

**If you plan to submit a bid directly to the Department of Transportation**

**PREQUALIFICATION**

Any contractor who desires to become pre-qualified to bid on work advertised by IDOT must submit the properly completed pre-qualification forms to the Bureau of Construction no later than 4:30 p.m. prevailing time twenty-one days prior to the letting of interest. This pre-qualification requirement applies to first time contractors, contractors renewing expired ratings, contractors maintaining continuous pre-qualification or contractors requesting revised ratings. To be eligible to bid, existing pre-qualification ratings must be effective through the date of letting.

**REQUESTS FOR AUTHORIZATION TO BID**

Contractors wanting to bid on items included in a particular letting must submit the properly completed "Request for Authorization to Bid/or Not For Bid Status" (BDE 124INT) and the ORIGINAL "Affidavit of Availability" (BC 57) to the proper office no later than 4:30 p.m. prevailing time, three (3) days prior to the letting date.

**WHO CAN BID ?**

Bids will be accepted from only those companies that request and receive written **Authorization to Bid** from IDOT's Central Bureau of Construction.

**WHAT CONSTITUTES WRITTEN AUTHORIZATION TO BID?:** When a prospective prime bidder submits a "Request for Authorization to Bid/or Not For Bid Status"(BDE 124INT) he/she must indicate at that time which items are being requested For Bidding purposes. Only those items requested For Bidding will be analyzed. After the request has been analyzed, the bidder will be issued a **Proposal Denial and/or Authorization Form**, approved by the Central Bureau of Construction, that indicates which items have been approved For Bidding. If **Authorization to Bid** cannot be approved, the **Proposal Denial and/or Authorization Form** will indicate the reason for denial.

**ABOUT AUTHORIZATION TO BID:** Firms that have not received an authorization form within a reasonable time of complete and correct original document submittal should contact the department as to status. This is critical in the week before the letting. These documents must be received three days before the letting date. Firms unsure as to authorization status should call the Prequalification Section of the Bureau of Construction at the number listed at the end of these instructions.

**ADDENDA AND REVISIONS:** It is the contractor's responsibility to determine which, if any, addenda or revisions pertain to any project they may be bidding. Failure to incorporate all relevant addenda or revisions may cause the bid to be declared unacceptable.

Each addendum will be placed with the contract number. Addenda and revisions will also be placed on the Addendum/Revision Checklist and each subscription service subscriber will be notified by e-mail of each addendum and revision issued.

The Internet is the Department's primary way of doing business. The subscription server e-mails are an added courtesy the Department provides. It is suggested that bidders check IDOT's website at <http://www.dot.il.gov/desenv/delett.html> before submitting final bid information.

***IDOT IS NOT RESPONSIBLE FOR ANY E-MAIL FAILURES.***

Addenda Questions may be directed to the Contracts Office at (217)782-7806 or [D&Econtracts@dot.il.gov](mailto:D&Econtracts@dot.il.gov)

Technical Questions about downloading these files may be directed to Tim Garman (217)524-1642 or [Timothy.Garman@illinois.gov](mailto:Timothy.Garman@illinois.gov).

**WHAT MUST BE INCLUDED WHEN BIDS ARE SUBMITTED?:** Bidders need not return the entire proposal when bids are submitted. That portion of the proposal that must be returned includes the following:

1. All documents from the Proposal Cover Sheet through the Proposal Bid Bond
2. Other special documentation and/or information that may be required by the contract special provisions

All proposal documents, including Proposal Guaranty Checks or Proposal Bid Bonds, should be stapled together to prevent loss when bids are processed by IDOT personnel.

**ABOUT SUBMITTING BIDS:** It is recommended that bidders deliver bids in person to insure they arrive at the proper location prior to the time specified for the receipt of bids. Any bid received at the place of letting after the time specified will not be accepted.

**WHO SHOULD BE CALLED IF ASSISTANCE IS NEEDED?**

<b>Questions Regarding</b>	<b>Call</b>
Prequalification and/or Authorization to Bid	217/782-3413
Preparation and submittal of bids	217/782-7806
Mailing of plans and proposals	217/782-7806

**ADDENDUMS AND REVISIONS TO THE PROPOSAL FORMS**

Planholders should verify that they have received and incorporated any addendum and/or revision prior to submitting their bid. Failure by the bidder to include an addendum or revision could result in a bid being rejected as irregular.

# 36

RETURN WITH BID

Proposal Submitted By
Name
Address
City

## Letting June 12, 2009

**BIDDERS NEED NOT RETURN THE ENTIRE PROPOSAL**  
(See instructions inside front cover)

### NOTICE TO PROSPECTIVE BIDDERS

This proposal can be used for bidding purposes by only those companies that request and receive written AUTHORIZATION TO BID from IDOT's Central Bureau of Construction.  
(SEE INSTRUCTIONS ON THE INSIDE OF COVER)

# Notice To Bidders, Specifications, Proposal, Contract and Contract Bond



**Illinois Department  
of Transportation**

Springfield, Illinois 62764

**Contract No. 76C82  
Various Counties  
Section DIST 8 SEAL COAT 2010-2  
District 8 Construction Funds  
Various Routes**

PLEASE MARK THE APPROPRIATE BOX BELOW:

- A Bid Bond is included.
- A Cashier's Check or a Certified Check is included.

Plans Included  
Herein

Prepared by

S

Checked by

(Printed by authority of the State of Illinois)

---

---

## INSTRUCTIONS

**ABOUT IDOT PROPOSALS:** All proposals issued by IDOT are potential bidding proposals. Each proposal contains all Certifications and Affidavits, a Proposal Signature Sheet and a Proposal Bid Bond required for Prime Contractors to submit a bid after written **Authorization to Bid** has been issued by IDOT's Central Bureau of Construction.

**WHO CAN BID?:** Bids will be accepted from only those companies that request and receive written **Authorization to Bid** from IDOT's Central Bureau of Construction. To request authorization, a potential bidder must complete and submit Part B of the Request for Authorization to Bid/or Not For Bid Status form (BDE 124 INT) and submit an original Affidavit of Availability (BC 57).

**WHAT CONSTITUTES WRITTEN AUTHORIZATION TO BID?:** When a prospective prime bidder submits a "Request for Proposal Forms and Plans" he/she must indicate at that time which items are being requested For Bidding purposes. Only those items requested For Bidding will be analyzed. After the request has been analyzed, the bidder will be issued a **Proposal Denial and/or Authorization Form**, approved by the Central Bureau of Construction, that indicates which items have been approved For Bidding. If **Authorization to Bid** cannot be approved, the **Proposal Denial and/or Authorization Form** will indicate the reason for denial. If a contractor has requested to bid but has not received a **Proposal Denial and/or Authorization Form**, they should contact the Central Bureau of Construction in advance of the letting date.

**WHAT MUST BE INCLUDED WHEN BIDS ARE SUBMITTED?:** Bidders need not return the entire proposal when bids are submitted. That portion of the proposal that must be returned includes the following:

1. All documents from the Proposal Cover Sheet through the Proposal Bid Bond
2. Other special documentation and/or information that may be required by the contract special provisions

All proposal documents, including Proposal Guaranty Checks or Proposal Bid Bonds, should be stapled together to prevent loss when bids are processed by IDOT personnel.

**ABOUT SUBMITTING BIDS:** It is recommended that bidders deliver bids in person to insure they arrive at the proper location prior to the time specified for the receipt of bids. Any bid received at the place of letting after the time specified will not be accepted.

### WHO SHOULD BE CALLED IF ASSISTANCE IS NEEDED?

Questions Regarding	Call
Prequalification and/or Authorization to Bid	217/782-3413
Preparation and submittal of bids	217/782-7806
Mailing of CD-ROMS	217/782-7806

RETURN WITH BID



PROPOSAL

TO THE DEPARTMENT OF TRANSPORTATION

1. Proposal of \_\_\_\_\_

\_\_\_\_\_

Taxpayer Identification Number (Mandatory) \_\_\_\_\_ a

for the improvement identified and advertised for bids in the Invitation for Bids as:

**Contract No. 76C82**  
**Various Counties**  
**Section DIST 8 SEAL COAT 2010-2**  
**Various Routes**  
**District 8 Construction Funds**

**Cover and seal coats at various locations in Jersey, Greene and Calhoun Counties.**

2. The undersigned bidder will furnish all labor, material and equipment to complete the above described project in a good and workmanlike manner as provided in the contract documents provided by the Department of Transportation. This proposal will become part of the contract and the terms and conditions contained in the contract documents shall govern performance and payments.

**RETURN WITH BID**

3. **ASSURANCE OF EXAMINATION AND INSPECTION/WAIVER.** The undersigned further declares that he/she has carefully examined the proposal, plans, specifications, form of contract and contract bond, and special provisions, and that he/she has inspected in detail the site of the proposed work, and that he/she has familiarized themselves with all of the local conditions affecting the contract and the detailed requirements of construction, and understands that in making this proposal he/she waives all right to plead any misunderstanding regarding the same.
4. **EXECUTION OF CONTRACT AND CONTRACT BOND.** The undersigned further agrees to execute a contract for this work and present the same to the department within fifteen (15) days after the contract has been mailed to him/her. The undersigned further agrees that he/she and his/her surety will execute and present within fifteen (15) days after the contract has been mailed to him/her contract bond satisfactory to and in the form prescribed by the Department of Transportation, in the penal sum of the full amount of the contract, guaranteeing the faithful performance of the work in accordance with the terms of the contract.
5. **PROPOSAL GUARANTY.** Accompanying this proposal is either a bid bond on the department form, executed by a corporate surety company satisfactory to the department, or a proposal guaranty check consisting of a bank cashier's check or a properly certified check for not less than 5 per cent of the amount bid or for the amount specified in the following schedule:

<u>Amount of Bid</u>		<u>Proposal Guaranty</u>	<u>Amount of Bid</u>		<u>Proposal Guaranty</u>	
Up to	\$5,000 .....	\$150	\$2,000,000	to	\$3,000,000 .....	\$100,000
\$5,000	to \$10,000 .....	\$300	\$3,000,000	to	\$5,000,000 .....	\$150,000
\$10,000	to \$50,000 .....	\$1,000	\$5,000,000	to	\$7,500,000 .....	\$250,000
\$50,000	to \$100,000 .....	\$3,000	\$7,500,000	to	\$10,000,000 .....	\$400,000
\$100,000	to \$150,000 .....	\$5,000	\$10,000,000	to	\$15,000,000 .....	\$500,000
\$150,000	to \$250,000 .....	\$7,500	\$15,000,000	to	\$20,000,000 .....	\$600,000
\$250,000	to \$500,000 .....	\$12,500	\$20,000,000	to	\$25,000,000 .....	\$700,000
\$500,000	to \$1,000,000 .....	\$25,000	\$25,000,000	to	\$30,000,000 .....	\$800,000
\$1,000,000	to \$1,500,000 .....	\$50,000	\$30,000,000	to	\$35,000,000 .....	\$900,000
\$1,500,000	to \$2,000,000 .....	\$75,000	over		\$35,000,000 .....	\$1,000,000

Bank cashier's checks or properly certified checks accompanying proposals shall be made payable to the Treasurer, State of Illinois, when the state is awarding authority; the county treasurer, when a county is the awarding authority; or the city, village, or town treasurer, when a city, village, or town is the awarding authority.

If a combination bid is submitted, the proposal guaranties which accompany the individual proposals making up the combination will be considered as also covering the combination bid.

The amount of the proposal guaranty check is \_\_\_\_\_ \$(\_\_\_\_\_). If this proposal is accepted and the undersigned shall fail to execute a contract bond as required herein, it is hereby agreed that the amount of the proposal guaranty shall become the property of the State of Illinois, and shall be considered as payment of damages due to delay and other causes suffered by the State because of the failure to execute said contract and contract bond; otherwise, the bid bond shall become void or the proposal guaranty check shall be returned to the undersigned.

**Attach Cashier's Check or Certified Check Here**

In the event that one proposal guaranty check is intended to cover two or more proposals, the amount must be equal to the sum of the proposal guaranties which would be required for each individual proposal. If the guaranty check is placed in another proposal, state below where it may be found.

The proposal guaranty check will be found in the proposal for:

Item \_\_\_\_\_

Section No. \_\_\_\_\_

County \_\_\_\_\_

**Mark the proposal cover sheet as to the type of proposal guaranty submitted.**

**RETURN WITH BID**

6. **COMBINATION BIDS.** The undersigned further agrees that if awarded the contract for the sections contained in the following combination, he/she will perform the work in accordance with the requirements of each individual proposal comprising the combination bid specified in the schedule below, and that the combination bid shall be prorated against each section in proportion to the bid submitted for the same. If an error is found to exist in the gross sum bid for one or more of the individual sections included in a combination, the combination bid shall be corrected as provided in the specifications.

**When a combination bid is submitted, the schedule below must be completed in each proposal comprising the combination.**

**If alternate bids are submitted for one or more of the sections comprising the combination, a combination bid must be submitted for each alternate.**

**Schedule of Combination Bids**

Combination No.	Sections Included in Combination	Combination Bid	
		Dollars	Cents

7. **SCHEDULE OF PRICES.** The undersigned bidder submits herewith, in accordance with the rules and instructions, a schedule of prices for the items of work for which bids are sought. The unit prices bid are in U.S. dollars and cents, and all extensions and summations have been made. The bidder understands that the quantities appearing in the bid schedule are approximate and are provided for the purpose of obtaining a gross sum for the comparison of bids. If there is an error in the extension of the unit prices, the unit prices shall govern. Payment to the contractor awarded the contract will be made only for actual quantities of work performed and accepted or materials furnished according to the contract. The scheduled quantities of work to be done and materials to be furnished may be increased, decreased or omitted as provided elsewhere in the contract.
8. **CERTIFICATE OF AUTHORITY.** The undersigned bidder, if a business organized under the laws of another State, assures the Department that it will furnish a copy of its certificate of authority to do business in the State of Illinois with the return of the executed contract and bond. Failure to furnish the certificate within the time provided for execution of an awarded contract may be cause for cancellation of the award and forfeiture of the proposal guaranty to the State.





**CONTRACT NUMBER**

**76C82**

**THIS IS THE TOTAL BID**

**\$ \_\_\_\_\_**

**NOTES:**

1. Each PAY ITEM should have a UNIT PRICE and a TOTAL PRICE.
2. The UNIT PRICE shall govern if no TOTAL PRICE is shown or if there is a discrepancy between the product of the UNIT PRICE multiplied by the QUANTITY.
3. If a UNIT PRICE is omitted, the TOTAL PRICE will be divided by the QUANTITY in order to establish a UNIT PRICE.
4. A bid may be declared UNACCEPTABLE if neither a unit price nor a total price is shown.

## RETURN WITH BID

### **STATE REQUIRED ETHICAL STANDARDS GOVERNING CONTRACT PROCUREMENT: ASSURANCES, CERTIFICATIONS AND DISCLOSURES**

#### **I. GENERAL**

**A.** Article 50 of the Illinois Procurement Code establishes the duty of all State chief procurement officers, State purchasing officers, and their designees to maximize the value of the expenditure of public moneys in procuring goods, services, and contracts for the State of Illinois and to act in a manner that maintains the integrity and public trust of State government. In discharging this duty, they are charged by law to use all available information, reasonable efforts, and reasonable actions to protect, safeguard, and maintain the procurement process of the State of Illinois.

**B.** In order to comply with the provisions of Article 50 and to carry out the duty established therein, all bidders are to adhere to ethical standards established for the procurement process, and to make such assurances, disclosures and certifications required by law. By execution of the Proposal Signature Sheet, the bidder indicates that each of the mandated assurances has been read and understood, that each certification is made and understood, and that each disclosure requirement has been understood and completed.

**C.** In addition to all other remedies provided by law, failure to comply with any assurance, failure to make any disclosure or the making of a false certification shall be grounds for termination of the contract and the suspension or debarment of the bidder.

#### **II. ASSURANCES**

**A.** The assurances hereinafter made by the bidder are each a material representation of fact upon which reliance is placed should the Department enter into the contract with the bidder. The Department may terminate the contract if it is later determined that the bidder rendered a false or erroneous assurance, and the surety providing the performance bond shall be responsible for the completion of the contract.

##### **B. Felons**

1. The Illinois Procurement Code provides:

Section 50-10. Felons. Unless otherwise provided, no person or business convicted of a felony shall do business with the State of Illinois or any state agency from the date of conviction until 5 years after the date of completion of the sentence for that felony, unless no person held responsible by a prosecutorial office for the facts upon which the conviction was based continues to have any involvement with the business.

2. The bidder assures the Department that the award and execution of the contract would not cause a violation of Section 50-10.

##### **C. Conflicts of Interest**

1. The Illinois Procurement Code provides in pertinent part:

Section 50-13. Conflicts of Interest.

(a) Prohibition. It is unlawful for any person holding an elective office in this State, holding a seat in the General Assembly, or appointed to or employed in any of the offices or agencies of state government and who receives compensation for such employment in excess of 60% of the salary of the Governor of the State of Illinois, or who is an officer or employee of the Capital Development Board or the Illinois Toll Highway Authority, or who is the spouse or minor child of any such person to have or acquire any contract, or any direct pecuniary interest in any contract therein, whether for stationery, printing, paper, or any services, materials, or supplies, that will be wholly or partially satisfied by the payment of funds appropriated by the General Assembly of the State of Illinois or in any contract of the Capital Development Board or the Illinois Toll Highway authority.

(b) Interests. It is unlawful for any firm, partnership, association or corporation, in which any person listed in subsection (a) is entitled to receive (i) more than 7 1/2% of the total distributable income or (ii) an amount in excess of the salary of the Governor, to have or acquire any such contract or direct pecuniary interest therein.

(c) Combined interests. It is unlawful for any firm, partnership, association, or corporation, in which any person listed in subsection (a) together with his or her spouse or minor children is entitled to receive (i) more than 15%, in the aggregate, of the total distributable income or (ii) an amount in excess of 2 times the salary of the Governor, to have or acquire any such contract or direct pecuniary interest therein.

(d) Securities. Nothing in this Section invalidates the provisions of any bond or other security previously offered or to be offered for sale or sold by or for the State of Illinois.

(e) Prior interests. This Section does not affect the validity of any contract made between the State and an officer or employee of the State or member of the General Assembly, his or her spouse, minor child or any combination of those persons if that contract was in existence before his or her election or employment as an officer, member, or employee. The contract is voidable, however, if it cannot be completed within 365 days after the officer, member, or employee takes office or is employed.

The current salary of the Governor is \$177,412.00. Sixty percent of the salary is \$106,447.20.

## RETURN WITH BID

2. The bidder assures the Department that the award and execution of the contract would not cause a violation of Section 50-13, or that an effective exemption has been issued by the Board of Ethics to any individual subject to the Section 50-13 prohibitions pursuant to the provisions of Section 50-20 of the Code and Executive Order Number 3 (1998). Information concerning the exemption process is available from the Department upon request.

### **D. Negotiations**

1. The Illinois Procurement Code provides in pertinent part:

Section 50-15. Negotiations.

(a) It is unlawful for any person employed in or on a continual contractual relationship with any of the offices or agencies of State government to participate in contract negotiations on behalf of that office or agency with any firm, partnership, association, or corporation with whom that person has a contract for future employment or is negotiating concerning possible future employment.

2. The bidder assures the Department that the award and execution of the contract would not cause a violation of Section 50-15, and that the bidder has no knowledge of any facts relevant to the kinds of acts prohibited therein.

### **E. Inducements**

1. The Illinois Procurement Code provides:

Section 50-25. Inducement. Any person who offers or pays any money or other valuable thing to any person to induce him or her not to bid for a State contract or as recompense for not having bid on a State contract is guilty of a Class 4 felony. Any person who accepts any money or other valuable thing for not bidding for a State contract or who withholds a bid in consideration of the promise for the payment of money or other valuable thing is guilty of a Class 4 felony.

2. The bidder assures the Department that the award and execution of the contract would not cause a violation of Section 50-25, and that the bidder has no knowledge of any facts relevant to the kinds of acts prohibited therein.

### **F. Revolving Door Prohibition**

1. The Illinois Procurement Code provides:

Section 50-30. Revolving door prohibition. Chief procurement officers, associate procurement officers, State purchasing officers, their designees whose principal duties are directly related to State procurement, and executive officers confirmed by the Senate are expressly prohibited for a period of 2 years after terminating an affected position from engaging in any procurement activity relating to the State agency most recently employing them in an affected position for a period of at least 6 months. The prohibition includes, but is not limited to: lobbying the procurement process; specifying; bidding; proposing bid, proposal, or contract documents; on their own behalf or on behalf of any firm, partnership, association, or corporation. This Section applies only to persons who terminate an affected position on or after January 15, 1999.

2. The bidder assures the Department that the award and execution of the contract would not cause a violation of Section 50-30, and that the bidder has no knowledge of any facts relevant to the kinds of acts prohibited therein.

### **G. Reporting Anticompetitive Practices**

1. The Illinois Procurement Code provides:

Section 50-40. Reporting anticompetitive practices. When, for any reason, any vendor, bidder, contractor, chief procurement officer, State purchasing officer, designee, elected official, or State employee suspects collusion or other anticompetitive practice among any bidders, offerors, contractors, proposers, or employees of the State, a notice of the relevant facts shall be transmitted to the Attorney General and the chief procurement officer.

2. The bidder assures the Department that it has not failed to report any relevant facts concerning the practices addressed in Section 50-40 which may involve the contract for which the bid is submitted.

### **H. Confidentiality**

1. The Illinois Procurement Code provides:

Section 50-45. Confidentiality. Any chief procurement officer, State purchasing officer, designee, or executive officer who willfully uses or allows the use of specifications, competitive bid documents, proprietary competitive information, proposals, contracts, or selection information to compromise the fairness or integrity of the procurement, bidding, or contract process shall be subject to immediate dismissal, regardless of the Personnel code, any contract, or any collective bargaining agreement, and may in addition be subject to criminal prosecution.

2. The bidder assures the Department that it has no knowledge of any fact relevant to the practices addressed in Section 50-45 which may involve the contract for which the bid is submitted.

## RETURN WITH BID

### **I. Insider Information**

1. The Illinois Procurement Act provides:

Section 50-50. Insider information. It is unlawful for any current or former elected or appointed State official or State employee to knowingly use confidential information available only by virtue of that office or employment for actual or anticipated gain for themselves or another person.

2. The bidder assures the Department that it has no knowledge of any facts relevant to the practices addressed in Section 50-50 which may involve the contract for which the bid is submitted.

### **III. CERTIFICATIONS**

**A.** The certifications hereinafter made by the bidder are each a material representation of fact upon which reliance is placed should the Department enter into the contract with the bidder. The Department may terminate the contract if it is later determined that the bidder rendered a false or erroneous certification, and the surety providing the performance bond shall be responsible for completion of the contract.

### **B. Bribery**

1. The Illinois Procurement Code provides:

Section 50-5. Bribery.

(a) Prohibition. No person or business shall be awarded a contract or subcontract under this Code who:

(1) has been convicted under the laws of Illinois or any other state of bribery or attempting to bribe an officer or employee of the State of Illinois or any other state in that officer's or employee's official capacity; or

(2) has made an admission of guilt of that conduct that is a matter of record but has not been prosecuted for that conduct.

(b) Businesses. No business shall be barred from contracting with any unit of State or local government as a result of a conviction under this Section of any employee or agent of the business if the employee or agent is no longer employed by the business and:

(1) the business has been finally adjudicated not guilty; or

(2) the business demonstrates to the governmental entity with which it seeks to contract, and that entity finds that the commission of the offense was not authorized, requested, commanded, or performed by a director, officer, or high managerial agent on behalf of the business as provided in paragraph (2) of subsection (a) of Section 5-4 of the Criminal Code of 1961.

(c) Conduct on behalf of business. For purposes of this Section, when an official, agent, or employee of a business committed the bribery or attempted bribery on behalf of the business and in accordance with the direction or authorization of a responsible official of the business, the business shall be chargeable with the conduct.

(d) Certification. Every bid submitted to and contract executed by the State shall contain a certification by the contractor that the contractor is not barred from being awarded a contract or subcontract under this Section. A contractor who makes a false statement, material to the certification, commits a Class 3 felony.

2. The bidder certifies that it is not barred from being awarded a contract under Section 50.5.

### **C. Educational Loan**

1. Section 3 of the Educational Loan Default Act provides:

§ 3. No State agency shall contract with an individual for goods or services if that individual is in default, as defined in Section 2 of this Act, on an educational loan. Any contract used by any State agency shall include a statement certifying that the individual is not in default on an educational loan as provided in this Section.

2. The bidder, if an individual as opposed to a corporation, partnership or other form of business organization, certifies that the bidder is not in default on an educational loan as provided in Section 3 of the Act.

### **D. Bid-Rigging/Bid Rotating**

1. Section 33E-11 of the Criminal Code of 1961 provides:

§ 33E-11. (a) Every bid submitted to and public contract executed pursuant to such bid by the State or a unit of local government shall contain a certification by the prime contractor that the prime contractor is not barred from contracting with any unit of State or local government as a result of a violation of either Section 33E-3 or 33E-4 of this Article. The State and units of local government shall provide the appropriate forms for such certification.

## RETURN WITH BID

(b) A contractor who makes a false statement, material to the certification, commits a Class 3 felony.

A violation of Section 33E-3 would be represented by a conviction of the crime of bid-rigging which, in addition to Class 3 felony sentencing, provides that any person convicted of this offense or any similar offense of any state or the United States which contains the same elements as this offense shall be barred for 5 years from the date of conviction from contracting with any unit of State or local government. No corporation shall be barred from contracting with any unit of State or local government as a result of a conviction under this Section of any employee or agent of such corporation if the employee so convicted is no longer employed by the corporation and: (1) it has been finally adjudicated not guilty or (2) if it demonstrates to the governmental entity with which it seeks to contract and that entity finds that the commission of the offense was neither authorized, requested, commanded, nor performed by a director, officer or a high managerial agent in behalf of the corporation.

A violation of Section 33E-4 would be represented by a conviction of the crime of bid-rotating which, in addition to Class 2 felony sentencing, provides that any person convicted of this offense or any similar offense of any state or the United States which contains the same elements as this offense shall be permanently barred from contracting with any unit of State or local government. No corporation shall be barred from contracting with any unit of State or local government as a result of a conviction under this Section of any employee or agent of such corporation if the employee so convicted is no longer employed by the corporation and: (1) it has been finally adjudicated not guilty or (2) if it demonstrates to the governmental entity with which it seeks to contract and that entity finds that the commission of the offense was neither authorized, requested, commanded, nor performed by a director, officer or a high managerial agent in behalf of the corporation.

2. The bidder certifies that it is not barred from contracting with the Department by reason of a violation of either Section 33E-3 or Section 33E-4.

### **E. International Anti-Boycott**

1. Section 5 of the International Anti-Boycott Certification Act provides:

§ 5. State contracts. Every contract entered into by the State of Illinois for the manufacture, furnishing, or purchasing of supplies, material, or equipment or for the furnishing of work, labor, or services, in an amount exceeding the threshold for small purchases according to the purchasing laws of this State or \$10,000.00, whichever is less, shall contain certification, as a material condition of the contract, by which the contractor agrees that neither the contractor nor any substantially-owned affiliated company is participating or shall participate in an international boycott in violation of the provisions of the U.S. Export Administration Act of 1979 or the regulations of the U.S. Department of Commerce promulgated under that Act.

2. The bidder makes the certification set forth in Section 5 of the Act.

### **F. Drug Free Workplace**

1. The Illinois "Drug Free Workplace Act" applies to this contract and it is necessary to comply with the provisions of the "Act" if the contractor is a corporation, partnership, or other entity (including a sole proprietorship) which has 25 or more employees.

2. The bidder certifies that if awarded a contract in excess of \$5,000 it will provide a drug free workplace by:

(a) Publishing a statement notifying employees that the unlawful manufacture, distribution, dispensation, possession or use of a controlled substance, including cannabis, is prohibited in the contractor's workplace; specifying the actions that will be taken against employees for violations of such prohibition; and notifying the employee that, as a condition of employment on such contract, the employee shall abide by the terms of the statement, and notify the employer of any criminal drug statute conviction for a violation occurring in the workplace no later than five (5) days after such conviction.

(b) Establishing a drug free awareness program to inform employees about the dangers of drug abuse in the workplace; the contractor's policy of maintaining a drug free workplace; any available drug counseling, rehabilitation, and employee assistance programs; and the penalties that may be imposed upon employees for drug violations.

(c) Providing a copy of the statement required by subparagraph (1) to each employee engaged in the performance of the contract and to post the statement in a prominent place in the workplace.

(d) Notifying the Department within ten (10) days after receiving notice from an employee or otherwise receiving actual notice of the conviction of an employee for a violation of any criminal drug statute occurring in the workplace.

(e) Imposing or requiring, within 30 days after receiving notice from an employee of a conviction or actual notice of such a conviction, an appropriate personnel action, up to and including termination, or the satisfactory participation in a drug abuse assistance or rehabilitation program approved by a federal, state or local health, law enforcement or other appropriate agency.

(f) Assisting employees in selecting a course of action in the event drug counseling, treatment, and rehabilitation is required and indicating that a trained referral team is in place.

(g) Making a good faith effort to continue to maintain a drug free workplace through implementation of the actions and efforts stated in this certification.

## RETURN WITH BID

### **G. Debt Delinquency**

1. The Illinois Procurement Code provides:

Section 50-11 and 50-12. Debt Delinquency.

The contractor or bidder certifies that it, or any affiliate, is not barred from being awarded a contract under 30 ILCS 500. Section 50-11 prohibits a person from entering into a contract with a State agency if it knows or should know that it, or any affiliate, is delinquent in the payment of any debt to the State as defined by the Debt Collection Board. Section 50-12 prohibits a person from entering into a contract with a State agency if it, or any affiliate, has failed to collect and remit Illinois Use Tax on all sales of tangible personal property into the State of Illinois in accordance with the provisions of the Illinois Use Tax Act. The contractor further acknowledges that the contracting State agency may declare the contract void if this certification is false or if the contractor, or any affiliate, is determined to be delinquent in the payment of any debt to the State during the term of the contract.

### **H. Sarbanes-Oxley Act of 2002**

1. The Illinois Procurement Code provides:

Section 50-60(c).

The contractor certifies in accordance with 30 ILCS 500/50-10.5 that no officer, director, partner or other managerial agent of the contracting business has been convicted of a felony under the Sarbanes-Oxley Act of 2002 or a Class 3 or Class 2 felony under the Illinois Securities Law of 1953 for a period of five years prior to the date of the bid or contract. The contractor acknowledges that the contracting agency shall declare the contract void if this certification is false.

### **I. Addenda**

The contractor or bidder certifies that all relevant addenda have been incorporated in to this contract. Failure to do so may cause the bid to be declared unacceptable.

### **J. Section 42 of the Environmental Protection Act**

The contractor certifies in accordance with 30 ILCS 500/50-12 that the bidder or contractor is not barred from being awarded a contract under this Section which prohibits the bidding on or entering into contracts with the State of Illinois or a State agency by a person or business found by a court or the Pollution Control Board to have committed a willful or knowing violation of Section 42 of the Environmental Protection Act for a period of five years from the date of the order. The contractor acknowledges that the contracting agency may declare the contract void if this certification is false.

### **K. Apprenticeship and Training Certification (Does not apply to federal aid projects)**

In accordance with the provisions of Section 30-22 (6) of the Illinois Procurement Code, the bidder certifies that it is a participant, either as an individual or as part of a group program, in the approved apprenticeship and training programs applicable to each type of work or craft that the bidder will perform with its own forces. The bidder further certifies for work that will be performed by subcontract that each of its subcontractors submitted for approval either (a) is, at the time of such bid, participating in an approved, applicable apprenticeship and training program; or (b) will, prior to commencement of performance of work pursuant to this contract, begin participation in an approved apprenticeship and training program applicable to the work of the subcontract. The Department, at any time before or after award, may require the production of a copy of each applicable Certificate of Registration issued by the United States Department of Labor evidencing such participation by the contractor and any or all of its subcontractors. Applicable apprenticeship and training programs are those that have been approved and registered with the United States Department of Labor. The bidder shall list in the space below, the official name of the program sponsor holding the Certificate of Registration for all of the types of work or crafts in which the bidder is a participant and that will be performed with the bidder's forces. Types of work or craft work that will be subcontracted shall be included and listed as subcontract work. The list shall also indicate any type of work or craft job category that does not have an applicable apprenticeship or training program. **The bidder is responsible for making a complete report and shall make certain that each type of work or craft job category that will be utilized on the project as reported on the Construction Employee Workforce Projection (Form BC-1256) and returned with the bid is accounted for and listed.**

---

---

---

The requirements of this certification and disclosure are a material part of the contract, and the contractor shall require this certification provision to be included in all approved subcontracts. In order to fulfill this requirement, it shall not be necessary that an applicable program sponsor be currently taking or that it will take applications for apprenticeship, training or employment during the performance of the work of this contract.

### **L. Executive Order Number 1 (2007) Regarding Lobbying on Government Procurements**

The bidder hereby warrants and certifies that they have complied and will comply with the requirements set forth in this Order. The requirements of this warrant and certification are a material part of the contract, and the contractor shall require this warrant and certification provision to be included in all approved subcontracts.

## RETURN WITH BID

### **M. Disclosure of Business Operations in Iran**

Section 50-36 of the Illinois Procurement Code, 30ILCS 500/50-36 provides that each bid, offer, or proposal submitted for a State contract shall include a disclosure of whether or not the Company acting as the bidder, offeror, or proposing entity, or any of its corporate parents or subsidiaries, within the 24 months before submission of the bid, offer, or proposal had business operations that involved contracts with or provision of supplies or services to the Government of Iran, companies in which the Government of Iran has any direct or indirect equity share, consortiums or projects commissioned by the Government of Iran, or companies involved in consortiums or projects commissioned by the Government of Iran and either of the following conditions apply:

- (1) More than 10% of the Company's revenues produced in or assets located in Iran involve oil-related activities or mineral-extraction activities; less than 75% of the Company's revenues produced in or assets located in Iran involve contracts with or provision of oil-related or mineral-extraction products or services to the Government of Iran or a project or consortium created exclusively by that government; and the Company has failed to take substantial action.
- (2) The Company has, on or after August 5, 1996, made an investment of \$20 million or more, or any combination of investments of at least \$10 million each that in the aggregate equals or exceeds \$20 million in any 12-month period, which directly or significantly contributes to the enhancement of Iran's ability to develop petroleum resources of Iran.

The terms "Business operations", "Company", "Mineral-extraction activities", "Oil-related activities", "Petroleum resources", and "Substantial action" are all defined in the Code.

Failure to make the disclosure required by the Code shall cause the bid, offer or proposal to be considered not responsive. The disclosure will be considered when evaluating the bid, offer, or proposal or awarding the contract. The name of each Company disclosed as doing business or having done business in Iran will be provided to the State Comptroller.

Check the appropriate statement:

Company has no business operations in Iran to disclose.

Company has business operations in Iran as disclosed the attached document.

### **N. Political Contributions and Registration with the State Board of Elections**

Sections 20-160 and 50-37 of the Illinois Procurement Code regulate political contributions from business entities and any affiliated entities or affiliated persons bidding on or contracting with the state. Generally under Section 50-37, any business entity, and any affiliated entity or affiliated person of the business entity, whose current year contracts with all state agencies exceed an awarded value of \$50,000, are prohibited from making any contributions to any political committees established to promote the candidacy of the officeholder responsible for the awarding of the contracts or any other declared candidate for that office for the duration of the term of office of the incumbent officeholder or a period 2 years after the termination of the contract, whichever is longer. Any business entity and affiliated entities or affiliated persons whose state contracts in the current year do not exceed an awarded value of \$50,000, but whose aggregate pending bids and proposals on state contracts exceed \$50,000, either alone or in combination with contracts not exceeding \$50,000, are prohibited from making any political contributions to any political committee established to promote the candidacy of the officeholder responsible for awarding the pending contract during the period beginning on the date the invitation for bids or request for proposals is issued and ending on the day after the date of award or selection if the entity was not awarded or selected. Section 20-160 requires certification of registration of affected business entities in accordance with procedures found in Section 9-35 of The Election Code.

By submission of a bid, the contractor business entity acknowledges and agrees that it has read and understands Sections 20-160 and 50-37 of the Illinois Procurement Code, and that it makes the following certification:

**The undersigned business entity certifies that it has registered as a business with the State Board of Elections and acknowledges a continuing duty to update the registration in accordance with the above referenced statutes. A copy of the certificate of registration shall be submitted with the bid. The bidder is cautioned that the Department will not award a contract without submission of the certificate of registration.**

These requirements and compliance with the above referenced statutory sections are a material part of the contract, and any breach thereof shall be cause to void the contract under Section 50-60 of the Illinois Procurement Code. This provision does not apply to Federal-aid contracts.

**TO BE RETURNED WITH BID**

**IV. DISCLOSURES**

A. The disclosures hereinafter made by the bidder are each a material representation of fact upon which reliance is placed should the Department enter into the contract with the bidder. The Department may terminate the contract if it is later determined that the bidder rendered a false or erroneous disclosure, and the surety providing the performance bond shall be responsible for completion of the contract.

**B. Financial Interests and Conflicts of Interest**

1. Section 50-35 of the Illinois Procurement Code provides that all bids of more than \$10,000 shall be accompanied by disclosure of the financial interests of the bidder. This disclosed information for the successful bidder, will be maintained as public information subject to release by request pursuant to the Freedom of Information Act.

The financial interests to be disclosed shall include ownership or distributive income share that is in excess of 5%, or an amount greater than 60% of the annual salary of the Governor, of the bidding entity or its parent entity, whichever is less, unless the contractor or bidder is a publicly traded entity subject to Federal 10K reporting, in which case it may submit its 10K disclosure in place of the prescribed disclosure. If a bidder is a privately held entity that is exempt from Federal 10K reporting, but has more than 400 shareholders, it may submit the information that Federal 10K companies are required to report, and list the names of any person or entity holding any ownership share that is in excess of 5%. The disclosure shall include the names, addresses, and dollar or proportionate share of ownership of each person making the disclosure, their instrument of ownership or beneficial relationship, and notice of any potential conflict of interest resulting from the current ownership or beneficial interest of each person making the disclosure having any of the relationships identified in Section 50-35 and on the disclosure form.

In addition, all disclosures shall indicate any other current or pending contracts, proposals, leases, or other ongoing procurement relationships the bidding entity has with any other unit of state government and shall clearly identify the unit and the contract, proposal, lease, or other relationship.

2. Disclosure Forms. Disclosure Form A is attached for use concerning the individuals meeting the above ownership or distributive share requirements. Subject individuals should be covered each by one form. In addition, a second form (Disclosure Form B) provides for the disclosure of current or pending procurement relationships with other (non-IDOT) state agencies. **The forms must be included with each bid or incorporated by reference.**

**C. Disclosure Form Instructions**

**Form A: For bidders that have previously submitted the information requested in Form A**

The Department has retained the Form A disclosures submitted by all bidders responding to these requirements for the April 24, 1998 or any subsequent letting conducted by the Department. The bidder has the option of submitting the information again or the bidder may check the following certification statement indicating that the information previously submitted by the bidder is, as of the date of submission, current and accurate. Before checking this certification, the bidder should carefully review its prior submissions to ensure the Certification is correct. If the Bidder checks the Certification, the Bidder should proceed to Form B instructions.

**CERTIFICATION STATEMENT**

**I have determined that the Form A disclosure information previously submitted is current and accurate, and all forms are hereby incorporated by reference in this bid. Any necessary additional forms or amendments to previously submitted forms are attached to this bid.**

\_\_\_\_\_  
(Bidding Company)

\_\_\_\_\_  
Signature of Authorized Representative

\_\_\_\_\_  
Date



**Form A: For bidders who have NOT previously submitted the information requested in Form A**

If the bidder is a publicly traded entity subject to Federal 10K reporting, the 10K Report may be submitted to meet the requirements of Form A. If a bidder is a privately held entity that is exempt from Federal 10K reporting, but has more than 400 shareholders, it may submit the information that Federal 10K companies are required to report, and list the names of any person or entity holding any ownership share that is in excess of 5%. If a bidder is not subject to Federal 10K reporting, the bidder must determine if any individuals are required by law to complete a financial disclosure form. To do this, the bidder should answer each of the following questions. A "YES" answer indicates Form A must be completed. If the answer to each of the following questions is "NO", then the NOT APPLICABLE STATEMENT on the second page of Form A must be signed and dated by a person that is authorized to execute contracts for the bidding company. Note: These questions are for assistance only and are not required to be completed.

1. Does anyone in your organization have a direct or beneficial ownership share of greater than 5% of the bidding entity or parent entity? YES \_\_\_ NO \_\_\_
2. Does anyone in your organization have a direct or beneficial ownership share of less than 5%, but which has a value greater than \$106,447.20? YES \_\_\_ NO \_\_\_
3. Does anyone in your organization receive more than \$106,447.20 of the bidding entity's or parent entity's distributive income? (Note: Distributive income is, for these purposes, any type of distribution of profits. An annual salary is not distributive income.) YES \_\_\_ NO \_\_\_
4. Does anyone in your organization receive greater than 5% of the bidding entity's or parent entity's total distributive income, but which is less than \$106,447.20? YES \_\_\_ NO \_\_\_

(Note: Only one set of forms needs to be completed per person per bid even if a specific individual would require a yes answer to more than one question.)

A "YES" answer to any of these questions requires the completion of Form A. The bidder must determine each individual in the bidding entity or the bidding entity's parent company that would cause the questions to be answered "Yes". Each form must be signed and dated by a person that is authorized to execute contracts for your organization. **Photocopied or stamped signatures are not acceptable.** The person signing can be, but does not have to be, the person for which the form is being completed. The bidder is responsible for the accuracy of any information provided.

If the answer to each of the above questions is "NO", then the NOT APPLICABLE STATEMENT on page 2 of Form A must be signed and dated by a person that is authorized to execute contracts for your company.

**Form B: Identifying Other Contracts & Procurement Related Information** Disclosure Form B must be completed for each bid submitted by the bidding entity. Note: *Checking the NOT APPLICABLE STATEMENT on Form A does not allow the bidder to ignore Form B. Form B must be completed, checked, and dated or the bidder may be considered nonresponsive and the bid will not be accepted.*

The Bidder shall identify, by checking Yes or No on Form B, whether it has any pending contracts (including leases), bids, proposals, or other ongoing procurement relationship with any other (non-IDOT) State of Illinois agency. If "No" is checked, the bidder only needs to complete the check box on the bottom of Form B. If "Yes" is checked, the bidder must do one of the following:

Option I: If the bidder did not submit an Affidavit of Availability to obtain authorization to bid, the bidder must list all non-IDOT State of Illinois agency pending contracts, leases, bids, proposals, and other ongoing procurement relationships. These items may be listed on Form B or on an attached sheet(s). Do not include IDOT contracts. Contracts with cities, counties, villages, etc. are not considered State of Illinois agency contracts and are not to be included. Contracts with other State of Illinois agencies such as the Department of Natural Resources or the Capital Development Board must be included. Bidders who submit Affidavits of Availability are suggested to use Option II.

Option II: If the bidder is required and has submitted an Affidavit of Availability in order to obtain authorization to bid, the bidder may write or type "See Affidavit of Availability" which indicates that the Affidavit of Availability is incorporated by reference and includes all non-IDOT State of Illinois agency pending contracts, leases, bids, proposals, and other ongoing procurement relationships. For any contracts that are not covered by the Affidavit of Availability, the bidder must identify them on Form B or on an attached sheet(s). These might be such things as leases.

**D. Bidders Submitting More Than One Bid**

Bidders submitting multiple bids may submit one set of forms consisting of all required Form A disclosures and one Form B for use with all bids. Please indicate in the space provided below the bid item that contains the original disclosure forms and the bid items which incorporate the forms by reference.

- The bid submitted for letting item \_\_\_\_\_ contains the Form A disclosures or Certification Statement and the Form B disclosures. The following letting items incorporate the said forms by reference:

---

---

**ILLINOIS DEPARTMENT  
OF TRANSPORTATION**

**Form A  
Financial Information &  
Potential Conflicts of Interest  
Disclosure**

Contractor Name		
Legal Address		
City, State, Zip		
Telephone Number	Email Address	Fax Number (if available)

Disclosure of the information contained in this Form is required by the Section 50-35 of the Illinois Procurement Code (30 ILCS 500). Vendors desiring to enter into a contract with the State of Illinois must disclose the financial information and potential conflict of interest information as specified in this Disclosure Form. This information shall become part of the publicly available contract file. This Form A must be completed for bids in excess of \$10,000, and for all open-ended contracts. **A publicly traded company may submit a 10K disclosure (or equivalent if applicable) in satisfaction of the requirements set forth in Form A. See Disclosure Form Instructions.**

**DISCLOSURE OF FINANCIAL INFORMATION**

**1. Disclosure of Financial Information.** The individual named below has an interest in the BIDDER (or its parent) in terms of ownership or distributive income share in excess of 5%, or an interest which has a value of more than \$106,447.20 (60% of the Governor's salary as of 7/1/07). **(Make copies of this form as necessary and attach a separate Disclosure Form A for each individual meeting these requirements)**

**FOR INDIVIDUAL (type or print information)**

**NAME:** \_\_\_\_\_

**ADDRESS** \_\_\_\_\_

**Type of ownership/distributable income share:**

stock \_\_\_\_\_ sole proprietorship \_\_\_\_\_ Partnership \_\_\_\_\_ other: (explain on separate sheet):

% or \$ value of ownership/distributable income share: \_\_\_\_\_

**2. Disclosure of Potential Conflicts of Interest.** Check "Yes" or "No" to indicate which, if any, of the following potential conflict of interest relationships apply. If the answer to any question is "Yes", please attach additional pages and describe.

(a) State employment, currently or in the previous 3 years, including contractual employment of services.

Yes \_\_\_ No \_\_\_

If your answer is yes, please answer each of the following questions.

1. Are you currently an officer or employee of either the Capitol Development Board or the Illinois Toll Highway Authority? Yes \_\_\_ No \_\_\_

2. Are you currently appointed to or employed by any agency of the State of Illinois? If you are currently appointed to or employed by any agency of the State of Illinois, and your annual salary exceeds \$106,447.20, (60% of the Governor's salary as of 7/1/07) provide the name the State agency for which you are employed and your annual salary. \_\_\_\_\_

**RETURN WITH BID/OFFER**

3. If you are currently appointed to or employed by any agency of the State of Illinois, and your annual salary exceeds \$106,447.20, (60% of the Governor's salary as of 7/1/07) are you entitled to receive (i) more than 7 1/2% of the total distributable income of your firm, partnership, association or corporation, or (ii) an amount in excess of the salary of the Governor? Yes \_\_\_ No \_\_\_
4. If you are currently appointed to or employed by any agency of the State of Illinois, and your annual salary exceeds \$106,447.20, (60% of the Governor's salary as of 7/1/07) are you and your spouse or minor children entitled to receive (i) more than 15 % in the aggregate of the total distributable income of your firm, partnership, association or corporation, or (ii) an amount in excess of 2 times the salary of the Governor? Yes \_\_\_ No \_\_\_

---

(b) State employment of spouse, father, mother, son, or daughter, including contractual employment services in the previous 2 years.

Yes \_\_\_ No \_\_\_

If your answer is yes, please answer each of the following questions.

1. Is your spouse or any minor children currently an officer or employee of the Capitol Development Board or the Illinois Toll Highway Authority? Yes \_\_\_ No \_\_\_
2. Is your spouse or any minor children currently appointed to or employed by any agency of the State of Illinois? If your spouse or minor children is/are currently appointed to or employed by any agency of the State of Illinois, and his/her annual salary exceeds \$106,447.20, (60 % of the Governor's salary as of 7/1/07) provide the name of your spouse and/or minor children, the name of the State agency for which he/she is employed and his/her annual salary. \_\_\_\_\_
3. If your spouse or any minor children is/are currently appointed to or employed by any agency of the State of Illinois, and his/her annual salary exceeds \$106,447.20, (60% of the salary of the Governor as of 7/1/07) are you entitled to receive (i) more then 71/2% of the total distributable income of your firm, partnership, association or corporation, or (ii) an amount in excess of the salary of the Governor? Yes \_\_\_ No \_\_\_
4. If your spouse or any minor children are currently appointed to or employed by any agency of the State of Illinois, and his/her annual salary exceeds \$106,447.20, (60% of the Governor's salary as of 7/1/07) are you and your spouse or minor children entitled to receive (i) more than 15 % in the aggregate of the total distributable income of your firm, partnership, association or corporation, or (ii) an amount in excess of 2 times the salary of the Governor? Yes \_\_\_ No \_\_\_

---

(c) Elective status; the holding of elective office of the State of Illinois, the government of the United States, any unit of local government authorized by the Constitution of the State of Illinois or the statutes of the State of Illinois currently or in the previous 3 years. Yes \_\_\_ No \_\_\_

---

(d) Relationship to anyone holding elective office currently or in the previous 2 years; spouse, father, mother, son, or daughter. Yes \_\_\_ No \_\_\_

---

(e) Appointive office; the holding of any appointive government office of the State of Illinois, the United States of America, or any unit of local government authorized by the Constitution of the State of Illinois or the statutes of the State of Illinois, which office entitles the holder to compensation in excess of the expenses incurred in the discharge of that office currently or in the previous 3 years. Yes \_\_\_ No \_\_\_

---

(f) Relationship to anyone holding appointive office currently or in the previous 2 years; spouse, father, mother, son, or daughter. Yes \_\_\_ No \_\_\_

---

(g) Employment, currently or in the previous 3 years, as or by any registered lobbyist of the State government. Yes \_\_\_ No \_\_\_

---

**RETURN WITH BID/OFFER**

(h) Relationship to anyone who is or was a registered lobbyist in the previous 2 years; spouse, father, mother, son, or daughter. Yes \_\_\_ No \_\_\_

(i) Compensated employment, currently or in the previous 3 years, by any registered election or reelection committee registered with the Secretary of State or any county clerk of the State of Illinois, or any political action committee registered with either the Secretary of State or the Federal Board of Elections. Yes \_\_\_ No \_\_\_

(j) Relationship to anyone; spouse, father, mother, son, or daughter; who was a compensated employee in the last 2 years by any registered election or re-election committee registered with the Secretary of State or any county clerk of the State of Illinois, or any political action committee registered with either the Secretary of State or the Federal Board of Elections. Yes \_\_\_ No \_\_\_

**APPLICABLE STATEMENT**

**This Disclosure Form A is submitted on behalf of the INDIVIDUAL named on previous page.**

Completed by:  \_\_\_\_\_  
Signature of Individual or Authorized Representative Date

**NOT APPLICABLE STATEMENT**

**I have determined that no individuals associated with this organization meet the criteria that would require the completion of this Form A.**

**This Disclosure Form A is submitted on behalf of the CONTRACTOR listed on the previous page.**

\_\_\_\_\_  
Signature of Authorized Representative Date

RETURN WITH BID/OFFER

ILLINOIS DEPARTMENT  
OF TRANSPORTATION

Form B  
Other Contracts &  
Procurement Related Information  
Disclosure

Contractor Name		
Legal Address		
City, State, Zip		
Telephone Number	Email Address	Fax Number (if available)

Disclosure of the information contained in this Form is required by the Section 50-35 of the Illinois Procurement Act (30 ILCS 500). This information shall become part of the publicly available contract file. This Form B must be completed for bids in excess of \$10,000, and for all open-ended contracts.

**DISCLOSURE OF OTHER CONTRACTS AND PROCUREMENT RELATED INFORMATION**

**1. Identifying Other Contracts & Procurement Related Information.** The BIDDER shall identify whether it has any pending contracts (including leases), bids, proposals, or other ongoing procurement relationship with any other State of Illinois agency: Yes \_\_\_ No \_\_\_

If "No" is checked, the bidder only needs to complete the signature box on the bottom of this page.

**2. If "Yes" is checked.** Identify each such relationship by showing State of Illinois agency name and other descriptive information such as bid or project number (attach additional pages as necessary). SEE DISCLOSURE FORM INSTRUCTIONS:

**THE FOLLOWING STATEMENT MUST BE CHECKED**

<input type="checkbox"/>	_____	_____
	Signature of Authorized Representative	Date

## **RETURN WITH BID**

### **SPECIAL NOTICE TO CONTRACTORS**

The following requirements of the Illinois Department of Human Rights' Rules and Regulations are applicable to bidders on all construction contracts advertised by the Illinois Department of Transportation:

#### **CONSTRUCTION EMPLOYEE UTILIZATION PROJECTION**

- (a) All bidders on construction contracts shall complete and submit, along with and as part of their bids, a Bidder's Employee Utilization Form (Form BC-1256) setting forth a projection and breakdown of the total workforce intended to be hired and/or allocated to such contract work by the bidder including a projection of minority and female employee utilization in all job classifications on the contract project.
- (b) The Department of Transportation shall review the Employee Utilization Form, and workforce projections contained therein, of the contract awardee to determine if such projections reflect an underutilization of minority persons and/or women in any job classification in accordance with the Equal Employment Opportunity Clause and Section 7.2 of the Illinois Department of Human Rights' Rules and Regulations for Public Contracts adopted as amended on September 17, 1980. If it is determined that the contract awardee's projections reflect an underutilization of minority persons and/or women in any job classification, it shall be advised in writing of the manner in which it is underutilizing and such awardee shall be considered to be in breach of the contract unless, prior to commencement of work on the contract project, it submits revised satisfactory projections or an acceptable written affirmative action plan to correct such underutilization including a specific timetable geared to the completion stages of the contract.
- (c) The Department of Transportation shall provide to the Department of Human Rights a copy of the contract awardee's Employee Utilization Form, a copy of any required written affirmative action plan, and any written correspondence related thereto. The Department of Human Rights may review and revise any action taken by the Department of Transportation with respect to these requirements.



**RETURN WITH BID**

**Contract No. 76C82  
Various Counties  
Section DIST 8 SEAL COAT 2010-2  
Various Routes  
District 8 Construction Funds**

**PART II. WORKFORCE PROJECTION - continued**

- B. Included in "Total Employees" under Table A is the total number of **new hires** that would be employed in the event the undersigned bidder is awarded this contract.

The undersigned bidder projects that: (number) \_\_\_\_\_ new hires would be recruited from the area in which the contract project is located; and/or (number) \_\_\_\_\_ new hires would be recruited from the area in which the bidder's principal office or base of operation is located.

- C. Included in "Total Employees" under Table A is a projection of numbers of persons to be employed directly by the undersigned bidder as well as a projection of numbers of persons to be employed by subcontractors.

The undersigned bidder estimates that (number) \_\_\_\_\_ persons will be directly employed by the prime contractor and that (number) \_\_\_\_\_ persons will be employed by subcontractors.

**PART III. AFFIRMATIVE ACTION PLAN**

- A. The undersigned bidder understands and agrees that in the event the foregoing minority and female employee utilization projection included under **PART II** is determined to be an underutilization of minority persons or women in any job category, and in the event that the undersigned bidder is awarded this contract, he/she will, prior to commencement of work, develop and submit a written Affirmative Action Plan including a specific timetable (geared to the completion stages of the contract) whereby deficiencies in minority and/or female employee utilization are corrected. Such Affirmative Action Plan will be subject to approval by the contracting agency and the **Department of Human Rights**.
- B. The undersigned bidder understands and agrees that the minority and female employee utilization projection submitted herein, and the goals and timetable included under an Affirmative Action Plan if required, are deemed to be part of the contract specifications.

Company \_\_\_\_\_ Telephone Number \_\_\_\_\_  
\_\_\_\_\_  
Address \_\_\_\_\_

**NOTICE REGARDING SIGNATURE**

The Bidder's signature on the Proposal Signature Sheet will constitute the signing of this form. The following signature block needs to be completed if revisions are required.

Signature:  \_\_\_\_\_ Title: \_\_\_\_\_ Date: \_\_\_\_\_

- Instructions: All tables must include subcontractor personnel in addition to prime contractor personnel.
- Table A - Include both the number of employees that would be hired to perform the contract work and the total number currently employed (Table B) that will be allocated to contract work, and include all apprentices and on-the-job trainees. The "Total Employees" column should include all employees including all minorities, apprentices and on-the-job trainees to be employed on the contract work.
  - Table B - Include all employees currently employed that will be allocated to the contract work including any apprentices and on-the-job trainees currently employed.
  - Table C - Indicate the racial breakdown of the total apprentices and on-the-job trainees shown in Table A.



**RETURN WITH BID**

**Contract No. 76C82  
Various Counties  
Section DIST 8 SEAL COAT 2010-2  
Various Routes  
District 8 Construction Funds**

PROPOSAL SIGNATURE SHEET

The undersigned bidder hereby makes and submits this bid on the subject Proposal, thereby assuring the Department that all requirements of the Invitation for Bids and rules of the Department have been met, that there is no misunderstanding of the requirements of paragraph 3 of this Proposal, and that the contract will be executed in accordance with the rules of the Department if an award is made on this bid.

Firm Name \_\_\_\_\_  
(IF AN INDIVIDUAL) Signature of Owner \_\_\_\_\_  
Business Address \_\_\_\_\_  
\_\_\_\_\_

\_\_\_\_\_  
Firm Name \_\_\_\_\_  
By \_\_\_\_\_  
(IF A CO-PARTNERSHIP) Business Address \_\_\_\_\_  
Name and Address of All Members of the Firm:  
\_\_\_\_\_  
\_\_\_\_\_

\_\_\_\_\_  
Corporate Name \_\_\_\_\_  
By \_\_\_\_\_  
Signature of Authorized Representative  
\_\_\_\_\_  
Typed or printed name and title of Authorized Representative  
(IF A CORPORATION) Attest \_\_\_\_\_  
Signature  
(IF A JOINT VENTURE, USE THIS SECTION  
FOR THE MANAGING PARTY AND THE  
SECOND PARTY SHOULD SIGN BELOW) Business Address \_\_\_\_\_  
\_\_\_\_\_

\_\_\_\_\_  
Corporate Name \_\_\_\_\_  
By \_\_\_\_\_  
Signature of Authorized Representative  
\_\_\_\_\_  
Typed or printed name and title of Authorized Representative  
(IF A JOINT VENTURE) Attest \_\_\_\_\_  
Signature  
Business Address \_\_\_\_\_  
\_\_\_\_\_

If more than two parties are in the joint venture, please attach an additional signature sheet.



**Illinois Department of Transportation**

**Return with Bid**

**Division of Highways  
Proposal Bid Bond  
(Effective November 1, 1992)**

Item No. \_\_\_\_\_

Letting Date \_\_\_\_\_

KNOW ALL MEN BY THESE PRESENTS, That We \_\_\_\_\_

as PRINCIPAL, and \_\_\_\_\_

\_\_\_\_\_ as SURETY, are held jointly, severally and firmly bound unto the STATE OF ILLINOIS in the penal sum of 5 percent of the total bid price, or for the amount specified in Article 102.09 of the "Standard Specifications for Road and Bridge Construction" in effect on the date of invitation for bids, whichever is the lesser sum, well and truly to be paid unto said STATE OF ILLINOIS, for the payment of which we bind ourselves, our heirs, executors, administrators, successors and assigns.

THE CONDITION OF THE FOREGOING OBLIGATION IS SUCH, that whereas, the PRINCIPAL has submitted a bid proposal to the STATE OF ILLINOIS, acting through the Department of Transportation, for the improvement designated by the Transportation Bulletin Item Number and Letting Date indicated above.

NOW, THEREFORE, if the Department shall accept the bid proposal of the PRINCIPAL; and if the PRINCIPAL shall, within the time and as specified in the bidding and contract documents, submit a DBE Utilization Plan that is accepted and approved by the Department; and if, after award by the Department, the PRINCIPAL shall enter into a contract in accordance with the terms of the bidding and contract documents including evidence of the required insurance coverages and providing such bond as specified with good and sufficient surety for the faithful performance of such contract and for the prompt payment of labor and material furnished in the prosecution thereof; or if, in the event of the failure of the PRINCIPAL to make the required DBE submission or to enter into such contract and to give the specified bond, the PRINCIPAL pays to the Department the difference not to exceed the penalty hereof between the amount specified in the bid proposal and such larger amount for which the Department may contract with another party to perform the work covered by said bid proposal, then this obligation shall be null and void. otherwise. it shall remain in full force and effect.

IN THE EVENT the Department determines the PRINCIPAL has failed to comply with any requirement as set forth in the preceding paragraph, then Surety shall pay the penal sum to the Department within fifteen (15) days of written demand therefor. If Surety does not make full payment within such period of time, the Department may bring an action to collect the amount owed. Surety is liable to the Department for all its expenses, including attorney's fees, incurred in any litigation in which it prevails either in whole or in part.

In TESTIMONY WHEREOF, the said PRINCIPAL and the said SURETY have caused this instrument to be signed by

their respective officers \_\_\_\_\_ day of \_\_\_\_\_ A.D., \_\_\_\_\_ .

**PRINCIPAL**

**SURETY**

\_\_\_\_\_  
(Company Name)

\_\_\_\_\_  
(Company Name)

By \_\_\_\_\_  
(Signature & Title)

By: \_\_\_\_\_  
(Signature of Attorney-in-Fact)

**Notary Certification for Principal and Surety**

STATE OF ILLINOIS,  
County of \_\_\_\_\_

I, \_\_\_\_\_, a Notary Public in and for said County, do hereby certify that

\_\_\_\_\_ and \_\_\_\_\_  
(Insert names of individuals signing on behalf of PRINCIPAL & SURETY)

who are each personally known to me to be the same persons whose names are subscribed to the foregoing instrument on behalf of PRINCIPAL and SURETY, appeared before me this day in person and acknowledged respectively, that they signed and delivered said instrument as their free and voluntary act for the uses and purposes therein set forth.

Given under my hand and notarial seal this \_\_\_\_\_ day of \_\_\_\_\_ A.D. \_\_\_\_\_

My commission expires \_\_\_\_\_

\_\_\_\_\_  
Notary Public

In lieu of completing the above section of the Proposal Bid Form, the Principal may file an Electronic Bid Bond. By signing the proposal and marking the check box next to the Signature and Title line below, the Principal is ensuring the identified electronic bid bond has been executed and the Principal and Surety are firmly bound unto the State of Illinois under the conditions of the bid bond as shown above.

\_\_\_\_\_  
Electronic Bid Bond ID#

\_\_\_\_\_  
Company / Bidder Name

\_\_\_\_\_  
Signature and Title

# PROPOSAL ENVELOPE



# PROPOSALS

for construction work advertised for bids by the  
Illinois Department of Transportation

Item No.	Item No.	Item No.

Submitted By:

Name:
Address:
Phone No.

Bidders should use an IDOT proposal envelope or affix this form to the front of a 10" x 13" envelope for the submittal of bids. If proposals are mailed, they should be enclosed in a second or outer envelope addressed to:

Engineer of Design and Environment - Room 326  
Illinois Department of Transportation  
2300 South Dirksen Parkway  
Springfield, Illinois 62764

## **NOTICE**

**Individual bids, including Bid Bond and/or supplemental information if required, should be securely stapled.**

# CONTRACTOR OFFICE COPY OF CONTRACT SPECIFICATIONS

---

## NOTICE

None of the following material needs to be returned with the bid package unless the special provisions require documentation and/or other information to be submitted.

**Contract No. 76C82**  
**Various Counties**  
**Section DIST 8 SEAL COAT 2010-2**  
**Various Routes**  
**District 8 Construction Funds**

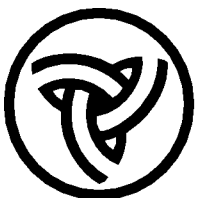

**Illinois Department of Transportation**



## NOTICE TO BIDDERS

1. **TIME AND PLACE OF OPENING BIDS.** Sealed proposals for the improvement described herein will be received by the Department of Transportation at the Harry R. Hanley Building, 2300 South Dirksen Parkway, in Springfield, Illinois until 10:00 o'clock a.m., June 12, 2009. All bids will be gathered, sorted, publicly opened and read in the auditorium at the Department of Transportation's Harry R. Hanley Building shortly after the 10:00 a.m. cut off time.

2. **DESCRIPTION OF WORK.** The proposed improvement is identified and advertised for bids in the Invitation for Bids as:

**Contract No. 76C82**  
**Various Counties**  
**Section DIST 8 SEAL COAT 2010-2**  
**Various Routes**  
**District 8 Construction Funds**

**Cover and seal coats at various locations in Jersey, Greene and Calhoun Counties.**

3. **INSTRUCTIONS TO BIDDERS.** (a) This Notice, the invitation for bids, proposal and letter of award shall, together with all other documents in accordance with Article 101.09 of the Standard Specifications for Road and Bridge Construction, become part of the contract. Bidders are cautioned to read and examine carefully all documents, to make all required inspections, and to inquire or seek explanation of the same prior to submission of a bid.

(b) State law, and, if the work is to be paid wholly or in part with Federal-aid funds, Federal law requires the bidder to make various certifications as a part of the proposal and contract. By execution and submission of the proposal, the bidder makes the certification contained therein. A false or fraudulent certification shall, in addition to all other remedies provided by law, be a breach of contract and may result in termination of the contract.

4. **AWARD CRITERIA AND REJECTION OF BIDS.** This contract will be awarded to the lowest responsive and responsible bidder considering conformity with the terms and conditions established by the Department in the rules, Invitation for Bids and contract documents. The issuance of plans and proposal forms for bidding based upon a prequalification rating shall not be the sole determinant of responsibility. The Department reserves the right to determine responsibility at the time of award, to reject any or all proposals, to readvertise the proposed improvement, and to waive technicalities.

By Order of the  
Illinois Department of Transportation

Gary Hannig,  
Acting Secretary

INDEX  
FOR  
SUPPLEMENTAL SPECIFICATIONS  
AND RECURRING SPECIAL PROVISIONS

Adopted January 1, 2009

This index contains a listing of SUPPLEMENTAL SPECIFICATIONS and frequently used RECURRING SPECIAL PROVISIONS.

ERRATA Standard Specifications for Road and Bridge Construction (Adopted 1-1-07) (Revised 1-1-09)

SUPPLEMENTAL SPECIFICATIONS

<u>Std. Spec. Sec.</u>	<u>Page No.</u>
201 Clearing, Tree Removal and Protection .....	1
205 Embankment .....	2
251 Mulch .....	3
253 Planting Woody Plants .....	4
280 Temporary Erosion Control .....	6
443 Reflective Crack Control Treatment .....	7
502 Excavation for Structures .....	10
503 Concrete Structures .....	11
504 Precast Concrete Structures .....	12
505 Steel Structures .....	13
540 Box Culverts .....	14
581 Waterproofing Membrane System .....	15
633 Removing and Reerecting Guardrail and Terminals .....	16
669 Removal and Disposal of Regulated Substances .....	17
672 Sealing Abandoned Water Wells .....	18
701 Work Zone Traffic Control and Protection .....	19
733 Overhead Sign Structures .....	20
783 Pavement Marking and Marker Removal .....	21
801 Electrical Requirements .....	22
805 Electrical Service Installation – Traffic Signals .....	23
836 Pole Foundation .....	24
838 Breakaway Devices .....	25
862 Uninterruptable Power Supply .....	26
873 Electric Cable .....	28
878 Traffic Signal Concrete Foundation .....	30
1004 Coarse Aggregates .....	31
1008 Structural Steel Coatings .....	32
1010 Finely Divided Materials .....	33
1020 Portland Cement Concrete .....	34
1022 Concrete Curing Materials .....	43
1024 Nonshrink Grout .....	44
1042 Precast Concrete Products .....	45
1062 Reflective Crack Control System .....	47
1069 Pole and Tower .....	49
1074 Control Equipment .....	52
1076 Wire and Cable .....	57
1081 Materials for Planting .....	58
1083 Elastomeric Bearings .....	60
1094 Overhead Sign Structures .....	61
1101 General Equipment .....	62
1102 Hot-Mix Asphalt Equipment .....	63
1106 Work Zone Traffic Control Devices .....	64

RECURRING SPECIAL PROVISIONS

The following RECURRING SPECIAL PROVISIONS indicated by an "X" are applicable to this contract and are included by reference:

<u>CHECK SHEET #</u>	<u>PAGE NO.</u>
1	65
2	67
3	68
4	78
5	83
6	88
7	89
8	90
9	91
10	94
11	97
12	99
13	103
14	105
15	106
16	108
17	109
18	111
19	112
20	113
21	117
22	119
23	121
24	123
25	124
26	125
27	126
28	127
29	128
30	129
31	137
32	149
33	150

## TABLE OF CONTENTS

LOCATION OF PROJECT .....	1
DESCRIPTION OF PROJECT .....	1
MONTHLY LABOR SUMMARY AND ACTIVITY REPORTING SYSTEM .....	1
HOT-MIX ASPHALT SURFACE TREATMENT (CLASS A-1, A-2, A-3).....	4
TRAFFIC CONTROL PLAN .....	4
CONSTRUCTION AND MAINTENANCE SIGN SUPPORTS .....	4
STATUS OF UTILITIES TO BE ADJUSTED .....	5
APPROVAL OF PROPOSED BORROW AREAS, USE AREAS, AND/OR WASTE AREAS INSIDE ILLINOIS STATE BORDERS (BDE) .....	5
AUTOMATED FLAGGER ASSISTANCE DEVICES (BDE).....	5
CONSTRUCTION AIR QUALITY - IDLING RESTRICTIONS (BDE).....	7
DISADVANTAGED BUSINESS ENTERPRISE PARTICIPATION (BDE) .....	8
EQUIPMENT RENTAL RATES (BDE).....	15
FLAGGER AT SIDE ROADS AND ENTRANCES (BDE) .....	16
LIQUIDATED DAMAGES (BDE).....	17
NATIONAL POLLUTANT DISCHARGE ELIMINATION SYSTEM / EROSION AND SEDIMENT CONTROL DEFICIENCY DEDUCTION (BDE) .....	17
PAYMENTS TO SUBCONTRACTORS (BDE) .....	18
PAYROLLS AND PAYROLL RECORDS (BDE) .....	19
PERSONAL PROTECTIVE EQUIPMENT (BDE) .....	20
REFLECTIVE SHEETING ON CHANNELIZING DEVICES (BDE) .....	21
SUBCONTRACTOR MOBILIZATION PAYMENTS (BDE) .....	21
WORKING DAYS (BDE) .....	22



## STATE OF ILLINOIS

---

### SPECIAL PROVISIONS

The following Special Provisions supplement the "Standard Specifications for Road and Bridge Construction," adopted January 1, 2007, the latest edition of the "Manual on Uniform Traffic Control Devices for Streets and Highways," and the "Manual of Test Procedures for Materials" in effect on the date of invitation for bids, and the Supplemental Specifications and Recurring Special Provisions indicated on the Check Sheet included herein which apply to and govern the construction of Various Routes; Section Dist 8 Seal Coat 2010-2; Various Counties; Contract No. 76C82, and in case of conflict with any part or parts of said Specifications, the said Special Provisions shall take precedence and shall govern.

#### LOCATION OF PROJECT

Various locations in Jersey, Greene and Calhoun Counties.

#### DESCRIPTION OF PROJECT

The project consists of A-1 and A-2 Seal Coats at various locations and maintenance facilities in Jersey, Greene and Calhoun Counties. Pay items included in the project are Bituminous Materials (Prime Coat), Bituminous Materials (Cover and Seal Coat), Cover Coat Aggregate, Seal Coat Aggregate and Traffic Control.

#### MONTHLY LABOR SUMMARY AND ACTIVITY REPORTING SYSTEM

Effective: 1-1-1995

Revised June 2001

##### I. Monthly Labor Summary Report, Form SBE 148

The prime contractor and each first and second tier sub-contractor, (hereinafter referred to as "subcontractor") shall submit a certified Monthly Labor Summary Report directly to the District Engineer.

This report is in lieu of submittal of the Monthly Workforce Analysis Report, Form SBE 956.

This report must be received in District Eight no later than the tenth day of the next month.

This Report shall be submitted by the prime contractor and each subcontractor, for each consecutive month, from the start, to the completion of their work on the contract.

The data source for this Report will be a summation of all personnel and hours worked on each subject contract for the month based on weekly payrolls for that month.

The Monthly Labor Summary Report is required to be submitted in one of the following formats:

- a.) For contractors having IDOT contracts valued in the aggregate at \$250,000 or less, the report may be typed or clearly handwritten using Form SBE 148 for submittal to the District Engineer for District Eight.
- b.) For contractors having IDOT contracts valued in the aggregate at more than \$250,000, the report must be submitted in a specific "Fixed Length Comma Delimited ASCII Text File Format". The subject file format is detailed on the next page. Submittal of this file may be by 3.5 inch disk, modem, or by e-mail.

## II. Monthly Contract Activity Report, Form SBE 248

The prime contractor and each subcontractor shall submit a monthly report directly to the District Engineer reflecting their contract activity on all Illinois Department of Transportation contracts they have in force in District Eight.

This report shall be submitted for each consecutive month, from the start, to the completion of all contracts in District Eight.

The report must be received in the District Office no later than the tenth day of the next month.

## Monthly Labor Summary and Activity Reporting System Codes and Formats

Indicated below for your reference are the Employee Codes and File Formats required for this system.

### I.) Monthly Labor Summary Report, Form SBE 148

The following employee codes are to be used to identify each individual on the Summary Report:

1. **Gender:**        **M** - Male        **F** - Female
2. **Ethnic Group:**    **1** - White        **2** - Black        **3** - Hispanic  
                         **4** - American Indian/Alaskan Native        **5** - Asian/Pacific Islander
3. **Work Classification:** **OF** - Official    **SU** - Supervisor        **FO** - Foremen  
                         **CL** - Clerical    **CA** - Carpenter        **EO** - Operator        **ME** - Mechanic  
                         **TD** - Truck Driver    **IW** - Ironworker        **PA** - Painter        **OT** - Other  
                         **EL** - Electrician    **PP** - Pipefitter        **TE** - Technical        **LA** - Laborer  
                         **CM** - Cement Mason
4. **Employee Status:**    **O** - Owner Operator        **J** - Journeyman  
                         **C** - Company        **A** - Apprentice        **T** - Trainee

Specific “Fixed Length Comma Delimited ASCII File Format”

Order	Field Name	Type	Size
1	Contractor Number	A	4
2	Contractor Reference Number	A	6
3	Contract Number	A	5
4	Period (07/28/2000)	D	10
5	SSN (111-11-1111)	A	11
6	Name	A	40
7	Gender	A	1
8	Ethnic Group	A	1
9	Work Classification	A	1
10	Employee Status	A	1
11	Total Hours (000060.00)	N	10

File Name Conventions: (Contractor Number + Report Month/Year).Txt  
i.e. 20001298.Txt

II.) Monthly Contract Activity Report, Form SBE 248

The following activity codes are to be used to identify the contractor’s contract status each month on the Monthly Activity Report, Form SBE 248:

- A. Contract Status:      1 - Not Started      2 - Active      3 - No Work  
4 - Suspended      5 - Complete

Failure to comply with this special provision may result in the withholding of payments to the contractor, and/or cancellation, termination, or suspension of the contract in whole or part.

Compliance with this Special Provision shall be considered incidental to the cost of the contract and no additional compensation will be allowed for any costs incurred.

All prime and subcontractors having contracts in the aggregate exceeding \$250,000 must provide a “Fixed Length Comma Delimited ASCII File” for approval prior to the start of construction.

This Special Provision must be included in each subcontract agreement.

The Department of Transportation is requesting disclosure of information necessary to accomplish the statutory purpose as outlined under 23CFR part 230 and 41CFR part 60.4 and the Illinois Human Rights Act. Disclosure of this information is REQUIRED. Failure to comply with this special provision may result in the withholding of payments to the contractor, and/or cancellation, termination, or suspension of the contract in whole or part.

Compliance with this Special Provision shall be considered incidental to the cost of the contract and no additional compensation will be allowed for any costs incurred.

This Special Provision must be included in each subcontract agreement.

**HOT-MIX ASPHALT SURFACE TREATMENT (CLASS A-1, A-2, A-3)**

Effective: March 28, 1975

Revised: November 1, 2006

Under Materials Article 1004.03(c), add:

CA-16 or CM-16 may be used for Cover and Seal Coat Aggregate.

**TRAFFIC CONTROL PLAN**

Effective: July 12, 1993

Revised: May 12, 1997

Traffic control shall be in accordance with the applicable sections of the "Standard Specifications for Road and Bridge Construction", the applicable guidelines contained in the "National Manual on Uniform Traffic Control Devices for Streets and Highways", Illinois Supplement to the National Manual of Uniform Traffic Control Devices, these Special Provisions, and any special details and Highway Standards contained herein and in the plans.

Special attention is called to Articles 107.09 and 107.14 of the "Standard Specifications for Road and Bridge Construction and the following Highway Standards relating to traffic control:

701001      701006      701011      701306      701901

In addition, the following Special Provision(s) will also govern traffic control for this project:

Construction and Maintenance Sign Supports  
Automated Flagger Assistance Device  
Reflective Sheeting on Channelizing Devices  
Flagger at Side Roads and Entrances

**CONSTRUCTION AND MAINTENANCE SIGN SUPPORTS**

Effective: April 21, 1981

Revised: November 1, 2006

This work shall be done according to Section 1106 of the Standard Specifications and Highway Standard 701901 except as herein modified.

All construction signs mounted on permanent support for use in temporary traffic control having an area of 10 square feet (1 square meter) or more shall be mounted on two 4 in x 4 in (100 mm x 100 mm) or two 4 in x 6 in (100 mm x 150 mm) wood posts.

Type A metal post (two for each sign) conforming to Article 1006.29 of the Standard Specifications may be used in lieu of wood posts. Type A metal posts used for these signs may be unfinished.

This work shall not be paid for separately; but shall be considered included in the cost of the traffic control items in this contract.

## STATUS OF UTILITIES TO BE ADJUSTED

### NO UTILITIES TO BE ADJUSTED

The above represents the best information of the Department and is only included for the convenience of the bidder. The applicable provisions of Sections 102, 103, and Articles 105.07 and 107.20 of the Standard Specifications for Road and Bridge Construction shall apply.

If any utility adjustment or removal has not been completed when required by the Contractor's operation, the Contractor should notify the Engineer in writing. A request for an extension of time will be considered to the extent the Contractor's operations were affected.

## APPROVAL OF PROPOSED BORROW AREAS, USE AREAS, AND/OR WASTE AREAS INSIDE ILLINOIS STATE BORDERS (BDE)

Effective: November 1, 2008

Revise the title of Article 107.22 of the Standard Specifications to read:

**“107.22 Approval of Proposed Borrow Areas, Use Areas, and/or Waste Areas Inside Illinois State Borders.”**

Add the following sentence to the end of the first paragraph of Article 107.22 of the Standard Specifications:

“Proposed borrow areas, use areas, and/or waste areas outside of Illinois shall comply with Article 107.01.”

## AUTOMATED FLAGGER ASSISTANCE DEVICES (BDE)

Effective: January 1, 2008

Description. This work shall consist of furnishing and operating automated flagger assistance devices (AFADs) as part of the work zone traffic control and protection for two-lane highways where two-way traffic is maintained over one lane of pavement. Use of these devices shall be at the option of the Contractor.

Equipment. AFADs shall be according to the FHWA memorandum, “MUTCD - Revised Interim Approval for the use of Automated Flagger Assistance Devices in Temporary Traffic Control Zones (IA-4R)”, dated January 28, 2005. The devices shall be mounted on a trailer or a moveable cart and shall meet the requirements of NCHRP 350, Category 4.

The AFAD shall be the Stop/Slow type. This device uses remotely controlled “STOP” and “SLOW” signs to alternately control right-of-way.

Signs for the AFAD shall be according to Article 701.03 of the Standard Specifications and the MUTCD. The signs shall be 24 x 24 in. (600 x 600 mm) having an octagon shaped “STOP” sign

on one side and a diamond shaped "SLOW" sign on the opposite side. The letters on the signs shall be 8 in. (200 mm) high. If the "STOP" sign has louvers, the full sign face shall be visible at a distance of 50 ft (15 m) and greater.

The signs shall be supplemented with one of the following types of lights.

- (a) Flashing Lights. When flashing lights are used, white or red flashing lights shall be mounted within the "STOP" sign face and white or yellow flashing lights within the "SLOW" sign face.
- (b) Stop and Warning Beacons. When beacons are used, a stop beacon shall be mounted 24 in. (600 mm) or less above the "STOP" sign face and a warning beacon mounted 24 in. (600 mm) or less above, below, or to the side of the "SLOW" sign face. As an option, a Type B warning light may be used in lieu of the warning beacon.

A "WAIT ON STOP" sign shall be placed on the right hand side of the roadway at a point where drivers are expected to stop. The sign shall be 24 x 30 in. (600 x 750 mm) with a black legend and border on a white background. The letters shall be at least 6 in. (150 mm) high.

This device may include a gate arm or mast arm that descends to a horizontal position when the "STOP" sign is displayed and rises to a vertical position when the "SLOW" sign is displayed. When included, the end of the arm shall reach at least to the center of the lane being controlled. The arm shall have alternating red and white retroreflective stripes, on both sides, sloping downward at 45 degrees toward the side on which traffic will pass. The stripes shall be 6 in. (150 mm) in width and at least 2 in. (50 mm) in height.

Flagging Requirements. Flaggers and flagging requirements shall be according to Article 701.13 of the Standard Specifications and the following.

AFADs shall be placed at each end of the traffic control, where a flagger is shown on the plans. The flaggers shall be able to view the face of the AFAD and approaching traffic during operation.

To stop traffic, the "STOP" sign shall be displayed, the corresponding lights/beacon shall flash, and when included, the gate arm shall descend to a horizontal position. To permit traffic to move, the "SLOW" sign shall be displayed, the corresponding lights/beacon shall flash, and when included, the gate arm shall rise to a vertical position.

If used at night, the AFAD location shall be illuminated according to Section 701 of the Standard Specifications.

When not in use, AFADs will be considered nonoperating equipment and shall be stored according to Article 701.11 of the Standard Specifications.

Basis of Payment. This work will not be paid for separately but shall be considered as included in the cost of the various traffic control items included in the contract.

## **CONSTRUCTION AIR QUALITY - IDLING RESTRICTIONS (BDE)**

Effective: April 1, 2009

Idling Restrictions. The Contractor shall establish truck-staging areas for all diesel powered vehicles that are waiting to load or unload material at the jobsite. Staging areas shall be located where the diesel emissions from the equipment will have a minimum impact on adjacent sensitive receptors. The Department will review the selection of staging areas, whether within or outside the existing highway right-of-way, to avoid locations near sensitive areas or populations to the extent possible. Sensitive receptors include, but are not limited to, hospitals, schools, residences, motels, hotels, daycare facilities, elderly housing and convalescent facilities. Diesel powered engines shall also be located as far away as possible from fresh air intakes, air conditioners, and windows. The Engineer will approve staging areas before implementation.

Diesel powered vehicle operators may not cause or allow the motor vehicle, when it is not in motion, to idle for more than a total of 10 minutes within any 60 minute period, except under any of the following circumstances:

- 1) The motor vehicle has a gross vehicle weight rating of less than 8000 lb (3630 kg).
- 2) The motor vehicle idles while forced to remain motionless because of on-highway traffic, an official traffic control device or signal, or at the direction of a law enforcement official.
- 3) The motor vehicle idles when operating defrosters, heaters, air conditioners, or other equipment solely to prevent a safety or health emergency.
- 4) A police, fire, ambulance, public safety, other emergency or law enforcement motor vehicle, or any motor vehicle used in an emergency capacity, idles while in an emergency or training mode and not for the convenience of the vehicle operator.
- 5) The primary propulsion engine idles for maintenance, servicing, repairing, or diagnostic purposes if idling is necessary for such activity.
- 6) A motor vehicle idles as part of a government inspection to verify that all equipment is in good working order, provided idling is required as part of the inspection.
- 7) When idling of the motor vehicle is required to operate auxiliary equipment to accomplish the intended use of the vehicle (such as loading, unloading, mixing, or processing cargo; controlling cargo temperature; construction operations, lumbering operations; oil or gas well servicing; or farming operations), provided that this exemption does not apply when the vehicle is idling solely for cabin comfort or to operate non-essential equipment such as air conditioning, heating, microwave ovens, or televisions.
- 8) When the motor vehicle idles due to mechanical difficulties over which the operator has no control.
- 9) The outdoor temperature is less than 32 °F (0 °C) or greater than 80 °F (26 °C).

When the outdoor temperature is greater than or equal to 32 °F (0 °C) or less than or equal to 80 °F (26 °C), a person who operates a motor vehicle operating on diesel fuel shall not cause or allow the motor vehicle to idle for a period greater than 30 minutes in any 60 minute period while waiting to weigh, load, or unload cargo or freight, unless the vehicle is in a line of vehicles that regularly and periodically moves forward.

The above requirements do not prohibit the operation of an auxiliary power unit or generator set as an alternative to idling the main engine of a motor vehicle operating on diesel fuel.

Environmental Deficiency Deduction. When the Engineer is notified, or determines that an environmental control deficiency exists based on non-compliance with the idling restrictions, he/she will notify the Contractor, and direct the Contractor to correct the deficiency.

If the Contractor fails to correct the deficiency a monetary deduction will be imposed. The monetary deduction will be \$1,000.00 for each deficiency identified.

**DISADVANTAGED BUSINESS ENTERPRISE PARTICIPATION (BDE)**

Effective: September 1, 2000

Revised: November 1, 2008

FEDERAL OBLIGATION. The Department of Transportation, as a recipient of federal financial assistance, is required to take all necessary and reasonable steps to ensure nondiscrimination in the award and administration of contracts. Consequently, the federal regulatory provisions of 49 CFR part 26 apply to this contract concerning the utilization of disadvantaged business enterprises. For the purposes of this Special Provision, a disadvantaged business enterprise (DBE) means a business certified by the Department in accordance with the requirements of 49 CFR part 26 and listed in the Illinois Unified Certification Program (IL UCP) DBE Directory or most recent addendum.

STATE OBLIGATION. This Special Provision will also be used by the Department to satisfy the requirements of the Business Enterprise for Minorities, Females, and Persons with Disabilities Act, 30 ILCS 575. When this Special Provision is used to satisfy state law requirements on 100 percent state-funded contracts, the federal government has no involvement in such contracts (not a federal-aid contract) and no responsibility to oversee the implementation of this Special Provision by the Department on those contracts. DBE participation on 100 percent state-funded contracts will not be credited toward fulfilling the Department's annual overall DBE goal required by the US Department of Transportation to comply with the federal DBE program requirements.

CONTRACTOR ASSURANCE. The Contractor makes the following assurance and agrees to include the assurance in each subcontract that the Contractor signs with a subcontractor:

The Contractor, subrecipient, or subcontractor shall not discriminate on the basis of race, color, national origin, or sex in the performance of this contract. The Contractor shall carry out applicable requirements of 49 CFR part 26 in the award and administration of contracts funded in whole or in part with federal or state funds. Failure by the Contractor to carry out these requirements is a material breach of this contract, which may result in the termination of this contract or such other remedy as the recipient deems appropriate.

OVERALL GOAL SET FOR THE DEPARTMENT. As a requirement of compliance with 49 CFR part 26, the Department has set an overall goal for DBE participation in its federally assisted contracts. That goal applies to all federal-aid funds the Department will expend in its federally assisted contracts for the subject reporting fiscal year. The Department is required to make a good faith effort to achieve the overall goal. The dollar amount paid to all approved DBE companies performing work called for in this contract is eligible to be credited toward fulfillment of the Department's overall goal.



CONTRACT GOAL TO BE ACHIEVED BY THE CONTRACTOR. This contract includes a specific DBE utilization goal established by the Department. The goal has been included because the Department has determined that the work of this contract has subcontracting opportunities that may be suitable for performance by DBE companies. This determination is based on an assessment of the type of work, the location of the work, and the availability of DBE companies to do a part of the work. The assessment indicates that, in the absence of unlawful discrimination, and in an arena of fair and open competition, DBE companies can be expected to perform 0.0% of the work. This percentage is set as the DBE participation goal for this contract. Consequently, in addition to the other award criteria established for this contract, the Department will award this contract to a bidder who makes a good faith effort to meet this goal of DBE participation in the performance of the work. A bidder makes a good faith effort for award consideration if either of the following is done in accordance with the procedures set forth in this Special Provision:

- (a) The bidder documents that firmly committed DBE participation has been obtained to meet the goal; or
- (b) The bidder documents that a good faith effort has been made to meet the goal, even though the effort did not succeed in obtaining enough DBE participation to meet the goal.

DBE LOCATOR REFERENCES. Bidders may consult the IL UCP DBE Directory as a reference source for DBE-certified companies. In addition, the Department maintains a letting and item specific DBE locator information system whereby DBE companies can register their interest in providing quotes on particular bid items advertised for letting. Information concerning DBE companies willing to quote work for particular contracts may be obtained by contacting the Department's Bureau of Small Business Enterprises at telephone number (217)785-4611, or by visiting the Department's web site at [www.dot.il.gov](http://www.dot.il.gov).

BIDDING PROCEDURES. Compliance with the bidding procedures of this Special Provision is required prior to the award of the contract and the failure of the as-read low bidder to comply will render the bid not responsive.

- (a) In order to assure the timely award of the contract, the as-read low bidder shall submit a Disadvantaged Business Utilization Plan on Department form SBE 2026 within seven working days after the date of letting. To meet the seven day requirement, the bidder may send the Plan by certified mail or delivery service within the seven working day period. If a question arises concerning the mailing date of a Plan, the mailing date will be established by the U.S. Postal Service postmark on the original certified mail receipt from the U.S. Postal Service or the receipt issued by a delivery service. It is the responsibility of the bidder to ensure that the postmark or receipt date is affixed within the seven working days if the bidder intends to rely upon mailing or delivery to satisfy the submission day requirement. The Plan is to be submitted to the Department of Transportation, Bureau of Small Business Enterprises, Contract Compliance Section, 2300 South Dirksen Parkway, Room 319, Springfield, Illinois 62764 (Telefax: (217)785-1524). It is the responsibility of the bidder to obtain confirmation of telefax delivery. The Department will not accept a Utilization Plan if it does not meet the seven day submittal requirement and the bid will be declared not responsive. In the event the bid is declared

not responsive due to a failure to submit a Plan or failure to comply with the bidding procedures set forth herein, the Department may elect to cause the forfeiture of the penal sum of the bidder's proposal guaranty, and may deny authorization to bid the project if re-advertised for bids. The Department reserves the right to invite any other bidder to submit a Utilization Plan at any time for award consideration or to extend the time for award.

- (b) The Utilization Plan shall indicate that the bidder either has obtained sufficient DBE participation commitments to meet the contract goal or has not obtained enough DBE participation commitments in spite of a good faith effort to meet the goal. The Utilization Plan shall further provide the name, telephone number, and telefax number of a responsible official of the bidder designated for purposes of notification of plan approval or disapproval under the procedures of this Special Provision.
- (c) The Utilization Plan shall include a DBE Participation Commitment Statement, Department form SBE 2025, for each DBE proposed for the performance of work to achieve the contract goal. The signatures on these forms must be original signatures. All elements of information indicated on the said form shall be provided, including but not limited to the following:
  - (1) The name and address of each DBE to be used;
  - (2) A description, including pay item numbers, of the commercially useful work to be done by each DBE;
  - (3) The price to be paid to each DBE for the identified work specifically stating the quantity, unit price, and total subcontract price for the work to be completed by the DBE. If partial pay items are to be performed by the DBE, indicate the portion of each item, a unit price where appropriate and the subcontract price amount;
  - (4) A commitment statement signed by the bidder and each DBE evidencing availability and intent to perform commercially useful work on the project; and
  - (5) If the bidder is a joint venture comprised of DBE companies and non-DBE companies, the plan must also include a clear identification of the portion of the work to be performed by the DBE partner(s).
- (d) The contract will not be awarded until the Utilization Plan submitted by the bidder is approved. The Utilization Plan will be approved by the Department if the Plan commits sufficient commercially useful DBE work performance to meet the contract goal. The Utilization Plan will not be approved by the Department if the Plan does not commit sufficient DBE performance to meet the contract goal unless the bidder documents that it made a good faith effort to meet the goal. The good faith procedures of Section VIII of this special provision apply. If the Utilization Plan is not approved because it is deficient in a technical matter, unless waived by the Department, the bidder will be notified and will be allowed no less than a five working day period in order to cure the deficiency.

CALCULATING DBE PARTICIPATION. The Utilization Plan values represent work anticipated to be performed and paid for upon satisfactory completion. The Department is only able to count toward the achievement of the overall goal and the contract goal the value of payments made for the work actually performed by DBE companies. In addition, a DBE must perform a commercially useful function on the contract to be counted. A commercially useful function is generally performed when the DBE is responsible for the work and is carrying out its responsibilities by actually performing, managing, and supervising the work involved. The Department and Contractor are governed by the provisions of 49 CFR part 26.55(c) on questions of commercially useful functions as it affects the work. Specific counting guidelines are provided in 49 CFR part 26.55, the provisions of which govern over the summary contained herein.

- (a) DBE as the Contractor: 100 percent goal credit for that portion of the work performed by the DBE's own forces, including the cost of materials and supplies. Work that a DBE subcontracts to a non-DBE does not count toward the DBE goals.
- (b) DBE as a joint venture Contractor: 100 percent goal credit for that portion of the total dollar value of the contract equal to the distinct, clearly defined portion of the work performed by the DBE's own forces.
- (c) DBE as a subcontractor: 100 percent goal credit for the work of the subcontract performed by the DBE's own forces, including the cost of materials and supplies, excluding the purchase of materials and supplies or the lease of equipment by the DBE subcontractor from the prime Contractor or its affiliates. Work that a DBE subcontractor in turn subcontracts to a non-DBE does not count toward the DBE goal.
- (d) DBE as a trucker: 100 percent goal credit for trucking participation provided the DBE is responsible for the management and supervision of the entire trucking operation for which it is responsible. At least one truck owned, operated, licensed, and insured by the DBE must be used on the contract. Credit will be given for the full value of all such DBE trucks operated using DBE employed drivers. Goal credit will be limited to the value of the reasonable fee or commission received by the DBE if trucks are leased from a non-DBE company.
- (e) DBE as a material supplier:
  - (1) 60 percent goal credit for the cost of the materials or supplies purchased from a DBE regular dealer.
  - (2) 100 percent goal credit for the cost of materials or supplies obtained from a DBE manufacturer.
  - (3) 100 percent credit for the value of reasonable fees and commissions for the procurement of materials and supplies if not a regular dealer or manufacturer.

GOOD FAITH EFFORT PROCEDURES. If the bidder cannot obtain sufficient DBE commitments to meet the contract goal, the bidder must document in the Utilization Plan the good faith efforts made in the attempt to meet the goal. This means that the bidder must show

that all necessary and reasonable steps were taken to achieve the contract goal. Necessary and reasonable steps are those which could reasonably be expected to obtain sufficient DBE participation. The Department will consider the quality, quantity, and intensity of the kinds of efforts that the bidder has made. Mere *pro forma* efforts are not good faith efforts; rather, the bidder is expected to have taken those efforts that would be reasonably expected of a bidder actively and aggressively trying to obtain DBE participation sufficient to meet the contract goal.

- (a) The following is a list of types of action that the Department will consider as part of the evaluation of the bidder's good faith efforts to obtain participation. These listed factors are not intended to be a mandatory checklist and are not intended to be exhaustive. Other factors or efforts brought to the attention of the Department may be relevant in appropriate cases, and will be considered by the Department.
  - (1) Soliciting through all reasonable and available means (e.g. attendance at pre-bid meetings, advertising and/or written notices) the interest of all certified DBE companies that have the capability to perform the work of the contract. The bidder must solicit this interest within sufficient time to allow the DBE companies to respond to the solicitation. The bidder must determine with certainty if the DBE companies are interested by taking appropriate steps to follow up initial solicitations.
  - (2) Selecting portions of the work to be performed by DBE companies in order to increase the likelihood that the DBE goals will be achieved. This includes, where appropriate, breaking out contract work items into economically feasible units to facilitate DBE participation, even when the prime Contractor might otherwise prefer to perform these work items with its own forces.
  - (3) Providing interested DBE companies with adequate information about the plans, specifications, and requirements of the contract in a timely manner to assist them in responding to a solicitation.
  - (4)
    - a. Negotiating in good faith with interested DBE companies. It is the bidder's responsibility to make a portion of the work available to DBE subcontractors and suppliers and to select those portions of the work or material needs consistent with the available DBE subcontractors and suppliers, so as to facilitate DBE participation. Evidence of such negotiation includes the names, addresses, and telephone numbers of DBE companies that were considered; a description of the information provided regarding the plans and specifications for the work selected for subcontracting; and evidence as to why additional agreements could not be reached for DBE companies to perform the work.
    - b. A bidder using good business judgment would consider a number of factors in negotiating with subcontractors, including DBE subcontractors, and would take a firm's price and capabilities as well as contract goals into consideration. However, the fact that there may be some additional costs involved in finding and using DBE companies is not in itself sufficient reason for a bidder's failure to meet the contract DBE goal, as long as such costs are reasonable. Also, the ability or desire of a bidder to perform the work of a contract with its own

organization does not relieve the bidder of the responsibility to make good faith efforts. Bidders are not, however, required to accept higher quotes from DBE companies if the price difference is excessive or unreasonable.

- (5) Not rejecting DBE companies as being unqualified without sound reasons based on a thorough investigation of their capabilities. The bidder's standing within its industry, membership in specific groups, organizations, or associations and political or social affiliations (for example union vs. non-union employee status) are not legitimate causes for the rejection or non-solicitation of bids in the bidder's efforts to meet the project goal.
  - (6) Making efforts to assist interested DBE companies in obtaining bonding, lines of credit, or insurance as required by the recipient or Contractor.
  - (7) Making efforts to assist interested DBE companies in obtaining necessary equipment, supplies, materials, or related assistance or services.
  - (8) Effectively using the services of available minority/women community organizations; minority/women contractors' groups; local, state, and federal minority/women business assistance offices; and other organizations as allowed on a case-by-case basis to provide assistance in the recruitment and placement of DBE companies.
- (b) If the Department determines that the bidder has made a good faith effort to secure the work commitment of DBE companies to meet the contract goal, the Department will award the contract provided that it is otherwise eligible for award. If the Department determines that a good faith effort has not been made, the Department will notify the bidder of that preliminary determination by contacting the responsible company official designated in the Utilization Plan. The preliminary determination shall include a statement of reasons why good faith efforts have not been found, and may include additional good faith efforts that the bidder could take. The notification will designate a five working day period during which the bidder shall take additional efforts. The bidder is not limited by a statement of additional efforts, but may take other action beyond any stated additional efforts in order to obtain additional DBE commitments. The bidder shall submit an amended Utilization Plan if additional DBE commitments to meet the contract goal are secured. If additional DBE commitments sufficient to meet the contract goal are not secured, the bidder shall report the final good faith efforts made in the time allotted. All additional efforts taken by the bidder will be considered as part of the bidder's good faith efforts. If the bidder is not able to meet the goal after taking additional efforts, the Department will make a pre-final determination of the good faith efforts of the bidder and will notify the designated responsible company official of the reasons for an adverse determination.
- (c) The bidder may request administrative reconsideration of a pre-final determination adverse to the bidder within the five working days after the notification date of the determination by delivering the request to the Department of Transportation, Bureau of Small Business Enterprises, Contract Compliance Section, 2300 South Dirksen Parkway, Room 319, Springfield, Illinois 62764 (Telefax: (217)785-1524). Deposit of the request in the United States mail on or before the fifth business day shall not be deemed

delivery. The pre-final determination shall become final if a request is not made and delivered. A request may provide additional written documentation and/or argument concerning the issue of whether an adequate good faith effort was made to meet the contract goal. In addition, the request shall be considered a consent by the bidder to extend the time for award. The request will be forwarded to the Department's Reconsideration Officer. The Reconsideration Officer will extend an opportunity to the bidder to meet in person in order to consider all issues of whether the bidder made a good faith effort to meet the goal. After the review by the Reconsideration Officer, the bidder will be sent a written decision within ten working days after receipt of the request for reconsideration, explaining the basis for finding that the bidder did or did not meet the goal or make adequate good faith efforts to do so. A final decision by the Reconsideration Officer that a good faith effort was made shall approve the Utilization Plan submitted by the bidder and shall clear the contract for award. A final decision that a good faith effort was not made shall render the bid not responsive.

**CONTRACT COMPLIANCE.** Compliance with this Special Provision is an essential part of the contract. The Department is prohibited by federal regulations from crediting the participation of a DBE included in the Utilization Plan toward either the contract goal or the Department's overall goal until the amount to be applied toward the goals has been paid to the DBE. The following administrative procedures and remedies govern the compliance by the Contractor with the contractual obligations established by the Utilization Plan. After approval of the Plan and award of the contract, the Utilization Plan and individual DBE Participation Statements become part of the contract. If the Contractor did not succeed in obtaining enough DBE participation to achieve the advertised contract goal, and the Utilization Plan was approved and contract awarded based upon a determination of good faith, the total dollar value of DBE work calculated in the approved Utilization Plan as a percentage of the awarded contract value shall become the amended contract goal.

- (a) No amendment to the Utilization Plan may be made without prior written approval from the Department's Bureau of Small Business Enterprises. All requests for amendment to the Utilization Plan shall be submitted to the Department of Transportation, Bureau of Small Business Enterprises, Contract Compliance Section, 2300 South Dirksen Parkway, Room 319, Springfield, Illinois 62764. Telephone number (217) 785-4611. Telefax number (217) 785-1524.
- (b) All work indicated for performance by an approved DBE shall be performed, managed, and supervised by the DBE executing the Participation Statement. The Contractor shall not terminate for convenience a DBE listed in the Utilization Plan and then perform the work of the terminated DBE with its own forces, those of an affiliate or those of another subcontractor, whether DBE or not, without first obtaining the written consent of the Bureau of Small Business Enterprises to amend the Utilization Plan. If a DBE listed in the Utilization Plan is terminated for reasons other than convenience, or fails to complete its work on the contract for any reason, the Contractor shall make good faith efforts to find another DBE to substitute for the terminated DBE. The good faith efforts shall be directed at finding another DBE to perform at least the same amount of work under the contract as the DBE that was terminated, but only to the extent needed to meet the contract goal or the amended contract goal. The Contractor shall notify the Bureau of Small Business Enterprises of any termination for reasons other than convenience, and

shall obtain approval for inclusion of the substitute DBE in the Utilization Plan. If good faith efforts following a termination of a DBE for cause are not successful, the Contractor shall contact the Bureau of Small Business Enterprises and provide a full accounting of the efforts undertaken to obtain substitute DBE participation. The Bureau of Small Business Enterprises will evaluate the good faith efforts in light of all circumstances surrounding the performance status of the contract, and determine whether the contract goal should be amended.

- (c) The Contractor shall maintain a record of payments for work performed to the DBE participants. The records shall be made available to the Department for inspection upon request. After the performance of the final item of work or delivery of material by a DBE and final payment therefore to the DBE by the Contractor, but not later than thirty calendar days after payment has been made by the Department to the Contractor for such work or material, the Contractor shall submit a DBE Payment Agreement on Department form SBE 2115 to the Regional Engineer. If full and final payment has not been made to the DBE, the DBE Payment Agreement shall indicate whether a disagreement as to the payment required exists between the Contractor and the DBE or if the Contractor believes that the work has not been satisfactorily completed. If the Contractor does not have the full amount of work indicated in the Utilization Plan performed by the DBE companies indicated in the Plan, the Department will deduct from contract payments to the Contractor the amount of the goal not achieved as liquidated and ascertained damages.
- (d) The Department reserves the right to withhold payment to the Contractor to enforce the provisions of this Special Provision. Final payment shall not be made on the contract until such time as the Contractor submits sufficient documentation demonstrating achievement of the goal in accordance with this Special Provision or after liquidated damages have been determined and collected.
- (e) Notwithstanding any other provision of the contract, including but not limited to Article 109.09 of the Standard Specifications, the Contractor may request administrative reconsideration of a decision to deduct the amount of the goal not achieved as liquidated damages. A request to reconsider shall be delivered to the Contract Compliance Section and shall be handled and considered in the same manner as set forth in paragraph (c) of "Good Faith Effort Procedures" of this Special Provision, except a final decision that a good faith effort was not made during contract performance to achieve the goal agreed to in the Utilization Plan shall be the final administrative decision of the Department.

#### **EQUIPMENT RENTAL RATES (BDE)**

Effective: August 2, 2007

Revised: January 2, 2008

Replace the second and third paragraphs of Article 105.07(b)(4)a. of the Standard Specifications with the following:

"Equipment idled which cannot be used on other work, and which is authorized to standby on the project site by the Engineer, will be paid for according to Article 109.04(b)(4)."

Replace Article 109.04(b)(4) of the Standard Specifications with the following:

“(4) Equipment. Equipment used for extra work shall be authorized by the Engineer. The equipment shall be specifically described, be of suitable size and capacity for the work to be performed, and be in good operating condition. For such equipment, the Contractor will be paid as follows.

- a. Contractor Owned Equipment. Contractor owned equipment will be paid for by the hour using the applicable FHWA hourly rate from the “Equipment Watch Rental Rate Blue Book” (Blue Book) in effect when the force account work begins. The FHWA hourly rate is calculated as follows.

$$\text{FHWA hourly rate} = (\text{monthly rate}/176) \times (\text{model year adj.}) \times (\text{Illinois adj.}) + \text{EOC}$$

Where: EOC = Estimated Operating Costs per hour (from the Blue Book)

The time allowed will be the actual time the equipment is operating on the extra work. For the time required to move the equipment to and from the site of the extra work and any authorized idle (standby) time, payment will be made at the following hourly rate:  $0.5 \times (\text{FHWA hourly rate} - \text{EOC})$ .

All time allowed shall fall within the working hours authorized for the extra work.

The rates above include the cost of fuel, oil, lubrication, supplies, small tools, necessary attachments, repairs, overhaul and maintenance of any kind, depreciation, storage, overhead, profits, insurance, and all incidentals. The rates do not include labor.

The Contractor shall submit to the Engineer sufficient information for each piece of equipment and its attachments to enable the Engineer to determine the proper equipment category. If a rate is not established in the Blue Book for a particular piece of equipment, the Engineer will establish a rate for that piece of equipment that is consistent with its cost and use in the industry.

- b. Rented Equipment. Whenever it is necessary for the Contractor to rent equipment to perform extra work, the rental and transportation costs of the equipment plus five percent for overhead will be paid. In no case shall the rental rates exceed those of established distributors or equipment rental agencies.

All prices shall be agreed to in writing before the equipment is used.”

#### **FLAGGER AT SIDE ROADS AND ENTRANCES (BDE)**

Effective: April 1, 2009

Revise the second paragraph of Article 701.13(a) of the Standard Specifications to read:

“The Engineer will determine when a side road or entrance shall be closed to traffic. A flagger will be required at each side road or entrance remaining open to traffic within the



operation where two-way traffic is maintained on one lane of pavement. The flagger shall be positioned as shown on the plans or as directed by the Engineer.”

Revise the first and second paragraph of Article 701.20(i) of the Standard Specifications to read:

“Signs, barricades, or other traffic control devices required by the Engineer over and above those specified will be paid for according to Article 109.04. All flaggers required at side roads and entrances remaining open to traffic including those that are shown on the Highway Standards and/or additional barricades required by the Engineer to close side roads and entrances will be paid for according to Article 109.04.”

**LIQUIDATED DAMAGES (BDE)**

Effective: April 1, 2009

Revise the table in Article 108.09 of the Standard Specifications to read:

“Schedule of Deductions for Each Day of Overrun in Contract Time			
Original Contract Amount		Daily Charges	
From More Than	To and Including	Calendar Day	Work Day
\$ 0	\$ 100,000	\$ 375	\$ 500
100,000	500,000	625	875
500,000	1,000,000	1,025	1,425
1,000,000	3,000,000	1,125	1,550
3,000,000	5,000,000	1,425	1,950
5,000,000	10,000,000	1,700	2,350
10,000,000	And over	3,325	4,650”

**NATIONAL POLLUTANT DISCHARGE ELIMINATION SYSTEM / EROSION AND SEDIMENT CONTROL DEFICIENCY DEDUCTION (BDE)**

Effective: April 1, 2007

Revised: November 1, 2008

Revise Article 105.03(a) of the Standard Specifications to read:

“(a) National Pollutant Discharge Elimination System (NPDES) / Erosion and Sediment Control Deficiency Deduction. When the Engineer is notified or determines an erosion and/or sediment control deficiency(s) exists, or the Contractor’s activities represents a violation of the Department’s NPDES permits, the Engineer will notify and direct the Contractor to correct the deficiency within a specified time. The specified time, which begins upon notification to the Contractor, will be from 1/2 hour to 1 week based on the urgency of the situation and the nature of the work effort required. The Engineer will be the sole judge.

A deficiency may be any lack of repair, maintenance, or implementation of erosion and/or sediment control devices included in the contract, or any failure to comply with the conditions of the Department's NPDES permits. A deficiency may also be applied to situations where corrective action is not an option such as the failure to participate in a jobsite inspection of the project, failure to install required measures prior to initiating earth moving operations, disregard of concrete washout requirements, or other disregard of the NPDES permit.

If the Contractor fails to correct a deficiency within the specified time, a daily monetary deduction will be imposed for each calendar day or fraction thereof the deficiency exists. The calendar day(s) will begin with notification to the Contractor and end with the Engineer's acceptance of the correction. The daily monetary deduction will be either \$1000.00 or 0.05 percent of the awarded contract value, whichever is greater. For those deficiencies where corrective action was not an option, the monetary deduction will be immediate and will be valued at one calendar day."

### **PAYMENTS TO SUBCONTRACTORS (BDE)**

Effective: June 1, 2000

Revised: January 1, 2006

Federal regulations found at 49 CFR §26.29 mandate the Department to establish a contract clause to require Contractors to pay subcontractors for satisfactory performance of their subcontracts and to set the time for such payments.

State law also addresses the timing of payments to be made to subcontractors and material suppliers. Section 7 of the Prompt Payment Act, 30 ILCS 540/7, requires that when a Contractor receives any payment from the Department, the Contractor shall make corresponding, proportional payments to each subcontractor and material supplier performing work or supplying material within 15 calendar days after receipt of the Department payment. Section 7 of the Act further provides that interest in the amount of two percent per month, in addition to the payment due, shall be paid to any subcontractor or material supplier by the Contractor if the payment required by the Act is withheld or delayed without reasonable cause. The Act also provides that the time for payment required and the calculation of any interest due applies to transactions between subcontractors and lower-tier subcontractors and material suppliers throughout the contracting chain.

This Special Provision establishes the required federal contract clause, and adopts the 15 calendar day requirement of the State Prompt Payment Act for purposes of compliance with the federal regulation regarding payments to subcontractors. This contract is subject to the following payment obligations.

When progress payments are made to the Contractor according to Article 109.07 of the Standard Specifications, the Contractor shall make a corresponding payment to each subcontractor and material supplier in proportion to the work satisfactorily completed by each subcontractor and for the material supplied to perform any work of the contract. The proportionate amount of partial payment due to each subcontractor and material supplier throughout the contracting chain shall be determined by the quantities measured or otherwise determined as eligible for payment by the Department and included in the progress payment to

the Contractor. Subcontractors and material suppliers shall be paid by the Contractor within 15 calendar days after the receipt of payment from the Department. The Contractor shall not hold retainage from the subcontractors. These obligations shall also apply to any payments made by subcontractors and material suppliers to their subcontractors and material suppliers; and to all payments made to lower tier subcontractors and material suppliers throughout the contracting chain. Any payment or portion of a payment subject to this provision may only be withheld from the subcontractor or material supplier to whom it is due for reasonable cause.

This Special Provision does not create any rights in favor of any subcontractor or material supplier against the State or authorize any cause of action against the State on account of any payment, nonpayment, delayed payment, or interest claimed by application of the State Prompt Payment Act. The Department will not approve any delay or postponement of the 15 day requirement except for reasonable cause shown after notice and hearing pursuant to Section 7(b) of the State Prompt Payment Act. State law creates other and additional remedies available to any subcontractor or material supplier, regardless of tier, who has not been paid for work properly performed or material furnished. These remedies are a lien against public funds set forth in Section 23(c) of the Mechanics Lien Act, 770 ILCS 60/23(c), and a recovery on the Contractor's payment bond according to the Public Construction Bond Act, 30 ILCS 550.

#### **PAYROLLS AND PAYROLL RECORDS (BDE)**

Effective: March 1, 2009

FEDERAL AID CONTRACTS. Revise the following section of Check Sheet #1 of the Recurring Special Provisions to read:

##### **"STATEMENTS AND PAYROLLS**

The payroll records shall include each worker's name, address, telephone number, social security number, classification, rate of pay, number of hours worked each day, starting and ending times of work each day, total hours worked each week, itemized deductions made, and actual wages paid.

The Contractor and each subcontractor shall submit payroll records to the Engineer each week from the start to the completion of their respective work, except that full social security numbers and home addresses shall not be included on weekly transmittals. Instead the payrolls shall include an identification number for each employee (e.g., the last four digits of the employee's social security number.). The submittals shall be on the Department's form SBE 48, or an approved facsimile. When there has been no activity during a work week, a payroll record shall still be submitted with the appropriate box ("No Work", "Suspended", or "Complete") checked on the form."

STATE CONTRACTS. Revise Section IV of Check Sheet #5 of the Recurring Special Provisions to read:

##### **"IV.COMPLIANCE WITH THE PREVAILING WAGE ACT**

1. **Prevailing Wages.** All wages paid by the Contractor and each subcontractor shall be in compliance with The Prevailing Wage Act (820 ILCS 130), as amended, except where a prevailing wage violates a federal law, order, or ruling, the rate conforming to the federal law, order, or ruling shall govern. The Contractor shall be responsible to notify each subcontractor of the wage rates set forth in this contract and any revisions thereto. If the Department of Labor revises the wage rates, the Contractor will not be allowed additional compensation on account of said revisions.
2. **Payroll Records.** The Contractor and each subcontractor shall make and keep, for a period of three years from the date of completion of this contract, records of the wages paid to his/her workers. The payroll records shall include each worker's name, address, telephone number, social security number, classification, rate of pay, number of hours worked each day, starting and ending times of work each day, total hours worked each week, itemized deductions made, and actual wages paid. Upon two business days' notice, these records shall be available, at all reasonable hours at a location within the State, for inspection by the Department or the Department of Labor.
3. **Submission of Payroll Records.** The Contractor and each subcontractor shall submit payroll records to the Engineer each week from the start to the completion of their respective work, except that full social security numbers and home addresses shall not be included on weekly transmittals. Instead the payrolls shall include an identification number for each employee (e.g., the last four digits of the employee's social security number). The submittals shall be on the Department's form SBE 48, or an approved facsimile. When there has been no activity during a work week, a payroll record shall still be submitted with the appropriate box ("No Work", "Suspended", or "Complete") checked on the form.

Each submittal shall be accompanied by a statement signed by the Contractor or subcontractor which avers that: (i) such records are true and accurate; (ii) the hourly rate paid to each worker is not less than the general prevailing rate of hourly wages required by the Act; and (iii) the Contractor or subcontractor is aware that filing a payroll record that he/she knows to be false is a Class B misdemeanor.

4. **Employee Interviews.** The Contractor and each subcontractor shall permit his/her employees to be interviewed on the job, during working hours, by compliance investigators of the Department or the Department of Labor."

#### **PERSONAL PROTECTIVE EQUIPMENT (BDE)**

Effective: November 1, 2008

Revise the first sentence of Article 701.12 of the Standard Specifications to read:

"All personnel on foot, excluding flaggers, within the highway right-of-way shall wear a fluorescent orange, fluorescent yellow/green, or a combination of fluorescent orange and fluorescent yellow/green vest meeting the requirements of ANSI/ISEA 107-2004 for Conspicuity Class 2 garments."

**REFLECTIVE SHEETING ON CHANNELIZING DEVICES (BDE)**

Effective: April 1, 2007

Revised: November 1, 2008

Revise the seventh paragraph of Article 1106.02 of the Standard Specifications to read:

“At the time of manufacturing, the retroreflective prismatic sheeting used on channelizing devices shall meet or exceed the initial minimum coefficient of retroreflection as specified in the following table. Measurements shall be conducted according to ASTM E 810, without averaging. Sheeting used on cones, drums and flexible delineators shall be reboundable as tested according to ASTM D 4956. Prestriped sheeting for rigid substrates on barricades shall be white and orange. **The sheeting shall be uniform in color and devoid of streaks throughout the length of each roll. The color shall conform to the latest appropriate standard color tolerance chart issued by the U.S. Department of Transportation, Federal Highway Administration, and to the daytime and nighttime color requirements of ASTM D 4956.**

Initial Minimum Coefficient of Retroreflection candelas/foot candle/sq ft (candelas/lux/sq m) of material				
Observation Angle (deg.)	Entrance Angle (deg.)	White	Orange	Fluorescent Orange
0.2	-4	365	160	150
0.2	+30	175	80	70
0.5	-4	245	100	95
0.5	+30	100	50	40”

Revise the first sentence of the first paragraph of Article 1106.02(c) of the Standard Specifications to read:

“Barricades and vertical panels shall have alternating white and orange stripes sloping downward at 45 degrees toward the side on which traffic will pass.”

Revise the third sentence of the first paragraph of Article 1106.02(d) of the Standard Specifications to read:

“The bottom panels shall be 8 x 24 in. (200 x 600 mm) with alternating white and orange stripes sloping downward at 45 degrees toward the side on which traffic will pass.”

**SUBCONTRACTOR MOBILIZATION PAYMENTS (BDE)**

Effective: April 2, 2005

To account for the preparatory work and operations necessary for the movement of subcontractor personnel, equipment, supplies, and incidentals to the project site and for all other work or operations that must be performed or costs incurred when beginning work approved for subcontracting in accordance with Article 108.01 of the Standard Specifications, the Contractor shall make a mobilization payment to each subcontractor.

This mobilization payment shall be made at least 14 days prior to the subcontractor starting work. The amount paid shall be equal to 3 percent of the amount of the subcontract reported on form BC 260A submitted for the approval of the subcontractor's work.

This provision shall be incorporated directly or by reference into each subcontract approved by the Department.

**WORKING DAYS (BDE)**

Effective: January 1, 2002

The Contractor shall complete the work within **15** working days.

# STATE OF ILLINOIS

DEPARTMENT OF TRANSPORTATION

PLANS FOR PROPOSED  
VARIOUS ROUTES  
DIST. 8 SEAL COAT 2010-2  
VARIOUS COUNTIES  
SEAL COAT

C-98-022-09

FOR INDEX OF SHEETS SEE SHEET NO. 2

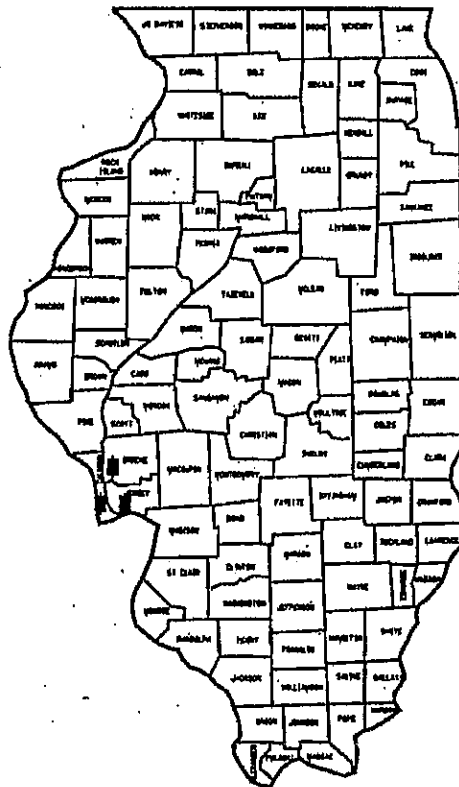

LOCATION OF SECTION INDICATED THUS 

D-98-027-09

FOR LOCATION MAPS  
SEE SHEETS NO. 5 - 14

LOCATIONS 1 THROUGH 6

LOCATIONS 9 & 10

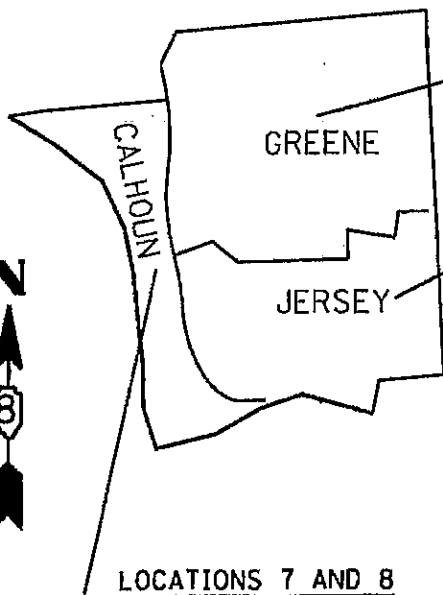

LOCATIONS 7 AND 8

JOINT UTILITY LOCATION  
INFORMATION FOR EXCAVATIONS  
PHONE: (800) 892-0123

SUBMITTED March 30, 2009

Mary C. Jarure  
DEPUTY DIRECTOR OF HIGHWAYS  
REGION FIVE ENGINEER

PASSED \_\_\_\_\_

ENGINEER OF DESIGN & ENVIRONMENT

APPROVED \_\_\_\_\_

DIRECTOR, DIVISION OF HIGHWAYS

## LOCATION MAP

CONTRACT NO. 76C82

PRINTED BY THE AUTHORITY OF THE STATE OF ILLINOIS

PL07 DATE: 1/29/2009 \*TIME\*

PROJECT ENGINEER: PATTI LOBEAU 618 346-3179  
SQUAD LEADER: CHERYL KEPLAR 618 346-3186

GENERAL NOTES

TOTAL SHEETS	SHEET NO.
14	2
CONTRACT NO.: 76C82	

1. THE RATES OF APPLICATION SHOWN IN THE PLANS ARE NOMINAL RATES. DEVIATION WILL BE ALLOWED AS SPECIFIED BY THE ENGINEER IN ACCORDANCE WITH STANDARD SPECIFICATIONS.
2. THE STANDARDS AND REVISION NUMBERS LISTED SHALL APPLY TO THIS PROJECT.
3. FLAGMEN SHALL BE PRESENT DURING ALL CLOSURE HOURS INCLUDING LUNCH HOUR AND NO ADDITIONAL COMPENSATION SHALL BE PERMITTED.
4. "ROAD CONSTRUCTION AHEAD" SIGNS SHALL BE PLACED AT EACH END OF THE PROJECT PLUS THE INTERSECTING SIDEROADS, AND WILL BE INCLUDED IN THE TRAFFIC CONTROL PAY ITEMS. ALL CONSTRUCTION SIGNS SHALL BE FLUORESCENT ORANGE, 48" x 48".
5. THE ROADWAY IS TO REMAIN OPEN TO TRAFFIC DURING CONSTRUCTION OPERATIONS. NO OVERNIGHT LANE CLOSURES WILL BE ALLOWED. THE 24 HOUR CURE FOR THE PRIME COAT (ART. 403.09) WILL NOT BE REQUIRED. THE RESIDENT ENGINEER WILL APPROVE THE CURE PERIOD FOR THE PRIME COAT.
6. THE IDOT MAINTENANCE YARDS SHALL BE COMPLETED TO THE SATISFACTION OF THE MAINTENANCE FIELD TECHNICIAN. WORK SHALL BE CONDUCTED BETWEEN 7:00 AM AND 3:30 PM. YARD TECHNICIANS SHALL BE NOTIFIED 3 DAYS PRIOR TO THE START OF WORK AT THE MAINTENANCE YARD.
7. UTILITY CONFLICTS ARE NOT ANTICIPATED ON THIS CONTRACT. SHOULD THIS PROVE TO BE OTHERWISE DURING THIS CONTRACT, THE ENGINEER IS TO BE NOTIFIED AT THE TIME OF THE OCCURANCE. NO ADDITIONAL COST WILL BE ADDED TO THE CONTRACT. THE JOINT UTILITY LOCATING INFORMATION FOR EXCAVATORS (J.U.L.I.E.) SYSTEM NUMBER IS (800)892-0123.
8. IF ANY SECTION OR SUB-SECTION MONUMENTS ARE ENCOUNTERED, THE ENGINEER SHALL BE NOTIFIED BEFORE SUCH MONUMENTS ARE REMOVED OR RESURFACED OVER. THE CONTRACTOR SHALL PROTECT AND CAREFULLY PRESERVE ALL PROPERTY MARKERS AND MONUMENTS UNTIL THE OWNER, AN AUTHORIZED SURVEYOR, OR AGENT HAS WITNESSED OR OTHERWISE REFERENCED THEIR LOCATION.
9. THE CONTRACTOR SHALL VERIFY ALL DIMENSIONS AND CONDITIONS IN THE FIELD PRIOR TO CONSTRUCTION AND ORDERING OF MATERIALS.
10. THE RESIDENT ENGINEER SHALL VERIFY THE EXISTENCE OF HIGHWAY LIGHTING AND/OR ITS UTILITIES WITHIN THE PROJECT LIMITS. IF HIGHWAY LIGHTING AND/OR ITS EXISTS WITHIN THE PROJECT LIMITS, AND IF THESE ITEMS REQUIRE LOCATING, THE CONTRACTOR SHALL BE DIRECTED TO DO SO ACCORDING TO SECTION 803 OF THE STANDARD SPECIFICATIONS. IF "LOCATING UNDERGROUND CABLE" IS NOT INCLUDED AS PART OF THE PLANS, THIS WORK SHALL BE PAID FOR ACCORDING TO ARTICLE 109.04 OF THE STANDARD SPECIFICATIONS.
11. ALL EXISTING AND PROPOSED RIGHT-OF-WAY LINES AND PROPERTY LINES SHOWN ON THE PLAN SHEETS ARE GRAPHICAL REPRESENTATIONS AND SHALL NOT BE USED AS A MEANS TO ESTABLISH OWNERSHIP. IN ALL MATTERS RELATING TO RIGHT-OF-WAY, THE PLAT OF HIGHWAYS SHALL BE CONTROLLING DOCUMENT.

INDEX OF SHEETS  
GENERAL NOTES  
& STANDARDS

VARIOUS ROUTES  
DIST. 8 SEAL COAT 2010-2  
VARIOUS COUNTIES.

PLOT DATE: DATE-TIME: \$TIME\$



TOTAL SHEETS	SHEET NO.
14	2A
CONTRACT NO.: 76CB2	

COMMITMENTS FOR THIS PROJECT ARE AS FOLLOWS: NONE

INDEX OF SHEETS

- 1 COVER SHEET
- 2 GENERAL NOTES, COMMITMENTS, INDEX OF SHEETS & HIGHWAY STANDARDS
- 3 SUMMARY OF QUANTITIES
- 4 SCHEDULES
- 5-14 LOCATION DETAILS

HIGHWAY STANDARDS

701001-02  
701006-03  
701011-02  
701306-02  
701901-01

INDEX OF SHEETS  
GENERAL NOTES  
& STANDARDS

VARIOUS ROUTES  
DIST. 8 SEAL COAT 2010-2  
VARIOUS COUNTIES

PLOT DATE: \*DATE-TIME\* \*TIME\*

\*\*DATE\*\*  
 \*\*DATE-TIME\*\*  
 \*\*CON-SPEC\*\*

# SUMMARY OF QUANTITIES

VAR 10015

CODE NO	ITEM	UNIT	CONSTRUCTION TYPE CODE - 1000					TOTAL QUANTITIES
			GREENE (RURAL)	GREENE (URBAN)	JERSEY (RURAL)	JERSEY (URBAN)	CALHOUN (URBAN)	
40300200	BITUMINOUS MATERIALS (PRIME COAT)	TON			0.4			0.6
40300400	BITUMINOUS MATERIALS (COVER AND SEAL COATS)	TON	41.1	20.8	0.9	15.7		82.8
40300500	COVER COAT AGGREGATE	TON	61.1		2.6			64.7
40300600	SEAL COAT AGGREGATE	TON	202.3	133.1	2.6	100.6		465.1
67100100	MOBILIZATION	L SUM	0.2	0.2	0.2	0.2		1
70100460	TRAFFIC CONTROL AND PROTECTION, STANDARD 701306	L SUM	0.5		0.5			1

TOTAL SHEETS	SHEET NO.
14	3
CONTRACT NO.: 76082	

## SUMMARY OF QUANTITIES

VARIOUS ROUTES  
 DIST. 8 SEAL COAT 2010-2  
 VARIOUS COUNTIES

PLOT DATE: DATE-TIME

DATE: 1/24/2009  
 17:24:28  
 C:\Users\mcc\Documents\1762-82-ahs\plowdfr

**SURFACE TREATMENT SCHEDULE**

LOCATION	NOMINAL		AREA	BITUMINOUS MATERIALS			AGGREGATE	
	LENGTH	WIDTH		PRIME COAT	(CVR & SEAL COAT)	CVR COAT	SEAL COAT	
LOC #	MILE	FEET	SQ.YD	TON	TON	TON	TON	
DISCRPTION								
GREENE COUNTY								
1	0.22	18	2390		3.7		23.9	
2	0.82	21	10102.4		15.8		101.0	
3	0.05	12	382		0.6		3.5	
4	0.27	18.5	2990.4		4.6		29.3	
5	0.43	22	5549.9		17.3	55.5	55.5 ***	
6			9186.9		14.3		91.7	
MISCELLANEOUS 10%					5.6	5.6	30.5	
GREENE COUNTY TOTALS					61.9	61.1	335.4	

**CALHOUN COUNTY**

7			2018		3.2		20.2
8			382	0.2	0.7	0.9	3.9 **
MISCELLANEOUS 10%					0.4	0.1	2.4
CALHOUN COUNTY TOTALS				0.2	4.3	1.0	26.5

**JERSEY COUNTY**

9			235.6	0.4	0.8	2.4	2.4 *
10			9135.5		14.3		91.4
MISCELLANEOUS 10%					1.5	0.2	9.4
JERSEY COUNTY TOTALS				0.4	16.6	2.6	103.2
TOTAL QUANTITIES				0.6	82.8	64.7	465.1

• THIS AREA IS GETTING AN A-2 TREATMENT  
 \*\* 89 SQ. YD. OF THIS AREA IS GETTING AN A-2 TREATMENT  
 \*\*\* THIS AREA IS GETTING AN A-2 TREATMENT BUT DOES NOT REQUIRE THE BITUMINOUS MATERIAL (PRIME COAT)  
 RATES OF APPLICATION  
 BITUMINOUS MATERIAL (PRIME COAT) = 0.375 GAL/SO YD  
 BITUMINOUS MATERIAL (COVER & SEAL COAT) = 0.375 GAL/SO YD  
 COVER COAT ACCRETE = 20 LB/SO YD  
 SEAL COAT AGGREGATE = 20 LB/SO YD

TOTAL SHEETS	SHEET NO.
14	4

CONTRACT NO. 176CB2

**SURFACE TREATMENT SCHEDULE**  
 VARIOUS ROUTES  
 DIST. 8 SEAL COAT 2010-2  
 VARIOUS COUNTIES

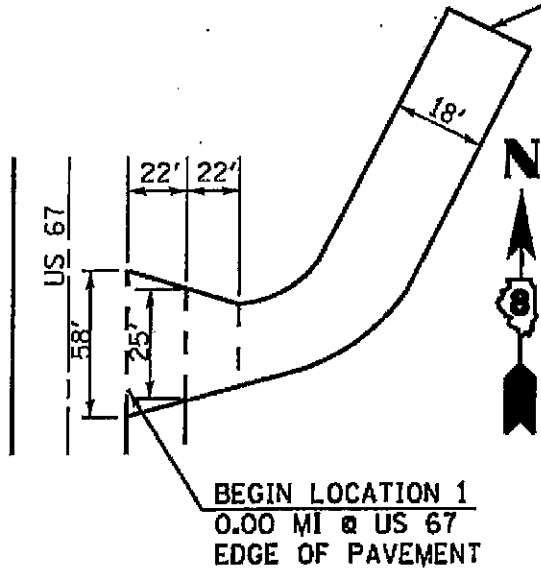
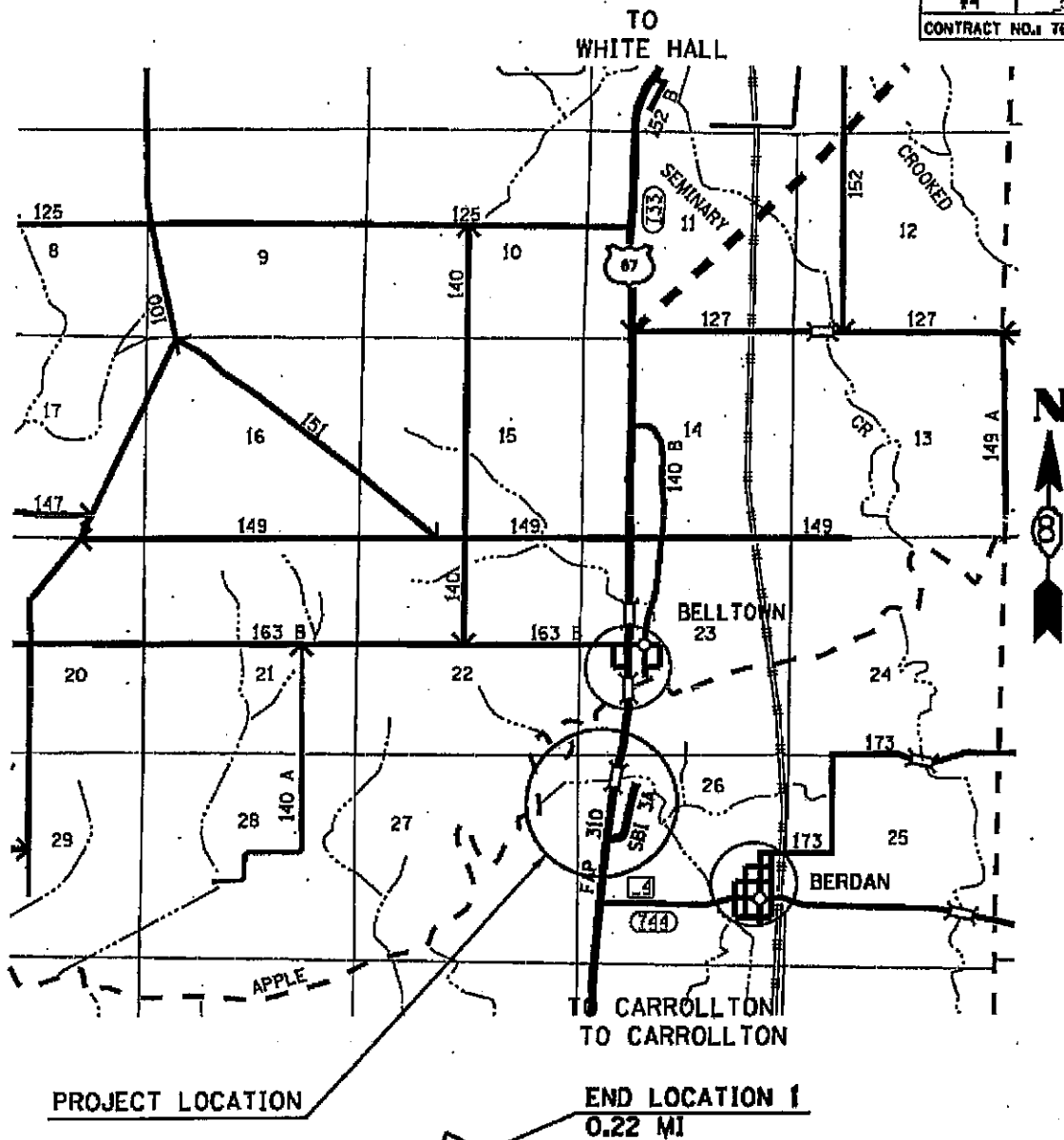

**LOCATION 1 DETAILS**

VARIOUS ROUTES  
DIST. 8 SEAL COAT 2010-2  
VARIOUS COUNTIES

PLOT DATE: 1/29/2009

94047555  
 1/29/2009  
 c:\pwork\acsk\p\1001\PHILLIPSS\10019406\4876-682-ak1\p1sev.dgn

TOTAL SHEETS	SHEET NO.
14	6
CONTRACT NO. 76C82	

**PROJECT LOCATION**

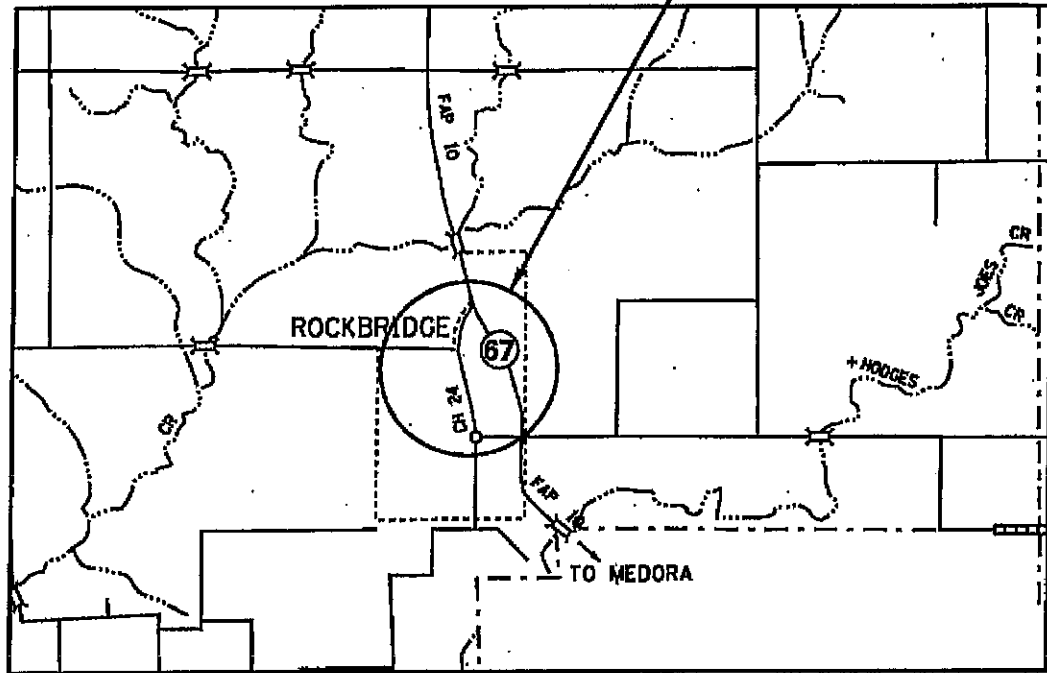

BEGIN LOCATION 2  
0.00 MI. @ EDGE OF  
WEDGE FROM US 267

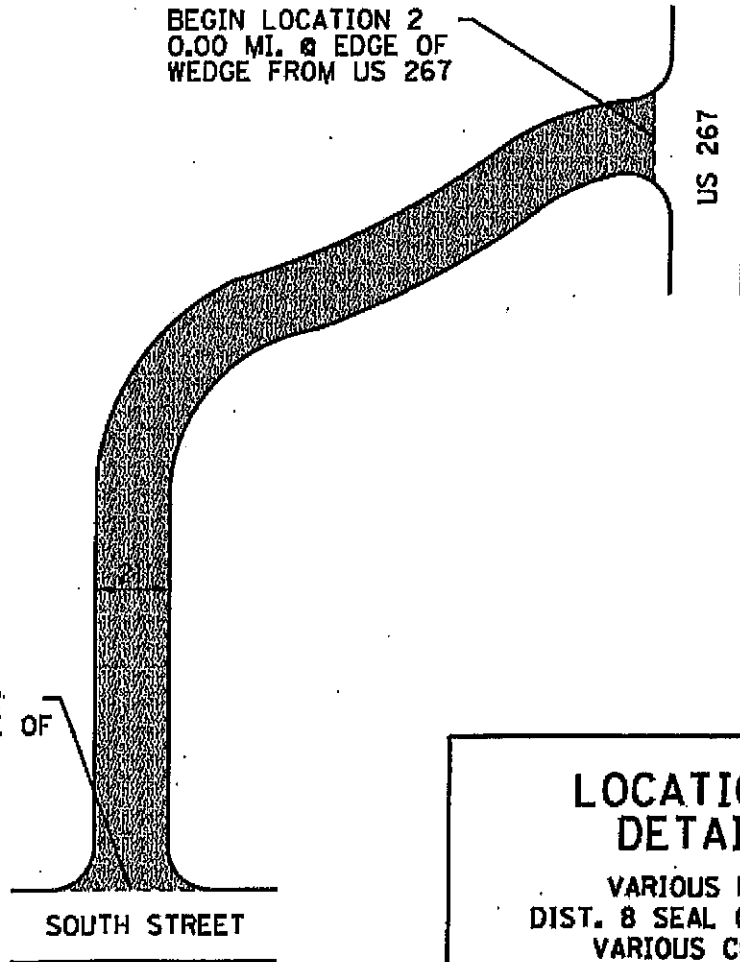

END LOCATION 2  
0.82 MI. @ EDGE OF  
SOUTH STREET

**SOUTH STREET**

**LOCATION 2  
DETAILS**

VARIOUS ROUTES  
DIST. 8 SEAL COAT 2010-2  
VARIOUS COUNTIES

TOTAL SHEETS	SHEET NO.
14	7
CONTRACT NO. 76C02	

**PROJECT LOCATION**

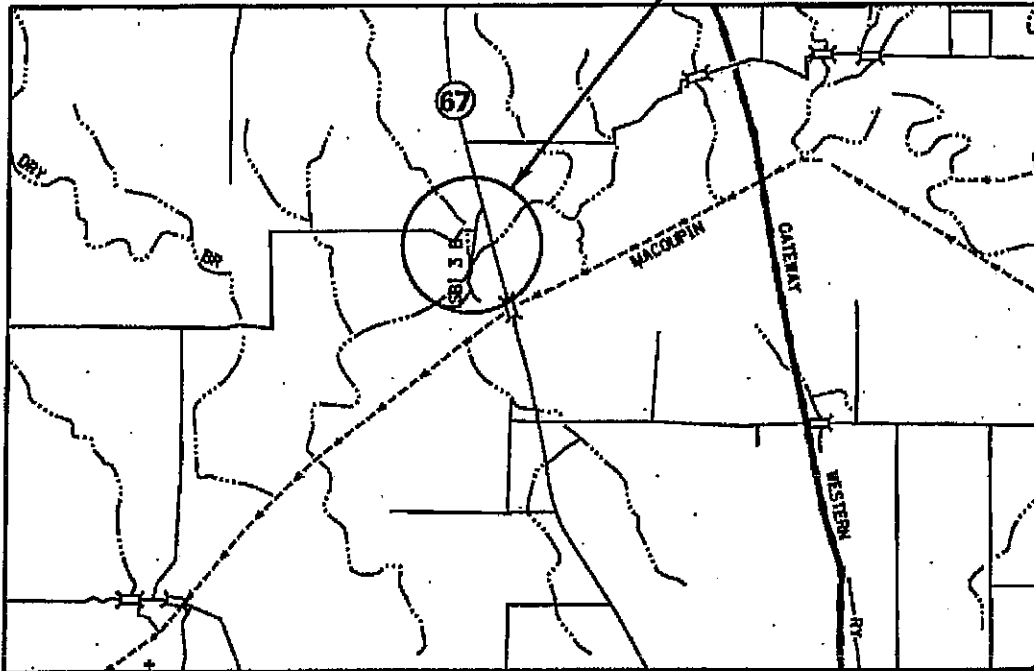

END LOCATION 3  
0.05 MI.

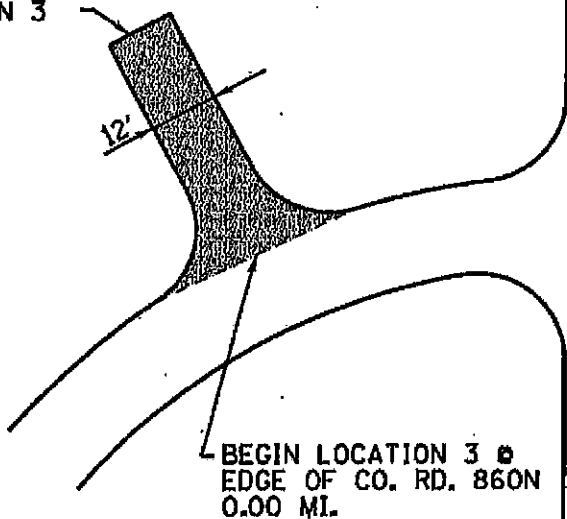

**LOCATION 3  
DETAILS**

VARIOUS ROUTES  
DIST. 8 SEAL COAT 2010-2  
VARIOUS COUNTIES

1/25/2009  
8:11:58 AM  
C:\pwork\p\DOT\PHILLIPSS\6811945B\6876c02-ah\p\end.dgn

TOTAL SHEETS	SHEET NO.
14	8
CONTRACT NO.: 76C82	

PROJECT LOCATION

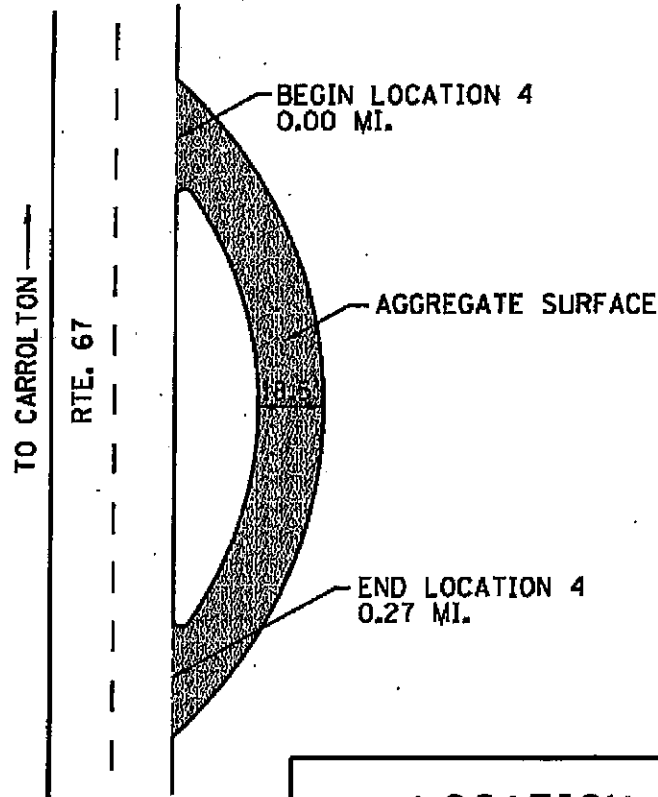
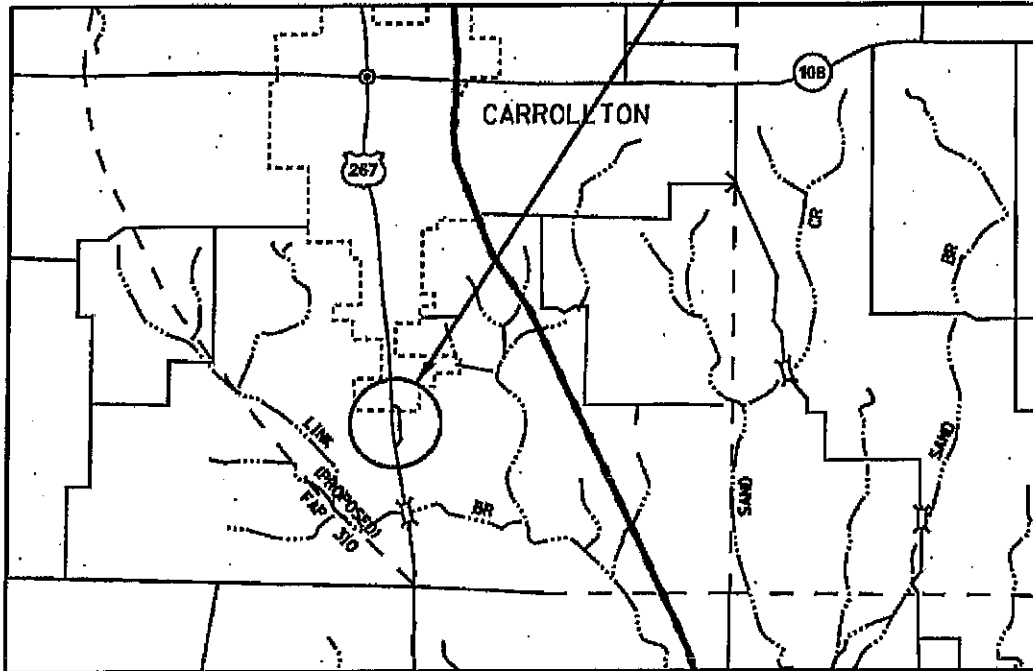

**LOCATION 4  
DETAILS**

VARIOUS ROUTES  
DIST. 8 SEAL COAT 2010-2  
VARIOUS COUNTIES

PLOT DATE: 1/29/2009 \*TIME\*

TOTAL SHEETS	SHEET NO.
14	9
CONTRACT NO. 76C82	

PROJECT LOCATION

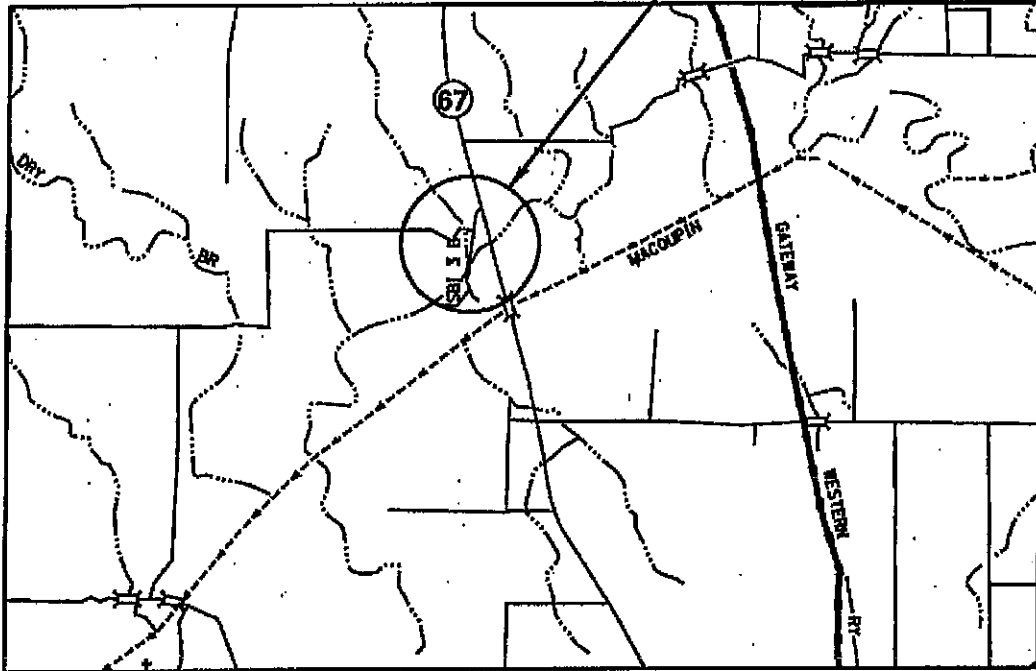

BEGIN 0.00 MI.



END 0.43 MI.

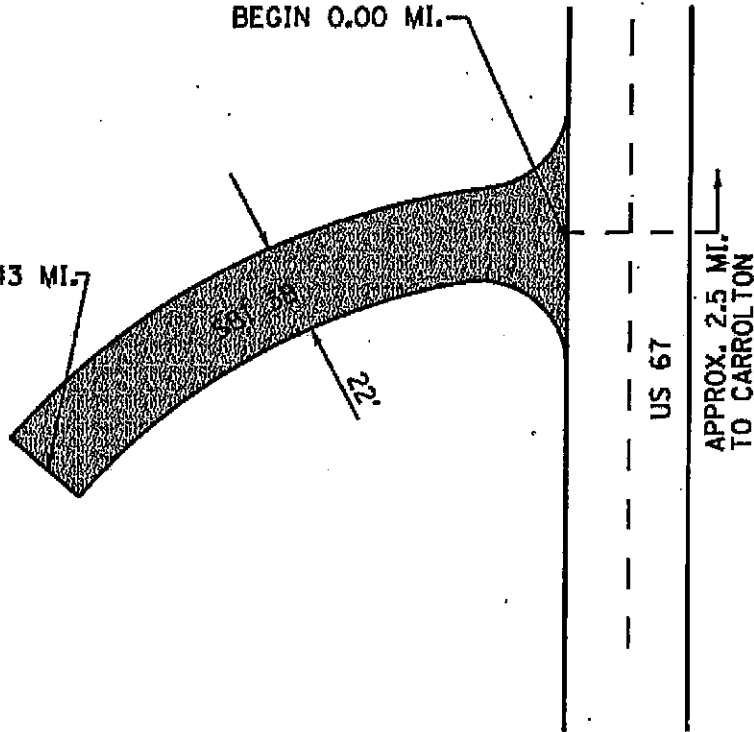

LOCATION 5  
DETAILS

VARIOUS ROUTES  
DIST. 8 SEAL COAT 2010-2  
VARIOUS COUNTIES

PLOT DATE: 1/29/2009

#DATE##  
1/29/2009  
c:\pwr\_swr\A\PM1001\PHILLIPSS\del19456\del76c82-ant-plon.dgn

1/29/2009  
8:10:55  
c:\pwr\_swr\A\PM1001\PHILLIPSS\del19456\del76c82-ant-plon.dgn



TOTAL SHEETS	SHEET NO.
14	10
CONTRACT NO.: 76C82	

**PROJECT LOCATION**

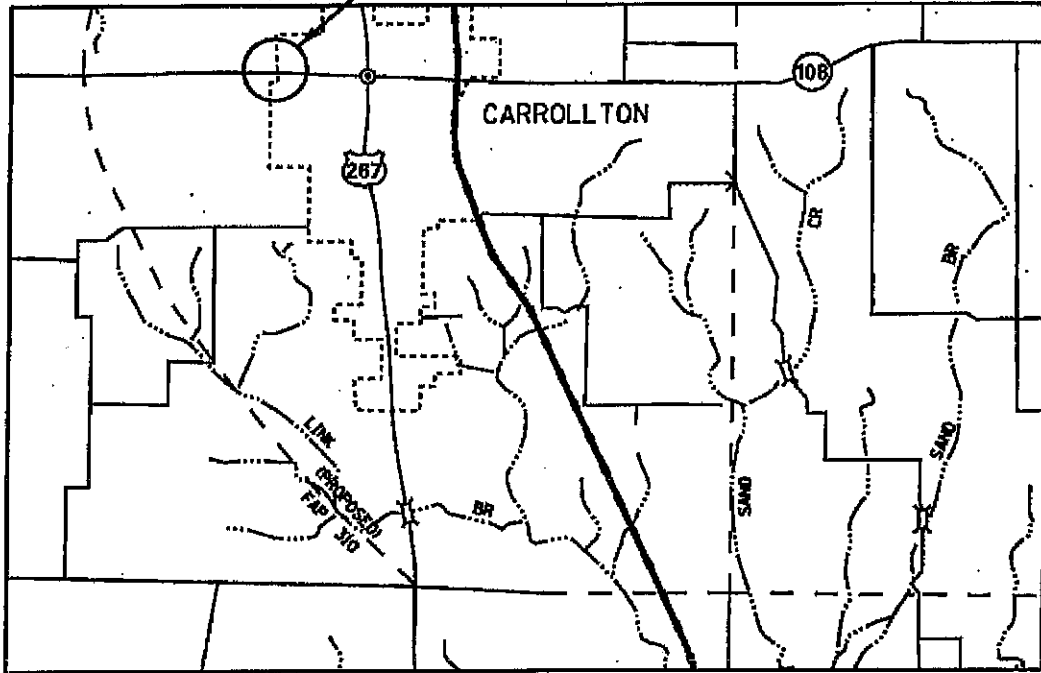

**RTE. 108**

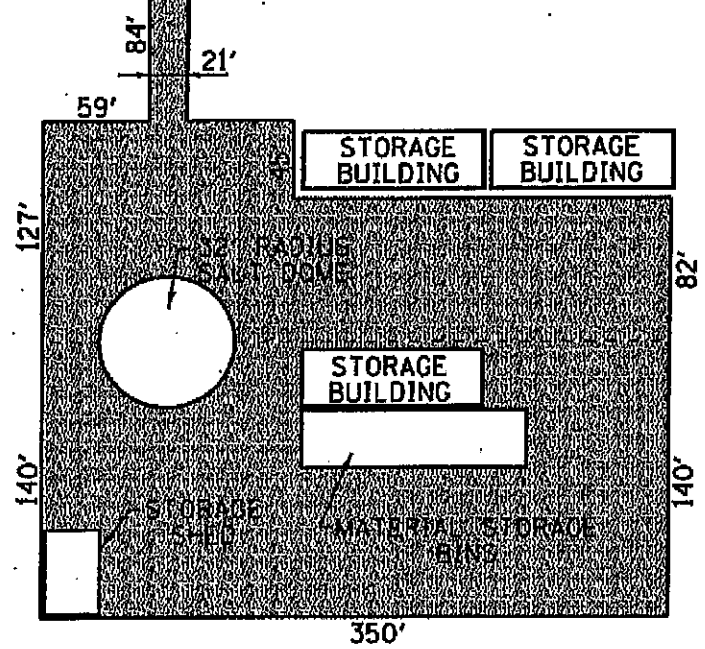

**LOCATION 6  
DETAILS**

VARIOUS ROUTES  
DIST. 8 SEAL COAT 2010-2  
VARIOUS COUNTIES

PROJECT LOCATION

TOTAL SHEETS	SHEET NO.
14	11
CONTRACT NO.: 76C82	

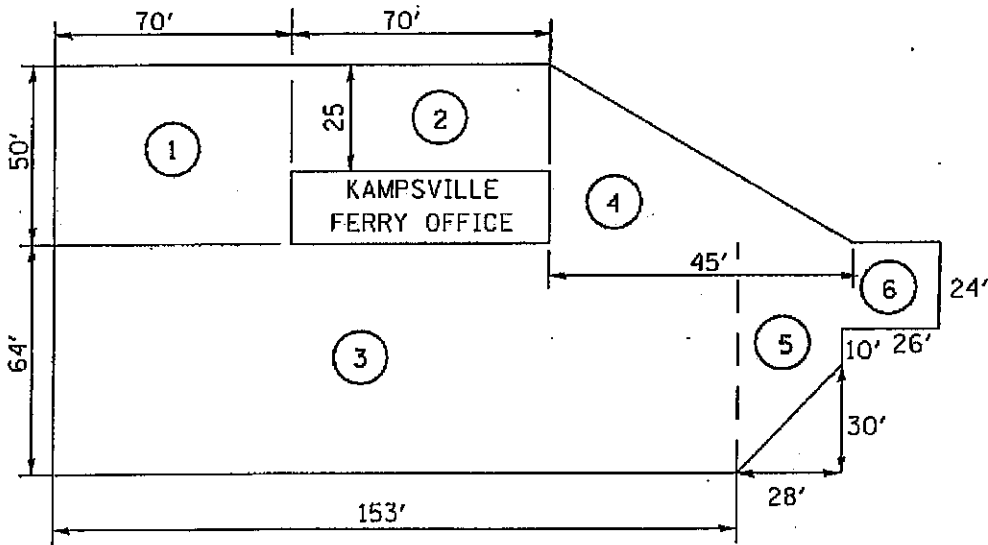
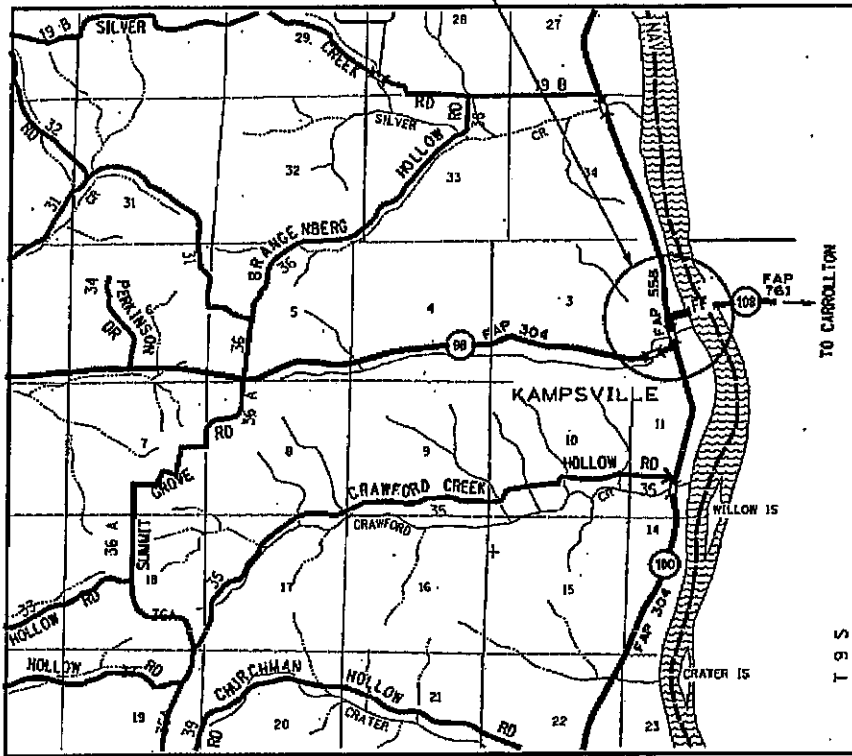

LOCATION 7  
DETAILS

VARIOUS ROUTES  
DIST. 8 SEAL COAT 2010-2  
VARIOUS COUNTIES

PLOT DATE: 1/29/2009

\*\*DATE\*\*  
1/29/2009  
c:\pvt\work\p\10107\PHILLIPSS\10119450\4876c82.dgn

TOTAL SHEETS	SHEET NO.
14	12
CONTRACT NO. 76CB2	

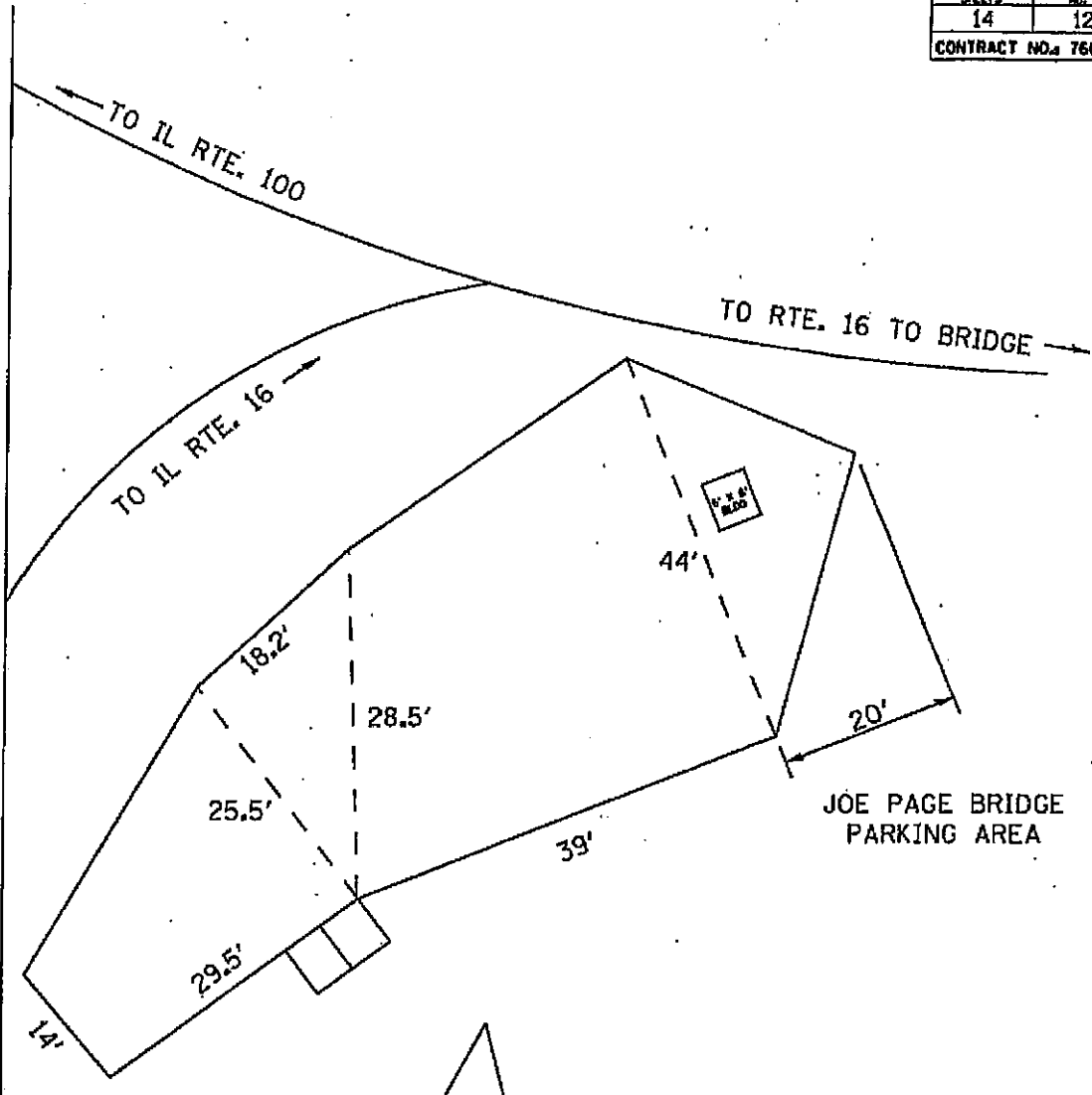

COUNTY ROAD 1 TO HARDIN

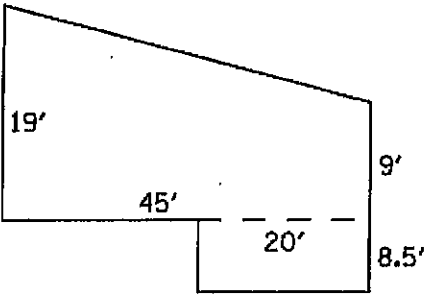

JOE PAGE BRIDGE  
EQUIPMENT STORAGE GARAGE  
(0.1 MI S. OF BRIDGE)  
A2 SURFACE TREATMENT

STORAGE GARAGE

----- LOCATION 8 -----  
 ----- DETAILS -----

**VARIOUS ROUTES  
 DIST. 8 SEAL COAT 2010-2  
 VARIOUS COUNTIES**

PHILLIPSSA \\PHILLIPSSA\1119456\38776c82-ar-p-lans.dgn  
 1/29/2009 10:54:16 AM

PLOT DATE: 1/29/2009

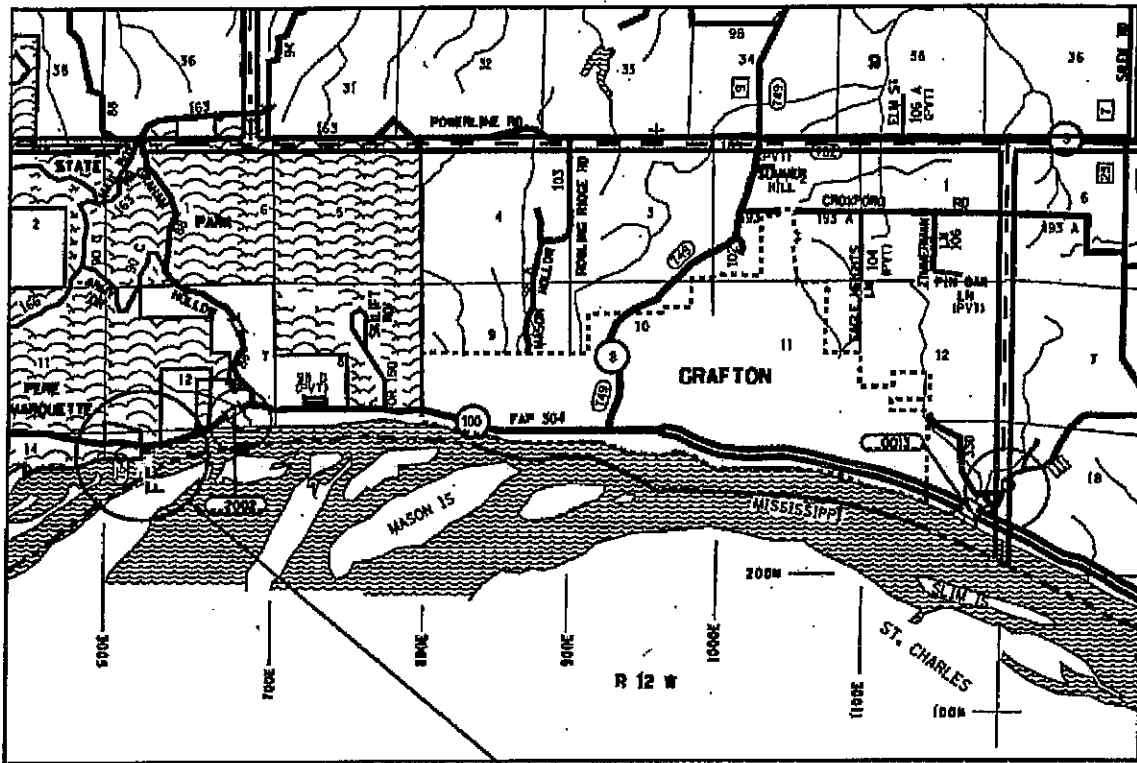

**PROJECT LOCATION**

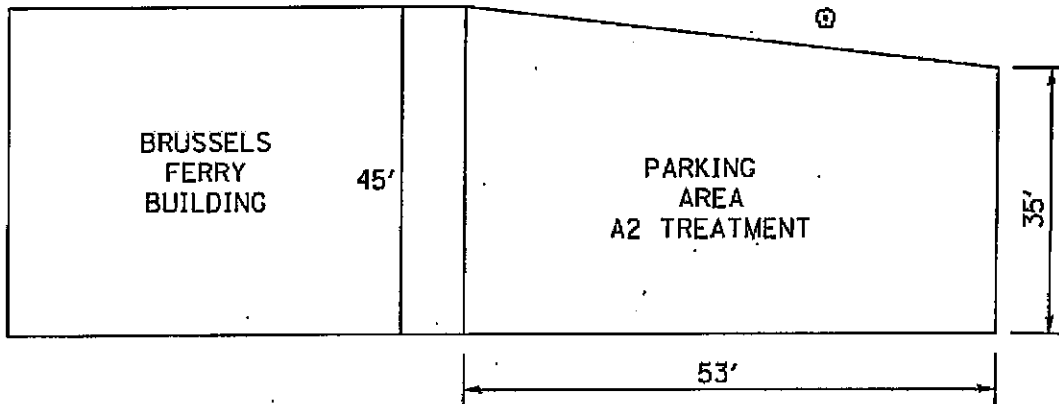

IL RTE. 100

**LOCATION 9  
DETAILS**

VARIOUS ROUTES  
DIST. 8 SEAL COAT 2010-2  
VARIOUS COUNTIES

PLOT DATE: 1/29/2009

TOTAL SHEETS	SHEET NO.
14	14
CONTRACT NO. 76CB2	

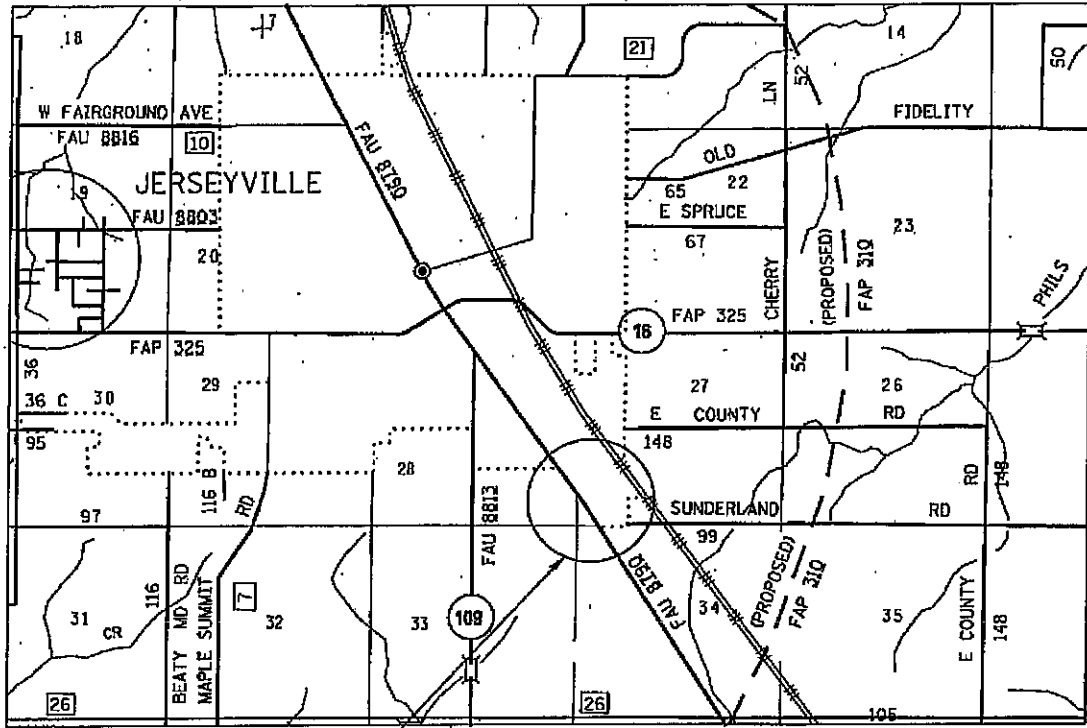

PROJECT LOCATION

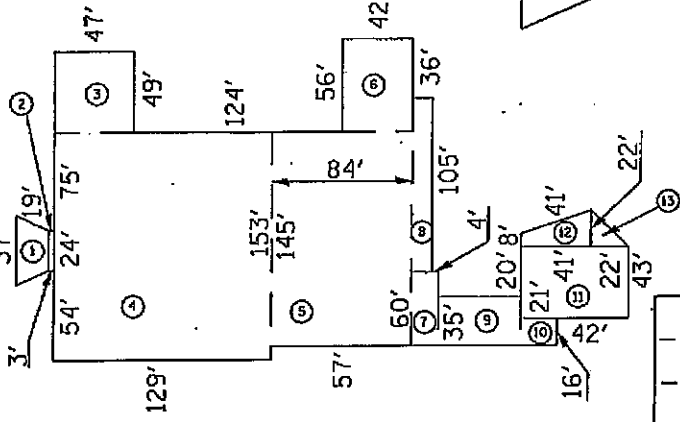
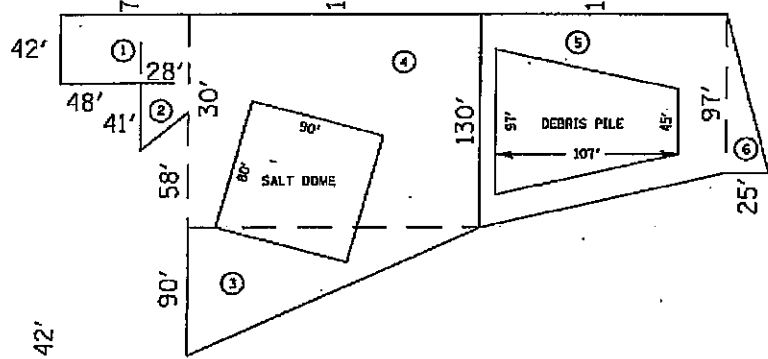

LOCATION 10  
DETAILS & QUANTITIES

VARIOUS ROUTES  
DIST. B SEAL COAT 2010-2  
VARIOUS COUNTIES

PLOT DATE: DATE-TIME

\*\*DATE\*\*  
\*DATE-TIME\*  
\*JOB-SPEC\*

## **ILLINOIS DEPARTMENT OF LABOR**

### **PREVAILING WAGES FOR VARIOUS COUNTIES EFFECTIVE MAY 2009**

The Prevailing rates of wages are included in the Contract proposals which are subject to Check Sheet #5 of the Supplemental Specifications and Recurring Special Provisions. The rates have been ascertained and certified by the Illinois Department of Labor for the locality in which the work is to be performed and for each craft or type of work or mechanic needed to execute the work of the Contract. As required by Prevailing Wage Act (820 ILCS 130/0.01, et seq.) and Check Sheet #5 of the Contract, not less than the rates of wages ascertained by the Illinois Department of Labor and as revised during the performance of a Contract shall be paid to all laborers, workers and mechanics performing work under the Contract. Post the scale of wages in a prominent and easily accessible place at the site of work.

If the Illinois Department of Labor revises the prevailing rates of wages to be paid as listed in the specification of rates, the contractor shall post the revised rates of wages and shall pay not less than the revised rates of wages. Current wage rate information shall be obtained by visiting the Illinois Department of Labor web site at <http://www.state.il.us/agency/idol/> or by calling 312-793-2814. It is the responsibility of the contractor to review the rates applicable to the work of the contract at regular intervals in order to insure the timely payment of current rates. Provision of this information to the contractor by means of the Illinois Department of Labor web site satisfies the notification of revisions by the Department to the contractor pursuant to the Act, and the contractor agrees that no additional notice is required. The contractor shall notify each of its subcontractors of the revised rates of wages.

# Calhoun County Prevailing Wage for May 2009

Trade Name	RG	TYP	C	Base	FRMAN	*M-F>8	OSA	OSH	H/W	Pensn	Vac	Trng
=====	==	===	=	=====	=====	=====	===	===	=====	=====	=====	=====
ASBESTOS ABT-GEN		ALL		27.100	27.600	1.5	1.5	2.0	5.050	7.400	0.000	0.700
ASBESTOS ABT-MEC		BLD		26.610	27.610	1.5	1.5	2.0	5.250	2.500	0.000	0.250
BOILERMAKER		BLD		31.500	34.000	1.5	1.5	2.0	6.820	11.43	1.500	0.350
BRICK MASON		BLD		27.990	29.790	1.5	1.5	2.0	5.850	8.600	2.000	0.500
CARPENTER		ALL		32.270	33.770	1.5	1.5	2.0	5.550	4.250	0.000	0.350
CEMENT MASON		ALL		28.450	29.450	1.5	1.5	2.0	6.500	9.500	0.000	0.200
CERAMIC TILE FNSHER		BLD		23.370	0.000	1.5	1.5	2.0	5.200	4.400	0.000	0.410
ELECTRIC PWR EQMT OP		ALL		32.310	39.460	1.5	2.0	2.0	4.750	8.080	0.000	0.240
ELECTRIC PWR GRNDMAN		ALL		22.000	39.460	1.5	2.0	2.0	4.750	5.500	0.000	0.170
ELECTRIC PWR LINEMAN		ALL		37.270	39.460	1.5	2.0	2.0	4.750	9.320	0.000	0.280
ELECTRIC PWR TRK DRV		ALL		22.550	39.460	1.5	2.0	2.0	4.750	5.640	0.000	0.170
ELECTRICIAN		ALL		33.700	35.700	1.5	1.5	2.0	5.900	8.515	0.000	0.510
ELECTRONIC SYS TECH		BLD		25.000	26.500	1.5	1.5	2.0	5.650	5.475	0.000	0.250
FLOOR LAYER		BLD		27.680	27.980	1.5	1.5	2.0	5.550	4.250	1.000	0.350
GLAZIER		BLD		30.810	0.000	2.0	2.0	2.0	9.020	8.300	2.460	0.310
HT/FROST INSULATOR		BLD		32.910	33.910	1.5	1.5	2.0	5.600	9.360	0.000	0.500
IRON WORKER		ALL		28.350	29.850	1.5	1.5	2.0	6.360	10.05	0.000	0.420
LABORER		ALL		26.600	27.100	1.5	1.5	2.0	5.050	7.400	0.000	0.700
MACHINIST		BLD		40.530	42.530	1.5	1.5	2.0	7.000	7.670	0.650	0.000
MARBLE FINISHERS		BLD		23.370	0.000	1.5	1.5	2.0	5.200	4.400	0.000	0.410
MILLWRIGHT		ALL		32.270	33.770	1.5	1.5	2.0	5.550	4.250	0.000	0.350
OPERATING ENGINEER		ALL	1	28.500	31.500	1.5	1.5	2.0	7.300	12.75	0.000	1.000
OPERATING ENGINEER		ALL	2	27.370	31.500	1.5	1.5	2.0	7.300	12.75	0.000	1.000
OPERATING ENGINEER		ALL	3	22.890	31.500	1.5	1.5	2.0	7.300	12.75	0.000	1.000
OPERATING ENGINEER		ALL	4	22.950	31.500	1.5	1.5	2.0	7.300	12.75	0.000	1.000
OPERATING ENGINEER		ALL	5	22.620	31.500	1.5	1.5	2.0	7.300	12.75	0.000	1.000
OPERATING ENGINEER		ALL	6	29.050	31.500	1.5	1.5	2.0	7.300	12.75	0.000	1.000
OPERATING ENGINEER		ALL	7	29.350	31.500	1.5	1.5	2.0	7.300	12.75	0.000	1.000
OPERATING ENGINEER		ALL	8	29.630	31.500	1.5	1.5	2.0	7.300	12.75	0.000	1.000
PAINTER		BLD		27.700	29.200	1.5	1.5	2.0	4.750	6.170	0.000	0.450
PAINTER		HWY		28.900	30.400	1.5	1.5	2.0	4.750	6.170	0.000	0.450
PAINTER OVER 30FT		BLD		28.700	30.200	1.5	1.5	2.0	4.750	6.170	0.000	0.450
PAINTER PWR EQMT		BLD		28.700	30.200	1.5	1.5	2.0	4.750	6.170	0.000	0.450
PAINTER PWR EQMT		HWY		29.900	31.400	1.5	1.5	2.0	4.750	6.170	0.000	0.450
PILEDRIVER		ALL		32.270	33.770	1.5	1.5	2.0	5.550	4.250	0.000	0.350
PIPEFITTER		BLD		32.950	34.600	2.0	2.0	2.0	5.350	7.160	0.000	0.200
PLASTERER		BLD		29.150	30.150	1.5	1.5	2.0	6.500	7.750	0.000	0.250
PLUMBER		BLD		32.950	34.600	2.0	2.0	2.0	5.350	7.160	0.000	0.200
ROOFER		BLD		28.000	30.000	1.5	1.5	2.0	7.150	6.400	0.000	0.200
SHEETMETAL WORKER		BLD		24.750	26.410	1.5	1.5	2.0	6.790	7.940	0.000	0.380
SPRINKLER FITTER		BLD		36.230	38.980	2.0	2.0	2.0	6.650	8.350	0.000	0.650
TERRAZZO FINISHER		BLD		31.240	0.000	1.5	1.5	2.0	0.000	0.000	0.000	0.000
TERRAZZO MASON		BLD		32.530	32.830	1.5	1.5	2.0	0.000	4.250	0.000	0.070
TRUCK DRIVER		ALL	1	27.580	0.000	1.5	1.5	2.0	8.600	3.925	0.000	0.000
TRUCK DRIVER		ALL	2	27.980	0.000	1.5	1.5	2.0	8.600	3.925	0.000	0.000
TRUCK DRIVER		ALL	3	28.180	0.000	1.5	1.5	2.0	8.600	3.925	0.000	0.000
TRUCK DRIVER		ALL	4	28.430	0.000	1.5	1.5	2.0	8.600	3.925	0.000	0.000
TRUCK DRIVER		ALL	5	29.180	0.000	1.5	1.5	2.0	8.600	3.925	0.000	0.000
TRUCK DRIVER		O&C	1	22.060	0.000	1.5	1.5	2.0	8.600	3.925	0.000	0.000
TRUCK DRIVER		O&C	2	22.380	0.000	1.5	1.5	2.0	8.600	3.925	0.000	0.000
TRUCK DRIVER		O&C	3	22.540	0.000	1.5	1.5	2.0	8.600	3.925	0.000	0.000
TRUCK DRIVER		O&C	4	22.740	0.000	1.5	1.5	2.0	8.600	3.925	0.000	0.000
TRUCK DRIVER		O&C	5	23.340	0.000	1.5	1.5	2.0	8.600	3.925	0.000	0.000

Legend:

M-F>8 (Overtime is required for any hour greater than 8 worked each day, Monday through Friday.)

OSA (Overtime is required for every hour worked on Saturday)

OSH (Overtime is required for every hour worked on Sunday and Holidays)

H/W (Health & Welfare Insurance)

Pensn (Pension)

Vac (Vacation)

Trng (Training)

## Explanations

### CALHOUN COUNTY

The following list is considered as those days for which holiday rates of wages for work performed apply: New Years Day, Memorial/Decoration Day, Fourth of July, Labor Day, Veterans Day, Thanksgiving Day, Christmas Day. Generally, any of these holidays which fall on a Sunday is celebrated on the following Monday. This then makes work performed on that Monday payable at the appropriate overtime rate for holiday pay. Common practice in a given local may alter certain days of celebration such as the day after Thanksgiving for Veterans Day. If in doubt, please check with IDOL.

Oil and chip resealing (O&C) means the application of road oils and liquid asphalt to coat an existing road surface, followed by application of aggregate chips or gravel to coated surface, and subsequent rolling of material to seal the surface.

### EXPLANATION OF CLASSES

ASBESTOS - GENERAL - removal of asbestos material/mold and hazardous materials from any place in a building, including mechanical systems where those mechanical systems are to be removed. This includes the removal of asbestos materials/mold and hazardous materials from ductwork or pipes in a building when the building is to be demolished at the time or at some close future date.

ASBESTOS - MECHANICAL - removal of asbestos material from mechanical systems, such as pipes, ducts, and boilers, where the mechanical systems are to remain.

### CERAMIC TILE FINISHER AND MARBLE FINISHER

The handling, at the building site, of all sand, cement, tile, marble or stone and all other materials that may be used and installed by [a] tile layer or marble mason. In addition, the grouting, cleaning, sealing, and mixing on the job site, and all other work as required in assisting the setter. The term "Ceramic" is used for naming the classification only and is in no way a limitation of the product handled. Ceramic takes into consideration most hard tiles.

### ELECTRONIC SYSTEMS TECHNICIAN

Installation, service and maintenance of low-voltage systems which utilizes the transmission and/or transference of voice, sound, vision, or digital for commercial, education, security and entertainment



purposes for the following: TV monitoring and surveillance, background/foreground music, intercom and telephone interconnect, field programming, inventory control systems, microwave transmission, multi-media, multiplex, radio page, school, intercom and sound burglar alarms and low voltage master clock systems.

Excluded from this classification are energy management systems, life safety systems, supervisory controls and data acquisition systems not intrinsic with the above listed systems, fire alarm systems, nurse call systems and raceways exceeding fifteen feet in length.

#### TRUCK DRIVER - BUILDING, HEAVY AND HIGHWAY CONSTRUCTION

Class 1. Drivers on 2 axle trucks hauling less than 9 ton. Air compressor and welding machines and brooms, including those pulled by separate units, truck driver helpers, warehouse employees, mechanic helpers, greasers and tiremen, pickup trucks when hauling materials, tools, or workers to and from and on-the-job site, and fork lifts up to 6,000 lb. capacity.

Class 2. Two or three axle trucks hauling more than 9 ton but hauling less than 16 ton. A-frame winch trucks, hydrolift trucks, vector trucks or similar equipment when used for transportation purposes. Fork lifts over 6,000 lb. capacity, winch trucks, four axle combination units, and ticket writers.

Class 3. Two, three or four axle trucks hauling 16 ton or more. Drivers on water pulls, articulated dump trucks, mechanics and working forepersons, and dispatchers. Five axle or more combination units.

Class 4. Low Boy and Oil Distributors.

Class 5. Drivers who require special protective clothing while employed on hazardous waste work.

#### TRUCK DRIVER - OIL AND CHIP RESEALING ONLY.

This shall encompass laborers, workers and mechanics who drive contractor or subcontractor owned, leased, or hired pickup, dump, service, or oil distributor trucks. The work includes transporting materials and equipment (including but not limited to, oils, aggregate supplies, parts, machinery and tools) to or from the job site; distributing oil or liquid asphalt and aggregate; stock piling material when in connectin with the actual oil and chip contract. The Truck Driver (Oil & Chip Resealing) wage classification does not include supplier delivered materials.

#### OPERATING ENGINEERS

GROUP I. Cranes, Dragline, Shovels, Skimmer Scoops, Clamshells or Derrick Boats, Pile Drivers, Crane-Type Backhoes, Asphalt Plant Operators, Concrete Plant Operators, Dredges, Asphalt Spreading Machines, All Locomotives, Cable Ways, or Tower Machines, Hoists, Hydraulic Backhoes, Ditching Machines or Backfiller, Cherrypickers, Overhead Cranes, Roller, Steam or Gas, Concrete Pavers, Excavators, Concrete Breakers, Concrete Pumps, Bulk Cement Plants, Cement Pumps, Derrick-Type Drills, Boat Operators, Motor Graders or Pushcats, Scoops or Tournapulls, Bulldozers, Endloaders or Fork Lifts, Power Blade or Elevating Graders, Winch Cats, Boom or Winch Trucks or Boom Tractors, Pipe Wrapping or Painting Machines, Asphalt Plant Engineer, Journeyman Lubricating Engineer, Drills (other than Derrick Type), Mud Jacks, or Well Drilling Machines, Boring Machines or Track Jacks, Mixers, Conveyors (Two), Air Compressors (Two), Water Pumps

regardless of size (Two), Welding Machines (Two), Siphons or Jets (Two), Winch Heads or Apparatuses (Two), Light Plants (Two), Waterblasters (two), All Tractors regardless of size (straight tractor only), Fireman on Stationary Boilers, Automatic Elevators, Form Grading Machines, Finishing Machines, Power Sub-Grader or Ribbon Machines, Longitudinal Floats, Distributor Operators on Trucks, Winch Heads or Apparatuses (One), Mobil Track air and heaters (two to five), Heavy Equipment Greaser, Relief Operator, Assistant Master Mechanic and Heavy Duty Mechanic, all Operators (except those listed below).

GROUP II. Assistant Operators.

GROUP III. Air Compressors (One), Water Pumps, regardless of Size (One), Waterblasters (one), Welding Machine (One), Mixers (One Bag), Conveyor (One), Siphon or Jet (One), Light Plant (One), Heater (One), Immobile Track Air (One), and Self Propelled Walk-Behind Rollers.

GROUP IV. Asphalt Spreader Oilers, Fireman on Whirlies and Heavy Equipment Oilers, Truck Cranes, Dredges, Monigans, Large Cranes - (Over 65-ton rated capacity) Concrete Plant Oiler, Blacktop Plant Oiler, and Creter Crane Oiler (when required).

GROUP V. Oiler.

GROUP VI. Master Mechanics, Operators on equipment with Booms, including jibs, 100 feet and over, and less than 150 feet long

GROUP VII. Operators on equipment with Booms, including jibs, 150 feet and over, and less than 200 feet long.

GROUP VIII. Operators on Equipment with Booms, including jibs, 200 feet and over; Tower Cranes; Whirlie Cranes; and Operator Foreman.

#### TERRAZZO FINISHER

The handling of all materials used for Mosaic and Terrazzo work including preparing, mixing by hand, by mixing machine or transporting of pre-mixed materials and distributing with shovel, rake, hoe, or pail, all kinds of concrete foundations necessary for Mosaic and Terrazzo work, all cement terrazzo, magnesite terrazzo, Do-O-Tex terrazzo, epoxy matrix ter-razzo, exposed aggregate, rustic or rough washed for exterior or interior of buildings placed either by machine or by hand, and any other kind of mixture of plastics composed of chips or granules when mixed with cement, rubber, neoprene, vinyl, magnesium chloride or any other resinous or chemical substances used for seamless flooring systems, and all other building materials, all similar materials and all precast terrazzo work on jobs, all scratch coat used for Mosaic and Terrazzo work and sub-bed, tar paper and wire mesh (2x2 etc.) or lath. The rubbing, grinding, cleaning and finishing of same either by hand or by machine or by terrazzo resurfacing equipment on new or existing floors. When necessary finishers shall be allowed to assist the mechanics to spread sand bed, lay tarpaper and wire mesh (2x2 etc.) or lath. The finishing of cement floors where additional aggregate of stone is added by spreading or sprinkling on top of the finished base, and troweled or rolled into the finish and then the surface is ground by grinding machines.

Other Classifications of Work:

For definitions of classifications not otherwise set out, the Department generally has on file such definitions which are available. If a task to be performed is not subject to one of the classifications of pay set out, the Department will upon being contacted state which neighboring county has such a classification and provide such rate, such rate being deemed to exist by reference in this document. If no neighboring county rate applies to the task, the Department shall undertake a special determination, such special determination being then deemed to have existed under this determination. If a project requires these, or any classification not listed, please contact IDOL at 618/993-7271 for wage rates or clarifications.

LANDSCAPING

Landscaping work falls under the existing classifications for laborer, operating engineer and truck driver. The work performed by landscape plantsman and landscape laborer is covered by the existing classification of laborer. The work performed by landscape operators (regardless of equipment used or its size) is covered by the classifications of operating engineer. The work performed by landscape truck drivers (regardless of size of truck driven) is covered by the classifications of truck driver.

# Greene County Prevailing Wage for May 2009

Trade Name	RG	TYP	C	Base	FRMAN	*M-F>8	OSA	OSH	H/W	Pensn	Vac	Trng
=====	==	===	=	=====	=====	=====	===	===	=====	=====	=====	=====
ASBESTOS ABT-GEN		ALL		27.100	27.600	1.5	1.5	2.0	5.050	7.400	0.000	0.700
ASBESTOS ABT-MEC		BLD		26.610	27.610	1.5	1.5	2.0	5.250	2.500	0.000	0.250
BOILERMAKER		BLD		31.500	34.000	1.5	1.5	2.0	6.820	11.43	1.500	0.350
BRICK MASON		BLD		25.260	26.260	1.5	1.5	2.0	6.900	6.500	0.000	0.540
CARPENTER		BLD		27.250	29.500	1.5	1.5	2.0	6.750	8.590	0.000	0.320
CARPENTER		HWY		27.250	29.000	1.5	1.5	2.0	6.750	8.430	0.000	0.320
CEMENT MASON		ALL		28.450	29.450	1.5	1.5	2.0	6.500	9.500	0.000	0.200
CERAMIC TILE FNSHER		BLD		23.960	0.000	1.5	1.5	2.0	6.900	6.500	0.000	0.000
ELECTRIC PWR EQMT OP		ALL		32.310	39.460	1.5	2.0	2.0	4.750	8.080	0.000	0.240
ELECTRIC PWR GRNDMAN		ALL		22.000	39.460	1.5	2.0	2.0	4.750	5.500	0.000	0.170
ELECTRIC PWR LINEMAN		ALL		37.270	39.460	1.5	2.0	2.0	4.750	9.320	0.000	0.280
ELECTRIC PWR TRK DRV		ALL		22.550	39.460	1.5	2.0	2.0	4.750	5.640	0.000	0.170
ELECTRICIAN		ALL		33.700	35.700	1.5	1.5	2.0	5.900	8.515	0.000	0.510
ELECTRONIC SYS TECH		BLD		25.000	26.500	1.5	1.5	2.0	5.650	5.475	0.000	0.250
ELEVATOR CONSTRUCTOR		BLD		39.715	44.680	2.0	2.0	2.0	9.525	8.210	2.380	0.000
GLAZIER		BLD		30.810	0.000	2.0	2.0	2.0	9.020	8.300	2.460	0.310
HT/FROST INSULATOR		BLD		32.910	33.910	1.5	1.5	2.0	5.600	9.360	0.000	0.500
IRON WORKER		BLD		27.300	29.300	1.5	1.5	2.0	5.860	9.610	0.000	0.500
IRON WORKER		HWY		27.300	28.800	1.5	1.5	2.0	5.860	9.610	0.000	0.500
LABORER		ALL		26.600	27.100	1.5	1.5	2.0	5.050	7.400	0.000	0.700
LATHER		BLD		27.250	29.500	1.5	1.5	2.0	6.750	8.590	0.000	0.320
MACHINIST		BLD		40.530	42.530	1.5	1.5	2.0	7.000	7.670	0.650	0.000
MARBLE FINISHERS		BLD		23.960	0.000	1.5	1.5	2.0	6.900	6.500	0.000	0.000
MARBLE MASON		BLD		25.460	26.210	1.5	1.5	2.0	6.900	6.500	0.000	0.000
MILLWRIGHT		BLD		27.700	29.950	1.5	1.5	2.0	6.750	8.600	0.000	0.320
MILLWRIGHT		HWY		29.260	31.010	1.5	1.5	2.0	6.750	9.050	0.000	0.320
OPERATING ENGINEER		ALL	1	28.500	31.500	1.5	1.5	2.0	7.300	12.75	0.000	1.000
OPERATING ENGINEER		ALL	2	27.370	31.500	1.5	1.5	2.0	7.300	12.75	0.000	1.000
OPERATING ENGINEER		ALL	3	22.890	31.500	1.5	1.5	2.0	7.300	12.75	0.000	1.000
OPERATING ENGINEER		ALL	4	22.950	31.500	1.5	1.5	2.0	7.300	12.75	0.000	1.000
OPERATING ENGINEER		ALL	5	22.620	31.500	1.5	1.5	2.0	7.300	12.75	0.000	1.000
OPERATING ENGINEER		ALL	6	29.050	31.500	1.5	1.5	2.0	7.300	12.75	0.000	1.000
OPERATING ENGINEER		ALL	7	29.350	31.500	1.5	1.5	2.0	7.300	12.75	0.000	1.000
OPERATING ENGINEER		ALL	8	29.630	31.500	1.5	1.5	2.0	7.300	12.75	0.000	1.000
PAINTER		BLD		27.700	29.200	1.5	1.5	2.0	4.750	6.170	0.000	0.450
PAINTER		HWY		28.900	30.400	1.5	1.5	2.0	4.750	6.170	0.000	0.450
PAINTER OVER 30FT		BLD		28.700	30.200	1.5	1.5	2.0	4.750	6.170	0.000	0.450
PAINTER PWR EQMT		BLD		28.700	30.200	1.5	1.5	2.0	4.750	6.170	0.000	0.450
PAINTER PWR EQMT		HWY		29.900	31.400	1.5	1.5	2.0	4.750	6.170	0.000	0.450
PILEDRIIVER		BLD		27.750	30.000	1.5	1.5	2.0	6.750	8.590	0.000	0.320
PILEDRIIVER		HWY		27.250	29.000	1.5	1.5	2.0	6.750	8.430	0.000	0.320
PIPEFITTER		BLD		32.950	34.600	2.0	2.0	2.0	5.350	7.160	0.000	0.200
PLASTERER		BLD		29.150	30.150	1.5	1.5	2.0	6.500	7.750	0.000	0.250
PLUMBER		BLD		32.950	34.600	2.0	2.0	2.0	5.350	7.160	0.000	0.200
ROOFER		BLD		28.000	30.000	1.5	1.5	2.0	7.150	6.400	0.000	0.200
SHEETMETAL WORKER		ALL		28.080	29.580	1.5	1.5	2.0	6.350	5.650	1.690	0.260
SPRINKLER FITTER		BLD		36.230	38.980	2.0	2.0	2.0	6.650	8.350	0.000	0.650
STONE MASON		BLD		25.260	26.260	1.5	1.5	2.0	6.900	6.500	0.000	0.540
TERRAZZO FINISHER		BLD		23.960	0.000	1.5	1.5	2.0	6.900	6.500	0.000	0.000
TERRAZZO MASON		BLD		25.460	26.210	1.5	1.5	2.0	6.900	6.500	0.000	0.000
TILE MASON		BLD		25.460	26.210	1.5	1.5	2.0	6.900	6.500	0.000	0.000
TRUCK DRIVER		ALL	1	27.580	0.000	1.5	1.5	2.0	8.600	3.925	0.000	0.000
TRUCK DRIVER		ALL	2	27.980	0.000	1.5	1.5	2.0	8.600	3.925	0.000	0.000
TRUCK DRIVER		ALL	3	28.180	0.000	1.5	1.5	2.0	8.600	3.925	0.000	0.000
TRUCK DRIVER		ALL	4	28.430	0.000	1.5	1.5	2.0	8.600	3.925	0.000	0.000
TRUCK DRIVER		ALL	5	29.180	0.000	1.5	1.5	2.0	8.600	3.925	0.000	0.000
TRUCK DRIVER		O&C	1	22.060	0.000	1.5	1.5	2.0	8.600	3.925	0.000	0.000
TRUCK DRIVER		O&C	2	22.380	0.000	1.5	1.5	2.0	8.600	3.925	0.000	0.000

TRUCK DRIVER	O&C 3	22.540	0.000	1.5	1.5	2.0	8.600	3.925	0.000	0.000
TRUCK DRIVER	O&C 4	22.740	0.000	1.5	1.5	2.0	8.600	3.925	0.000	0.000
TRUCK DRIVER	O&C 5	23.340	0.000	1.5	1.5	2.0	8.600	3.925	0.000	0.000
TUCKPONTER	BLD	25.260	26.260	1.5	1.5	2.0	6.900	6.500	0.000	0.540

Legend:

M-F>8 (Overtime is required for any hour greater than 8 worked each day, Monday through Friday.)

OSA (Overtime is required for every hour worked on Saturday)

OSH (Overtime is required for every hour worked on Sunday and Holidays)

H/W (Health & Welfare Insurance)

Pensn (Pension)

Vac (Vacation)

Trng (Training)

## Explanations

### GREENE COUNTY

The following list is considered as those days for which holiday rates of wages for work performed apply: New Years Day, Memorial/Decoration Day, Fourth of July, Labor Day, Veterans Day, Thanksgiving Day, Christmas Day. Generally, any of these holidays which fall on a Sunday is celebrated on the following Monday. This then makes work performed on that Monday payable at the appropriate overtime rate for holiday pay. Common practice in a given local may alter certain days of celebration such as the day after Thanksgiving for Veterans Day. If in doubt, please check with IDOL.

Oil and chip resealing (O&C) means the application of road oils and liquid asphalt to coat an existing road surface, followed by application of aggregate chips or gravel to coated surface, and subsequent rolling of material to seal the surface.

### EXPLANATION OF CLASSES

ASBESTOS - GENERAL - removal of asbestos material/mold and hazardous materials from any place in a building, including mechanical systems where those mechanical systems are to be removed. This includes the removal of asbestos materials/mold and hazardous materials from ductwork or pipes in a building when the building is to be demolished at the time or at some close future date.

ASBESTOS - MECHANICAL - removal of asbestos material from mechanical systems, such as pipes, ducts, and boilers, where the mechanical systems are to remain.

### CERAMIC TILE FINISHER, MARBLE FINISHER, TERRAZZO FINISHER

Assisting, helping or supporting the tile, marble and terrazzo mechanic by performing their historic and traditional work assignments required to complete the proper installation of the work covered by

said crafts. The term "Ceramic" is used for naming the classification only and is in no way a limitation of the product handled. Ceramic takes into consideration most hard tiles.

#### ELECTRONIC SYSTEMS TECHNICIAN

Installation, service and maintenance of low-voltage systems which utilizes the transmission and/or transference of voice, sound, vision, or digital for commercial, education, security and entertainment purposes for the following: TV monitoring and surveillance, background/foreground music, intercom and telephone interconnect, field programming, inventory control systems, microwave transmission, multi-media, multiplex, radio page, school, intercom and sound burglar alarms and low voltage master clock systems.

Excluded from this classification are energy management systems, life safety systems, supervisory controls and data acquisition systems not intrinsic with the above listed systems, fire alarm systems, nurse call systems and raceways exceeding fifteen feet in length.

#### TRUCK DRIVER - BUILDING, HEAVY AND HIGHWAY CONSTRUCTION

Class 1. Drivers on 2 axle trucks hauling less than 9 ton. Air compressor and welding machines and brooms, including those pulled by separate units, truck driver helpers, warehouse employees, mechanic helpers, greasers and tiremen, pickup trucks when hauling materials, tools, or workers to and from and on-the-job site, and fork lifts up to 6,000 lb. capacity.

Class 2. Two or three axle trucks hauling more than 9 ton but hauling less than 16 ton. A-frame winch trucks, hydrolift trucks, vector trucks or similar equipment when used for transportation purposes. Fork lifts over 6,000 lb. capacity, winch trucks, four axle combination units, and ticket writers.

Class 3. Two, three or four axle trucks hauling 16 ton or more. Drivers on water pulls, articulated dump trucks, mechanics and working forepersons, and dispatchers. Five axle or more combination units.

Class 4. Low Boy and Oil Distributors.

Class 5. Drivers who require special protective clothing while employed on hazardous waste work.

#### TRUCK DRIVER - OIL AND CHIP RESEALING ONLY.

This shall encompass laborers, workers and mechanics who drive contractor or subcontractor owned, leased, or hired pickup, dump, service, or oil distributor trucks. The work includes transporting materials and equipment (including but not limited to, oils, aggregate supplies, parts, machinery and tools) to or from the job site; distributing oil or liquid asphalt and aggregate; stock piling material when in connection with the actual oil and chip contract. The Truck Driver (Oil & Chip Resealing) wage classification does not include supplier delivered materials.

#### OPERATING ENGINEERS

GROUP I. Cranes, Dragline, Shovels, Skimmer Scoops, Clamshells or Derrick Boats, Pile Drivers, Crane-Type Backhoes, Asphalt Plant Operators, Concrete Plant Operators, Dredges, Asphalt Spreading Machines, All Locomotives, Cable Ways, or Tower Machines, Hoists, Hydraulic Backhoes, Ditching Machines or Backfiller, Cherrypickers, Overhead Cranes, Roller, Steam or Gas, Concrete Pavers, Excavators, Concrete Breakers, Concrete Pumps, Bulk Cement Plants, Cement Pumps,

Derrick-Type Drills, Boat Operators, Motor Graders or Pushcats, Scoops or Tournapulls, Bulldozers, Endloaders or Fork Lifts, Power Blade or Elevating Graders, Winch Cats, Boom or Winch Trucks or Boom Tractors, Pipe Wrapping or Painting Machines, Asphalt Plant Engineer, Journeyman Lubricating Engineer, Drills (other than Derrick Type), Mud Jacks, or Well Drilling Machines, Boring Machines or Track Jacks, Mixers, Conveyors (Two), Air Compressors (Two), Water Pumps regardless of size (Two), Welding Machines (Two), Siphons or Jets (Two), Winch Heads or Apparatuses (Two), Light Plants (Two), Waterblasters (two), All Tractors regardless of size (straight tractor only), Fireman on Stationary Boilers, Automatic Elevators, Form Grading Machines, Finishing Machines, Power Sub-Grader or Ribbon Machines, Longitudinal Floats, Distributor Operators on Trucks, Winch Heads or Apparatuses (One), Mobil Track air and heaters (two to five), Heavy Equipment Greaser, Relief Operator, Assistant Master Mechanic and Heavy Duty Mechanic, all Operators (except those listed below).

GROUP II. Assistant Operators.

GROUP III. Air Compressors (One), Water Pumps, regardless of Size (One), Waterblasters (one), Welding Machine (One), Mixers (One Bag), Conveyor (One), Siphon or Jet (One), Light Plant (One), Heater (One), Immobile Track Air (One), and Self Propelled Walk-Behind Rollers.

GROUP IV. Asphalt Spreader Oilers, Fireman on Whirlies and Heavy Equipment Oilers, Truck Cranes, Dredges, Monigans, Large Cranes - (Over 65-ton rated capacity) Concrete Plant Oiler, Blacktop Plant Oiler, and Creter Crane Oiler (when required).

GROUP V. Oiler.

GROUP VI. Master Mechanics, Operators on equipment with Booms, including jibs, 100 feet and over, and less than 150 feet long.

GROUP VII. Operators on equipment with Booms, including jibs, 150 feet and over, and less than 200 feet long.

GROUP VIII. Operators on Equipment with Booms, including jibs, 200 feet and over; Tower Cranes; Whirlie Cranes; and Operator Foreman.

Other Classifications of Work:

For definitions of classifications not otherwise set out, the Department generally has on file such definitions which are available. If a task to be performed is not subject to one of the classifications of pay set out, the Department will upon being contacted state which neighboring county has such a classification and provide such rate, such rate being deemed to exist by reference in this document. If no neighboring county rate applies to the task, the Department shall undertake a special determination, such special determination being then deemed to have existed under this determination. If a project requires these, or any classification not listed, please contact IDOL at 618/993-7271 for wage rates or clarifications.

#### LANDSCAPING

Landscaping work falls under the existing classifications for laborer, operating engineer and truck driver. The work performed by landscape plantsman and landscape laborer is covered by the existing classification of laborer. The work performed by landscape operators (regardless of equipment used or its size) is covered by the classifications of operating engineer. The work performed by

landscape truck drivers (regardless of size of truck driven) is covered by the classifications of truck driver.



# Jersey County Prevailing Wage for May 2009

Trade Name	RG	TYP	C	Base	FRMAN	*M-F>8	OSA	OSH	H/W	Pensn	Vac	Trng
=====	==	===	=	=====	=====	=====	===	===	=====	=====	=====	=====
ASBESTOS ABT-GEN		ALL		27.100	27.600	1.5	1.5	2.0	5.050	7.400	0.000	0.700
ASBESTOS ABT-MEC		BLD		26.610	27.610	1.5	1.5	2.0	5.250	2.500	0.000	0.250
BOILERMAKER		BLD		31.500	34.000	1.5	1.5	2.0	6.820	11.43	1.500	0.350
BRICK MASON		BLD		27.990	29.790	1.5	1.5	2.0	5.850	8.600	2.000	0.500
CARPENTER		ALL		32.270	33.770	1.5	1.5	2.0	5.550	4.250	0.000	0.350
CEMENT MASON		ALL		28.450	29.450	1.5	1.5	2.0	6.500	9.500	0.000	0.200
CERAMIC TILE FNSHER		BLD		23.370	0.000	1.5	1.5	2.0	5.200	4.400	0.000	0.410
ELECTRIC PWR EQMT OP		ALL		32.310	39.460	1.5	2.0	2.0	4.750	8.080	0.000	0.240
ELECTRIC PWR GRNDMAN		ALL		22.000	39.460	1.5	2.0	2.0	4.750	5.500	0.000	0.170
ELECTRIC PWR LINEMAN		ALL		37.270	39.460	1.5	2.0	2.0	4.750	9.320	0.000	0.280
ELECTRIC PWR TRK DRV		ALL		22.550	39.460	1.5	2.0	2.0	4.750	5.640	0.000	0.170
ELECTRICIAN		ALL		33.700	35.700	1.5	1.5	2.0	5.900	8.515	0.000	0.510
ELECTRONIC SYS TECH		BLD		25.000	26.500	1.5	1.5	2.0	5.650	5.475	0.000	0.250
ELEVATOR CONSTRUCTOR		BLD		39.715	44.680	2.0	2.0	2.0	9.525	8.210	2.380	0.000
FLOOR LAYER		BLD		27.680	27.980	1.5	1.5	2.0	5.550	4.250	1.000	0.350
GLAZIER		BLD		30.810	0.000	2.0	2.0	2.0	9.020	8.300	2.460	0.310
HT/FROST INSULATOR		BLD		32.910	33.910	1.5	1.5	2.0	5.600	9.360	0.000	0.500
IRON WORKER		ALL		28.350	29.850	1.5	1.5	2.0	6.360	10.05	0.000	0.420
LABORER		ALL		26.600	27.100	1.5	1.5	2.0	5.050	7.400	0.000	0.700
MACHINIST		BLD		40.530	42.530	1.5	1.5	2.0	7.000	7.670	0.650	0.000
MARBLE FINISHERS		BLD		23.370	0.000	1.5	1.5	2.0	5.200	4.400	0.000	0.410
MILLWRIGHT		ALL		32.270	33.770	1.5	1.5	2.0	5.550	4.250	0.000	0.350
OPERATING ENGINEER		ALL	1	28.500	31.500	1.5	1.5	2.0	7.300	12.75	0.000	1.000
OPERATING ENGINEER		ALL	2	27.370	31.500	1.5	1.5	2.0	7.300	12.75	0.000	1.000
OPERATING ENGINEER		ALL	3	22.890	31.500	1.5	1.5	2.0	7.300	12.75	0.000	1.000
OPERATING ENGINEER		ALL	4	22.950	31.500	1.5	1.5	2.0	7.300	12.75	0.000	1.000
OPERATING ENGINEER		ALL	5	22.620	31.500	1.5	1.5	2.0	7.300	12.75	0.000	1.000
OPERATING ENGINEER		ALL	6	29.050	31.500	1.5	1.5	2.0	7.300	12.75	0.000	1.000
OPERATING ENGINEER		ALL	7	29.350	31.500	1.5	1.5	2.0	7.300	12.75	0.000	1.000
OPERATING ENGINEER		ALL	8	29.630	31.500	1.5	1.5	2.0	7.300	12.75	0.000	1.000
PAINTER		BLD		27.700	29.200	1.5	1.5	2.0	4.750	6.170	0.000	0.450
PAINTER		HWY		28.900	30.400	1.5	1.5	2.0	4.750	6.170	0.000	0.450
PAINTER OVER 30FT		BLD		28.700	30.200	1.5	1.5	2.0	4.750	6.170	0.000	0.450
PAINTER PWR EQMT		BLD		28.700	30.200	1.5	1.5	2.0	4.750	6.170	0.000	0.450
PAINTER PWR EQMT		HWY		29.900	31.400	1.5	1.5	2.0	4.750	6.170	0.000	0.450
PILEDRIVER		ALL		32.270	33.770	1.5	1.5	2.0	5.550	4.250	0.000	0.350
PIPEFITTER		BLD		32.950	34.600	2.0	2.0	2.0	5.350	7.160	0.000	0.200
PLASTERER		BLD		29.150	30.150	1.5	1.5	2.0	6.500	7.750	0.000	0.250
PLUMBER		BLD		32.950	34.600	2.0	2.0	2.0	5.350	7.160	0.000	0.200
ROOFER		BLD		28.000	30.000	1.5	1.5	2.0	7.150	6.400	0.000	0.200
SHEETMETAL WORKER		ALL		28.080	29.580	1.5	1.5	2.0	6.350	5.650	1.690	0.260
SPRINKLER FITTER		BLD		36.230	38.980	2.0	2.0	2.0	6.650	8.350	0.000	0.650
TERRAZZO FINISHER		BLD		31.240	0.000	1.5	1.5	2.0	0.000	0.000	0.000	0.000
TERRAZZO MASON		BLD		32.530	32.830	1.5	1.5	2.0	0.000	4.250	0.000	0.070
TRUCK DRIVER		ALL	1	27.580	0.000	1.5	1.5	2.0	8.600	3.925	0.000	0.000
TRUCK DRIVER		ALL	2	27.980	0.000	1.5	1.5	2.0	8.600	3.925	0.000	0.000
TRUCK DRIVER		ALL	3	28.180	0.000	1.5	1.5	2.0	8.600	3.925	0.000	0.000
TRUCK DRIVER		ALL	4	28.430	0.000	1.5	1.5	2.0	8.600	3.925	0.000	0.000
TRUCK DRIVER		ALL	5	29.180	0.000	1.5	1.5	2.0	8.600	3.925	0.000	0.000
TRUCK DRIVER		O&C	1	22.060	0.000	1.5	1.5	2.0	8.600	3.925	0.000	0.000
TRUCK DRIVER		O&C	2	22.380	0.000	1.5	1.5	2.0	8.600	3.925	0.000	0.000
TRUCK DRIVER		O&C	3	22.540	0.000	1.5	1.5	2.0	8.600	3.925	0.000	0.000
TRUCK DRIVER		O&C	4	22.740	0.000	1.5	1.5	2.0	8.600	3.925	0.000	0.000
TRUCK DRIVER		O&C	5	23.340	0.000	1.5	1.5	2.0	8.600	3.925	0.000	0.000

Legend :

M-F>8 (Overtime is required for any hour greater than 8 worked each day, Monday through Friday.)

OSA (Overtime is required for every hour worked on Saturday)

OSH (Overtime is required for every hour worked on Sunday and Holidays)

H/W (Health & Welfare Insurance)

Pensn (Pension)

Vac (Vacation)

Trng (Training)

## Explanations

### JERSEY COUNTY

The following list is considered as those days for which holiday rates of wages for work performed apply: New Years Day, Memorial/Decoration Day, Fourth of July, Labor Day, Veterans Day, Thanksgiving Day, Christmas Day. Generally, any of these holidays which fall on a Sunday is celebrated on the following Monday. This then makes work performed on that Monday payable at the appropriate overtime rate for holiday pay. Common practice in a given local may alter certain days of celebration such as the day after Thanksgiving for Veterans Day. If in doubt, please check with IDOL.

Oil and chip resealing (O&C) means the application of road oils and liquid asphalt to coat an existing road surface, followed by application of aggregate chips or gravel to coated surface, and subsequent rolling of material to seal the surface.

### EXPLANATION OF CLASSES

ASBESTOS - GENERAL - removal of asbestos material/mold and hazardous materials from any place in a building, including mechanical systems where those mechanical systems are to be removed. This includes the removal of asbestos materials/mold and hazardous materials from ductwork or pipes in a building when the building is to be demolished at the time or at some close future date.

ASBESTOS - MECHANICAL - removal of asbestos material from mechanical systems, such as pipes, ducts, and boilers, where the mechanical systems are to remain.

### CERAMIC TILE FINISHER AND MARBLE FINISHER

The handling, at the building site, of all sand, cement, tile, marble or stone and all other materials that may be used and installed by [a] tile layer or marble mason. In addition, the grouting, cleaning, sealing, and mixing on the job site, and all other work as required in assisting the setter. The term "Ceramic" is used for naming the classification only and is in no way a limitation of the product handled. Ceramic takes into consideration most hard tiles.

### ELECTRONIC SYSTEMS TECHNICIAN

Installation, service and maintenance of low-voltage systems which utilizes the transmission and/or transference of voice, sound, vision,

or digital for commercial, education, security and entertainment purposes for the following: TV monitoring and surveillance, background/foreground music, intercom and telephone interconnect, field programming, inventory control systems, microwave transmission, multi-media, multiplex, radio page, school, intercom and sound burglar alarms and low voltage master clock systems.

Excluded from this classification are energy management systems, life safety systems, supervisory controls and data acquisition systems not intrinsic with the above listed systems, fire alarm systems, nurse call systems and raceways exceeding fifteen feet in length.

#### TRUCK DRIVER - BUILDING, HEAVY AND HIGHWAY CONSTRUCTION

Class 1. Drivers on 2 axle trucks hauling less than 9 ton. Air compressor and welding machines and brooms, including those pulled by separate units, truck driver helpers, warehouse employees, mechanic helpers, greasers and tiremen, pickup trucks when hauling materials, tools, or workers to and from and on-the-job site, and fork lifts up to 6,000 lb. capacity.

Class 2. Two or three axle trucks hauling more than 9 ton but hauling less than 16 ton. A-frame winch trucks, hydrolift trucks, vector trucks or similar equipment when used for transportation purposes. Fork lifts over 6,000 lb. capacity, winch trucks, four axle combination units, and ticket writers.

Class 3. Two, three or four axle trucks hauling 16 ton or more. Drivers on water pulls, articulated dump trucks, mechanics and working forepersons, and dispatchers. Five axle or more combination units.

Class 4. Low Boy and Oil Distributors.

Class 5. Drivers who require special protective clothing while employed on hazardous waste work.

#### TRUCK DRIVER - OIL AND CHIP RESEALING ONLY.

This shall encompass laborers, workers and mechanics who drive contractor or subcontractor owned, leased, or hired pickup, dump, service, or oil distributor trucks. The work includes transporting materials and equipment (including but not limited to, oils, aggregate supplies, parts, machinery and tools) to or from the job site; distributing oil or liquid asphalt and aggregate; stock piling material when in connection with the actual oil and chip contract. The Truck Driver (Oil & Chip Resealing) wage classification does not include supplier delivered materials.

#### OPERATING ENGINEERS

GROUP I. Cranes, Dragline, Shovels, Skimmer Scoops, Clamshells or Derrick Boats, Pile Drivers, Crane-Type Backhoes, Asphalt Plant Operators, Concrete Plant Operators, Dredges, Asphalt Spreading Machines, All Locomotives, Cable Ways, or Tower Machines, Hoists, Hydraulic Backhoes, Ditching Machines or Backfiller, Cherrypickers, Overhead Cranes, Roller, Steam or Gas, Concrete Pavers, Excavators, Concrete Breakers, Concrete Pumps, Bulk Cement Plants, Cement Pumps, Derrick-Type Drills, Boat Operators, Motor Graders or Pushcats, Scoops or Tournapulls, Bulldozers, Endloaders or Fork Lifts, Power Blade or Elevating Graders, Winch Cats, Boom or Winch Trucks or Boom Tractors, Pipe Wrapping or Painting Machines, Asphalt Plant Engineer, Journeyman Lubricating Engineer, Drills (other than Derrick Type), Mud Jacks, or Well Drilling Machines, Boring Machines or Track Jacks, Mixers, Conveyors (Two), Air Compressors (Two), Water Pumps regardless of size (Two), Welding Machines (Two), Siphons or Jets

(Two), Winch Heads or Apparatuses (Two), Light Plants (Two), Waterblasters (two), All Tractors regardless of size (straight tractor only), Fireman on Stationary Boilers, Automatic Elevators, Form Grading Machines, Finishing Machines, Power Sub-Grader or Ribbon Machines, Longitudinal Floats, Distributor Operators on Trucks, Winch Heads or Apparatuses (One), Mobil Track air and heaters (two to five), Heavy Equipment Greaser, Relief Operator, Assistant Master Mechanic and Heavy Duty Mechanic, all Operators (except those listed below).

GROUP II. Assistant Operators.

GROUP III. Air Compressors (One), Water Pumps, regardless of Size (One), Waterblasters (one), Welding Machine (One), Mixers (One Bag), Conveyor (One), Siphon or Jet (One), Light Plant (One), Heater (One), Immobile Track Air (One), and Self Propelled Walk-Behind Rollers.

GROUP IV. Asphalt Spreader Oilers, Fireman on Whirlies and Heavy Equipment Oilers, Truck Cranes, Dredges, Monigans, Large Cranes - (Over 65-ton rated capacity) Concrete Plant Oiler, Blacktop Plant Oiler, and Creter Crane Oiler (when required).

GROUP V. Oiler.

GROUP VI. Master Mechanics, Operators on equipment with Booms, including jibs, 100 feet and over, and less than 150 feet long.

GROUP VII. Operators on equipment with Booms, including jibs, 150 feet and over, and less than 200 feet long.

GROUP VIII. Operators on Equipment with Booms, including jibs, 200 feet and over; Tower Cranes; Whirlie Cranes; and Operator Foreman.

TERRAZZO FINISHER

The handling of all materials used for Mosaic and Terrazzo work including preparing, mixing by hand, by mixing machine or transporting of pre-mixed materials and distributing with shovel, rake, hoe, or pail, all kinds of concrete foundations necessary for Mosaic and Terrazzo work, all cement terrazzo, magnesite terrazzo, Do-O-Tex terrazzo, epoxy matrix ter-razzo, exposed aggregate, rustic or rough washed for exterior or interior of buildings placed either by machine or by hand, and any other kind of mixture of plastics composed of chips or granules when mixed with cement, rubber, neoprene, vinyl, magnesium chloride or any other resinous or chemical substances used for seamless flooring systems, and all other building materials, all similar materials and all precast terrazzo work on jobs, all scratch coat used for Mosaic and Terrazzo work and sub-bed, tar paper and wire mesh (2x2 etc.) or lath. The rubbing, grinding, cleaning and finishing of same either by hand or by machine or by terrazzo resurfacing equipment on new or existing floors. When necessary finishers shall be allowed to assist the mechanics to spread sand bed, lay tarpaper and wire mesh (2x2 etc.) or lath. The finishing of cement floors where additional aggregate of stone is added by spreading or sprinkling on top of the finished base, and troweled or rolled into the finish and then the surface is ground by grinding machines.

Other Classifications of Work:

For definitions of classifications not otherwise set out, the Department generally has on file such definitions which are available. If a task to be performed is not subject to one of the classifications of pay set out, the Department will upon being contacted state which neighboring county has such a classification and provide such rate, such rate being deemed to exist by reference in this document. If no neighboring county rate applies to the task, the Department shall undertake a special determination, such special determination being then deemed to have existed under this determination. If a project requires these, or any classification not listed, please contact IDOL at 618/993-7271 for wage rates or clarifications.

LANDSCAPING

Landscaping work falls under the existing classifications for laborer, operating engineer and truck driver. The work performed by landscape plantsman and landscape laborer is covered by the existing classification of laborer. The work performed by landscape operators (regardless of equipment used or its size) is covered by the classifications of operating engineer. The work performed by landscape truck drivers (regardless of size of truck driven) is covered by the classifications of truck driver.