

STATE OF ILLINOIS
DEPARTMENT OF TRANSPORTATION

F.A.U. RTE.	SECTION	COUNTY	TOTAL SHEETS	SHEET NO.
8012	(21) PP. 1-5	SANGAMON	6	1
		ILLINOIS	CONTRACT NO. 72M01	

FOR INDEX OF SHEETS, SEE SHEET NO. 2

PROPOSED IMPROVEMENTS

FAU 8012 (OLD US 36)
SECTION (21) PP, 1-5
PATCHING
STATE
SANGAMON CO.

C-96-100-20

D-96-070-20

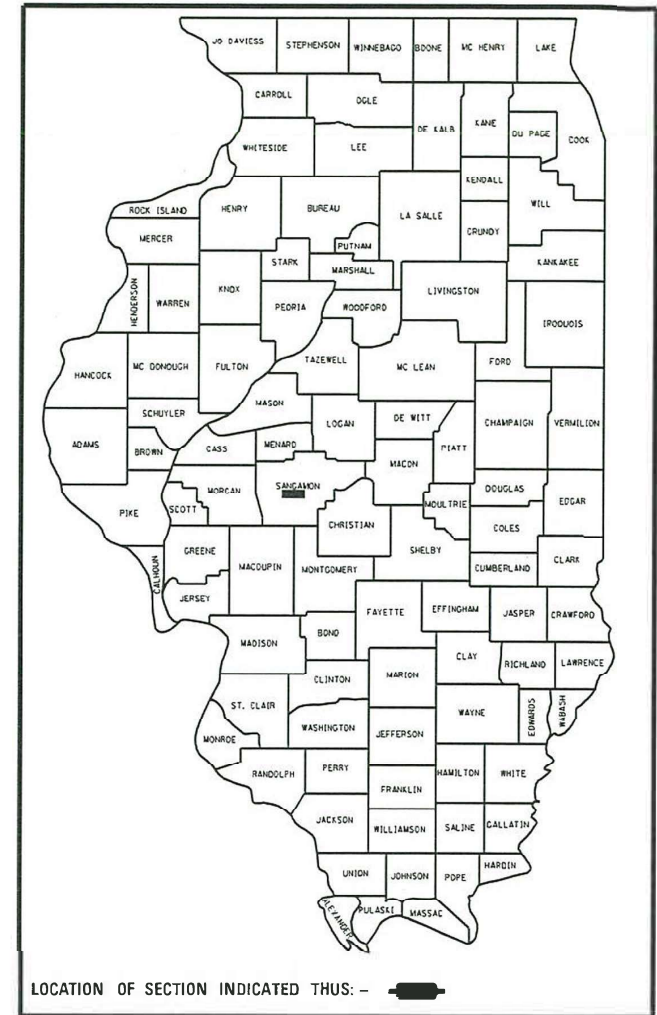

FAU 8012 (2017)
ADT = 2,100
SU = 150
MU = 30

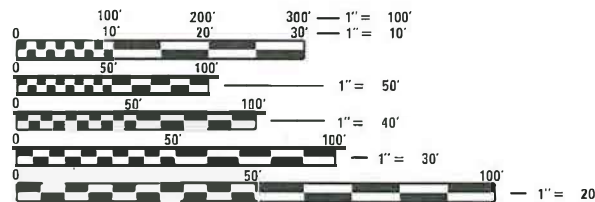

FULL SIZE PLANS HAVE BEEN PREPARED USING STANDARD ENGINEERING SCALES. REDUCED SIZED PLANS WILL NOT CONFORM TO STANDARD SCALES. IN MAKING MEASUREMENTS ON REDUCED PLANS, THE ABOVE SCALES MAY BE USED.

J.U.L.I.E.
JOINT UTILITY LOCATION INFORMATION FOR EXCAVATION
1-800-892-0123
OR 811

START PROJECT
STA. 215+50.00

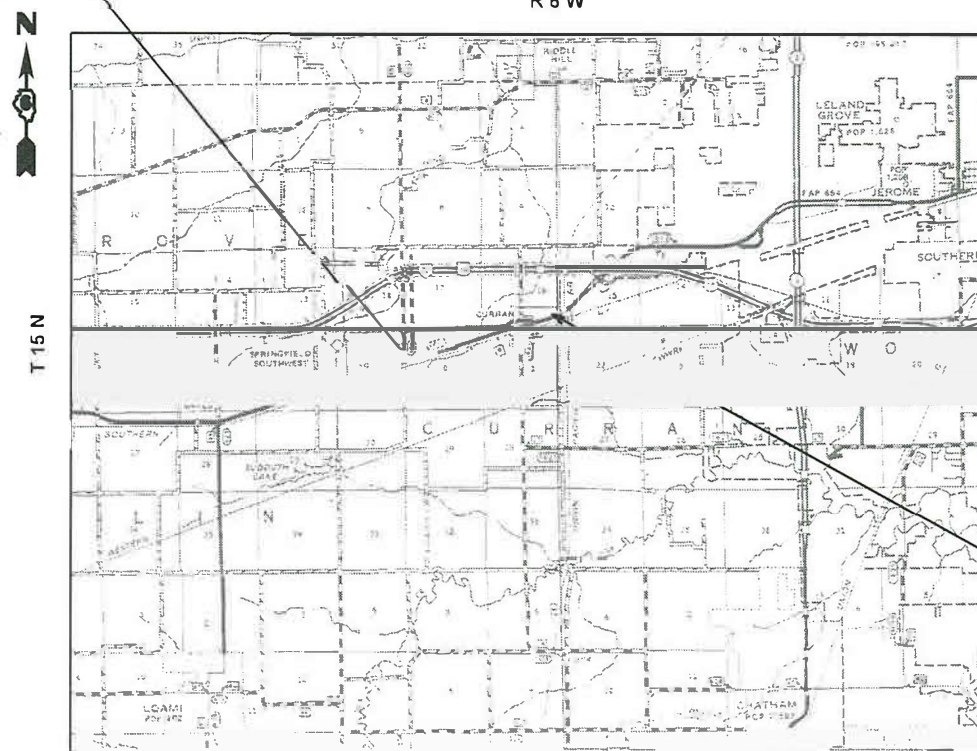

END PROJECT
STA. 347+80.00

PROJECT ENGINEER : MIKE IRWIN - (217)524-7765
PROJECT MANAGER : TIMOTHY SHARP - (217)524-9160

CONTRACT NO. 72M01

STATE OF ILLINOIS
DEPARTMENT OF TRANSPORTATION

SUBMITTED March 25 2020
[Signature] REGION FOUR ENGINEER

May 8, 2020 *[Signature]*
ENGINEER OF DESIGN AND ENVIRONMENT

May 8, 2020 *[Signature]*
DIRECTOR OF HIGHWAYS PROJECT IMPLEMENTATION 13

PRINTED BY THE AUTHORITY
OF THE STATE OF ILLINOIS

INDEX OF SHEETS

SHEET NO.	DESCRIPTION
1.	COVER SHEET
2.	INDEX OF SHEETS, STANDARDS, GENERAL NOTES & SIGNATURES
3.	SUMMARY OF QUANTITIES
4.	SCHEDULES
5.	LOCATION MAPS
6.	PROJECT TYPICAL SECTIONS

STANDARDS

STANDARD NO.	DESCRIPTION
000001-07	STANDARD SYMBOLS, ABBREVIATIONS AND PATTERNS
442201-03	CLASS C & D PATCHES
701201-05	LANE CLOSURE, 2L, 2W, DAY ONLY, FOR SPEEDS ≥ 45 MPH
701301-04	LANE CLOSURE, 2L, 2W, SHORT TIME OPERATIONS
701306-04	LANE CLOSURE 2L, 2W, SLOW MOVING OPERATIONS DAY ONLY, FOR SPEEDS ≥ 45 MPH
701901-08	TRAFFIC CONTROL DEVICES

**STATE OF ILLINOIS
DEPARTMENT OF TRANSPORTATION
DIVISION OF HIGHWAYS
DISTRICT 6**

EXAMINED _____ 20 _____

 ENGINEER OF OPERATIONS

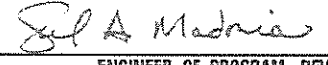
EXAMINED _____ 20 _____

 ENGINEER OF PROJECT IMPLEMENTATION

EXAMINED _____ 20 _____

 ENGINEER OF PROGRAM DEVELOPMENT

FILE NAME =	USER NAME = sharptd	DESIGNED - _____	REVISED - _____	STATE OF ILLINOIS DEPARTMENT OF TRANSPORTATION	INDEX OF SHEETS, STANDARDS GENERAL NOTES, SIGNATURES	F.A.J. RTE.	SECTION	COUNTY	TOTAL SHEETS	SHEET NO.	
S:\EDNTRMAINT_CAD\72HD1 - FAU 8012 IDLO	US 361-PATCHING-SANGAMON CO.CURRAN\PLANS\	DRAWN - 2-gennato	REVISED - _____			8012	(211 PP. 1-5	SANGAMON	6	2	
	PLOT SCALE = 40.0000 / in.	CHECKED - _____	REVISED - _____			CONTRACT NO. 72M01					
Default	PLOT DATE = 3/24/2020	DATE - _____	REVISED - _____			[ILLINOIS] FED. AID PROJECT					

CLASS C PATCHES, 9 INCH		
	TY II (S.Y.)	TY III (S.Y.)
E.B.	125.0	22.5
W.B.	125.0	22.5
TOTAL	250.0	45.0

DIAMOND GRINDING AND SURFACE TESTING BUMPS	
STATION	SQ FT
222+30.00	14.7
224+40.00	14.7
225+40.00	14.7
226+00.00	14.7
226+40.00	14.7
227+20.00	14.7
227+20.00	14.7
228+30.00	14.7
228+50.00	14.7
231+50.00	14.7
232+60.00	14.7
233+40.00	14.7
236+60.00	14.7
241+30.00	14.7
246+90.00	14.7
248+50.00	14.7
249+40.00	14.7
252+40.00	14.7
255+20.00	14.7
255+90.00	14.7
257+50.00	14.7
260+90.00	14.7
264+30.00	14.7
269+70.00	14.7
270+90.00	14.7
272+20.00	14.7
281+00.00	14.7
281+50.00	14.7
282+20.00	14.7
282+70.00	14.7
283+10.00	14.7
283+20.00	14.7
284+30.00	14.7
289+80.00	14.7
298+30.00	14.7
302+60.00	14.7
304+30.00	14.7
306+00.00	14.7
307+60.00	14.7
308+70.00	14.7
322+80.00	14.7
328+70.00	14.7
TOTAL	616.0



START PROJECT
STA. 215+50.00

END PROJECT
STA. 347+80.00

FILE NAME = S:\CONTRMINT_CAD\72M01 - FAU 8012 10LO	USER NAME = shorptd	DESIGNED -	REVISED -	STATE OF ILLINOIS DEPARTMENT OF TRANSPORTATION	PROJECT LOCATION			F.A.U. RTE.	SECTION	COUNTY	TOTAL SHEETS	SHEET NO.
	US 36-PATCHING-SANGAMON CD\CURRAN\PLANS\	DRAWN-5-locations.dgn	REVISED -					8012	(2) PP. 1-5	SANGAMON	6	5
Default	PLLOT SCALE = 3.0000' / 1"	CHECKED -	REVISED -		SCALE:	SHEET 1	OF 2 SHEETS	STA.	TO STA.	CONTRACT NO. 72M01		
	PLLOT DATE = 3/24/2020	DATE -	REVISED -		ILLINOIS FED. AID PROJECT							

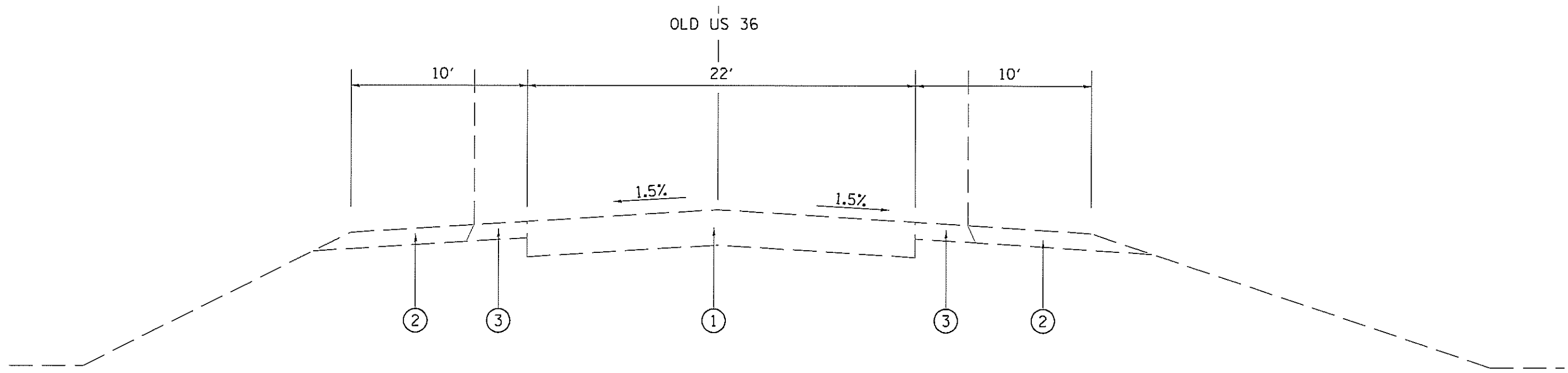

EXISTING TYPICAL

STA. 215+50.00 TO STA. 347+80.00

- ① EXISTING PCC PAVEMENT, 9"
- ② EXISTING AGGREGATE SHOULDERS
- ③ EXISTING HOT-MIX ASPHALT SHOULDERS, 8"

MODEL: I:\model\...
 FILE: 8012_001_010_115_015_016_017_018_019_020_021_022_023_024_025_026_027_028_029_030_031_032_033_034_035_036_037_038_039_040_041_042_043_044_045_046_047_048_049_050_051_052_053_054_055_056_057_058_059_060_061_062_063_064_065_066_067_068_069_070_071_072_073_074_075_076_077_078_079_080_081_082_083_084_085_086_087_088_089_090_091_092_093_094_095_096_097_098_099_100_101_102_103_104_105_106_107_108_109_110_111_112_113_114_115_116_117_118_119_120_121_122_123_124_125_126_127_128_129_130_131_132_133_134_135_136_137_138_139_140_141_142_143_144_145_146_147_148_149_150_151_152_153_154_155_156_157_158_159_160_161_162_163_164_165_166_167_168_169_170_171_172_173_174_175_176_177_178_179_180_181_182_183_184_185_186_187_188_189_190_191_192_193_194_195_196_197_198_199_200_201_202_203_204_205_206_207_208_209_210_211_212_213_214_215_216_217_218_219_220_221_222_223_224_225_226_227_228_229_230_231_232_233_234_235_236_237_238_239_240_241_242_243_244_245_246_247_248_249_250_251_252_253_254_255_256_257_258_259_260_261_262_263_264_265_266_267_268_269_270_271_272_273_274_275_276_277_278_279_280_281_282_283_284_285_286_287_288_289_290_291_292_293_294_295_296_297_298_299_300_301_302_303_304_305_306_307_308_309_310_311_312_313_314_315_316_317_318_319_320_321_322_323_324_325_326_327_328_329_330_331_332_333_334_335_336_337_338_339_340_341_342_343_344_345_346_347_348_349_350_351_352_353_354_355_356_357_358_359_360_361_362_363_364_365_366_367_368_369_370_371_372_373_374_375_376_377_378_379_380_381_382_383_384_385_386_387_388_389_390_391_392_393_394_395_396_397_398_399_400_401_402_403_404_405_406_407_408_409_410_411_412_413_414_415_416_417_418_419_420_421_422_423_424_425_426_427_428_429_430_431_432_433_434_435_436_437_438_439_440_441_442_443_444_445_446_447_448_449_450_451_452_453_454_455_456_457_458_459_460_461_462_463_464_465_466_467_468_469_470_471_472_473_474_475_476_477_478_479_480_481_482_483_484_485_486_487_488_489_490_491_492_493_494_495_496_497_498_499_500_501_502_503_504_505_506_507_508_509_510_511_512_513_514_515_516_517_518_519_520_521_522_523_524_525_526_527_528_529_530_531_532_533_534_535_536_537_538_539_540_541_542_543_544_545_546_547_548_549_550_551_552_553_554_555_556_557_558_559_560_561_562_563_564_565_566_567_568_569_570_571_572_573_574_575_576_577_578_579_580_581_582_583_584_585_586_587_588_589_590_591_592_593_594_595_596_597_598_599_600_601_602_603_604_605_606_607_608_609_610_611_612_613_614_615_616_617_618_619_620_621_622_623_624_625_626_627_628_629_630_631_632_633_634_635_636_637_638_639_640_641_642_643_644_645_646_647_648_649_650_651_652_653_654_655_656_657_658_659_660_661_662_663_664_665_666_667_668_669_670_671_672_673_674_675_676_677_678_679_680_681_682_683_684_685_686_687_688_689_690_691_692_693_694_695_696_697_698_699_700_701_702_703_704_705_706_707_708_709_710_711_712_713_714_715_716_717_718_719_720_721_722_723_724_725_726_727_728_729_730_731_732_733_734_735_736_737_738_739_740_741_742_743_744_745_746_747_748_749_750_751_752_753_754_755_756_757_758_759_760_761_762_763_764_765_766_767_768_769_770_771_772_773_774_775_776_777_778_779_780_781_782_783_784_785_786_787_788_789_790_791_792_793_794_795_796_797_798_799_800_801_802_803_804_805_806_807_808_809_810_811_812_813_814_815_816_817_818_819_820_821_822_823_824_825_826_827_828_829_830_831_832_833_834_835_836_837_838_839_840_841_842_843_844_845_846_847_848_849_850_851_852_853_854_855_856_857_858_859_860_861_862_863_864_865_866_867_868_869_870_871_872_873_874_875_876_877_878_879_880_881_882_883_884_885_886_887_888_889_890_891_892_893_894_895_896_897_898_899_900_901_902_903_904_905_906_907_908_909_910_911_912_913_914_915_916_917_918_919_920_921_922_923_924_925_926_927_928_929_930_931_932_933_934_935_936_937_938_939_940_941_942_943_944_945_946_947_948_949_950_951_952_953_954_955_956_957_958_959_960_961_962_963_964_965_966_967_968_969_970_971_972_973_974_975_976_977_978_979_980_981_982_983_984_985_986_987_988_989_990_991_992_993_994_995_996_997_998_999_1000

USER NAME = snajprd	DESIGNED -	REVISED -
PLOT SCALE = 5 0000 1/16	DRAWN -	REVISED -
PLOT DATE = 3/24/2020	CHECKED -	REVISED -
	DATE -	REVISED -

**STATE OF ILLINOIS
DEPARTMENT OF TRANSPORTATION**

TYPICAL	
SCALE	SHEET OF SHEETS STA TO STA

F.A.U. RTE	SECTION	COUNTY	TOTAL SHEETS	SHEET NO.
8012	(21) PP, I-5	SANGAMON	6	6
CONTRACT NO. 72H01			ILLINOIS FED. AID PROJECT	