

130

Letting June 12, 2020

Notice to Bidders, Specifications and Proposal



**Contract No. 99645
HAMILTON County
Section 19-00114-00-PP
Various Routes
Project 3TKP-949 ()
District 9 Construction Funds**

Plans Included
Herein

Prepared by

Checked by

F

(Printed by authority of the State of Illinois)



- 1. TIME AND PLACE OF OPENING BIDS.** Electronic bids are to be submitted to the electronic bidding system (iCX-Integrated Contractors Exchange). All bids must be submitted to the iCX system prior to 12:00 p.m. June 12, 2020 at which time the bids will be publicly opened from the iCX SecureVault.
- 2. DESCRIPTION OF WORK.** The proposed improvement is identified and advertised for bids in the Invitation for Bids as:

**Contract No. 99645
HAMILTON County
Section 19-00114-00-PP
Project 3TKP-949 ()
Various Routes
District 9 Construction Funds**

Construct a 20'- 22' wide bituminous service treatment on various county highways.

- 3. INSTRUCTIONS TO BIDDERS.** (a) This Notice, the invitation for bids, proposal and letter of award shall, together with all other documents in accordance with Article 101.09 of the Standard Specifications for Road and Bridge Construction, become part of the contract. Bidders are cautioned to read and examine carefully all documents, to make all required inspections, and to inquire or seek explanation of the same prior to submission of a bid.

(b) State law, and, if the work is to be paid wholly or in part with Federal-aid funds, Federal law requires the bidder to make various certifications as a part of the proposal and contract. By execution and submission of the proposal, the bidder makes the certification contained therein. A false or fraudulent certification shall, in addition to all other remedies provided by law, be a breach of contract and may result in termination of the contract.
- 4. AWARD CRITERIA AND REJECTION OF BIDS.** This contract will be awarded to the lowest responsive and responsible bidder considering conformity with the terms and conditions established by the Department in the rules, Invitation for Bids and contract documents. The issuance of plans and proposal forms for bidding based upon a prequalification rating shall not be the sole determinant of responsibility. The Department reserves the right to determine responsibility at the time of award, to reject any or all proposals, to readvertise the proposed improvement, and to waive technicalities.

By Order of the
Illinois Department of Transportation

Omer Osman,
Acting Secretary

INDEX
FOR
SUPPLEMENTAL SPECIFICATIONS
AND RECURRING SPECIAL PROVISIONS

Adopted January 1, 2020

This index contains a listing of SUPPLEMENTAL SPECIFICATIONS, frequently used RECURRING SPECIAL PROVISIONS, and LOCAL ROADS AND STREETS RECURRING SPECIAL PROVISIONS.

ERRATA Standard Specifications for Road and Bridge Construction (Adopted 4-1-16) (Revised 1-1-20)

SUPPLEMENTAL SPECIFICATIONS

<u>Std. Spec. Sec.</u>	<u>Page No.</u>
106 Control of Materials	1
107 Legal Regulations and Responsibility to Public	2
109 Measurement and Payment	3
205 Embankment	4
403 Bituminous Surface Treatment (Class A-1, A-2, A-3)	5
404 Micro-Surfacing and Slurry Sealing	6
405 Cape Seal	17
406 Hot-Mix Asphalt Binder and Surface Course	27
420 Portland Cement Concrete Pavement	28
424 Portland Cement Concrete Sidewalk	30
442 Pavement Patching	31
502 Excavation for Structures	32
503 Concrete Structures	35
504 Precast Concrete Structures	38
506 Cleaning and Painting New Steel Structures	39
522 Retaining Walls	40
542 Pipe Culverts	41
586 Sand Backfill for Vaulted Abutments	42
602 Catch Basin, Manhole, Inlet, Drainage Structure, and Valve Vault Construction, Adjustment, and Reconstruction	44
603 Adjusting Frames and Grates of Drainage and Utility Structures	45
630 Steel Plate Beam Guardrail	46
631 Traffic Barrier Terminals	49
670 Engineer's Field Office and Laboratory	50
701 Work Zone Traffic Control and Protection	51
704 Temporary Concrete Barrier	53
780 Pavement Striping	55
781 Raised Reflective Pavement Markers	56
888 Pedestrian Push-Button.....	57
1001 Cement	58
1003 Fine Aggregates	59
1004 Coarse Aggregates	60
1006 Metals	63
1020 Portland Cement Concrete	65
1043 Adjusting Rings	67
1050 Poured Joint Sealers	69
1069 Pole and Tower	71
1077 Post and Foundation	72
1096 Pavement Markers	73
1101 General Equipment	74
1102 Hot-Mix Asphalt Equipment	75
1103 Portland Cement Concrete Equipment	77
1105 Pavement Marking Equipment	79
1106 Work Zone Traffic Control Devices	81

RECURRING SPECIAL PROVISIONS

The following RECURRING SPECIAL PROVISIONS indicated by an "X" are applicable to this contract and are included by reference:

<u>CHECK SHEET #</u>		<u>PAGE NO.</u>
1	X Additional State Requirements for Federal-Aid Construction Contracts	83
2	X Subletting of Contracts (Federal-Aid Contracts)	86
3	X EEO	87
4	Specific EEO Responsibilities Non Federal-Aid Contracts	97
5	Required Provisions - State Contracts	102
6	Asbestos Bearing Pad Removal	108
7	Asbestos Waterproofing Membrane and Asbestos HMA Surface Removal	109
8	Temporary Stream Crossings and In-Stream Work Pads	110
9	Construction Layout Stakes Except for Bridges	111
10	Construction Layout Stakes	114
11	Use of Geotextile Fabric for Railroad Crossing	117
12	Subsealing of Concrete Pavements	119
13	Hot-Mix Asphalt Surface Correction	123
14	Pavement and Shoulder Resurfacing	125
15	Patching with Hot-Mix Asphalt Overlay Removal	126
16	Polymer Concrete	128
17	PVC Pipeliner	130
18	Bicycle Racks	131
19	Temporary Portable Bridge Traffic Signals	133
20	Work Zone Public Information Signs	135
21	Nighttime Inspection of Roadway Lighting	136
22	English Substitution of Metric Bolts	137
23	Calcium Chloride Accelerator for Portland Cement Concrete	138
24	Quality Control of Concrete Mixtures at the Plant	139
25	Quality Control/Quality Assurance of Concrete Mixtures	147
26	Digital Terrain Modeling for Earthwork Calculations	163
27	Reserved	165
28	Preventive Maintenance – Bituminous Surface Treatment (A-1)	166
29	Reserved	172
30	Reserved	173
31	Reserved	174
32	Temporary Raised Pavement Markers	175
33	Restoring Bridge Approach Pavements Using High-Density Foam	176
34	Portland Cement Concrete Inlay or Overlay	179
35	Portland Cement Concrete Partial Depth Hot-Mix Asphalt Patching	183
36	Longitudinal Joint and Crack Patching	186

LOCAL ROADS AND STREETS RECURRING SPECIAL PROVISIONS

The following LOCAL ROADS AND STREETS RECURRING SPECIAL PROVISIONS indicated by an "X" are applicable to this contract and are included by reference:

<u>CHECK SHEET #</u>		<u>PAGE NO.</u>
LRS1	Reserved	189
LRS2	Furnished Excavation	190
LRS3	X Work Zone Traffic Control Surveillance	191
LRS4	Flaggers in Work Zones	192
LRS5	Contract Claims	193
LRS6	Bidding Requirements and Conditions for Contract Proposals	194
LRS7	Bidding Requirements and Conditions for Material Proposals	200
LRS8	Reserved	206
LRS9	Bituminous Surface Treatments	207
LRS10	Reserved	208
LRS11	Employment Practices	209
LRS12	Wages of Employees on Public Works	211
LRS13	Selection of Labor	213
LRS14	Paving Brick and Concrete Paver Pavements and Sidewalks	214
LRS15	Partial Payments	217
LRS16	Protests on Local Lettings	218
LRS17	Substance Abuse Prevention Program	219
LRS18	Multigrade Cold Mix Asphalt	220

INDEX OF SPECIAL PROVISIONS

Item	Page Number
REFERENCES	1
DESCRIPTION OF WORK	1
TRAFFIC CONTROL PLAN	1-2
UTILITIES	2
BITUMINOUS SURFACE TREATMENT, (CL A-1)	2-7
PAINT PAVEMENT MARKING-LINE 4"	7-8
INSURANCE	9

BDE SPECIAL PROVISIONS

The following special provisions indicated by an "X" are applicable to this contract. An * indicates a new or revised special provision for the letting.

<u>File Name</u>	<u>Pg.</u>	<u>Special Provision Title</u>	<u>Effective</u>	<u>Revised</u>
* 80099		Accessible Pedestrian Signals (APS)	April 1, 2003	April 1, 2020
80274		Aggregate Subgrade Improvement	April 1, 2012	April 1, 2016
80192		Automated Flagger Assistance Device	Jan. 1, 2008	
80173		Bituminous Materials Cost Adjustments	Nov. 2, 2006	Aug. 1, 2017
80246		Bituminous Surface Treatment with Fog Seal	Jan. 1, 2020	
80241		Bridge Demolition Debris	July 1, 2009	
50261		Building Removal-Case I (Non-Friable and Friable Asbestos)	Sept. 1, 1990	April 1, 2010
50481		Building Removal-Case II (Non-Friable Asbestos)	Sept. 1, 1990	April 1, 2010
50491		Building Removal-Case III (Friable Asbestos)	Sept. 1, 1990	April 1, 2010
50531		Building Removal-Case IV (No Asbestos)	Sept. 1, 1990	April 1, 2010
80425		Cape Seal	Jan. 1, 2020	
80384	10	X Compensable Delay Costs	June 2, 2017	April 1, 2019
80198		Completion Date (via calendar days)	April 1, 2008	
80199		Completion Date (via calendar days) Plus Working Days	April 1, 2008	
80293		Concrete Box Culverts with Skews > 30 Degrees and Design Fills ≤ 5 Feet	April 1, 2012	July 1, 2016
80311		Concrete End Sections for Pipe Culverts	Jan. 1, 2013	April 1, 2016
80277		Concrete Mix Design – Department Provided	Jan. 1, 2012	April 1, 2016
80261		Construction Air Quality – Diesel Retrofit	June 1, 2010	Nov. 1, 2014
80387		Contrast Preformed Plastic Pavement Marking	Nov. 1, 2017	
80029	14	X Disadvantaged Business Enterprise Participation	Sept. 1, 2000	Mar. 2, 2019
80402	24	X Disposal Fees	Nov. 1, 2018	
80378		Dowel Bar Inserter	Jan. 1, 2017	Jan. 1, 2018
80405		Elastomeric Bearings	Jan. 1, 2019	
80421		Electric Service Installation	Jan. 1, 2020	
80415	26	X Emulsified Asphalts	Aug. 1, 2019	
80423		Engineer's Field Office Laboratory	Jan. 1, 2020	
80388	29	X Equipment Parking and Storage	Nov. 1, 2017	
80229		Fuel Cost Adjustment	April 1, 2009	Aug. 1, 2017
80417		Geotechnical Fabric for Pipe Underdrains and French Drains	Nov. 1, 2019	
80420		Geotextile Retaining Walls	Nov. 1, 2019	
80304		Grooving for Recessed Pavement Markings	Nov. 1, 2012	Nov. 1, 2017
80422		High Tension Cable Median Barrier Reflectors	Jan. 1, 2020	
80416		Hot-Mix Asphalt – Binder and Surface Course	July 2, 2019	Nov. 1, 2019
80398		Hot-Mix Asphalt – Longitudinal Joint Sealant	Aug. 1, 2018	Nov. 1, 2019
* 80406		Hot-Mix Asphalt – Mixture Design Verification and Production (Modified for I-FIT Data Collection)	Jan. 1, 2019	Jan. 2, 2020
80347		Hot-Mix Asphalt – Pay for Performance Using Percent Within Limits – Jobsite Sampling	Nov. 1, 2014	July 2, 2019
80383		Hot-Mix Asphalt – Quality Control for Performance	April 1, 2017	July 2, 2019
80411		Luminaires, LED	April 1, 2019	
80393		Manholes, Valve Vaults, and Flat Slab Tops	Jan. 1, 2018	Mar. 1, 2019
80045		Material Transfer Device	June 15, 1999	Aug. 1, 2014
80418		Mechanically Stabilized Earth Retaining Walls	Nov. 1, 2019	
80424		Micro-Surfacing and Slurry Sealing	Jan. 1, 2020	
* 80428	30	X Mobilization	April 1, 2020	
80165		Moisture Cured Urethane Paint System	Nov. 1, 2006	Jan. 1, 2010
80412		Obstruction Warning Luminaires, LED	Aug. 1, 2019	
80349		Pavement Marking Blackout Tape	Nov. 1, 2014	April 1, 2016
80371		Pavement Marking Removal	July 1, 2016	
80389		Portland Cement Concrete	Nov. 1, 2017	

<u>File Name</u>	<u>Pg.</u>		<u>Special Provision Title</u>	<u>Effective</u>	<u>Revised</u>
80359			Portland Cement Concrete Bridge Deck Curing	April 1, 2015	Nov. 1, 2019
80300			Preformed Plastic Pavement Marking Type D - Inlaid	April 1, 2012	April 1, 2016
34261			Railroad Protective Liability Insurance	Dec. 1, 1986	Jan. 1, 2006
80157			Railroad Protective Liability Insurance (5 and 10)	Jan. 1, 2006	
* 80306			Reclaimed Asphalt Pavement (RAP) and Reclaimed Asphalt Shingles (RAS)	Nov. 1, 2012	Jan. 2, 2020
80407	31	X	Removal and Disposal of Regulated Substances	Jan. 1, 2019	Jan. 1, 2020
* 80419			Silt Fence, Inlet Filters, Ground Stabilization and Riprap Filter Fabric	Nov. 1, 2019	April 1, 2020
80395			Sloped Metal End Section for Pipe Culverts	Jan. 1, 2018	
80340			Speed Display Trailer	April 2, 2014	Jan. 1, 2017
80127			Steel Cost Adjustment	April 2, 2014	Aug. 1, 2017
80408			Steel Plate Beam Guardrail Manufacturing	Jan. 1, 2019	
80413			Structural Timber	Aug. 1, 2019	
80397	42	X	Subcontractor and DBE Payment Reporting	April 2, 2018	
80391	43	X	Subcontractor Mobilization Payments	Nov. 2, 2017	April 1, 2019
80317			Surface Testing of Hot-Mix Asphalt Overlays	Jan. 1, 2013	Aug. 1, 2019
80298			Temporary Pavement Marking	April 1, 2012	April 1, 2017
80403			Traffic Barrier Terminal, Type 1 Special	Nov. 1, 2018	
80409	44	X	Traffic Control Devices – Cones	Jan. 1, 2019	
80410			Traffic Spotters	Jan. 1, 2019	
20338			Training Special Provisions	Oct. 15, 1975	
80318			Traversable Pipe Grate for Concrete End Sections	Jan. 1, 2013	Jan. 1, 2018
* 80429			Ultra-Thin Bonded Wearing Course	April 1, 2020	
80288			Warm Mix Asphalt	Jan. 1, 2012	April 1, 2016
80302	45	X	Weekly DBE Trucking Reports	June 2, 2012	April 2, 2015
* 80414			Wood Fence Sight Screen	Aug. 1, 2019	April 1, 2020
* 80427			Work Zone Traffic Control Devices	Mar. 2, 2020	
80071	46	X	Working Days	Jan. 1, 2002	

The following special provisions are in the 2020 Supplemental Specifications and Recurring Special Provisions.

<u>File Name</u>	<u>Special Provision Title</u>	<u>New Location(s)</u>	<u>Effective</u>	<u>Revised</u>
80404	Coarse Aggregate Quality for Micro-Surfacing and Cape Seals	Article 1004.01(b)	Jan. 1, 2019	
80392	Lights on Barricades	Articles 701.16, 701.17(c)(2) & 603.07	Jan. 1, 2018	
80336	Longitudinal Joint and Crack Patching	Check Sheet #36	April 1, 2014	April 1, 2016
80400	Mast Arm Assembly and Pole	Article 1077.03(b)	Aug. 1, 2018	
80394	Metal Flared End Section for Pipe Culverts	Articles 542.07(c) and 542.11	Jan. 1, 2018	April 1, 2018
80390	Payments to Subcontractors	Article 109.11	Nov. 2, 2017	

The following special provisions have been deleted from use.

<u>File Name</u>	<u>Special Provision Title</u>	<u>Effective</u>	<u>Revised</u>
80328	Progress Payments	Nov. 2, 2013	

SPECIAL PROVISIONS

The following Special Provisions supplement the "Standard Specifications for Road and Bridge Construction" adopted April 1, 2016, the latest edition of the "Manual on Uniform Traffic Control Devices for Streets and Highways", and the "Manual of Test Procedures for Materials" in effect on the date of invitation for bids, and the Supplemental Specifications and Recurring Special Provisions indicated on the Check Sheet included herein apply to and govern the construction of Project KFIG(965), Section 19-00114-00-PP Hamilton County and in case of conflict with any part or parts of said specifications, the said Special Provisions shall take precedence and shall govern.

DESCRIPTION OF WORK: This work shall consist of the construction of a 20'-22' wide Bituminous Surface Treatment on existing HMA and Oil and Chip pavement for pavement preservation measures.

TRAFFIC CONTROL PLAN: Traffic control shall be in accordance with the applicable sections of the Standard Specifications for Road and bridge Construction, the applicable guidelines contained in this "Illinois Manual on Uniform Traffic Control Devices for Streets and Highways", these special provisions and any special details and Highway Standards contained herein and in the plans.

Special attention is called to Articles 107.09 and 107.14 of the "Standard Specifications for Road and Bridge Construction" and the following: (1) Highway Standards and (2) other special provisions relating to traffic control:

1. Traffic Control Standards 701006, 701301, 701306, 701311, and 701901
2. Traffic will be maintained along the route during construction and both lanes shall be open to traffic overnight.
3. The ADT volume is anticipated to be more than 320 vehicles within the construction area.
4. Standard 701006 shall apply for operations when the Contractor's vehicles, equipment or men, are entirely off the edge of the pavement.
5. Standard 701301 shall apply when the Contractor is performing short—term operations.
6. Standard 701306 shall apply when any portion of a Contractor's moving day operations, including vehicles, equipment or men encroach on the pavement. Typical applications are when the Contractor is involved with bituminous resurfacing operations on the pavement and adjacent entrances and public roads, placing of aggregate or bituminous surface on entrances and public road

approaches. At no time shall signs be placed at a distance greater than the item of work will cover in 1/2 day and the traffic control signs shall be relocated at least once each day to maintain protection. During resurfacing of the pavement at side road intersections, the Contractor shall provide a flagger for the side road traffic until the operation has passed through the intersection. No additional compensation shall be allowed for an additional flagger.

7. Contractor shall post the roadway with "LOOSE GRAVEL" and SPEED LIMIT 35" signs in accordance with applicable articles of Division 700 of the Standard Specifications. These signs shall be placed at the start of the work, near intersecting roadways and then at an average spacing of 0.5 mi (0.8 km). The signs may be removed as soon as the sweeping operation has been completed.

Basis of Payment: The cost of work, excluding all other standards listed, shall include all labor, materials, transportation, handling, and incidental work necessary to furnish, install, maintain and remove all traffic control devices as indicated on the plan, in these Special Provisions and as directed by the Engineer, and shall be considered incidental to the contract and no additional compensation will be allowed. Standard 701306 shall be paid for at the contract unit price per LUMP SUM for TRAFFIC CONTROL AND PROTECTION STANDARD 701306.

The Engineer will determine the required Traffic Control for any operation not covered above.

UTILITIES: It shall be the Contractor's responsibility to contact all the utilities affecting the Project prior to construction.

BITUMINOUS SURFACE TREATMENT, (CL A-1)

HFP

DESCRIPTION. This work shall consist of the application of single course bituminous surface treatments (A-I) to seal existing surfaces.

The work shall meet the requirements of Article 403 of the previously mentioned Standard Specifications except that the preparation of the existing surfaces will be performed by the Local Agency.

MATERIALS. Materials shall meet the requirements of Articles 1004 and 1032 of the Standard Specifications. The Bituminous Materials (Cover and Seal Coats) shall be HFP

oil. The Seal Coat Aggregate shall be CA 16 with the requirements for Class C quality coarse aggregate.

EQUIPMENT. Equipment shall be according to the following Articles/Sections of the Standard Specifications.

Item	Article/Section
(a) Self-Propelled Pneumatic-Tired Roller (Note 1)	1101.01
(b) Mechanical Sweeper (Note 2)	1101.03
(c) Aggregate Spreaders (Note 3)	1102.04
(d) Pressure Distributor (Note 4)	1102.05
(e) Heating Equipment.....	1102.07

Note 1. There shall be a minimum of two rollers, with the final number of rollers determined by the rollers' abilities to maintain proper spacing with the aggregate spreader as directed by the Engineer.

Note 2. The mechanical sweeper shall be power driven and self-propelled with the broom located between the axles. The mechanical sweeper shall not use a cantilever-mounted broom and the broom rotation shall not be operated by forward movement.

Note 3. The aggregate spreader shall be a self-propelled mechanical type with the receiving hopper in the rear and shall pull the aggregate truck. The spreader shall be fitted with an automated system which provides positive interconnected control of the aggregate flow with the forward speed of the spreader. The automated system shall provide uniform and consistent aggregate application at the rate specified.

The Engineer will check the spread roll of the aggregate spreader for straightness each day before operations begin. Should the surface of the spread roll vary off a straight line along its longitudinal dimension by more than 1/16 in. (1.5 mm), the Engineer will inspect the application of aggregate for corrugations and, should these occur, the machine shall be repaired or replaced. The forward speed of the spreader during calibration shall be the same as is to be used during construction. The equipment required for aggregate spreader calibration may consist of several sheets of canvas, each being exactly 1 sq yd (0.8 sq m), and a weight scale. By making several runs at different gate openings over the sheets of canvas, placed to cover the full width applied by the spreader, and carefully measuring the aggregate on each canvas sheet, the gate opening at the pre-

established speed required to apply aggregate at the specified rate may be determined.

Note 4. The pressure distributor shall have a minimum capacity of 3000 gal (11,500 L). The application rate control shall be automated and shall control the application rate regardless of ground speed or spray bar width. The computer shall have the capability of recording the application rate, gallons sprayed, square yards, and feet traveled. The pressure distributor shall be capable of maintaining the asphalt emulsion at the specified temperature. The spray bar nozzles shall produce a uniform triple lap application fan spray, and the shutoff shall be instantaneous, with no dripping. The pressure distributor shall be capable of maintaining the specified application rate within ± 0.015 gal/sq yd (± 0.070 L/sq m) for each load. The spray-bar nozzles shall be turned to make the same angle with the longitudinal axis of the spray bar as recommended by the manufacturer. Application rates shall be determined by the procedures listed in ASTM D 2995, except the sample may be taken on three 8 x 12 in. (200 x 300 mm) metal plates. The three plates shall be positioned as directed by the Engineer.

CONSTRUCTION REQUIREMENTS

Weather Limitations. This work shall be done between May 1 and August 31. Bituminous materials shall be applied only when the temperature of the air in the shade is above 55°F (13°C). No work shall be started if local conditions indicate that rain is imminent.

This work may be done between September 1 and September 15 provided both of the following conditions are met:

- (a) The temperature of the air in the shade is above 70°F (20°C) and the temperature of the surface to which the asphalt will be applied is 70°F (20°C) or above, and
- (b) The National Weather Service forecast for the area does not show any rain or any temperatures below 55°F (13°C) for the day the work is to be done or for the following five days.

Repair and Preparation of Base or Existing Surface. The base or existing surface shall be prepared according to Article 358 of the Standard Specifications. This work will be performed by the Local Agency.

Calibration. The working day prior to starting construction, the pressure distributor and aggregate spreader shall be calibrated and adjusted according to the manufacturer's

recommendations. At least three days prior to starting the work the Contractor shall provide the Engineer with a copy of the manufacturer's recommendations for the equipment to be used. All calibrations and adjustments shall be made in the presence of the Engineer on a level surface at a location approved by the Engineer. The Contractor shall maintain proper calibration and adjustment of the equipment and the Engineer reserves the right to check application rates as the work progresses. Should the equipment fail to consistently apply the specified rates, the work shall be stopped and the Contractor shall recalibrate and readjust the equipment.

Application Rates. Application rate for Bituminous Material shall be 0.20 gal/sq yd (1.3 L/sq m) and the rate of Aggregate shall be 18 lb/sq yd (8 kg/sq m), and shall result in aggregate embedment between 50 and 70 percent behind the roller. The Contractor shall verify the application rates of bituminous material and seal coat aggregate. Any recommendations for the application rates along with the seal coat gradations shall be submitted to the Engineer for approval prior to the start of work. Changes in the application rate of greater than 15 percent shall be resubmitted to the Engineer for approval.

Preparation of Bituminous Material. The temperature of the bituminous material at the time of application shall be such that it will spray uniformly without clogging the spraying nozzles and shall be applied within the temperature ranges of 150 — 190°F (65-90°C)

Preparation of Aggregate. At the contractor's option, the aggregate may be stockpiled near the jobsite according to Article 1003.01 (e) or 1004.01 (e) of the Standard Specifications. The aggregate used shall contain no free moisture. Slightly damp aggregate may be used with the approval of the Engineer. The County Highway Yard on the north side of McLeansboro is available for stockpiling aggregate. If this option is chosen the aggregate shall be weighed after loading, on a certified scale and weight tickets delivered to the job site by the driver as the aggregate is delivered to the job site, for record purposes and for tracking the application rates of the aggregate. Certified scales are available at various locations within the County. Any costs associated with weighing the loaded trucks shall be incidental to the project.

Application of Bituminous Material. The bituminous material shall be applied with a pressure distributor. The entire length of the spray bar shall be set at the height above the surface recommended by the manufacturer for even distribution of the bituminous material.

The distributor shall be operated in a manner such that missing or overlapping of transverse joints will be avoided. To prevent overlapping of successive applications of

bituminous material at transverse joints, heavy paper shall be spread over the previously applied bituminous material and aggregates. In order to obtain a uniform application of the bituminous material, the distributor shall be traveling at the speed required for the specified rate of application when the spray bar crosses the paper.

Adjacent construction, such as concrete pavement, curb and gutter, bridge floors, raised reflective pavement markers, and bridge handrails, shall be protected by shields, covers or other means. If bituminous material is applied to adjacent construction, the Contractor shall remove such material to the satisfaction of the Engineer.

The emulsified asphalt shall not be applied when the wind conditions will inhibit uniform coverage from the fans of asphalt being applied.

Application of Aggregates. The seal coat aggregates shall be spread evenly with an aggregate spreader over the entire surface being treated. When treating one-half of the pavement width at a time, an inside strip of uncovered emulsified asphalt 3 in. (75 mm) wide shall be left during construction of the first half to provide center joint overlap when the second half of the treatment is placed. In all cases, the aggregate shall be applied ahead of the truck or spreader wheels. Hand spreading will be permitted only when approved by the Engineer and, when so permitted, the aggregate shall be spread uniformly and at the approximate rate specified. Any ridges of aggregate left by the aggregate spreader shall be smoothed out with hand brooms immediately behind the aggregate spreader.

All equipment involved in the work shall operate as close to each other as practical. The aggregate shall cover the asphalt emulsion within 30 seconds of applications. At no time shall the aggregate spreader trail the pressure distributor by more than 150 ft (45 m) to ensure proper asphalt/aggregate adhesion.

Each aggregate truck shall be equipped with a suitable hitch for connection to the aggregate spreader while unloading. The trucks shall avoid contact between the truck body or bed and the aggregate spreader. The body or bed of the truck shall be modified, if necessary, to empty cleanly and completely into the receiving hopper of the aggregate spreader. No aggregate shall be allowed to spill onto the road surface when the truck is emptying into this hopper.

The aggregate shall be rolled following spreading. A maximum time of five minutes will be allowed between the spreading of aggregate and completion of the initial rolling of the aggregate. The rollers will proceed in a longitudinal direction at a speed less than or equal to 5 mph (8 km/h). Each roller will travel over the aggregate a minimum of two times. The entire surface shall be rolled immediately with a self-propelled pneumatic-

tired roller. Rolling shall proceed in a longitudinal direction beginning at the edges and progressing toward the center, overlapping on successive trips by at least 1/2 the width of the roller. The aggregate shall then be rolled with a separate pneumatic-tired roller until the aggregate is properly seated in the bituminous material.

The Contractor shall use the appropriate sweeping equipment to perform an initial sweeping after a minimum of two hours curing and not less than one hour before sunset on the day the bituminous surface treatment is placed. The initial sweeping shall remove excess aggregate by lightly sweeping each pavement lane. The sweeping shall be sufficient to prevent migration of loose aggregate back onto any part of the pavement.

The Contractor shall sweep the pavement surface as needed to remove excess aggregate.

Opening to Traffic. The road shall be opened to traffic according to Article 701.17(c)(4) of the Standard Specifications.

DELIVERY. The material supplier shall coordinate the work with the County Engineer and shall make every effort to begin work within seven (7) days from receiving notification that the existing surfaces are prepared.

METHOD OF MEASUREMENT. The Bituminous Materials shall be measured for payment by the TON and according to the requirements of Article 1032. The Aggregate shall be measured for payment by the TON and as specified in Article 31 1.08 of the Standard Specifications.

BASIS OF PAYMENT. This work will be paid for at the awarded unit price per TON for BITUMINOUS MATERIALS (COVER AND SEAL COATS) and at the awarded unit price per TON for SEAL COAT AGGREGATE which prices shall be payment in full for furnishing, spreading, rolling, and all incidentals necessary to properly complete the work. No payment will be made until proper evidence of state inspection has been received.

PAINT PAVEMENT MARKING-LINE 4"

PAINT PAVEMENT MARKING LINE 4" shall be placed in accordance with Article 780 of the Standard Specifications and the Manual of Uniform Traffic Control Devices for Streets and Highways.

Paint conforming to the following Illinois Department of Transportation Maintenance Specifications will be permitted as alternative to the paint required in Article 1095.02 of the Standard Specifications for Traffic Control Items:

Specifications for Cold-Applied Pavement Marking Paint, White and Yellow (Chlorinated Rubber Type), Serial No. M122-85.

Specifications for Fast-Dry Pavement Marking Paint, White and Yellow (Chlorinated Rubber Type), Serial No. M123-88.

The centerline shall not be offset from the center of the pavement and the edge lines shall be placed as shown on the typical sections in the plans and on Standard 780001. A reference line shall be established to ensure a straight line on the tangent sections and accurate marking on curves. Prior to actual striping operations, the Contractor shall demonstrate the ability of the striping equipment to produce the specified striping patterns, with accurate line lengths, line widths and spacing between adjacent lines.

The Contractor shall install the striping within three calendar days, or as directed by the Engineer, after the completion of the overlay. If the work cannot be completed in the time allowed, the Contractor shall install Short-Term Pavement markings in accordance with Article 703.04 with the following exceptions: "All temporary markings shall be installed within three calendar days, or as directed by the Engineer. The installation and the removal shall be at the Contractor's expense."

The Paint Pavement Markings shall not be placed over the temporary marking tape. Compliance with this Special Provision shall be included in the contract unit price per FOOT for PAINT PAVEMENT MARKING - LINE 4" and no additional compensation will be allowed.

State of Illinois
Department of Transportation
Bureau of Local Roads and Streets

SPECIAL PROVISION
FOR
INSURANCE

Effective: February 1, 2007
Revised: August 1, 2007

All references to Sections or Articles in this specification shall be construed to mean specific Section or Article of the Standard Specifications for Road and Bridge Construction, adopted by the Department of Transportation.

The Contractor shall name the following entities as additional insured under the Contractor's general liability insurance policy in accordance with Article 107.27:

The entities listed above and their officers, employees, and agents shall be indemnified and held harmless in accordance with Article 107.26.

COMPENSABLE DELAY COSTS (BDE)

Effective: June 2, 2017

Revised: April 1, 2019

Revise Article 107.40(b) of the Standard Specifications to read:

“(b) Compensation. Compensation will not be allowed for delays, inconveniences, or damages sustained by the Contractor from conflicts with facilities not meeting the above definition; or if a conflict with a utility in an unanticipated location does not cause a shutdown of the work or a documentable reduction in the rate of progress exceeding the limits set herein. The provisions of Article 104.03 notwithstanding, compensation for delays caused by a utility in an unanticipated location will be paid according to the provisions of this Article governing minor and major delays or reduced rate of production which are defined as follows.

- (1) Minor Delay. A minor delay occurs when the work in conflict with the utility in an unanticipated location is completely stopped for more than two hours, but not to exceed two weeks.
- (2) Major Delay. A major delay occurs when the work in conflict with the utility in an unanticipated location is completely stopped for more than two weeks.
- (3) Reduced Rate of Production Delay. A reduced rate of production delay occurs when the rate of production on the work in conflict with the utility in an unanticipated location decreases by more than 25 percent and lasts longer than seven calendar days.”

Revise Article 107.40(c) of the Standard Specifications to read:

“(c) Payment. Payment for Minor, Major, and Reduced Rate of Production Delays will be made as follows.

- (1) Minor Delay. Labor idled which cannot be used on other work will be paid for according to Article 109.04(b)(1) and (2) for the time between start of the delay and the minimum remaining hours in the work shift required by the prevailing practice in the area.

Equipment idled which cannot be used on other work, and which is authorized to standby on the project site by the Engineer, will be paid for according to Article 109.04(b)(4).

- (2) Major Delay. Labor will be the same as for a minor delay.

Equipment will be the same as for a minor delay, except Contractor-owned equipment will be limited to two weeks plus the cost of move-out to either the

Contractor's yard or another job and the cost to re-mobilize, whichever is less. Rental equipment may be paid for longer than two weeks provided the Contractor presents adequate support to the Department (including lease agreement) to show retaining equipment on the job is the most economical course to follow and in the public interest.

- (3) Reduced Rate of Production Delay. The Contractor will be compensated for the reduced productivity for labor and equipment time in excess of the 25 percent threshold for that portion of the delay in excess of seven calendar days. Determination of compensation will be in accordance with Article 104.02, except labor and material additives will not be permitted.

Payment for escalated material costs, escalated labor costs, extended project overhead, and extended traffic control will be determined according to Article 109.13.”

Revise Article 108.04(b) of the Standard Specifications to read:

“(b) No working day will be charged under the following conditions.

- (1) When adverse weather prevents work on the controlling item.
- (2) When job conditions due to recent weather prevent work on the controlling item.
- (3) When conduct or lack of conduct by the Department or its consultants, representatives, officers, agents, or employees; delay by the Department in making the site available; or delay in furnishing any items required to be furnished to the Contractor by the Department prevents work on the controlling item.
- (4) When delays caused by utility or railroad adjustments prevent work on the controlling item.
- (5) When strikes, lock-outs, extraordinary delays in transportation, or inability to procure critical materials prevent work on the controlling item, as long as these delays are not due to any fault of the Contractor.
- (6) When any condition over which the Contractor has no control prevents work on the controlling item.”

Revise Article 109.09(f) of the Standard Specifications to read:

“(f) Basis of Payment. After resolution of a claim in favor of the Contractor, any adjustment in time required for the work will be made according to Section 108. Any adjustment in the costs to be paid will be made for direct labor, direct materials, direct equipment, direct jobsite overhead, direct offsite overhead, and other direct costs allowed by the resolution. Adjustments in costs will not be made for interest charges, loss of anticipated profit, undocumented loss of efficiency, home office overhead and unabsorbed overhead

other than as allowed by Article 109.13, lost opportunity, preparation of claim expenses and other consequential indirect costs regardless of method of calculation.

The above Basis of Payment is an essential element of the contract and the claim cost recovery of the Contractor shall be so limited.”

Add the following to Section 109 of the Standard Specifications.

“109.13 Payment for Contract Delay. Compensation for escalated material costs, escalated labor costs, extended project overhead, and extended traffic control will be allowed when such costs result from a delay meeting the criteria in the following table.

Contract Type	Cause of Delay	Length of Delay
Working Days	Article 108.04(b)(3) or Article 108.04(b)(4)	No working days have been charged for two consecutive weeks.
Completion Date	Article 108.08(b)(1) or Article 108.08(b)(7)	The Contractor has been granted a minimum two week extension of contract time, according to Article 108.08.

Payment for each of the various costs will be according to the following.

- (a) Escalated Material and/or Labor Costs. When the delay causes work, which would have otherwise been completed, to be done after material and/or labor costs have increased, such increases will be paid. Payment for escalated material costs will be limited to the increased costs substantiated by documentation furnished by the Contractor. Payment for escalated labor costs will be limited to those items in Article 109.04(b)(1) and (2), except the 35 percent and 10 percent additives will not be permitted.
- (b) Extended Project Overhead. For the duration of the delay, payment for extended project overhead will be paid as follows.
 - (1) Direct Jobsite and Offsite Overhead. Payment for documented direct jobsite overhead and documented direct offsite overhead, including onsite supervisory and administrative personnel, will be allowed according to the following table.

Original Contract Amount	Supervisory and Administrative Personnel
Up to \$5,000,000	One Project Superintendent
Over \$ 5,000,000 - up to \$25,000,000	One Project Manager, One Project Superintendent or Engineer, and One Clerk
Over \$25,000,000 - up to \$50,000,000	One Project Manager, One Project Superintendent, One Engineer, and

	One Clerk
Over \$50,000,000	One Project Manager, Two Project Superintendents, One Engineer, and One Clerk

(2) Home Office and Unabsorbed Overhead. Payment for home office and unabsorbed overhead will be calculated as 8 percent of the total delay cost.

(c) Extended Traffic Control. Traffic control required for an extended period of time due to the delay will be paid for according to Article 109.04.

When an extended traffic control adjustment is paid under this provision, an adjusted unit price as provided for in Article 701.20(a) for increase or decrease in the value of work by more than ten percent will not be paid.

Upon payment for a contract delay under this provision, the Contractor shall assign subrogation rights to the Department for the Department's efforts of recovery from any other party for monies paid by the Department as a result of any claim under this provision. The Contractor shall fully cooperate with the Department in its efforts to recover from another party any money paid to the Contractor for delay damages under this provision."

80384

DISADVANTAGED BUSINESS ENTERPRISE PARTICIPATION (DBE)

Effective: September 1, 2000

Revised: March 2, 2019

FEDERAL OBLIGATION. The Department of Transportation, as a recipient of federal financial assistance, is required to take all necessary and reasonable steps to ensure nondiscrimination in the award and administration of contracts. Consequently, the federal regulatory provisions of 49 CFR Part 26 apply to this contract concerning the utilization of disadvantaged business enterprises. For the purposes of this Special Provision, a disadvantaged business enterprise (DBE) means a business certified by the Department in accordance with the requirements of 49 CFR Part 26 and listed in the Illinois Unified Certification Program (IL UCP) DBE Directory.

STATE OBLIGATION. This Special Provision will also be used by the Department to satisfy the requirements of the Business Enterprise for Minorities, Females, and Persons with Disabilities Act, 30 ILCS 575. When this Special Provision is used to satisfy state law requirements on 100 percent state-funded contracts, the federal government has no involvement in such contracts (not a federal-aid contract) and no responsibility to oversee the implementation of this Special Provision by the Department on those contracts. DBE participation on 100 percent state-funded contracts will not be credited toward fulfilling the Department's annual overall DBE goal required by the US Department of Transportation to comply with the federal DBE program requirements.

CONTRACTOR ASSURANCE. The Contractor makes the following assurance and agrees to include the assurance in each subcontract the Contractor signs with a subcontractor.

The Contractor, subrecipient, or subcontractor shall not discriminate on the basis of race, color, national origin, or sex in the performance of this contract. The Contractor shall carry out applicable requirements of 49 CFR Part 26 in the award and administration of contracts funded in whole or in part with federal or state funds. Failure by the Contractor to carry out these requirements is a material breach of this contract, which may result in the termination of this contract or such other remedy as the recipient deems appropriate, which may include, but is not limited to:

- (a) Withholding progress payments;
- (b) Assessing sanctions;
- (c) Liquidated damages; and/or
- (d) Disqualifying the Contractor from future bidding as non-responsible.

OVERALL GOAL SET FOR THE DEPARTMENT. As a requirement of compliance with 49 CFR Part 26, the Department has set an overall goal for DBE participation in its federally assisted contracts. That goal applies to all federal-aid funds the Department will expend in its federally assisted contracts for the subject reporting fiscal year. The Department is required to make a

good faith effort to achieve the overall goal. The dollar amount paid to all approved DBE companies performing work called for in this contract is eligible to be credited toward fulfillment of the Department's overall goal.

CONTRACT GOAL TO BE ACHIEVED BY THE CONTRACTOR. This contract includes a specific DBE utilization goal established by the Department. The goal has been included because the Department has determined the work of this contract has subcontracting opportunities that may be suitable for performance by DBE companies. The determination is based on an assessment of the type of work, the location of the work, and the availability of DBE companies to do a part of the work. The assessment indicates, in the absence of unlawful discrimination and in an arena of fair and open competition, DBE companies can be expected to perform 0.00 % of the work. This percentage is set as the DBE participation goal for this contract. Consequently, in addition to the other award criteria established for this contract, the Department will only award this contract to a bidder who makes a good faith effort to meet this goal of DBE participation in the performance of the work. A bidder makes a good faith effort for award consideration if either of the following is done in accordance with the procedures set for in this Special Provision:

- (a) The bidder documents enough DBE participation has been obtained to meet the goal or,
- (b) The bidder documents a good faith effort has been made to meet the goal, even though the effort did not succeed in obtaining enough DBE participation to meet the goal.

DBE LOCATOR REFERENCES. Bidders shall consult the IL UCP DBE Directory as a reference source for DBE-certified companies. In addition, the Department maintains a letting and item specific DBE locator information system whereby DBE companies can register their interest in providing quotes on particular bid items advertised for letting. Information concerning DBE companies willing to quote work for particular contracts may be obtained by contacting the Department's Bureau of Small Business Enterprises at telephone number (217) 785-4611, or by visiting the Department's website at:

<http://www.idot.illinois.gov/doing-business/certifications/disadvantaged-business-enterprise-certification/il-ucp-directory/index>.

BIDDING PROCEDURES. Compliance with this Special Provision is a material bidding requirement and failure of the bidder to comply will render the bid not responsive.

The bidder shall submit a DBE Utilization Plan (form SBE 2026), and a DBE Participation Statement (form SBE 2025) for each DBE company proposed for the performance of work to achieve the contract goal, with the bid. If the Utilization Plan indicates the contract goal will not be met, documentation of good faith efforts shall also be submitted. The documentation of good faith efforts must include copies of each DBE and non-DBE subcontractor quote submitted to the bidder when a non-DBE subcontractor is selected over a DBE for work on the contract. The required forms and documentation must be submitted as a single .pdf file using the "Integrated Contractor Exchange (iCX)" application within the Department's "EBids System".

The Department will not accept a Utilization Plan if it does not meet the bidding procedures set forth herein and the bid will be declared not responsive. In the event the bid is declared not responsive, the Department may elect to cause the forfeiture of the penal sum of the bidder's proposal guaranty and may deny authorization to bid the project if re-advertised for bids.

GOOD FAITH EFFORT PROCEDURES. The contract will not be awarded until the Utilization Plan is approved. All information submitted by the bidder must be complete, accurate and adequately document enough DBE participation has been obtained or document the good faith efforts of the bidder, in the event enough DBE participation has not been obtained, before the Department will commit to the performance of the contract by the bidder. The Utilization Plan will be approved by the Department if the Utilization Plan documents sufficient commercially useful DBE work to meet the contract goal or the bidder submits sufficient documentation of a good faith effort to meet the contract goal pursuant to 49 CFR Part 26, Appendix A. This means the bidder must show that all necessary and reasonable steps were taken to achieve the contract goal. Necessary and reasonable steps are those which, by their scope, intensity and appropriateness to the objective, could reasonably be expected to obtain sufficient DBE participation, even if they were not successful. The Department will consider the quality, quantity, and intensity of the kinds of efforts the bidder has made. Mere *pro forma* efforts, in other words efforts done as a matter of form, are not good faith efforts; rather, the bidder is expected to have taken genuine efforts that would be reasonably expected of a bidder actively and aggressively trying to obtain DBE participation sufficient to meet the contract goal.

- (a) The following is a list of types of action that the Department will consider as part of the evaluation of the bidder's good faith efforts to obtain participation. These listed factors are not intended to be a mandatory checklist and are not intended to be exhaustive. Other factors or efforts brought to the attention of the Department may be relevant in appropriate cases and will be considered by the Department.
 - (1) Soliciting through all reasonable and available means (e.g. attendance at pre-bid meetings, advertising and/or written notices) the interest of all certified DBE companies that have the capability to perform the work of the contract. The bidder must solicit this interest within sufficient time to allow the DBE companies to respond to the solicitation. The bidder must determine with certainty if the DBE companies are interested by taking appropriate steps to follow up initial solicitations.
 - (2) Selecting portions of the work to be performed by DBE companies in order to increase the likelihood that the DBE goals will be achieved. This includes, where appropriate, breaking out contract work items into economically feasible units to facilitate DBE participation, even when the Contractor might otherwise prefer to perform these work items with its own forces.
 - (3) Providing interested DBE companies with adequate information about the plans, specifications, and requirements of the contract in a timely manner to assist them in responding to a solicitation.

- (4) a. Negotiating in good faith with interested DBE companies. It is the bidder's responsibility to make a portion of the work available to DBE subcontractors and suppliers and to select those portions of the work or material needs consistent with the available DBE subcontractors and suppliers, so as to facilitate DBE participation. Evidence of such negotiation includes the names, addresses, and telephone numbers of DBE companies that were considered; a description of the information provided regarding the plans and specifications for the work selected for subcontracting; and evidence as to why additional agreements could not be reached for DBE companies to perform the work.
 - b. A bidder using good business judgment would consider a number of factors in negotiating with subcontractors, including DBE subcontractors, and would take a firm's price and capabilities as well as contract goals into consideration. However, the fact that there may be some additional costs involved in finding and using DBE companies is not in itself sufficient reason for a bidder's failure to meet the contract DBE goal, as long as such costs are reasonable. Also the ability or desire of a bidder to perform the work of a contract with its own organization does not relieve the bidder of the responsibility to make good faith efforts. Bidders are not, however, required to accept higher quotes from DBE companies if the price difference is excessive or unreasonable. In accordance with the above Bidding Procedures, the documentation of good faith efforts must include copies of each DBE and non-DBE subcontractor quote submitted to the bidder when a non-DBE subcontractor was selected over a DBE for work on the contract.
- (5) Not rejecting DBE companies as being unqualified without sound reasons based on a thorough investigation of their capabilities. The bidder's standing within its industry, membership in specific groups, organizations, or associations and political or social affiliations (for example union vs. non-union employee status) are not legitimate causes for the rejection or non-solicitation of bids in the bidder's efforts to meet the project goal.
 - (6) Making efforts to assist interested DBE companies in obtaining bonding, lines of credit, or insurance as required by the recipient or Contractor.
 - (7) Making efforts to assist interested DBE companies in obtaining necessary equipment, supplies, materials, or related assistance or services.
 - (8) Effectively using the services of available minority/women community organizations; minority/women contractors' groups; local, state, and federal minority/women business assistance offices; and other organizations as allowed on a case-by-case basis to provide assistance in the recruitment and placement of DBE companies.
- (b) If the Department determines the bidder has made a good faith effort to secure the work commitment of DBE companies to meet the contract goal, the Department will award the contract provided it is otherwise eligible for award. If the Department determines the

bidder has failed to meet the requirements of this Special Provision or that a good faith effort has not been made, the Department will notify the responsible company official designated in the Utilization Plan that the bid is not responsive. The notification will also include a statement of reasons for the adverse determination. If the Utilization Plan is not approved because it is deficient as a technical matter, unless waived by the Department, the bidder will be notified and will be allowed no more than a five calendar day period to cure the deficiency.

- (c) The bidder may request administrative reconsideration of an adverse determination by emailing the Department at "DOT.DBE.UP@illinois.gov" within the five calendar days after the receipt of the notification of the determination. The determination shall become final if a request is not made on or before the fifth calendar day. A request may provide additional written documentation or argument concerning the issues raised in the determination statement of reasons, provided the documentation and arguments address efforts made prior to submitting the bid. The request will be reviewed by the Department's Reconsideration Officer. The Reconsideration Officer will extend an opportunity to the bidder to meet in person to consider all issues of documentation and whether the bidder made a good faith effort to meet the goal. After the review by the Reconsideration Officer, the bidder will be sent a written decision within ten working days after receipt of the request for reconsideration, explaining the basis for finding that the bidder did or did not meet the goal or make adequate good faith efforts to do so. A final decision by the Reconsideration Officer that a good faith effort was made shall approve the Utilization Plan submitted by the bidder and shall clear the contract for award. A final decision that a good faith effort was not made shall render the bid not responsive.

CALCULATING DBE PARTICIPATION. The Utilization Plan values represent work anticipated to be performed and paid for upon satisfactory completion. The Department is only able to count toward the achievement of the overall goal and the contract goal the value of payments made for the work actually performed by DBE companies. In addition, a DBE must perform a commercially useful function on the contract to be counted. A commercially useful function is generally performed when the DBE is responsible for the work and is carrying out its responsibilities by actually performing, managing, and supervising the work involved. The Department and Contractor are governed by the provisions of 49 CFR Part 26.55(c) on questions of commercially useful functions as it affects the work. Specific counting guidelines are provided in 49 CFR Part 26.55, the provisions of which govern over the summary contained herein.

- (a) DBE as the Contractor: 100 percent goal credit for that portion of the work performed by the DBE's own forces, including the cost of materials and supplies. Work that a DBE subcontracts to a non-DBE does not count toward the DBE goals.
- (b) DBE as a joint venture Contractor: 100 percent goal credit for that portion of the total dollar value of the contract equal to the distinct, clearly defined portion of the work performed by the DBE's own forces.

- (c) DBE as a subcontractor: 100 percent goal credit for the work of the subcontract performed by the DBE's own forces, including the cost of materials and supplies, excluding the purchase of materials and supplies or the lease of equipment by the DBE subcontractor from the Contractor or its affiliates. Work that a DBE subcontractor in turn subcontracts to a non-DBE does not count toward the DBE goal.
- (d) DBE as a trucker: 100 percent goal credit for trucking participation provided the DBE is responsible for the management and supervision of the entire trucking operation for which it is responsible. At least one truck owned, operated, licensed, and insured by the DBE must be used on the contract. Credit will be given for the following:
 - (1) The DBE may lease trucks from another DBE firm, including an owner-operator who is certified as a DBE. The DBE who leases trucks from another DBE receives credit for the total value of the transportation services the lessee DBE provides on the contract.
 - (2) The DBE may also lease trucks from a non-DBE firm, including from an owner-operator. The DBE who leases trucks from a non-DBE is entitled to credit only for the fee or commission is receives as a result of the lease arrangement.
- (e) DBE as a material supplier:
 - (1) 60 percent goal credit for the cost of the materials or supplies purchased from a DBE regular dealer.
 - (2) 100 percent goal credit for the cost of materials of supplies obtained from a DBE manufacturer.
 - (3) 100 percent credit for the value of reasonable fees and commissions for the procurement of materials and supplies if not a DBE regular dealer or DBE manufacturer.

CONTRACT COMPLIANCE. Compliance with this Special Provision is an essential part of the contract. The Department is prohibited by federal regulations from crediting the participation of a DBE included in the Utilization Plan toward either the contract goal or the Department's overall goal until the amount to be applied toward the goals has been paid to the DBE. The following administrative procedures and remedies govern the compliance by the Contractor with the contractual obligations established by the Utilization Plan. After approval of the Utilization Plan and award of the contract, the Utilization Plan and individual DBE Participation Statements become part of the contract. If the Contractor did not succeed in obtaining enough DBE participation to achieve the advertised contract goal, and the Utilization Plan was approved and contract awarded based upon a determination of good faith, the total dollar value of DBE work calculated in the approved Utilization Plan as a percentage of the awarded contract value shall become the amended contract goal. All work indicated for performance by an approved DBE shall be performed, managed, and supervised by the DBE executing the DBE Participation Commitment Statement.

- (a) NO AMENDMENT. No amendment to the Utilization Plan may be made without prior written approval from the Department's Bureau of Small Business Enterprises. All requests for amendment to the Utilization Plan shall be emailed to the Department at DOT.DBE.UP@illinois.gov.
- (b) CHANGES TO WORK. Any deviation from the DBE condition-of-award or contract plans, specifications, or special provisions must be approved, in writing, by the Department as provided elsewhere in the Contract. The Contractor shall notify affected DBEs in writing of any changes in the scope of work which result in a reduction in the dollar amount condition-of-award to the contract. Where the revision includes work committed to a new DBE subcontractor, not previously involved in the project, then a Request for Approval of Subcontractor, Department form BC 260A or AER 260A, must be signed and submitted. If the commitment of work is in the form of additional tasks assigned to an existing subcontract, a new Request for Approval of Subcontractor will not be required. However, the Contractor must document efforts to assure the existing DBE subcontractor is capable of performing the additional work and has agreed in writing to the change.
- (c) SUBCONTRACT. The Contractor must provide copies of DBE subcontracts to the Department upon request. Subcontractors shall ensure that all lower tier subcontracts or agreements with DBEs to supply labor or materials be performed in accordance with this Special Provision.
- (d) ALTERNATIVE WORK METHODS. In addition to the above requirements for reductions in the condition of award, additional requirements apply to the two cases of Contractor-initiated work substitution proposals. Where the contract allows alternate work methods which serve to delete or create underruns in condition of award DBE work, and the Contractor selects that alternate method or, where the Contractor proposes a substitute work method or material that serves to diminish or delete work committed to a DBE and replace it with other work, then the Contractor must demonstrate one of the following:
- (1) The replacement work will be performed by the same DBE (as long as the DBE is certified in the respective item of work) in a modification of the condition of award; or
 - (2) The DBE is aware its work will be deleted or will experience underruns and has agreed in writing to the change. If this occurs, the Contractor shall substitute other work of equivalent value to a certified DBE or provide documentation of good faith efforts to do so; or
 - (3) The DBE is not capable of performing the replacement work or has declined to perform the work at a reasonable competitive price. If this occurs, the Contractor shall substitute other work of equivalent value to a certified DBE or provide documentation of good faith efforts to do so.

(e) TERMINATION AND REPLACEMENT PROCEDURES. The Contractor shall not terminate or replace a DBE listed on the approved Utilization Plan, or perform with other forces work designated for a listed DBE except as provided in this Special Provision. The Contractor shall utilize the specific DBEs listed to perform the work and supply the materials for which each is listed unless the Contractor obtains the Department's written consent as provided in subsection (a) of this part. Unless Department consent is provided for termination of a DBE subcontractor, the Contractor shall not be entitled to any payment for work or material unless it is performed or supplied by the DBE in the Utilization Plan.

As stated above, the Contractor shall not terminate or replace a DBE subcontractor listed in the approved Utilization Plan without prior written consent. This includes, but is not limited to, instances in which the Contractor seeks to perform work originally designated for a DBE subcontractor with its own forces or those of an affiliate, a non-DBE firm, or with another DBE firm. Written consent will be granted only if the Bureau of Small Business Enterprises agrees, for reasons stated in its concurrence document, that the Contractor has good cause to terminate or replace the DBE firm. Before transmitting to the Bureau of Small Business Enterprises any request to terminate and/or substitute a DBE subcontractor, the Contractor shall give notice in writing to the DBE subcontractor, with a copy to the Bureau, of its intent to request to terminate and/or substitute, and the reason for the request. The Contractor shall give the DBE five days to respond to the Contractor's notice. The DBE so notified shall advise the Bureau and the Contractor of the reasons, if any, why it objects to the proposed termination of its subcontract and why the Bureau should not approve the Contractor's action. If required in a particular case as a matter of public necessity, the Bureau may provide a response period shorter than five days.

For purposes of this paragraph, good cause includes the following circumstances:

- (1) The listed DBE subcontractor fails or refuses to execute a written contract;
- (2) The listed DBE subcontractor fails or refuses to perform the work of its subcontract in a way consistent with normal industry standards. Provided, however, that good cause does not exist if the failure or refusal of the DBE subcontractor to perform its work on the subcontract results from the bad faith or discriminatory action of the Contractor;
- (3) The listed DBE subcontractor fails or refuses to meet the Contractor's reasonable, nondiscriminatory bond requirements;
- (4) The listed DBE subcontractor becomes bankrupt, insolvent, or exhibits credit unworthiness;
- (5) The listed DBE subcontractor is ineligible to work on public works projects because of suspension and debarment proceedings pursuant 2 CFR Parts 180, 215 and 1200 or applicable state law.

- (6) The Contractor has determined the listed DBE subcontractor is not a responsible contractor;
- (7) The listed DBE subcontractor voluntarily withdraws from the projects and provides written notice to the Contractor of its withdrawal;
- (8) The listed DBE is ineligible to receive DBE credit for the type of work required;
- (9) A DBE owner dies or becomes disabled with the result that the listed DBE subcontractor is unable to complete its work on the contract;
- (10) Other documented good cause that compels the termination of the DBE subcontractor. Provided, that good cause does not exist if the Contractor seeks to terminate a DBE it relied upon to obtain the contract so that the Contractor can self-perform the work for which the DBE contractor was engaged or so that the Contractor can substitute another DBE or non-DBE contractor after contract award.

When a DBE is terminated or fails to complete its work on the Contract for any reason, the Contractor shall make a good faith effort to find another DBE to substitute for the original DBE to perform at least the same amount of work under the contract as the terminated DBE to the extent needed to meet the established Contract goal. The good faith efforts shall be documented by the Contractor. If the Department requests documentation under this provision, the Contractor shall submit the documentation within seven days, which may be extended for an additional seven days if necessary at the request of the Contractor. The Department will provide a written determination to the Contractor stating whether or not good faith efforts have been demonstrated.

- (f) FINAL PAYMENT. After the performance of the final item of work or delivery of material by a DBE and final payment therefore to the DBE by the Contractor, but not later than 30 calendar days after payment has been made by the Department to the Contractor for such work or material, the Contractor shall submit a DBE Payment Agreement on Department form SBE 2115 to the Resident Engineer. If full and final payment has not been made to the DBE, the DBE Payment Agreement shall indicate whether a disagreement as to the payment required exists between the Contractor and the DBE or if the Contractor believes the work has not been satisfactorily completed. If the Contractor does not have the full amount of work indicated in the Utilization Plan performed by the DBE companies indicated in the Utilization Plan and after good faith efforts are reviewed, the Department may deduct from contract payments to the Contractor the amount of the goal not achieved as liquidated and ascertained damages. The Contractor may request an administrative reconsideration of any amount deducted as damages pursuant to subsection (h) of this part.
- (g) ENFORCEMENT. The Department reserves the right to withhold payment to the Contractor to enforce the provisions of this Special Provision. Final payment shall not be

made on the contract until such time as the Contractor submits sufficient documentation demonstrating achievement of the goal in accordance with this Special Provision or after liquidated damages have been determined and collected.

- (h) RECONSIDERATION. Notwithstanding any other provision of the contract, including but not limited to Article 109.09 of the Standard Specifications, the Contractor may request administrative reconsideration of a decision to deduct the amount of the goal not achieved as liquidated damages. A request to reconsider shall be delivered to the Contract Compliance Section and shall be handled and considered in the same manner as set forth in paragraph (c) of “Good Faith Effort Procedures” of this Special Provision, except a final decision that a good faith effort was not made during contract performance to achieve the goal agreed to in the Utilization Plan shall be the final administrative decision of the Department. The result of the reconsideration process is not administratively appealable to the U.S. Department of Transportation.

80029

DISPOSAL FEES (BDE)

Effective: November 1, 2018

Replace Articles 109.04(b)(5) – 109.04(b)(8) of the Standard Specifications with the following:

- “(5) Disposal Fees. When the extra work performed includes paying for disposal fees at a clean construction and demolition debris facility, an uncontaminated soil fill operation or a landfill, the Contractor shall receive, as administrative costs, an amount equal to five percent of the first \$10,000 and one percent of any amount over \$10,000 of the total approved costs of such fees.
- (6) Miscellaneous. No additional allowance will be made for general superintendence, the use of small tools, or other costs for which no specific allowance is herein provided.
- (7) Statements. No payment will be made for work performed on a force account basis until the Contractor has furnished the Engineer with itemized statements of the cost of such force account work. Statements shall be accompanied and supported by invoices for all materials used and transportation charges. However, if materials used on the force account work are not specifically purchased for such work but are taken from the Contractor’s stock, then in lieu of the invoices, the Contractor shall furnish an affidavit certifying that such materials were taken from his/her stock, that the quantity claimed was actually used, and that the price and transportation claimed represent the actual cost to the Contractor.

Itemized statements at the cost of force account work shall be detailed as follows.

- a. Name, classification, date, daily hours, total hours, rate, and extension for each laborer and foreman. Payrolls shall be submitted to substantiate actual wages paid if so requested by the Engineer.
 - b. Designation, dates, daily hours, total hours, rental rate, and extension for each unit of machinery and equipment.
 - c. Quantities of materials, prices and extensions.
 - d. Transportation of materials.
 - e. Cost of property damage, liability and workmen’s compensation insurance premiums, unemployment insurance contributions, and social security tax.
- (8) Work Performed by an Approved Subcontractor. When extra work is performed by an approved subcontractor, the Contractor shall receive, as administrative costs, an amount equal to five percent of the total approved costs of such work with the minimum payment being \$100.

- (9) All statements of the cost of force account work shall be furnished to the Engineer not later than 60 days after receipt of the Central Bureau of Construction form "Extra Work Daily Report". If the statement is not received within the specified time frame, all demands for payment for the extra work are waived and the Department is released from any and all such demands. It is the responsibility of the Contractor to ensure that all statements are received within the specified time regardless of the manner or method of delivery."

80402

EMULSIFIED ASPHALTS (BDE)

Effective: August 1, 2019

Revise Article 1032.06 of the Standard Specifications to read:

“1032.06 Emulsified Asphalts. Emulsified asphalts will be accepted according to the current Bureau of Materials Policy Memorandum, “Emulsified Asphalt Acceptance Procedure”. These materials shall be homogeneous and shall show no separation of asphalt after thorough mixing, within 30 days after delivery, provided separation has not been caused by freezing. They shall coat the aggregate being used in the work to the satisfaction of the Engineer and shall be according to the following requirements.

- (a) Anionic Emulsified Asphalt. Anionic emulsified asphalts RS-1, RS-2, HFRS-2, SS-1h, and SS-1 shall be according to AASHTO M 140, except as follows.
 - (1) The cement mixing test will be waived when the emulsion is being used as a tack coat.
 - (2) The Solubility in Trichloroethylene test according to AASHTO T 44 may be run in lieu of Ash Content and shall meet a minimum of 97.5 percent.
- (b) Cationic Emulsified Asphalt. Cationic emulsified asphalts CRS-1, CRS-2, CSS-1h, and CSS-1 shall be according to AASHTO M 208, except as follows.
 - (1) The cement mixing test will be waived when the emulsion is being used as a tack coat.
 - (2) The Solubility in Trichloroethylene test according to AASHTO T 44 may be run in lieu of Ash Content and shall meet a minimum of 97.5 percent.
- (c) High Float Emulsion. High float emulsions HFE-90, HFE-150, and HFE-300 are medium setting and shall be according to the following table.

Test	HFE-90	HFE-150	HFE-300
Viscosity, Saybolt Furol, at 122 °F (50 °C), (AASHTO T 59), SFS ^{1/}	50 min.	50 min.	50 min.
Sieve Test, No. 20 (850 µm), retained on sieve, (AASHTO T 59), %	0.10 max.	0.10 max.	0.10 max.
Storage Stability Test, 1 day, (AASHTO T 59), %	1 max.	1 max.	1 max.
Coating Test (All Grades), (AASHTO T 59), 3 minutes	stone coated thoroughly		
Distillation Test, (AASHTO T 59): Residue from distillation test to 500 °F (260 °C), % Oil distillate by volume, %	65 min. 7 max.	65 min. 7 max.	65 min. 7 max.

Characteristics of residue from distillation test to 500 °F (260 °C): Penetration at 77 °F (25 °C), (AASHTO T 49), 100 g, 5 sec, dmm	90-150	150-300	300 min.
Float Test at 140 °F (60 °C), (AASHTO T 50), sec.	1200 min.	1200 min.	1200 min.

1/ The emulsion shall be pumpable.

- (d) Penetrating Emulsified Prime. Penetrating Emulsified Prime (PEP) shall be according to AASHTO T 59, except as follows.

Test	Result
Viscosity, Saybolt Furol, at 77 °F (25 °C), SFS	75 max.
Sieve test, retained on No. 20 (850 µm) sieve, %	0.10 max.
Distillation to 500 °F (260 °C) residue, %	38 min.
Oil distillate by volume, %	4 max.

The PEP shall be tested according to the current Bureau of Materials Illinois Laboratory Test Procedure (ILTP), "Sand Penetration Test of Penetrating Emulsified Prime (PEP)". The time of penetration shall be equal to or less than that of MC-30. The depth of penetration shall be equal to or greater than that of MC-30.

- (e) Delete this subparagraph.
- (f) Polymer Modified Emulsified Asphalt. Polymer modified emulsified asphalts, e.g. SS-1hP, CSS-1hP, CRS-2P (formerly CRSP), CQS-1hP (formerly CSS-1h Latex Modified) and HFRS-2P (formerly HFP) shall be according to AASHTO M 316, except as follows.
- (1) The cement mixing test will be waived when the polymer modified emulsion is being used as a tack coat.
 - (2) CQS-1hP (formerly CSS-1h Latex Modified) emulsion for micro-surfacing treatments shall use latex as the modifier.
 - (3) Upon examination of the storage stability test cylinder after standing undisturbed for 24 hours, the surface shall show minimal to no white, milky colored substance and shall be a homogenous brown color throughout.
 - (4) The distillation for all polymer modified emulsions shall be performed according to AASHTO T 59, except the temperature shall be 374 ± 9 °F (190 ± 5 °C) to be held for a period of 15 minutes and measured using an ASTM 16F (16C) thermometer.
 - (5) The specified temperature for the Elastic Recovery test for all polymer modified emulsions shall be 50.0 ± 1.0 °F (10.0 ± 0.5 °C).

(6) The Solubility in Trichloroethylene test according to AASHTO T 44 may be run in lieu of Ash Content and shall meet a minimum of 97.5 percent.

(g) Non-Tracking Emulsified Asphalt. Non-tracking emulsified asphalt NTEA (formerly SS-1vh) shall be according to the following.

Test	Requirement
Saybolt Viscosity at 77 °F (25 °C), (AASHTO T 59), SFS	20-100
Storage Stability Test, 24 hr, (AASHTO T 59), %	1 max.
Residue by Distillation, 500 ± 10 °F (260 ± 5 °C), or Residue by Evaporation, 325 ± 5 °F (163 ± 3 °C), (AASHTO T 59), %	50 min.
Sieve Test, No. 20 (850 µm), (AASHTO T 59), %	0.3 max.
Tests on Residue from Evaporation	
Penetration at 77 °F (25 °C), 100 g, 5 sec, (AASHTO T 49), dmm	40 max.
Softening Point, (AASHTO T 53), °F (°C)	135 (57) min.
Ash Content, (AASHTO T 111), % ^{1/}	1 max.

1/ The Solubility in Trichloroethylene test according to AASHTO T 44 may be run in lieu of Ash Content and shall meet a minimum of 97.5 percent

The different grades are, in general, used for the following.

Grade	Use
SS-1, SS-1h, RS-1, RS-2, CSS-1, CRS-1, CRS-2, CSS-1h, HFE-90, SS-1hP, CSS-1hP, NTEA (formerly SS-1vh)	Tack Coat
PEP	Prime Coat
RS-2, HFE-90, HFE-150, HFE-300, CRS-2P (formerly CRSP), HFRS-2P (formerly HFP), CRS-2, HFRS-2	Bituminous Surface Treatment
CQS-1hP (formerly CSS-1h Latex Modified)	Micro-Surfacing Slurry Sealing Cape Seal™

80415

EQUIPMENT PARKING AND STORAGE (BDE)

Effective: November 1, 2017

Replace the first paragraph of Article 701.11 of the Standard Specifications with the following.

“701.11 Equipment Parking and Storage. During working hours, all vehicles and/or nonoperating equipment which are parked, two hours or less, shall be parked at least 8 ft (2.5 m) from the open traffic lane. For other periods of time during working and for all nonworking hours, all vehicles, materials, and equipment shall be parked or stored as follows.

- (a) When the project has adequate right-of-way, vehicles, materials, and equipment shall be located a minimum of 30 ft (9 m) from the pavement.
- (b) When adequate right-of-way does not exist, vehicles, materials, and equipment shall be located a minimum of 15 ft (4.5 m) from the edge of any pavement open to traffic.
- (c) Behind temporary concrete barrier, vehicles, materials, and equipment shall be located a minimum of 24 in. (600 mm) behind free standing barrier or a minimum of 6 in. (150 mm) behind barrier that is either pinned or restrained according to Article 704.04. The 24 in. or 6 in. measurement shall be from the base of the non-traffic side of the barrier.
- (d) Behind other man-made or natural barriers meeting the approval of the Engineer.”

80388

MOBILIZATION (BDE)

Effective: April 1, 2020

Replace Articles 671.02(a), (b), and (c) of the Standard Specifications with the following:

“(a) Upon execution of the contract, 90 percent of the pay item will be paid.

(b) When 90 percent of the adjusted contract value is earned, the remaining ten percent of the pay item will be paid along with any amount bid in excess of six percent of the original contract amount.”

80428

REMOVAL AND DISPOSAL OF REGULATED SUBSTANCES (BDE)

Effective: January 1, 2019

Revised: January 1, 2020

Revise Section 669 of the Standard Specifications to read:

“SECTION 669. REMOVAL AND DISPOSAL OF REGULATED SUBSTANCES

669.01 Description. This work shall consist of the transportation and proper disposal of regulated substances. This work shall also consist of the removal, transportation, and proper disposal of underground storage tanks (UST), their contents and associated underground piping to the point where the piping is above the ground, including determining the content types and estimated quantities.

669.02 Equipment. The Contractor shall notify the Engineer of the delivery of all excavation, storage, and transportation equipment to a work area location. The equipment shall comply with OSHA and American Petroleum Institute (API) guidelines and shall be furnished in a clean condition. Clean condition means the equipment does not contain any residual material classified as a non-special waste, non-hazardous special waste, or hazardous waste. Residual materials include, but are not limited to, petroleum products, chemical products, sludges, or any other material present in or on equipment.

Before beginning any associated soil or groundwater management activity, the Contractor shall provide the Engineer with the opportunity to visually inspect and approve the equipment. If the equipment contains any contaminated residual material, decontamination shall be performed on the equipment as appropriate to the regulated substance and degree of contamination present according to OSHA and API guidelines. All cleaning fluids used shall be treated as the contaminant unless laboratory testing proves otherwise.

669.03 Pre-Construction Submittals and Qualifications. Prior to beginning this work, or working in areas with regulated substances, the Contractor shall submit a “Regulated Substances Pre-Construction Plan (RSPCP)” to the Engineer for review and approval using form BDE 2730. The form shall be signed by an Illinois licensed Professional Engineer or Professional Geologist.

As part of the RSPCP, the Contractor(s) or firm(s) performing the work shall meet the following qualifications.

- (a) Regulated Substances Monitoring. Qualification for environmental observation and field screening of regulated substances work and environmental observation of UST removal shall require either pre-qualification in Hazardous Waste by the Department or demonstration of acceptable project experience in remediation and operations for contaminated sites in accordance with applicable Federal, State, or local regulatory requirements using BDE 2730.

Qualification for each individual performing regulated substances monitoring shall require a minimum of one-year of experience in similar activities as those required for the project.

- (b) Underground Storage Tank Removal. Qualification for underground storage tank (UST) removal work shall require licensing and certification with the Office of the State Fire Marshall (OSFM) and possession of all permits required to perform the work. A copy of the permit shall be provided to the Engineer prior to tank removal.

The qualified Contractor(s) or firm(s) shall also document it does not have any current or former ties with any of the properties contained within, adjoining, or potentially affecting the work.

The Engineer will require up to 21 calendar days for review of the RSPCP. The review may involve rejection or revision and resubmittal; in which case, an additional 21 days will be required for each subsequent review. Work shall not commence until the RSPCP has been approved by the Engineer. After approval, the RSPCP shall be revised as necessary to reflect changed conditions in the field and documented using BDE 2730A "Regulated Substances Pre-Construction Plan (RSPCP) Addendum" and submitted to the Engineer for approval.

CONSTRUCTION REQUIREMENTS

669.04 Regulated Substances Monitoring. Regulated substances monitoring includes environmental observation and field screening during regulated substances management activities at the contract specific work areas. As part of the regulated substances monitoring, the monitoring personnel shall perform and document the applicable duties listed on form BDE 2732 "Regulated Substances Monitoring Daily Record (RSMDR)".

- (a) Environmental Observation. Prior to beginning excavation, the Contractor shall mark the limits of the contract specific work areas. Once work begins, the monitoring personnel shall be present on-site continuously during the excavation and loading of material.
- (b) Field Screening. Field screening shall be performed during the excavation and loading of material from the contract specific work areas, except for material classified according to Article 669.05(b)(1) or 669.05(c) where field screening is not required.

Field screening shall be performed with either a photoionization detector (PID) (minimum 10.6eV lamp) or a flame ionization detector (FID), and other equipment as appropriate, to monitor for potential contaminants associated with regulated substances. The PID or FID shall be calibrated on-site, and background level readings taken and recorded daily, and as field and weather conditions change. Field screen readings on the PID or FID in excess of background levels indicates the potential presence of regulated substances requiring handling as a non-special waste, special waste, or hazardous waste. PID or FID readings may be used as the basis of increasing the limits of removal with the approval of the Engineer but shall in no case be used to decrease the limits.

669.05 Regulated Substances Management and Disposal. The management and disposal of soil and/or groundwater containing regulated substances shall be according to the following:

- (a) **Soil Analytical Results Exceed Most Stringent MAC.** When the soil analytical results indicate detected levels exceed the most stringent maximum allowable concentration (MAC) for chemical constituents in soil established pursuant to Subpart F of 35 Ill. Adm. Code 1100.605, the soil shall be managed as follows:
 - (1) When analytical results indicate inorganic chemical constituents exceed the most stringent MAC, but still considered within area background levels by the Engineer, the excavated soil can be utilized within the right-of-way as embankment or fill, when suitable. If the soils cannot be utilized within the right-of-way, they shall be managed and disposed of at a landfill as a non-special waste.
 - (2) When analytical results indicate inorganic chemical constituents exceed the most stringent MAC but do not exceed the MAC for a Metropolitan Statistical Area (MSA) County identified in 35 Ill. Admin. Code 742 Appendix A. Table G, the excavated soil can be utilized within the right-of-way as embankment or fill, when suitable, or managed and disposed of at a clean construction and demolition debris (CCDD) facility or an uncontaminated soil fill operation (USFO) within an MSA County provided the pH of the soil is within the range of 6.25 - 9.0, inclusive.
 - (3) When analytical results indicate chemical constituents exceed the most stringent MAC but do not exceed the MAC for an MSA County excluding Chicago, or the MAC within the Chicago corporate limits, the excavated soil can be utilized within the right-of-way as embankment or fill, when suitable, or managed and disposed of off-site at a CCDD facility or an USFO within an MSA County excluding Chicago or within the Chicago corporate limits provided the pH of the soil is within the range of 6.25 - 9.0, inclusive.
 - (4) When analytical results indicate chemical constituents exceed the most stringent MAC but do not exceed the MAC for an MSA County excluding Chicago, the excavated soil can be utilized within the right-of-way as embankment or fill, when suitable, or managed and disposed of off-site at a CCDD facility or an USFO within an MSA County excluding Chicago provided the pH of the soil is within the range of 6.25 - 9.0, inclusive.
 - (5) When the Engineer determines soil cannot be managed according to Articles 669.05(a)(1) through (a)(4) above and the materials do not contain special waste or hazardous waste, as determined by the Engineer, the soil shall be managed and disposed of at a landfill as a non-special waste.
 - (6) When analytical results indicate soil is hazardous by characteristic or listing pursuant to 35 Ill. Admin. Code 721, contains radiological constituents, or the Engineer otherwise determines the soil cannot be managed according to Articles 669.05(a)(1)

through (a)(5) above, the soil shall be managed and disposed of off-site as a special waste or hazardous waste as applicable.

(b) Soil Analytical Results Do Not Exceed Most Stringent MAC. When the soil analytical results indicate that detected levels do not exceed the most stringent MAC, the excavated soil can be utilized within the right-of-way as embankment or fill, when suitable, or managed and disposed of off-site according to Article 202.03. However, the excavated soil cannot be taken to a CCDD facility or an USFO for any of the following reasons.

(1) The pH of the soil is less than 6.25 or greater than 9.0.

(2) The soil exhibited PID or FID readings in excess of background levels.

(c) Soil Analytical Results Exceed Most Stringent MAC but Do Not Exceed Tiered Approach to Corrective Action Objectives (TACO) Residential. When the soil analytical results indicate that detected levels exceed the most stringent MAC but do not exceed TACO Tier 1 Soil Remediation Objectives for Residential Properties pursuant to 35 Ill. Admin. Code 742 Appendix B Table A, the excavated soil can be utilized within the right-of-way as embankment or fill, when suitable, or managed and disposed of off-site according to Article 202.03. However, the excavated soil cannot be taken to a CCDD facility or an USFO.

(d) Groundwater. When groundwater analytical results indicate the detected levels are above Appendix B, Table E of 35 Ill. Admin. Code 742, the most stringent Tier 1 Groundwater Remediation Objectives for Groundwater Component of the Groundwater Ingestion Route for Class 1 groundwater, the groundwater shall be managed off-site as a special waste or hazardous waste as applicable. Special waste groundwater shall be containerized and trucked to an off-site treatment facility, or may be discharged to a sanitary sewer or combined sewer when permitted by the local sewer authority. Groundwater discharged to a sanitary sewer or combined sewer shall be pre-treated to remove particulates and measured with a calibrated flow meter to comply with applicable discharge limits. A copy of the permit shall be provided to the Engineer prior to discharging groundwater to the sanitary sewer or combined sewer.

Groundwater encountered within trenches may be managed within the trench and allowed to infiltrate back into the ground. If the groundwater cannot be managed within the trench, it may be discharged to a sanitary sewer or combined sewer when permitted by the local sewer authority, or it shall be containerized and trucked to an off-site treatment facility as a special waste or hazardous waste. The Contractor is prohibited from discharging groundwater within the trench through a storm sewer. The Contractor shall install backfill plugs within the area of groundwater contamination.

One backfill plug shall be placed down gradient to the area of groundwater contamination. Backfill plugs shall be installed at intervals not to exceed 50 ft (15 m). Backfill plugs are to be 4 ft (1.2 m) long, measured parallel to the trench, full trench width and depth. Backfill plugs shall not have any fine aggregate bedding or backfill, but shall be entirely cohesive

soil or any class of concrete. The Contractor shall provide test data that the material has a permeability of less than 10^{-7} cm/sec according to ASTM D 5084, Method A or per another test method approved by the Engineer.

The Contractor shall use due care when transferring contaminated material from the area of origin to the transporter. Should releases of contaminated material to the environment occur (i.e., spillage onto the ground, etc.), the Contractor shall clean-up spilled material and place in the appropriate storage containers as previously specified. Clean-up shall include, but not be limited to, sampling beneath the material staging area to determine complete removal of the spilled material.

The Contractor shall provide engineered barriers, when required, and shall include materials sufficient to completely line excavation surfaces, including sloped surfaces, bottoms, and sidewall faces, within the areas designated for protection.

The Contractor shall obtain all documentation including any permits and/or licenses required to transport the material containing regulated substances to the disposal facility. The Contractor shall coordinate with the Engineer on the completion of all documentation. The Contractor shall make all arrangements for collection and analysis of landfill acceptance testing. The Contractor shall coordinate waste disposal approvals with the disposal facility.

The Contractor shall provide the Engineer with all transport-related documentation within two days of transport or receipt of said document(s). For management of special or hazardous waste, the Contractor shall provide the Engineer with documentation that the Contractor is operating with a valid Illinois special waste transporter permit at least two weeks before transporting the first load of contaminated material.

Transportation and disposal of material classified according to Article 669.05(a)(5) or 669.05(a)(6) shall be completed each day so that none of the material remains on-site by the close of business, except when temporary staging has been approved.

Any waste generated as a special or hazardous waste from a non-fixed facility shall be manifested off-site using the Department's county generator number provided by the Bureau of Design and Environment. An authorized representative of the Department shall sign all manifests for the disposal of the contaminated material and confirm the Contractor's transported volume. Any waste generated as a non-special waste may be managed off-site without a manifest, a special waste transporter, or a generator number.

The Contractor shall select a landfill permitted for disposal of the contaminant within the State of Illinois. The Department will review and approve or reject the facility proposed by the Contractor to use as a landfill. The Contractor shall verify whether the selected disposal facility is compliant with those applicable standards as mandated by their permit and whether the disposal facility is presently, has previously been, or has never been, on the United States Environmental Protection Agency (U.S. EPA) National Priorities List or the Resource Conservation and Recovery Act (RCRA) List of Violating Facilities. The use of a Contractor selected landfill shall in no manner delay the construction schedule or alter the Contractor's responsibilities as set forth.

669.06 Non-Special Waste Certification. An authorized representative of the Department shall sign and date all non-special waste certifications. The Contractor shall be responsible for providing the Engineer with the required information that will allow the Engineer to certify the waste is not a special waste.

(a) Definition. A waste is considered a non-special waste as long as it is not:

- (1) a potentially infectious medical waste;
- (2) a hazardous waste as defined in 35 Ill. Admin. Code 721;
- (3) an industrial process waste or pollution control waste that contains liquids, as determined using the paint filter test set forth in subdivision (3)(A) of subsection (m) of 35 Ill. Admin. Code 811.107;
- (4) a regulated asbestos-containing waste material, as defined under the National Emission Standards for Hazardous Air Pollutants in 40 CFR Part 61.141;
- (5) a material containing polychlorinated biphenyls (PCB's) regulated pursuant to 40 CFR Part 761;
- (6) a material subject to the waste analysis and recordkeeping requirements of 35 Ill. Admin. Code 728.107 under land disposal restrictions of 35 Ill. Admin. Code 728;
- (7) a waste material generated by processing recyclable metals by shredding and required to be managed as a special waste under Section 22.29 of the Environmental Protection Act; or
- (8) an empty portable device or container in which a special or hazardous waste has been stored, transported, treated, disposed of, or otherwise handled.

(b) Certification Information. All information used to determine the waste is not a special waste shall be attached to the certification. The information shall include but not be limited to:

- (1) the means by which the generator has determined the waste is not a hazardous waste;
- (2) the means by which the generator has determined the waste is not a liquid;
- (3) if the waste undergoes testing, the analytic results obtained from testing, signed and dated by the person responsible for completing the analysis;
- (4) if the waste does not undergo testing, an explanation as to why no testing is needed;

(5) a description of the process generating the waste; and

(6) relevant material safety data sheets.

669.07 Temporary Staging. Soil classified according to Articles 669.05(a)(2), (b)(1), or (c) may be temporarily staged at the Contractor's option. Soil classified according to Articles 669.05(a)(1), (a)(3), (a)(4), (a)(5), (a)(6), or (b)(2) shall be managed and disposed of without temporary staging to the greatest extent practicable. If circumstances beyond the Contractor's control require temporary staging of these latter materials, the Contractor shall request approval from the Engineer in writing.

Temporary staging shall be accomplished within the right-of-way and the Contractor's means and methods shall be described in the approved or amended RSPCP. Staging areas shall not be located within 200 feet (61 m) of a public or private water supply well; nor within 100 feet (30 m) of sensitive environmental receptor areas, including wetlands, rivers, streams, lakes, or designated habitat zones.

The method of staging shall consist of containerization or stockpiling as applicable for the type, classification, and physical state (i.e., liquid, solid, semisolid) of the material. Materials of different classifications shall be staged separately with no mixing or co-mingling.

When containers are used, the containers and their contents shall remain intact and inaccessible to unauthorized persons until the manner of disposal is determined. The Contractor shall be responsible for all activities associated with the storage containers including, but not limited to, the procurement, transport, and labeling of the containers. The Contractor shall not use a storage container if visual inspection of the container reveals the presence of free liquids or other substances that could cause the waste to be reclassified as a hazardous or special waste.

When stockpiles are used, they shall be covered with a minimum 20-mil plastic sheeting or tarps secured using weights or tie-downs. Perimeter berms or diversionary trenches shall be provided to contain and collect for disposal any water that drains from the soil. Stockpiles shall be managed to prevent or reduce potential dust generation.

When staging non-special waste, special waste, or hazardous waste, the following additional requirements shall apply:

- (a) **Non-Special Waste.** When stockpiling soil classified according to Article 669.05(a)(1) or 669.05(a)(5), an impermeable surface barrier between the materials and the ground surface shall be installed. The impermeable barrier shall consist of a minimum 20-mil plastic liner material and the surface of the stockpile area shall be clean and free of debris prior to placement of the liner. Measures shall also be taken to limit or discourage access to the staging area.
- (b) **Special Waste and Hazardous Waste.** Soil classified according to Article 669.05(a)(6) shall not be stockpiled but shall be containerized immediately upon generation in containers, tanks or containment buildings as defined by RCRA, Toxic Substances Control

Act (TSCA), and other applicable State or local regulations and requirements, including 35 Ill. Admin. Code Part 722, Standards Applicable to Generators of Hazardous Waste.

The staging area(s) shall be enclosed (by a fence or other structure) to restrict direct access to the area, and all required regulatory identification signs applicable to a staging area containing special waste or hazardous waste shall be deployed.

Storage containers shall be placed on an all-weather gravel-packed, asphalt, or concrete surface. Containers shall be in good condition and free of leaks, large dents, or severe rusting, which may compromise containment integrity. Containers must be constructed of, or lined with, materials that will not react or be otherwise incompatible with the hazardous or special waste contents. Containers used to store liquids shall not be filled more than 80 percent of the rated capacity. Incompatible wastes shall not be placed in the same container or comingled.

All containers shall be legibly labeled and marked using pre-printed labels and permanent marker in accordance with applicable regulations, clearly showing the date of waste generation, location and/or area of waste generation, and type of waste. The Contractor shall place these identifying markings on an exterior side surface of the container.

Storage containers shall be kept closed, and storage pads covered, except when access is needed by authorized personnel.

Special waste and hazardous waste shall be transported and disposed within 90 days from the date of generation.

669.08 Underground Storage Tank Removal. For the purposes of this section, an underground storage tank (UST) includes the underground storage tank, piping, electrical controls, pump island, vent pipes and appurtenances.

Prior to removing an UST, the Engineer shall determine whether the Department is considered an "owner" or "operator" of the UST as defined by the UST regulations (41 Ill. Adm. Code Part 176). Ownership of the UST refers to the Department's owning title to the UST during storage, use or dispensing of regulated substances. The Department may be considered an "operator" of the UST if it has control of, or has responsibility for, the daily operation of the UST. The Department may however voluntarily undertake actions to remove an UST from the ground without being deemed an "operator" of the UST.

In the event the Department is deemed not to be the "owner" or "operator" of the UST, the OSFM removal permit shall reflect who was the past "owner" or "operator" of the UST. If the "owner" or "operator" cannot be determined from past UST registration documents from OSFM, then the OSFM removal permit will state the "owner" or "operator" of the UST is the Department. The Department's Office of Chief Counsel (OCC) will review all UST removal permits prior to submitting any removal permit to the OSFM. If the Department is not the "owner" or "operator" of the UST then it will not register the UST or pay any registration fee.

The Contractor shall be responsible for obtaining permits required for removing the UST, notification to the OSFM, using an OSFM certified tank contractor, removal and disposal of the UST and its contents, and preparation and submittal of the OSFM Site Assessment Report in accordance with 41 Ill. Admin. Code Part 176.330.

The Contractor shall contact the Engineer and the OSFM's office at least 72 hours prior to removal to confirm the OSFM inspector's presence during the UST removal. Removal, transport, and disposal of the UST shall be according to the applicable portions of the latest revision of the "American Petroleum Institute (API) Recommended Practice 1604".

The Contractor shall collect and analyze tank content (sludge) for disposal purposes. The Contractor shall remove as much of the regulated substance from the UST system as necessary to prevent further release into the environment. All contents within the tank shall be removed, transported and disposed of, or recycled. The tank shall be removed and rendered empty according to IEPA definition.

The Contractor shall collect soil samples from the bottom and sidewalls of the excavated area in accordance with 35 Ill. Admin. Code Part 734.210(h) after the required backfill has been removed during the initial response action, to determine the level of contamination remaining in the ground, regardless if a release is confirmed or not by the OSFM on-site inspector.

In the event the UST is designated a leaking underground storage tank (LUST) by the OSFM's inspector, or confirmation by analytical results, the Contractor shall notify the Engineer and the District Environmental Studies Unit (DESU). Upon confirmation of a release of contaminants and notifications to the Engineer and DESU, the Contractor shall report the release to the Illinois Emergency Management Agency (IEMA) (e.g., by telephone or electronic mail) and provide them with whatever information is available ("owner" or "operator" shall be stated as the past registered "owner" or "operator", or the IDOT District in which the tank is located and the DESU Manager).

The Contractor shall perform the following initial response actions if a release is indicated by the OSFM inspector:

- (a) Take immediate action to prevent any further release of the regulated substance to the environment, which may include removing, at the Engineer's discretion, and disposing of up to 4 ft (1.2 m) of the contaminated material, as measured from the outside dimension of the tank;
- (b) Identify and mitigate fire, explosion and vapor hazards;
- (c) Visually inspect any above ground releases or exposed below ground releases and prevent further migration of the released substance into surrounding soils and groundwater; and
- (d) Continue to monitor and mitigate any additional fire and safety hazards posed by vapors and free product that have migrated from the tank excavation zone and entered into subsurface structures (such as sewers or basements).

The tank excavation shall be backfilled according to applicable portions of Sections 205, 208, and 550 with a material that will compact and develop stability. All uncontaminated concrete and soil removed during tank extraction may be used to backfill the excavation, at the discretion of the Engineer.

After backfilling the excavation, the site shall be graded and cleaned.

669.09 Regulated Substances Final Construction Report. Not later than 90 days after completing this work, the Contractor shall submit a "Regulated Substances Final Construction Report (RSFCR)" to the Engineer using form BDE 2733 and required attachments. The form shall be signed by an Illinois licensed Professional Engineer or Professional Geologist.

669.10 Method of Measurement. Non-special waste, special waste, and hazardous waste soil will be measured for payment according to Article 202.07(b) when performing earth excavation, Article 502.12(b) when excavating for structures, or by computing the volume of the trench using the maximum trench width permitted and the actual depth of the trench.

Groundwater containerized and transported off-site for management, storage, and disposal will be measured for payment in gallons (liters).

Backfill plugs will be measured in cubic yards (cubic meters) in place, except the quantity for which payment will be made shall not exceed the volume of the trench, as computed by using the maximum width of trench permitted by the Specifications and the actual depth of the trench, with a deduction for the volume of the pipe.

Engineered Barriers will be measured for payment in square yards (square meters).

669.11 Basis of Payment. The work of preparing, submitting and administering a Regulated Substances Pre-Construction Plan will be paid for at the contract lump sum price for REGULATED SUBSTANCES PRE-CONSTRUCTION PLAN.

Regulated substances monitoring, including completion of form BDE 2732 for each day of work, will be paid for at the contract unit price per calendar day, or fraction thereof to the nearest 0.5 calendar day, for REGULATED SUBSTANCES MONITORING.

The installation of engineered barriers will be paid for at the contract unit price per square yard (square meter) for ENGINEERED BARRIER.

The work of UST removal, soil excavation, soil and content sampling, the management of excavated soil and UST content, and UST disposal, will be paid for at the contract unit price per each for UNDERGROUND STORAGE TANK REMOVAL.

The transportation and disposal of soil and other materials from an excavation determined to be contaminated will be paid for at the contract unit price per cubic yard (cubic meter) for

NON-SPECIAL WASTE DISPOSAL, SPECIAL WASTE DISPOSAL, or HAZARDOUS WASTE DISPOSAL.

The transportation and disposal of groundwater from an excavation determined to be contaminated will be paid for at the contract unit price per gallon (liter) for SPECIAL WASTE GROUNDWATER DISPOSAL or HAZARDOUS WASTE GROUNDWATER DISPOSAL. When groundwater is discharged to a sanitary or combined sewer by permit, the cost will be paid for according to Article 109.05.

Backfill plugs will be paid for at the contract unit price per cubic yard (cubic meter) for BACKFILL PLUGS.

Payment for temporary staging of soil classified according to Articles 669.05(a)(1), (a)(3), (a)(4), (a)(5), (a)(6), or (b)(2) will be paid for according to Article 109.04. The Department will not be responsible for any additional costs incurred, if mismanagement of the staging area, storage containers, or their contents by the Contractor results in excess cost expenditure for disposal or other material management requirements.

Payment for accumulated stormwater removal and disposal will be according to Article 109.04. Payment will only be allowed if appropriate stormwater and erosion control methods were used.

Payment for decontamination, labor, material, and equipment for monitoring areas beyond the specified areas, with the Engineer's prior written approval, will be according to Article 109.04.

When the waste material for disposal requires sampling for landfill disposal acceptance, the samples shall be analyzed for TCLP VOCs, SVOCs, RCRA metals, pH, ignitability, and paint filter test. The analysis will be paid for at the contract unit price per each for SOIL DISPOSAL ANALYSIS using EPA Methods 1311 (extraction), 8260B for VOCs, 8270C for SVOCs, 6010B and 7470A for RCRA metals, 9045C for pH, 1030 for ignitability, and 9095A for paint filter.

The work of preparing, submitting and administering a Regulated Substances Final Construction Report will be paid for at the contract lump sum price REGULATED SUBSTANCES FINAL CONSTRUCTION REPORT."

80407

SUBCONTRACTOR AND DBE PAYMENT REPORTING (BDE)

Effective: April 2, 2018

Add the following to Section 109 of the Standard Specifications.

“109.14 Subcontractor and Disadvantaged Business Enterprise Payment Reporting.
The Contractor shall report all payments made to the following parties:

- (a) first tier subcontractors;
- (b) lower tier subcontractors affecting disadvantaged business enterprise (DBE) goal credit;
- (c) material suppliers or trucking firms that are part of the Contractor’s submitted DBE utilization plan.

The report shall be made through the Department’s on-line subcontractor payment reporting system within 21 days of making the payment.”

80397

SUBCONTRACTOR MOBILIZATION PAYMENTS (BDE)

Effective: November 2, 2017

Revised: April 1, 2019

Replace the second paragraph of Article 109.12 of the Standard Specifications with the following:

“This mobilization payment shall be made at least seven days prior to the subcontractor starting work. The amount paid shall be at the following percentage of the amount of the subcontract reported on form BC 260A submitted for the approval of the subcontractor’s work.

Value of Subcontract Reported on Form BC 260A	Mobilization Percentage
Less than \$10,000	25%
\$10,000 to less than \$20,000	20%
\$20,000 to less than \$40,000	18%
\$40,000 to less than \$60,000	16%
\$60,000 to less than \$80,000	14%
\$80,000 to less than \$100,000	12%
\$100,000 to less than \$250,000	10%
\$250,000 to less than \$500,000	9%
\$500,000 to \$750,000	8%
Over \$750,000	7%”

80391

TRAFFIC CONTROL DEVICES - CONES (BDE)

Effective: January 1, 2019

Revise Article 701.15(a) of the Standard Specifications to read:

“(a) Cones. Cones are used to channelize traffic. Cones used to channelize traffic at night shall be reflectorized; however, cones shall not be used in nighttime lane closure tapers or nighttime lane shifts.”

Revise Article 1106.02(b) of the Standard Specifications to read:

“(b) Cones. Cones shall be predominantly orange. Cones used at night that are 28 to 36 in. (700 to 900 mm) in height shall have two white circumferential stripes. If non-reflective spaces are left between the stripes, the spaces shall be no more than 2 in. (50mm) in width. Cones used at night that are taller than 36 in. (900 mm) shall have a minimum of two white and two fluorescent orange alternating, circumferential stripes with the top stripe being fluorescent orange. If non-reflective spaces are left between the stripes, the spaces shall be no more than 3 in. (75 mm) in width.

The minimum weights for the various cone heights shall be 4 lb for 18 in. (2 kg for 450 mm), 7 lb for 28 in. (3 kg for 700 mm), and 10 lb for 36 in. (5 kg for 900 mm) with a minimum of 60 percent of the total weight in the base. Cones taller than 36 in. shall be weighted per the manufacturer’s specifications such that they are not moved by wind or passing traffic.”

80409

WEEKLY DBE TRUCKING REPORTS (BDE)

Effective: June 2, 2012

| Revised: April 2, 2015

| The Contractor shall submit a weekly report of Disadvantaged Business Enterprise (DBE) trucks hired by the Contractor or subcontractors (i.e. not owned by the Contractor or subcontractors) that are used for DBE goal credit.

| The report shall be submitted to the Engineer on Department form "SBE 723" within ten business days following the reporting period. The reporting period shall be Monday through Sunday for each week reportable trucking activities occur.

Any costs associated with providing weekly DBE trucking reports shall be considered as included in the contract unit prices bid for the various items of work involved and no additional compensation will be allowed.

80302

WORKING DAYS (BDE)

Effective: January 1, 2002

The Contractor shall complete the work within 15 working days.

80071

F.A.S. ROFFE	SECTION	COUNTY	TOTAL SHEETS	SHEET NO.
VARIOUS	19-00114-00-PP	HAMILTON	24	1
FED. ROAD DIST. NO. 9		ILLINOIS		

STATE OF ILLINOIS DEPARTMENT OF TRANSPORTATION PLANS FOR PROPOSED PAVEMENT PRESERVATION PROJECT HAMILTON COUNTY, ILLINOIS

ROUTE NO. VARIOUS LOCATIONS
SECTION 19-00114-00-PP
PROJECT 3TKP (949)
JOB NO. C-99-068-19
HAMILTON COUNTY

INDEX OF SHEETS

1. Cover Sheet
2. Index of Standards, Typical Section and SOQ
3. Location Map
4. Paint Pavement Marking Schedule
5. IDOT Standards

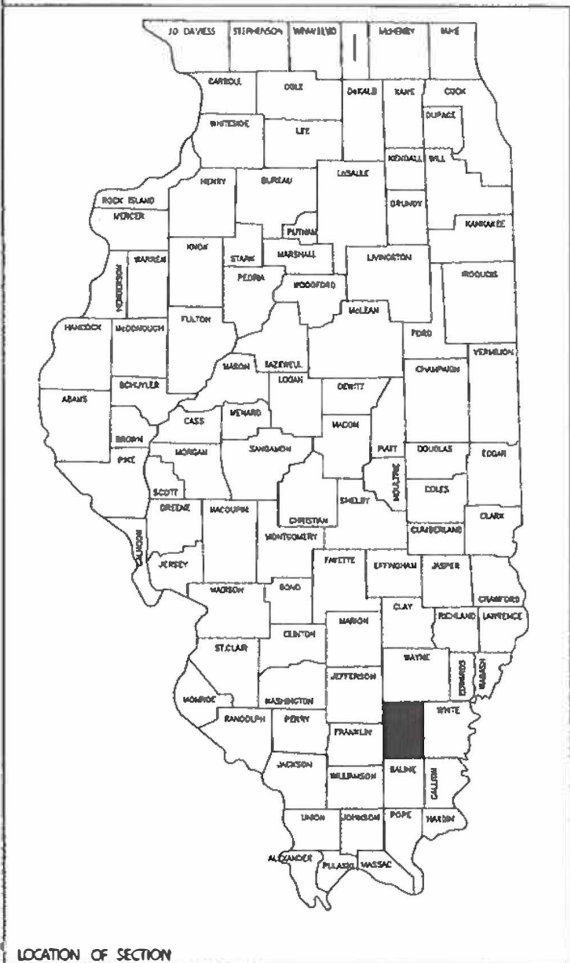

LOCATION OF SECTION

CONTRACT NO : 99645
DESIGN CLASS: MAJOR COLLECTOR
CURRENT A.D.T. = 225 - 500
DESIGN SPEED = 50 MPH

TOTAL LENGTH OF IMPROVEMENTS:	110,669 FEET	20.96 MILES
OMISSION :	246 FEET	.05 MILES
NET LENGTH OF IMPROVEMENTS:	110,423 FEET	20.91 MILES



EXPIRES 11/30/2021

STATE OF ILLINOIS DEPARTMENT OF TRANSPORTATION	
APPROVED	<i>March 24, 2020</i> <i>Kevin Phillips</i> COUNTY ENGINEER
PASSED	<i>04/01/2020</i> <i>[Signature]</i> DISTRICT 9 ENGINEER OF LOCAL ROADS & STREETS
RELEASING FOR BID, BASED ON LIMITED REVIEW	<i>04/01/2020</i> <i>Keith Roberts</i> KEITH ROBERTS, P.E. ACTING REGION FIVE ENGINEER

F.A.S. ROUTE	SECTION	COUNTY	TOTAL SHEETS	SHEET NO.
VARIOUS	19-00114-00-PP	HAMILTON	24	2
FED. ROAD DIST. NO. 9		ILLINOIS		

INDEX OF STANDARDS

<u>STD #</u>	<u>DESCRIPTION</u>
000001-07	STANDARD SYMBOLS, ABBREVIATIONS & PATTERNS
442201-03	CLASS C & D PATCHES
701006-05	OFF-RD OPERATIONS, 2L, 2W, 4.5m (15') TO 600mm (24") FROM PAVEMENT EDGE
701301-04	LANE CLOSURE, 2L, 2W, SHORT TIME OPERATION
701306-04	LANE CLOSURE, 2L, 2W, SLOW MOVING OPERATIONS, DAY ONLY FOR SPEEDS > 45 MPH
701311-03	LANE CLOSURE, 2L, 2W, MOVING DAY ONLY OPERATIONS
701901-08	TRAFFIC CONTROL DEVICES
780001-05	TYPICAL PAVEMENT MARKINGS

**TYPICAL CROSS SECTION
OF EXISTING/PROPOSED ROAD**

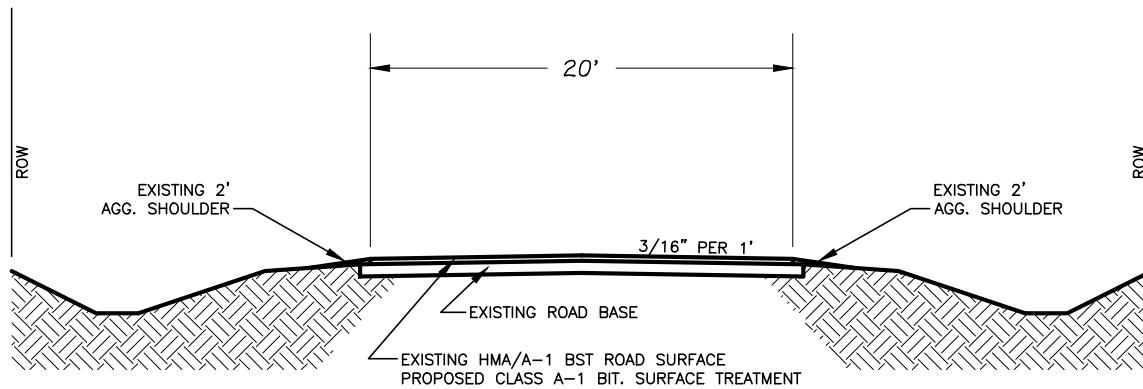

SUMMARY OF QUANTITIES

<u>QUANTITY</u>	<u>UNIT</u>	<u>ITEM</u>	<u>CODE NO.</u>
245	TON	BITUMINOUS MATERIALS (COVER & SEAL COATS)	40300400
3,075	TON	SEAL COAT AGGREGATE	40300600
1	L SUM	MOBILIZATION	67100100
1	L SUM	TRAFFIC CONTROL AND PROTECTION, STANDARD 701306	70100460
48,220	FOOT	PAINT PAVEMENT MARKING LINE 4"	78001110 Δ

Δ SPECIALTY ITEM

F.A.S. ROUTE	SECTION	COUNTY	TOTAL SHEETS	SHEET NO.
VARIOUS	19-00114-00-PP	HAMILTON	24	3
FED. ROAD DIST. NO. 9		ILLINOIS		

LOCATION MAP

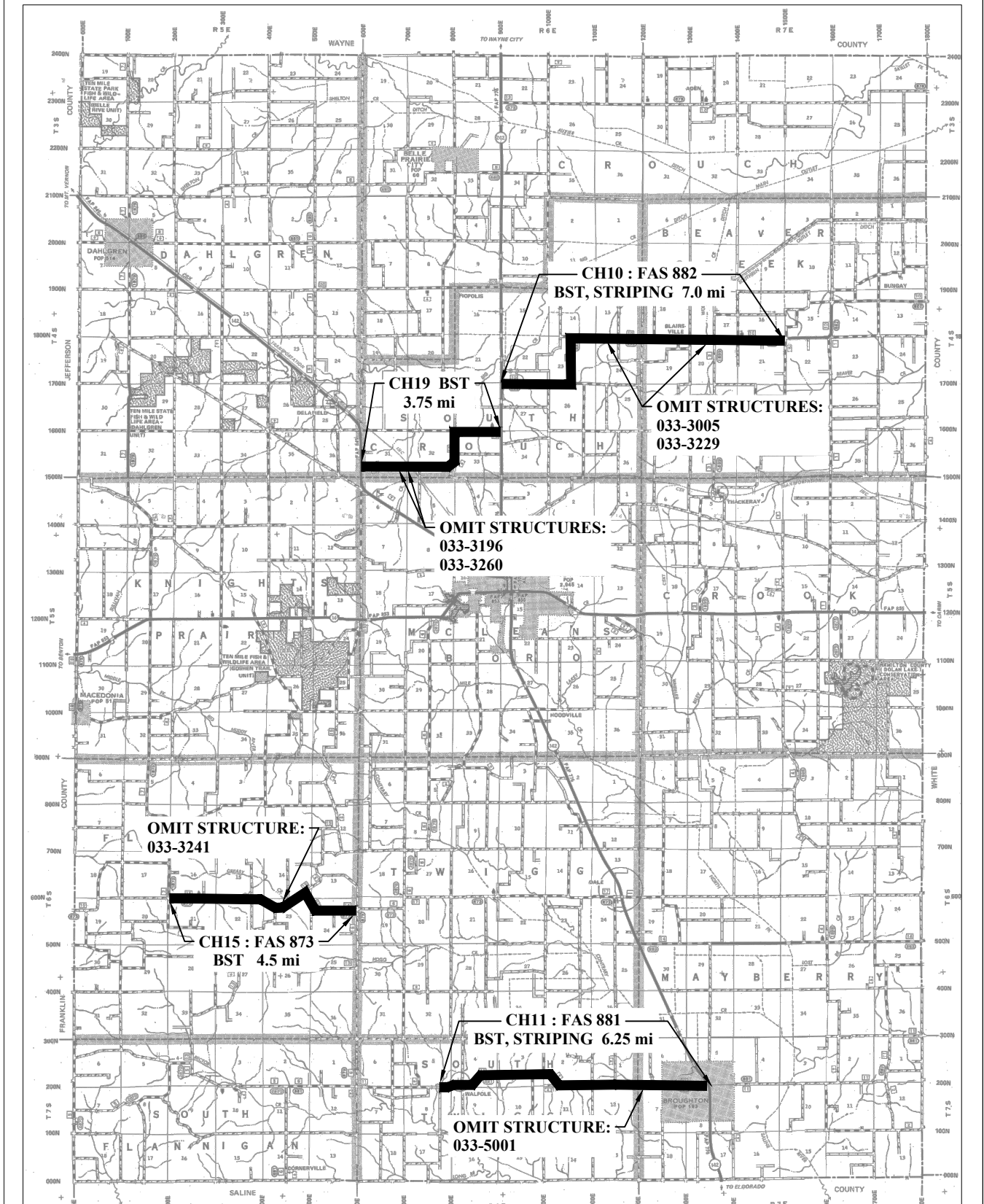

PAINT PAVEMENT MARKING - LINE 4"				
CH10 - FAS 882				QUANTITY
STATION		STATION	LOCATION	FOOT
CENTERLINE				
0+44	to	50+82	Centerline	1,260
56+30	to	73+24	Centerline	424
81+15	to	123+78	Centerline	1,066
134+86	to	367+80	Centerline	5,824
Total:				8,572
NO PASSING ZONES				
50+82	to	56+30	Right	548
50+82	to	64+15	Left	1,333
65+28	to	81+15	Right	1,587
73+24	to	90+05	Left	1,681
90+05	to	95+52	Right	547
97+59	to	104+06	Left	647
114+82	to	134+86	Right	2,004
123+78	to	139+37	Left	1,559
Total:				9,906

PAINT PAVEMENT MARKING - LINE 4"				
CH11 - FAS 881				QUANTITY
STATION		STATION	LOCATION	FOOT
CENTERLINE				
279+25	to	287+55	Centerline	208
294+84	to	315+53	Centerline	517
337+50	to	407+01		1,738
435+53	to	456+21		517
457+48	to	589+83		3,309
Total:				6,288
NO PASSING ZONES				
279+25	to	294+84	Right	1,559
287+55	to	303+53	Left	1,598
307+30	to	337+50	Right	3,020
315+53	to	346+44	Left	3,091
398+51	to	435+53	Right	3,702
407+01	to	444+81	Left	3,780
447+54	to	457+48	Right	994
456+21	to	465+38	Left	917
466+48	to	473+48	Right	700
486+47	to	492+47	Right	600
494+81	to	500+46	Left	565
567+49		575+20	Right	771
576+23		582+29	Left	606
582+29	to	593+81	Right	1,152
589+83	to	593+81	Left	398
Total:				23,453

Total Striping: 48,220

ADJUSTMENT ITEMS	EX	PR	ADJUSTMENT ITEMS	EX	PR	ADJUSTMENT ITEMS	EX	PR	ADJUSTMENT ITEMS	EX	PR
Structure To Be Adjusted		ADJ	Centerline			Channel or Stream Line			Storm Sewer		
Structure To Be Cleared		C	Centerline Break Circle			Culvert Line			Flowline		
Main Structure To Be Filled		FM	Baseline Symbol			Grading & Shaping Ditches			Ditch Check		
Structure To Be Filled		F	Centerline Symbol			Drainage Boundary Line			Headwall		
Structure To Be Filled Special		FSP	PI Indicator			Paved Ditch			Inlet		
Structure To Be Removed		R	Point Indicator			Aggregate Ditch			Mannhole		
Structure To Be Reconstructed		REC	Horizontal Curve Data (Half Size)			Pipe Underdrain			Summit		
Structure To Be Reconstructed Special		RSP	Horizontal Curve Data (Half Size)			Storm Sewer			Roadway Ditch flow		
Frame and Grute To Be Adjusted		A	BOUNDARIES ITEMS			Flowline			Swale		
Frame and Lid To Be Adjusted		A	Dashed Property Line			Ditch Check			Catch Basin		
Domestic Sewer Box To Be Adjusted		A	Solid Property/LOL Line			Headwall			Culvert End Section		
Valve Vault To Be Adjusted		A	Section/Grant Line			Storm Sewer			Water Surface Indicator		
Special Adjustment		SP	Quarter Section Line			Culvert Line			Riprap		
Item To Be Abandoned		AB	Quarter/Quarter Section Line			Channel or Stream Line			Overflow		
Item To Be Moved		M	County/Township Line			Culvert Line			Sheet Flow		
Item To Be Relocated		REL	State Line			Grading & Shaping Ditches			Hydrant Outlet		
Pavement Removal and Replacement			Iron Pipe Found			Drainage Boundary Line					

STANDARD SYMBOLS, ABBREVIATIONS AND PATTERNS
(Sheet 2 of 9)
STANDARD 000001-07

ILLINOIS DEPARTMENT OF TRANSPORTATION
 APPROVED: [Signature]
 DATE: [Date]
 PROJECT: [Project Name]

LIGHTING (contd.)	PAVEMENT MARKINGS	STANDARD SYMBOLS, ABBREVIATIONS AND PATTERNS
Pull Point	Handicap Symbol	PR
Handhole	RR Crossing	PR
Heavy Duty Handhole	Raised Marker Amber 1 Way	PR
Junction Box	Raised Marker Amber 2 Way	PR
Light Unit Comb.	Raised Marker Crystal 1 Way	PR
Electrical Ground	Two Way Turn Left	EX
Traffic Flow Arrow	Shoulder Diag. Pattern	PR
High Mast Pole (HMI Size)	Skip-Dash White	PR
Light Unit 1	Skip-Dash Yellow	PR
Keyed Long. Joint	Stop Line	EX
Keyed Long. Joint w/Tie Bars	Solid Line	EX
Sawed Long. Joint w/Tie Bars	Double Centerline	EX
Ritenuous Shoulder	Dotted Lines	EX
Bituminous Taper		
Stabilized Driveway		
Widening		

Illinois Department of Transportation

PROJECT: _____

DATE: _____

APPROVED: _____

ILLINOIS DEPARTMENT OF TRANSPORTATION

**STANDARD SYMBOLS,
ABBREVIATIONS
AND PATTERNS**

(Sheet 4 of 9)

STANDARD 000001-07

PAVEMENT MARKINGS
(contd.)

CL 2Ln 2Way
RRPM 12.2 m (40') o.c.

CL 2Ln 2Way
RRPM 80' (24.4 m) o.c.

CL Multilane Div.
RRPM 30' (12.2 m) o.c.

CL Multilane Div.
RRPM 80' (24.4 m) o.c.

CL Multilane Div. Dbl.
RRPM 80' (24.4 m) o.c.

CL Multilane Undiv.

Two Way Turn Left Line

Urban Combination Left

Urban Combination Right

Urban Left Turn Arrow

Urban Right Turn Arrow

Urban Left Turn Only

Urban Right Turn Only

Urban Thru Only

EX

PR

RAILROAD ITEMS

Abandoned Railroad

Railroad

Railroad Point

Control Box

Crossing Gate

Flashing Signal

Railroad Cant. Mast Arm

Crossbuck

REMOVAL ITEMS

Removal Tic

Biluminous Removal

Hatch Pattern

Tree Removal Single

RIGHT OF WAY ITEMS

Future ROW Corner Monument

ROW Marker

ROW Line

Easement

Temporary Easement

PR

EX

RAILROAD ITEMS



EX

REMOVAL ITEMS



EX

RIGHT OF WAY ITEMS



**STANDARD SYMBOLS,
ABBREVIATIONS
AND PATTERNS**
(Sheet 5 of 9)

STANDARD 000001-07

Illinois Department of Transportation
 DIVISION OF HIGHWAYS
 APPROVED: [Signature]
 DATE: 10/14/14
 PROJECT: [Blank]
 SHEET: 5 OF 9

ONLY ONLY ONLY

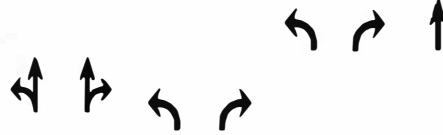

PAVEMENT MARKINGS
(contd.)

EX

PR

Urban U-Turn



Urban Combination U-Turn



Rural Combination Left



Rural Combination Right



Rural Left Turn Arrow



Rural Right Turn Arrow



Rural Left Turn Only

ONLY



Rural Right Turn Only

ONLY



Rural Thru Only

ONLY



Bike Lane Symbol



Bike Lane Text



Bike Path Shared



Bike Shared Roadway



Illinois Department of Transportation
 DATE: 11/15/19
 PROJECT: 15-001
 DRAWING: 15-001-001
 SHEET: 6 OF 9
 APPROVED: [Signature]
 TITLE: [Title]

**STANDARD SYMBOLS,
 ABBREVIATIONS
 AND PATTERNS**
 (Sheet 6 of 9)
STANDARD 000001-07

RIGHT OF WAY ITEMS (contd.)	ROADWAY PROFILES	SIGNING ITEMS (contd.)
Access Control Line	PR — AC —	PR
Access Control Line & ROW	EX — AC —	EX
Access Control Line & ROW with Fence	EX — AC —	EX
Excess ROW Line	EX — XS —	EX
ROADWAY PLAN ITEMS		
Cable Barrier	PR 	PR
Concrete Barrier	EX 	EX
Edge of Pavement	PR 	EX
Bit Shoulders, Medians and C&G Line	PR 	EX
Aggregate Shoulder	PR 	EX
Shoulders, Driveways	PR 	EX
Guardrail	PR 	EX
Guardrail Post	PR 	EX
Traffic Sign	PR 	EX
Corrugated Median	PR 	EX
Impact Attenuator	PR 	EX
North Arrow with District Office (Half Size)	PR 	EX
Match Line	PR STA. 45+00	EX
Slope Limit Line	PR 	EX
Typical Cross-Section Line	PR 	EX

STANDARD SYMBOLS, ABBREVIATIONS AND PATTERNS
(Sheet 7 of 9)
STANDARD 000001-07

SIGNING ITEMS (contd.)	EX	PR	STRUCTURES ITEMS	EX	PR	TRAFFIC SHEET ITEMS	EX	PR
One Way Arrow Lg. W1-6-(O) (Half Size)			Box Culvert Barrel			Cable Number		
Two Way Arrow Large W1-7-(O) (Half Size)			Box Culvert Headwall			Left Turn Green		
Detour M4-10L-(O) (Half Size)			Bridge Pier			Left Turn Yellow		
Detour M4-10R-(O) (Half Size)			Bridge			Signal Backplate		
One Way Left R6-1L (Half Size)			Retaining Wall			Signal Section 8" (200 mm)		
One Way Right R6-1R (Half Size)			Temporary Street Piling			Signal Section 12" (300 mm)		
Left Turn Lane R3-1H00L (Half Size)						Walk/Don't Walk Letters		
Keep Left R4-7AL (Half Size)						Walk/Don't Walk Symbols		
Keep Left R4-7BL (Half Size)								
Keep Right R4-7AR (Half Size)								
Keep Right R4-7BR (Half Size)								
Stop Here On Red R10-6-AL (Half Size)								
Stop Here On Red R10-6-AR (Half Size)								
No Left Turn R3-2 (Half Size)								
No Right Turn R3-1 (Half Size)								
Road Closed R11-2 (Half Size)								
Road Closed Thru Traffic R11-2 (Half Size)								
 ILLINOIS DEPARTMENT OF TRANSPORTATION DIVISION OF HIGHWAYS APPROPRIATE TO THE ILLINOIS HIGHWAY DEPARTMENT ILLINOIS DEPARTMENT OF TRANSPORTATION								
						STANDARD SYMBOLS, ABBREVIATIONS AND PATTERNS (Sheet 8 of 9)		
						STANDARD 000001-07		

CLASS C

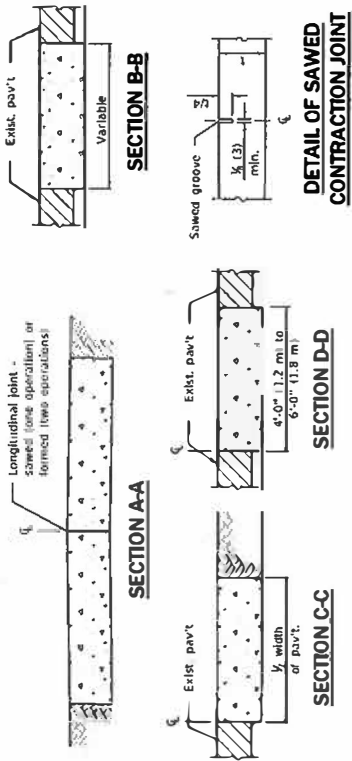
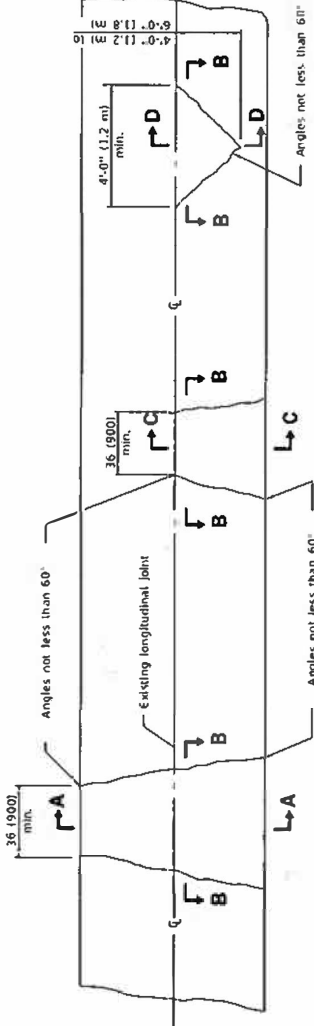

Note:
Longitudinal joints shall be as detailed on Standard 420001, except the bars are not required for patches 20'-0" (6.0 m) or less in length.

CLASS D

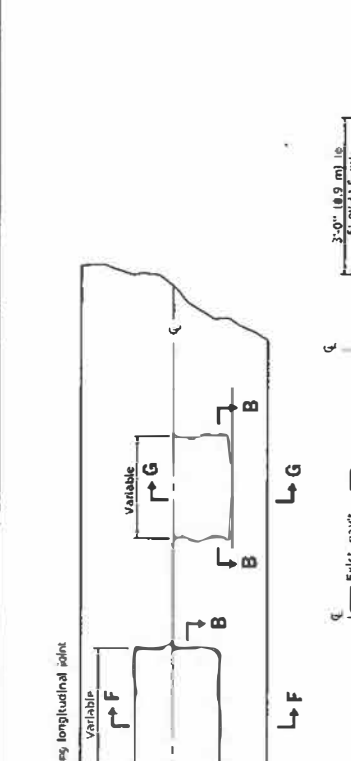
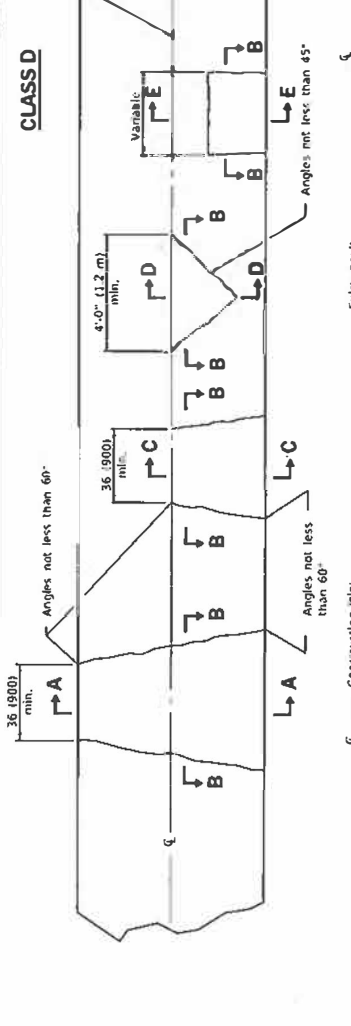

SECTION A-A
(Built in two operations)

SECTION B-B

SECTION C-C

SECTION D-D

SECTION E-E

SECTION F-F
(Built in two operations)

SECTION B-B

SECTION C-C

SECTION D-D

SECTION E-E

GENERAL NOTES
Existing tie bars shall be either cut or removed.
Marginal bars shall be cut.
All dimensions are in inches (millimeters) unless otherwise shown.

Illinois Department of Transportation
 PROJECT: _____
 DRAWING NO.: _____
 SHEET NO.: _____ OF _____
 DATE: _____
 DESIGNED BY: _____
 CHECKED BY: _____
 APPROVED BY: _____
 TITLE: _____

DATE	REVISIONS
1-1-08	Switched units to English (metric).
1-1-07	Revised Note for Class C patches.

CLASS C and D PATCHES

STANDARD 442201-03

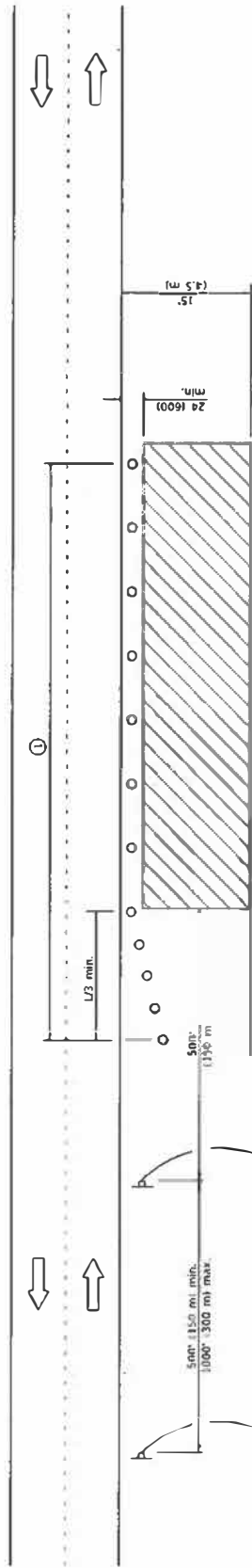

For contract construction projects

W20-1101-411

For maintenance and utility projects

W20-1101-48

W21-1101-18

TYPICAL APPLICATIONS

- Utility operations
- Culvert extensions
- Side slope changes
- Guardrail installation and maintenance
- Delinquent installation
- Landscaping operations
- Shoulder repair
- Sign installation and maintenance

SYMBOLS

- Work area
- Sign
- Cone, drum or barricade

GENERAL NOTES

This Standard is used where any vehicles, equipment, workers or their activities will encroach in the area 15' (4.5 m) to 24' (600) from the edge of pavement.

Calculate L as follows:

SPEED LIMIT

40 mph (70 km/h) or less:

45 mph (80 km/h) or greater:

W = Width of offset in feet (meters).

S = Normal posted speed mph (km/h).

All dimensions are in inches (millimeters) unless otherwise shown.

FORMULAS

English (Metric)

$L = \frac{WS^2}{60}$ $L = \frac{WS^2}{150}$

$L = (W)(S)$ $L = 0.65(W)(S)$

Illinois Department of Transportation

APPROVED

FORWARDED

APPROVED

ILLINOIS DEPARTMENT OF TRANSPORTATION

DATE	REVISIONS
1-1-14	Revised workers sign number to agree with current MUTCD.
1-1-13	Omitted text "WORKERS' sign."

OFF-RD OPERATIONS, 2L, 2W, 15' (4.5 m) TO 24" (600 mm) FROM PAVEMENT EDGE

STANDARD 701006-05

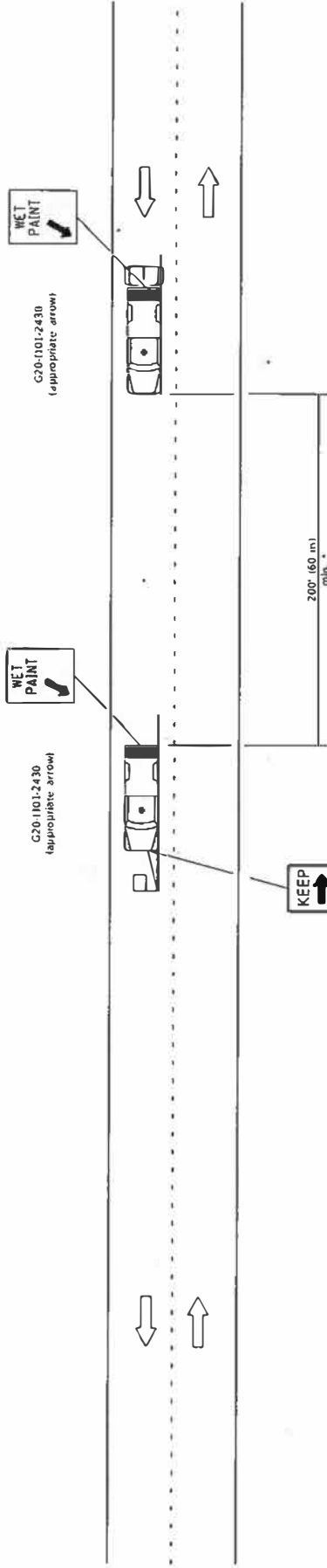

Distance varies depending on terrain and susceptibility of pavement marking or crack sealant to wheel tracking.

TYPICAL APPLICATIONS

- Landscape work
- Utility work
- Pavement marking
- Weed spraying
- Roadometer measurements
- Debris cleanup
- Crack pouring

SYMBOLS

- Arrow board (Hazard Mode only)
- Truck with headlights, emergency flashers and flashing amber light (visible from all directions)
- 18x18 (450x450) min. orange flag (use when guide wheel is used)
- Truck mounted attenuator

GENERAL NOTES

TMS Standard is used where any vehicle, equipment, workers or their activities will require a continuous moving operation where the average speed is greater than 3 mph (5 km/h).

For shoulder operations not encroaching on the pavement, use DETAIL A, Standard 701a2b.

All dimensions are in inches (millimeters) unless otherwise shown.

DATE	REVISIONS
1-1-09	Switched units to English (metric) Unlimited
	Pass With Care sign.
1-1-08	Elim. speed restrictions In Standard title.

**LANE CLOSURE 2L, 2W
MOVING OPERATIONS-
DAY ONLY**

STANDARD 701311-03

Illinois Department of Transportation
 PROJECT: _____ DATE: _____
 DRAWN BY: _____
 APPROVED BY: _____
 ILLUSTRATION OF SYMBOL AND STANDARD

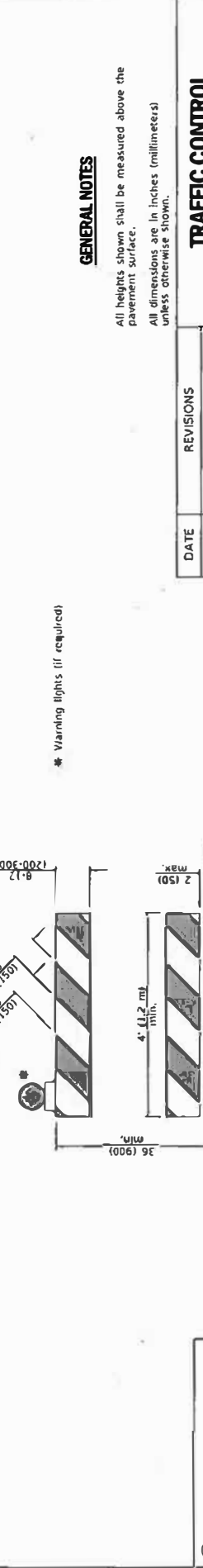
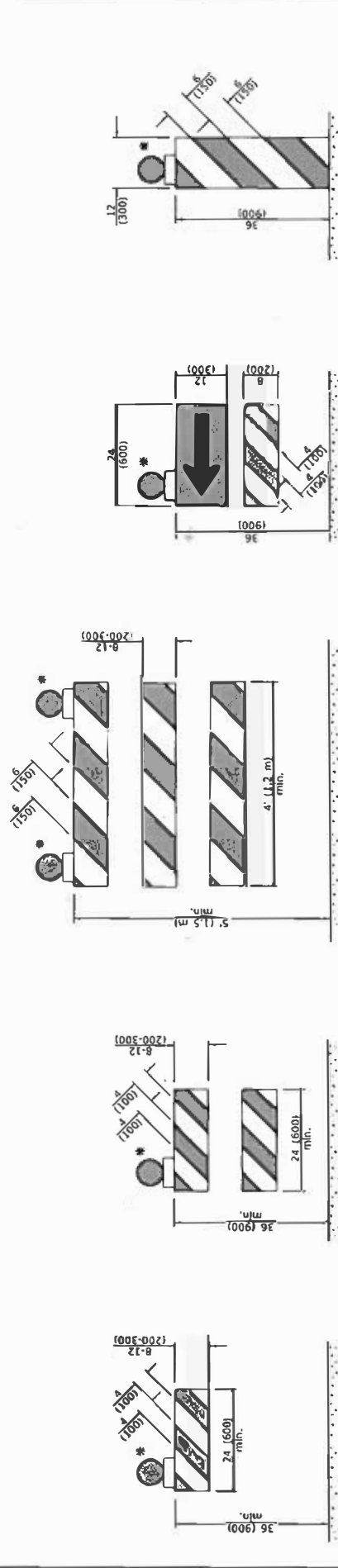
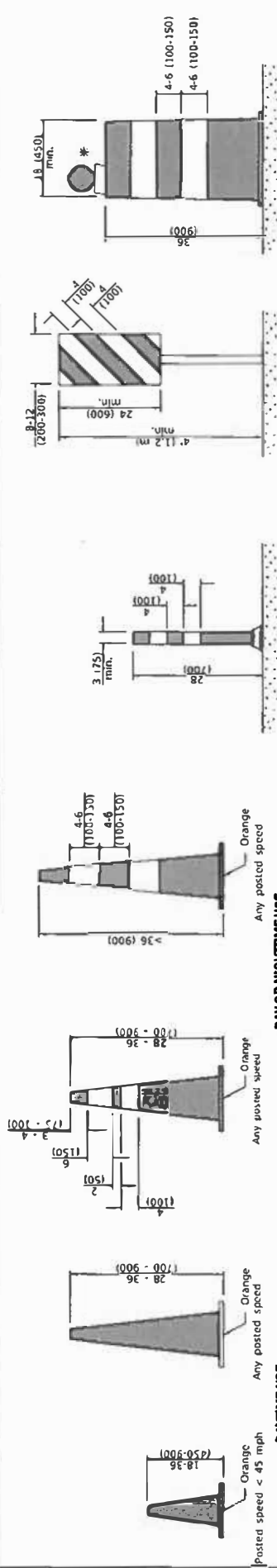

GENERAL NOTES

All heights shown shall be measured above the pavement surface.
All dimensions are in inches (millimeters) unless otherwise shown.

DATE	REVISIONS
1-1-19	Revised cone usage and added cones >36" (900 mm) height.
1-1-18	Revised END-USE ZONE
	SPEED LIMIT sign from orange to white background.

TRAFFIC CONTROL DEVICES

ILLINOIS DEPARTMENT OF TRANSPORTATION

PROJECT: _____ DATE: _____

DESIGNED BY: _____

CHECKED BY: _____

APP'D BY: _____

PROPERTY OF ILLINOIS DEPARTMENT OF TRANSPORTATION

STANDARD 701901-08 (Sheet 1 of 3)



This signing is required for all projects 2 miles (3200 m) or more in length.
 ROAD CONSTRUCTION NEXT X MILES sign shall be placed 500' (150 m) in advance of project limits.
 END CONSTRUCTION sign shall be erected at the end of the job unless another job is within 2 miles (3200 m).
 Dual sign displays shall be utilized on multi-lane highways.

WORK LIMIT SIGNING

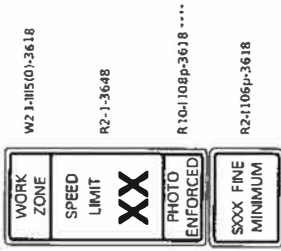

Sign assembly as shown on Standards or as allowed by District Operations.



This sign shall be used when the above sign assembly is used.

HIGHWAY CONSTRUCTION SPEED ZONE SIGNS

R10-1108p shall only be used along roadways under the jurisdiction of the State.

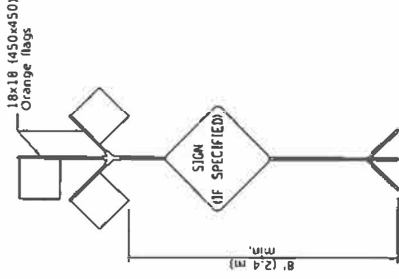

HIGH LEVEL WARNING DEVICE

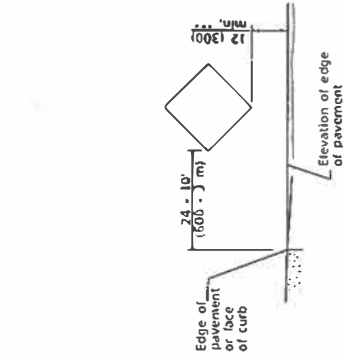

SIGNS ON TEMPORARY SUPPORTS

When work operations exceed 1000' (300 m) in length, signs shall be 5' (1.5 m) min. If located behind other devices, the height shall be sufficient to be seen completely above the devices.

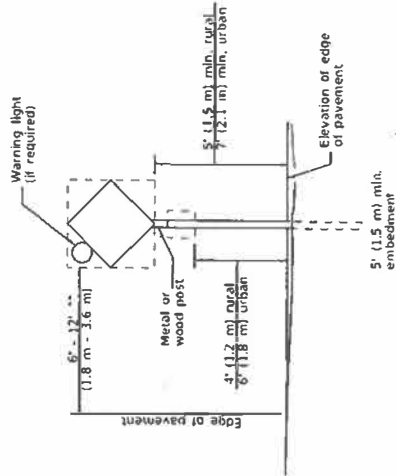

POST MOUNTED SIGNS

When curb or paved shoulder are present this dimension shall be 1600 to the edge of the curb or 1180 to the outside edge of the paved shoulder.

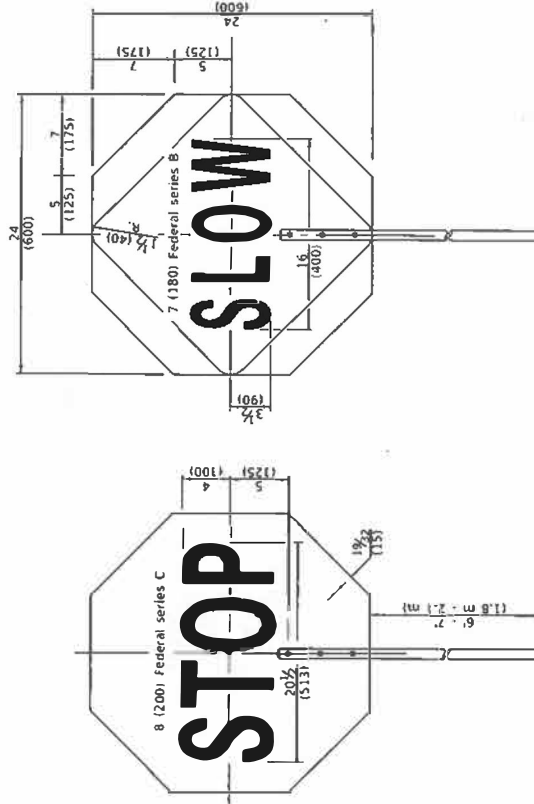

REVERSE SIDE

FRONT SIDE



WIDTH RESTRICTION SIGN

XX-XX" width and X miles are variable.

FLAGGER TRAFFIC CONTROL SIGN

TRAFFIC CONTROL DEVICES

(Sheet 2 of 3)

STANDARD 701901-08

Illinois Department of Transportation
 APPROVED: [Signature] 2/17
 EXEMPTED BY: [Signature] 2/17
 APPROVED: [Signature] 2/17
 ILLINOIS DEPARTMENT OF TRANSPORTATION

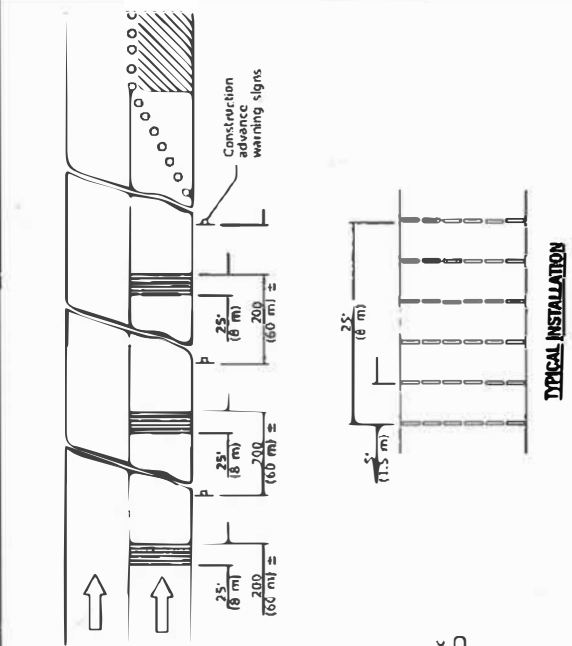

TYPICAL INSTALLATION

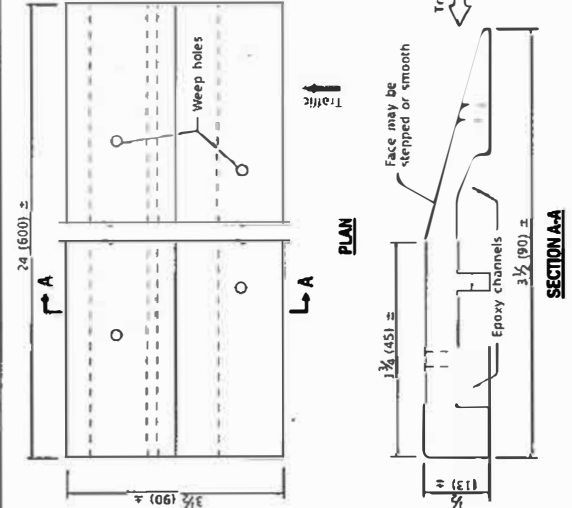

TEMPORARY RUMBLE STRIPS

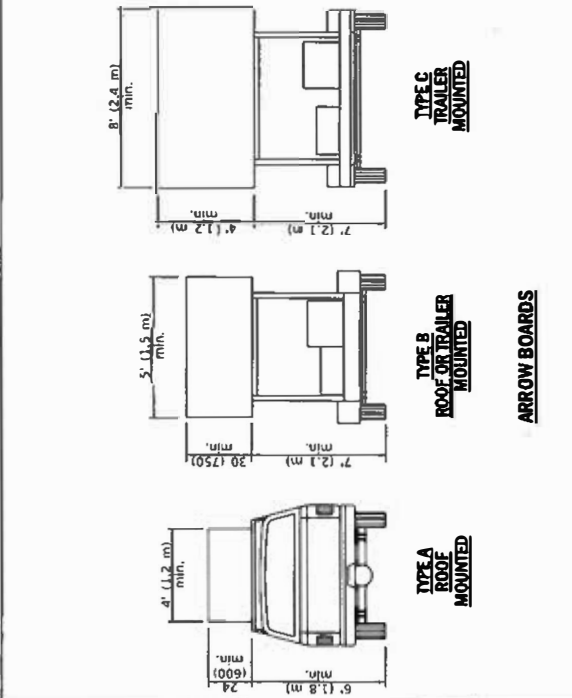

ARROW BOARDS

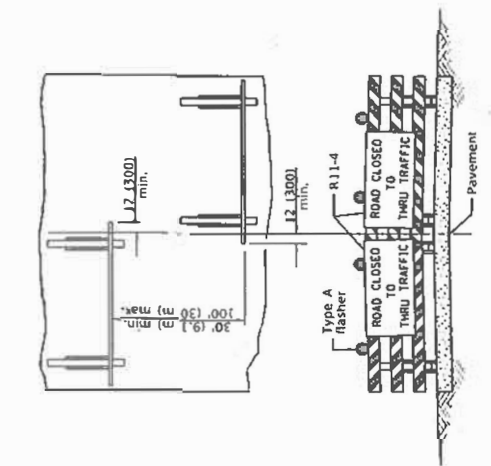

ROAD CLOSED TO THRU TRAFFIC

ReflectORIZED striping shall appear on the back side of the barricades. Type III barricades with an attached sign panel which meets MCHRP 350 is not available; the sign may be mounted on MCHRP 350 temporary sign supports directly in front of the barricade.

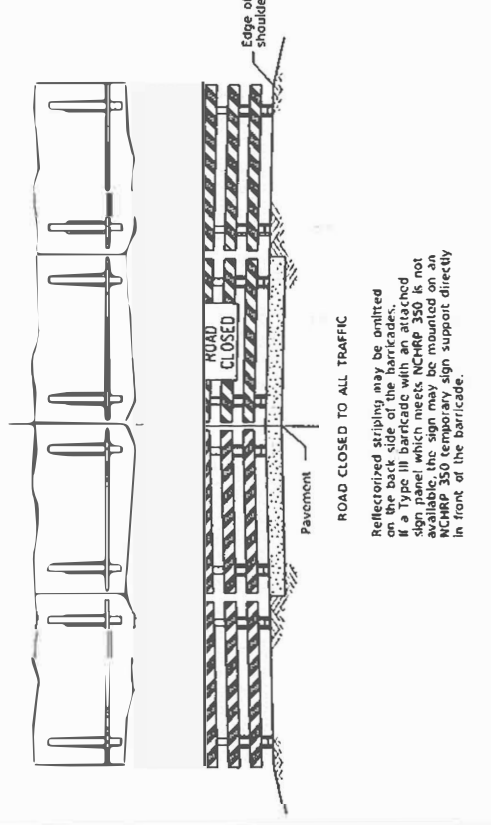

ROAD CLOSED TO ALL TRAFFIC

ReflectORIZED striping may be omitted on the back side of the barricades. If a Type III barricade with an attached sign panel which meets MCHRP 350 is not available, this sign may be mounted on an MCHRP 350 temporary sign support directly in front of the barricade.

TYPICAL APPLICATIONS OF TYPE III BARRICADES CLOSING A ROAD

Illinois Department of Transportation

APPROVED: [Signature] 05/19/10

FOR THE DIRECTOR OF TRANSPORTATION

DESIGNED BY: [Signature] 05/19/10

PROJECT: [Signature] 05/19/10

DATE: [Signature] 05/19/10

PROJECT: [Signature] 05/19/10

DATE: [Signature] 05/19/10

TRAFFIC CONTROL DEVICES

(Sheet 3 of 3)

STANDARD 701901-08

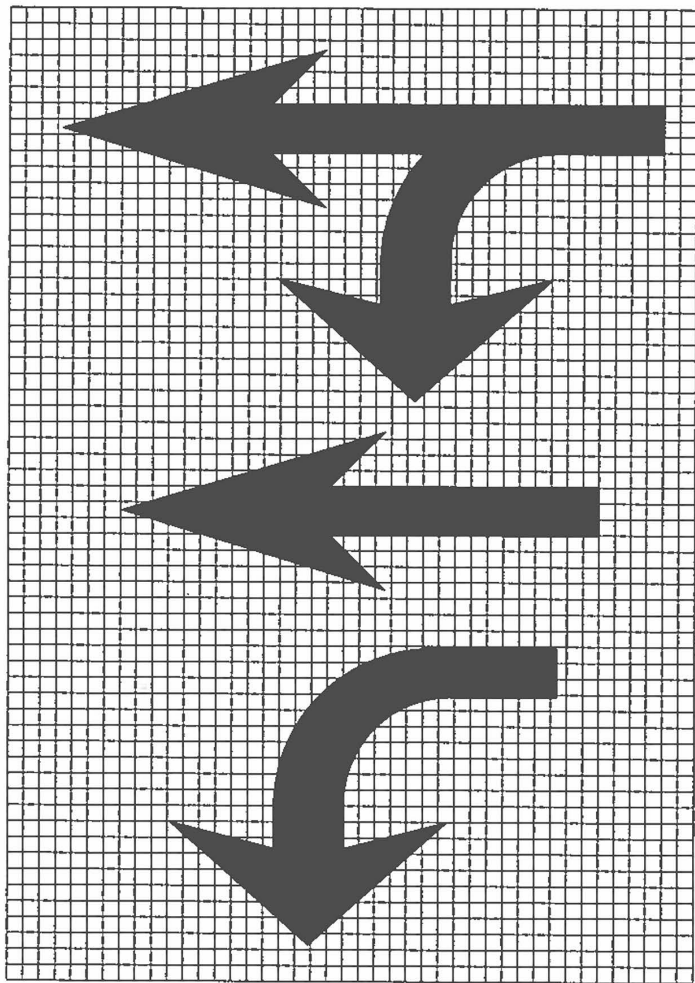
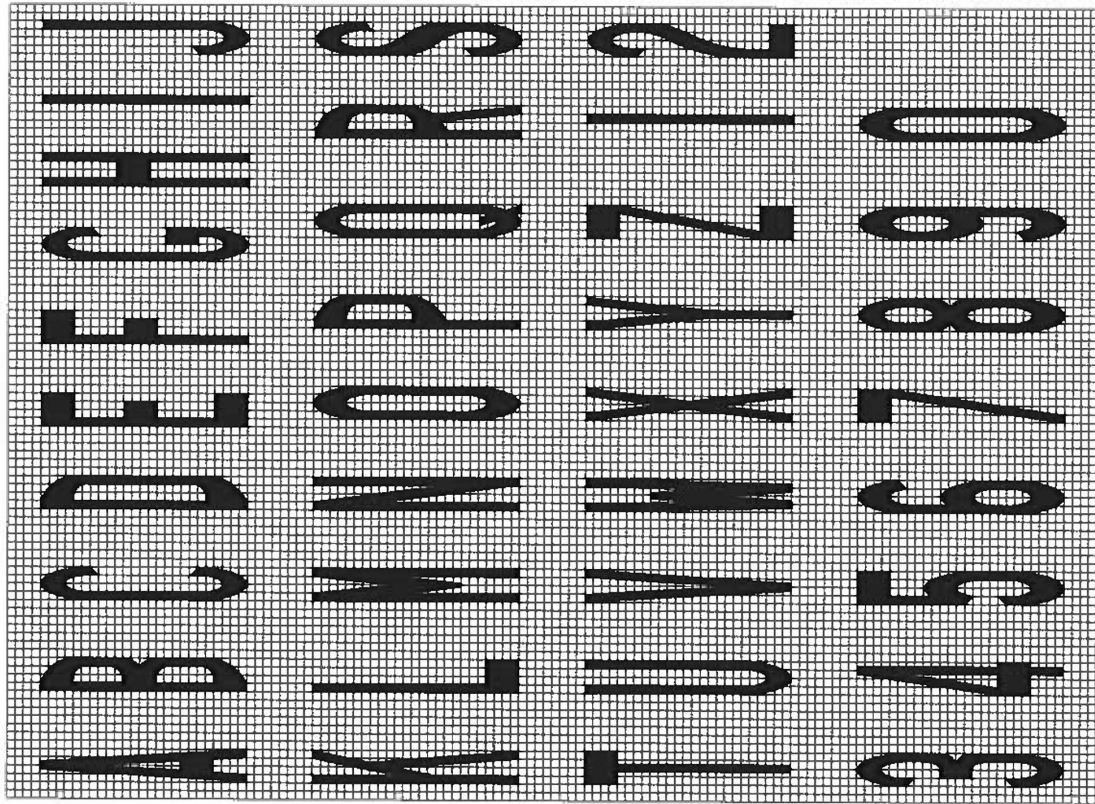

Legend Height	Arrow Size	a
6' (1.8 m)	Small	2.9 (74)
8' (2.4 m)	Large	3.8 (96)

The space between adjacent letters or numerals should be approximately 3 (75) for 6' (1.8 m) legend and 4 (100) for 8' (2.4 m) legend.

LETTER AND ARROW GRID SCALE

Illinois Department of Transportation
 ISSUED 1-1-97
 APPROVED _____
 ENGINEER OF TRANSPORTATION
 APPROVED _____
 CHIEF OF DESIGN AND CONSTRUCTION

TYPICAL PAVEMENT MARKINGS
 (Sheet 2 of 3)
STANDARD 780001-05



20' (6 m): urban
 30' (15 m): rural
 (Between arrow
 and start of
 word)

ONLY

WORD AND ARROW LAYOUT

6' (1.8 m): urban
 8' (2.4 m): rural

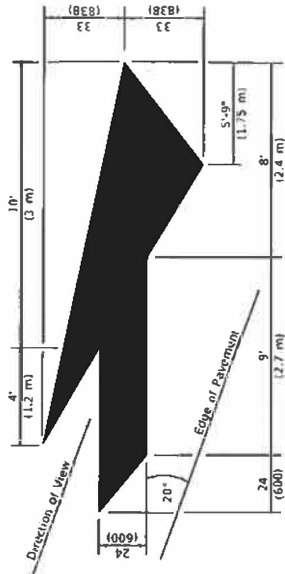

LANE-REDUCTION ARROW

Right lane-reduction arrow shown.
 Use mirror image for left lane.

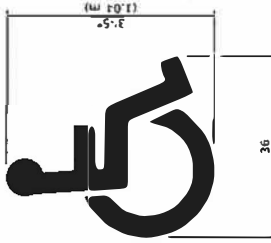

**INTERNATIONAL
 SYMBOL OF
 ACCESSIBILITY**

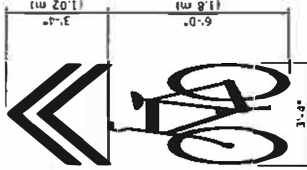

**SHARED LANE
 SYMBOL**

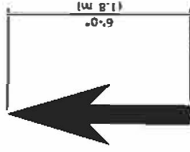

6'-0" (1.8 m)

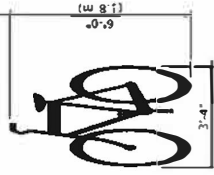

BIKE SYMBOL
 (Arrow is optional.)

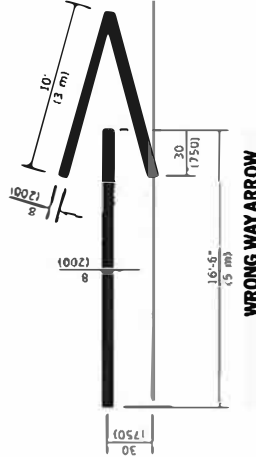

WRONG WAY ARROW

Illinois Department of Transportation
 PROJECT: _____
 DRAWING: _____
 DATE: _____
 DESIGNED BY: _____
 CHECKED BY: _____
 APPROVED BY: _____
 TITLE: _____

**TYPICAL PAVEMENT
 MARKINGS**

(Sheet 3 of 3)

STANDARD 780001-05

REQUIRED CONTRACT PROVISIONS FEDERAL-AID CONSTRUCTION CONTRACTS

- I. General
- II. Nondiscrimination
- III. Nonsegregated Facilities
- IV. Davis-Bacon and Related Act Provisions
- V. Contract Work Hours and Safety Standards Act Provisions
- VI. Subletting or Assigning the Contract
- VII. Safety: Accident Prevention
- VIII. False Statements Concerning Highway Projects
- IX. Implementation of Clean Air Act and Federal Water Pollution Control Act
- X. Compliance with Governmentwide Suspension and Debarment Requirements
- XI. Certification Regarding Use of Contract Funds for Lobbying

ATTACHMENTS

A. Employment and Materials Preference for Appalachian Development Highway System or Appalachian Local Access Road Contracts (included in Appalachian contracts only)

I. GENERAL

1. Form FHWA-1273 must be physically incorporated in each construction contract funded under Title 23 (excluding emergency contracts solely intended for debris removal). The contractor (or subcontractor) must insert this form in each subcontract and further require its inclusion in all lower tier subcontracts (excluding purchase orders, rental agreements and other agreements for supplies or services).

The applicable requirements of Form FHWA-1273 are incorporated by reference for work done under any purchase order, rental agreement or agreement for other services. The prime contractor shall be responsible for compliance by any subcontractor, lower-tier subcontractor or service provider.

Form FHWA-1273 must be included in all Federal-aid design-build contracts, in all subcontracts and in lower tier subcontracts (excluding subcontracts for design services, purchase orders, rental agreements and other agreements for supplies or services). The design-builder shall be responsible for compliance by any subcontractor, lower-tier subcontractor or service provider.

Contracting agencies may reference Form FHWA-1273 in bid proposal or request for proposal documents, however, the Form FHWA-1273 must be physically incorporated (not referenced) in all contracts, subcontracts and lower-tier subcontracts (excluding purchase orders, rental agreements and other agreements for supplies or services related to a construction contract).

2. Subject to the applicability criteria noted in the following sections, these contract provisions shall apply to all work performed on the contract by the contractor's own organization and with the assistance of workers under the contractor's immediate superintendence and to all work performed on the contract by piecework, station work, or by subcontract.

3. A breach of any of the stipulations contained in these Required Contract Provisions may be sufficient grounds for withholding of progress payments, withholding of final payment, termination of the contract, suspension / debarment or any other action determined to be appropriate by the contracting agency and FHWA.

4. Selection of Labor: During the performance of this contract, the contractor shall not use convict labor for any purpose within the limits of a construction project on a Federal-aid highway unless it is labor

performed by convicts who are on parole, supervised release, or probation. The term Federal-aid highway does not include roadways functionally classified as local roads or rural minor collectors.

II. NONDISCRIMINATION

The provisions of this section related to 23 CFR Part 230 are applicable to all Federal-aid construction contracts and to all related construction subcontracts of \$10,000 or more. The provisions of 23 CFR Part 230 are not applicable to material supply, engineering, or architectural service contracts.

In addition, the contractor and all subcontractors must comply with the following policies: Executive Order 11246, 41 CFR 60, 29 CFR 1625-1627, Title 23 USC Section 140, the Rehabilitation Act of 1973, as amended (29 USC 794), Title VI of the Civil Rights Act of 1964, as amended, and related regulations including 49 CFR Parts 21, 26 and 27; and 23 CFR Parts 200, 230, and 633.

The contractor and all subcontractors must comply with: the requirements of the Equal Opportunity Clause in 41 CFR 60-1.4(b) and, for all construction contracts exceeding \$10,000, the Standard Federal Equal Employment Opportunity Construction Contract Specifications in 41 CFR 60-4.3.

Note: The U.S. Department of Labor has exclusive authority to determine compliance with Executive Order 11246 and the policies of the Secretary of Labor including 41 CFR 60, and 29 CFR 1625-1627. The contracting agency and the FHWA have the authority and the responsibility to ensure compliance with Title 23 USC Section 140, the Rehabilitation Act of 1973, as amended (29 USC 794), and Title VI of the Civil Rights Act of 1964, as amended, and related regulations including 49 CFR Parts 21, 26 and 27; and 23 CFR Parts 200, 230, and 633.

The following provision is adopted from 23 CFR 230, Appendix A, with appropriate revisions to conform to the U.S. Department of Labor (US DOL) and FHWA requirements.

1. Equal Employment Opportunity: Equal employment opportunity (EEO) requirements not to discriminate and to take affirmative action to assure equal opportunity as set forth under laws, executive orders, rules, regulations (28 CFR 35, 29 CFR 1630, 29 CFR 1625-1627, 41 CFR 60 and 49 CFR 27) and orders of the Secretary of Labor as modified by the provisions prescribed herein, and imposed pursuant to 23 U.S.C. 140 shall constitute the EEO and specific affirmative action standards for the contractor's project activities under this contract. The provisions of the Americans with Disabilities Act of 1990 (42 U.S.C. 12101 et seq.) set forth under 28 CFR 35 and 29 CFR 1630 are incorporated by reference in this contract. In the execution of this contract, the contractor agrees to comply with the following minimum specific requirement activities of EEO:

a. The contractor will work with the contracting agency and the Federal Government to ensure that it has made every good faith effort to provide equal opportunity with respect to all of its terms and conditions of employment and in their review of activities under the contract.

b. The contractor will accept as its operating policy the following statement:

"It is the policy of this Company to assure that applicants are employed, and that employees are treated during employment, without regard to their race, religion, sex, color, national origin, age or disability. Such action shall include: employment, upgrading, demotion, or transfer; recruitment or recruitment advertising; layoff or termination; rates of pay or other forms of compensation; and selection

for training, including apprenticeship, pre-apprenticeship, and/or on-the-job training."

2. EEO Officer: The contractor will designate and make known to the contracting officers an EEO Officer who will have the responsibility for and must be capable of effectively administering and promoting an active EEO program and who must be assigned adequate authority and responsibility to do so.

3. Dissemination of Policy: All members of the contractor's staff who are authorized to hire, supervise, promote, and discharge employees, or who recommend such action, or who are substantially involved in such action, will be made fully cognizant of, and will implement, the contractor's EEO policy and contractual responsibilities to provide EEO in each grade and classification of employment. To ensure that the above agreement will be met, the following actions will be taken as a minimum:

a. Periodic meetings of supervisory and personnel office employees will be conducted before the start of work and then not less often than once every six months, at which time the contractor's EEO policy and its implementation will be reviewed and explained. The meetings will be conducted by the EEO Officer.

b. All new supervisory or personnel office employees will be given a thorough indoctrination by the EEO Officer, covering all major aspects of the contractor's EEO obligations within thirty days following their reporting for duty with the contractor.

c. All personnel who are engaged in direct recruitment for the project will be instructed by the EEO Officer in the contractor's procedures for locating and hiring minorities and women.

d. Notices and posters setting forth the contractor's EEO policy will be placed in areas readily accessible to employees, applicants for employment and potential employees.

e. The contractor's EEO policy and the procedures to implement such policy will be brought to the attention of employees by means of meetings, employee handbooks, or other appropriate means.

4. Recruitment: When advertising for employees, the contractor will include in all advertisements for employees the notation: "An Equal Opportunity Employer." All such advertisements will be placed in publications having a large circulation among minorities and women in the area from which the project work force would normally be derived.

a. The contractor will, unless precluded by a valid bargaining agreement, conduct systematic and direct recruitment through public and private employee referral sources likely to yield qualified minorities and women. To meet this requirement, the contractor will identify sources of potential minority group employees, and establish with such identified sources procedures whereby minority and women applicants may be referred to the contractor for employment consideration.

b. In the event the contractor has a valid bargaining agreement providing for exclusive hiring hall referrals, the contractor is expected to observe the provisions of that agreement to the extent that the system meets the contractor's compliance with EEO contract provisions. Where implementation of such an agreement has the effect of discriminating against minorities or women, or obligates the contractor to do the same, such implementation violates Federal nondiscrimination provisions.

c. The contractor will encourage its present employees to refer minorities and women as applicants for employment. Information and procedures with regard to referring such applicants will be discussed with employees.

5. Personnel Actions: Wages, working conditions, and employee benefits shall be established and administered, and personnel actions of every type, including hiring, upgrading, promotion, transfer, demotion, layoff, and termination, shall be taken without regard to race, color, religion, sex, national origin, age or disability. The following procedures shall be followed:

a. The contractor will conduct periodic inspections of project sites to insure that working conditions and employee facilities do not indicate discriminatory treatment of project site personnel.

b. The contractor will periodically evaluate the spread of wages paid within each classification to determine any evidence of discriminatory wage practices.

c. The contractor will periodically review selected personnel actions in depth to determine whether there is evidence of discrimination. Where evidence is found, the contractor will promptly take corrective action. If the review indicates that the discrimination may extend beyond the actions reviewed, such corrective action shall include all affected persons.

d. The contractor will promptly investigate all complaints of alleged discrimination made to the contractor in connection with its obligations under this contract, will attempt to resolve such complaints, and will take appropriate corrective action within a reasonable time. If the investigation indicates that the discrimination may affect persons other than the complainant, such corrective action shall include such other persons. Upon completion of each investigation, the contractor will inform every complainant of all of their avenues of appeal.

6. Training and Promotion:

a. The contractor will assist in locating, qualifying, and increasing the skills of minorities and women who are applicants for employment or current employees. Such efforts should be aimed at developing full journey level status employees in the type of trade or job classification involved.

b. Consistent with the contractor's work force requirements and as permissible under Federal and State regulations, the contractor shall make full use of training programs, i.e., apprenticeship, and on-the-job training programs for the geographical area of contract performance. In the event a special provision for training is provided under this contract, this subparagraph will be superseded as indicated in the special provision. The contracting agency may reserve training positions for persons who receive welfare assistance in accordance with 23 U.S.C. 140(a).

c. The contractor will advise employees and applicants for employment of available training programs and entrance requirements for each.

d. The contractor will periodically review the training and promotion potential of employees who are minorities and women and will encourage eligible employees to apply for such training and promotion.

7. Unions: If the contractor relies in whole or in part upon unions as a source of employees, the contractor will use good faith efforts to obtain the cooperation of such unions to increase opportunities for minorities and women. Actions by the contractor, either directly or through a contractor's association acting as agent, will include the procedures set forth below:

a. The contractor will use good faith efforts to develop, in cooperation with the unions, joint training programs aimed toward qualifying more minorities and women for membership in the unions and increasing the skills of minorities and women so that they may qualify for higher paying employment.

b. The contractor will use good faith efforts to incorporate an EEO clause into each union agreement to the end that such union will be contractually bound to refer applicants without regard to their race, color, religion, sex, national origin, age or disability.

c. The contractor is to obtain information as to the referral practices and policies of the labor union except that to the extent such information is within the exclusive possession of the labor union and such labor union refuses to furnish such information to the contractor, the contractor shall so certify to the contracting agency and shall set forth what efforts have been made to obtain such information.

d. In the event the union is unable to provide the contractor with a reasonable flow of referrals within the time limit set forth in the collective bargaining agreement, the contractor will, through independent recruitment efforts, fill the employment vacancies without regard to race, color, religion, sex, national origin, age or disability; making full efforts to obtain qualified and/or qualifiable minorities and women. The failure of a union to provide sufficient referrals (even though it is obligated to provide exclusive referrals under the terms of a collective bargaining agreement) does not relieve the contractor from the requirements of this paragraph. In the event the union referral practice prevents the contractor from meeting the obligations pursuant to Executive Order 11246, as amended, and these special provisions, such contractor shall immediately notify the contracting agency.

8. Reasonable Accommodation for Applicants / Employees with Disabilities: The contractor must be familiar with the requirements for and comply with the Americans with Disabilities Act and all rules and regulations established there under. Employers must provide reasonable accommodation in all employment activities unless to do so would cause an undue hardship.

9. Selection of Subcontractors, Procurement of Materials and Leasing of Equipment: The contractor shall not discriminate on the grounds of race, color, religion, sex, national origin, age or disability in the selection and retention of subcontractors, including procurement of materials and leases of equipment. The contractor shall take all necessary and reasonable steps to ensure nondiscrimination in the administration of this contract.

a. The contractor shall notify all potential subcontractors and suppliers and lessors of their EEO obligations under this contract.

b. The contractor will use good faith efforts to ensure subcontractor compliance with their EEO obligations.

10. Assurance Required by 49 CFR 26.13(b):

a. The requirements of 49 CFR Part 26 and the State DOT's U.S. DOT-approved DBE program are incorporated by reference.

b. The contractor or subcontractor shall not discriminate on the basis of race, color, national origin, or sex in the performance of this contract. The contractor shall carry out applicable requirements of 49 CFR Part 26 in the award and administration of DOT-assisted contracts. Failure by the contractor to carry out these requirements is a material breach of this contract, which may result in the termination of this contract or such other remedy as the contracting agency deems appropriate.

11. Records and Reports: The contractor shall keep such records as necessary to document compliance with the EEO requirements. Such records shall be retained for a period of three years following the date of the final payment to the contractor for all contract work and shall be available at reasonable times and places for inspection by authorized representatives of the contracting agency and the FHWA.

a. The records kept by the contractor shall document the following:

(1) The number and work hours of minority and non-minority group members and women employed in each work classification on the project;

(2) The progress and efforts being made in cooperation with unions, when applicable, to increase employment opportunities for minorities and women; and

(3) The progress and efforts being made in locating, hiring, training, qualifying, and upgrading minorities and women;

b. The contractors and subcontractors will submit an annual report to the contracting agency each July for the duration of the project, indicating the number of minority, women, and non-minority group employees currently engaged in each work classification required by the contract work. This information is to be reported on [Form FHWA-1391](#).

The staffing data should represent the project work force on board in all or any part of the last payroll period preceding the end of July. If on-the-job training is being required by special provision, the contractor will be required to collect and report training data. The employment data should reflect the work force on board during all or any part of the last payroll period preceding the end of July.

III. NONSEGREGATED FACILITIES

This provision is applicable to all Federal-aid construction contracts and to all related construction subcontracts of \$10,000 or more.

The contractor must ensure that facilities provided for employees are provided in such a manner that segregation on the basis of race, color, religion, sex, or national origin cannot result. The contractor may neither require such segregated use by written or oral policies nor tolerate such use by employee custom. The contractor's obligation extends further to ensure that its employees are not assigned to perform their services at any location, under the contractor's control, where the facilities are segregated. The term "facilities" includes waiting rooms, work areas, restaurants and other eating areas, time clocks, restrooms, washrooms, locker rooms, and other storage or dressing areas, parking lots, drinking fountains, recreation or entertainment areas, transportation, and housing provided for employees. The contractor shall provide separate or single-user restrooms and necessary dressing or sleeping areas to assure privacy between sexes.

IV. DAVIS-BACON AND RELATED ACT PROVISIONS

This section is applicable to all Federal-aid construction projects exceeding \$2,000 and to all related subcontracts and lower-tier subcontracts (regardless of subcontract size). The requirements apply to all projects located within the right-of-way of a roadway that is functionally classified as Federal-aid highway. This excludes roadways functionally classified as local roads or rural minor collectors, which are exempt. Contracting agencies may elect to apply these requirements to other projects.

The following provisions are from the U.S. Department of Labor regulations in 29 CFR 5.5 "Contract provisions and related matters" with minor revisions to conform to the FHWA-1273 format and FHWA program requirements.

1. Minimum wages

a. All laborers and mechanics employed or working upon the site of the work, will be paid unconditionally and not less often than once a week, and without subsequent deduction or rebate on any account (except such payroll deductions as are permitted by regulations issued by the Secretary of Labor under the Copeland Act (29 CFR part 3)), the full amount of wages and bona fide fringe benefits (or cash equivalents thereof) due at time of payment computed at rates not less than those contained in the wage determination of the Secretary of Labor which is attached hereto and made a part hereof, regardless of any contractual relationship which may be alleged to exist between the contractor and such laborers and mechanics.

Contributions made or costs reasonably anticipated for bona fide fringe benefits under section 1(b)(2) of the Davis-Bacon Act on behalf of laborers or mechanics are considered wages paid to such laborers or mechanics, subject to the provisions of paragraph 1.d. of this section; also, regular contributions made or costs incurred for more than a weekly period (but not less often than quarterly) under plans, funds, or programs which cover the particular weekly period, are deemed to be constructively made or incurred during such weekly period. Such laborers and mechanics shall be paid the appropriate wage rate and fringe benefits on the wage determination for the classification of work actually performed, without regard to skill, except as provided in 29 CFR 5.5(a)(4). Laborers or mechanics performing work in more than one classification may be compensated at the rate specified for each

classification for the time actually worked therein: Provided, That the employer's payroll records accurately set forth the time spent in each classification in which work is performed. The wage determination (including any additional classification and wage rates conformed under paragraph 1.b. of this section) and the Davis-Bacon poster (WH-1321) shall be posted at all times by the contractor and its subcontractors at the site of the work in a prominent and accessible place where it can be easily seen by the workers.

b. (1) The contracting officer shall require that any class of laborers or mechanics, including helpers, which is not listed in the wage determination and which is to be employed under the contract shall be classified in conformance with the wage determination. The contracting officer shall approve an additional classification and wage rate and fringe benefits therefore only when the following criteria have been met:

(i) The work to be performed by the classification requested is not performed by a classification in the wage determination; and

(ii) The classification is utilized in the area by the construction industry; and

(iii) The proposed wage rate, including any bona fide fringe benefits, bears a reasonable relationship to the wage rates contained in the wage determination.

(2) If the contractor and the laborers and mechanics to be employed in the classification (if known), or their representatives, and the contracting officer agree on the classification and wage rate (including the amount designated for fringe benefits where appropriate), a report of the action taken shall be sent by the contracting officer to the Administrator of the Wage and Hour Division, Employment Standards Administration, U.S. Department of Labor, Washington, DC 20210. The Administrator, or an authorized representative, will approve, modify, or disapprove every additional classification action within 30 days of receipt and so advise the contracting officer or will notify the contracting officer within the 30-day period that additional time is necessary.

(3) In the event the contractor, the laborers or mechanics to be employed in the classification or their representatives, and the contracting officer do not agree on the proposed classification and wage rate (including the amount designated for fringe benefits, where appropriate), the contracting officer shall refer the questions, including the views of all interested parties and the recommendation of the contracting officer, to the Wage and Hour Administrator for determination. The Wage and Hour Administrator, or an authorized representative, will issue a determination within 30 days of receipt and so advise the contracting officer or will notify the contracting officer within the 30-day period that additional time is necessary.

(4) The wage rate (including fringe benefits where appropriate) determined pursuant to paragraphs 1.b.(2) or 1.b.(3) of this section, shall be paid to all workers performing work in the classification under this contract from the first day on which work is performed in the classification.

c. Whenever the minimum wage rate prescribed in the contract for a class of laborers or mechanics includes a fringe benefit which is not expressed as an hourly rate, the contractor shall either pay the benefit as stated in the wage determination or shall pay another bona fide fringe benefit or an hourly cash equivalent thereof.

d. If the contractor does not make payments to a trustee or other third person, the contractor may consider as part of the wages of any laborer or mechanic the amount of any costs reasonably anticipated in providing bona fide fringe benefits under a plan or program, Provided, That the Secretary of Labor has found, upon the written request of the contractor, that the applicable standards of the Davis-Bacon Act have been met. The Secretary of Labor may require the contractor to set aside in a

separate account assets for the meeting of obligations under the plan or program.

2. Withholding

The contracting agency shall upon its own action or upon written request of an authorized representative of the Department of Labor, withhold or cause to be withheld from the contractor under this contract, or any other Federal contract with the same prime contractor, or any other federally-assisted contract subject to Davis-Bacon prevailing wage requirements, which is held by the same prime contractor, so much of the accrued payments or advances as may be considered necessary to pay laborers and mechanics, including apprentices, trainees, and helpers, employed by the contractor or any subcontractor the full amount of wages required by the contract. In the event of failure to pay any laborer or mechanic, including any apprentice, trainee, or helper, employed or working on the site of the work, all or part of the wages required by the contract, the contracting agency may, after written notice to the contractor, take such action as may be necessary to cause the suspension of any further payment, advance, or guarantee of funds until such violations have ceased.

3. Payrolls and basic records

a. Payrolls and basic records relating thereto shall be maintained by the contractor during the course of the work and preserved for a period of three years thereafter for all laborers and mechanics working at the site of the work. Such records shall contain the name, address, and social security number of each such worker, his or her correct classification, hourly rates of wages paid (including rates of contributions or costs anticipated for bona fide fringe benefits or cash equivalents thereof of the types described in section 1(b)(2)(B) of the Davis-Bacon Act), daily and weekly number of hours worked, deductions made and actual wages paid. Whenever the Secretary of Labor has found under 29 CFR 5.5(a)(1)(iv) that the wages of any laborer or mechanic include the amount of any costs reasonably anticipated in providing benefits under a plan or program described in section 1(b)(2)(B) of the Davis-Bacon Act, the contractor shall maintain records which show that the commitment to provide such benefits is enforceable, that the plan or program is financially responsible, and that the plan or program has been communicated in writing to the laborers or mechanics affected, and records which show the costs anticipated or the actual cost incurred in providing such benefits. Contractors employing apprentices or trainees under approved programs shall maintain written evidence of the registration of apprenticeship programs and certification of trainee programs, the registration of the apprentices and trainees, and the ratios and wage rates prescribed in the applicable programs.

b. (1) The contractor shall submit weekly for each week in which any contract work is performed a copy of all payrolls to the contracting agency. The payrolls submitted shall set out accurately and completely all of the information required to be maintained under 29 CFR 5.5(a)(3)(i), except that full social security numbers and home addresses shall not be included on weekly transmittals. Instead the payrolls shall only need to include an individually identifying number for each employee (e.g. , the last four digits of the employee's social security number). The required weekly payroll information may be submitted in any form desired. Optional Form WH-347 is available for this purpose from the Wage and Hour Division Web site at <http://www.dol.gov/esa/whd/forms/wh347instr.htm> or its successor site. The prime contractor is responsible for the submission of copies of payrolls by all subcontractors. Contractors and subcontractors shall maintain the full social security number and current address of each covered worker, and shall provide them upon request to the contracting agency for transmission to the State DOT, the FHWA or the Wage and Hour Division of the Department of Labor for purposes of an investigation or audit of compliance with prevailing wage requirements. It is not a violation of this section for a prime contractor to require a subcontractor to provide addresses and social security numbers to the prime contractor for its own records, without weekly submission to the contracting agency..

(2) Each payroll submitted shall be accompanied by a "Statement of Compliance," signed by the contractor or subcontractor or his or her agent who pays or supervises the payment of the persons employed under the contract and shall certify the following:

(i) That the payroll for the payroll period contains the information required to be provided under §5.5 (a)(3)(ii) of Regulations, 29 CFR part 5, the appropriate information is being maintained under §5.5 (a)(3)(i) of Regulations, 29 CFR part 5, and that such information is correct and complete;

(ii) That each laborer or mechanic (including each helper, apprentice, and trainee) employed on the contract during the payroll period has been paid the full weekly wages earned, without rebate, either directly or indirectly, and that no deductions have been made either directly or indirectly from the full wages earned, other than permissible deductions as set forth in Regulations, 29 CFR part 3;

(iii) That each laborer or mechanic has been paid not less than the applicable wage rates and fringe benefits or cash equivalents for the classification of work performed, as specified in the applicable wage determination incorporated into the contract.

(3) The weekly submission of a properly executed certification set forth on the reverse side of Optional Form WH-347 shall satisfy the requirement for submission of the "Statement of Compliance" required by paragraph 3.b.(2) of this section.

(4) The falsification of any of the above certifications may subject the contractor or subcontractor to civil or criminal prosecution under section 1001 of title 18 and section 231 of title 31 of the United States Code.

c. The contractor or subcontractor shall make the records required under paragraph 3.a. of this section available for inspection, copying, or transcription by authorized representatives of the contracting agency, the State DOT, the FHWA, or the Department of Labor, and shall permit such representatives to interview employees during working hours on the job. If the contractor or subcontractor fails to submit the required records or to make them available, the FHWA may, after written notice to the contractor, the contracting agency or the State DOT, take such action as may be necessary to cause the suspension of any further payment, advance, or guarantee of funds. Furthermore, failure to submit the required records upon request or to make such records available may be grounds for debarment action pursuant to 29 CFR 5.12.

4. Apprentices and trainees

a. Apprentices (programs of the USDOL).

Apprentices will be permitted to work at less than the predetermined rate for the work they performed when they are employed pursuant to and individually registered in a bona fide apprenticeship program registered with the U.S. Department of Labor, Employment and Training Administration, Office of Apprenticeship Training, Employer and Labor Services, or with a State Apprenticeship Agency recognized by the Office, or if a person is employed in his or her first 90 days of probationary employment as an apprentice in such an apprenticeship program, who is not individually registered in the program, but who has been certified by the Office of Apprenticeship Training, Employer and Labor Services or a State Apprenticeship Agency (where appropriate) to be eligible for probationary employment as an apprentice.

The allowable ratio of apprentices to journeymen on the job site in any craft classification shall not be greater than the ratio permitted to the contractor as to the entire work force under the registered program. Any worker listed on a payroll at an apprentice wage rate, who is not registered or otherwise employed as stated above, shall be paid not less than the applicable wage rate on the wage determination for the classification of work actually performed. In addition, any apprentice

performing work on the job site in excess of the ratio permitted under the registered program shall be paid not less than the applicable wage rate on the wage determination for the work actually performed. Where a contractor is performing construction on a project in a locality other than that in which its program is registered, the ratios and wage rates (expressed in percentages of the journeyman's hourly rate) specified in the contractor's or subcontractor's registered program shall be observed.

Every apprentice must be paid at not less than the rate specified in the registered program for the apprentice's level of progress, expressed as a percentage of the journeymen hourly rate specified in the applicable wage determination. Apprentices shall be paid fringe benefits in accordance with the provisions of the apprenticeship program. If the apprenticeship program does not specify fringe benefits, apprentices must be paid the full amount of fringe benefits listed on the wage determination for the applicable classification. If the Administrator determines that a different practice prevails for the applicable apprentice classification, fringes shall be paid in accordance with that determination.

In the event the Office of Apprenticeship Training, Employer and Labor Services, or a State Apprenticeship Agency recognized by the Office, withdraws approval of an apprenticeship program, the contractor will no longer be permitted to utilize apprentices at less than the applicable predetermined rate for the work performed until an acceptable program is approved.

b. Trainees (programs of the USDOL).

Except as provided in 29 CFR 5.16, trainees will not be permitted to work at less than the predetermined rate for the work performed unless they are employed pursuant to and individually registered in a program which has received prior approval, evidenced by formal certification by the U.S. Department of Labor, Employment and Training Administration.

The ratio of trainees to journeymen on the job site shall not be greater than permitted under the plan approved by the Employment and Training Administration.

Every trainee must be paid at not less than the rate specified in the approved program for the trainee's level of progress, expressed as a percentage of the journeyman hourly rate specified in the applicable wage determination. Trainees shall be paid fringe benefits in accordance with the provisions of the trainee program. If the trainee program does not mention fringe benefits, trainees shall be paid the full amount of fringe benefits listed on the wage determination unless the Administrator of the Wage and Hour Division determines that there is an apprenticeship program associated with the corresponding journeyman wage rate on the wage determination which provides for less than full fringe benefits for apprentices. Any employee listed on the payroll at a trainee rate who is not registered and participating in a training plan approved by the Employment and Training Administration shall be paid not less than the applicable wage rate on the wage determination for the classification of work actually performed. In addition, any trainee performing work on the job site in excess of the ratio permitted under the registered program shall be paid not less than the applicable wage rate on the wage determination for the work actually performed.

In the event the Employment and Training Administration withdraws approval of a training program, the contractor will no longer be permitted to utilize trainees at less than the applicable predetermined rate for the work performed until an acceptable program is approved.

c. Equal employment opportunity. The utilization of apprentices, trainees and journeymen under this part shall be in conformity with the equal employment opportunity requirements of Executive Order 11246, as amended, and 29 CFR part 30.

d. Apprentices and Trainees (programs of the U.S. DOT).

Apprentices and trainees working under apprenticeship and skill training programs which have been certified by the Secretary of Transportation as promoting EEO in connection with Federal-aid highway construction programs are not subject to the requirements of paragraph 4 of this Section IV. The straight time hourly wage rates for apprentices and trainees under such programs will be established by the particular programs. The ratio of apprentices and trainees to journeymen shall not be greater than permitted by the terms of the particular program.

5. Compliance with Copeland Act requirements. The contractor shall comply with the requirements of 29 CFR part 3, which are incorporated by reference in this contract.

6. Subcontracts. The contractor or subcontractor shall insert Form FHWA-1273 in any subcontracts and also require the subcontractors to include Form FHWA-1273 in any lower tier subcontracts. The prime contractor shall be responsible for the compliance by any subcontractor or lower tier subcontractor with all the contract clauses in 29 CFR 5.5.

7. Contract termination: debarment. A breach of the contract clauses in 29 CFR 5.5 may be grounds for termination of the contract, and for debarment as a contractor and a subcontractor as provided in 29 CFR 5.12.

8. Compliance with Davis-Bacon and Related Act requirements. All rulings and interpretations of the Davis-Bacon and Related Acts contained in 29 CFR parts 1, 3, and 5 are herein incorporated by reference in this contract.

9. Disputes concerning labor standards. Disputes arising out of the labor standards provisions of this contract shall not be subject to the general disputes clause of this contract. Such disputes shall be resolved in accordance with the procedures of the Department of Labor set forth in 29 CFR parts 5, 6, and 7. Disputes within the meaning of this clause include disputes between the contractor (or any of its subcontractors) and the contracting agency, the U.S. Department of Labor, or the employees or their representatives.

10. Certification of eligibility.

a. By entering into this contract, the contractor certifies that neither it (nor he or she) nor any person or firm who has an interest in the contractor's firm is a person or firm ineligible to be awarded Government contracts by virtue of section 3(a) of the Davis-Bacon Act or 29 CFR 5.12(a)(1).

b. No part of this contract shall be subcontracted to any person or firm ineligible for award of a Government contract by virtue of section 3(a) of the Davis-Bacon Act or 29 CFR 5.12(a)(1).

c. The penalty for making false statements is prescribed in the U.S. Criminal Code, 18 U.S.C. 1001.

V. CONTRACT WORK HOURS AND SAFETY STANDARDS ACT

The following clauses apply to any Federal-aid construction contract in an amount in excess of \$100,000 and subject to the overtime provisions of the Contract Work Hours and Safety Standards Act. These clauses shall be inserted in addition to the clauses required by 29 CFR 5.5(a) or 29 CFR 4.6. As used in this paragraph, the terms laborers and mechanics include watchmen and guards.

1. Overtime requirements. No contractor or subcontractor contracting for any part of the contract work which may require or involve the employment of laborers or mechanics shall require or permit any such laborer or mechanic in any workweek in which he or she is employed on such work to work in excess of forty hours in such workweek unless such laborer or mechanic receives compensation at a rate not less than one

and one-half times the basic rate of pay for all hours worked in excess of forty hours in such workweek.

2. Violation; liability for unpaid wages; liquidated damages. In the event of any violation of the clause set forth in paragraph (1.) of this section, the contractor and any subcontractor responsible therefor shall be liable for the unpaid wages. In addition, such contractor and subcontractor shall be liable to the United States (in the case of work done under contract for the District of Columbia or a territory, to such District or to such territory), for liquidated damages. Such liquidated damages shall be computed with respect to each individual laborer or mechanic, including watchmen and guards, employed in violation of the clause set forth in paragraph (1.) of this section, in the sum of \$10 for each calendar day on which such individual was required or permitted to work in excess of the standard workweek of forty hours without payment of the overtime wages required by the clause set forth in paragraph (1.) of this section.

3. Withholding for unpaid wages and liquidated damages. The FHWA or the contracting agency shall upon its own action or upon written request of an authorized representative of the Department of Labor withhold or cause to be withheld, from any moneys payable on account of work performed by the contractor or subcontractor under any such contract or any other Federal contract with the same prime contractor, or any other federally-assisted contract subject to the Contract Work Hours and Safety Standards Act, which is held by the same prime contractor, such sums as may be determined to be necessary to satisfy any liabilities of such contractor or subcontractor for unpaid wages and liquidated damages as provided in the clause set forth in paragraph (2.) of this section.

4. Subcontracts. The contractor or subcontractor shall insert in any subcontracts the clauses set forth in paragraph (1.) through (4.) of this section and also a clause requiring the subcontractors to include these clauses in any lower tier subcontracts. The prime contractor shall be responsible for compliance by any subcontractor or lower tier subcontractor with the clauses set forth in paragraphs (1.) through (4.) of this section.

VI. SUBLETTING OR ASSIGNING THE CONTRACT

This provision is applicable to all Federal-aid construction contracts on the National Highway System.

1. The contractor shall perform with its own organization contract work amounting to not less than 30 percent (or a greater percentage if specified elsewhere in the contract) of the total original contract price, excluding any specialty items designated by the contracting agency. Specialty items may be performed by subcontract and the amount of any such specialty items performed may be deducted from the total original contract price before computing the amount of work required to be performed by the contractor's own organization (23 CFR 635.116).

a. The term "perform work with its own organization" refers to workers employed or leased by the prime contractor, and equipment owned or rented by the prime contractor, with or without operators. Such term does not include employees or equipment of a subcontractor or lower tier subcontractor, agents of the prime contractor, or any other assignees. The term may include payments for the costs of hiring leased employees from an employee leasing firm meeting all relevant Federal and State regulatory requirements. Leased employees may only be included in this term if the prime contractor meets all of the following conditions:

(1) the prime contractor maintains control over the supervision of the day-to-day activities of the leased employees;

(2) the prime contractor remains responsible for the quality of the work of the leased employees;

(3) the prime contractor retains all power to accept or exclude individual employees from work on the project; and

(4) the prime contractor remains ultimately responsible for the payment of predetermined minimum wages, the submission of payrolls, statements of compliance and all other Federal regulatory requirements.

b. "Specialty Items" shall be construed to be limited to work that requires highly specialized knowledge, abilities, or equipment not ordinarily available in the type of contracting organizations qualified and expected to bid or propose on the contract as a whole and in general are to be limited to minor components of the overall contract.

2. The contract amount upon which the requirements set forth in paragraph (1) of Section VI is computed includes the cost of material and manufactured products which are to be purchased or produced by the contractor under the contract provisions.

3. The contractor shall furnish (a) a competent superintendent or supervisor who is employed by the firm, has full authority to direct performance of the work in accordance with the contract requirements, and is in charge of all construction operations (regardless of who performs the work) and (b) such other of its own organizational resources (supervision, management, and engineering services) as the contracting officer determines is necessary to assure the performance of the contract.

4. No portion of the contract shall be sublet, assigned or otherwise disposed of except with the written consent of the contracting officer, or authorized representative, and such consent when given shall not be construed to relieve the contractor of any responsibility for the fulfillment of the contract. Written consent will be given only after the contracting agency has assured that each subcontract is evidenced in writing and that it contains all pertinent provisions and requirements of the prime contract.

5. The 30% self-performance requirement of paragraph (1) is not applicable to design-build contracts; however, contracting agencies may establish their own self-performance requirements.

VII. SAFETY: ACCIDENT PREVENTION

This provision is applicable to all Federal-aid construction contracts and to all related subcontracts.

1. In the performance of this contract the contractor shall comply with all applicable Federal, State, and local laws governing safety, health, and sanitation (23 CFR 635). The contractor shall provide all safeguards, safety devices and protective equipment and take any other needed actions as it determines, or as the contracting officer may determine, to be reasonably necessary to protect the life and health of employees on the job and the safety of the public and to protect property in connection with the performance of the work covered by the contract.

2. It is a condition of this contract, and shall be made a condition of each subcontract, which the contractor enters into pursuant to this contract, that the contractor and any subcontractor shall not permit any employee, in performance of the contract, to work in surroundings or under conditions which are unsanitary, hazardous or dangerous to his/her health or safety, as determined under construction safety and health standards (29 CFR 1926) promulgated by the Secretary of Labor, in accordance with Section 107 of the Contract Work Hours and Safety Standards Act (40 U.S.C. 3704).

3. Pursuant to 29 CFR 1926.3, it is a condition of this contract that the Secretary of Labor or authorized representative thereof, shall have right of entry to any site of contract performance to inspect or investigate the matter of compliance with the construction safety and health standards and to carry out the duties of the Secretary under Section 107 of the Contract Work Hours and Safety Standards Act (40 U.S.C.3704).

VIII. FALSE STATEMENTS CONCERNING HIGHWAY PROJECTS

This provision is applicable to all Federal-aid construction contracts and to all related subcontracts.

In order to assure high quality and durable construction in conformity with approved plans and specifications and a high degree of reliability on statements and representations made by engineers, contractors, suppliers, and workers on Federal-aid highway projects, it is essential that all persons concerned with the project perform their functions as carefully, thoroughly, and honestly as possible. Willful falsification, distortion, or misrepresentation with respect to any facts related to the project is a violation of Federal law. To prevent any misunderstanding regarding the seriousness of these and similar acts, Form FHWA-1022 shall be posted on each Federal-aid highway project (23 CFR 635) in one or more places where it is readily available to all persons concerned with the project:

18 U.S.C. 1020 reads as follows:

"Whoever, being an officer, agent, or employee of the United States, or of any State or Territory, or whoever, whether a person, association, firm, or corporation, knowingly makes any false statement, false representation, or false report as to the character, quality, quantity, or cost of the material used or to be used, or the quantity or quality of the work performed or to be performed, or the cost thereof in connection with the submission of plans, maps, specifications, contracts, or costs of construction on any highway or related project submitted for approval to the Secretary of Transportation; or

Whoever knowingly makes any false statement, false representation, false report or false claim with respect to the character, quality, quantity, or cost of any work performed or to be performed, or materials furnished or to be furnished, in connection with the construction of any highway or related project approved by the Secretary of Transportation; or

Whoever knowingly makes any false statement or false representation as to material fact in any statement, certificate, or report submitted pursuant to provisions of the Federal-aid Roads Act approved July 1, 1916, (39 Stat. 355), as amended and supplemented;

Shall be fined under this title or imprisoned not more than 5 years or both."

IX. IMPLEMENTATION OF CLEAN AIR ACT AND FEDERAL WATER POLLUTION CONTROL ACT

This provision is applicable to all Federal-aid construction contracts and to all related subcontracts.

By submission of this bid/proposal or the execution of this contract, or subcontract, as appropriate, the bidder, proposer, Federal-aid construction contractor, or subcontractor, as appropriate, will be deemed to have stipulated as follows:

1. That any person who is or will be utilized in the performance of this contract is not prohibited from receiving an award due to a violation of Section 508 of the Clean Water Act or Section 306 of the Clean Air Act.

2. That the contractor agrees to include or cause to be included the requirements of paragraph (1) of this Section X in every subcontract, and further agrees to take such action as the contracting agency may direct as a means of enforcing such requirements.

X. CERTIFICATION REGARDING DEBARMENT, SUSPENSION, INELIGIBILITY AND VOLUNTARY EXCLUSION

This provision is applicable to all Federal-aid construction contracts, design-build contracts, subcontracts, lower-tier subcontracts, purchase orders, lease agreements, consultant contracts or any other covered transaction requiring FHWA approval or that is estimated to cost \$25,000 or more – as defined in 2 CFR Parts 180 and 1200.

1. Instructions for Certification – First Tier Participants:

a. By signing and submitting this proposal, the prospective first tier participant is providing the certification set out below.

b. The inability of a person to provide the certification set out below will not necessarily result in denial of participation in this covered transaction. The prospective first tier participant shall submit an explanation of why it cannot provide the certification set out below. The certification or explanation will be considered in connection with the department or agency's determination whether to enter into this transaction. However, failure of the prospective first tier participant to furnish a certification or an explanation shall disqualify such a person from participation in this transaction.

c. The certification in this clause is a material representation of fact upon which reliance was placed when the contracting agency determined to enter into this transaction. If it is later determined that the prospective participant knowingly rendered an erroneous certification, in addition to other remedies available to the Federal Government, the contracting agency may terminate this transaction for cause of default.

d. The prospective first tier participant shall provide immediate written notice to the contracting agency to whom this proposal is submitted if any time the prospective first tier participant learns that its certification was erroneous when submitted or has become erroneous by reason of changed circumstances.

e. The terms "covered transaction," "debarred," "suspended," "ineligible," "participant," "person," "principal," and "voluntarily excluded," as used in this clause, are defined in 2 CFR Parts 180 and 1200. "First Tier Covered Transactions" refers to any covered transaction between a grantee or subgrantee of Federal funds and a participant (such as the prime or general contract). "Lower Tier Covered Transactions" refers to any covered transaction under a First Tier Covered Transaction (such as subcontracts). "First Tier Participant" refers to the participant who has entered into a covered transaction with a grantee or subgrantee of Federal funds (such as the prime or general contractor). "Lower Tier Participant" refers any participant who has entered into a covered transaction with a First Tier Participant or other Lower Tier Participants (such as subcontractors and suppliers).

f. The prospective first tier participant agrees by submitting this proposal that, should the proposed covered transaction be entered into, it shall not knowingly enter into any lower tier covered transaction with a person who is debarred, suspended, declared ineligible, or voluntarily excluded from participation in this covered transaction, unless authorized by the department or agency entering into this transaction.

g. The prospective first tier participant further agrees by submitting this proposal that it will include the clause titled "Certification Regarding Debarment, Suspension, Ineligibility and Voluntary Exclusion-Lower Tier Covered Transactions," provided by the department or contracting agency, entering into this covered transaction, without modification, in all lower tier covered transactions and in all solicitations for lower tier covered transactions exceeding the \$25,000 threshold.

h. A participant in a covered transaction may rely upon a certification of a prospective participant in a lower tier covered transaction that is not debarred, suspended, ineligible, or voluntarily excluded from the covered transaction, unless it knows that the certification is erroneous. A participant is responsible for ensuring that its principals are not suspended, debarred, or otherwise ineligible to participate in covered transactions. To verify the eligibility of its principals, as well as the eligibility of any lower tier prospective participants, each participant may, but is not required to, check the Excluded Parties List System website (<https://www.epls.gov/>), which is compiled by the General Services Administration.

i. Nothing contained in the foregoing shall be construed to require the establishment of a system of records in order to render in good faith the certification required by this clause. The knowledge and information of the prospective participant is not required to exceed that which is normally possessed by a prudent person in the ordinary course of business dealings.

j. Except for transactions authorized under paragraph (f) of these instructions, if a participant in a covered transaction knowingly enters into a lower tier covered transaction with a person who is suspended, debarred, ineligible, or voluntarily excluded from participation in this transaction, in addition to other remedies available to the Federal Government, the department or agency may terminate this transaction for cause or default.

* * * * *

2. Certification Regarding Debarment, Suspension, Ineligibility and Voluntary Exclusion – First Tier Participants:

a. The prospective first tier participant certifies to the best of its knowledge and belief, that it and its principals:

(1) Are not presently debarred, suspended, proposed for debarment, declared ineligible, or voluntarily excluded from participating in covered transactions by any Federal department or agency;

(2) Have not within a three-year period preceding this proposal been convicted of or had a civil judgment rendered against them for commission of fraud or a criminal offense in connection with obtaining, attempting to obtain, or performing a public (Federal, State or local) transaction or contract under a public transaction; violation of Federal or State antitrust statutes or commission of embezzlement, theft, forgery, bribery, falsification or destruction of records, making false statements, or receiving stolen property;

(3) Are not presently indicted for or otherwise criminally or civilly charged by a governmental entity (Federal, State or local) with commission of any of the offenses enumerated in paragraph (a)(2) of this certification; and

(4) Have not within a three-year period preceding this application/proposal had one or more public transactions (Federal, State or local) terminated for cause or default.

b. Where the prospective participant is unable to certify to any of the statements in this certification, such prospective participant shall attach an explanation to this proposal.

2. Instructions for Certification - Lower Tier Participants:

(Applicable to all subcontracts, purchase orders and other lower tier transactions requiring prior FHWA approval or estimated to cost \$25,000 or more - 2 CFR Parts 180 and 1200)

a. By signing and submitting this proposal, the prospective lower tier is providing the certification set out below.

b. The certification in this clause is a material representation of fact upon which reliance was placed when this transaction was entered into. If it is later determined that the prospective lower tier participant knowingly rendered an erroneous certification, in addition to other remedies available to the Federal Government, the department, or agency with which this transaction originated may pursue available remedies, including suspension and/or debarment.

c. The prospective lower tier participant shall provide immediate written notice to the person to which this proposal is submitted if at any time the prospective lower tier participant learns that its certification was erroneous by reason of changed circumstances.

d. The terms "covered transaction," "debarred," "suspended," "ineligible," "participant," "person," "principal," and "voluntarily excluded," as used in this clause, are defined in 2 CFR Parts 180 and 1200. You may contact the person to which this proposal is submitted for assistance in obtaining a copy of those regulations. "First Tier Covered Transactions" refers to any covered transaction between a grantee or subgrantee of Federal funds and a participant (such as the prime or general contract). "Lower Tier Covered Transactions" refers to any covered transaction under a First Tier Covered Transaction (such as subcontracts). "First Tier Participant" refers to the participant who has entered into a covered transaction with a grantee or subgrantee of

Federal funds (such as the prime or general contractor). "Lower Tier Participant" refers any participant who has entered into a covered transaction with a First Tier Participant or other Lower Tier Participants (such as subcontractors and suppliers).

e. The prospective lower tier participant agrees by submitting this proposal that, should the proposed covered transaction be entered into, it shall not knowingly enter into any lower tier covered transaction with a person who is debarred, suspended, declared ineligible, or voluntarily excluded from participation in this covered transaction, unless authorized by the department or agency with which this transaction originated.

f. The prospective lower tier participant further agrees by submitting this proposal that it will include this clause titled "Certification Regarding Debarment, Suspension, Ineligibility and Voluntary Exclusion-Lower Tier Covered Transaction," without modification, in all lower tier covered transactions and in all solicitations for lower tier covered transactions exceeding the \$25,000 threshold.

g. A participant in a covered transaction may rely upon a certification of a prospective participant in a lower tier covered transaction that is not debarred, suspended, ineligible, or voluntarily excluded from the covered transaction, unless it knows that the certification is erroneous. A participant is responsible for ensuring that its principals are not suspended, debarred, or otherwise ineligible to participate in covered transactions. To verify the eligibility of its principals, as well as the eligibility of any lower tier prospective participants, each participant may, but is not required to, check the Excluded Parties List System website (<https://www.epls.gov/>), which is compiled by the General Services Administration.

h. Nothing contained in the foregoing shall be construed to require establishment of a system of records in order to render in good faith the certification required by this clause. The knowledge and information of participant is not required to exceed that which is normally possessed by a prudent person in the ordinary course of business dealings.

i. Except for transactions authorized under paragraph e of these instructions, if a participant in a covered transaction knowingly enters into a lower tier covered transaction with a person who is suspended, debarred, ineligible, or voluntarily excluded from participation in this transaction, in addition to other remedies available to the Federal Government, the department or agency with which this transaction originated may pursue available remedies, including suspension and/or debarment.

* * * * *

Certification Regarding Debarment, Suspension, Ineligibility and Voluntary Exclusion--Lower Tier Participants:

1. The prospective lower tier participant certifies, by submission of this proposal, that neither it nor its principals is presently debarred, suspended, proposed for debarment, declared ineligible, or voluntarily excluded from participating in covered transactions by any Federal department or agency.

2. Where the prospective lower tier participant is unable to certify to any of the statements in this certification, such prospective participant shall attach an explanation to this proposal.

* * * * *

XI. CERTIFICATION REGARDING USE OF CONTRACT FUNDS FOR LOBBYING

This provision is applicable to all Federal-aid construction contracts and to all related subcontracts which exceed \$100,000 (49 CFR 20).

1. The prospective participant certifies, by signing and submitting this bid or proposal, to the best of his or her knowledge and belief, that:

a. No Federal appropriated funds have been paid or will be paid, by or on behalf of the undersigned, to any person for influencing or attempting to influence an officer or employee of any Federal agency, a Member of

Congress, an officer or employee of Congress, or an employee of a Member of Congress in connection with the awarding of any Federal contract, the making of any Federal grant, the making of any Federal loan, the entering into of any cooperative agreement, and the extension, continuation, renewal, amendment, or modification of any Federal contract, grant, loan, or cooperative agreement.

b. If any funds other than Federal appropriated funds have been paid or will be paid to any person for influencing or attempting to influence an officer or employee of any Federal agency, a Member of Congress, an officer or employee of Congress, or an employee of a Member of Congress in connection with this Federal contract, grant, loan, or cooperative agreement, the undersigned shall complete and submit Standard Form-LLL, "Disclosure Form to Report Lobbying," in accordance with its instructions.

2. This certification is a material representation of fact upon which reliance was placed when this transaction was made or entered into. Submission of this certification is a prerequisite for making or entering into this transaction imposed by 31 U.S.C. 1352. Any person who fails to file the required certification shall be subject to a civil penalty of not less than \$10,000 and not more than \$100,000 for each such failure.

3. The prospective participant also agrees by submitting its bid or proposal that the participant shall require that the language of this certification be included in all lower tier subcontracts, which exceed \$100,000 and that all such recipients shall certify and disclose accordingly.

ATTACHMENT A - EMPLOYMENT AND MATERIALS PREFERENCE FOR APPALACHIAN DEVELOPMENT HIGHWAY SYSTEM OR APPALACHIAN LOCAL ACCESS ROAD CONTRACTS

This provision is applicable to all Federal-aid projects funded under the Appalachian Regional Development Act of 1965.

1. During the performance of this contract, the contractor undertaking to do work which is, or reasonably may be, done as on-site work, shall give preference to qualified persons who regularly reside in the labor area as designated by the DOL wherein the contract work is situated, or the subregion, or the Appalachian counties of the State wherein the contract work is situated, except:

a. To the extent that qualified persons regularly residing in the area are not available.

b. For the reasonable needs of the contractor to employ supervisory or specially experienced personnel necessary to assure an efficient execution of the contract work.

c. For the obligation of the contractor to offer employment to present or former employees as the result of a lawful collective bargaining contract, provided that the number of nonresident persons employed under this subparagraph (1c) shall not exceed 20 percent of the total number of employees employed by the contractor on the contract work, except as provided in subparagraph (4) below.

2. The contractor shall place a job order with the State Employment Service indicating (a) the classifications of the laborers, mechanics and other employees required to perform the contract work, (b) the number of employees required in each classification, (c) the date on which the participant estimates such employees will be required, and (d) any other pertinent information required by the State Employment Service to complete the job order form. The job order may be placed with the State Employment Service in writing or by telephone. If during the course of the contract work, the information submitted by the contractor in the original job order is substantially modified, the participant shall promptly notify the State Employment Service.

3. The contractor shall give full consideration to all qualified job applicants referred to him by the State Employment Service. The contractor is not required to grant employment to any job applicants who, in his opinion, are not qualified to perform the classification of work required.

4. If, within one week following the placing of a job order by the contractor with the State Employment Service, the State Employment Service is unable to refer any qualified job applicants to the contractor, or less than the number requested, the State Employment Service will forward a certificate to the contractor indicating the unavailability of applicants. Such certificate shall be made a part of the contractor's permanent project records. Upon receipt of this certificate, the contractor may employ persons who do not normally reside in the labor area to fill positions covered by the certificate, notwithstanding the provisions of subparagraph (1c) above.

5. The provisions of 23 CFR 633.207(e) allow the contracting agency to provide a contractual preference for the use of mineral resource materials native to the Appalachian region.

6. The contractor shall include the provisions of Sections 1 through 4 of this Attachment A in every subcontract for work which is, or reasonably may be, done as on-site work.

Contract Provision - Cargo Preference Requirements

In accordance with Title 46 CFR § 381.7 (b), the contractor agrees—

“(1) To utilize privately owned United States-flag commercial vessels to ship at least 50 percent of the gross tonnage (computed separately for dry bulk carriers, dry cargo liners, and tankers) involved, whenever shipping any equipment, material, or commodities pursuant to this contract, to the extent such vessels are available at fair and reasonable rates for United States-flag commercial vessels.

(2) To furnish within 20 days following the date of loading for shipments originating within the United States or within 30 working days following the date of loading for shipments originating outside the United States, a legible copy of a rated, ‘on-board’ commercial ocean bill-of-lading in English for each shipment of cargo described in paragraph (b) (1) of this section to both the Contracting Officer (through the prime contractor in the case of subcontractor bills-of-lading) and to the Division of National Cargo, Office of Market Development, Maritime Administration, Washington, DC 20590.

(3) To insert the substance of the provisions of this clause in all subcontracts issued pursuant to this contract.”

Provisions (1) and (2) apply to materials or equipment that are acquired solely for the project. The two provisions do not apply to goods or materials that come into inventories independent of the project, such as shipments of Portland cement, asphalt cement, or aggregates, when industry suppliers and contractors use these materials to replenish existing inventories.

**MINIMUM WAGES FOR FEDERAL AND FEDERALLY
ASSISTED CONSTRUCTION CONTRACTS**

This project is funded, in part, with Federal-aid funds and, as such, is subject to the provisions of the Davis-Bacon Act of March 3, 1931, as amended (46 Sta. 1494, as amended, 40 U.S.C. 276a) and of other Federal statutes referred to in a 29 CFR Part 1, Appendix A, as well as such additional statutes as may from time to time be enacted containing provisions for the payment of wages determined to be prevailing by the Secretary of Labor in accordance with the Davis-Bacon Act and pursuant to the provisions of 29 CFR Part 1. The prevailing rates and fringe benefits shown in the General Wage Determination Decisions issued by the U.S. Department of Labor shall, in accordance with the provisions of the foregoing statutes, constitute the minimum wages payable on Federal and federally assisted construction projects to laborers and mechanics of the specified classes engaged on contract work of the character and in the localities described therein.

General Wage Determination Decisions, modifications and supersedes decisions thereto are to be used in accordance with the provisions of 29 CFR Parts 1 and 5. Accordingly, the applicable decision, together with any modifications issued, must be made a part of every contract for performance of the described work within the geographic area indicated as required by an applicable DBRA Federal prevailing wage law and 29 CFR Part 5. The wage rates and fringe benefits contained in the General Wage Determination Decision shall be the minimum paid by contractors and subcontractors to laborers and mechanics.