

STATE OF ILLINOIS
DEPARTMENT OF TRANSPORTATION

ROUTE NO.	REL.	COUNTY	TOTAL SHEETS	SHEET NO.
194	3HB-2	WINNEBAGO	171	83
F.A. ROUTE 194 SECTION 3HB-2 WINNEBAGO COUNTY				

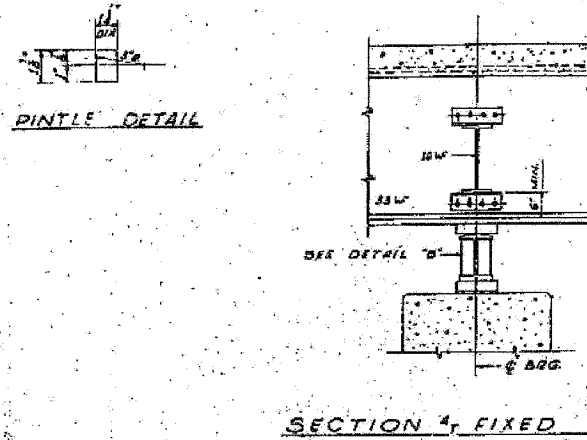

SECTION 2, FIXED PIER

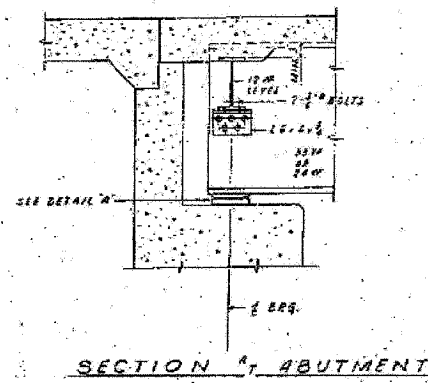
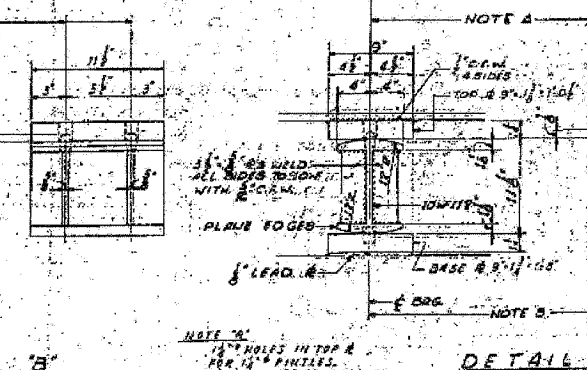
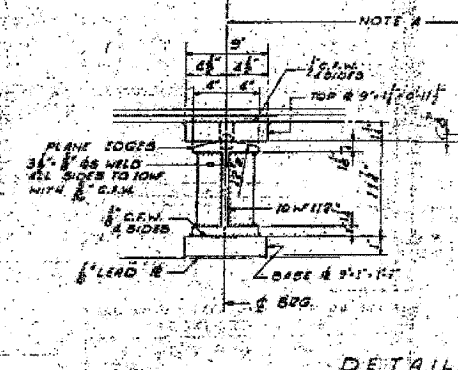
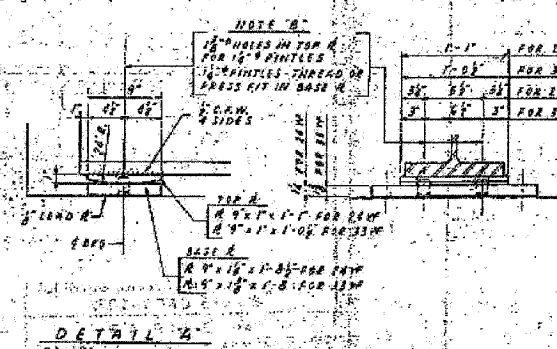
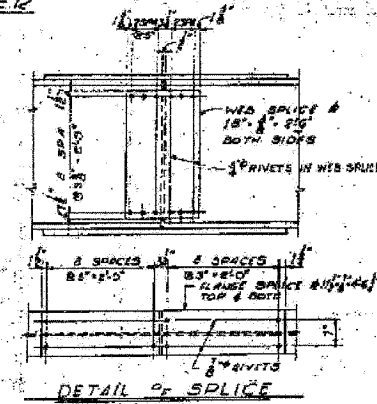
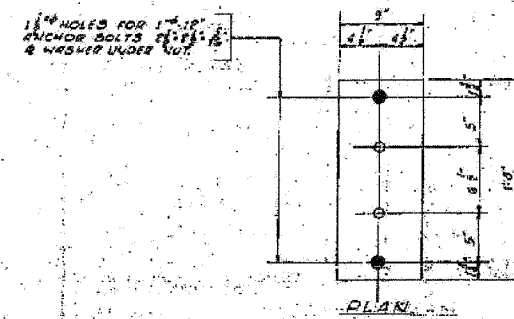
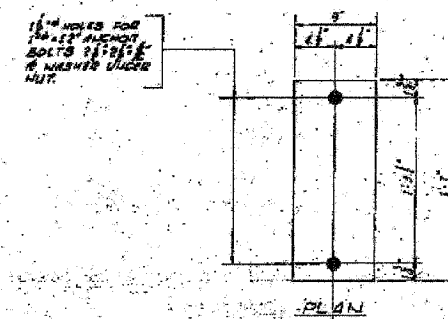
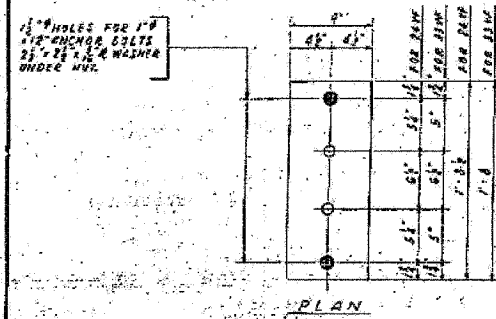
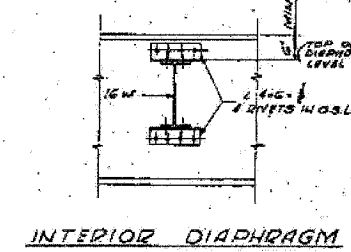
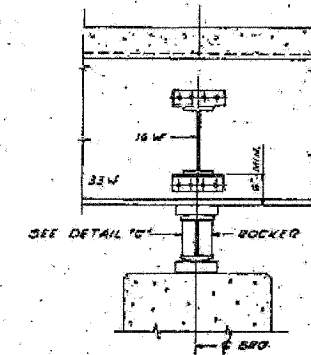

ILLINOIS DIVISION OF HIGHWAYS	
ROCKFORD BYPASS	
F.A.P. ROUTE 194	SECTION 3HB-2
PROJECT	WINNEBAGO COUNTY
STEEL DETAILS PART I	
DESIGNED BY: J.D.M.	CHECKED BY: J.P.P.

SHEET NO. 14	F.A.P. RTE.	SECTION	COUNTY	TOTAL SHEETS	SHEET NO.
	301	3HB-2	WINNEBAGO	171	83
19 SHEETS	CONTRACT NO. 64292				
FED. ROAD DIST. NO.		ILLINOIS	FED. AID PROJECT		