

If you plan to submit a bid directly to the Department of Transportation

PREQUALIFICATION

Any contractor who desires to become pre-qualified to bid on work advertised by IDOT must submit the properly completed pre-qualification forms to the Bureau of Construction no later than 4:30 p.m. prevailing time twenty-one days prior to the letting of interest. This pre-qualification requirement applies to first time contractors, contractors renewing expired ratings, contractors maintaining continuous pre-qualification or contractors requesting revised ratings. To be eligible to bid, existing pre-qualification ratings must be effective through the date of letting.

REQUESTS FOR AUTHORIZATION TO BID

Contractors downloading and/or ordering CD-ROM's and are wanting to bid on items included in a particular letting must submit the properly completed "Request for Authorization to Bid/or Not For Bid Status" (BDE 124INT) and the ORIGINAL, signed and notarized, "Affidavit of Availability" (BC 57) to the proper office no later than 4:30 p.m. prevailing time, three (3) days prior to the letting date.

WHO CAN BID ?

Bids will be accepted from only those companies that request and receive written **Authorization to Bid** from IDOT's Central Bureau of Construction.

WHAT CONSTITUTES WRITTEN AUTHORIZATION TO BID? When a prospective prime bidder submits a "Request for Authorization to Bid/or Not For Bid Status"(BDE 124INT) he/she must indicate at that time which items are being requested For Bidding purposes. Only those items requested For Bidding will be analyzed. After the request has been analyzed, the bidder will be issued a **Proposal Denial and/or Authorization Form**, approved by the Central Bureau of Construction, that indicates which items have been approved For Bidding. If **Authorization to Bid** cannot be approved, the **Proposal Denial and/or Authorization Form** will indicate the reason for denial.

ABOUT AUTHORIZATION TO BID: Firms that have not received an authorization form within a reasonable time of complete and correct original document submittal should contact the department as to status. This is critical in the week before the letting. These documents must be received three days before the letting date. Firms unsure as to authorization status should call the Prequalification Section of the Bureau of Construction at the number listed at the end of these instructions.

ADDENDA AND REVISIONS: It is the contractor's responsibility to determine which, if any, addenda or revisions pertain to any project they may be bidding. Failure to incorporate all relevant addenda or revisions may cause the bid to be declared unacceptable.

Each addendum will be placed with the contract number. Addenda and revisions will also be placed on the Addendum/Revision Checklist and each subscription service subscriber will be notified by e-mail of each addendum and revision issued.

The Internet is the Department's primary way of doing business. The subscription server e-mails are an added courtesy the Department provides. It is suggested that bidder check IDOT's website <http://www.dot.il.gov/desenv/delett.html> before submitting final bid information.

IDOT is not responsible for any e-mail related failures.

Addenda Questions may be directed to the Contracts Office at (217)782-7806 or D&Econtracts@dot.il.gov

Technical Questions about downloading these files may be directed to Tim Garman (217)524-1642 or Timothy.Garman@illinois.gov.

WHAT MUST BE INCLUDED WHEN BIDS ARE SUBMITTED?: Bidders need not return the entire proposal when bids are submitted. That portion of the proposal that must be returned includes the following:

1. All documents from the Proposal Cover Sheet through the Proposal Bid Bond
2. Other special documentation and/or information that may be required by the contract special provisions

All proposal documents, including Proposal Guaranty Checks or Proposal Bid Bonds, should be stapled together to prevent loss when bids are processed by IDOT personnel.

ABOUT SUBMITTING BIDS: It is recommended that bidders deliver bids in person to insure they arrive at the proper location prior to the time specified for the receipt of bids. Any bid received at the place of letting after the time specified will not be accepted.

WHO SHOULD BE CALLED IF ASSISTANCE IS NEEDED?

Questions Regarding	Call
Prequalification and/or Authorization to Bid	(217)782-3413
Preparation and submittal of bids	(217)782-7806
Mailing of plans and proposals	(217)782-7806
Electronic plans and proposals	(217)524-1642

ADDENDUMS AND REVISIONS TO THE PROPOSAL FORMS

Planholders should verify that they have received and incorporated the addendum and/or revision prior to submitting their bid. Failure by the bidder to include an addendum could result in a bid being rejected as irregular.

265

RETURN WITH BID

Proposal Submitted By
Name
Address
City

Letting June 13, 2008

BIDDERS NEED NOT RETURN THE ENTIRE PROPOSAL
(See instructions inside front cover)

NOTICE TO PROSPECTIVE BIDDERS

This proposal can be used for bidding purposes by only those companies that request and receive written AUTHORIZATION TO BID from IDOT's Central Bureau of Construction.
(SEE INSTRUCTIONS ON THE INSIDE OF COVER)

Notice To Bidders, Specifications, Proposal, Contract and Contract Bond



**Illinois Department
of Transportation**

Springfield, Illinois 62764

**Contract No. 68822
PEORIA-TAZEWELL Counties
Section D4 HIGHWAY LIGHTING 2008-1
District 4 Construction Funds
Route FAP 318/399**

PLEASE MARK THE APPROPRIATE BOX BELOW:

- A Bid Bond is included.
- A Cashier's Check or a Certified Check is included.

Plans Included
Herein

Prepared by

S

Checked by

(Printed by authority of the State of Illinois)

INSTRUCTIONS

ABOUT IDOT PROPOSALS: All proposals issued by IDOT are potential bidding proposals. Each proposal contains all Certifications and Affidavits, a Proposal Signature Sheet and a Proposal Bid Bond required for Prime Contractors to submit a bid after written **Authorization to Bid** has been issued by IDOT's Central Bureau of Construction.

WHO CAN BID?: Bids will be accepted from only those companies that request and receive written **Authorization to Bid** from IDOT's Central Bureau of Construction. To request authorization, a potential bidder must complete and submit Part B of the Request for Authorization to Bid/or Not For Bid Status form (BDE 124 INT) and submit an original Affidavit of Availability (BC 57).

WHAT CONSTITUTES WRITTEN AUTHORIZATION TO BID?: When a prospective prime bidder submits a "Request for Proposal Forms and Plans" he/she must indicate at that time which items are being requested For Bidding purposes. Only those items requested For Bidding will be analyzed. After the request has been analyzed, the bidder will be issued a **Proposal Denial and/or Authorization Form**, approved by the Central Bureau of Construction, that indicates which items have been approved For Bidding. If **Authorization to Bid** cannot be approved, the **Proposal Denial and/or Authorization Form** will indicate the reason for denial. If a contractor has requested to bid but has not received a **Proposal Denial and/or Authorization Form**, they should contact the Central Bureau of Construction in advance of the letting date.

WHAT MUST BE INCLUDED WHEN BIDS ARE SUBMITTED?: Bidders need not return the entire proposal when bids are submitted. That portion of the proposal that must be returned includes the following:

1. All documents from the Proposal Cover Sheet through the Proposal Bid Bond
2. Other special documentation and/or information that may be required by the contract special provisions

All proposal documents, including Proposal Guaranty Checks or Proposal Bid Bonds, should be stapled together to prevent loss when bids are processed by IDOT personnel.

ABOUT SUBMITTING BIDS: It is recommended that bidders deliver bids in person to insure they arrive at the proper location prior to the time specified for the receipt of bids. Any bid received at the place of letting after the time specified will not be accepted.

WHO SHOULD BE CALLED IF ASSISTANCE IS NEEDED?

Questions Regarding	Call
Prequalification and/or Authorization to Bid	217/782-3413
Preparation and submittal of bids	217/782-7806
Mailing of CD-ROMS	217/782-7806

RETURN WITH BID



PROPOSAL

TO THE DEPARTMENT OF TRANSPORTATION

1. Proposal of _____

Taxpayer Identification Number (Mandatory) _____ a

for the improvement identified and advertised for bids in the Invitation for Bids as:

**Contract No. 68822
PEORIA-TAZEWELL Counties
Section D4 HIGHWAY LIGHTING 2008-1
Route FAP 318/399
District 4 Construction Funds**

This project consists of replacing existing luminaires at various interchanges along IL Route 6 in Peoria County and at the IL Route 8 and Interstate 74 interchange in Tazewell County.

2. The undersigned bidder will furnish all labor, material and equipment to complete the above described project in a good and workmanlike manner as provided in the contract documents provided by the Department of Transportation. This proposal will become part of the contract and the terms and conditions contained in the contract documents shall govern performance and payments.

RETURN WITH BID

6. **COMBINATION BIDS.** The undersigned further agrees that if awarded the contract for the sections contained in the following combination, he/she will perform the work in accordance with the requirements of each individual proposal comprising the combination bid specified in the schedule below, and that the combination bid shall be prorated against each section in proportion to the bid submitted for the same. If an error is found to exist in the gross sum bid for one or more of the individual sections included in a combination, the combination bid shall be corrected as provided in the specifications.

When a combination bid is submitted, the schedule below must be completed in each proposal comprising the combination.

If alternate bids are submitted for one or more of the sections comprising the combination, a combination bid must be submitted for each alternate.

Schedule of Combination Bids

Combination No.	Sections Included in Combination	Combination Bid	
		Dollars	Cents

7. **SCHEDULE OF PRICES.** The undersigned bidder submits herewith, in accordance with the rules and instructions, a schedule of prices for the items of work for which bids are sought. The unit prices bid are in U.S. dollars and cents, and all extensions and summations have been made. The bidder understands that the quantities appearing in the bid schedule are approximate and are provided for the purpose of obtaining a gross sum for the comparison of bids. If there is an error in the extension of the unit prices, the unit prices shall govern. Payment to the contractor awarded the contract will be made only for actual quantities of work performed and accepted or materials furnished according to the contract. The scheduled quantities of work to be done and materials to be furnished may be increased, decreased or omitted as provided elsewhere in the contract.

8. **CERTIFICATE OF AUTHORITY.** The undersigned bidder, if a business organized under the laws of another State, assures the Department that it will furnish a copy of its certificate of authority to do business in the State of Illinois with the return of the executed contract and bond. Failure to furnish the certificate within the time provided for execution of an awarded contract may be cause for cancellation of the award and forfeiture of the proposal guaranty to the State.

RETURN WITH BID

STATE REQUIRED ETHICAL STANDARDS GOVERNING CONTRACT PROCUREMENT: ASSURANCES, CERTIFICATIONS AND DISCLOSURES

I. GENERAL

A. Article 50 of the Illinois Procurement Code establishes the duty of all State chief procurement officers, State purchasing officers, and their designees to maximize the value of the expenditure of public moneys in procuring goods, services, and contracts for the State of Illinois and to act in a manner that maintains the integrity and public trust of State government. In discharging this duty, they are charged by law to use all available information, reasonable efforts, and reasonable actions to protect, safeguard, and maintain the procurement process of the State of Illinois.

B. In order to comply with the provisions of Article 50 and to carry out the duty established therein, all bidders are to adhere to ethical standards established for the procurement process, and to make such assurances, disclosures and certifications required by law. By execution of the Proposal Signature Sheet, the bidder indicates that each of the mandated assurances has been read and understood, that each certification is made and understood, and that each disclosure requirement has been understood and completed.

C. In addition to all other remedies provided by law, failure to comply with any assurance, failure to make any disclosure or the making of a false certification shall be grounds for termination of the contract and the suspension or debarment of the bidder.

II. ASSURANCES

A. The assurances hereinafter made by the bidder are each a material representation of fact upon which reliance is placed should the Department enter into the contract with the bidder. The Department may terminate the contract if it is later determined that the bidder rendered a false or erroneous assurance, and the surety providing the performance bond shall be responsible for the completion of the contract.

B. Felons

1. The Illinois Procurement Code provides:

Section 50-10. Felons. Unless otherwise provided, no person or business convicted of a felony shall do business with the State of Illinois or any state agency from the date of conviction until 5 years after the date of completion of the sentence for that felony, unless no person held responsible by a prosecutorial office for the facts upon which the conviction was based continues to have any involvement with the business.

2. The bidder assures the Department that the award and execution of the contract would not cause a violation of Section 50-10.

C. Conflicts of Interest

1. The Illinois Procurement Code provides in pertinent part:

Section 50-13. Conflicts of Interest.

(a) Prohibition. It is unlawful for any person holding an elective office in this State, holding a seat in the General Assembly, or appointed to or employed in any of the offices or agencies of state government and who receives compensation for such employment in excess of 60% of the salary of the Governor of the State of Illinois, or who is an officer or employee of the Capital Development Board or the Illinois Toll Highway Authority, or who is the spouse or minor child of any such person to have or acquire any contract, or any direct pecuniary interest in any contract therein, whether for stationery, printing, paper, or any services, materials, or supplies, that will be wholly or partially satisfied by the payment of funds appropriated by the General Assembly of the State of Illinois or in any contract of the Capital Development Board or the Illinois Toll Highway authority.

(b) Interests. It is unlawful for any firm, partnership, association or corporation, in which any person listed in subsection (a) is entitled to receive (i) more than 7 1/2% of the total distributable income or (ii) an amount in excess of the salary of the Governor, to have or acquire any such contract or direct pecuniary interest therein.

(c) Combined interests. It is unlawful for any firm, partnership, association, or corporation, in which any person listed in subsection (a) together with his or her spouse or minor children is entitled to receive (i) more than 15%, in the aggregate, of the total distributable income or (ii) an amount in excess of 2 times the salary of the Governor, to have or acquire any such contract or direct pecuniary interest therein.

(d) Securities. Nothing in this Section invalidates the provisions of any bond or other security previously offered or to be offered for sale or sold by or for the State of Illinois.

(e) Prior interests. This Section does not affect the validity of any contract made between the State and an officer or employee of the State or member of the General Assembly, his or her spouse, minor child or any combination of those persons if that contract was in existence before his or her election or employment as an officer, member, or employee. The contract is voidable, however, if it cannot be completed within 365 days after the officer, member, or employee takes office or is employed.

The current salary of the Governor is \$171,000.00. Sixty percent of the salary is \$102,600.00.

RETURN WITH BID

2. The bidder assures the Department that the award and execution of the contract would not cause a violation of Section 50-13, or that an effective exemption has been issued by the Board of Ethics to any individual subject to the Section 50-13 prohibitions pursuant to the provisions of Section 50-20 of the Code and Executive Order Number 3 (1998). Information concerning the exemption process is available from the Department upon request.

D. Negotiations

1. The Illinois Procurement Code provides in pertinent part:

Section 50-15. Negotiations.

(a) It is unlawful for any person employed in or on a continual contractual relationship with any of the offices or agencies of State government to participate in contract negotiations on behalf of that office or agency with any firm, partnership, association, or corporation with whom that person has a contract for future employment or is negotiating concerning possible future employment.

2. The bidder assures the Department that the award and execution of the contract would not cause a violation of Section 50-15, and that the bidder has no knowledge of any facts relevant to the kinds of acts prohibited therein.

E. Inducements

1. The Illinois Procurement Code provides:

Section 50-25. Inducement. Any person who offers or pays any money or other valuable thing to any person to induce him or her not to bid for a State contract or as recompense for not having bid on a State contract is guilty of a Class 4 felony. Any person who accepts any money or other valuable thing for not bidding for a State contract or who withholds a bid in consideration of the promise for the payment of money or other valuable thing is guilty of a Class 4 felony.

2. The bidder assures the Department that the award and execution of the contract would not cause a violation of Section 50-25, and that the bidder has no knowledge of any facts relevant to the kinds of acts prohibited therein.

F. Revolving Door Prohibition

1. The Illinois Procurement Code provides:

Section 50-30. Revolving door prohibition. Chief procurement officers, associate procurement officers, State purchasing officers, their designees whose principal duties are directly related to State procurement, and executive officers confirmed by the Senate are expressly prohibited for a period of 2 years after terminating an affected position from engaging in any procurement activity relating to the State agency most recently employing them in an affected position for a period of at least 6 months. The prohibition includes, but is not limited to: lobbying the procurement process; specifying; bidding; proposing bid, proposal, or contract documents; on their own behalf or on behalf of any firm, partnership, association, or corporation. This Section applies only to persons who terminate an affected position on or after January 15, 1999.

2. The bidder assures the Department that the award and execution of the contract would not cause a violation of Section 50-30, and that the bidder has no knowledge of any facts relevant to the kinds of acts prohibited therein.

G. Reporting Anticompetitive Practices

1. The Illinois Procurement Code provides:

Section 50-40. Reporting anticompetitive practices. When, for any reason, any vendor, bidder, contractor, chief procurement officer, State purchasing officer, designee, elected official, or State employee suspects collusion or other anticompetitive practice among any bidders, offerors, contractors, proposers, or employees of the State, a notice of the relevant facts shall be transmitted to the Attorney General and the chief procurement officer.

2. The bidder assures the Department that it has not failed to report any relevant facts concerning the practices addressed in Section 50-40 which may involve the contract for which the bid is submitted.

H. Confidentiality

1. The Illinois Procurement Code provides:

Section 50-45. Confidentiality. Any chief procurement officer, State purchasing officer, designee, or executive officer who willfully uses or allows the use of specifications, competitive bid documents, proprietary competitive information, proposals, contracts, or selection information to compromise the fairness or integrity of the procurement, bidding, or contract process shall be subject to immediate dismissal, regardless of the Personnel code, any contract, or any collective bargaining agreement, and may in addition be subject to criminal prosecution.

2. The bidder assures the Department that it has no knowledge of any fact relevant to the practices addressed in Section 50-45 which may involve the contract for which the bid is submitted.

RETURN WITH BID

I. Insider Information

1. The Illinois Procurement Act provides:

Section 50-50. Insider information. It is unlawful for any current or former elected or appointed State official or State employee to knowingly use confidential information available only by virtue of that office or employment for actual or anticipated gain for themselves or another person.

2. The bidder assures the Department that it has no knowledge of any facts relevant to the practices addressed in Section 50-50 which may involve the contract for which the bid is submitted.

III. CERTIFICATIONS

A. The certifications hereinafter made by the bidder are each a material representation of fact upon which reliance is placed should the Department enter into the contract with the bidder. The Department may terminate the contract if it is later determined that the bidder rendered a false or erroneous certification, and the surety providing the performance bond shall be responsible for completion of the contract.

B. Bribery

1. The Illinois Procurement Code provides:

Section 50-5. Bribery.

(a) Prohibition. No person or business shall be awarded a contract or subcontract under this Code who:

(1) has been convicted under the laws of Illinois or any other state of bribery or attempting to bribe an officer or employee of the State of Illinois or any other state in that officer's or employee's official capacity; or

(2) has made an admission of guilt of that conduct that is a matter of record but has not been prosecuted for that conduct.

(b) Businesses. No business shall be barred from contracting with any unit of State or local government as a result of a conviction under this Section of any employee or agent of the business if the employee or agent is no longer employed by the business and:

(1) the business has been finally adjudicated not guilty; or

(2) the business demonstrates to the governmental entity with which it seeks to contract, and that entity finds that the commission of the offense was not authorized, requested, commanded, or performed by a director, officer, or high managerial agent on behalf of the business as provided in paragraph (2) of subsection (a) of Section 5-4 of the Criminal Code of 1961.

(c) Conduct on behalf of business. For purposes of this Section, when an official, agent, or employee of a business committed the bribery or attempted bribery on behalf of the business and in accordance with the direction or authorization of a responsible official of the business, the business shall be chargeable with the conduct.

(d) Certification. Every bid submitted to and contract executed by the State shall contain a certification by the contractor that the contractor is not barred from being awarded a contract or subcontract under this Section. A contractor who makes a false statement, material to the certification, commits a Class 3 felony.

2. The bidder certifies that it is not barred from being awarded a contract under Section 50.5.

C. Educational Loan

1. Section 3 of the Educational Loan Default Act provides:

§ 3. No State agency shall contract with an individual for goods or services if that individual is in default, as defined in Section 2 of this Act, on an educational loan. Any contract used by any State agency shall include a statement certifying that the individual is not in default on an educational loan as provided in this Section.

2. The bidder, if an individual as opposed to a corporation, partnership or other form of business organization, certifies that the bidder is not in default on an educational loan as provided in Section 3 of the Act.

D. Bid-Rigging/Bid Rotating

1. Section 33E-11 of the Criminal Code of 1961 provides:

§ 33E-11. (a) Every bid submitted to and public contract executed pursuant to such bid by the State or a unit of local government shall contain a certification by the prime contractor that the prime contractor is not barred from contracting with any unit of State or local government as a result of a violation of either Section 33E-3 or 33E-4 of this Article. The State and units of local government shall provide the appropriate forms for such certification.

RETURN WITH BID

(b) A contractor who makes a false statement, material to the certification, commits a Class 3 felony.

A violation of Section 33E-3 would be represented by a conviction of the crime of bid-rigging which, in addition to Class 3 felony sentencing, provides that any person convicted of this offense or any similar offense of any state or the United States which contains the same elements as this offense shall be barred for 5 years from the date of conviction from contracting with any unit of State or local government. No corporation shall be barred from contracting with any unit of State or local government as a result of a conviction under this Section of any employee or agent of such corporation if the employee so convicted is no longer employed by the corporation and: (1) it has been finally adjudicated not guilty or (2) if it demonstrates to the governmental entity with which it seeks to contract and that entity finds that the commission of the offense was neither authorized, requested, commanded, nor performed by a director, officer or a high managerial agent in behalf of the corporation.

A violation of Section 33E-4 would be represented by a conviction of the crime of bid-rotating which, in addition to Class 2 felony sentencing, provides that any person convicted of this offense or any similar offense of any state or the United States which contains the same elements as this offense shall be permanently barred from contracting with any unit of State or local government. No corporation shall be barred from contracting with any unit of State or local government as a result of a conviction under this Section of any employee or agent of such corporation if the employee so convicted is no longer employed by the corporation and: (1) it has been finally adjudicated not guilty or (2) if it demonstrates to the governmental entity with which it seeks to contract and that entity finds that the commission of the offense was neither authorized, requested, commanded, nor performed by a director, officer or a high managerial agent in behalf of the corporation.

2. The bidder certifies that it is not barred from contracting with the Department by reason of a violation of either Section 33E-3 or Section 33E-4.

E. International Anti-Boycott

1. Section 5 of the International Anti-Boycott Certification Act provides:

§ 5. State contracts. Every contract entered into by the State of Illinois for the manufacture, furnishing, or purchasing of supplies, material, or equipment or for the furnishing of work, labor, or services, in an amount exceeding the threshold for small purchases according to the purchasing laws of this State or \$10,000.00, whichever is less, shall contain certification, as a material condition of the contract, by which the contractor agrees that neither the contractor nor any substantially-owned affiliated company is participating or shall participate in an international boycott in violation of the provisions of the U.S. Export Administration Act of 1979 or the regulations of the U.S. Department of Commerce promulgated under that Act.

2. The bidder makes the certification set forth in Section 5 of the Act.

F. Drug Free Workplace

1. The Illinois "Drug Free Workplace Act" applies to this contract and it is necessary to comply with the provisions of the "Act" if the contractor is a corporation, partnership, or other entity (including a sole proprietorship) which has 25 or more employees.

2. The bidder certifies that if awarded a contract in excess of \$5,000 it will provide a drug free workplace by:

(a) Publishing a statement notifying employees that the unlawful manufacture, distribution, dispensation, possession or use of a controlled substance, including cannabis, is prohibited in the contractor's workplace; specifying the actions that will be taken against employees for violations of such prohibition; and notifying the employee that, as a condition of employment on such contract, the employee shall abide by the terms of the statement, and notify the employer of any criminal drug statute conviction for a violation occurring in the workplace no later than five (5) days after such conviction.

(b) Establishing a drug free awareness program to inform employees about the dangers of drug abuse in the workplace; the contractor's policy of maintaining a drug free workplace; any available drug counseling, rehabilitation, and employee assistance programs; and the penalties that may be imposed upon employees for drug violations.

(c) Providing a copy of the statement required by subparagraph (1) to each employee engaged in the performance of the contract and to post the statement in a prominent place in the workplace.

(d) Notifying the Department within ten (10) days after receiving notice from an employee or otherwise receiving actual notice of the conviction of an employee for a violation of any criminal drug statute occurring in the workplace.

(e) Imposing or requiring, within 30 days after receiving notice from an employee of a conviction or actual notice of such a conviction, an appropriate personnel action, up to and including termination, or the satisfactory participation in a drug abuse assistance or rehabilitation program approved by a federal, state or local health, law enforcement or other appropriate agency.

(f) Assisting employees in selecting a course of action in the event drug counseling, treatment, and rehabilitation is required and indicating that a trained referral team is in place.

(g) Making a good faith effort to continue to maintain a drug free workplace through implementation of the actions and efforts stated in this certification.

G. Debt Delinquency

1. The Illinois Procurement Code provides:

Section 50-11 and 50-12. Debt Delinquency.

The contractor or bidder certifies that it, or any affiliate, is not barred from being awarded a contract under 30 ILCS 500. Section 50-11 prohibits a person from entering into a contract with a State agency if it knows or should know that it, or any affiliate, is delinquent in the payment of any debt to the State as defined by the Debt Collection Board. Section 50-12 prohibits a person from entering into a contract with a State agency if it, or any affiliate, has failed to collect and remit Illinois Use Tax on all sales of tangible personal property into the State of Illinois in accordance with the provisions of the Illinois Use Tax Act. The contractor further acknowledges that the contracting State agency may declare the contract void if this certification is false or if the contractor, or any affiliate, is determined to be delinquent in the payment of any debt to the State during the term of the contract.

H. Sarbanes-Oxley Act of 2002

1. The Illinois Procurement Code provides:

Section 50-60(c).

The contractor certifies in accordance with 30 ILCS 500/50-10.5 that no officer, director, partner or other managerial agent of the contracting business has been convicted of a felony under the Sarbanes-Oxley Act of 2002 or a Class 3 or Class 2 felony under the Illinois Securities Law of 1953 for a period of five years prior to the date of the bid or contract. The contractor acknowledges that the contracting agency shall declare the contract void if this certification is false.

I. Addenda

The contractor or bidder certifies that all relevant addenda have been incorporated in to this contract. Failure to do so may cause the bid to be declared unacceptable.

J. Section 42 of the Environmental Protection Act

The contractor certifies in accordance with 30 ILCS 500/50-12 that the bidder or contractor is not barred from being awarded a contract under this Section which prohibits the bidding on or entering into contracts with the State of Illinois or a State agency by a person or business found by a court or the Pollution Control Board to have committed a willful or knowing violation of Section 42 of the Environmental Protection Act for a period of five years from the date of the order. The contractor acknowledges that the contracting agency may declare the contract void if this certification is false.

K. Apprenticeship and Training Certification (Does not apply to federal aid projects)

In accordance with the provisions of Section 30-22 (6) of the Illinois Procurement Code, the bidder certifies that it is a participant, either as an individual or as part of a group program, in the approved apprenticeship and training programs applicable to each type of work or craft that the bidder will perform with its own forces. The bidder further certifies for work that will be performed by subcontract that each of its subcontractors submitted for approval either (a) is, at the time of such bid, participating in an approved, applicable apprenticeship and training program; or (b) will, prior to commencement of performance of work pursuant to this contract, begin participation in an approved apprenticeship and training program applicable to the work of the subcontract. The Department, at any time before or after award, may require the production of a copy of each applicable Certificate of Registration issued by the United States Department of Labor evidencing such participation by the contractor and any or all of its subcontractors. Applicable apprenticeship and training programs are those that have been approved and registered with the United States Department of Labor. The bidder shall list in the space below, the official name of the program sponsor holding the Certificate of Registration for all of the types of work or crafts in which the bidder is a participant and that will be performed with the bidder's forces. Types of work or craft work that will be subcontracted shall be included and listed as subcontract work. The list shall also indicate any type of work or craft job category that does not have an applicable apprenticeship or training program. **The bidder is responsible for making a complete report and shall make certain that each type of work or craft job category that will be utilized on the project as reported on the Construction Employee Workforce Projection (Form BC-1256) and returned with the bid is accounted for and listed.**

The requirements of this certification and disclosure are a material part of the contract, and the contractor shall require this certification provision to be included in all approved subcontracts. In order to fulfill this requirement, it shall not be necessary that an applicable program sponsor be currently taking or that it will take applications for apprenticeship, training or employment during the performance of the work of this contract.

L. Executive Order Number 1 (2007) Regarding Lobbying on Government Procurements

The bidder hereby warrants and certifies that they have complied and will comply with the requirements set forth in this Order. The requirements of this warrant and certification are a material part of the contract, and the contractor shall require this warrant and certification provision to be included in all approved subcontracts.

M. Disclosure of Business Operations in Iran

Public Act 95-0616 provides that each bid, offer, or proposal submitted for a State contract shall include a disclosure of whether or not the Company acting as the bidder, offeror, or proposing entity, or any of its corporate parents or subsidiaries, within the 24 months before submission of the bid, offer, or proposal had business operations that involved contracts with or provision of supplies or services to the Government of Iran, companies in which the Government of Iran has any direct or indirect equity share, consortiums or projects commissioned by the Government of Iran, or companies involved in consortiums or projects commissioned by the Government of Iran and either of the following conditions apply:

- (1) More than 10% of the Company's revenues produced in or assets located in Iran involve oil-related activities or mineral-extraction activities; less than 75% of the Company's revenues produced in or assets located in Iran involve contracts with or provision of oil-related or mineral-extraction products or services to the Government of Iran or a project or consortium created exclusively by that government; and the Company has failed to take substantial action.
- (2) The Company has, on or after August 5, 1996, made an investment of \$20 million or more, or any combination of investments of at least \$10 million each that in the aggregate equals or exceeds \$20 million in any 12-month period, which directly or significantly contributes to the enhancement of Iran's ability to develop petroleum resources of Iran.

The terms "Business operations", "Company", "Mineral-extraction activities", "Oil-related activities", "Petroleum resources", and "Substantial action" are all defined in the Act.

Failure to make the disclosure required by the Act shall cause the bid, offer or proposal to be considered not responsive. The disclosure will be considered when evaluating the bid, offer, or proposal or awarding the contract. The name of each Company disclosed as doing business or having done business in Iran will be provided to the State Comptroller.

Check the appropriate statement:

Company has no business operations in Iran to disclose.

Company has business operations in Iran as disclosed the attached document.

NOTICE

**PA 95-0635 SUBSTANCE ABUSE PREVENTION PROGRAM (SAPP)
Effective January 1, 2008**

This Public Act requires that all contractors and subcontractors have a SAPP, meeting certain requirements, in place before starting work.

The as read low bidder is required to submit a correctly completed SAPP Certification Form BC 261 within seven (7) working days after the Letting. The Department will not accept a SAPP that does not meet the seven day submittal requirement and the bid will be declared not responsive. In the event the bid is declared not responsive due to failure to comply the Department may elect to cause the forfeiture of the penal sum of the bidder's proposal guaranty, may deny authorization to bid the project if re-advertised for bids and may not allow the bidder to participate on subsequent Lettings.

Submittal and approval of the bidder's SAPP is a condition of award.

The SAPP is to be submitted to the Bureau of Design & Environment, Contracts Office, Room 326, 2300 South Dirksen Parkway, Springfield, IL 62764. Voice 217-782-7806. Fax 217-785-1141. It is the bidder's responsibility to obtain confirmation of delivery.

The requirements of this Public Act are a material part of the contract, and the contractor shall require this provision to be included in all approved subcontracts. The contractor shall submit the correctly completed SAPP Certification Form BC 261 for each subcontractor with the Request for Approval of Subcontractor Form BC 260A.

TO BE RETURNED WITH BID

IV. DISCLOSURES

A. The disclosures hereinafter made by the bidder are each a material representation of fact upon which reliance is placed should the Department enter into the contract with the bidder. The Department may terminate the contract if it is later determined that the bidder rendered a false or erroneous disclosure, and the surety providing the performance bond shall be responsible for completion of the contract.

B. Financial Interests and Conflicts of Interest

1. Section 50-35 of the Illinois Procurement Code provides that all bids of more than \$10,000 shall be accompanied by disclosure of the financial interests of the bidder. This disclosed information for the successful bidder, will be maintained as public information subject to release by request pursuant to the Freedom of Information Act.

The financial interests to be disclosed shall include ownership or distributive income share that is in excess of 5%, or an amount greater than 60% of the annual salary of the Governor, of the bidding entity or its parent entity, whichever is less, unless the contractor or bidder is a publicly traded entity subject to Federal 10K reporting, in which case it may submit its 10K disclosure in place of the prescribed disclosure. If a bidder is a privately held entity that is exempt from Federal 10K reporting, but has more than 400 shareholders, it may submit the information that Federal 10K companies are required to report, and list the names of any person or entity holding any ownership share that is in excess of 5%. The disclosure shall include the names, addresses, and dollar or proportionate share of ownership of each person making the disclosure, their instrument of ownership or beneficial relationship, and notice of any potential conflict of interest resulting from the current ownership or beneficial interest of each person making the disclosure having any of the relationships identified in Section 50-35 and on the disclosure form.

In addition, all disclosures shall indicate any other current or pending contracts, proposals, leases, or other ongoing procurement relationships the bidding entity has with any other unit of state government and shall clearly identify the unit and the contract, proposal, lease, or other relationship.

2. Disclosure Forms. Disclosure Form A is attached for use concerning the individuals meeting the above ownership or distributive share requirements. Subject individuals should be covered each by one form. In addition, a second form (Disclosure Form B) provides for the disclosure of current or pending procurement relationships with other (non-IDOT) state agencies. **The forms must be included with each bid or incorporated by reference.**

C. Disclosure Form Instructions

Form A: For bidders that have previously submitted the information requested in Form A

The Department has retained the Form A disclosures submitted by all bidders responding to these requirements for the April 24, 1998 or any subsequent letting conducted by the Department. The bidder has the option of submitting the information again or the bidder may check the following certification statement indicating that the information previously submitted by the bidder is, as of the date of submission, current and accurate. Before checking this certification, the bidder should carefully review its prior submissions to ensure the Certification is correct. If the Bidder checks the Certification, the Bidder should proceed to Form B instructions.

CERTIFICATION STATEMENT

I have determined that the Form A disclosure information previously submitted is current and accurate, and all forms are hereby incorporated by reference in this bid. Any necessary additional forms or amendments to previously submitted forms are attached to this bid.

(Bidding Company)



Signature of Authorized Representative

Date

Form A: For bidders who have NOT previously submitted the information requested in Form A

If the bidder is a publicly traded entity subject to Federal 10K reporting, the 10K Report may be submitted to meet the requirements of Form A. If a bidder is a privately held entity that is exempt from Federal 10K reporting, but has more than 400 shareholders, it may submit the information that Federal 10K companies are required to report, and list the names of any person or entity holding any ownership share that is in excess of 5%. If a bidder is not subject to Federal 10K reporting, the bidder must determine if any individuals are required by law to complete a financial disclosure form. To do this, the bidder should answer each of the following questions. A "YES" answer indicates Form A must be completed. If the answer to each of the following questions is "NO", then the NOT APPLICABLE STATEMENT on the second page of Form A must be signed and dated by a person that is authorized to execute contracts for the bidding company. Note: These questions are for assistance only and are not required to be completed.

1. Does anyone in your organization have a direct or beneficial ownership share of greater than 5% of the bidding entity or parent entity? YES ___ NO ___
2. Does anyone in your organization have a direct or beneficial ownership share of less than 5%, but which has a value greater than \$102,600.00? YES ___ NO ___
3. Does anyone in your organization receive more than \$102,600.00 of the bidding entity's or parent entity's distributive income? (Note: Distributive income is, for these purposes, any type of distribution of profits. An annual salary is not distributive income.) YES ___ NO ___
4. Does anyone in your organization receive greater than 5% of the bidding entity's or parent entity's total distributive income, but which is less than \$102,600.00? YES ___ NO ___

(Note: Only one set of forms needs to be completed per person per bid even if a specific individual would require a yes answer to more than one question.)

A "YES" answer to any of these questions requires the completion of Form A. The bidder must determine each individual in the bidding entity or the bidding entity's parent company that would cause the questions to be answered "Yes". Each form must be signed and dated by a person that is authorized to execute contracts for your organization. **Photocopied or stamped signatures are not acceptable.** The person signing can be, but does not have to be, the person for which the form is being completed. The bidder is responsible for the accuracy of any information provided.

If the answer to each of the above questions is "NO", then the NOT APPLICABLE STATEMENT on page 2 of Form A must be signed and dated by a person that is authorized to execute contracts for your company.

Form B: Identifying Other Contracts & Procurement Related Information Disclosure Form B must be completed for each bid submitted by the bidding entity. Note: *Checking the NOT APPLICABLE STATEMENT on Form A does not allow the bidder to ignore Form B. Form B must be completed, checked, and dated or the bidder may be considered nonresponsive and the bid will not be accepted.*

The Bidder shall identify, by checking Yes or No on Form B, whether it has any pending contracts (including leases), bids, proposals, or other ongoing procurement relationship with any other (non-IDOT) State of Illinois agency. If "No" is checked, the bidder only needs to complete the check box on the bottom of Form B. If "Yes" is checked, the bidder must do one of the following:

Option I: If the bidder did not submit an Affidavit of Availability to obtain authorization to bid, the bidder must list all non-IDOT State of Illinois agency pending contracts, leases, bids, proposals, and other ongoing procurement relationships. These items may be listed on Form B or on an attached sheet(s). Do not include IDOT contracts. Contracts with cities, counties, villages, etc. are not considered State of Illinois agency contracts and are not to be included. Contracts with other State of Illinois agencies such as the Department of Natural Resources or the Capital Development Board must be included. Bidders who submit Affidavits of Availability are suggested to use Option II.

Option II: If the bidder is required and has submitted an Affidavit of Availability in order to obtain authorization to bid, the bidder may write or type "See Affidavit of Availability" which indicates that the Affidavit of Availability is incorporated by reference and includes all non-IDOT State of Illinois agency pending contracts, leases, bids, proposals, and other ongoing procurement relationships. For any contracts that are not covered by the Affidavit of Availability, the bidder must identify them on Form B or on an attached sheet(s). These might be such things as leases.

D. Bidders Submitting More Than One Bid

Bidders submitting multiple bids may submit one set of forms consisting of all required Form A disclosures and one Form B for use with all bids. Please indicate in the space provided below the bid item that contains the original disclosure forms and the bid items which incorporate the forms by reference.

- The bid submitted for letting item _____ contains the Form A disclosures or Certification Statement and the Form B disclosures. The following letting items incorporate the said forms by reference:

**ILLINOIS DEPARTMENT
OF TRANSPORTATION**

**Form A
Financial Information &
Potential Conflicts of Interest
Disclosure**

Contractor Name		
Legal Address		
City, State, Zip		
Telephone Number	Email Address	Fax Number (if available)

Disclosure of the information contained in this Form is required by the Section 50-35 of the Illinois Procurement Code (30 ILCS 500). Vendors desiring to enter into a contract with the State of Illinois must disclose the financial information and potential conflict of interest information as specified in this Disclosure Form. This information shall become part of the publicly available contract file. This Form A must be completed for bids in excess of \$10,000, and for all open-ended contracts. **A publicly traded company may submit a 10K disclosure (or equivalent if applicable) in satisfaction of the requirements set forth in Form A. See Disclosure Form Instructions.**

DISCLOSURE OF FINANCIAL INFORMATION

1. Disclosure of Financial Information. The individual named below has an interest in the BIDDER (or its parent) in terms of ownership or distributive income share in excess of 5%, or an interest which has a value of more than \$102,600.00 (60% of the Governor's salary as of 7/1/07). **(Make copies of this form as necessary and attach a separate Disclosure Form A for each individual meeting these requirements)**

FOR INDIVIDUAL (type or print information)

NAME: _____

ADDRESS _____

Type of ownership/distributable income share:

stock _____ sole proprietorship _____ Partnership _____ other: (explain on separate sheet):
% or \$ value of ownership/distributable income share: _____

2. Disclosure of Potential Conflicts of Interest. Check "Yes" or "No" to indicate which, if any, of the following potential conflict of interest relationships apply. If the answer to any question is "Yes", please attach additional pages and describe.

(a) State employment, currently or in the previous 3 years, including contractual employment of services. Yes ___ No ___

If your answer is yes, please answer each of the following questions.

1. Are you currently an officer or employee of either the Capitol Development Board or the Illinois Toll Highway Authority? Yes ___ No ___
2. Are you currently appointed to or employed by any agency of the State of Illinois? If you are currently appointed to or employed by any agency of the State of Illinois, and your annual salary exceeds \$102,600.00, (60% of the Governor's salary as of 7/1/07) provide the name the State agency for which you are employed and your annual salary. _____

RETURN WITH BID/OFFER

3. If you are currently appointed to or employed by any agency of the State of Illinois, and your annual salary exceeds \$102,600.00, (60% of the Governor's salary as of 7/1/07) are you entitled to receive (i) more than 7 1/2% of the total distributable income of your firm, partnership, association or corporation, or (ii) an amount in excess of the salary of the Governor? Yes ___ No ___
4. If you are currently appointed to or employed by any agency of the State of Illinois, and your annual salary exceeds \$102,600.00, (60% of the Governor's salary as of 7/1/07) are you and your spouse or minor children entitled to receive (i) more than 15 % in the aggregate of the total distributable income of your firm, partnership, association or corporation, or (ii) an amount in excess of 2 times the salary of the Governor? Yes ___ No ___

(b) State employment of spouse, father, mother, son, or daughter, including contractual employment services in the previous 2 years.

Yes ___ No ___

If your answer is yes, please answer each of the following questions.

1. Is your spouse or any minor children currently an officer or employee of the Capitol Development Board or the Illinois Toll Highway Authority? Yes ___ No ___
2. Is your spouse or any minor children currently appointed to or employed by any agency of the State of Illinois? If your spouse or minor children is/are currently appointed to or employed by any agency of the State of Illinois, and his/her annual salary exceeds \$102,600.00, (60 % of the Governor's salary as of 7/1/07) provide the name of your spouse and/or minor children, the name of the State agency for which he/she is employed and his/her annual salary. _____
-
3. If your spouse or any minor children is/are currently appointed to or employed by any agency of the State of Illinois, and his/her annual salary exceeds \$102,600.00, (60% of the salary of the Governor as of 7/1/07) are you entitled to receive (i) more then 71/2% of the total distributable income of your firm, partnership, association or corporation, or (ii) an amount in excess of the salary of the Governor? Yes ___ No ___
4. If your spouse or any minor children are currently appointed to or employed by any agency of the State of Illinois, and his/her annual salary exceeds \$102,600.00, (60% of the Governor's salary as of 7/1/07) are you and your spouse or minor children entitled to receive (i) more than 15 % in the aggregate of the total distributable income of your firm, partnership, association or corporation, or (ii) an amount in excess of 2 times the salary of the Governor? Yes ___ No ___

(c) Elective status; the holding of elective office of the State of Illinois, the government of the United States, any unit of local government authorized by the Constitution of the State of Illinois or the statutes of the State of Illinois currently or in the previous 3 years. Yes ___ No ___

(d) Relationship to anyone holding elective office currently or in the previous 2 years; spouse, father, mother, son, or daughter. Yes ___ No ___

(e) Appointive office; the holding of any appointive government office of the State of Illinois, the United States of America, or any unit of local government authorized by the Constitution of the State of Illinois or the statutes of the State of Illinois, which office entitles the holder to compensation in excess of the expenses incurred in the discharge of that office currently or in the previous 3 years. Yes ___ No ___

(f) Relationship to anyone holding appointive office currently or in the previous 2 years; spouse, father, mother, son, or daughter. Yes ___ No ___

(g) Employment, currently or in the previous 3 years, as or by any registered lobbyist of the State government. Yes ___ No ___

RETURN WITH BID/OFFER

(h) Relationship to anyone who is or was a registered lobbyist in the previous 2 years; spouse, father, mother, son, or daughter. Yes ___ No ___

(i) Compensated employment, currently or in the previous 3 years, by any registered election or reelection committee registered with the Secretary of State or any county clerk of the State of Illinois, or any political action committee registered with either the Secretary of State or the Federal Board of Elections. Yes ___ No ___

(j) Relationship to anyone; spouse, father, mother, son, or daughter; who was a compensated employee in the last 2 years by any registered election or re-election committee registered with the Secretary of State or any county clerk of the State of Illinois, or any political action committee registered with either the Secretary of State or the Federal Board of Elections. Yes ___ No ___

APPLICABLE STATEMENT

This Disclosure Form A is submitted on behalf of the INDIVIDUAL named on previous page.

Completed by: _____ Date _____
Signature of Individual or Authorized Representative

NOT APPLICABLE STATEMENT

I have determined that no individuals associated with this organization meet the criteria that would require the completion of this Form A.

This Disclosure Form A is submitted on behalf of the CONTRACTOR listed on the previous page.

_____ Date _____
Signature of Authorized Representative

RETURN WITH BID/OFFER

ILLINOIS DEPARTMENT
OF TRANSPORTATION

Form B
Other Contracts &
Procurement Related Information
Disclosure

Contractor Name		
Legal Address		
City, State, Zip		
Telephone Number	Email Address	Fax Number (if available)

Disclosure of the information contained in this Form is required by the Section 50-35 of the Illinois Procurement Act (30 ILCS 500). This information shall become part of the publicly available contract file. This Form B must be completed for bids in excess of \$10,000, and for all open-ended contracts.

DISCLOSURE OF OTHER CONTRACTS AND PROCUREMENT RELATED INFORMATION

1. Identifying Other Contracts & Procurement Related Information. The BIDDER shall identify whether it has any pending contracts (including leases), bids, proposals, or other ongoing procurement relationship with any other State of Illinois agency: Yes ___ No ___

If "No" is checked, the bidder only needs to complete the signature box on the bottom of this page.

2. If "Yes" is checked. Identify each such relationship by showing State of Illinois agency name and other descriptive information such as bid or project number (attach additional pages as necessary). SEE DISCLOSURE FORM INSTRUCTIONS:

THE FOLLOWING STATEMENT MUST BE CHECKED

<input type="checkbox"/>	_____	_____
	Signature of Authorized Representative	Date

RETURN WITH BID

SPECIAL NOTICE TO CONTRACTORS

The following requirements of the Illinois Department of Human Rights' Rules and Regulations are applicable to bidders on all construction contracts advertised by the Illinois Department of Transportation:

CONSTRUCTION EMPLOYEE UTILIZATION PROJECTION

- (a) All bidders on construction contracts shall complete and submit, along with and as part of their bids, a Bidder's Employee Utilization Form (Form BC-1256) setting forth a projection and breakdown of the total workforce intended to be hired and/or allocated to such contract work by the bidder including a projection of minority and female employee utilization in all job classifications on the contract project.
- (b) The Department of Transportation shall review the Employee Utilization Form, and workforce projections contained therein, of the contract awardee to determine if such projections reflect an underutilization of minority persons and/or women in any job classification in accordance with the Equal Employment Opportunity Clause and Section 7.2 of the Illinois Department of Human Rights' Rules and Regulations for Public Contracts adopted as amended on September 17, 1980. If it is determined that the contract awardee's projections reflect an underutilization of minority persons and/or women in any job classification, it shall be advised in writing of the manner in which it is underutilizing and such awardee shall be considered to be in breach of the contract unless, prior to commencement of work on the contract project, it submits revised satisfactory projections or an acceptable written affirmative action plan to correct such underutilization including a specific timetable geared to the completion stages of the contract.
- (c) The Department of Transportation shall provide to the Department of Human Rights a copy of the contract awardee's Employee Utilization Form, a copy of any required written affirmative action plan, and any written correspondence related thereto. The Department of Human Rights may review and revise any action taken by the Department of Transportation with respect to these requirements.

RETURN WITH BID

**Contract No. 68822
PEORIA-TAZEWELL Counties
Section D4 HIGHWAY LIGHTING 2008-1
Route FAP 318/399
District 4 Construction Funds**

PART II. WORKFORCE PROJECTION - continued

- B. Included in "Total Employees" under Table A is the total number of **new hires** that would be employed in the event the undersigned bidder is awarded this contract.

The undersigned bidder projects that: (number) _____ new hires would be recruited from the area in which the contract project is located; and/or (number) _____ new hires would be recruited from the area in which the bidder's principal office or base of operation is located.

- C. Included in "Total Employees" under Table A is a projection of numbers of persons to be employed directly by the undersigned bidder as well as a projection of numbers of persons to be employed by subcontractors.

The undersigned bidder estimates that (number) _____ persons will be directly employed by the prime contractor and that (number) _____ persons will be employed by subcontractors.

PART III. AFFIRMATIVE ACTION PLAN

- A. The undersigned bidder understands and agrees that in the event the foregoing minority and female employee utilization projection included under **PART II** is determined to be an underutilization of minority persons or women in any job category, and in the event that the undersigned bidder is awarded this contract, he/she will, prior to commencement of work, develop and submit a written Affirmative Action Plan including a specific timetable (geared to the completion stages of the contract) whereby deficiencies in minority and/or female employee utilization are corrected. Such Affirmative Action Plan will be subject to approval by the contracting agency and the **Department of Human Rights**.
- B. The undersigned bidder understands and agrees that the minority and female employee utilization projection submitted herein, and the goals and timetable included under an Affirmative Action Plan if required, are deemed to be part of the contract specifications.

Company _____ Telephone Number _____

Address _____

NOTICE REGARDING SIGNATURE

The Bidder's signature on the Proposal Signature Sheet will constitute the signing of this form. The following signature block needs to be completed if revisions are required.

Signature: _____ Title: _____ Date: _____

- Instructions: All tables must include subcontractor personnel in addition to prime contractor personnel.
- Table A - Include both the number of employees that would be hired to perform the contract work and the total number currently employed (Table B) that will be allocated to contract work, and include all apprentices and on-the-job trainees. The "Total Employees" column should include all employees including all minorities, apprentices and on-the-job trainees to be employed on the contract work.
 - Table B - Include all employees currently employed that will be allocated to the contract work including any apprentices and on-the-job trainees currently employed.
 - Table C - Indicate the racial breakdown of the total apprentices and on-the-job trainees shown in Table A.

RETURN WITH BID

**Contract No. 68822
PEORIA-TAZEWELL Counties
Section D4 HIGHWAY LIGHTING 2008-1
Route FAP 318/399
District 4 Construction Funds**

PROPOSAL SIGNATURE SHEET

The undersigned bidder hereby makes and submits this bid on the subject Proposal, thereby assuring the Department that all requirements of the Invitation for Bids and rules of the Department have been met, that there is no misunderstanding of the requirements of paragraph 3 of this Proposal, and that the contract will be executed in accordance with the rules of the Department if an award is made on this bid.

(IF AN INDIVIDUAL) Firm Name _____
Signature of Owner _____
Business Address _____

(IF A CO-PARTNERSHIP) Firm Name _____
By _____
Business Address _____
Name and Address of All Members of the Firm:

(IF A CORPORATION)
(IF A JOINT VENTURE, USE THIS SECTION FOR THE MANAGING PARTY AND THE SECOND PARTY SHOULD SIGN BELOW)

Corporate Name _____
By _____
Signature of Authorized Representative _____
Typed or printed name and title of Authorized Representative _____
Attest _____
Signature _____
Business Address _____

(IF A JOINT VENTURE)

Corporate Name _____
By _____
Signature of Authorized Representative _____
Typed or printed name and title of Authorized Representative _____
Attest _____
Signature _____
Business Address _____

If more than two parties are in the joint venture, please attach an additional signature sheet.



Return with Bid

Division of Highways
Proposal Bid Bond
(Effective November 1, 1992)

Item No. _____

Letting Date _____

KNOW ALL MEN BY THESE PRESENTS, That We _____

as PRINCIPAL, and _____

_____ as SURETY, are held jointly, severally and firmly bound unto the STATE OF ILLINOIS in the penal sum of 5 percent of the total bid price, or for the amount specified in Article 102.09 of the "Standard Specifications for Road and Bridge Construction" in effect on the date of invitation for bids, whichever is the lesser sum, well and truly to be paid unto said STATE OF ILLINOIS, for the payment of which we bind ourselves, our heirs, executors, administrators, successors and assigns.

THE CONDITION OF THE FOREGOING OBLIGATION IS SUCH, that whereas, the PRINCIPAL has submitted a bid proposal to the STATE OF ILLINOIS, acting through the Department of Transportation, for the improvement designated by the Transportation Bulletin Item Number and Letting Date indicated above.

NOW, THEREFORE, if the Department shall accept the bid proposal of the PRINCIPAL; and if the PRINCIPAL shall, within the time and as specified in the bidding and contract documents, submit a DBE Utilization Plan that is accepted and approved by the Department; and if, after award by the Department, the PRINCIPAL shall enter into a contract in accordance with the terms of the bidding and contract documents including evidence of the required insurance coverages and providing such bond as specified with good and sufficient surety for the faithful performance of such contract and for the prompt payment of labor and material furnished in the prosecution thereof; or if, in the event of the failure of the PRINCIPAL to make the required DBE submission or to enter into such contract and to give the specified bond, the PRINCIPAL pays to the Department the difference not to exceed the penalty hereof between the amount specified in the bid proposal and such larger amount for which the Department may contract with another party to perform the work covered by said bid proposal, then this obligation shall be null and void, otherwise, it shall remain in full force and effect.

IN THE EVENT the Department determines the PRINCIPAL has failed to comply with any requirement as set forth in the preceding paragraph, then Surety shall pay the penal sum to the Department within fifteen (15) days of written demand therefor. If Surety does not make full payment within such period of time, the Department may bring an action to collect the amount owed. Surety is liable to the Department for all its expenses, including attorney's fees, incurred in any litigation in which it prevails either in whole or in part.

In TESTIMONY WHEREOF, the said PRINCIPAL and the said SURETY have caused this instrument to be signed by their respective officers this _____ day of _____ A.D., _____.

PRINCIPAL

(Company Name)

(Company Name)

By: _____
(Signature & Title)

By: _____
(Signature of Attorney-in-Fact)

Notary Certification for Principal and Surety

STATE OF ILLINOIS,

County of _____

I, _____, a Notary Public in and for said County, do hereby certify that

_____ and _____
(Insert names of individuals signing on behalf of PRINCIPAL & SURETY)

who are each personally known to me to be the same persons whose names are subscribed to the foregoing instrument on behalf of PRINCIPAL and SURETY, appeared before me this day in person and acknowledged respectively, that they signed and delivered said instrument as their free and voluntary act for the uses and purposes therein set forth.

Given under my hand and notarial seal this _____ day of _____ A.D. _____

My commission expires _____

Notary Public

In lieu of completing the above section of the Proposal Bid Form, the Principal may file an Electronic Bid Bond. By signing the proposal and marking the check box next to the Signature and Title line below, the Principal is ensuring the identified electronic bid bond has been executed and the Principal and Surety are firmly bound unto the State of Illinois under the conditions of the bid bond as shown above.

Electronic Bid Bond ID# _____

Company / Bidder Name _____



Signature and Title _____

PROPOSAL ENVELOPE



PROPOSALS

for construction work advertised for bids by the
Illinois Department of Transportation

Item No.	Item No.	Item No.

Submitted By:

Name:
Address:
Phone No.

Bidders should use an IDOT proposal envelope or affix this form to the front of a 10" x 13" envelope for the submittal of bids. If proposals are mailed, they should be enclosed in a second or outer envelope addressed to:

Engineer of Design and Environment - Room 326
Illinois Department of Transportation
2300 South Dirksen Parkway
Springfield, Illinois 62764

NOTICE

Individual bids, including Bid Bond and/or supplemental information if required, should be securely stapled.

CONTRACTOR OFFICE COPY OF CONTRACT SPECIFICATIONS

NOTICE

None of the following material needs to be returned with the bid package unless the special provisions require documentation and/or other information to be submitted.

**Contract No. 68822
PEORIA-TAZEWELL Counties
Section D4 HIGHWAY LIGHTING 2008-1
Route FAP 318/399
District 4 Construction Funds**



Illinois Department of Transportation



NOTICE TO BIDDERS

- 1. TIME AND PLACE OF OPENING BIDS.** Sealed proposals for the improvement described herein will be received by the Department of Transportation at the Harry R. Hanley Building, 2300 South Dirksen Parkway, in Springfield, Illinois until 10:00 o'clock a.m., June 13, 2008. All bids will be gathered, sorted, publicly opened and read in the auditorium at the Department of Transportation's Harry R. Hanley Building shortly after the 10:00 a.m. cut off time.
- 2. DESCRIPTION OF WORK.** The proposed improvement is identified and advertised for bids in the Invitation for Bids as:

**Contract No. 68822
PEORIA-TAZEWELL Counties
Section D4 HIGHWAY LIGHTING 2008-1
Route FAP 318/399
District 4 Construction Funds**

This project consists of replacing existing luminaires at various interchanges along IL Route 6 in Peoria County and at the IL Route 8 and Interstate 74 interchange in Tazewell County.

- 3. INSTRUCTIONS TO BIDDERS.** (a) This Notice, the invitation for bids, proposal and letter of award shall, together with all other documents in accordance with Article 101.09 of the Standard Specifications for Road and Bridge Construction, become part of the contract. Bidders are cautioned to read and examine carefully all documents, to make all required inspections, and to inquire or seek explanation of the same prior to submission of a bid.

(b) State law, and, if the work is to be paid wholly or in part with Federal-aid funds, Federal law requires the bidder to make various certifications as a part of the proposal and contract. By execution and submission of the proposal, the bidder makes the certification contained therein. A false or fraudulent certification shall, in addition to all other remedies provided by law, be a breach of contract and may result in termination of the contract.
- 4. AWARD CRITERIA AND REJECTION OF BIDS.** This contract will be awarded to the lowest responsive and responsible bidder considering conformity with the terms and conditions established by the Department in the rules, Invitation for Bids and contract documents. The issuance of plans and proposal forms for bidding based upon a prequalification rating shall not be the sole determinant of responsibility. The Department reserves the right to determine responsibility at the time of award, to reject any or all proposals, to readvertise the proposed improvement, and to waive technicalities.

By Order of the
Illinois Department of Transportation

Milton R. Sees, Secretary

BD 351 (Rev. 01/2003)

INDEX
FOR
SUPPLEMENTAL SPECIFICATIONS
AND RECURRING SPECIAL PROVISIONS

Adopted January 1, 2008

This index contains a listing of SUPPLEMENTAL SPECIFICATIONS and frequently used RECURRING SPECIAL PROVISIONS.

ERRATA Standard Specifications for Road and Bridge Construction (Adopted 1-1-07) (Revised 1-1-08)

SUPPLEMENTAL SPECIFICATIONS

<u>Std. Spec. Sec.</u>	<u>Page No.</u>
205 Embankment	1
251 Mulch	2
253 Planting Woody Plants	3
280 Temporary Erosion Control	5
443 Reflective Crack Control Treatment	6
502 Excavation for Structures	9
503 Concrete Structures	10
505 Steel Structures	11
540 Box Culverts	12
633 Removing and Reerecting Guardrail and Terminals	13
672 Sealing Abandoned Water Wells	14
701 Work Zone Traffic Control and Protection	15
838 Breakaway Devices	16
1004 Coarse Aggregates	17
1020 Portland Cement Concrete	18
1022 Concrete Curing Materials	20
1042 Precast Concrete Products	21
1062 Reflective Crack Control System	22
1069 Pole and Tower	24
1081 Materials for Planting	27
1083 Elastomeric Bearings	29
1102 Hot-Mix Asphalt Equipment	30

RECURRING SPECIAL PROVISIONS

The following RECURRING SPECIAL PROVISIONS indicated by an "X" are applicable to this contract and are included by reference:

<u>CHECK SHEET #</u>	<u>PAGE NO.</u>
1	31
2	33
3	34
4	44
5	49
6	54
7	55
8	56
9	57
10	60
11	63
12	65
13	69
14	71
15	72
16	74
17	75
18	77
19	78
20	79
21	83
22	85
23	87
24	89
25	90
26	91
27	92
28	93
29	94
30	100
31	108

TABLE OF CONTENTS

LOCATION OF PROJECT 1
DESCRIPTION OF PROJECT 1
TRAFFIC CONTROL PLAN 1
CONTRACT GUARANTEE 2
LOCATION OF UNDERGROUND STATE MAINTAINED FACILITIES 2
INSTALLATION OF BREAKAWAY COUPLINGS ON EXISTING SCREW-IN FOUNDATIONS 2
EXISTING LIGHT POLE FOUNDATION ADJUSTMENT 3
BREAKAWAY DEVICE, COUPLING, WITH STAINLESS STEEL SCREEN 3
LUMINAIRE, HIGH PRESSURE SODIUM, SPECIAL 4
DRILL EXISTING FOUNDATION 5
EQUIPMENT RENTAL RATES (BDE) 5
PAYMENTS TO SUBCONTRACTORS (BDE) 6
REFLECTIVE SHEETING ON CHANNELIZING DEVICES (BDE) 7
SUBCONTRACTOR MOBILIZATION PAYMENTS (BDE) 8
WORKING DAYS (BDE) 9

STATE OF ILLINOIS

SPECIAL PROVISIONS

The following Special Provisions supplement the "Standard Specifications for Road and Bridge Construction," adopted January 1, 2007, the latest edition of the "Manual on Uniform Traffic Control Devices for Streets and Highways," and the "Manual of Test Procedures for Materials" in effect on the date of invitation for bids, and the Supplemental Specifications and Recurring Special Provisions indicated on the Check Sheet included herein which apply to and govern the construction of FAP Route 399 / 318 (IL 8 / IL 6), Section D4 Highway Lighting 2008-1 in Peoria and Tazewell Counties and in case of conflict with any part or parts of said Specifications, the said Special Provisions shall take precedence and shall govern.

LOCATION OF PROJECT

This project is located at the following interchanges:

Peoria County: IL Route 6 and US Route 150 (War Memorial Drive), IL Route 6 and Allen Road, IL Route 6 and IL Route 40 (Knoxville Avenue), IL Route 6 and IL Route 29, and IL Route 29 and Old Galena Road.

Tazewell County: Interstate 74 and IL Route 8 (Camp Street) in East Peoria.

DESCRIPTION OF PROJECT

This project consists of removing the existing luminaires and installing Department furnished luminaires on existing light poles at the five Peoria County locations, removing the existing light poles and luminaires at the interchange of Interstate 74 and IL Route 8 (Camp Street), and installing new light poles, luminaires and break-away couplings, and performing all other collateral work required to complete the improvements.

TRAFFIC CONTROL PLAN

Effective April 4, 2008

Traffic control shall be in accordance with the applicable sections of the "Standard Specifications for Road and Bridge Construction", the applicable guidelines contained in the "Illinois Manual on Uniform Traffic Control Devices for Streets and Highways", these Special Provisions, and any special details and Highway Standards contained herein and in the plans.

Special attention is called to Section 701 and Articles 107.09 and 107.14 of the "Standard Specifications for Road and Bridge Construction" and the following Highway Standards relating to traffic control:

701001 701006 701011 701201 701301 701602 702001

CONTRACT GUARANTEE

The Contractor shall guarantee all electrical equipment, apparatus, materials, and workmanship provided under the contract for a period of six (6) months after the date of final inspection according to Article 801.07.

All instruction sheets required to be furnished by the manufacturer for materials and supplies and for operations shall be delivered to the Engineer prior to the acceptance of the project, with the following warranties and guarantees:

1. The manufacturer's standard written warranty for each piece of electrical equipment or apparatus furnished under the contract.
2. The Contractor's written guarantee that, for a period of six (6) months after the date of final inspection of the project, all necessary repairs to or replacement of said warranted equipment, or apparatus shall be made by the Contractor at no cost to the Department.
3. The Contractor's written guarantee for satisfactory operation of all electrical systems furnished and constructed under the contract for a period of 6 months after final inspection of the project.

LOCATION OF UNDERGROUND STATE MAINTAINED FACILITIES

The Contractor shall be responsible for locating all existing and proposed IDOT electrical facilities prior to performing any work at his/her own expense if required. The Contractor shall also be liable for any damage to facilities resulting from inaccurate locating. The Contractor may obtain, on request, plans of existing electrical facilities from the Department.

The Contractor shall also be responsible for locating and providing protection for facilities during all phases of construction. If at any time, the facilities are damaged, the Contractor shall immediately notify the Department and make all necessary arrangements for repair to the satisfaction of the Engineer. This work shall be included in the contract bid price and no additional compensation will be allowed.

INSTALLATION OF BREAKAWAY COUPLINGS ON EXISTING SCREW-IN FOUNDATIONS

The existing steel screw in foundations on this project may require modifications in order to provide the correct bolt projection for the breakaway couplings.

On foundations with tapped holes, the Contractor will be required to reduce thread projection to 1.5 inches or as required by the breakaway device manufacturer by threading the stud or bolt into the foundation as needed. The breakaway coupling shall then be installed according to manufacturer's instructions using the required washers and hardware. After coupling installation, the Contractor shall install a one-inch (1") galvanized lock washer and jam nut on the bottom side on the foundation base plate and tighten the jam nut adequately to prevent vibration from loosening the stud in the foundation or breakaway device.

On those foundations with drilled through holes, the Contractor shall remove the top jam nut and washer from the existing through bolt or stud. The breakaway device shall then be installed with the required washers on the top of the base plate and a one-inch (1") galvanized lock washer and jam nut on the bottom of the foundation base plate and tighten the jam nut in accordance with the manufacturer's specifications.

For all foundation types, the Contractor shall take necessary steps to assure that the correct amount of bolt is threaded into the breakaway device so the device will function according to design requirements.

The Contractor will be allowed to reuse any existing studs, bolts, nuts, washers and other hardware that the Engineer determines is in good condition. All additional hardware including, but not limited to, longer studs, nuts or washers needed to comply with the requirements above and assure that the breakaway devices are properly installed shall be provided by the Contractor.

This work will not be paid for separately, but shall be included in the bid price for the pay item BREAKAWAY DEVICE, COUPLING, WITH STAINLESS STEEL SCREEN. No additional compensation will be paid for this work.

EXISTING LIGHT POLE FOUNDATION ADJUSTMENT

This work shall be in accordance with Section 836 and 1070 of the Standard Specifications except as modified herein.

The existing screw-in metal foundations are installed approximately one foot above grade. The Contractor shall excavate to remove the existing unit duct from the foundation, install the foundation to match the existing grade, reinstall the unit duct, and restore the ground (including seeding).

The foundation shall be installed in accordance with AASHTO requirements.

Basis of Payment: This work shall be paid for at the contract unit price each for EXISTING LIGHT POLE FOUNDATION ADJUSTMENT which price shall be payment in full for all labor, equipment, and materials required to adjust the existing light pole foundation described above, complete.

BREAKAWAY DEVICE, COUPLING, WITH STAINLESS STEEL SCREEN

This work shall be in accordance with Sections 838 and 1070 of the Standard Specifications except as modified herein.

The breakaway couplings shall be one-inch (1") diameter galvanized steel couplings and be coordinated to match the light pole foundation. The use of aluminum breakaway couplings will not be allowed.

All breakaway couplings shall be installed level on the existing metal screw-in foundations. The breakaway couplings shall be installed according to the manufacturer's recommendations. The coupling installation shall not be used to level the pole base.

Breakaway couplings shall be manufactured from galvanized steel. Certification shall be submitted from the supplier that the device used under the conditions of the particular design meets the AASHTO breakaway specification. Certification shall include test results performed by the manufacturer, supplier or others. If test results have been previously approved by a letter from the FHWA, a copy of the approval letter from FHWA should accompany the certification. The coupling shall not alter the bolt circle of the pole. The breakaway device shall be vandal resistant and shall not adversely affect the light pole installation and maintenance or decrease the resistance of the light pole to non-collision type of design loading. The breakaway device shall be field attachable and detachable.

The Contractor will be allowed to substitute perforated aluminum sheeting in place of the stainless steel screen.

The Contractor shall fill any voids within the existing metal screw-in foundation with fine aggregate to prevent rodent entry and provide circuit extensions as needed to install the light pole and luminaires.

Basis of Payment: This work will be paid for at the contract unit price each for BREAKAWAY DEVICE, COUPLING, WITH STAINLESS STEEL SCREEN which shall be payment in full for all labor, equipment, and materials required to provide and install the breakaway device described above, complete.

LUMINAIRE, HIGH PRESSURE SODIUM, SPECIAL

This work shall consist of removing an existing luminaire and installing a Department supplied vertical mount luminaire on an existing light pole according to Sections 821, 1065, 1066, and 1067 of the Standard Specifications and as modified herein.

The Contractor shall perform the following:

Pick up the luminaire from the IDOT Warehouse located at 6500 W. US Rt. 150, Edwards, IL and deliver it to the job site.

Install a new mag-reg ballast kit (240V or 480V, 250 Watt or 400 Watt as required), and non-cycling lamp (250 Watt or 400 Watt as required) in the luminaire and dispose of all surplus parts.

Remove the existing luminaire from the light pole and dispose of it from the job site. The salvage value of the luminaire shall be reflected in the bid price for this pay item.

Install supplied luminaire on existing light pole utilizing the existing fuses, surge arrestors, and fuseholders. The Contractor shall furnish and install new wiring from the luminaire to

the fuse holder and butt splice it into the existing wiring. The Contractor shall also furnish and install any brackets, hardware, electrical cables, fuses, and other materials required to install the proposed luminaire and make it fully operational.

Aim the luminaire so the light pattern illuminates the center of the roadway in accordance with the manufacturer's recommendations and to the satisfaction of the Engineer.

Basis of Payment: This work will be paid for at the contract unit price each for LUMINAIRE, HIGH PRESSURE SODIUM, SPECIAL which shall be payment in full for all labor, equipment, and materials required to install the proposed luminaire as described above, complete.

DRILL EXISTING FOUNDATION

This work shall be in accordance with Section 879 of the Standard Specifications except as modified herein.

The existing light pole shown as number 4 on the plan sheet for I-74 & IL 8 (Camp St.) has the unit duct installed externally.

The Contractor shall perform the following:

- Excavate next to existing foundation and fill when done.
- Drill the existing concrete foundation. The hole shall be drilled large enough to accommodate the existing unit duct.
- Remove the existing unit duct and electrical cables and lengthen as needed by coupling new unit duct and cables to the existing as required to install the circuit through the foundation at a depth of 2 ft below grade.
- Splice unit duct and electrical cables as needed. The polyethylene jacket of the unit duct may be spliced below grade but cable shall be spliced in the pole hand hole only.

Basis of Payment: This work shall be paid for at the contract unit price each for DRILL EXISTING FOUNDATION which price shall be payment in full for all labor, equipment, and materials required to drill existing light pole foundation, remove the external lighting feed, modify the lighting feed for installation through the concrete foundation, and install the lighting feed into the light pole as described above, complete.

EQUIPMENT RENTAL RATES (BDE)

Effective: August 2, 2007

Revised: January 2, 2008

Replace the second and third paragraphs of Article 105.07(b)(4)a. of the Standard Specifications with the following:

“Equipment idled which cannot be used on other work, and which is authorized to standby on the project site by the Engineer, will be paid for according to Article 109.04(b)(4).”

Replace Article 109.04(b)(4) of the Standard Specifications with the following:

“(4) Equipment. Equipment used for extra work shall be authorized by the Engineer. The equipment shall be specifically described, be of suitable size and capacity for the work to be performed, and be in good operating condition. For such equipment, the Contractor will be paid as follows.

- a. Contractor Owned Equipment. Contractor owned equipment will be paid for by the hour using the applicable FHWA hourly rate from the “Equipment Watch Rental Rate Blue Book” (Blue Book) in effect when the force account work begins. The FHWA hourly rate is calculated as follows.

$$\text{FHWA hourly rate} = (\text{monthly rate}/176) \times (\text{model year adj.}) \times (\text{Illinois adj.}) + \text{EOC}$$

Where: EOC = Estimated Operating Costs per hour (from the Blue Book)

The time allowed will be the actual time the equipment is operating on the extra work. For the time required to move the equipment to and from the site of the extra work and any authorized idle (standby) time, payment will be made at the following hourly rate: $0.5 \times (\text{FHWA hourly rate} - \text{EOC})$.

All time allowed shall fall within the working hours authorized for the extra work.

The rates above include the cost of fuel, oil, lubrication, supplies, small tools, necessary attachments, repairs, overhaul and maintenance of any kind, depreciation, storage, overhead, profits, insurance, and all incidentals. The rates do not include labor.

The Contractor shall submit to the Engineer sufficient information for each piece of equipment and its attachments to enable the Engineer to determine the proper equipment category. If a rate is not established in the Blue Book for a particular piece of equipment, the Engineer will establish a rate for that piece of equipment that is consistent with its cost and use in the industry.

- b. Rented Equipment. Whenever it is necessary for the Contractor to rent equipment to perform extra work, the rental and transportation costs of the equipment plus five percent for overhead will be paid. In no case shall the rental rates exceed those of established distributors or equipment rental agencies.

All prices shall be agreed to in writing before the equipment is used.”

PAYMENTS TO SUBCONTRACTORS (BDE)

Effective: June 1, 2000

Revised: January 1, 2006

Federal regulations found at 49 CFR §26.29 mandate the Department to establish a contract clause to require Contractors to pay subcontractors for satisfactory performance of their subcontracts and to set the time for such payments.

State law also addresses the timing of payments to be made to subcontractors and material suppliers. Section 7 of the Prompt Payment Act, 30 ILCS 540/7, requires that when a Contractor receives any payment from the Department, the Contractor shall make corresponding, proportional payments to each subcontractor and material supplier performing work or supplying material within 15 calendar days after receipt of the Department payment. Section 7 of the Act further provides that interest in the amount of two percent per month, in addition to the payment due, shall be paid to any subcontractor or material supplier by the Contractor if the payment required by the Act is withheld or delayed without reasonable cause. The Act also provides that the time for payment required and the calculation of any interest due applies to transactions between subcontractors and lower-tier subcontractors and material suppliers throughout the contracting chain.

This Special Provision establishes the required federal contract clause, and adopts the 15 calendar day requirement of the State Prompt Payment Act for purposes of compliance with the federal regulation regarding payments to subcontractors. This contract is subject to the following payment obligations.

When progress payments are made to the Contractor according to Article 109.07 of the Standard Specifications, the Contractor shall make a corresponding payment to each subcontractor and material supplier in proportion to the work satisfactorily completed by each subcontractor and for the material supplied to perform any work of the contract. The proportionate amount of partial payment due to each subcontractor and material supplier throughout the contracting chain shall be determined by the quantities measured or otherwise determined as eligible for payment by the Department and included in the progress payment to the Contractor. Subcontractors and material suppliers shall be paid by the Contractor within 15 calendar days after the receipt of payment from the Department. The Contractor shall not hold retainage from the subcontractors. These obligations shall also apply to any payments made by subcontractors and material suppliers to their subcontractors and material suppliers; and to all payments made to lower tier subcontractors and material suppliers throughout the contracting chain. Any payment or portion of a payment subject to this provision may only be withheld from the subcontractor or material supplier to whom it is due for reasonable cause.

This Special Provision does not create any rights in favor of any subcontractor or material supplier against the State or authorize any cause of action against the State on account of any payment, nonpayment, delayed payment, or interest claimed by application of the State Prompt Payment Act. The Department will not approve any delay or postponement of the 15 day requirement except for reasonable cause shown after notice and hearing pursuant to Section 7(b) of the State Prompt Payment Act. State law creates other and additional remedies available to any subcontractor or material supplier, regardless of tier, who has not been paid for work properly performed or material furnished. These remedies are a lien against public funds set forth in Section 23(c) of the Mechanics Lien Act, 770 ILCS 60/23(c), and a recovery on the Contractor's payment bond according to the Public Construction Bond Act, 30 ILCS 550.

REFLECTIVE SHEETING ON CHANNELIZING DEVICES (BDE)

Effective: April 1, 2007

Revise the seventh paragraph of Article 1106.02 of the Standard Specifications to read:

“At the time of manufacturing, the retroreflective prismatic sheeting used on channelizing devices shall meet or exceed the initial minimum coefficient of retroreflection as specified in the following table. Measurements shall be conducted according to ASTM E 810, without averaging. Sheeting used on cones, drums and flexible delineators shall be reboundable as tested according to ASTM D 4956. Prestriped sheeting for rigid substrates on barricades shall be white and orange.

Initial Minimum Coefficient of Retroreflection candelas/foot candle/sq ft (candelas/lux/sq m) of material				
Observation Angle (deg.)	Entrance Angle (deg.)	White	Orange	Fluorescent Orange
0.2	-4	365	160	150
0.2	+30	175	80	70
0.5	-4	245	100	95
0.5	+30	100	50	40”

Revise the first sentence of the first paragraph of Article 1106.02(c) of the Standard Specifications to read:

“Barricades and vertical panels shall have alternating white and orange stripes sloping downward at 45 degrees toward the side on which traffic will pass.”

Revise the third sentence of the first paragraph of Article 1106.02(d) of the Standard Specifications to read:

“The bottom panels shall be 8 x 24 in. (200 x 600 mm) with alternating white and orange stripes sloping downward at 45 degrees toward the side on which traffic will pass.”

SUBCONTRACTOR MOBILIZATION PAYMENTS (BDE)

Effective: April 2, 2005

To account for the preparatory work and operations necessary for the movement of subcontractor personnel, equipment, supplies, and incidentals to the project site and for all other work or operations that must be performed or costs incurred when beginning work approved for subcontracting in accordance with Article 108.01 of the Standard Specifications, the Contractor shall make a mobilization payment to each subcontractor.

This mobilization payment shall be made at least 14 days prior to the subcontractor starting work. The amount paid shall be equal to 3 percent of the amount of the subcontract reported on form BC 260A submitted for the approval of the subcontractor’s work.

This provision shall be incorporated directly or by reference into each subcontract approved by the Department.

WORKING DAYS (BDE)

Effective: January 1, 2002

The Contractor shall complete the work within 20 working days.



**STATE OF ILLINOIS
DEPARTMENT OF TRANSPORTATION
DIVISION OF HIGHWAYS
SECTION D4 HIGHWAY LIGHTING 2008-1
PEORIA-TAZEWELL COUNTIES
C-94-091-08**

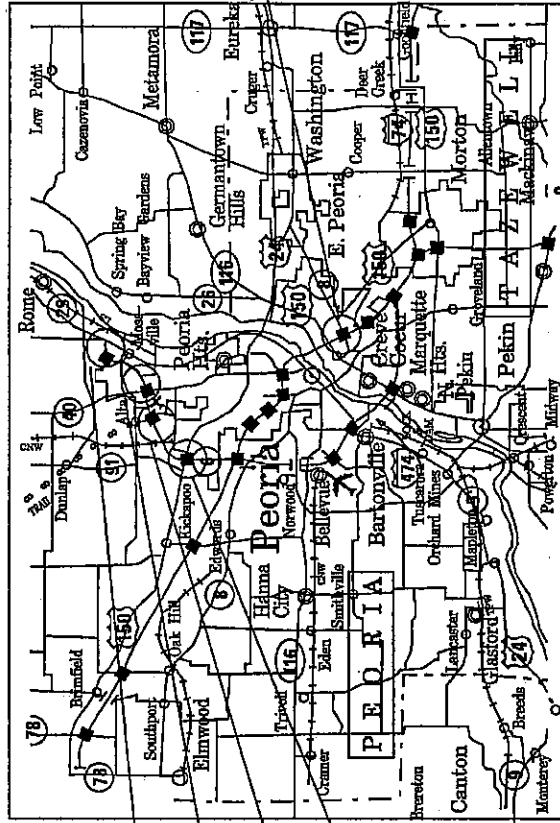

I-74 & IL 8
(CAMP ST.)

INDEX OF SHEETS

1. COVER SHEET AND NOTES
2. COMMITMENTS AND QUANTITIES
3. SUMMARY OF QUANTITIES
4. SCHEDULE OF QUANTITIES
5. LIGHTING DETAILS (IL 6 & US 150)
6. LIGHTING DETAILS (IL 6 & ALLEN)
- 7-8. LIGHTING DETAILS (IL 74 & IL 40)
9. LIGHTING DETAILS (IL 74 & IL 29 SPUR)
10. LIGHTING DETAILS (IL 29 & OLD GALENA)
11. LIGHTING DETAILS (IL 74 & IL 8 (CAMP))
12. LUMINAIRE WIRING DETAIL

- IL 6 & IL 29
- IL 6 & OLD GALENA RD.
- IL 6 & IL 40 (KNOXVILLE)
- IL 6 & ALLEN RD.
- IL 6 & US 150 (WAR MEMORIAL)

STANDARDS

- 701001-01
- 701006-02
- 701011-01
- 701101-01
- 701106-01
- 701301-02
- 701602-03
- 701901

LOCATION OF IMPROVEMENT

INTERCHANGES OF IL 6 & US 150, IL 6 & ALLEN, IL 6 & IL 29, AND IL 29 & OLD GALENA RD. IN PEORIA COUNTY; INTERCHANGE OF I-74 & IL 8 (CAMP ST.) IN EAST PEORIA, IN TAZEWELL COUNTY.
CONTRACT NO. 68822
CATALOG NO. 033835-000

DESCRIPTION OF WORK

THIS PROJECT CONSISTS OF REMOVING EXISTING LUMINAIRES AND INSTALLING DEPARTMENT SUPPLIED LUMINAIRES AT THE INTERCHANGES OF IL 6 & US 150, IL 6 & ALLEN, IL 6 & IL 40, IL 6 & IL 29, AND IL 29 & OLD GALENA RD. AND REMOVING EXISTING LIGHT POLES AND LUMINAIRES AND INSTALLING NEW LIGHT POLES, LUMINAIRES, AND BREAKAWAY COUPLINGS AT THE INTERCHANGE OF I-74 & IL 8 (CAMP ST.) AND ALL OTHER WORK REQUIRED TO COMPLETE THE IMPROVEMENTS.

JULIE 1-800-892-6123
JOINT UTILITY LOCATION INFORMATION FOR EXCAVATION

**STATE OF ILLINOIS
DEPARTMENT OF TRANSPORTATION
DIVISION OF HIGHWAYS**

SUBMITTED April 4, 2008
J. E. Crane

DEPUTY DIRECTOR OF HIGHWAYS REGION ENGINEER
PRINTED BY THE AUTHORITY OF THE STATE OF ILLINOIS

ROUTE		SECTION	COUNTY	SHEET	
MKD.	DESIG.			TOTAL	NO.
FAP 318	IL 6	D4 HIGHWAY LIGHTING 2008-1	PEORIA TAZEWELL	12	2
FAP 399	IL 8				

COMMITMENTS

NO COMMITMENTS WERE MADE IN CONJUNCTION WITH THIS PROJECT.

CONSTRUCTION NOTES

ANY MAINTENANCE OF EXISTING LIGHTING SHALL BE CONSIDERED EXTRA WORK IN ACCORDANCE WITH ARTICLE 109.04 OF THE STANDARD SPECIFICATIONS.

THE LOCATION OF ALL UTILITIES AND PRIVATELY OWNED FACILITIES SHALL BE FIELD VERIFIED BY THE CONTRACTOR PRIOR TO THE INSTALLATION OF ANY COMPONENTS.

THE CONTRACTOR SHALL BE RESPONSIBLE FOR LOCATING ALL EXISTING IDOT ELECTRICAL FACILITIES.

ELECTRICAL WORK SHALL CONFORM WITH NATIONAL, STATE, AND LOCAL CODES.

ALL SURPLUS MATERIALS SHALL BE DISPOSED OF IN ACCORDANCE WITH ARTICLE 202.03 OF THE STANDARD SPECIFICATIONS.

THE REMOVAL OF THE EXISTING LIGHT POLES AND COUPLINGS AT THE INTERCHANGE OF IL 8 (CAMP ST.) & I-74 IN EAST PEORIA SHALL BE INCLUDED IN THE BID PRICE FOR THE PROPOSED LIGHT POLES. THE CONTRACTOR SHALL DISPOSE OF THESE ITEMS OFF OF THE RIGHT-OF-WAY AND REFLECT THE SALVAGE VALUE OF THESE ITEMS IN THE BID PRICE FOR THE PROPOSED LIGHT POLES.

THE REMOVAL OF EXISTING LUMINAIRES, CABLES, ETC. AT THE INTERCHANGE OF IL 8 (CAMP ST.) & I-74 IN EAST PEORIA SHALL BE INCLUDED IN THE BID PRICE FOR THE PROPOSED LUMINAIRES.

THE CONTRACTOR SHALL DISPOSE OF THESE ITEMS OFF OF THE RIGHT-OF-WAY AND REFLECT THE SALVAGE VALUE OF THESE ITEMS IN THE BID PRICE FOR THE PROPOSED LUMINAIRES.

THE PROPOSED LUMINAIRES AT IL 8 (CAMP ST.) SHALL BE 240V, MEDIUM CUTOFF, TYPE 3 DISTRIBUTION.

COMMITMENTS AND NOTES

ROUTE		SECTION	COUNTY	SHEET	
MKD.	DESIG.			TOTAL	NO.
FAP 318	IL 6	D4 HIGHWAY LIGHTING 2008-1	PEORIA TAZEWELL	12	3
FAP 399	IL 8				

CODE NUMBER	ITEM DESCRIPTION	UNIT	TOTAL QTY	PEORIA CTY.		TAZEWELL CTY.	
				CONST. TYPE CODE	100% STATE 0% CITY URBAN	CONST. TYPE CODE	100% STATE 0% CITY URBAN
67100100	MOBILIZATION	L SUM	1.0	0.8	0.2		
70102630	TRAFFIC CONTROL AND PROTECTION, STANDARD 701601	L SUM	1.0		1.0		
82102150	LUMINAIRE, SODIUM VAPOR, HORIZONTAL MOUNT, 250 WATT	EACH	10.0		10.0		
83001200	LIGHT POLE, ALUMINUM, 35 FT. M.H., 6 FT. DAVIT ARM	EACH	10.0		10.0		
83800650	BREAKAWAY DEVICE, COUPLING, WITH STAINLESS STEEL SCREEN	EACH	32.0		32.0		
87900100	DRILL EXISTING FOUNDATION	EACH	1.0		1.0		
X0323857	EXISTING LIGHT POLE FOUNDATION ADJUSTMENT	EACH	1.0		1.0		
XX001164	LUMINAIRE, HIGH PRESSURE SODIUM, SPECIAL	EACH	73.0	73.0			

SUMMARY OF QUANTITIES

ROUTE		SECTION	COUNTY	SHEET	
MKD.	DESIG.			TOTAL	NO.
FAP 318	IL 6	D4 HIGHWAY LIGHTING 2008-1	PEORIA TAZEWELL	12	4
FAP 399	IL 8				

SCHEDULE OF QUANTITIES

ITEM DESCRIPTION	UNIT	TOTAL QTY	PEORIA CTY.				TAZEWELL CTY.
			IL 6 & US 150 ALLEN	IL 6 & IL 40	IL 6 & IL 29	IL 29 & GALENA	
MOBILIZATION	L-SUM	1.0	0.1	0.2	0.2	0.1	
TRAFFIC CONTROL AND PROTECTION, STANDARD 701602	L-SUM	1.0					1.0
LIGHT POLE, ALUMINUM, 35 FT. M.H., 6 FT. DAVIT ARM	EACH	10.0					10.0
LUMINAIRE, SODIUM VAPOR, HORIZONTAL MOUNT, 250 WATT	EACH	10.0					10.0
BREAKAWAY DEVICE, COUPLING, WITH STAINLESS STEEL SCREEN	EACH	32.0					32.0
DRILL EXISTING FOUNDATION	EACH	1.0					1.0
EXISTING-LIGHT POLE FOUNDATION ADJUSTMENT	EACH	1.0					1.0
LUMINAIRE, HIGH PRESSURE SODIUM, SPECIAL	EACH	73.0	8.0	23.0	19.0	9.0	

SCHEDULE OF QUANTITIES

ROUTE		SECTION		COUNTY		SHEET	
MKD.	DESIG.	D4 HIGHWAY LIGHTING 2008-1		PEORIA TAZEWELL		TOTAL	NO.
FAP 318	IL 6					12	5
FAP 399	IL 8						

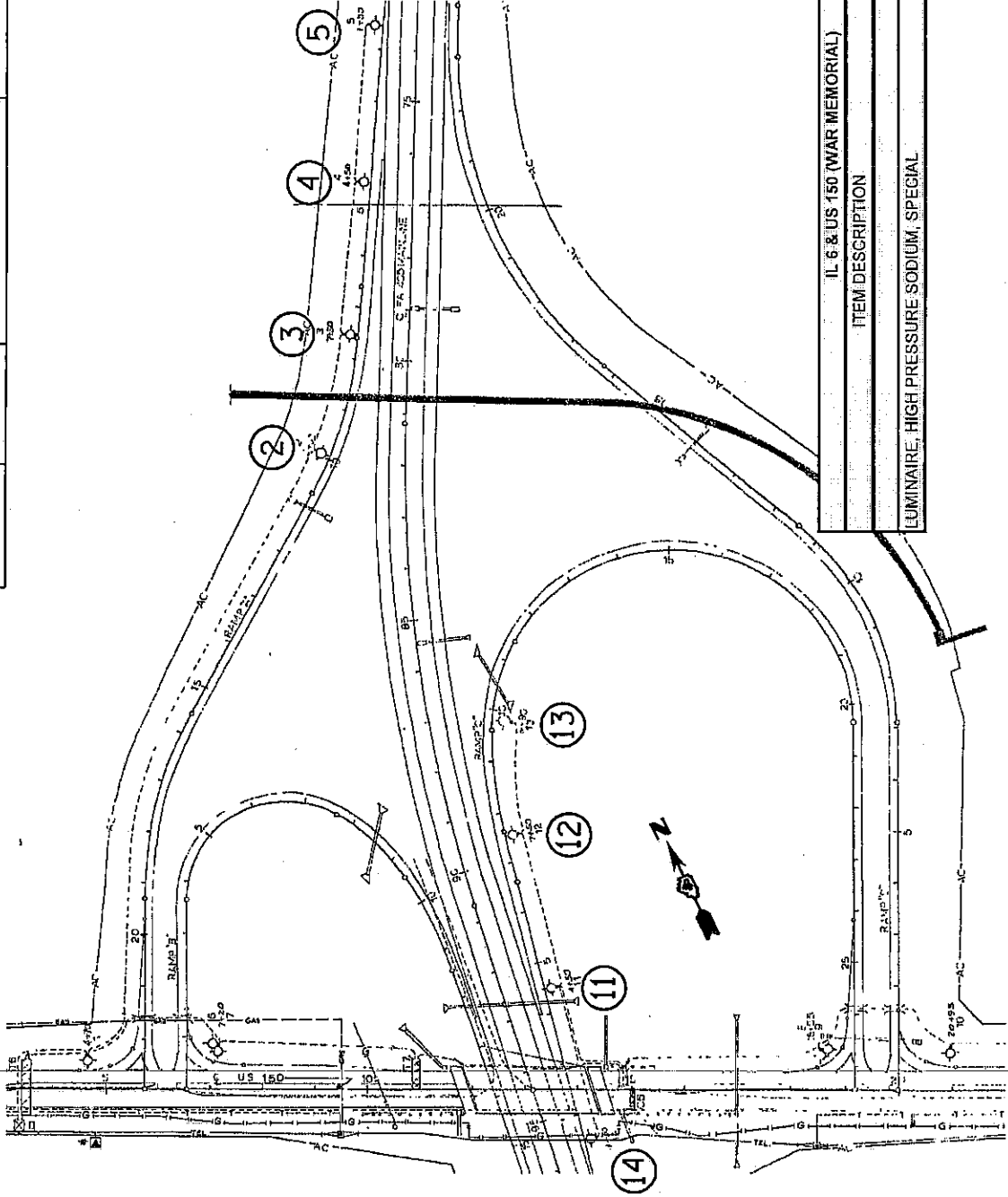

IL 6 & US 150 (WAR MEMORIAL)		
ITEM DESCRIPTION	UNIT	QUANTITY
LUMINAIRE, HIGH PRESSURE SODIUM, SPECIAL	EACH	8

EXISTING LIGHT POLES ARE 45' ALUMINUM TENON TOP POLES

NOT TO SCALE

LIGHTING DETAILS
IL 6 & US 150

ROUTE		SECTION	COUNTY	SHEET	
MKD.	DESIG.	D4 HIGHWAY LIGHTING 2008-1	PEORIA TAZEWELL	TOTAL	NO.
FAP 318	IL 6			12	6
FAP 399	IL 8				

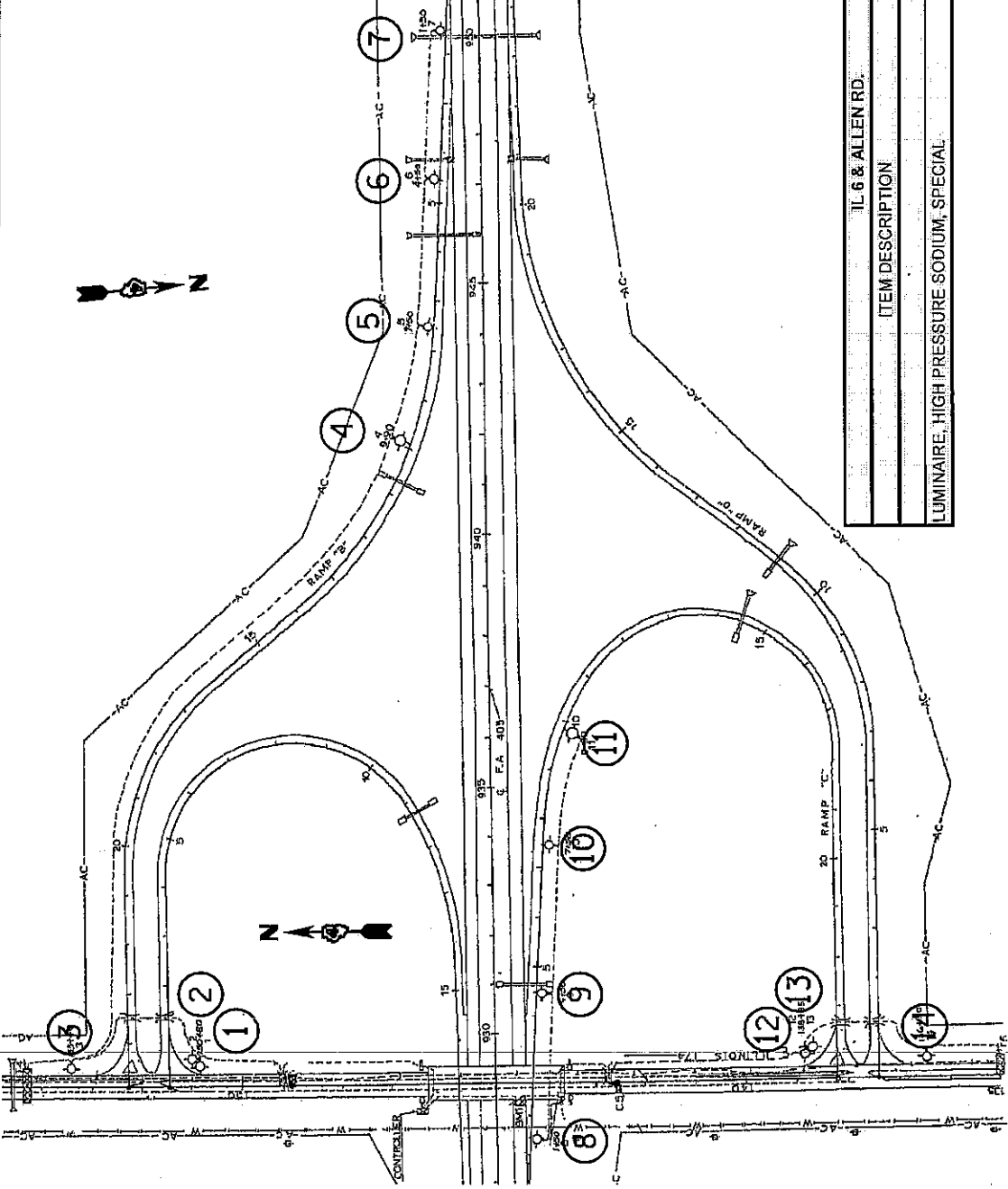

ITEM DESCRIPTION	UNIT	QUANTITY
LUMINAIRE, HIGH PRESSURE SODIUM, SPECIAL	EACH	14

EXISTING LIGHT POLES ARE 45' ALUMINUM TENON TOP POLES

NOT TO SCALE

LIGHTING DETAILS
IL 6 & ALLEN RD.

ROUTE		SECTION	COUNTY	SHEET	
MKD.	DESIG.	D4 HIGHWAY LIGHTING 2008-1	PEORIA TAZEWELL	TOTAL	NO.
FAP 318	IL 6			12	7
FAP 399	IL 8				

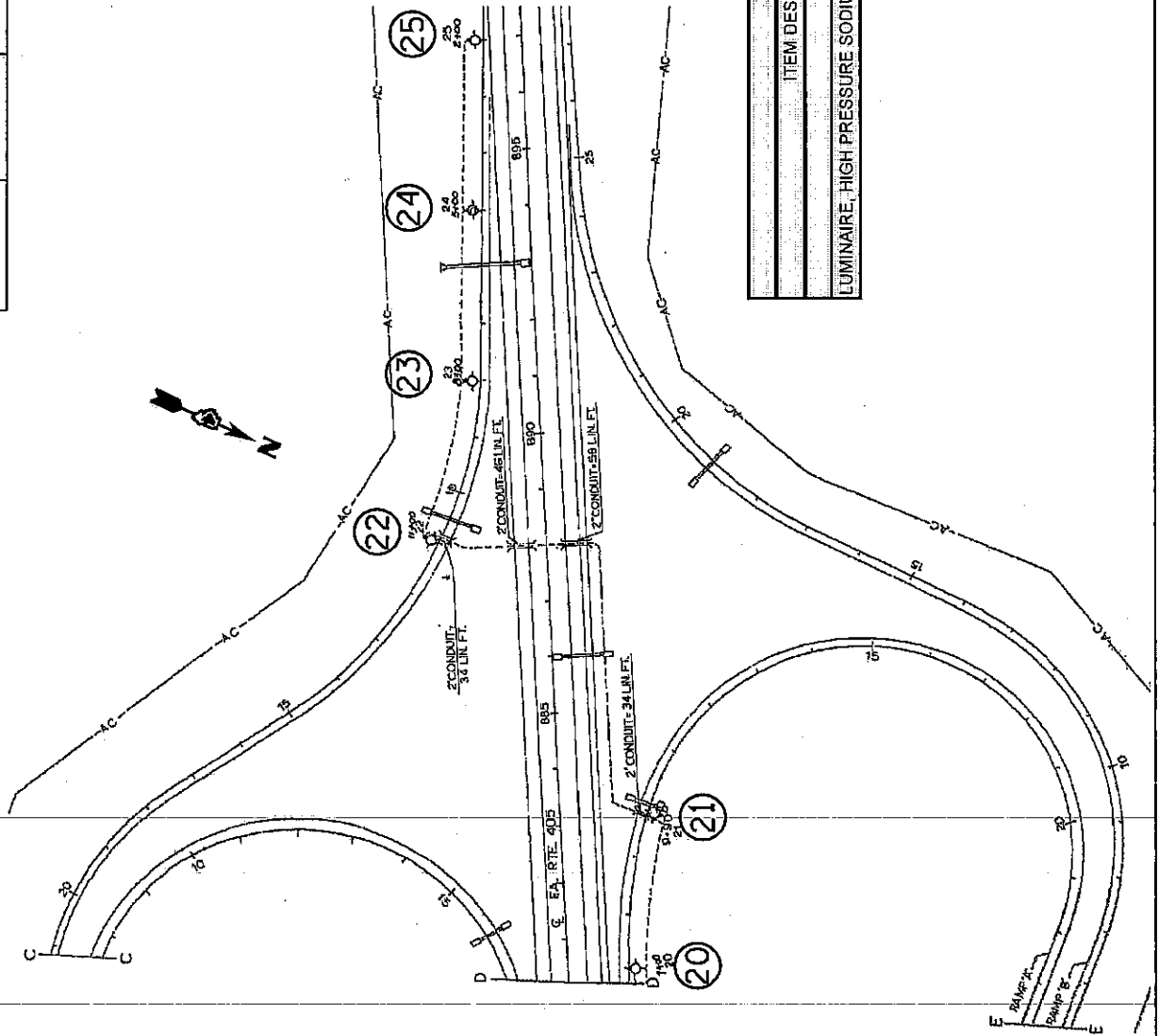

IL 6 & IL 40 (KNOXVILLE)		
ITEM DESCRIPTION	UNIT	QUANTITY
LUMINAIRE, HIGH PRESSURE SODIUM, SPECIAL	EACH	6

EXISTING LIGHT POLES ARE 45'
ALUMINUM TENON TOP POLES

NOT TO SCALE

LIGHTING DETAILS
IL 6 & IL 40

ROUTE		SECTION		COUNTY		SHEET	
MKD.	DESIG.	D4 HIGHWAY LIGHTING 2008-1		PEORIA		TOTAL NO.	
FAP 318	IL 6			TAZEWELL		12	
FAP 399	IL 8					8	

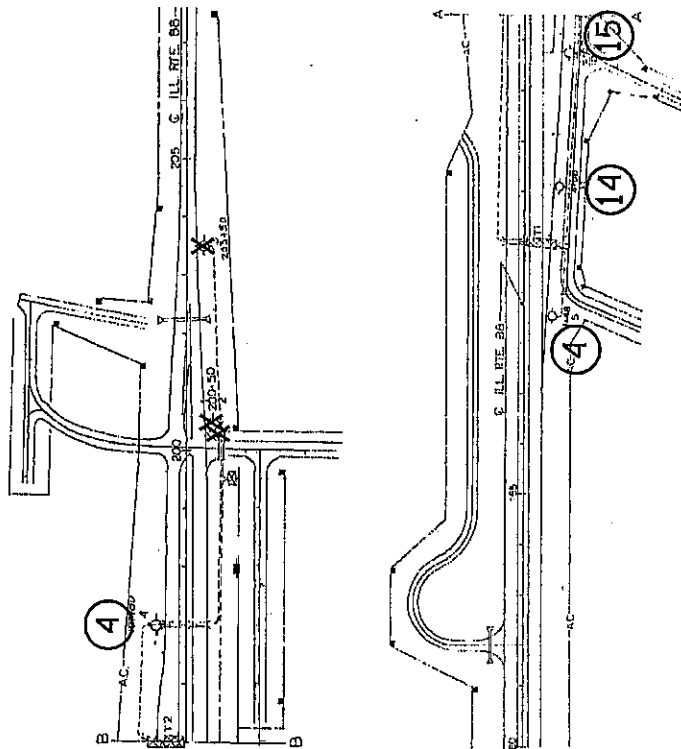
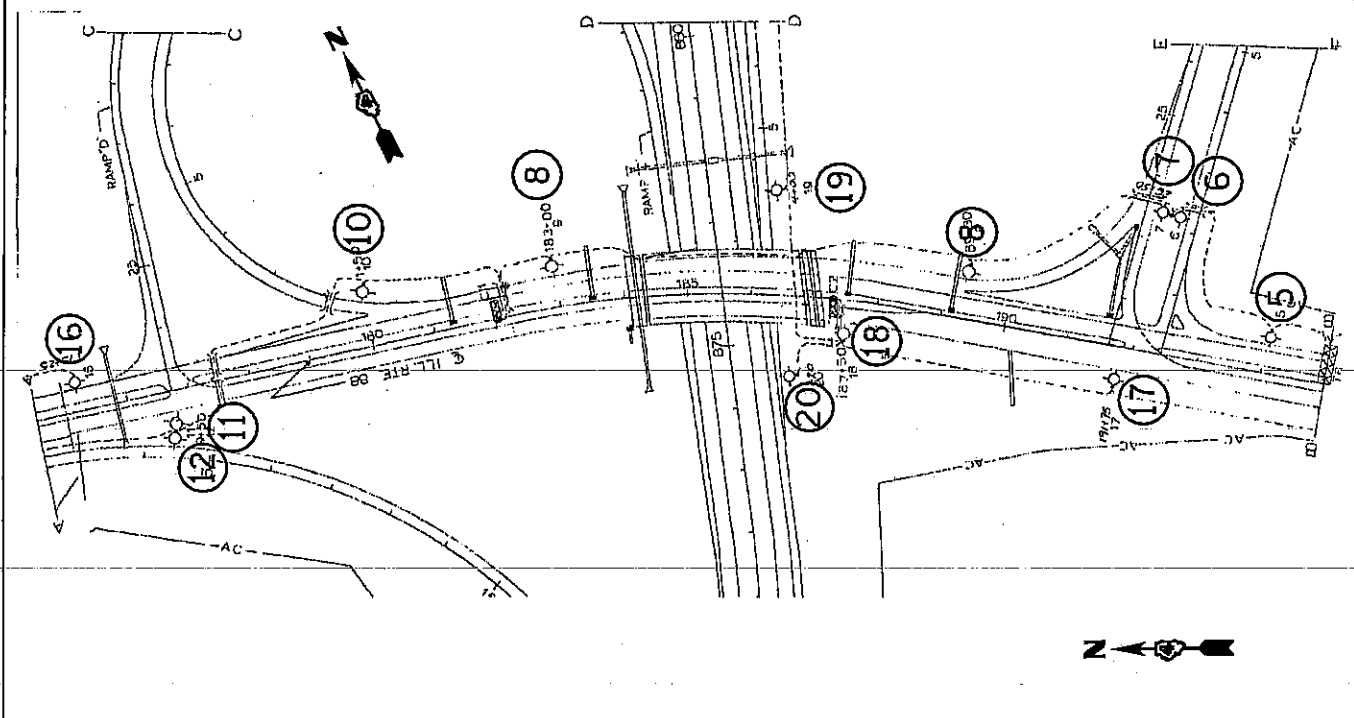

IL 6 & IL 40 (KNOXVILLE)		UNIT	QUANTITY
ITEM DESCRIPTION			
LUMINAIRE, HIGH PRESSURE SODIUM, SPECIAL		EACH	17

EXISTING LIGHT POLES ARE 45' ALUMINUM TENON TOP POLES

NOT TO SCALE

LIGHTING DETAILS
IL 6 & IL 40

ROUTE		SECTION	COUNTY	SHEET
MKD.	DESIG.	D4 HIGHWAY LIGHTING 2008-1	PEORIA TAZEWELL	TOTAL
FAP 318	IL 6			NO.
FAP 399	IL 8			12

ITEM DESCRIPTION	UNIT	QUANTITY
IL 6 & IL 29 SPUR		
LUMINAIRE: HIGH PRESSURE SODIUM, SPECIAL	EACH	7

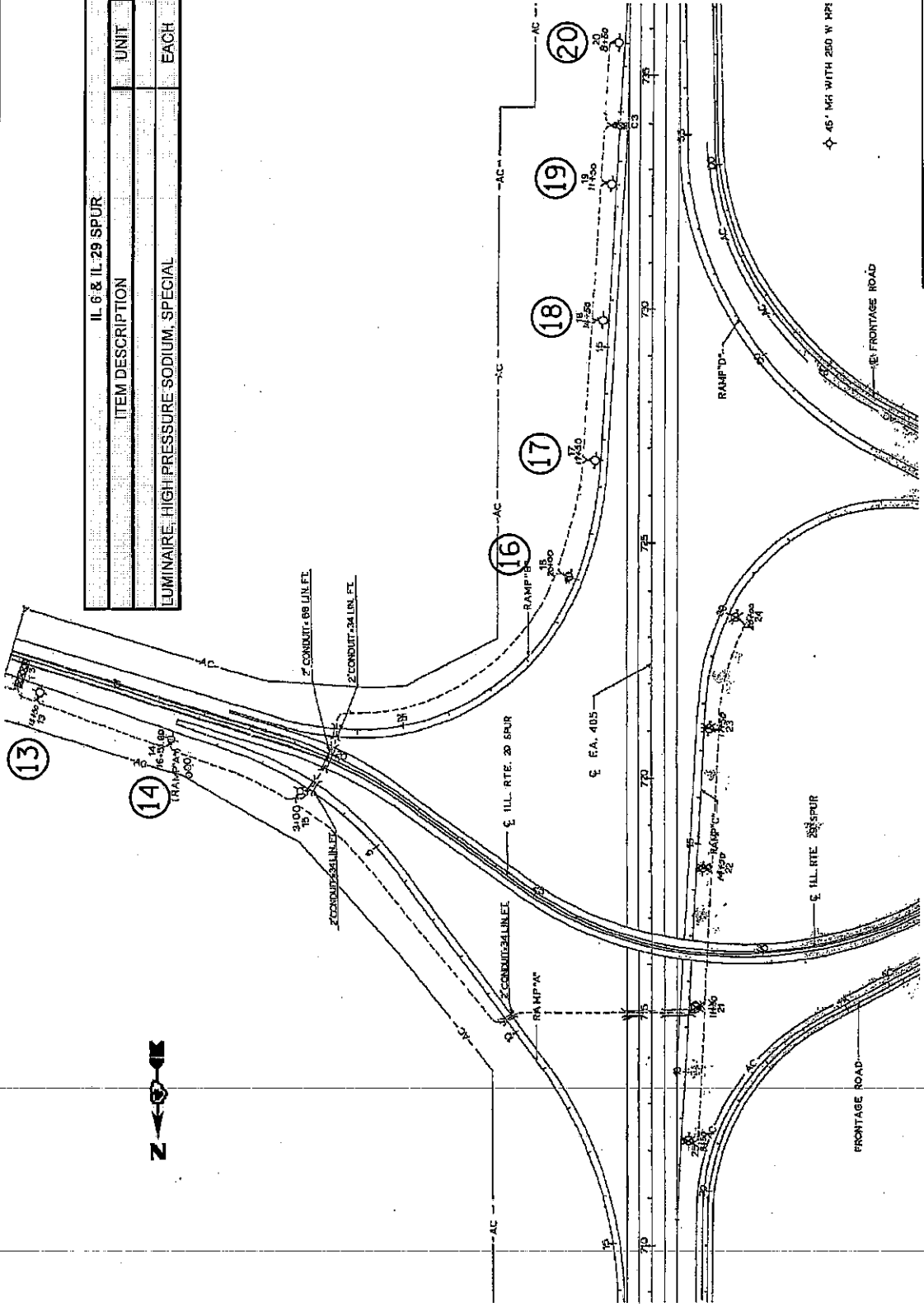

LIGHTING DETAILS
IL 6 & IL 29

NOT TO SCALE

EXISTING LIGHT POLES ARE 45'
ALUMINUM TENON TOP POLES

ROUTE		SECTION	COUNTY	SHEET	
MKD.	DESIG.			TOTAL	NO.
FAP 318	IL 6	D4 HIGHWAY	PEORIA	12	10
FAP 399	IL 8	LIGHTING 2008-1	TAZEWELL	12	10

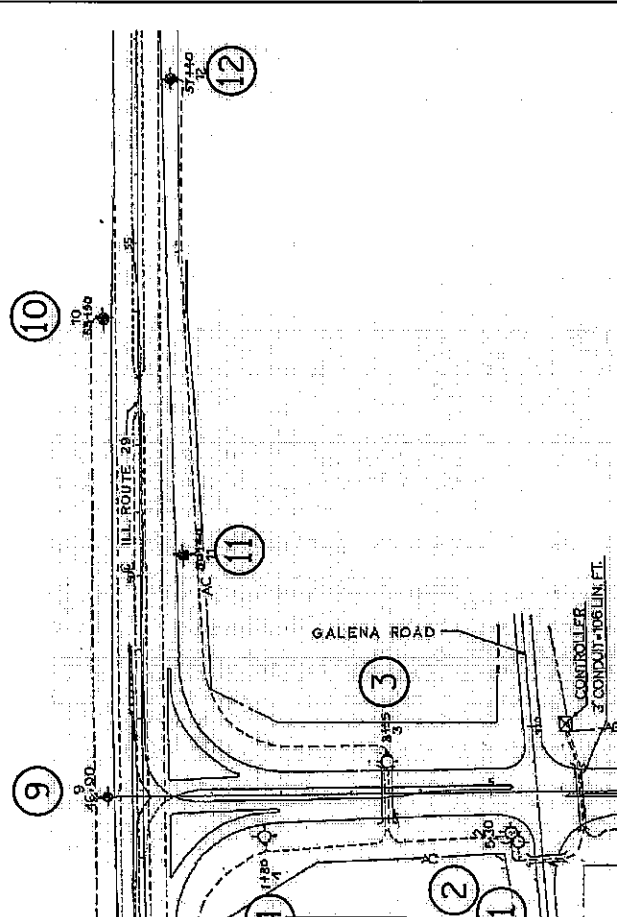

ITEM DESCRIPTION	UNIT	QUANTITY
IL 6 & IL 29 SPUR	EACH	12
LUMINAIRE, HIGH PRESSURE SODIUM, SPECIAL	EACH	12

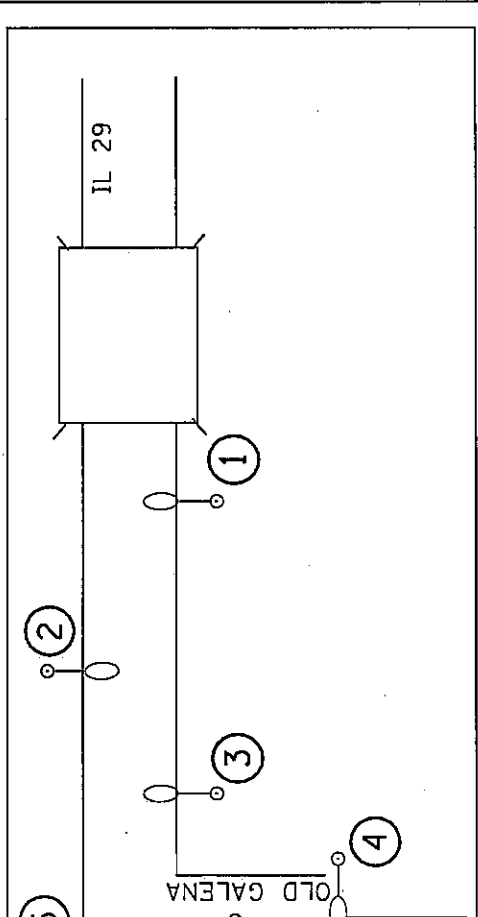

ITEM DESCRIPTION	UNIT	QUANTITY
IL 29 & OLD GALENA RD.	EACH	9
LUMINAIRE, HIGH PRESSURE SODIUM, SPECIAL	EACH	9

EXISTING LIGHT POLES ARE 45' ALUMINUM TENON TOP POLES

NOT TO SCALE

LIGHTING DETAILS
IL 6 & IL 29
IL 29 & OLD GALENA RD.

ROUTE		SECTION	COUNTY	SHEET	
MKD.	DESIG.	D4 HIGHWAY LIGHTING 2008-1	PEORIA TAZEWELL	TOTAL	NO.
FAP 318	IL 6			12	11
FAP 399	IL 8				

174 & IL 8 (CAMP ST.) - EAST PEORIA		
ITEM DESCRIPTION	UNIT	QUANTITY
LIGHT POLE, ALUMINUM, 35 FT. M.H., 16 FT. DAVIT ARM	EACH	10
LUMINAIRE, SODIUM VAPOR, HORIZONTAL MT., 150 W	EACH	10
BREAKAWAY DEVICE, COUPLING, WITH SS SCREEN	EACH	32
DRILL EXISTING FOUNDATION	EACH	1
EXISTING LIGHT POLE FOUNDATION ADJUSTMENT	EACH	1

LIGHT POLE NUMBER	LIGHT POLE, ALUMINUM, 35 FT. M.H., 16 FT. DAVIT ARM	LUMINAIRE, SODIUM VAPOR, 150 WATT HORIZ. MT.	BREAKAWAY DEVICE, COUPLING, SS SCREEN	COMMENTS
1	1	1	4	
2	1	1	4	
3	1	1	4	
4	1	1	4	DRILL EXISTING FOUNDATION
5	1	1	4	
6	1	1	4	BEHIND GUARDRAIL
7	1	1	4	BEHIND GUARDRAIL
8	1	1	4	
9	1	1	4	
10	1	1	4	ADJUST EXISTING FOUNDATION

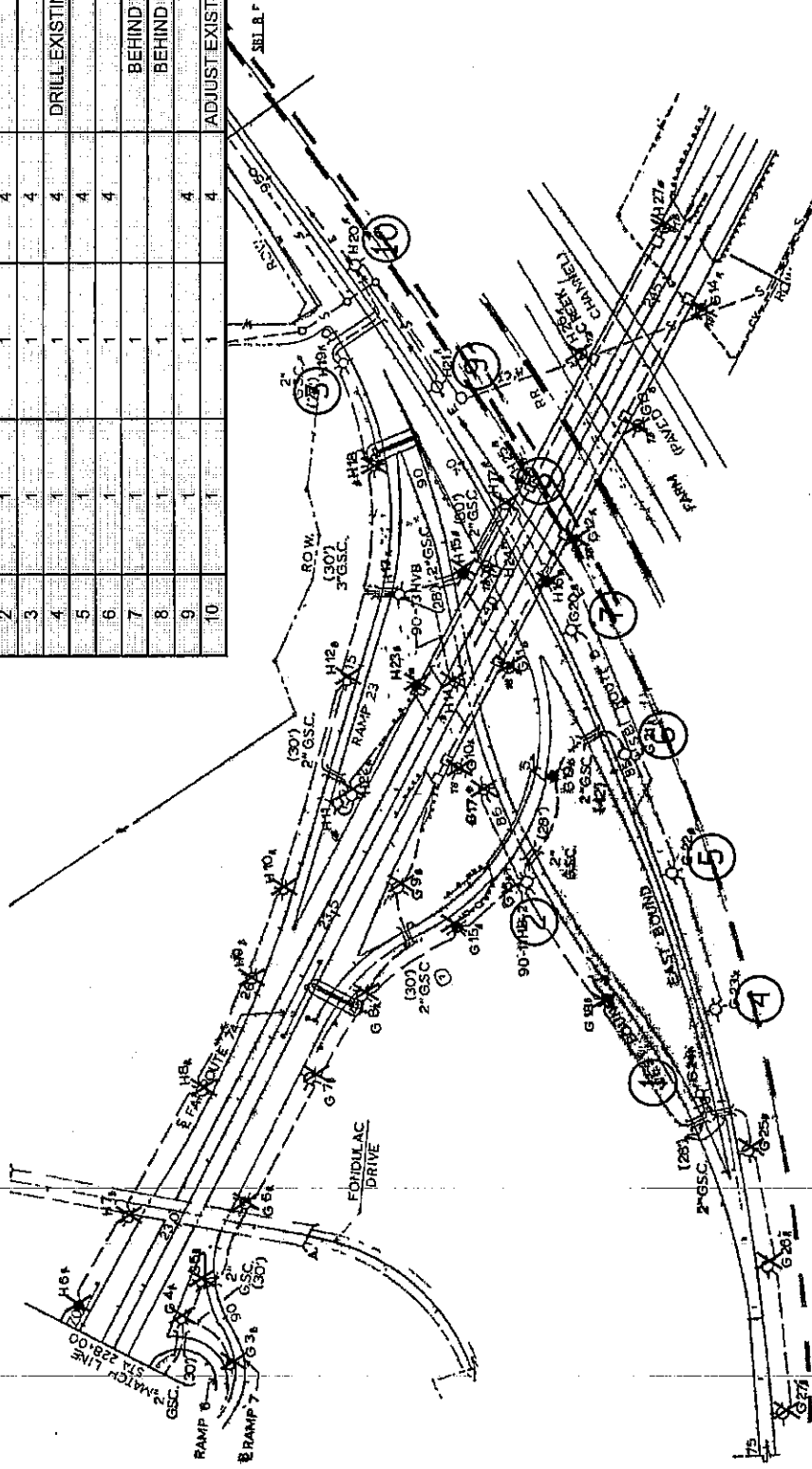

LIGHTING DETAILS
IL 8 (CAMP ST.)
EAST PEORIA

NOT TO SCALE

ROUTE		SECTION	COUNTY	SHEET	
MKD.	DESIG.			TOTAL	NO.
FAP 318	IL 6	D4 HIGHWAY LIGHTING 2008-1	PEORIA TAZEWELL	12	12
FAP 399	IL 8				

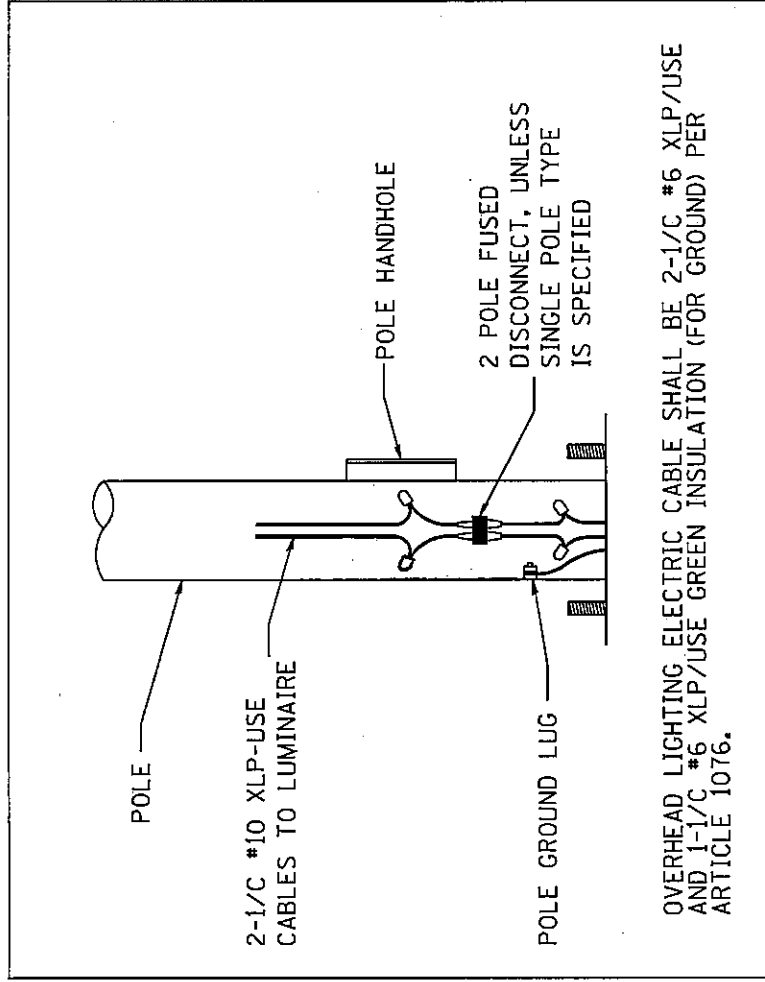

NOT TO SCALE

LUMINAIRE DETAIL
I-74 & IL 8 (CAMP ST.)

ILLINOIS DEPARTMENT OF LABOR

PREVAILING WAGES FOR PEORIA-TAZEWELL COUNTY EFFECTIVE MAY 2008

The Prevailing rates of wages are included in the Contract proposals which are subject to Check Sheet #5 of the Supplemental Specifications and Recurring Special Provisions. The rates have been ascertained and certified by the Illinois Department of Labor for the locality in which the work is to be performed and for each craft or type of work or mechanic needed to execute the work of the Contract. As required by Prevailing Wage Act (820 ILCS 130/0.01, et seq.) and Check Sheet #5 of the Contract, not less than the rates of wages ascertained by the Illinois Department of Labor and as revised during the performance of a Contract shall be paid to all laborers, workers and mechanics performing work under the Contract. Post the scale of wages in a prominent and easily accessible place at the site of work.

If the Illinois Department of Labor revises the prevailing rates of wages to be paid as listed in the specification of rates, the contractor shall post the revised rates of wages and shall pay not less than the revised rates of wages. Current wage rate information shall be obtained by visiting the Illinois Department of Labor web site at <http://www.state.il.us/agency/idol/> or by calling 312-793-2814. It is the responsibility of the contractor to review the rates applicable to the work of the contract at regular intervals in order to insure the timely payment of current rates. Provision of this information to the contractor by means of the Illinois Department of Labor web site satisfies the notification of revisions by the Department to the contractor pursuant to the Act, and the contractor agrees that no additional notice is required. The contractor shall notify each of its subcontractors of the revised rates of wages.

Peoria County Prevailing Wage for May 2008

Trade Name	RG	TYP	C	Base	FRMAN	*M-F>8	OSA	OSH	H/W	Pensn	Vac	Trng
=====	==	==	=	=====	=====	=====	==	==	=====	=====	=====	=====
ASBESTOS ABT-GEN		BLD		24.200	25.700	1.5	1.5	2.0	6.250	10.09	0.000	0.750
ASBESTOS ABT-GEN		HWY		25.640	26.390	1.5	1.5	2.0	6.250	10.71	0.000	0.700
ASBESTOS ABT-MEC		BLD		25.480	27.230	1.5	1.5	2.0	8.760	6.410	0.000	0.310
BOILERMAKER		BLD		30.970	33.970	2.0	2.0	2.0	8.270	7.740	0.000	0.300
BRICK MASON		BLD		27.020	28.520	1.5	1.5	2.0	6.250	7.350	0.000	0.420
CARPENTER		BLD		26.540	28.540	1.5	1.5	2.0	6.750	8.150	0.000	0.320
CARPENTER		HWY		27.340	29.340	1.5	1.5	2.0	6.750	8.520	0.000	0.320
CEMENT MASON		BLD		24.220	25.970	1.5	1.5	2.0	5.490	10.44	0.000	0.500
CEMENT MASON		HWY		25.500	26.500	1.5	1.5	2.0	5.490	10.44	0.000	0.500
CERAMIC TILE FNSHER		BLD		24.910	0.000	1.5	1.5	2.0	6.250	7.350	0.000	0.420
ELECTRIC PWR EQMT OP		ALL		30.750	0.000	1.5	1.5	2.0	4.750	8.610	0.000	0.000
ELECTRIC PWR GRNDMAN		ALL		21.090	0.000	1.5	1.5	2.0	4.750	5.905	0.000	0.000
ELECTRIC PWR LINEMAN		ALL		34.160	36.350	1.5	1.5	2.0	4.750	9.560	0.000	0.000
ELECTRIC PWR TRK DRV		ALL		22.130	0.000	1.5	1.5	2.0	4.750	6.200	0.000	0.000
ELECTRICIAN		BLD		31.190	33.690	1.5	1.5	2.0	5.150	8.480	0.000	0.250
ELECTRONIC SYS TECH		BLD		24.830	26.330	1.5	1.5	2.0	5.150	6.145	0.000	0.250
ELEVATOR CONSTRUCTOR		BLD		35.615	40.070	2.0	2.0	2.0	8.775	6.960	2.140	0.000
GLAZIER		BLD		27.020	27.770	1.5	1.5	2.0	6.400	5.750	0.000	0.500
HT/FROST INSULATOR		BLD		36.400	38.150	1.5	1.5	2.0	8.760	10.11	0.000	0.310
IRON WORKER		BLD		26.310	28.060	1.5	1.5	2.0	8.140	7.810	0.000	0.400
IRON WORKER		HWY		28.570	30.070	1.5	1.5	2.0	8.140	7.810	0.000	0.350
LABORER		BLD		23.200	24.700	1.5	1.5	2.0	6.250	10.09	0.000	0.700
LABORER		HWY		24.890	25.640	1.5	1.5	2.0	6.250	10.71	0.000	0.700
LABORER, SKILLED		BLD		23.600	25.100	1.5	1.5	2.0	6.250	10.09	0.000	0.700
LABORER, SKILLED		HWY		25.190	25.940	1.5	1.5	2.0	6.250	10.71	0.000	0.700
LATHER		BLD		26.540	28.540	1.5	1.5	2.0	6.750	8.150	0.000	0.320
MACHINERY MOVER		HWY		28.570	30.070	1.5	1.5	2.0	8.140	7.810	0.000	0.350
MACHINIST		BLD		38.390	40.390	2.0	2.0	2.0	4.880	6.550	2.650	0.000
MARBLE FINISHERS		BLD		24.910	0.000	1.5	1.5	2.0	6.250	7.350	0.000	0.420
MARBLE MASON		BLD		26.520	27.770	1.5	1.5	2.0	6.250	7.350	0.000	0.420
MILLWRIGHT		BLD		27.180	29.180	1.5	1.5	2.0	6.750	7.850	0.000	0.320
MILLWRIGHT		HWY		28.410	30.410	1.5	1.5	2.0	6.750	7.950	0.000	0.320
OPERATING ENGINEER		BLD	1	29.420	32.420	1.5	1.5	2.0	6.450	10.00	0.000	1.100
OPERATING ENGINEER		BLD	2	27.360	32.420	1.5	1.5	2.0	6.450	10.00	0.000	1.100
OPERATING ENGINEER		BLD	3	25.850	32.420	1.5	1.5	2.0	6.450	10.00	0.000	1.100
OPERATING ENGINEER		HWY	1	30.300	33.300	1.5	1.5	2.0	6.450	10.00	0.000	1.100
OPERATING ENGINEER		HWY	2	27.790	33.300	1.5	1.5	2.0	6.450	10.00	0.000	1.100
OPERATING ENGINEER		HWY	3	23.640	33.300	1.5	1.5	2.0	6.450	10.00	0.000	1.100
PAINTER		ALL		29.850	31.850	1.5	1.5	1.5	6.750	6.750	0.000	0.500
PAINTER SIGNS		BLD		28.970	32.520	1.5	1.5	1.5	2.600	2.310	0.000	0.000
PILEDRIVER		BLD		27.040	29.040	1.5	1.5	2.0	6.750	8.150	0.000	0.320
PILEDRIVER		HWY		28.340	30.340	1.5	1.5	2.0	6.750	8.520	0.000	0.320
PIPEFITTER		BLD		32.830	36.440	1.5	1.5	2.0	6.450	8.240	0.000	0.610
PLASTERER		BLD		24.490	25.740	1.5	1.5	2.0	5.490	10.24	0.000	0.500
PLUMBER		BLD		29.630	32.300	1.5	1.5	2.0	6.450	9.550	0.000	0.900
ROOFER		BLD		25.250	26.250	1.5	1.5	2.0	5.550	6.700	0.000	0.150
SHEETMETAL WORKER		BLD		28.740	30.180	1.5	1.5	2.0	5.770	10.21	0.000	0.310
SIGN HANGER		HWY		28.570	30.070	1.5	1.5	2.0	8.140	7.810	0.000	0.350
SPRINKLER FITTER		BLD		35.140	37.690	1.5	1.5	2.0	7.000	6.200	0.000	0.250
STEEL ERECTOR		HWY		28.570	30.070	1.5	1.5	2.0	8.140	7.810	0.000	0.350
STONE MASON		BLD		27.020	28.520	1.5	1.5	2.0	6.250	7.350	0.000	0.420
TERRAZZO FINISHER		BLD		24.910	0.000	1.5	1.5	2.0	6.250	7.350	0.000	0.420
TERRAZZO MASON		BLD		26.520	27.770	1.5	1.5	2.0	6.250	7.350	0.000	0.420
TILE MASON		BLD		26.520	27.770	1.5	1.5	2.0	6.250	7.350	0.000	0.420
TRUCK DRIVER		ALL	1	27.457	0.000	1.5	1.5	2.0	8.600	3.797	0.000	0.000
TRUCK DRIVER		ALL	2	27.857	0.000	1.5	1.5	2.0	8.600	3.797	0.000	0.000
TRUCK DRIVER		ALL	3	28.057	0.000	1.5	1.5	2.0	8.600	3.797	0.000	0.000
TRUCK DRIVER		ALL	4	28.307	0.000	1.5	1.5	2.0	8.600	3.797	0.000	0.000

TRUCK DRIVER	ALL	5	29.057	0.000	1.5	1.5	2.0	8.600	3.797	0.000	0.000
TRUCK DRIVER	O&C	1	21.970	0.000	1.5	1.5	2.0	8.600	3.797	0.000	0.000
TRUCK DRIVER	O&C	2	22.290	0.000	1.5	1.5	2.0	8.600	3.797	0.000	0.000
TRUCK DRIVER	O&C	3	22.450	0.000	1.5	1.5	2.0	8.600	3.797	0.000	0.000
TRUCK DRIVER	O&C	4	22.650	0.000	1.5	1.5	2.0	8.600	3.797	0.000	0.000
TRUCK DRIVER	O&C	5	23.250	0.000	1.5	1.5	2.0	8.600	3.797	0.000	0.000
TUCKPOINTER	BLD		27.020	28.520	1.5	1.5	2.0	6.250	7.350	0.000	0.420

Legend:

M-F>8 (Overtime is required for any hour greater than 8 worked each day, Monday through Friday.)

OSA (Overtime is required for every hour worked on Saturday)

OSH (Overtime is required for every hour worked on Sunday and Holidays)

H/W (Health & Welfare Insurance)

Pensn (Pension)

Vac (Vacation)

Trng (Training)

Explanations

PEORIA COUNTY

The following list is considered as those days for which holiday rates of wages for work performed apply: New Years Day, Memorial/Decoration Day, Fourth of July, Labor Day, Veterans Day, Thanksgiving Day, Christmas Day. Generally, any of these holidays which fall on a Sunday is celebrated on the following Monday. This then makes work performed on that Monday payable at the appropriate overtime rate for holiday pay. Common practice in a given local may alter certain days of celebration such as the day after Thanksgiving for Veterans Day. If in doubt, please check with IDOL.

Oil and chip resealing (O&C) means the application of road oils and liquid asphalt to coat an existing road surface, followed by application of aggregate chips or gravel to coated surface, and subsequent rolling of material to seal the surface.

EXPLANATION OF CLASSES

ASBESTOS - GENERAL - removal of asbestos material/mold and hazardous materials from any place in a building, including mechanical systems where those mechanical systems are to be removed. This includes the removal of asbestos materials/mold and hazardous materials from ductwork or pipes in a building when the building is to be demolished at the time or at some close future date.

ASBESTOS - MECHANICAL - removal of asbestos material from mechanical systems, such as pipes, ducts, and boilers, where the mechanical systems are to remain.

CERAMIC TILE FINISHER, MARBLE FINISHER, TERRAZZO FINISHER

Assisting, helping or supporting the tile, marble and terrazzo mechanic by performing their historic and traditional work assignments required to complete the proper installation of the work covered by said crafts. The term "Ceramic" is used for naming the classification only and is in no way a limitation of the product handled. Ceramic takes into consideration most hard tiles.

ELECTRONIC SYSTEMS TECHNICIAN

Installation, service and maintenance of low-voltage systems which utilizes the transmission and/or transference of voice, sound, vision, or digital for commercial, education, security and entertainment purposes for the following: TV monitoring and surveillance, background/foreground music, intercom and telephone interconnect, field programming, inventory control systems, microwave transmission, multi-media, multiplex, radio page, school, intercom and sound burglar alarms and low voltage master clock systems.

Excluded from this classification are energy management systems, life safety systems, supervisory controls and data acquisition systems not intrinsic with the above listed systems, fire alarm systems, nurse call systems and raceways exceeding fifteen feet in length.

LABORER, SKILLED - BUILDING

The skilled laborer building (BLD) classification shall encompass the following types of work, irrespective of the site of the work: cutting & acetylene torch, gunnite nozzlemen, gunnite pump men & pots, kettlemen & carriers of men handling hot stuff, sandblaster nozzle men, sandblasting pump men & pots, setting up and using concrete burning bars, wood block setters, underpinning & shoring of existing buildings, and the unloading and handling of all material coated with creosote.

LABORER, SKILLED - HIGHWAY

The skilled laborer heavy & highway (HWY) classification shall encompass the following types of work, irrespective of the site of the work: jackhammer & drill operator, gunite pump & pot man, puddlers, vibrator men, wire fabric placer, sandblast pump & pot man, strike off concrete, unloading, handling & carrying of all creosoted piles, ties or timber, concrete burning bars, power wheelbarrows or buggies, asphalt raker, bricksetters, cutting torchman (electric & acetylene), men setting lines to level forms, form setters, gunite nozzle man & sandblasting nozzle man, power man, and rip-rapping by hand.

TRUCK DRIVER - BUILDING, HEAVY AND HIGHWAY CONSTRUCTION

Class 1. Drivers on 2 axle trucks hauling less than 9 ton. Air compressor and welding machines and brooms, including those pulled by separate units, truck driver helpers, warehouse employees, mechanic helpers, greasers and tiremen, pickup trucks when hauling materials, tools, or workers to and from and on-the-job site, and fork lifts up to 6,000 lb. capacity.

Class 2. Two or three axle trucks hauling more than 9 ton but hauling less than 16 ton. A-frame winch trucks, hydrolift trucks, vector trucks or similar equipment when used for transportation purposes. Fork lifts over 6,000 lb. capacity, winch trucks, four axle combination units, and ticket writers.

Class 3. Two, three or four axle trucks hauling 16 ton or more. Drivers on water pulls, articulated dump trucks, mechanics and working

forepersons, and dispatchers. Five axle or more combination units.

Class 4. Low Boy and Oil Distributors.

Class 5. Drivers who require special protective clothing while employed on hazardous waste work.

TRUCK DRIVER - OIL AND CHIP RESEALING ONLY.

This shall encompass laborers, workers and mechanics who drive contractor or subcontractor owned, leased, or hired pickup, dump, service, or oil distributor trucks. The work includes transporting materials and equipment (including but not limited to, oils, aggregate supplies, parts, machinery and tools) to or from the job site; distributing oil or liquid asphalt and aggregate; stock piling material when in connection with the actual oil and chip contract. The Truck Driver (Oil & Chip Resealing) wage classification does not include supplier delivered materials.

OPERATING ENGINEERS - BUILDING

Class 1. Cranes; Overhead Cranes; Gradall; All Cherry Pickers; Mechanics; Central Concrete Mixing Plant Operator; Road Pavers (27E - Dual Drum - Tri Batchers); Blacktop Plant Operators and Plant Engineers; 3 Drum Hoist; Derricks; Hydro Cranes; Shovels; Skimmer Scoops; Koehring Scooper; Drag Lines; Backhoe; Derrick Boats; Pile Drivers and Skid Rigs; Clamshells; Locomotive Cranes; Dredge (all types) Motor Patrol; Power Blades - Dumore - Elevating and similar types; Tower Cranes (Crawler-Mobile) and Stationary; Crane-type Backfiller; Drott Yumbo and similar types considered as Cranes; Caisson Rigs; Dozer; Tournadozer; Work Boats; Ross Carrier; Helicopter; Tournapulls - all and similar types; Scoops (all sizes); Pushcats; Endloaders (all types); Asphalt Surfacing Machine; Slip Form Paver; Rock Crusher; Heavy Equipment Greaser; CMI, CMI Belt Placer, Auto Grade & 3 Track and similar types; Side Booms; Multiple Unit Earth Movers; Creter Crane; Trench Machine; Pump-crete-Belt Crete-Squeeze Cretes-Screw-type Pumps and Gypsum; Bulker & Pump - Operator will clean; Formless Finishing Machine; Flaherty Spreader or similar types; Screed Man on Laydown Machine; Wheel Tractors (industrial or Farm-type w/Dozer-Hoe-Endloader or other attachments); F.W.D. & Similar Types; Vermeer Concrete Saw.

Class 2. Dinkeys; Power Launches; PH One-pass Soil Cement Machine (and similar types); Pugmill with Pump; Backfillers; Euclid Loader; Forklifts; Jeeps w/Ditching Machine or other attachments; Tuneluger; Automatic Cement and Gravel Batching Plants; Mobile Drills (Soil Testing) and similar types; Gurries and Similar Types; (1) and (2) Drum Hoists (Buck Hoist and Similar Types); Chicago Boom; Boring Machine & Pipe Jacking Machine; Hydro Boom; Dewatering System; Straw Blower; Hydro Seeder; Assistant Heavy Equipment Greaser on Spread; Tractors (Track type) without Power Unit pulling Rollers; Rollers on Asphalt -- Brick Macadem; Concrete Breakers; Concrete Spreaders; Mule Pulling Rollers; Center Stripper; Cement Finishing Machines & CMI Texture & Reel Curing Machines; Cement Finishing Machine; Barber Green or similar loaders; Vibro Tamper (All similar types) Self-propelled; Winch or Boom Truck; Mechanical Bull Floats; Mixers over 3 Bag to 27E; Tractor pulling Power Blade or Elevating Grader; Porter Rex Rail; Clary Screed; Truck Type Hoptoe Oilers; Fireman; Spray Machine on Paving; Curb Machines; Truck Crane Oilers; Oil Distributor; Truck-Mounted Saws.

Class 3. Air Compressor; Power Subgrader; Straight Tractor; Trac Air

without attachments; Herman Nelson Heater, Dravo, Warner, Silent Glo, and similar types; Roller: Five (5) Ton and under on Earth or Gravel; Form Grader; Crawler Crane & Skid Rig Oilers; Freight Elevators - permanently installed; Pump; Light Plant; Generator; Conveyor (1) or (2) - Operator will clean; Welding Machine; Mixer (3) Bag and Under (Standard Capacity with skip); Bulk Cement Plant; Oiler on Central Concrete Mixing Plant.

OPERATING ENGINEERS - HEAVY AND HIGHWAY CONSTRUCTION

Class 1. Cranes; Hydro Crane; Shovels; Crane Type Backfiller; Tower Cranes - Mobile & Crawler & Stationary; Derricks & Hoists (3 Drum); Draglines; Drott Yumbo & similar types considered as Cranes; Back Hoe; Derrick Boats; Pile Driver and Skid Rigs; Clam Shell; Locomotive - Cranes; Road Pavers - Single Drum - Dual Drum - Tri Batcher; Motor Patrols & Power Blades - Dumore - Elevating & Similar Types; Mechanics; Central Concrete Mixing Plant Operator; Asphalt Batch Plant Operators and Plant Engineers; Gradall; Caisson Rigs; Skimmer Scoop - Koering Scooper; Dredges (all types); Hoptoe; All Cherry Pickers; Work Boat; Ross Carrier; Helicopter; Dozer; Tournadozer; Tournapulls - all and similar types; Multiple Unit Earth Movers; Scoops (all sizes); Pushcats; Endloaders (all types); Asphalt Surfacing Machine; Slip Form Paver; Rock Crusher; Heavy Equipment Greaser (top greaser on spread); CMI, Auto Grade, CMI Belt Placer & 3 Track and similar types; Side Booms; Starting Engineer on Pipeline; Asphalt Heater & Planer Combination (used to plane streets); Wheel Tractors (with dozer, hoe or endloader attachments); F.W.D. and Similar types; Blaw Knox Spreader and Similar types; Trench Machines; Pump Crete - Belt Crete - Squeeze Crete - screw type pumps and gypsum (operator will clean); Formless Finishing Machines; Flaherty Spreader or similar types; Screed Man on Laydown Machine; Vermeer Concrete Saw.

Class 2. Bulker & Pump; Power Launches; Boring Machine & Pipe Jacking Machine; Dinkeys; P-H One Pass Soil Cement Machines and similar types; Wheel Tractors (Industry or farm type - other); Back Fillers; Euclid Loader; Fork Lifts; Jeep w/Ditching Machine or other attachments; Tunneluger; Automatic Cement & Gravel Batching Plants; Mobile Drills - Soil Testing and similar types; Pugmill with pump; All (1) and (2) Drum Hoists; Dewatering System; Straw Blower; Hydro-Seeder; Boring Machine; Hydro-Boom; Bump Grinders (self-propelled); Assistant Heavy Equipment Greaser; Apsco Spreader; Tractors (track-type) without Power Units Pulling Rollers on Asphalt - Brick or Macadam; Concrete Breakers; Concrete Spreaders; Cement Strippers; Cement Finishing Machines & CMI Texture & Reel Curing Machines; Vibro-Tampers (all similar types self-propelled); Mechanical Bull Floats; Self-propelled Concrete Saws; Mixers-over three (3) bags to 27E; Winch and Boom Trucks; Tractor Pulling Power Blade or Elevating Grader; Porter Rex Rail; Clary Screed; Mule Pulling Rollers; Pugmill without Pump; Barber Greene or similar Loaders; Track Type Tractor w/Power Unit attached (minimum); Fireman; Spray Machine on Paving; Curb Machines; Paved Ditch Machine; Power Broom; Self-Propelled Conveyors; Power Subgrader; Oil Distributor; Straight Tractor; Truck Crane Oiler; Truck Type Oilers; Directional boring machine; Horizontal directional drill.

Class 3. Straight framed articulating end dump vehicles and Truck mounted vac unit (separately powered); Trac Air Machine (without attachments); Herman Nelson Heater, Dravo Warner, Silent Glo & similar types; Rollers - five ton and under on earth and gravel; Form Graders; Pumps; Light Plant; Generator; Air Compressor (1) or (2); Conveyor; Welding Machine; Mixer - 3 bags and under; Bulk Cement Plant; Oilers.

Other Classifications of Work:

For definitions of classifications not otherwise set out, the Department generally has on file such definitions which are available. If a task to be performed is not subject to one of the classifications of pay set out, the Department will upon being contacted state which neighboring county has such a classification and provide such rate, such rate being deemed to exist by reference in this document. If no neighboring county rate applies to the task, the Department shall undertake a special determination, such special determination being then deemed to have existed under this determination. If a project requires these, or any classification not listed, please contact IDOL at 618/993-7271 for wage rates or clarifications.

LANDSCAPING

Landscaping work falls under the existing classifications for laborer, operating engineer and truck driver. The work performed by landscape plantsman and landscape laborer is covered by the existing classification of laborer. The work performed by landscape operators (regardless of equipment used or its size) is covered by the classifications of operating engineer. The work performed by landscape truck drivers (regardless of size of truck driven) is covered by the classifications of truck driver.

Tazewell County Prevailing Wage for May 2008

Trade Name	RG	TYP	C	Base	FRMAN	*M-F>8	OSA	OSH	H/W	Pensn	Vac	Trng
=====	==	===	=	=====	=====	=====	===	===	=====	=====	=====	=====
ASBESTOS ABT-GEN	NW	BLD		24.200	25.700	1.5	1.5	2.0	6.250	10.09	0.000	0.750
ASBESTOS ABT-GEN	NW	HWY		25.640	26.390	1.5	1.5	2.0	6.250	10.71	0.000	0.700
ASBESTOS ABT-GEN	SE	BLD		24.690	25.440	1.5	1.5	2.0	6.300	8.030	0.000	0.700
ASBESTOS ABT-MEC		BLD		25.480	27.230	1.5	1.5	2.0	8.760	6.410	0.000	0.310
BOILERMAKER		BLD		30.970	33.970	2.0	2.0	2.0	8.270	7.740	0.000	0.300
BRICK MASON		BLD		27.020	28.520	1.5	1.5	2.0	6.250	7.350	0.000	0.420
CARPENTER		BLD		26.540	28.540	1.5	1.5	2.0	6.750	8.150	0.000	0.320
CARPENTER		HWY		27.340	29.340	1.5	1.5	2.0	6.750	8.520	0.000	0.320
CEMENT MASON		BLD		24.220	25.970	1.5	1.5	2.0	5.490	10.44	0.000	0.500
CEMENT MASON		HWY		25.500	26.500	1.5	1.5	2.0	5.490	10.44	0.000	0.500
CERAMIC TILE FNSHER		BLD		24.910	0.000	1.5	1.5	2.0	6.250	7.350	0.000	0.420
ELECTRIC PWR EQMT OP		ALL		30.750	0.000	1.5	1.5	2.0	4.750	8.610	0.000	0.000
ELECTRIC PWR GRNDMAN		ALL		21.090	0.000	1.5	1.5	2.0	4.750	5.905	0.000	0.000
ELECTRIC PWR LINEMAN		ALL		34.160	36.350	1.5	1.5	2.0	4.750	9.560	0.000	0.000
ELECTRIC PWR TRK DRV		ALL		22.130	0.000	1.5	1.5	2.0	4.750	6.200	0.000	0.000
ELECTRICIAN		BLD		29.860	31.860	1.5	1.5	2.0	5.150	8.060	0.000	0.250
ELECTRONIC SYS TECH		BLD		24.830	26.330	1.5	1.5	2.0	5.150	6.145	0.000	0.250
ELEVATOR CONSTRUCTOR		BLD		35.615	40.070	2.0	2.0	2.0	8.775	6.960	2.140	0.000
GLAZIER		BLD		27.020	27.770	1.5	1.5	2.0	6.400	5.750	0.000	0.500
HT/FROST INSULATOR		BLD		36.400	38.150	1.5	1.5	2.0	8.760	10.11	0.000	0.310
IRON WORKER		BLD		26.310	28.060	1.5	1.5	2.0	8.140	7.810	0.000	0.400
IRON WORKER		HWY		28.570	30.070	1.5	1.5	2.0	8.140	7.810	0.000	0.350
LABORER	NW	BLD		23.200	24.700	1.5	1.5	2.0	6.250	10.09	0.000	0.700
LABORER	NW	HWY		24.890	25.640	1.5	1.5	2.0	6.250	10.71	0.000	0.700
LABORER	SE	BLD		24.690	25.440	1.5	1.5	2.0	6.300	8.030	0.000	0.700
LABORER	SE	HWY		26.300	27.300	1.5	1.5	2.0	6.300	8.030	0.000	0.700
LATHER		BLD		26.540	28.540	1.5	1.5	2.0	6.750	8.150	0.000	0.320
MACHINERY MOVER		HWY		28.570	30.070	1.5	1.5	2.0	8.140	7.810	0.000	0.350
MACHINIST		BLD		38.390	40.390	2.0	2.0	2.0	4.880	6.550	2.650	0.000
MARBLE FINISHERS		BLD		24.910	0.000	1.5	1.5	2.0	6.250	7.350	0.000	0.420
MARBLE MASON		BLD		26.520	27.770	1.5	1.5	2.0	6.250	7.350	0.000	0.420
MILLWRIGHT		BLD		27.180	29.180	1.5	1.5	2.0	6.750	7.850	0.000	0.320
MILLWRIGHT		HWY		28.410	30.410	1.5	1.5	2.0	6.750	7.950	0.000	0.320
OPERATING ENGINEER		BLD	1	29.420	32.420	1.5	1.5	2.0	6.450	10.00	0.000	1.100
OPERATING ENGINEER		BLD	2	27.360	32.420	1.5	1.5	2.0	6.450	10.00	0.000	1.100
OPERATING ENGINEER		BLD	3	25.850	32.420	1.5	1.5	2.0	6.450	10.00	0.000	1.100
OPERATING ENGINEER		HWY	1	30.300	33.300	1.5	1.5	2.0	6.450	10.00	0.000	1.100
OPERATING ENGINEER		HWY	2	27.790	33.300	1.5	1.5	2.0	6.450	10.00	0.000	1.100
OPERATING ENGINEER		HWY	3	23.640	33.300	1.5	1.5	2.0	6.450	10.00	0.000	1.100
PAINTER		ALL		29.850	31.850	1.5	1.5	1.5	6.750	6.750	0.000	0.500
PAINTER SIGNS		BLD		28.970	32.520	1.5	1.5	1.5	2.600	2.310	0.000	0.000
PILEDRIVER		BLD		27.040	29.040	1.5	1.5	2.0	6.750	8.150	0.000	0.320
PILEDRIVER		HWY		28.340	30.340	1.5	1.5	2.0	6.750	8.520	0.000	0.320
PIPEFITTER		BLD		32.830	36.440	1.5	1.5	2.0	6.450	8.240	0.000	0.610
PLASTERER		BLD		24.490	25.740	1.5	1.5	2.0	5.490	10.24	0.000	0.500
PLUMBER		BLD		29.630	32.300	1.5	1.5	2.0	6.450	9.550	0.000	0.900
ROOFER		BLD		25.250	26.250	1.5	1.5	2.0	5.550	6.700	0.000	0.150
SHEETMETAL WORKER		BLD		28.740	30.180	1.5	1.5	2.0	5.770	10.21	0.000	0.310
SIGN HANGER		HWY		28.570	30.070	1.5	1.5	2.0	8.140	7.810	0.000	0.350
SPRINKLER FITTER		BLD		35.140	37.690	1.5	1.5	2.0	7.000	6.200	0.000	0.250
STEEL ERECTOR		HWY		28.570	30.070	1.5	1.5	2.0	8.140	7.810	0.000	0.350
STONE MASON		BLD		27.020	28.520	1.5	1.5	2.0	6.250	7.350	0.000	0.420
TERRAZZO FINISHER		BLD		24.910	0.000	1.5	1.5	2.0	6.250	7.350	0.000	0.420
TERRAZZO MASON		BLD		26.520	27.770	1.5	1.5	2.0	6.250	7.350	0.000	0.420
TILE MASON		BLD		26.520	27.770	1.5	1.5	2.0	6.250	7.350	0.000	0.420
TRUCK DRIVER		ALL	1	27.457	0.000	1.5	1.5	2.0	8.600	3.797	0.000	0.000
TRUCK DRIVER		ALL	2	27.857	0.000	1.5	1.5	2.0	8.600	3.797	0.000	0.000
TRUCK DRIVER		ALL	3	28.057	0.000	1.5	1.5	2.0	8.600	3.797	0.000	0.000

TRUCK DRIVER	ALL	4	28.307	0.000	1.5	1.5	2.0	8.600	3.797	0.000	0.000
TRUCK DRIVER	ALL	5	29.057	0.000	1.5	1.5	2.0	8.600	3.797	0.000	0.000
TRUCK DRIVER	O&C	1	21.970	0.000	1.5	1.5	2.0	8.600	3.797	0.000	0.000
TRUCK DRIVER	O&C	2	22.290	0.000	1.5	1.5	2.0	8.600	3.797	0.000	0.000
TRUCK DRIVER	O&C	3	22.450	0.000	1.5	1.5	2.0	8.600	3.797	0.000	0.000
TRUCK DRIVER	O&C	4	22.650	0.000	1.5	1.5	2.0	8.600	3.797	0.000	0.000
TRUCK DRIVER	O&C	5	23.250	0.000	1.5	1.5	2.0	8.600	3.797	0.000	0.000
TUCKPOINTER	BLD		27.020	28.520	1.5	1.5	2.0	6.250	7.350	0.000	0.420

Legend:

M-F>8 (Overtime is required for any hour greater than 8 worked each day, Monday through Friday.)

OSA (Overtime is required for every hour worked on Saturday)

OSH (Overtime is required for every hour worked on Sunday and Holidays)

H/W (Health & Welfare Insurance)

Pensn (Pension)

Vac (Vacation)

Trng (Training)

Explanations

TAZEWELL COUNTY

ASBESTOS - See Laborers

CARPENTERS (NORTH) - That part of the county North including the towns of Marquette Hts., Morton, Creve Coeur and Deer Creek.

LABORERS (NORTHWEST) - The area bounded by the old city limits of East Peoria.

MILLWRIGHTS - See Carpenters

PILEDRIVERS - See Carpenters

The following list is considered as those days for which holiday rates of wages for work performed apply: New Years Day, Memorial/Decoration Day, Fourth of July, Labor Day, Veterans Day, Thanksgiving Day, Christmas Day. Generally, any of these holidays which fall on a Sunday is celebrated on the following Monday. This then makes work performed on that Monday payable at the appropriate overtime rate for holiday pay. Common practice in a given local may alter certain days of celebration such as the day after Thanksgiving for Veterans Day. If in doubt, please check with IDOL.

Oil and chip resealing (O&C) means the application of road oils and liquid asphalt to coat an existing road surface, followed by application of aggregate chips or gravel to coated surface, and subsequent rolling of material to seal the surface.

EXPLANATION OF CLASSES

ASBESTOS - GENERAL - removal of asbestos material/mold and hazardous materials from any place in a building, including mechanical systems

where those mechanical systems are to be removed. This includes the removal of asbestos materials/mold and hazardous materials from ductwork or pipes in a building when the building is to be demolished at the time or at some close future date.

ASBESTOS - MECHANICAL - Removal of asbestos material from mechanical systems, such as pipes, ducts, and boilers, where the mechanical systems are to remain.

CERAMIC TILE FINISHER, MARBLE FINISHER, TERRAZZO FINISHER

Assisting, helping or supporting the tile, marble and terrazzo mechanic by performing their historic and traditional work assignments required to complete the proper installation of the work covered by said crafts. The term "Ceramic" is used for naming the classification only and is in no way a limitation of the product handled. Ceramic takes into consideration most hard tiles.

ELECTRONIC SYSTEMS TECHNICIAN

Installation, service and maintenance of low-voltage systems which utilizes the transmission and/or transference of voice, sound, vision, or digital for commercial, education, security and entertainment purposes for the following: TV monitoring and surveillance, background/foreground music, intercom and telephone interconnect, field programming, inventory control systems, microwave transmission, multi-media, multiplex, radio page, school, intercom and sound burglar alarms and low voltage master clock systems.

Excluded from this classification are energy management systems, life safety systems, supervisory controls and data acquisition systems not intrinsic with the above listed systems, fire alarm systems, nurse call systems and raceways exceeding fifteen feet in length.

TRUCK DRIVER - BUILDING, HEAVY AND HIGHWAY CONSTRUCTION

Class 1. Drivers on 2 axle trucks hauling less than 9 ton. Air compressor and welding machines and brooms, including those pulled by separate units, truck driver helpers, warehouse employees, mechanic helpers, greasers and tiremen, pickup trucks when hauling materials, tools, or workers to and from and on-the-job site, and fork lifts up to 6,000 lb. capacity.

Class 2. Two or three axle trucks hauling more than 9 ton but hauling less than 16 ton. A-frame winch trucks, hydrolift trucks, vector trucks or similar equipment when used for transportation purposes. Fork lifts over 6,000 lb. capacity, winch trucks, four axle combination units, and ticket writers.

Class 3. Two, three or four axle trucks hauling 16 ton or more. Drivers on water pulls, articulated dump trucks, mechanics and working forepersons, and dispatchers. Five axle or more combination units.

Class 4. Low Boy and Oil Distributors.

Class 5. Drivers who require special protective clothing while employed on hazardous waste work.

TRUCK DRIVER - OIL AND CHIP RESEALING ONLY.

This shall encompass laborers, workers and mechanics who drive contractor or subcontractor owned, leased, or hired pickup, dump, service, or oil distributor trucks. The work includes transporting

materials and equipment (including but not limited to, oils, aggregate supplies, parts, machinery and tools) to or from the job site; distributing oil or liquid asphalt and aggregate; stock piling material when in connection with the actual oil and chip contract. The Truck Driver (Oil & Chip Resealing) wage classification does not include supplier delivered materials.

OPERATING ENGINEERS - BUILDING

Class 1. Cranes; Overhead Cranes; Gradall; All Cherry Pickers; Mechanics; Central Concrete Mixing Plant Operator; Road Pavers (27E - Dual Drum - Tri Batchers); Blacktop Plant Operators and Plant Engineers; 3 Drum Hoist; Derricks; Hydro Cranes; Shovels; Skimmer Scoops; Koehring Scooper; Drag Lines; Backhoe; Derrick Boats; Pile Drivers and Skid Rigs; Clamshells; Locomotive Cranes; Dredge (all types) Motor Patrol; Power Blades - Dumore - Elevating and similar types; Tower Cranes (Crawler-Mobile) and Stationary; Crane-type Backfiller; Drott Yumbo and similar types considered as Cranes; Caisson Rigs; Dozer; Tournadozer; Work Boats; Ross Carrier; Helicopter; Tournapulls - all and similar types; Scoops (all sizes); Pushcats; Endloaders (all types); Asphalt Surfacing Machine; Slip Form Paver; Rock Crusher; Heavy Equipment Greaser; CMI, CMI Belt Placer, Auto Grade & 3 Track and similar types; Side Booms; Multiple Unit Earth Movers; Creter Crane; Trench Machine; Pump-crete-Belt Crete-Squeeze Cretes-Screw-type Pumps and Gypsum; Bulker & Pump - Operator will clean; Formless Finishing Machine; Flaherty Spreader or similar types; Screed Man on Laydown Machine; Wheel Tractors (industrial or Farm-type w/Dozer-Hoe-Endloader or other attachments); F.W.D. & Similar Types; Vermeer Concrete Saw.

Class 2. Dinkeys; Power Launches; PH One-pass Soil Cement Machine (and similar types); Pugmill with Pump; Backfillers; Euclid Loader; Forklifts; Jeeps w/Ditching Machine or other attachments; Tuneluger; Automatic Cement and Gravel Batching Plants; Mobile Drills (Soil Testing) and similar types; Gurries and Similar Types; (1) and (2) Drum Hoists (Buck Hoist and Similar Types); Chicago Boom; Boring Machine & Pipe Jacking Machine; Hydro Boom; Dewatering System; Straw Blower; Hydro Seeder; Assistant Heavy Equipment Greaser on Spread; Tractors (Track type) without Power Unit pulling Rollers; Rollers on Asphalt -- Brick Macadem; Concrete Breakers; Concrete Spreaders; Mule Pulling Rollers; Center Stripper; Cement Finishing Machines & CMI Texture & Reel Curing Machines; Cement Finishing Machine; Barber Green or similar loaders; Vibro Tamper (All similar types) Self-propelled; Winch or Boom Truck; Mechanical Bull Floats; Mixers over 3 Bag to 27E; Tractor pulling Power Blade or Elevating Grader; Porter Rex Rail; Clary Screed; Truck Type Hoptoe Oilers; Fireman; Spray Machine on Paving; Curb Machines; Truck Crane Oilers; Oil Distributor; Truck-Mounted Saws.

Class 3. Air Compressor; Power Subgrader; Straight Tractor; Trac Air without attachments; Herman Nelson Heater, Dravo, Warner, Silent Glo, and similar types; Roller: Five (5) Ton and under on Earth or Gravel; Form Grader; Crawler Crane & Skid Rig Oilers; Freight Elevators - permanently installed; Pump; Light Plant; Generator; Conveyor (1) or (2) - Operator will clean; Welding Machine; Mixer (3) Bag and Under (Standard Capacity with skip); Bulk Cement Plant; Oiler on Central Concrete Mixing Plant.

OPERATING ENGINEERS - HEAVY AND HIGHWAY CONSTRUCTION

Class 1. Cranes; Hydro Crane; Shovels; Crane Type Backfiller; Tower Cranes - Mobile & Crawler & Stationary; Derricks & Hoists (3 Drum); Draglines; Drott Yumbo & similar types considered as Cranes; Back

Hoe; Derrick Boats; Pile Driver and Skid Rigs; Clam Shell; Locomotive - Cranes; Road Pavers - Single Drum - Dual Drum - Tri Batcher; Motor Patrols & Power Blades - Dumore - Elevating & Similar Types; Mechanics; Central Concrete Mixing Plant Operator; Asphalt Batch Plant Operators and Plant Engineers; Gradall; Caisson Rigs; Skimmer Scoop - Koering Scooper; Dredges (all types); Hoptoe; All Cherry Pickers; Work Boat; Ross Carrier; Helicopter; Dozer; Tournadozer; Tournapulls - all and similar types; Multiple Unit Earth Movers; Scoops (all sizes); Pushcats; Endloaders (all types); Asphalt Surfacing Machine; Slip Form Paver; Rock Crusher; Heavy Equipment Greaser (top greaser on spread); CMI, Auto Grade, CMI Belt Placer & 3 Track and similar types; Side Booms; Starting Engineer on Pipeline; Asphalt Heater & Planer Combination (used to plane streets); Wheel Tractors (with dozer, hoe or endloader attachments); F.W.D. and Similar types; Blaw Knox Spreader and Similar types; Trench Machines; Pump Crete - Belt Crete - Squeeze Crete - screw type pumps and gypsum (operator will clean); Formless Finishing Machines; Flaherty Spreader or similar types; Screed Man on Laydown Machine; Vermeer Concrete Saw.

Class 2. Bulker & Pump; Power Launches; Boring Machine & Pipe Jacking Machine; Dinkeys; P-H One Pass Soil Cement Machines and similar types; Wheel Tractors (Industry or farm type - other); Back Fillers; Euclid Loader; Fork Lifts; Jeep w/Ditching Machine or other attachments; Tunneluger; Automatic Cement & Gravel Batching Plants; Mobile Drills - Soil Testing and similar types; Pugmill with pump; All (1) and (2) Drum Hoists; Dewatering System; Straw Blower; Hydro-Seeder; Boring Machine; Hydro-Boom; Bump Grinders (self-propelled); Assistant Heavy Equipment Greaser; Apsco Spreader; Tractors (track-type) without Power Units Pulling Rollers on Asphalt - Brick or Macadam; Concrete Breakers; Concrete Spreaders; Cement Strippers; Cement Finishing Machines & CMI Texture & Reel Curing Machines; Vibro-Tampers (all similar types self-propelled); Mechanical Bull Floats; Self-propelled Concrete Saws; Mixers-over three (3) bags to 27E; Winch and Boom Trucks; Tractor Pulling Power Blade or Elevating Grader; Porter Rex Rail; Clary Screed; Mule Pulling Rollers; Pugmill without Pump; Barber Greene or similar Loaders; Track Type Tractor w/Power Unit attached (minimum); Fireman; Spray Machine on Paving; Curb Machines; Paved Ditch Machine; Power Broom; Self-Propelled Conveyors; Power Subgrader; Oil Distributor; Straight Tractor; Truck Crane Oiler; Truck Type Oilers; Directional boring machine; Horizontal directional drill.

Class 3. Straight framed articulating end dump vehicles and Truck mounted vac unit (separately powered); Trac Air Machine (without attachments); Herman Nelson Heater, Dravo Warner, Silent Glo & similar types; Rollers - five ton and under on earth and gravel; Form Graders; Pumps; Light Plant; Generator; Air Compressor (1) or (2); Conveyor; Welding Machine; Mixer - 3 bags and under; Bulk Cement Plant; Oilers.

Other Classifications of Work:

For definitions of classifications not otherwise set out, the Department generally has on file such definitions which are available. If a task to be performed is not subject to one of the classifications of pay set out, the Department will upon being contacted state which neighboring county has such a classification and provide such rate, such rate being deemed to exist by reference in this document. If no neighboring county rate applies to the task, the Department shall undertake a special determination, such special determination being then deemed to have existed under this determination. If a project requires these, or any classification not listed, please contact IDOL at 618/993-7271 for wage rates or

clarifications.

LANDSCAPING

Landscaping work falls under the existing classifications for laborer, operating engineer and truck driver. The work performed by landscape plantsman and landscape laborer is covered by the existing classification of laborer. The work performed by landscape operators (regardless of equipment used or its size) is covered by the classifications of operating engineer. The work performed by landscape truck drivers (regardless of size of truck driven) is covered by the classifications of truck driver.