

The diameter of this part is the same as the diameter of the bar spliced.

The diameter of this part is equal or larger than the diameter of bar spliced.

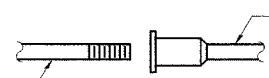

ROLLED THREAD DOWEL BAR



**** ONE PIECE**

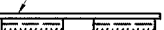
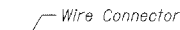

WELDED SECTIONS

BAR SPLICER ASSEMBLY ALTERNATIVES

** Heavy Hex Nuts conforming to ASTM A 563, Grade C, D or DH may be used.

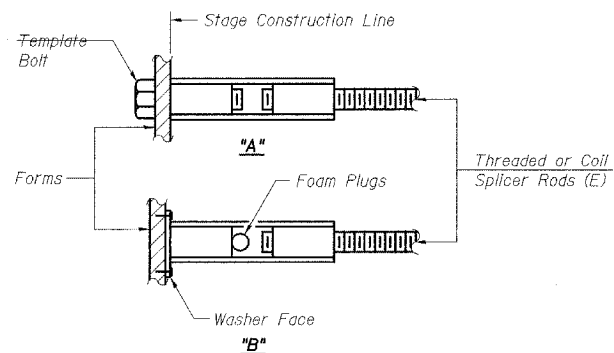

INSTALLATION AND SETTING METHODS

"A" : Set bar splicer assembly by means of a template bolt.
 "B" : Set bar splicer assembly by nailing to wood forms or cementing to steel forms.
 (E) : Indicates epoxy coating.

NOTES

Bar splicer assemblies shall be of an approved type and shall develop in tension at least 125 percent of the yield strength of the lapped reinforcement bars.

Splicer rods shall be of minimum 60 ksi yield strength, threaded or coiled full length.

All reinforcement bars shall be lapped and tied to the splicer rods or dowel bars.

Bar splicer assemblies shall be epoxy coated according to the requirements for reinforcement bars.

Other systems of similar design may be submitted to the Engineer for approval. Approval shall be based on certified test results from an approved testing laboratory that the proposed bar splicer assembly satisfies the following requirements:

Other systems of similar design may be submitted to the Engineer for approval. Approval shall be based on certified test results from an approved testing laboratory that the proposed bar splicer assembly satisfies the following requirements:

- ① Minimum Capacity = $1.25 \times f_y \times A_t$
(Tension in kips)
- ② Minimum *Pull-out Strength = $0.66 \times f_y \times A_t$
(Tension in kips)

Where f_y = Yield strength of lapped reinforcement bars in ksi.

A_t = Tensile stress area of lapped reinforcement bars.

* = 28 day concrete

Bar Size to be Spliced	Splicer Rod or Dowel Bar Length	Strength Requirements	
		Min. Capacity kips - tension	Min. Pull-Out Strength kips - tension
#4	1'-8"	14.7	7.9
#5	2'-0"	23.0	12.3
#6	2'-7"	33.1	17.4
#7	3'-5"	45.1	23.8
#8	4'-6"	58.9	31.3
#9	5'-9"	75.0	39.6
#10	7'-3"	95.0	50.3
#11	9'-0"	117.4	61.8

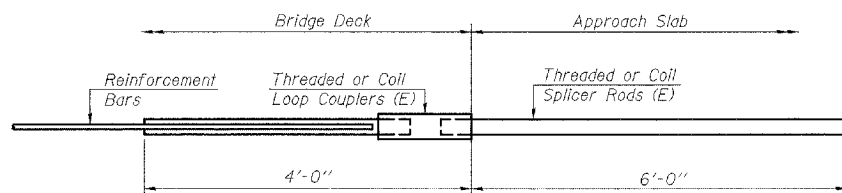

FOR INTEGRAL OR SEMI-INTEGRAL ABUTMENTS

Bar Splicer for #5 bar		
Min. Capacity =	23.0 kips - tension	
Min. Pull-out Strength =	12.3 kips - tension	
No. Required =		

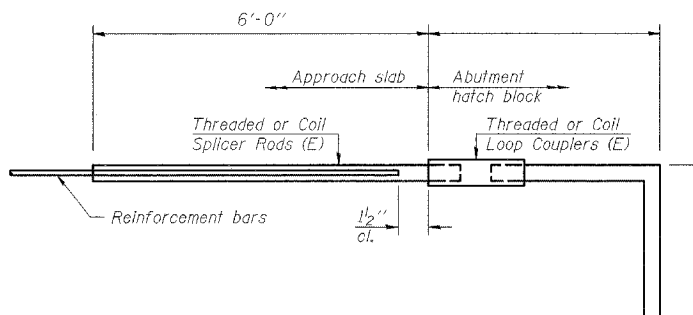

FOR STUB ABUTMENTS

Bar Splicer for #5 bar		
Min. Capacity =	23.0 kips - tension	
Min. Pull-out Strength =	12.3 kips - tension	
No. Required =		

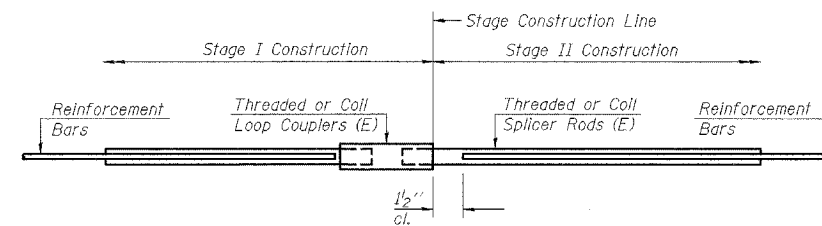

STANDARD

Bar Size	No. Assemblies Required	Location
#5	24	058-0093
#6	4	058-0093
#5	24	058-0094
#6	4	058-0094
#5	96	058-0095
#6	4	058-0095
#5	96	058-0096
#6	4	058-0096
#5	16	058-0097
#6	4	058-0097

BSD-1

11-1-06

BAR SPLICER ASSEMBLY DETAILS

FILE NAME = c:\projects\74171d\karenbridge.dgn	USER NAME = swartzrk	DESIGNED -	REVISED -
		DRAWN -	REVISED -
	PLOT SCALE = 20,0000 ' / IN.	CHECKED -	REVISED -
	PLOT DATE = 3/20/2008	DATE -	REVISED -

**STATE OF ILLINOIS
DEPARTMENT OF TRANSPORTATION**

BAR SPLICER ASSEMBLY DETAILS

SCALE: SHEET NO. 52 OF 52 SHEETS STA. TO STA.

F.A.I. RTE.	SECTION	COUNTY	TOTAL SHEETS	SH N
72	(58,74X66,67)RS-1	MACON	88	7
CONTRACT NO. 741			ILLINOIS FED. AID PROJECT	

SHEET NO. 52 SHEETS