

If you plan to submit a bid directly to the Department of Transportation

PREQUALIFICATION

Any contractor who desires to become pre-qualified to bid on work advertised by IDOT must submit the properly completed pre-qualification forms to the Bureau of Construction no later than 4:30 p.m. prevailing time twenty-one days prior to the letting of interest. This pre-qualification requirement applies to first time contractors, contractors renewing expired ratings, contractors maintaining continuous pre-qualification or contractors requesting revised ratings. To be eligible to bid, existing pre-qualification ratings must be effective through the date of letting.

REQUESTS FOR AUTHORIZATION TO BID

Contractors downloading and/or ordering CD-ROM's and are wanting to bid on items included in a particular letting must submit the properly completed "Request for Authorization to Bid/or Not For Bid Status" (BDE 124INT) and the ORIGINAL, signed and notarized, "Affidavit of Availability" (BC 57) to the proper office no later than 4:30 p.m. prevailing time, three (3) days prior to the letting date.

WHO CAN BID ?

Bids will be accepted from only those companies that request and receive written **Authorization to Bid** from IDOT's Central Bureau of Construction.

WHAT CONSTITUTES WRITTEN AUTHORIZATION TO BID? When a prospective prime bidder submits a "Request for Authorization to Bid/or Not For Bid Status"(BDE 124INT) he/she must indicate at that time which items are being requested For Bidding purposes. Only those items requested For Bidding will be analyzed. After the request has been analyzed, the bidder will be issued a **Proposal Denial and/or Authorization Form**, approved by the Central Bureau of Construction, that indicates which items have been approved For Bidding. If **Authorization to Bid** cannot be approved, the **Proposal Denial and/or Authorization Form** will indicate the reason for denial.

ABOUT AUTHORIZATION TO BID: Firms that have not received an authorization form within a reasonable time of complete and correct original document submittal should contact the department as to status. This is critical in the week before the letting. These documents must be received three days before the letting date. Firms unsure as to authorization status should call the Prequalification Section of the Bureau of Construction at the number listed at the end of these instructions.

ADDENDA AND REVISIONS: It is the contractor's responsibility to determine which, if any, addenda or revisions pertain to any project they may be bidding. Failure to incorporate all relevant addenda or revisions may cause the bid to be declared unacceptable.

Each addendum will be placed with the contract number. Addenda and revisions will also be placed on the Addendum/Revision Checklist and each subscription service subscriber will be notified by e-mail of each addendum and revision issued.

The Internet is the Department's primary way of doing business. The subscription server e-mails are an added courtesy the Department provides. It is suggested that bidder check IDOT's website <http://www.dot.il.gov/desenv/delett.html> before submitting final bid information.

IDOT is not responsible for any e-mail related failures.

Addenda Questions may be directed to the Contracts Office at (217)782-7806 or D&Econtracts@dot.il.gov

Technical Questions about downloading these files may be directed to Tim Garman (217)524-1642 or Timothy.Garman@illinois.gov.

WHAT MUST BE INCLUDED WHEN BIDS ARE SUBMITTED?: Bidders need not return the entire proposal when bids are submitted. That portion of the proposal that must be returned includes the following:

1. All documents from the Proposal Cover Sheet through the Proposal Bid Bond
2. Other special documentation and/or information that may be required by the contract special provisions

All proposal documents, including Proposal Guaranty Checks or Proposal Bid Bonds, should be stapled together to prevent loss when bids are processed by IDOT personnel.

ABOUT SUBMITTING BIDS: It is recommended that bidders deliver bids in person to insure they arrive at the proper location prior to the time specified for the receipt of bids. Any bid received at the place of letting after the time specified will not be accepted.

WHO SHOULD BE CALLED IF ASSISTANCE IS NEEDED?

Questions Regarding	Call
Prequalification and/or Authorization to Bid	(217)782-3413
Preparation and submittal of bids	(217)782-7806
Mailing of plans and proposals	(217)782-7806
Electronic plans and proposals	(217)524-1642

ADDENDUMS AND REVISIONS TO THE PROPOSAL FORMS

Planholders should verify that they have received and incorporated the addendum and/or revision prior to submitting their bid. Failure by the bidder to include an addendum could result in a bid being rejected as irregular.

161

RETURN WITH BID

Proposal Submitted By
Name
Address
City

Letting June 13, 2008

BIDDERS NEED NOT RETURN THE ENTIRE PROPOSAL
(See instructions inside front cover)

NOTICE TO PROSPECTIVE BIDDERS

This proposal can be used for bidding purposes by only those companies that request and receive written AUTHORIZATION TO BID from IDOT's Central Bureau of Construction.
(SEE INSTRUCTIONS ON THE INSIDE OF COVER)

Notice To Bidders, Specifications, Proposal, Contract and Contract Bond



**Illinois Department
of Transportation**

Springfield, Illinois 62764

**Contract No. 76A57
MADISON-RANDOLPH-BOND Counties
Section DIST 8 SEAL COAT 2008-1
District 8 Construction Funds
Various Routes**

PLEASE MARK THE APPROPRIATE BOX BELOW:

- A Bid Bond is included.
- A Cashier's Check or a Certified Check is included.

Plans Included
Herein

Prepared by

S

Checked by

(Printed by authority of the State of Illinois)

INSTRUCTIONS

ABOUT IDOT PROPOSALS: All proposals issued by IDOT are potential bidding proposals. Each proposal contains all Certifications and Affidavits, a Proposal Signature Sheet and a Proposal Bid Bond required for Prime Contractors to submit a bid after written **Authorization to Bid** has been issued by IDOT's Central Bureau of Construction.

WHO CAN BID?: Bids will be accepted from only those companies that request and receive written **Authorization to Bid** from IDOT's Central Bureau of Construction. To request authorization, a potential bidder must complete and submit Part B of the Request for Authorization to Bid/or Not For Bid Status form (BDE 124 INT) and submit an original Affidavit of Availability (BC 57).

WHAT CONSTITUTES WRITTEN AUTHORIZATION TO BID?: When a prospective prime bidder submits a "Request for Proposal Forms and Plans" he/she must indicate at that time which items are being requested For Bidding purposes. Only those items requested For Bidding will be analyzed. After the request has been analyzed, the bidder will be issued a **Proposal Denial and/or Authorization Form**, approved by the Central Bureau of Construction, that indicates which items have been approved For Bidding. If **Authorization to Bid** cannot be approved, the **Proposal Denial and/or Authorization Form** will indicate the reason for denial. If a contractor has requested to bid but has not received a **Proposal Denial and/or Authorization Form**, they should contact the Central Bureau of Construction in advance of the letting date.

WHAT MUST BE INCLUDED WHEN BIDS ARE SUBMITTED?: Bidders need not return the entire proposal when bids are submitted. That portion of the proposal that must be returned includes the following:

1. All documents from the Proposal Cover Sheet through the Proposal Bid Bond
2. Other special documentation and/or information that may be required by the contract special provisions

All proposal documents, including Proposal Guaranty Checks or Proposal Bid Bonds, should be stapled together to prevent loss when bids are processed by IDOT personnel.

ABOUT SUBMITTING BIDS: It is recommended that bidders deliver bids in person to insure they arrive at the proper location prior to the time specified for the receipt of bids. Any bid received at the place of letting after the time specified will not be accepted.

WHO SHOULD BE CALLED IF ASSISTANCE IS NEEDED?

Questions Regarding	Call
Prequalification and/or Authorization to Bid	217/782-3413
Preparation and submittal of bids	217/782-7806
Mailing of CD-ROMS	217/782-7806

RETURN WITH BID



PROPOSAL

TO THE DEPARTMENT OF TRANSPORTATION

1. Proposal of _____

Taxpayer Identification Number (Mandatory) _____ a

for the improvement identified and advertised for bids in the Invitation for Bids as:

**Contract No. 76A57
MADISON-RANDOLPH-BOND Counties
Section DIST 8 SEAL COAT 2008-1
Various Routes
District 8 Construction Funds**

10.79 miles of seal coat at 13 locations in Madison, Randolph and Bond counties.

2. The undersigned bidder will furnish all labor, material and equipment to complete the above described project in a good and workmanlike manner as provided in the contract documents provided by the Department of Transportation. This proposal will become part of the contract and the terms and conditions contained in the contract documents shall govern performance and payments.

RETURN WITH BID

6. **COMBINATION BIDS.** The undersigned further agrees that if awarded the contract for the sections contained in the following combination, he/she will perform the work in accordance with the requirements of each individual proposal comprising the combination bid specified in the schedule below, and that the combination bid shall be prorated against each section in proportion to the bid submitted for the same. If an error is found to exist in the gross sum bid for one or more of the individual sections included in a combination, the combination bid shall be corrected as provided in the specifications.

When a combination bid is submitted, the schedule below must be completed in each proposal comprising the combination.

If alternate bids are submitted for one or more of the sections comprising the combination, a combination bid must be submitted for each alternate.

Schedule of Combination Bids

Combination No.	Sections Included in Combination	Combination Bid	
		Dollars	Cents

7. **SCHEDULE OF PRICES.** The undersigned bidder submits herewith, in accordance with the rules and instructions, a schedule of prices for the items of work for which bids are sought. The unit prices bid are in U.S. dollars and cents, and all extensions and summations have been made. The bidder understands that the quantities appearing in the bid schedule are approximate and are provided for the purpose of obtaining a gross sum for the comparison of bids. If there is an error in the extension of the unit prices, the unit prices shall govern. Payment to the contractor awarded the contract will be made only for actual quantities of work performed and accepted or materials furnished according to the contract. The scheduled quantities of work to be done and materials to be furnished may be increased, decreased or omitted as provided elsewhere in the contract.

8. **CERTIFICATE OF AUTHORITY.** The undersigned bidder, if a business organized under the laws of another State, assures the Department that it will furnish a copy of its certificate of authority to do business in the State of Illinois with the return of the executed contract and bond. Failure to furnish the certificate within the time provided for execution of an awarded contract may be cause for cancellation of the award and forfeiture of the proposal guaranty to the State.

CONTRACT NUMBER

76A57

THIS IS THE TOTAL BID

\$ _____

NOTES:

- 1. Each PAY ITEM should have a UNIT PRICE and a TOTAL PRICE.**
- 2. The UNIT PRICE shall govern if no TOTAL PRICE is shown or if there is a discrepancy between the product of the UNIT PRICE multiplied by the QUANTITY.**
- 3. If a UNIT PRICE is omitted, the TOTAL PRICE will be divided by the QUANTITY in order to establish a UNIT PRICE.**
- 4. A bid may be declared UNACCEPTABLE if neither a unit price nor a total price is shown.**

RETURN WITH BID

STATE REQUIRED ETHICAL STANDARDS GOVERNING CONTRACT PROCUREMENT: ASSURANCES, CERTIFICATIONS AND DISCLOSURES

I. GENERAL

A. Article 50 of the Illinois Procurement Code establishes the duty of all State chief procurement officers, State purchasing officers, and their designees to maximize the value of the expenditure of public moneys in procuring goods, services, and contracts for the State of Illinois and to act in a manner that maintains the integrity and public trust of State government. In discharging this duty, they are charged by law to use all available information, reasonable efforts, and reasonable actions to protect, safeguard, and maintain the procurement process of the State of Illinois.

B. In order to comply with the provisions of Article 50 and to carry out the duty established therein, all bidders are to adhere to ethical standards established for the procurement process, and to make such assurances, disclosures and certifications required by law. By execution of the Proposal Signature Sheet, the bidder indicates that each of the mandated assurances has been read and understood, that each certification is made and understood, and that each disclosure requirement has been understood and completed.

C. In addition to all other remedies provided by law, failure to comply with any assurance, failure to make any disclosure or the making of a false certification shall be grounds for termination of the contract and the suspension or debarment of the bidder.

II. ASSURANCES

A. The assurances hereinafter made by the bidder are each a material representation of fact upon which reliance is placed should the Department enter into the contract with the bidder. The Department may terminate the contract if it is later determined that the bidder rendered a false or erroneous assurance, and the surety providing the performance bond shall be responsible for the completion of the contract.

B. Felons

1. The Illinois Procurement Code provides:

Section 50-10. Felons. Unless otherwise provided, no person or business convicted of a felony shall do business with the State of Illinois or any state agency from the date of conviction until 5 years after the date of completion of the sentence for that felony, unless no person held responsible by a prosecutorial office for the facts upon which the conviction was based continues to have any involvement with the business.

2. The bidder assures the Department that the award and execution of the contract would not cause a violation of Section 50-10.

C. Conflicts of Interest

1. The Illinois Procurement Code provides in pertinent part:

Section 50-13. Conflicts of Interest.

(a) Prohibition. It is unlawful for any person holding an elective office in this State, holding a seat in the General Assembly, or appointed to or employed in any of the offices or agencies of state government and who receives compensation for such employment in excess of 60% of the salary of the Governor of the State of Illinois, or who is an officer or employee of the Capital Development Board or the Illinois Toll Highway Authority, or who is the spouse or minor child of any such person to have or acquire any contract, or any direct pecuniary interest in any contract therein, whether for stationery, printing, paper, or any services, materials, or supplies, that will be wholly or partially satisfied by the payment of funds appropriated by the General Assembly of the State of Illinois or in any contract of the Capital Development Board or the Illinois Toll Highway authority.

(b) Interests. It is unlawful for any firm, partnership, association or corporation, in which any person listed in subsection (a) is entitled to receive (i) more than 7 1/2% of the total distributable income or (ii) an amount in excess of the salary of the Governor, to have or acquire any such contract or direct pecuniary interest therein.

(c) Combined interests. It is unlawful for any firm, partnership, association, or corporation, in which any person listed in subsection (a) together with his or her spouse or minor children is entitled to receive (i) more than 15%, in the aggregate, of the total distributable income or (ii) an amount in excess of 2 times the salary of the Governor, to have or acquire any such contract or direct pecuniary interest therein.

(d) Securities. Nothing in this Section invalidates the provisions of any bond or other security previously offered or to be offered for sale or sold by or for the State of Illinois.

(e) Prior interests. This Section does not affect the validity of any contract made between the State and an officer or employee of the State or member of the General Assembly, his or her spouse, minor child or any combination of those persons if that contract was in existence before his or her election or employment as an officer, member, or employee. The contract is voidable, however, if it cannot be completed within 365 days after the officer, member, or employee takes office or is employed.

The current salary of the Governor is \$171,000.00. Sixty percent of the salary is \$102,600.00.

RETURN WITH BID

2. The bidder assures the Department that the award and execution of the contract would not cause a violation of Section 50-13, or that an effective exemption has been issued by the Board of Ethics to any individual subject to the Section 50-13 prohibitions pursuant to the provisions of Section 50-20 of the Code and Executive Order Number 3 (1998). Information concerning the exemption process is available from the Department upon request.

D. Negotiations

1. The Illinois Procurement Code provides in pertinent part:

Section 50-15. Negotiations.

(a) It is unlawful for any person employed in or on a continual contractual relationship with any of the offices or agencies of State government to participate in contract negotiations on behalf of that office or agency with any firm, partnership, association, or corporation with whom that person has a contract for future employment or is negotiating concerning possible future employment.

2. The bidder assures the Department that the award and execution of the contract would not cause a violation of Section 50-15, and that the bidder has no knowledge of any facts relevant to the kinds of acts prohibited therein.

E. Inducements

1. The Illinois Procurement Code provides:

Section 50-25. Inducement. Any person who offers or pays any money or other valuable thing to any person to induce him or her not to bid for a State contract or as recompense for not having bid on a State contract is guilty of a Class 4 felony. Any person who accepts any money or other valuable thing for not bidding for a State contract or who withholds a bid in consideration of the promise for the payment of money or other valuable thing is guilty of a Class 4 felony.

2. The bidder assures the Department that the award and execution of the contract would not cause a violation of Section 50-25, and that the bidder has no knowledge of any facts relevant to the kinds of acts prohibited therein.

F. Revolving Door Prohibition

1. The Illinois Procurement Code provides:

Section 50-30. Revolving door prohibition. Chief procurement officers, associate procurement officers, State purchasing officers, their designees whose principal duties are directly related to State procurement, and executive officers confirmed by the Senate are expressly prohibited for a period of 2 years after terminating an affected position from engaging in any procurement activity relating to the State agency most recently employing them in an affected position for a period of at least 6 months. The prohibition includes, but is not limited to: lobbying the procurement process; specifying; bidding; proposing bid, proposal, or contract documents; on their own behalf or on behalf of any firm, partnership, association, or corporation. This Section applies only to persons who terminate an affected position on or after January 15, 1999.

2. The bidder assures the Department that the award and execution of the contract would not cause a violation of Section 50-30, and that the bidder has no knowledge of any facts relevant to the kinds of acts prohibited therein.

G. Reporting Anticompetitive Practices

1. The Illinois Procurement Code provides:

Section 50-40. Reporting anticompetitive practices. When, for any reason, any vendor, bidder, contractor, chief procurement officer, State purchasing officer, designee, elected official, or State employee suspects collusion or other anticompetitive practice among any bidders, offerors, contractors, proposers, or employees of the State, a notice of the relevant facts shall be transmitted to the Attorney General and the chief procurement officer.

2. The bidder assures the Department that it has not failed to report any relevant facts concerning the practices addressed in Section 50-40 which may involve the contract for which the bid is submitted.

H. Confidentiality

1. The Illinois Procurement Code provides:

Section 50-45. Confidentiality. Any chief procurement officer, State purchasing officer, designee, or executive officer who willfully uses or allows the use of specifications, competitive bid documents, proprietary competitive information, proposals, contracts, or selection information to compromise the fairness or integrity of the procurement, bidding, or contract process shall be subject to immediate dismissal, regardless of the Personnel code, any contract, or any collective bargaining agreement, and may in addition be subject to criminal prosecution.

2. The bidder assures the Department that it has no knowledge of any fact relevant to the practices addressed in Section 50-45 which may involve the contract for which the bid is submitted.

RETURN WITH BID

I. Insider Information

1. The Illinois Procurement Act provides:

Section 50-50. Insider information. It is unlawful for any current or former elected or appointed State official or State employee to knowingly use confidential information available only by virtue of that office or employment for actual or anticipated gain for themselves or another person.

2. The bidder assures the Department that it has no knowledge of any facts relevant to the practices addressed in Section 50-50 which may involve the contract for which the bid is submitted.

III. CERTIFICATIONS

A. The certifications hereinafter made by the bidder are each a material representation of fact upon which reliance is placed should the Department enter into the contract with the bidder. The Department may terminate the contract if it is later determined that the bidder rendered a false or erroneous certification, and the surety providing the performance bond shall be responsible for completion of the contract.

B. Bribery

1. The Illinois Procurement Code provides:

Section 50-5. Bribery.

(a) Prohibition. No person or business shall be awarded a contract or subcontract under this Code who:

(1) has been convicted under the laws of Illinois or any other state of bribery or attempting to bribe an officer or employee of the State of Illinois or any other state in that officer's or employee's official capacity; or

(2) has made an admission of guilt of that conduct that is a matter of record but has not been prosecuted for that conduct.

(b) Businesses. No business shall be barred from contracting with any unit of State or local government as a result of a conviction under this Section of any employee or agent of the business if the employee or agent is no longer employed by the business and:

(1) the business has been finally adjudicated not guilty; or

(2) the business demonstrates to the governmental entity with which it seeks to contract, and that entity finds that the commission of the offense was not authorized, requested, commanded, or performed by a director, officer, or high managerial agent on behalf of the business as provided in paragraph (2) of subsection (a) of Section 5-4 of the Criminal Code of 1961.

(c) Conduct on behalf of business. For purposes of this Section, when an official, agent, or employee of a business committed the bribery or attempted bribery on behalf of the business and in accordance with the direction or authorization of a responsible official of the business, the business shall be chargeable with the conduct.

(d) Certification. Every bid submitted to and contract executed by the State shall contain a certification by the contractor that the contractor is not barred from being awarded a contract or subcontract under this Section. A contractor who makes a false statement, material to the certification, commits a Class 3 felony.

2. The bidder certifies that it is not barred from being awarded a contract under Section 50.5.

C. Educational Loan

1. Section 3 of the Educational Loan Default Act provides:

§ 3. No State agency shall contract with an individual for goods or services if that individual is in default, as defined in Section 2 of this Act, on an educational loan. Any contract used by any State agency shall include a statement certifying that the individual is not in default on an educational loan as provided in this Section.

2. The bidder, if an individual as opposed to a corporation, partnership or other form of business organization, certifies that the bidder is not in default on an educational loan as provided in Section 3 of the Act.

D. Bid-Rigging/Bid Rotating

1. Section 33E-11 of the Criminal Code of 1961 provides:

§ 33E-11. (a) Every bid submitted to and public contract executed pursuant to such bid by the State or a unit of local government shall contain a certification by the prime contractor that the prime contractor is not barred from contracting with any unit of State or local government as a result of a violation of either Section 33E-3 or 33E-4 of this Article. The State and units of local government shall provide the appropriate forms for such certification.

RETURN WITH BID

(b) A contractor who makes a false statement, material to the certification, commits a Class 3 felony.

A violation of Section 33E-3 would be represented by a conviction of the crime of bid-rigging which, in addition to Class 3 felony sentencing, provides that any person convicted of this offense or any similar offense of any state or the United States which contains the same elements as this offense shall be barred for 5 years from the date of conviction from contracting with any unit of State or local government. No corporation shall be barred from contracting with any unit of State or local government as a result of a conviction under this Section of any employee or agent of such corporation if the employee so convicted is no longer employed by the corporation and: (1) it has been finally adjudicated not guilty or (2) if it demonstrates to the governmental entity with which it seeks to contract and that entity finds that the commission of the offense was neither authorized, requested, commanded, nor performed by a director, officer or a high managerial agent in behalf of the corporation.

A violation of Section 33E-4 would be represented by a conviction of the crime of bid-rotating which, in addition to Class 2 felony sentencing, provides that any person convicted of this offense or any similar offense of any state or the United States which contains the same elements as this offense shall be permanently barred from contracting with any unit of State or local government. No corporation shall be barred from contracting with any unit of State or local government as a result of a conviction under this Section of any employee or agent of such corporation if the employee so convicted is no longer employed by the corporation and: (1) it has been finally adjudicated not guilty or (2) if it demonstrates to the governmental entity with which it seeks to contract and that entity finds that the commission of the offense was neither authorized, requested, commanded, nor performed by a director, officer or a high managerial agent in behalf of the corporation.

2. The bidder certifies that it is not barred from contracting with the Department by reason of a violation of either Section 33E-3 or Section 33E-4.

E. International Anti-Boycott

1. Section 5 of the International Anti-Boycott Certification Act provides:

§ 5. State contracts. Every contract entered into by the State of Illinois for the manufacture, furnishing, or purchasing of supplies, material, or equipment or for the furnishing of work, labor, or services, in an amount exceeding the threshold for small purchases according to the purchasing laws of this State or \$10,000.00, whichever is less, shall contain certification, as a material condition of the contract, by which the contractor agrees that neither the contractor nor any substantially-owned affiliated company is participating or shall participate in an international boycott in violation of the provisions of the U.S. Export Administration Act of 1979 or the regulations of the U.S. Department of Commerce promulgated under that Act.

2. The bidder makes the certification set forth in Section 5 of the Act.

F. Drug Free Workplace

1. The Illinois "Drug Free Workplace Act" applies to this contract and it is necessary to comply with the provisions of the "Act" if the contractor is a corporation, partnership, or other entity (including a sole proprietorship) which has 25 or more employees.

2. The bidder certifies that if awarded a contract in excess of \$5,000 it will provide a drug free workplace by:

(a) Publishing a statement notifying employees that the unlawful manufacture, distribution, dispensation, possession or use of a controlled substance, including cannabis, is prohibited in the contractor's workplace; specifying the actions that will be taken against employees for violations of such prohibition; and notifying the employee that, as a condition of employment on such contract, the employee shall abide by the terms of the statement, and notify the employer of any criminal drug statute conviction for a violation occurring in the workplace no later than five (5) days after such conviction.

(b) Establishing a drug free awareness program to inform employees about the dangers of drug abuse in the workplace; the contractor's policy of maintaining a drug free workplace; any available drug counseling, rehabilitation, and employee assistance programs; and the penalties that may be imposed upon employees for drug violations.

(c) Providing a copy of the statement required by subparagraph (1) to each employee engaged in the performance of the contract and to post the statement in a prominent place in the workplace.

(d) Notifying the Department within ten (10) days after receiving notice from an employee or otherwise receiving actual notice of the conviction of an employee for a violation of any criminal drug statute occurring in the workplace.

(e) Imposing or requiring, within 30 days after receiving notice from an employee of a conviction or actual notice of such a conviction, an appropriate personnel action, up to and including termination, or the satisfactory participation in a drug abuse assistance or rehabilitation program approved by a federal, state or local health, law enforcement or other appropriate agency.

(f) Assisting employees in selecting a course of action in the event drug counseling, treatment, and rehabilitation is required and indicating that a trained referral team is in place.

(g) Making a good faith effort to continue to maintain a drug free workplace through implementation of the actions and efforts stated in this certification.

G. Debt Delinquency

1. The Illinois Procurement Code provides:

Section 50-11 and 50-12. Debt Delinquency.

The contractor or bidder certifies that it, or any affiliate, is not barred from being awarded a contract under 30 ILCS 500. Section 50-11 prohibits a person from entering into a contract with a State agency if it knows or should know that it, or any affiliate, is delinquent in the payment of any debt to the State as defined by the Debt Collection Board. Section 50-12 prohibits a person from entering into a contract with a State agency if it, or any affiliate, has failed to collect and remit Illinois Use Tax on all sales of tangible personal property into the State of Illinois in accordance with the provisions of the Illinois Use Tax Act. The contractor further acknowledges that the contracting State agency may declare the contract void if this certification is false or if the contractor, or any affiliate, is determined to be delinquent in the payment of any debt to the State during the term of the contract.

H. Sarbanes-Oxley Act of 2002

1. The Illinois Procurement Code provides:

Section 50-60(c).

The contractor certifies in accordance with 30 ILCS 500/50-10.5 that no officer, director, partner or other managerial agent of the contracting business has been convicted of a felony under the Sarbanes-Oxley Act of 2002 or a Class 3 or Class 2 felony under the Illinois Securities Law of 1953 for a period of five years prior to the date of the bid or contract. The contractor acknowledges that the contracting agency shall declare the contract void if this certification is false.

I. Addenda

The contractor or bidder certifies that all relevant addenda have been incorporated in to this contract. Failure to do so may cause the bid to be declared unacceptable.

J. Section 42 of the Environmental Protection Act

The contractor certifies in accordance with 30 ILCS 500/50-12 that the bidder or contractor is not barred from being awarded a contract under this Section which prohibits the bidding on or entering into contracts with the State of Illinois or a State agency by a person or business found by a court or the Pollution Control Board to have committed a willful or knowing violation of Section 42 of the Environmental Protection Act for a period of five years from the date of the order. The contractor acknowledges that the contracting agency may declare the contract void if this certification is false.

K. Apprenticeship and Training Certification (Does not apply to federal aid projects)

In accordance with the provisions of Section 30-22 (6) of the Illinois Procurement Code, the bidder certifies that it is a participant, either as an individual or as part of a group program, in the approved apprenticeship and training programs applicable to each type of work or craft that the bidder will perform with its own forces. The bidder further certifies for work that will be performed by subcontract that each of its subcontractors submitted for approval either (a) is, at the time of such bid, participating in an approved, applicable apprenticeship and training program; or (b) will, prior to commencement of performance of work pursuant to this contract, begin participation in an approved apprenticeship and training program applicable to the work of the subcontract. The Department, at any time before or after award, may require the production of a copy of each applicable Certificate of Registration issued by the United States Department of Labor evidencing such participation by the contractor and any or all of its subcontractors. Applicable apprenticeship and training programs are those that have been approved and registered with the United States Department of Labor. The bidder shall list in the space below, the official name of the program sponsor holding the Certificate of Registration for all of the types of work or crafts in which the bidder is a participant and that will be performed with the bidder's forces. Types of work or craft work that will be subcontracted shall be included and listed as subcontract work. The list shall also indicate any type of work or craft job category that does not have an applicable apprenticeship or training program. **The bidder is responsible for making a complete report and shall make certain that each type of work or craft job category that will be utilized on the project as reported on the Construction Employee Workforce Projection (Form BC-1256) and returned with the bid is accounted for and listed.**

The requirements of this certification and disclosure are a material part of the contract, and the contractor shall require this certification provision to be included in all approved subcontracts. In order to fulfill this requirement, it shall not be necessary that an applicable program sponsor be currently taking or that it will take applications for apprenticeship, training or employment during the performance of the work of this contract.

L. Executive Order Number 1 (2007) Regarding Lobbying on Government Procurements

The bidder hereby warrants and certifies that they have complied and will comply with the requirements set forth in this Order. The requirements of this warrant and certification are a material part of the contract, and the contractor shall require this warrant and certification provision to be included in all approved subcontracts.

M. Disclosure of Business Operations in Iran

Public Act 95-0616 provides that each bid, offer, or proposal submitted for a State contract shall include a disclosure of whether or not the Company acting as the bidder, offeror, or proposing entity, or any of its corporate parents or subsidiaries, within the 24 months before submission of the bid, offer, or proposal had business operations that involved contracts with or provision of supplies or services to the Government of Iran, companies in which the Government of Iran has any direct or indirect equity share, consortiums or projects commissioned by the Government of Iran, or companies involved in consortiums or projects commissioned by the Government of Iran and either of the following conditions apply:

- (1) More than 10% of the Company's revenues produced in or assets located in Iran involve oil-related activities or mineral-extraction activities; less than 75% of the Company's revenues produced in or assets located in Iran involve contracts with or provision of oil-related or mineral-extraction products or services to the Government of Iran or a project or consortium created exclusively by that government; and the Company has failed to take substantial action.
- (2) The Company has, on or after August 5, 1996, made an investment of \$20 million or more, or any combination of investments of at least \$10 million each that in the aggregate equals or exceeds \$20 million in any 12-month period, which directly or significantly contributes to the enhancement of Iran's ability to develop petroleum resources of Iran.

The terms "Business operations", "Company", "Mineral-extraction activities", "Oil-related activities", "Petroleum resources", and "Substantial action" are all defined in the Act.

Failure to make the disclosure required by the Act shall cause the bid, offer or proposal to be considered not responsive. The disclosure will be considered when evaluating the bid, offer, or proposal or awarding the contract. The name of each Company disclosed as doing business or having done business in Iran will be provided to the State Comptroller.

Check the appropriate statement:

Company has no business operations in Iran to disclose.

Company has business operations in Iran as disclosed the attached document.

NOTICE

**PA 95-0635 SUBSTANCE ABUSE PREVENTION PROGRAM (SAPP)
Effective January 1, 2008**

This Public Act requires that all contractors and subcontractors have a SAPP, meeting certain requirements, in place before starting work.

The as read low bidder is required to submit a correctly completed SAPP Certification Form BC 261 within seven (7) working days after the Letting. The Department will not accept a SAPP that does not meet the seven day submittal requirement and the bid will be declared not responsive. In the event the bid is declared not responsive due to failure to comply the Department may elect to cause the forfeiture of the penal sum of the bidder's proposal guaranty, may deny authorization to bid the project if re-advertised for bids and may not allow the bidder to participate on subsequent Lettings.

Submittal and approval of the bidder's SAPP is a condition of award.

The SAPP is to be submitted to the Bureau of Design & Environment, Contracts Office, Room 326, 2300 South Dirksen Parkway, Springfield, IL 62764. Voice 217-782-7806. Fax 217-785-1141. It is the bidder's responsibility to obtain confirmation of delivery.

The requirements of this Public Act are a material part of the contract, and the contractor shall require this provision to be included in all approved subcontracts. The contractor shall submit the correctly completed SAPP Certification Form BC 261 for each subcontractor with the Request for Approval of Subcontractor Form BC 260A.

TO BE RETURNED WITH BID

IV. DISCLOSURES

A. The disclosures hereinafter made by the bidder are each a material representation of fact upon which reliance is placed should the Department enter into the contract with the bidder. The Department may terminate the contract if it is later determined that the bidder rendered a false or erroneous disclosure, and the surety providing the performance bond shall be responsible for completion of the contract.

B. Financial Interests and Conflicts of Interest

1. Section 50-35 of the Illinois Procurement Code provides that all bids of more than \$10,000 shall be accompanied by disclosure of the financial interests of the bidder. This disclosed information for the successful bidder, will be maintained as public information subject to release by request pursuant to the Freedom of Information Act.

The financial interests to be disclosed shall include ownership or distributive income share that is in excess of 5%, or an amount greater than 60% of the annual salary of the Governor, of the bidding entity or its parent entity, whichever is less, unless the contractor or bidder is a publicly traded entity subject to Federal 10K reporting, in which case it may submit its 10K disclosure in place of the prescribed disclosure. If a bidder is a privately held entity that is exempt from Federal 10K reporting, but has more than 400 shareholders, it may submit the information that Federal 10K companies are required to report, and list the names of any person or entity holding any ownership share that is in excess of 5%. The disclosure shall include the names, addresses, and dollar or proportionate share of ownership of each person making the disclosure, their instrument of ownership or beneficial relationship, and notice of any potential conflict of interest resulting from the current ownership or beneficial interest of each person making the disclosure having any of the relationships identified in Section 50-35 and on the disclosure form.

In addition, all disclosures shall indicate any other current or pending contracts, proposals, leases, or other ongoing procurement relationships the bidding entity has with any other unit of state government and shall clearly identify the unit and the contract, proposal, lease, or other relationship.

2. Disclosure Forms. Disclosure Form A is attached for use concerning the individuals meeting the above ownership or distributive share requirements. Subject individuals should be covered each by one form. In addition, a second form (Disclosure Form B) provides for the disclosure of current or pending procurement relationships with other (non-IDOT) state agencies. **The forms must be included with each bid or incorporated by reference.**

C. Disclosure Form Instructions

Form A: For bidders that have previously submitted the information requested in Form A

The Department has retained the Form A disclosures submitted by all bidders responding to these requirements for the April 24, 1998 or any subsequent letting conducted by the Department. The bidder has the option of submitting the information again or the bidder may check the following certification statement indicating that the information previously submitted by the bidder is, as of the date of submission, current and accurate. Before checking this certification, the bidder should carefully review its prior submissions to ensure the Certification is correct. If the Bidder checks the Certification, the Bidder should proceed to Form B instructions.

CERTIFICATION STATEMENT

I have determined that the Form A disclosure information previously submitted is current and accurate, and all forms are hereby incorporated by reference in this bid. Any necessary additional forms or amendments to previously submitted forms are attached to this bid.

(Bidding Company)



Signature of Authorized Representative

Date

Form A: For bidders who have NOT previously submitted the information requested in Form A

If the bidder is a publicly traded entity subject to Federal 10K reporting, the 10K Report may be submitted to meet the requirements of Form A. If a bidder is a privately held entity that is exempt from Federal 10K reporting, but has more than 400 shareholders, it may submit the information that Federal 10K companies are required to report, and list the names of any person or entity holding any ownership share that is in excess of 5%. If a bidder is not subject to Federal 10K reporting, the bidder must determine if any individuals are required by law to complete a financial disclosure form. To do this, the bidder should answer each of the following questions. A "YES" answer indicates Form A must be completed. If the answer to each of the following questions is "NO", then the NOT APPLICABLE STATEMENT on the second page of Form A must be signed and dated by a person that is authorized to execute contracts for the bidding company. Note: These questions are for assistance only and are not required to be completed.

1. Does anyone in your organization have a direct or beneficial ownership share of greater than 5% of the bidding entity or parent entity? YES ___ NO ___
2. Does anyone in your organization have a direct or beneficial ownership share of less than 5%, but which has a value greater than \$102,600.00? YES ___ NO ___
3. Does anyone in your organization receive more than \$102,600.00 of the bidding entity's or parent entity's distributive income? (Note: Distributive income is, for these purposes, any type of distribution of profits. An annual salary is not distributive income.) YES ___ NO ___
4. Does anyone in your organization receive greater than 5% of the bidding entity's or parent entity's total distributive income, but which is less than \$102,600.00? YES ___ NO ___

(Note: Only one set of forms needs to be completed per person per bid even if a specific individual would require a yes answer to more than one question.)

A "YES" answer to any of these questions requires the completion of Form A. The bidder must determine each individual in the bidding entity or the bidding entity's parent company that would cause the questions to be answered "Yes". Each form must be signed and dated by a person that is authorized to execute contracts for your organization. **Photocopied or stamped signatures are not acceptable.** The person signing can be, but does not have to be, the person for which the form is being completed. The bidder is responsible for the accuracy of any information provided.

If the answer to each of the above questions is "NO", then the NOT APPLICABLE STATEMENT on page 2 of Form A must be signed and dated by a person that is authorized to execute contracts for your company.

Form B: Identifying Other Contracts & Procurement Related Information Disclosure Form B must be completed for each bid submitted by the bidding entity. Note: *Checking the NOT APPLICABLE STATEMENT on Form A does not allow the bidder to ignore Form B. Form B must be completed, checked, and dated or the bidder may be considered nonresponsive and the bid will not be accepted.*

The Bidder shall identify, by checking Yes or No on Form B, whether it has any pending contracts (including leases), bids, proposals, or other ongoing procurement relationship with any other (non-IDOT) State of Illinois agency. If "No" is checked, the bidder only needs to complete the check box on the bottom of Form B. If "Yes" is checked, the bidder must do one of the following:

Option I: If the bidder did not submit an Affidavit of Availability to obtain authorization to bid, the bidder must list all non-IDOT State of Illinois agency pending contracts, leases, bids, proposals, and other ongoing procurement relationships. These items may be listed on Form B or on an attached sheet(s). Do not include IDOT contracts. Contracts with cities, counties, villages, etc. are not considered State of Illinois agency contracts and are not to be included. Contracts with other State of Illinois agencies such as the Department of Natural Resources or the Capital Development Board must be included. Bidders who submit Affidavits of Availability are suggested to use Option II.

Option II: If the bidder is required and has submitted an Affidavit of Availability in order to obtain authorization to bid, the bidder may write or type "See Affidavit of Availability" which indicates that the Affidavit of Availability is incorporated by reference and includes all non-IDOT State of Illinois agency pending contracts, leases, bids, proposals, and other ongoing procurement relationships. For any contracts that are not covered by the Affidavit of Availability, the bidder must identify them on Form B or on an attached sheet(s). These might be such things as leases.

D. Bidders Submitting More Than One Bid

Bidders submitting multiple bids may submit one set of forms consisting of all required Form A disclosures and one Form B for use with all bids. Please indicate in the space provided below the bid item that contains the original disclosure forms and the bid items which incorporate the forms by reference.

- The bid submitted for letting item _____ contains the Form A disclosures or Certification Statement and the Form B disclosures. The following letting items incorporate the said forms by reference:

**ILLINOIS DEPARTMENT
OF TRANSPORTATION**

**Form A
Financial Information &
Potential Conflicts of Interest
Disclosure**

Contractor Name		
Legal Address		
City, State, Zip		
Telephone Number	Email Address	Fax Number (if available)

Disclosure of the information contained in this Form is required by the Section 50-35 of the Illinois Procurement Code (30 ILCS 500). Vendors desiring to enter into a contract with the State of Illinois must disclose the financial information and potential conflict of interest information as specified in this Disclosure Form. This information shall become part of the publicly available contract file. This Form A must be completed for bids in excess of \$10,000, and for all open-ended contracts. **A publicly traded company may submit a 10K disclosure (or equivalent if applicable) in satisfaction of the requirements set forth in Form A. See Disclosure Form Instructions.**

DISCLOSURE OF FINANCIAL INFORMATION

1. Disclosure of Financial Information. The individual named below has an interest in the BIDDER (or its parent) in terms of ownership or distributive income share in excess of 5%, or an interest which has a value of more than \$102,600.00 (60% of the Governor's salary as of 7/1/07). **(Make copies of this form as necessary and attach a separate Disclosure Form A for each individual meeting these requirements)**

FOR INDIVIDUAL (type or print information)

NAME: _____

ADDRESS _____

Type of ownership/distributable income share:

stock _____ sole proprietorship _____ Partnership _____ other: (explain on separate sheet):
% or \$ value of ownership/distributable income share: _____

2. Disclosure of Potential Conflicts of Interest. Check "Yes" or "No" to indicate which, if any, of the following potential conflict of interest relationships apply. If the answer to any question is "Yes", please attach additional pages and describe.

(a) State employment, currently or in the previous 3 years, including contractual employment of services. Yes ___ No ___

If your answer is yes, please answer each of the following questions.

1. Are you currently an officer or employee of either the Capitol Development Board or the Illinois Toll Highway Authority? Yes ___ No ___

2. Are you currently appointed to or employed by any agency of the State of Illinois? If you are currently appointed to or employed by any agency of the State of Illinois, and your annual salary exceeds \$102,600.00, (60% of the Governor's salary as of 7/1/07) provide the name the State agency for which you are employed and your annual salary. _____

RETURN WITH BID/OFFER

- 3. If you are currently appointed to or employed by any agency of the State of Illinois, and your annual salary exceeds \$102,600.00, (60% of the Governor's salary as of 7/1/07) are you entitled to receive (i) more than 7 1/2% of the total distributable income of your firm, partnership, association or corporation, or (ii) an amount in excess of the salary of the Governor? Yes ___ No ___
- 4. If you are currently appointed to or employed by any agency of the State of Illinois, and your annual salary exceeds \$102,600.00, (60% of the Governor's salary as of 7/1/07) are you and your spouse or minor children entitled to receive (i) more than 15 % in the aggregate of the total distributable income of your firm, partnership, association or corporation, or (ii) an amount in excess of 2 times the salary of the Governor? Yes ___ No ___

(b) State employment of spouse, father, mother, son, or daughter, including contractual employment services in the previous 2 years.

Yes ___ No ___

If your answer is yes, please answer each of the following questions.

- 1. Is your spouse or any minor children currently an officer or employee of the Capitol Development Board or the Illinois Toll Highway Authority? Yes ___ No ___
- 2. Is your spouse or any minor children currently appointed to or employed by any agency of the State of Illinois? If your spouse or minor children is/are currently appointed to or employed by any agency of the State of Illinois, and his/her annual salary exceeds \$102,600.00, (60 % of the Governor's salary as of 7/1/07) provide the name of your spouse and/or minor children, the name of the State agency for which he/she is employed and his/her annual salary. _____

- 3. If your spouse or any minor children is/are currently appointed to or employed by any agency of the State of Illinois, and his/her annual salary exceeds \$102,600.00, (60% of the salary of the Governor as of 7/1/07) are you entitled to receive (i) more then 71/2% of the total distributable income of your firm, partnership, association or corporation, or (ii) an amount in excess of the salary of the Governor? Yes ___ No ___
- 4. If your spouse or any minor children are currently appointed to or employed by any agency of the State of Illinois, and his/her annual salary exceeds \$102,600.00, (60% of the Governor's salary as of 7/1/07) are you and your spouse or minor children entitled to receive (i) more than 15 % in the aggregate of the total distributable income of your firm, partnership, association or corporation, or (ii) an amount in excess of 2 times the salary of the Governor? Yes ___ No ___

(c) Elective status; the holding of elective office of the State of Illinois, the government of the United States, any unit of local government authorized by the Constitution of the State of Illinois or the statutes of the State of Illinois currently or in the previous 3 years.

Yes ___ No ___

(d) Relationship to anyone holding elective office currently or in the previous 2 years; spouse, father, mother, son, or daughter.

Yes ___ No ___

(e) Appointive office; the holding of any appointive government office of the State of Illinois, the United States of America, or any unit of local government authorized by the Constitution of the State of Illinois or the statutes of the State of Illinois, which office entitles the holder to compensation in excess of the expenses incurred in the discharge of that office currently or in the previous 3 years.

Yes ___ No ___

(f) Relationship to anyone holding appointive office currently or in the previous 2 years; spouse, father, mother, son, or daughter.

Yes ___ No ___

(g) Employment, currently or in the previous 3 years, as or by any registered lobbyist of the State government.

Yes ___ No ___

RETURN WITH BID/OFFER

(h) Relationship to anyone who is or was a registered lobbyist in the previous 2 years; spouse, father, mother, son, or daughter. Yes ___ No ___

(i) Compensated employment, currently or in the previous 3 years, by any registered election or reelection committee registered with the Secretary of State or any county clerk of the State of Illinois, or any political action committee registered with either the Secretary of State or the Federal Board of Elections. Yes ___ No ___

(j) Relationship to anyone; spouse, father, mother, son, or daughter; who was a compensated employee in the last 2 years by any registered election or re-election committee registered with the Secretary of State or any county clerk of the State of Illinois, or any political action committee registered with either the Secretary of State or the Federal Board of Elections. Yes ___ No ___

APPLICABLE STATEMENT

This Disclosure Form A is submitted on behalf of the INDIVIDUAL named on previous page.

Completed by: _____ Date _____
Signature of Individual or Authorized Representative

NOT APPLICABLE STATEMENT

I have determined that no individuals associated with this organization meet the criteria that would require the completion of this Form A.

This Disclosure Form A is submitted on behalf of the CONTRACTOR listed on the previous page.

_____ Date _____
Signature of Authorized Representative

RETURN WITH BID/OFFER

ILLINOIS DEPARTMENT
OF TRANSPORTATION

Form B
Other Contracts &
Procurement Related Information
Disclosure

Contractor Name		
Legal Address		
City, State, Zip		
Telephone Number	Email Address	Fax Number (if available)

Disclosure of the information contained in this Form is required by the Section 50-35 of the Illinois Procurement Act (30 ILCS 500). This information shall become part of the publicly available contract file. This Form B must be completed for bids in excess of \$10,000, and for all open-ended contracts.

DISCLOSURE OF OTHER CONTRACTS AND PROCUREMENT RELATED INFORMATION

1. Identifying Other Contracts & Procurement Related Information. The BIDDER shall identify whether it has any pending contracts (including leases), bids, proposals, or other ongoing procurement relationship with any other State of Illinois agency: Yes ___ No ___

If "No" is checked, the bidder only needs to complete the signature box on the bottom of this page.

2. If "Yes" is checked. Identify each such relationship by showing State of Illinois agency name and other descriptive information such as bid or project number (attach additional pages as necessary). SEE DISCLOSURE FORM INSTRUCTIONS:

THE FOLLOWING STATEMENT MUST BE CHECKED

<input type="checkbox"/>	_____	_____
	Signature of Authorized Representative	Date

RETURN WITH BID

SPECIAL NOTICE TO CONTRACTORS

The following requirements of the Illinois Department of Human Rights' Rules and Regulations are applicable to bidders on all construction contracts advertised by the Illinois Department of Transportation:

CONSTRUCTION EMPLOYEE UTILIZATION PROJECTION

- (a) All bidders on construction contracts shall complete and submit, along with and as part of their bids, a Bidder's Employee Utilization Form (Form BC-1256) setting forth a projection and breakdown of the total workforce intended to be hired and/or allocated to such contract work by the bidder including a projection of minority and female employee utilization in all job classifications on the contract project.
- (b) The Department of Transportation shall review the Employee Utilization Form, and workforce projections contained therein, of the contract awardee to determine if such projections reflect an underutilization of minority persons and/or women in any job classification in accordance with the Equal Employment Opportunity Clause and Section 7.2 of the Illinois Department of Human Rights' Rules and Regulations for Public Contracts adopted as amended on September 17, 1980. If it is determined that the contract awardee's projections reflect an underutilization of minority persons and/or women in any job classification, it shall be advised in writing of the manner in which it is underutilizing and such awardee shall be considered to be in breach of the contract unless, prior to commencement of work on the contract project, it submits revised satisfactory projections or an acceptable written affirmative action plan to correct such underutilization including a specific timetable geared to the completion stages of the contract.
- (c) The Department of Transportation shall provide to the Department of Human Rights a copy of the contract awardee's Employee Utilization Form, a copy of any required written affirmative action plan, and any written correspondence related thereto. The Department of Human Rights may review and revise any action taken by the Department of Transportation with respect to these requirements.

RETURN WITH BID



Contract No. 76A57
MADISON-RANDOLPH-BOND Counties
Section DIST 8 SEAL COAT 2008-1
Various Routes
District 8 Construction Funds

PART I. IDENTIFICATION

Dept. Human Rights # _____ Duration of Project: _____
 Name of Bidder: _____

PART II. WORKFORCE PROJECTION

A. The undersigned bidder has analyzed minority group and female populations, unemployment rates and availability of workers for the location in which this contract work is to be performed, and for the locations from which the bidder recruits employees, and hereby submits the following workforce projection including a projection for minority and female employee utilization in all job categories in the workforce to be allocated to this contract:

TABLE A

TOTAL Workforce Projection for Contract													
JOB CATEGORIES	TOTAL EMPLOYEES		MINORITY EMPLOYEES						TRAINEES				
			BLACK		HISPANIC		*OTHER MINOR.		APPRENTICES		ON THE JOB TRAINEES		
	M	F	M	F	M	F	M	F	M	F	M	F	
OFFICIALS (MANAGERS)													
SUPERVISORS													
FOREMEN													
CLERICAL													
EQUIPMENT OPERATORS													
MECHANICS													
TRUCK DRIVERS													
IRONWORKERS													
CARPENTERS													
CEMENT MASONS													
ELECTRICIANS													
PIPEFITTERS, PLUMBERS													
PAINTERS													
LABORERS, SEMI-SKILLED													
LABORERS, UNSKILLED													
TOTAL													

TABLE B

CURRENT EMPLOYEES TO BE ASSIGNED TO CONTRACT			
TOTAL EMPLOYEES		MINORITY EMPLOYEES	
M	F	M	F

TABLE C

TOTAL Training Projection for Contract								
EMPLOYEES IN TRAINING	TOTAL EMPLOYEES		BLACK		HISPANIC		*OTHER MINOR.	
	M	F	M	F	M	F	M	F
APPRENTICES								
ON THE JOB TRAINEES								

FOR DEPARTMENT USE ONLY

* Other minorities are defined as Asians (A) or Native Americans (N).
 Please specify race of each employee shown in Other Minorities column.

Note: See instructions on page 2

RETURN WITH BID

**Contract No. 76A57
MADISON-RANDOLPH-BOND Counties
Section DIST 8 SEAL COAT 2008-1
Various Routes
District 8 Construction Funds**

PART II. WORKFORCE PROJECTION - continued

- B. Included in "Total Employees" under Table A is the total number of **new hires** that would be employed in the event the undersigned bidder is awarded this contract.

The undersigned bidder projects that: (number) _____ new hires would be recruited from the area in which the contract project is located; and/or (number) _____ new hires would be recruited from the area in which the bidder's principal office or base of operation is located.

- C. Included in "Total Employees" under Table A is a projection of numbers of persons to be employed directly by the undersigned bidder as well as a projection of numbers of persons to be employed by subcontractors.

The undersigned bidder estimates that (number) _____ persons will be directly employed by the prime contractor and that (number) _____ persons will be employed by subcontractors.

PART III. AFFIRMATIVE ACTION PLAN

- A. The undersigned bidder understands and agrees that in the event the foregoing minority and female employee utilization projection included under **PART II** is determined to be an underutilization of minority persons or women in any job category, and in the event that the undersigned bidder is awarded this contract, he/she will, prior to commencement of work, develop and submit a written Affirmative Action Plan including a specific timetable (geared to the completion stages of the contract) whereby deficiencies in minority and/or female employee utilization are corrected. Such Affirmative Action Plan will be subject to approval by the contracting agency and the **Department of Human Rights**.
- B. The undersigned bidder understands and agrees that the minority and female employee utilization projection submitted herein, and the goals and timetable included under an Affirmative Action Plan if required, are deemed to be part of the contract specifications.

Company _____ Telephone Number _____

Address _____

NOTICE REGARDING SIGNATURE

The Bidder's signature on the Proposal Signature Sheet will constitute the signing of this form. The following signature block needs to be completed if revisions are required.

Signature: _____ Title: _____ Date: _____

- Instructions: All tables must include subcontractor personnel in addition to prime contractor personnel.
- Table A - Include both the number of employees that would be hired to perform the contract work and the total number currently employed (Table B) that will be allocated to contract work, and include all apprentices and on-the-job trainees. The "Total Employees" column should include all employees including all minorities, apprentices and on-the-job trainees to be employed on the contract work.
 - Table B - Include all employees currently employed that will be allocated to the contract work including any apprentices and on-the-job trainees currently employed.
 - Table C - Indicate the racial breakdown of the total apprentices and on-the-job trainees shown in Table A.

RETURN WITH BID

**Contract No. 76A57
MADISON-RANDOLPH-BOND Counties
Section DIST 8 SEAL COAT 2008-1
Various Routes
District 8 Construction Funds**

PROPOSAL SIGNATURE SHEET

The undersigned bidder hereby makes and submits this bid on the subject Proposal, thereby assuring the Department that all requirements of the Invitation for Bids and rules of the Department have been met, that there is no misunderstanding of the requirements of paragraph 3 of this Proposal, and that the contract will be executed in accordance with the rules of the Department if an award is made on this bid.

Firm Name _____
(IF AN INDIVIDUAL) Signature of Owner _____
Business Address _____

Firm Name _____
By _____
(IF A CO-PARTNERSHIP) Business Address _____

Name and Address of All Members of the Firm:

Corporate Name _____
By _____
Signature of Authorized Representative

Typed or printed name and title of Authorized Representative
(IF A CORPORATION) Attest _____
Signature
(IF A JOINT VENTURE, USE THIS SECTION
FOR THE MANAGING PARTY AND THE
SECOND PARTY SHOULD SIGN BELOW) Business Address _____

Corporate Name _____
By _____
Signature of Authorized Representative

Typed or printed name and title of Authorized Representative
(IF A JOINT VENTURE) Attest _____
Signature
Business Address _____

If more than two parties are in the joint venture, please attach an additional signature sheet.



**Illinois Department
of Transportation**

Return with Bid

**Division of Highways
Proposal Bid Bond
(Effective November 1, 1992)**

Item No. _____

Letting Date _____

KNOW ALL MEN BY THESE PRESENTS, That We _____

as PRINCIPAL, and _____

_____ as SURETY, are held jointly, severally and firmly bound unto the STATE OF ILLINOIS in the penal sum of 5 percent of the total bid price, or for the amount specified in Article 102.09 of the "Standard Specifications for Road and Bridge Construction" in effect on the date of invitation for bids, whichever is the lesser sum, well and truly to be paid unto said STATE OF ILLINOIS, for the payment of which we bind ourselves, our heirs, executors, administrators, successors and assigns.

THE CONDITION OF THE FOREGOING OBLIGATION IS SUCH, that whereas, the PRINCIPAL has submitted a bid proposal to the STATE OF ILLINOIS, acting through the Department of Transportation, for the improvement designated by the Transportation Bulletin Item Number and Letting Date indicated above.

NOW, THEREFORE, if the Department shall accept the bid proposal of the PRINCIPAL; and if the PRINCIPAL shall, within the time and as specified in the bidding and contract documents, submit a DBE Utilization Plan that is accepted and approved by the Department; and if, after award by the Department, the PRINCIPAL shall enter into a contract in accordance with the terms of the bidding and contract documents including evidence of the required insurance coverages and providing such bond as specified with good and sufficient surety for the faithful performance of such contract and for the prompt payment of labor and material furnished in the prosecution thereof; or if, in the event of the failure of the PRINCIPAL to make the required DBE submission or to enter into such contract and to give the specified bond, the PRINCIPAL pays to the Department the difference not to exceed the penalty hereof between the amount specified in the bid proposal and such larger amount for which the Department may contract with another party to perform the work covered by said bid proposal, then this obligation shall be null and void, otherwise, it shall remain in full force and effect.

IN THE EVENT the Department determines the PRINCIPAL has failed to comply with any requirement as set forth in the preceding paragraph, then Surety shall pay the penal sum to the Department within fifteen (15) days of written demand therefor. If Surety does not make full payment within such period of time, the Department may bring an action to collect the amount owed. Surety is liable to the Department for all its expenses, including attorney's fees, incurred in any litigation in which it prevails either in whole or in part.

In TESTIMONY WHEREOF, the said PRINCIPAL and the said SURETY have caused this instrument to be signed by their respective officers this _____ day of _____ A.D., _____.

PRINCIPAL

(Company Name)

(Company Name)

By: _____
(Signature & Title)

By: _____
(Signature of Attorney-in-Fact)

Notary Certification for Principal and Surety

STATE OF ILLINOIS,

County of _____

I, _____, a Notary Public in and for said County, do hereby certify that

_____ and _____
(Insert names of individuals signing on behalf of PRINCIPAL & SURETY)

who are each personally known to me to be the same persons whose names are subscribed to the foregoing instrument on behalf of PRINCIPAL and SURETY, appeared before me this day in person and acknowledged respectively, that they signed and delivered said instrument as their free and voluntary act for the uses and purposes therein set forth.

Given under my hand and notarial seal this _____ day of _____ A.D. _____

My commission expires _____

Notary Public

In lieu of completing the above section of the Proposal Bid Form, the Principal may file an Electronic Bid Bond. By signing the proposal and marking the check box next to the Signature and Title line below, the Principal is ensuring the identified electronic bid bond has been executed and the Principal and Surety are firmly bound unto the State of Illinois under the conditions of the bid bond as shown above.

Electronic Bid Bond ID#

Company / Bidder Name



Signature and Title

PROPOSAL ENVELOPE



PROPOSALS

for construction work advertised for bids by the
Illinois Department of Transportation

Item No.	Item No.	Item No.

Submitted By:

Name:
Address:
Phone No.

Bidders should use an IDOT proposal envelope or affix this form to the front of a 10" x 13" envelope for the submittal of bids. If proposals are mailed, they should be enclosed in a second or outer envelope addressed to:

Engineer of Design and Environment - Room 326
Illinois Department of Transportation
2300 South Dirksen Parkway
Springfield, Illinois 62764

NOTICE

Individual bids, including Bid Bond and/or supplemental information if required, should be securely stapled.

CONTRACTOR OFFICE COPY OF CONTRACT SPECIFICATIONS

NOTICE

None of the following material needs to be returned with the bid package unless the special provisions require documentation and/or other information to be submitted.

**Contract No. 76A57
MADISON-RANDOLPH-BOND Counties
Section DIST 8 SEAL COAT 2008-1
Various Routes
District 8 Construction Funds**



Illinois Department of Transportation



NOTICE TO BIDDERS

1. TIME AND PLACE OF OPENING BIDS. Sealed proposals for the improvement described herein will be received by the Department of Transportation at the Harry R. Hanley Building, 2300 South Dirksen Parkway, in Springfield, Illinois until 10:00 o'clock a.m., June 13, 2008. All bids will be gathered, sorted, publicly opened and read in the auditorium at the Department of Transportation's Harry R. Hanley Building shortly after the 10:00 a.m. cut off time.

2. DESCRIPTION OF WORK. The proposed improvement is identified and advertised for bids in the Invitation for Bids as:

**Contract No. 76A57
MADISON-RANDOLPH-BOND Counties
Section DIST 8 SEAL COAT 2008-1
Various Routes
District 8 Construction Funds**

10.79 miles of seal coat at 13 locations in Madison, Randolph and Bond counties.

3. INSTRUCTIONS TO BIDDERS. (a) This Notice, the invitation for bids, proposal and letter of award shall, together with all other documents in accordance with Article 101.09 of the Standard Specifications for Road and Bridge Construction, become part of the contract. Bidders are cautioned to read and examine carefully all documents, to make all required inspections, and to inquire or seek explanation of the same prior to submission of a bid.

(b) State law, and, if the work is to be paid wholly or in part with Federal-aid funds, Federal law requires the bidder to make various certifications as a part of the proposal and contract. By execution and submission of the proposal, the bidder makes the certification contained therein. A false or fraudulent certification shall, in addition to all other remedies provided by law, be a breach of contract and may result in termination of the contract.

4. AWARD CRITERIA AND REJECTION OF BIDS. This contract will be awarded to the lowest responsive and responsible bidder considering conformity with the terms and conditions established by the Department in the rules, Invitation for Bids and contract documents. The issuance of plans and proposal forms for bidding based upon a prequalification rating shall not be the sole determinant of responsibility. The Department reserves the right to determine responsibility at the time of award, to reject any or all proposals, to readvertise the proposed improvement, and to waive technicalities.

By Order of the
Illinois Department of Transportation

Milton R. Sees, Secretary

BD 351 (Rev. 01/2003)

INDEX
FOR
SUPPLEMENTAL SPECIFICATIONS
AND RECURRING SPECIAL PROVISIONS

Adopted January 1, 2008

This index contains a listing of SUPPLEMENTAL SPECIFICATIONS and frequently used RECURRING SPECIAL PROVISIONS.

ERRATA Standard Specifications for Road and Bridge Construction (Adopted 1-1-07) (Revised 1-1-08)

SUPPLEMENTAL SPECIFICATIONS

<u>Std. Spec. Sec.</u>	<u>Page No.</u>
205 Embankment	1
251 Mulch	2
253 Planting Woody Plants	3
280 Temporary Erosion Control	5
443 Reflective Crack Control Treatment	6
502 Excavation for Structures	9
503 Concrete Structures	10
505 Steel Structures	11
540 Box Culverts	12
633 Removing and Reerecting Guardrail and Terminals	13
672 Sealing Abandoned Water Wells	14
701 Work Zone Traffic Control and Protection	15
838 Breakaway Devices	16
1004 Coarse Aggregates	17
1020 Portland Cement Concrete	18
1022 Concrete Curing Materials	20
1042 Precast Concrete Products	21
1062 Reflective Crack Control System	22
1069 Pole and Tower	24
1081 Materials for Planting	27
1083 Elastomeric Bearings	29
1102 Hot-Mix Asphalt Equipment	30

RECURRING SPECIAL PROVISIONS

The following RECURRING SPECIAL PROVISIONS indicated by an "X" are applicable to this contract and are included by reference:

<u>CHECK SHEET #</u>		<u>PAGE NO.</u>
1	Additional State Requirements For Federal-Aid Construction Contracts (Eff. 2-1-69) (Rev. 1-1-07)	31
2	Subletting of Contracts (Federal-Aid Contracts) (Eff. 1-1-88) (Rev. 5-1-93)	33
3	X EEO (Eff. 7-21-78) (Rev. 11-18-80)	34
4	X Specific Equal Employment Opportunity Responsibilities Non Federal-Aid Contracts (Eff. 3-20-69) (Rev. 1-1-94)	44
5	X Required Provisions - State Contracts (Eff. 4-1-65) (Rev. 1-1-07)	49
6	Reserved	54
7	Reserved	55
8	Haul Road Stream Crossings, Other Temporary Stream Crossings, and In-Stream Work Pads (Eff. 1-2-92) (Rev. 1-1-98)	56
9	Construction Layout Stakes Except for Bridges (Eff. 1-1-99) (Rev. 1-1-07)	57
10	Construction Layout Stakes (Eff. 5-1-93) (Rev. 1-1-07)	60
11	Use of Geotextile Fabric for Railroad Crossing (Eff. 1-1-95) (Rev. 1-1-07)	63
12	Subsealing of Concrete Pavements (Eff. 11-1-84) (Rev. 1-1-07)	65
13	Hot-Mix Asphalt Surface Removal (Cold Milling) (Eff. 11-1-87) (Rev. 1-1-07)	69
14	Pavement and Shoulder Resurfacing (Eff. 2-1-00) (Rev. 1-1-07)	71
15	PCC Partial Depth Hot-Mix Asphalt Patching (Eff. 1-1-98) (Rev. 1-1-07)	72
16	Patching with Hot-Mix Asphalt Overlay Removal (Eff. 10-1-95) (Rev. 1-1-07)	74
17	Polymer Concrete (Eff. 8-1-95) (Rev. 1-1-08)	75
18	PVC Pipeliner (Eff. 4-1-04) (Rev. 1-1-07)	77
19	Pipe Underdrains (Eff. 9-9-87) (Rev. 1-1-07)	78
20	Guardrail and Barrier Wall Delineation (Eff. 12-15-93) (Rev. 1-1-97)	79
21	Bicycle Racks (Eff. 4-1-94) (Rev. 1-1-07)	83
22	Temporary Modular Glare Screen System (Eff. 1-1-00) (Rev. 1-1-07)	85
23	Temporary Portable Bridge Traffic Signals (Eff. 8-1-03) (Rev. 1-1-07)	87
24	Work Zone Public Information Signs (Eff. 9-1-02) (Rev. 1-1-07)	89
25	Night Time Inspection of Roadway Lighting (Eff. 5-1-96)	90
26	English Substitution of Metric Bolts (Eff. 7-1-96)	91
27	English Substitution of Metric Reinforcement Bars (Eff. 4-1-96) (Rev. 1-1-03)	92
28	Calcium Chloride Accelerator for Portland Cement Concrete (Eff. 1-1-01)	93
29	Quality Control of Concrete Mixtures at the Plant-Single A (Eff. 8-1-00) (Rev. 1-1-04)	94
30	Quality Control of Concrete Mixtures at the Plant-Double A (Eff. 8-1-00) (Rev. 1-1-04)	100
31	Quality Control/Quality Assurance of Concrete Mixtures (Eff. 4-1-92) (Rev. 1-1-07)	108

TABLE OF CONTENTS

LOCATION OF PROJECT	1
DESCRIPTION OF PROJECT	1
MONTHLY LABOR SUMMARY AND ACTIVITY REPORTING SYSTEM	1
HOT-MIX ASPHALT SURFACE TREATMENT (CLASS A-1, A-2, A-3).....	4
TRAFFIC CONTROL PLAN	4
CONSTRUCTION AND MAINTENANCE SIGN SUPPORTS	4
STATUS OF UTILITIES TO BE ADJUSTED	5
TRAFFIC CONTROL AND PROTECTION, STANDARD BLR 21	5
TEMPORARY FLEXIBLE RAISED PAVEMENT MARKER.....	5
EQUIPMENT RENTAL RATES (BDE).....	6
PAYMENTS TO SUBCONTRACTORS (BDE)	7
REFLECTIVE SHEETING ON CHANNELIZING DEVICES (BDE)	8
SUBCONTRACTOR MOBILIZATION PAYMENTS (BDE)	9
WORKING DAYS (BDE)	9

STATE OF ILLINOIS

SPECIAL PROVISIONS

The following Special Provisions supplement the "Standard Specifications for Road and Bridge Construction," adopted January 1, 2007, the latest edition of the "Manual on Uniform Traffic Control Devices for Streets and Highways," and the "Manual of Test Procedures for Materials" in effect on the date of invitation for bids, and the Supplemental Specifications and Recurring Special Provisions indicated on the Check Sheet included herein which apply to and govern the construction of Various Routes; Dist 8 Seal Coat 2008-1; Madison, Bond, and Randolph Counties; Contract No. 76A57 and in case of conflict with any part or parts of said Specifications, the said Special Provisions shall take precedence and shall govern.

LOCATION OF PROJECT

This project is located on various routes in Madison, Bond, and Randolph Counties. These locations are I-70 Frontage Road east and west of IL 4, I-55/70 Frontage Road north and south of IL 162, Fort Kaskaskia Access Road, Ellis Grove Rest Area, Ellis Grove Historical Marker, Old IL 3 Runaround, Greenville Maintenance Yard, Collinsville Road from Troy Yard to Main Street, and North Frontage Road between Pocahontas and the Madison County Line, Troy Park n Ride and Lower Marine Road.

DESCRIPTION OF PROJECT

The project consists of A-1 and A-2 bituminous treatments at various locations. Other pay items include paint pavement marking and raised reflective pavement marker removal.

MONTHLY LABOR SUMMARY AND ACTIVITY REPORTING SYSTEM

Effective: 1-1-1995

Revised June 2001

I. Monthly Labor Summary Report, Form SBE 148

The prime contractor and each first and second tier sub-contractor, (hereinafter referred to as "subcontractor") shall submit a certified Monthly Labor Summary Report directly to the District Engineer.

This report is in lieu of submittal of the Monthly Workforce Analysis Report, Form SBE 956.

This report must be received in District Eight no later than the tenth day of the next month.

This Report shall be submitted by the prime contractor and each subcontractor, for each consecutive month, from the start, to the completion of their work on the contract.

The data source for this Report will be a summation of all personnel and hours worked on each subject contract for the month based on weekly payrolls for that month.

The Monthly Labor Summary Report is required to be submitted in one of the following formats:

- a.) For contractors having IDOT contracts valued in the aggregate at \$250,000 or less, the report may be typed or clearly handwritten using Form SBE 148 for submittal to the District Engineer for District Eight.
- b.) For contractors having IDOT contracts valued in the aggregate at more than \$250,000, the report must be submitted in a specific "Fixed Length Comma Delimited ASCII Text File Format". The subject file format is detailed on the next page. Submittal of this file may be by 3.5 inch disk, modem, or by e-mail.

II. Monthly Contract Activity Report, Form SBE 248

The prime contractor and each subcontractor shall submit a monthly report directly to the District Engineer reflecting their contract activity on all Illinois Department of Transportation contracts they have in force in District Eight.

This report shall be submitted for each consecutive month, from the start, to the completion of all contracts in District Eight.

The report must be received in the District Office no later than the tenth day of the next month.

Monthly Labor Summary and Activity Reporting System Codes and Formats

Indicated below for your reference are the Employee Codes and File Formats required for this system.

I.) Monthly Labor Summary Report, Form SBE 148

The following employee codes are to be used to identify each individual on the Summary Report:

1. **Gender:** M - Male F - Female
2. **Ethnic Group:** 1 - White 2 - Black 3 - Hispanic
4 - American Indian/Alaskan Native 5 - Asian/Pacific Islander
3. **Work Classification:** OF - Official SU - Supervisor FO - Foremen
CL - Clerical CA - Carpenter EO - Operator ME - Mechanic
TD - Truck Driver IW - Ironworker PA - Painter OT - Other
EL - Electrician PP - Pipefitter TE - Technical LA - Laborer
CM - Cement Mason
4. **Employee Status:** O - Owner Operator J - Journeyman
C - Company A - Apprentice T - Trainee

Specific “Fixed Length Comma Delimited ASCII File Format”

Order	Field Name	Type	Size
1	Contractor Number	A	4
2	Contractor Reference Number	A	6
3	Contract Number	A	5
4	Period (07/28/2000)	D	10
5	SSN (111-11-1111)	A	11
6	Name	A	40
7	Gender	A	1
8	Ethnic Group	A	1
9	Work Classification	A	1
10	Employee Status	A	1
11	Total Hours (000060.00)	N	10

File Name Conventions: (Contractor Number + Report Month/Year).Txt
i.e. 20001298.Txt

II.) Monthly Contract Activity Report, Form SBE 248

The following activity codes are to be used to identify the contractor’s contract status each month on the Monthly Activity Report, Form SBE 248:

- A. Contract Status: 1 - Not Started 2 - Active 3 - No Work
 4 - Suspended 5 - Complete

Failure to comply with this special provision may result in the withholding of payments to the contractor, and/or cancellation, termination, or suspension of the contract in whole or part.

Compliance with this Special Provision shall be considered incidental to the cost of the contract and no additional compensation will be allowed for any costs incurred.

All prime and subcontractors having contracts in the aggregate exceeding \$250,000 must provide a “Fixed Length Comma Delimited ASCII File” for approval prior to the start of construction.

This Special Provision must be included in each subcontract agreement.

The Department of Transportation is requesting disclosure of information necessary to accomplish the statutory purpose as outlined under 23CFR part 230 and 41CFR part 60.4 and the Illinois Human Rights Act. Disclosure of this information is REQUIRED. Failure to comply with this special provision may result in the withholding of payments to the contractor, and/or cancellation, termination, or suspension of the contract in whole or part.

Compliance with this Special Provision shall be considered incidental to the cost of the contract and no additional compensation will be allowed for any costs incurred.

This Special Provision must be included in each subcontract agreement.

HOT-MIX ASPHALT SURFACE TREATMENT (CLASS A-1, A-2, A-3)

Effective: March 28, 1975

Revised: November 1, 2006

Under Materials Article 1004.03(c), add:

CA-16 or CM-16 may be used for Cover and Seal Coat Aggregate.

TRAFFIC CONTROL PLAN

Effective: July 12, 1993

Revised: May 12, 1997

Traffic control shall be in accordance with the applicable sections of the "Standard Specifications for Road and Bridge Construction", the applicable guidelines contained in the "National Manual on Uniform Traffic Control Devices for Streets and Highways", Illinois Supplement to the National Manual of Uniform Traffic Control Devices, these Special Provisions, and any special details and Highway Standards contained herein and in the plans.

Special attention is called to Articles 107.09 and 107.14 of the "Standard Specifications for Road and Bridge Construction and the following Highway Standards relating to traffic control:

701306 701311 701901 780001

In addition, the following Special Provision(s) will also govern traffic control for this project:

Construction and Maintenance Sign Supports
Traffic Control and Protection, Standard BLR 21
Reflective Sheeting on Channelizing Devices

The Contractor shall post the roadway with "LOOSE GRAVEL" and "SPEED LIMIT 35" signs in accordance with applicable articles of Section 700 of the Standard Specifications.

These signs shall be placed at the start of the work, near intersecting roadways and then at an average spacing of 0.5 mi (0.8 km).

The signs may be removed as soon as the sweeping operation has been completed.

The Contractor shall post and maintain the roadway with "NO PASSING ZONES NOT STRIPED NEXT MILES" signs until markings have been restored in accordance with Article 701.05(c).

This work shall be considered incidental to TRAFFIC CONTROL AND PROTECTION STANDARD 701306.

CONSTRUCTION AND MAINTENANCE SIGN SUPPORTS

Effective: April 21, 1981

Revised: November 1, 2006

This work shall be done according to Section 1106 of the Standard Specifications and Highway Standard 702001 except as herein modified.

All construction signs mounted on permanent support for use in temporary traffic control having an area of 10 square feet (1 square meter) or more shall be mounted on two 4 in x 4 in (100 mm x 100 mm) or two 4 in x 6 in (100 mm x 150 mm) wood posts.

Type A metal post (two for each sign) conforming to Article 1006.29 of the Standard Specifications may be used in lieu of wood posts. Type A metal posts used for these signs may be unfinished.

This work shall not be paid for separately; but shall be considered included in the cost of the traffic control items in this contract.

STATUS OF UTILITIES TO BE ADJUSTED

NO UTILITIES TO BE ADJUSTED

The above represents the best information of the Department and is only included for the convenience of the bidder. The applicable provisions of Sections 102, 103, and Articles 105.07 and 107.20 of the Standard Specifications for Road and Bridge Construction shall apply.

If any utility adjustment or removal has not been completed when required by the Contractor's operation, the Contractor should notify the Engineer in writing. A request for an extension of time will be considered to the extent the Contractor's operations were affected.

TRAFFIC CONTROL AND PROTECTION, STANDARD BLR 21

This work consists of installation and removal of traffic control as detailed on Standard BLR 21. In addition, the advance signing for the rest area and historical marker shall be covered until the work is complete, and then removed.

This work shall be paid for at the contract unit price lump sum for TRAFFIC CONTROL AND PROTECTION, STANDARD BLR 21.

TEMPORARY FLEXIBLE RAISED PAVEMENT MARKER

Description. This work shall consist of furnishing and installing a self adhesive "L" shaped temporary flexible raised pavement marker prior to placing a bituminous surface treatment, micro-surfacing, cape seal, or slurry seal, and removing a protective shield system after the treatment is applied.

Materials. Materials shall consist of a polyurethane device with a butyl rubber adhesive pad protected with a release paper. The reflective surface shall consist of a cube-corner micro prism reflective tape. The protective plastic cover shall be polyvinyl chloride. The marker body shall be made from approximately 1.5 mm (0.06 in.) thick polyurethane formed in an "L" shape. The base of the marker shall be approximately 100 mm (4 in.) wide by 28 mm (1.125 in.) long with a solid 3.2 mm (0.125 in.) thick butyl rubber adhesive pad protected with a release paper.

The vertical portion of the marker shall be approximately 100 mm (4 in.) wide by 50 mm (2 in.) high. A cube-corner microprism reflective tape material shall be placed horizontally along both sides at the top of the vertical section of the marker. The reflective material shall be recessed in an "I-Beam" design to protect the reflective material from aggregate. A clear flexible polyvinyl chloride plastic cover is to be attached to the vertical section of the marker with a heavy duty staple to cover the reflective material during surfacing operations. The flexible raised pavement marker must be readily visible at night when viewed with high beam automobile headlamps from a distance of at least 90 m (300 ft). The flexible raised pavement marker shall be approved by the Engineer by visual acceptance prior to use.

Construction Requirements

Application. Markers shall be placed every 12 m (40 ft) along the centerline/lane-to-lane line prior to surface treatment application. The marker color and location shall match the existing line color and location. Locations requiring additional markers at different spacings will be noted on the plans.

Basis of Payment. The cost of furnishing and installing the devices, and removing the protective shield shall be included in the cost of the surface treatment shown on the plans.

EQUIPMENT RENTAL RATES (BDE)

Effective: August 2, 2007

Revised: January 2, 2008

Replace the second and third paragraphs of Article 105.07(b)(4)a. of the Standard Specifications with the following:

"Equipment idled which cannot be used on other work, and which is authorized to standby on the project site by the Engineer, will be paid for according to Article 109.04(b)(4)."

Replace Article 109.04(b)(4) of the Standard Specifications with the following:

"(4) Equipment. Equipment used for extra work shall be authorized by the Engineer. The equipment shall be specifically described, be of suitable size and capacity for the work to be performed, and be in good operating condition. For such equipment, the Contractor will be paid as follows.

- a. Contractor Owned Equipment. Contractor owned equipment will be paid for by the hour using the applicable FHWA hourly rate from the "Equipment Watch Rental Rate Blue Book" (Blue Book) in effect when the force account work begins. The FHWA hourly rate is calculated as follows.

FHWA hourly rate = (monthly rate/176) x (model year adj.) x (Illinois adj.) + EOC

Where: EOC = Estimated Operating Costs per hour (from the Blue Book)

The time allowed will be the actual time the equipment is operating on the extra work. For the time required to move the equipment to and from the site of the extra work and any authorized idle (standby) time, payment will be made at the following hourly rate: 0.5 x (FHWA hourly rate - EOC).

All time allowed shall fall within the working hours authorized for the extra work.

The rates above include the cost of fuel, oil, lubrication, supplies, small tools, necessary attachments, repairs, overhaul and maintenance of any kind, depreciation, storage, overhead, profits, insurance, and all incidentals. The rates do not include labor.

The Contractor shall submit to the Engineer sufficient information for each piece of equipment and its attachments to enable the Engineer to determine the proper equipment category. If a rate is not established in the Blue Book for a particular piece of equipment, the Engineer will establish a rate for that piece of equipment that is consistent with its cost and use in the industry.

- b. Rented Equipment. Whenever it is necessary for the Contractor to rent equipment to perform extra work, the rental and transportation costs of the equipment plus five percent for overhead will be paid. In no case shall the rental rates exceed those of established distributors or equipment rental agencies.

All prices shall be agreed to in writing before the equipment is used.”

PAYMENTS TO SUBCONTRACTORS (BDE)

Effective: June 1, 2000

Revised: January 1, 2006

Federal regulations found at 49 CFR §26.29 mandate the Department to establish a contract clause to require Contractors to pay subcontractors for satisfactory performance of their subcontracts and to set the time for such payments.

State law also addresses the timing of payments to be made to subcontractors and material suppliers. Section 7 of the Prompt Payment Act, 30 ILCS 540/7, requires that when a Contractor receives any payment from the Department, the Contractor shall make corresponding, proportional payments to each subcontractor and material supplier performing work or supplying material within 15 calendar days after receipt of the Department payment. Section 7 of the Act further provides that interest in the amount of two percent per month, in addition to the payment due, shall be paid to any subcontractor or material supplier by the Contractor if the payment required by the Act is withheld or delayed without reasonable cause. The Act also provides that the time for payment required and the calculation of any interest due applies to transactions between subcontractors and lower-tier subcontractors and material suppliers throughout the contracting chain.

This Special Provision establishes the required federal contract clause, and adopts the 15 calendar day requirement of the State Prompt Payment Act for purposes of compliance with the federal regulation regarding payments to subcontractors. This contract is subject to the following payment obligations.

When progress payments are made to the Contractor according to Article 109.07 of the Standard Specifications, the Contractor shall make a corresponding payment to each subcontractor and material supplier in proportion to the work satisfactorily completed by each subcontractor and for the material supplied to perform any work of the contract. The proportionate amount of partial payment due to each subcontractor and material supplier throughout the contracting chain shall be determined by the quantities measured or otherwise determined as eligible for payment by the Department and included in the progress payment to the Contractor. Subcontractors and material suppliers shall be paid by the Contractor within 15 calendar days after the receipt of payment from the Department. The Contractor shall not hold retainage from the subcontractors. These obligations shall also apply to any payments made by subcontractors and material suppliers to their subcontractors and material suppliers; and to all payments made to lower tier subcontractors and material suppliers throughout the contracting chain. Any payment or portion of a payment subject to this provision may only be withheld from the subcontractor or material supplier to whom it is due for reasonable cause.

This Special Provision does not create any rights in favor of any subcontractor or material supplier against the State or authorize any cause of action against the State on account of any payment, nonpayment, delayed payment, or interest claimed by application of the State Prompt Payment Act. The Department will not approve any delay or postponement of the 15 day requirement except for reasonable cause shown after notice and hearing pursuant to Section 7(b) of the State Prompt Payment Act. State law creates other and additional remedies available to any subcontractor or material supplier, regardless of tier, who has not been paid for work properly performed or material furnished. These remedies are a lien against public funds set forth in Section 23(c) of the Mechanics Lien Act, 770 ILCS 60/23(c), and a recovery on the Contractor's payment bond according to the Public Construction Bond Act, 30 ILCS 550.

REFLECTIVE SHEETING ON CHANNELIZING DEVICES (BDE)

Effective: April 1, 2007

Revise the seventh paragraph of Article 1106.02 of the Standard Specifications to read:

“At the time of manufacturing, the retroreflective prismatic sheeting used on channelizing devices shall meet or exceed the initial minimum coefficient of retroreflection as specified in the following table. Measurements shall be conducted according to ASTM E 810, without averaging. Sheeting used on cones, drums and flexible delineators shall be reboundable as tested according to ASTM D 4956. Prestriped sheeting for rigid substrates on barricades shall be white and orange.

Initial Minimum Coefficient of Retroreflection candelas/foot candle/sq ft (candelas/lux/sq m) of material				
Observation Angle (deg.)	Entrance Angle (deg.)	White	Orange	Fluorescent Orange
0.2	-4	365	160	150
0.2	+30	175	80	70
0.5	-4	245	100	95
0.5	+30	100	50	40"

Revise the first sentence of the first paragraph of Article 1106.02(c) of the Standard Specifications to read:

“Barricades and vertical panels shall have alternating white and orange stripes sloping downward at 45 degrees toward the side on which traffic will pass.”

Revise the third sentence of the first paragraph of Article 1106.02(d) of the Standard Specifications to read:

“The bottom panels shall be 8 x 24 in. (200 x 600 mm) with alternating white and orange stripes sloping downward at 45 degrees toward the side on which traffic will pass.”

SUBCONTRACTOR MOBILIZATION PAYMENTS (BDE)

Effective: April 2, 2005

To account for the preparatory work and operations necessary for the movement of subcontractor personnel, equipment, supplies, and incidentals to the project site and for all other work or operations that must be performed or costs incurred when beginning work approved for subcontracting in accordance with Article 108.01 of the Standard Specifications, the Contractor shall make a mobilization payment to each subcontractor.

This mobilization payment shall be made at least 14 days prior to the subcontractor starting work. The amount paid shall be equal to 3 percent of the amount of the subcontract reported on form BC 260A submitted for the approval of the subcontractor's work.

This provision shall be incorporated directly or by reference into each subcontract approved by the Department.

WORKING DAYS (BDE)

Effective: January 1, 2002

The Contractor shall complete the work within **20** working days.

800/1111
2/9/2007
C:\p\projects\662592\7\1\plan\662592.dwg

STATE OF ILLINOIS

DEPARTMENT OF TRANSPORTATION

PLANS FOR PROPOSED

VARIOUS ROUTES

DIST. 8 SEAL COAT 2008-1

MADISON, BOND, AND

RANDOLPH COUNTIES

C-98-030-07

FOR INDEX OF SHEETS SEE SHEET NO. 2

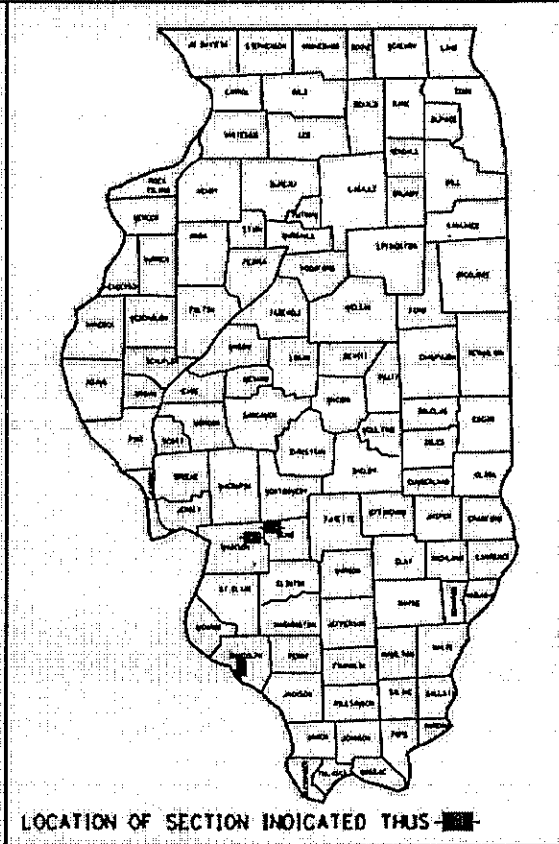

D-98-028-07

FOR LOCATION MAPS SEE SHEETS NO. 19-34

PROJECT LEADER: PATTI LEBEAU (618) 346-3179
SQUAD LEADER: CHERYL KEPLAR (618) 346-3186



GROSS LENGTH=10.79 MILES
NET LENGTH=10.57 MILES

STANDARDS

- 701306-01
- 701311-02
- 701901
- 780001-01
- BLR-21-7

JOINT UTILITY LOCATION
INFORMATION FOR EXCAVATIONS
PHONE: (800) 892-0123

SUBMITTED *May 21, 2007*

May C Lamo
DEPUTY DIRECTOR OF HIGHWAYS
REGION FIVE ENGINEER

PASSED _____

ENGINEER OF DESIGN & ENVIRONMENT

APPROVED _____

DIRECTOR, DIVISION OF HIGHWAYS

CONTRACT NO. 76A57

PRINTED BY THE AUTHORITY OF THE STATE OF ILLINOIS
PLOT DATE: 2/9/2007

INDEX OF SHEETS

TOTAL SHEETS	SHEET NO.
36	2
CONTRACT NO.: 76A57	

- 1. COVER SHEET, STANDARDS
- 2. INDEX OF SHEETS, ADT
- 3. GENERAL NOTES
- 4. SUMMARY OF QUANTITIES
- 5.-18. TYPICAL SECTIONS
- 19.-34. PLAN SHEETS
- 35.-36. SCHEDULES

Location	Location Description	2007 ADT	2027 ADT	MU	SU
1	I 70 Frontage Rd E of IL 4	75	75	N/A	N/A
2	I 70 Frontage Rd W of IL 4	225	275	N/A	N/A
3	I 55/70 Frontage Rd N of IL 162	3850	5800	30.00%	9.50%
4	I 55/70 Frontage Rd S of IL 162	2000	3000	14.20%	9.50%
5	Fort Kaskaskia Access Rd	350	425	N/A	N/A
6	Ellis Grove Rest Area	N/A	N/A	N/A	N/A
7	Ellis Grove Historical Marker	N/A	N/A	N/A	N/A
8	Old Rte 3 Runaround	N/A	N/A	N/A	N/A
9	Greenville Yard	N/A	N/A	N/A	N/A
10	Collinsville Rd from Troy Yard to Main St.	2800	3750	14.20%	9.50%
11	N Frontage Rd. between Pocahontas & Madison County	300	375	N/A	N/A
12	Troy Park-N-Ride	N/A	N/A	N/A	N/A
13	Lower Marine Road	225	225	N/A	N/A

INDEX OF SHEETS
ADT

VARIOUS ROUTES
DIST. 8 SEAL COAT 2008-1
MADISON, BOND, RANDOLPH COUNTIES

PLOT DATE: *DATE-TIME*

*DATE**
DATE-TIME
DGN-SPEC

TOTAL SHEETS	SHEET NO.
36	3
CONTRACT NO.: 76A57	

GENERAL NOTES

1. THE RATES OF APPLICATION SHOWN IN THE PLANS ARE NOMINAL RATES. DEVIATIONS WILL BE ALLOWED AS SPECIFIED BY THE ENGINEER AND IN ACCORDANCE WITH THE STANDARD SPECIFICATIONS.
2. UTILITIES INTERFERENCES ARE NOT ANTICIPATED ON THIS CONTRACT. SHOULD THIS PROVE TO BE OTHERWISE DURING ANY OF THE TIME OF THE OCCURRENCE, NO ADDITIONAL COST SHALL BE ADDED TO THE CONTRACT RESULTING FROM THE OCCURRENCE. THE JOINT UTILITY LOCATING INFORMATION FOR EXCAVATORS (J. U. L. I. E.) SYSTEM NUMBER IS (800) 892-0123.
3. THE CONTRACTOR SHALL WAIT A MINIMUM OF TWO (2) WEEKS, BUT NOT TO EXCEED THREE (3) WEEKS AFTER APPLICATION OF A-2 TREATMENT BEFORE INSTALLING PAINT PAVEMENT MARKING LINE.
4. THE STANDARDS AND REVISION NUMBERS LISTED SHALL APPLY TO THIS PROJECT.
5. FLAGMEN SHALL BE PRESENT DURING ALL CLOSURE HOURS INCLUDING LUNCH HOUR AND NO ADDITIONAL COMPENSATION WILL BE ALLOWED.
6. "ROAD CONSTRUCTION AHEAD" SIGNS SHALL BE PLACED AT THE BEGINNING AND END OF THE PROJECT PLUS THE INTERSECTING SIDE ROADS. THE SIGNS WILL BE CONSIDERED INCLUDED IN THE TRAFFIC CONTROL PAY ITEMS. ALL CONSTRUCTION SIGNS SHALL BE FLUORESCENT ORANGE.
7. "NO PASSING ZONES NOT STRIPED" SIGNS SHALL BE PLACED AT THE BEGINNING AND THE END OF THE PROJECT WHEN APPLICABLE. THIS SHALL BE INCLUDED IN THE PRICE OF THE TRAFFIC CONTROL PAY ITEMS.
8. THE RESIDENT ENGINEER SHALL LOCATE ALL NO PASSING ZONE LIMITS PRIOR TO ASPHALT WORK SO THE LIMITS CAN BE REPRODUCED UPON COMPLETION.
9. NO OVERNIGHT LANE CLOSURES WILL BE ALLOWED. THE 24 HOUR CURE FOR THE PRIME COAT (ART 403.09) WILL NOT BE REQUIRED. THE RESIDENT ENGINEER WILL APPROVE THE CURE PERIOD FOR THE PRIME COAT.
10. WHERE SECTION OR SUBSECTION MONUMENTS ARE ENCOUNTERED, THE ENGINEER SHALL BE NOTIFIED BEFORE SUCH MONUMENTS ARE REMOVED. THE CONTRACTOR SHALL PROTECT AND CAREFULLY PRESERVE ALL MONUMENTS UNTIL AN AUTHORIZED SURVEYOR OR AGENT HAS WITNESSED OR OTHERWISE REFERENCED THEIR LOCATION. THE CONTRACTOR SHALL BE RESESPONSIBLE FOR HAVING AN AUTHORIZED SURVEYOR REESTABLISH ANY SECTION OR SUBSECTION MONUMENTS DESTROYED BY HIS OPERATIONS.
11. ON EXISTING PAVEMENT WHICH MAY BE SUPERELEVATED, THE NEWA-2 TREATMENT SHALL BE BUILT WITH THE SAME SUPERELEVATION UNLESS NEW SUPERELEVATION RATES ARE GIVEN IN THE PLANS.
12. THE IDOT MAINTANENCE YARDS SHALL BE COMPLETED TO THE SATISFACTION OF THE MAINTANENCE FIELD TECHNICIAN BETWEEN THE HOURS OF 7:00 AM AND 3:30 PM.
13. THE IDOT MAINTANENCE TECHNICIAN SHALL MARK THE EXACT LOCATIONS WITHIN THE YARD TO RECEIVE THE A-2 BITUMINOUS TREATMENT. THE FIELD TECHNICIAN SHALL BE GIVEN ONE WEEK'S NOTICE IN ORDER TO MARK LOCATIONS AND COORDINATE MAINTANENCE ACTIVITY AT THE YARD.
GREENVILLE YARD - JASON ROECKENHAUS (618) 664-0982
TROY YARD - STAN RUDY (618) 667-0720
14. THE GRADATION OF AGGREGATE USED FOR THE BITUMINOUS SURFACE TREATMENT SHALL BE CA 16, CM 16, OR CA 20.
15. NO TYPICAL SECTION HAS BEEN PROVIDED FOR LOCATION 9, GREENVILLE . MAINTANENCE YARD.

COMMITMENTS
NONE

GENERAL NOTES

VARIOUS ROUTES
DIST. 8 SEAL COAT 2008-1
MADISON, BOND, RANDOLPH COUNTIES

PLOT DATE: -DATE-TIME-

VARIOUS ROUTES
DIST. 8 SEAL COAT 2008-1
MADISON, BOND, RANDOLPH COUNTIES

*DATE**
 DATE-TIME
 DGN-SPEC

SUMMARY OF QUANTITIES

100% STATE

F000

CODE NO	ITEM	UNIT	URBAN TOTAL QUANTITIES	CONSTRUCTION TYPE CODE		
				MADISON COUNTY	RANDOLPH COUNTY	BOND COUNTY
40300200	BITUMINOUS MATERIALS (PRIME COAT)	TON	16.9	1.2		15.7
40300400	BITUMINOUS MATERIALS (COVER AND SEAL COATS)	TON	335.5	128.1	73.6	133.8
40300500	COVER COAT AGGREGATE	TON	722.4	164.1	100	458.3
40300600	SEAL COAT AGGREGATE	TON	1575.1	713	403.8	458.3
67100100	MOBILIZATION	L SUM	1	0.5	0.2	0.3
70100460	TRAFFIC CONTROL AND PROTECTION, STANDARD BER 21	L SUM	1	0.5	0.2	0.3
70101830	TRAFFIC CONTROL AND PROTECTION, STANDARD BER 21	L SUM	1			
*78001110	PAINT PAVEMENT MARKING - LINE 4"	FOOT	38534	19460	19074	
*78001150	PAINT PAVEMENT MARKING - LINE 12"	FOOT	10	10		
78300200	RAISED REFLECTIVE PAVEMENT MARKER REMOVAL	EACH	99	99		

TOTAL SHEETS	SHEET NO.
36	4
CONTRACT NO.: 76A57	

SUMMARY OF QUANTITIES

VARIOUS ROUTES
 DIST. 8 SEAL COAT 2008-1
 MADISON, BOND, RANDOLPH COUNTIES

PLOT DATE: *DATE-TIME*

*Specialty Items

TOTAL SHEETS	SHEET NO.
36	5
CONTRACT NO.: 76A57	

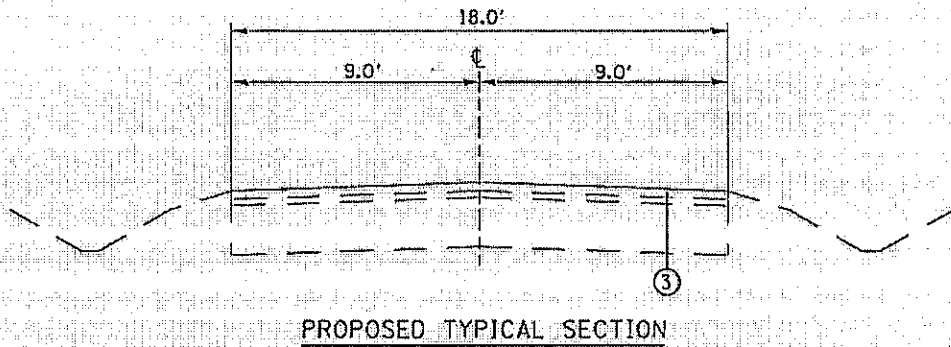
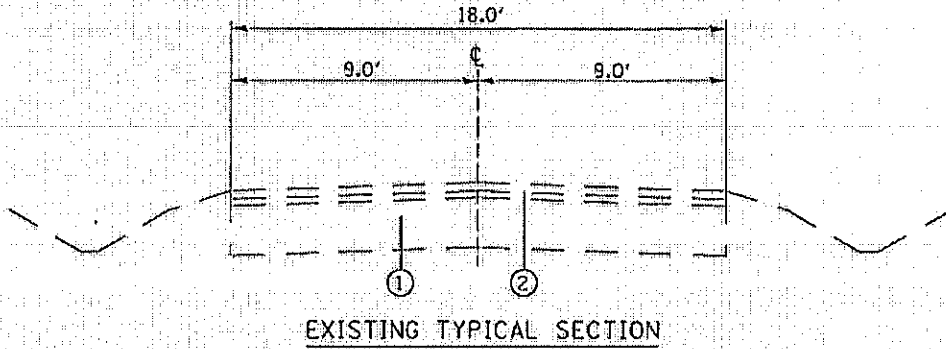

LEGEND

- ① EXISTING P.C.C. PAVEMENT
- ② EXISTING HOT MIX ASPHALT RESURFACING
- ③ PROPOSED BITUMINOUS SURFACE TREATMENT A-1
- ④ PROPOSED BITUMINOUS SURFACE TREATMENT A-2

TYPICAL SECTION
LOCATION 1 & 13
 I-70 FRONTAGE RD E OF IL 4
 LOWER MARINE ROAD
 VARIOUS ROUTES
 DIST. 8 SEAL COAT 2008-1
 MADISON, BOND, RANDOLPH COUNTIES

DATE: 11-11-08
 TIME: 10:00 AM
 DRAWN BY: JMM

PLOT DATE: 11-11-08

TOTAL SHEETS	SHEET NO.
36	6
CONTRACT NO.: 76A57	

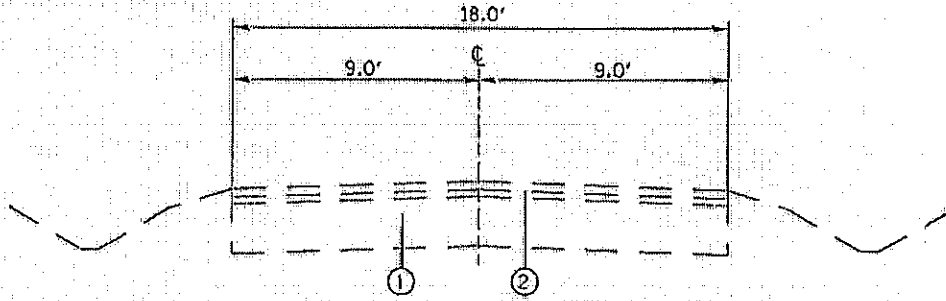

EXISTING TYPICAL SECTION

MI. STA. 0.000 TO STA. 0.600

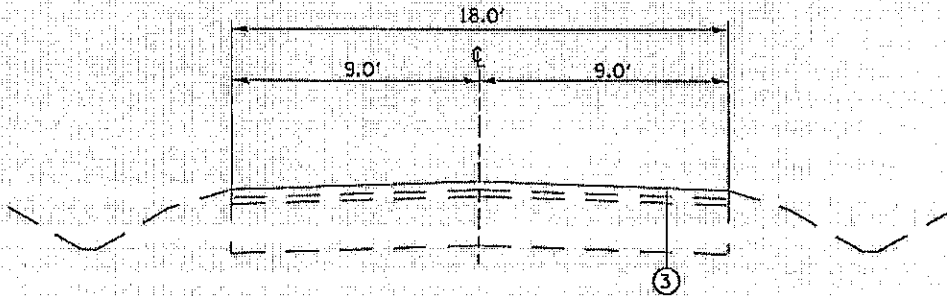

PROPOSED TYPICAL SECTION

MI. STA. 0.000 TO STA. 0.600

LEGEND

- ① EXISTING P.C.C. PAVEMENT
- ② EXISTING HOT MIX ASPHALT RESURFACING
- ③ PROPOSED BITUMINOUS SURFACE TREATMENT A-1
- ④ PROPOSED BITUMINOUS SURFACE TREATMENT A-2

**TYPICAL SECTION
LOCATION 2**

1-70 FRONTAGE RD W OF
IL 4 TO I-70
VARIOUS ROUTES
DIST. 8 SEAL COAT 2008-1
MADISON, BOND, RANDOLPH COUNTIES

PLOT DATE: --DATE-TIME

0041252
 0041252
 0041252

TOTAL SHEETS	SHEET NO.
36	7
CONTRACT NO.: 76A57	

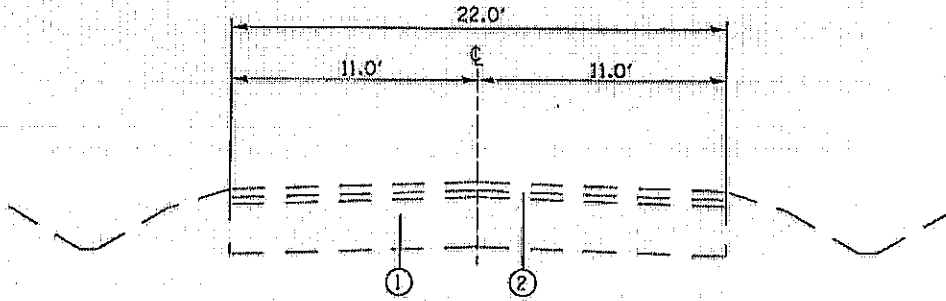

EXISTING TYPICAL SECTION

MI. STA. 0.020 TO STA. 0.900

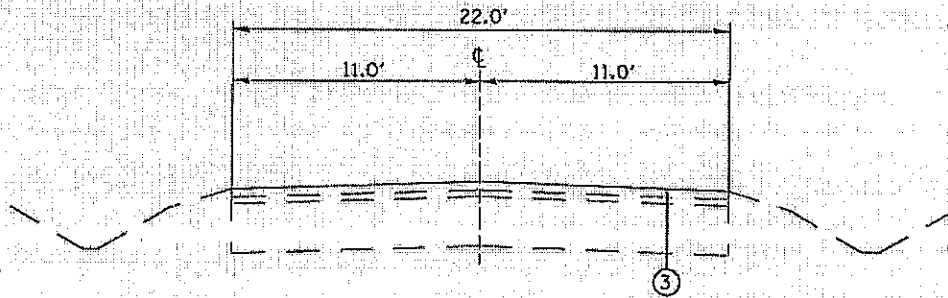

PROPOSED TYPICAL SECTION

MI. STA. 0.020 TO STA. 0.900

LEGEND

- ① EXISTING P.C.C. PAVEMENT
- ② EXISTING HOT MIX ASPHALT RESURFACING
- ③ PROPOSED BITUMINOUS SURFACE TREATMENT A-1
- ④ PROPOSED BITUMINOUS SURFACE TREATMENT A-2

**TYPICAL SECTION
LOCATION 3**

I-55/70 FRONTAGE RD N OF IL 162
VARIOUS ROUTES
DIST. 8 SEAL COAT 2008-1
MADISON, BOND, RANDOLPH COUNTIES

ISSUES
DATE-TIME
DRN-SPEC

PLOT DATE: DATE-TIME

TOTAL SHEETS	SHEET NO.
36	8
CONTRACT NO.: 76A57	

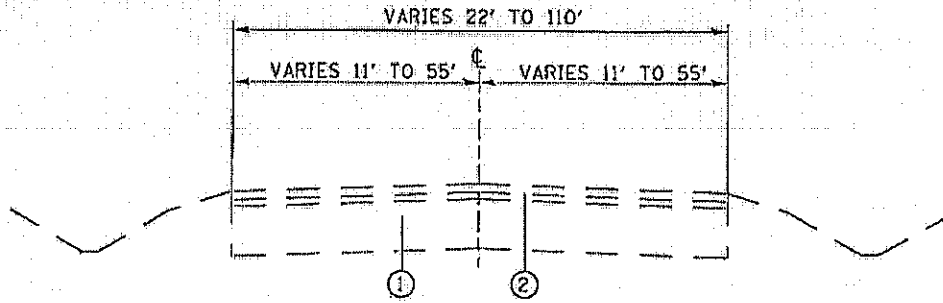

EXISTING TYPICAL SECTION

MI. STA. 0.000 TO STA. 0.020

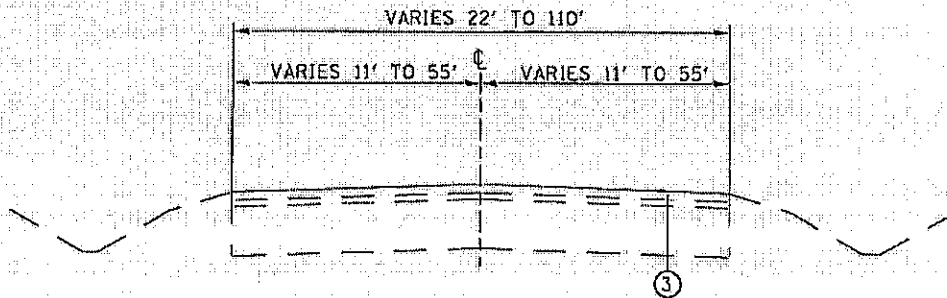

PROPOSED TYPICAL SECTION

MI. STA. 0.000 TO STA. 0.020

LEGEND

- ① EXISTING P.C.C. PAVEMENT
- ② EXISTING HOT MIX ASPHALT RESURFACING
- ③ PROPOSED BITUMINOUS SURFACE TREATMENT A-1
- ④ PROPOSED BITUMINOUS SURFACE TREATMENT A-2

TYPICAL SECTION
LOCATION 3 ENTRANCE
 I-55/70 FRONTAGE RD N OF IL 162
 VARIOUS ROUTES
 DIST. 8 SEAL COAT 2008-1
 MADISON, BOND, RANDOLPH COUNTIES

NOTES:
 DATE-TIME
 DRN-SPED

P.01 DATE: *DATE-TIME*

TOTAL SHEETS	SHEET NO.
36	9
CONTRACT NO.: 76A57	

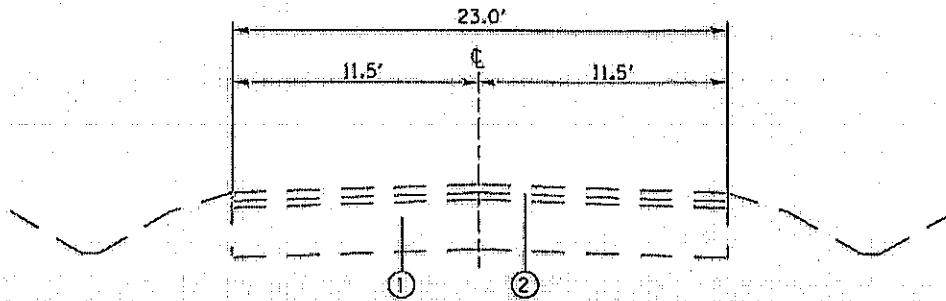

EXISTING TYPICAL SECTION

MI. STA. 0.010 TO STA. 0.600

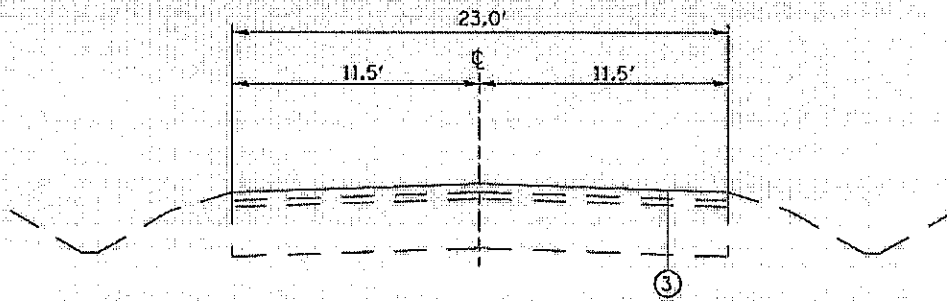

PROPOSED TYPICAL SECTION

MI. STA. 0.010 TO STA. 0.600

LEGEND

- ① EXISTING P.C.C. PAVEMENT
- ② EXISTING HOT MIX ASPHALT RESURFACING
- ③ PROPOSED BITUMINOUS SURFACE TREATMENT A-1
- ④ PROPOSED BITUMINOUS SURFACE TREATMENT A-2

**TYPICAL SECTION
LOCATION 4**

I-55/70 FRONTAGE RD S OF IL 162
VARIOUS ROUTES
DIST. 8 SEAL COAT 2008-1
MADISON, BOND, RANDOLPH COUNTIES

DATE: 11/11/08
DATE-TIME: 11:00 AM
CON-SPEC: 11/11/08

DATE: 11/11/08

TOTAL SHEETS	SHEET NO.
36	10
CONTRACT NO.: 76A57	

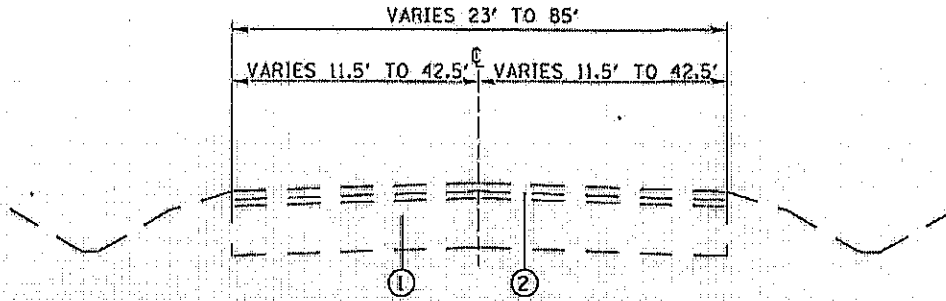

EXISTING TYPICAL SECTION

MI. STA. 0.000 TO STA. 0.010

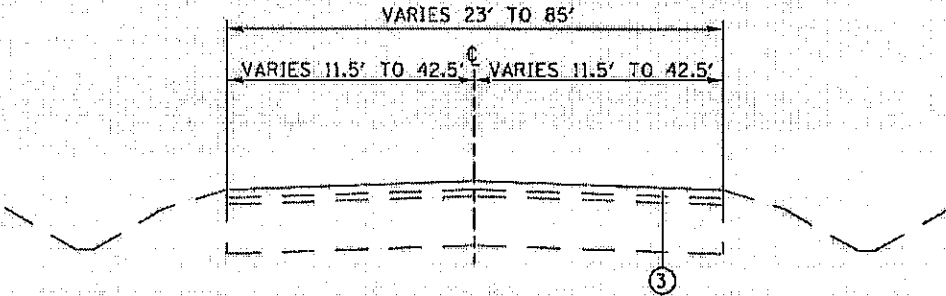

PROPOSED TYPICAL SECTION

MI. STA. 0.000 TO STA. 0.010

LEGEND

- ① EXISTING P.C.C. PAVEMENT
- ② EXISTING HOT MIX ASPHALT RESURFACING
- ③ PROPOSED BITUMINOUS SURFACE TREATMENT A-1
- ④ PROPOSED BITUMINOUS SURFACE TREATMENT A-2

TYPICAL SECTION
LOCATION 4 ENTRANCE
 I-55/70 FRONTAGE RD S OF IL 162
 VARIOUS ROUTES
 DIST. 8 SEAL COAT 2008-1
 MADISON, BOND, RANDOLPH COUNTIES
 PLOT DATE: *DATE* TIME

#DATE#
 DATE TIME
 DRAW#

TOTAL SHEETS	SHEET NO.
36	11
CONTRACT NO. 76A5T	

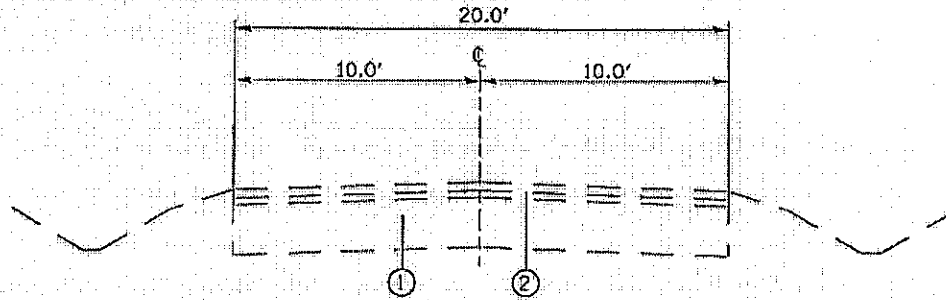

EXISTING TYPICAL SECTION

MI. STA. 0.000 TO STA. 1.750

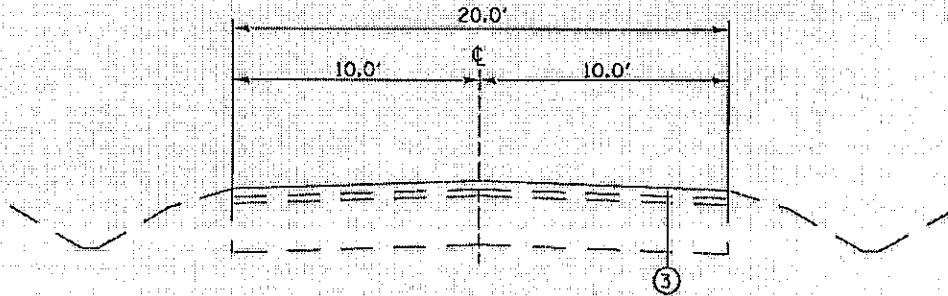

PROPOSED TYPICAL SECTION

MI. STA. 0.000 TO STA. 1.750

LEGEND

- ① EXISTING P.C.C. PAVEMENT
- ② EXISTING HOT MIX ASPHALT RESURFACING
- ③ PROPOSED BITUMINOUS SURFACE TREATMENT A-1
- ④ PROPOSED BITUMINOUS SURFACE TREATMENT A-2

**TYPICAL SECTION
LOCATION 5**

FORT KASKASKIA ACCESS RD.
VARIOUS ROUTES
DIST. 8 SEAL COAT 2008-1
MADISON, BOND, RANDOLPH COUNTIES

DATE-TIME
CON-SPEC

PLOT DATE: *DATE-TIME*

TOTAL SHEETS	SHEET NO.
36	12
CONTRACT NO.: 76A57	

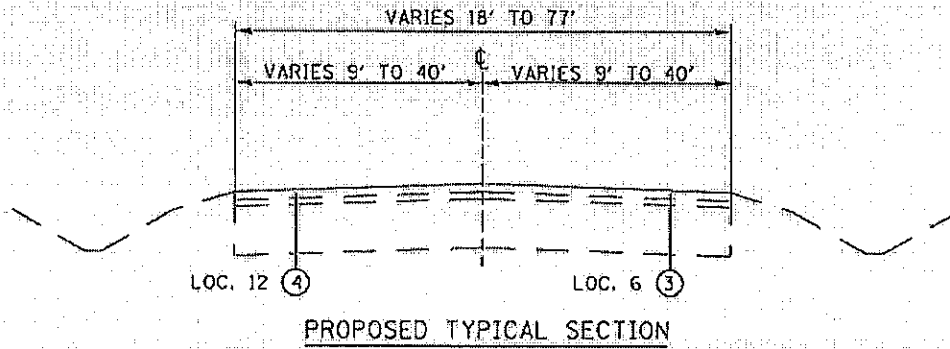
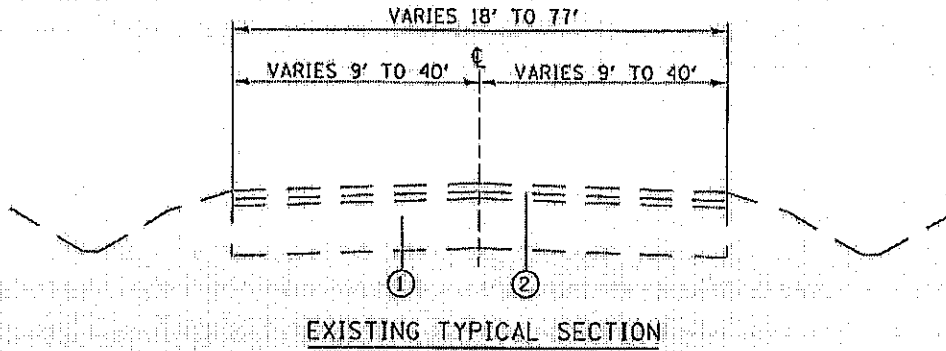

LEGEND

- ① EXISTING P.C.C. PAVEMENT
- ② EXISTING HOT MIX ASPHALT RESURFACING
- ③ PROPOSED BITUMINOUS SURFACE TREATMENT A-1
- ④ PROPOSED BITUMINOUS SURFACE TREATMENT A-2

TYPICAL SECTION
LOCATION 6 & 12
ELLIS GROVE REST AREA
TROY PARK-N-RIDE
VARIOUS ROUTES
DIST. 8 SEAL COAT 2008-1
MADISON, BOND, RANDOLPH COUNTIES
 PLOT DATE: *DATE-TIME*

DATE-TIME
 DATE-TIME
 DATE-TIME

TOTAL SHEETS	SHEET NO.
36	13
CONTRACT NO.: 76A57	

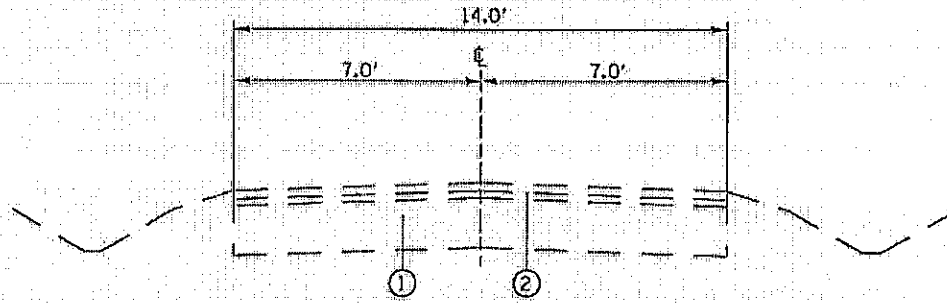

EXISTING TYPICAL SECTION

MI. STA. 0.000 TO STA. 0.035

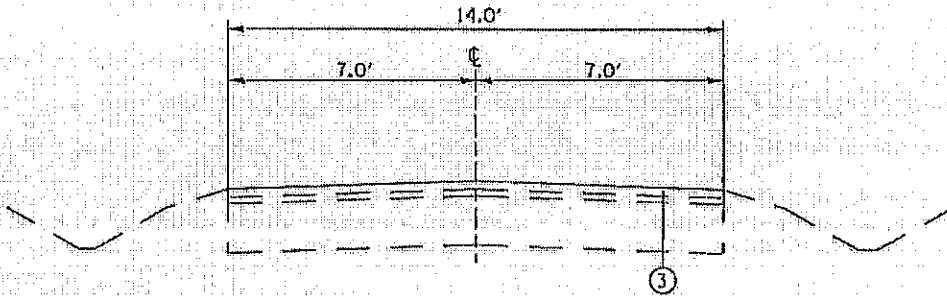

PROPOSED TYPICAL SECTION

MI. STA. 0.000 TO STA. 0.035

LEGEND

- ① EXISTING P.C.C. PAVEMENT
- ② EXISTING HOT MIX ASPHALT RESURFACING
- ③ PROPOSED BITUMINOUS SURFACE TREATMENT A-1
- ④ PROPOSED BITUMINOUS SURFACE TREATMENT A-2

**TYPICAL SECTION
LOCATION 7**

ELLIS GROVE HISTORICAL MARKER
VARIOUS ROUTES
DIST. 8 SEAL COAT 2008-1
MADISON, BOND, RANDOLPH COUNTIES

DATE: *DATE-TIME*
CON. SPEED

PLOT DATE: *DATE-TIME*

TOTAL SHEETS	SHEET NO.
36	14
CONTRACT NO.: 76A57	

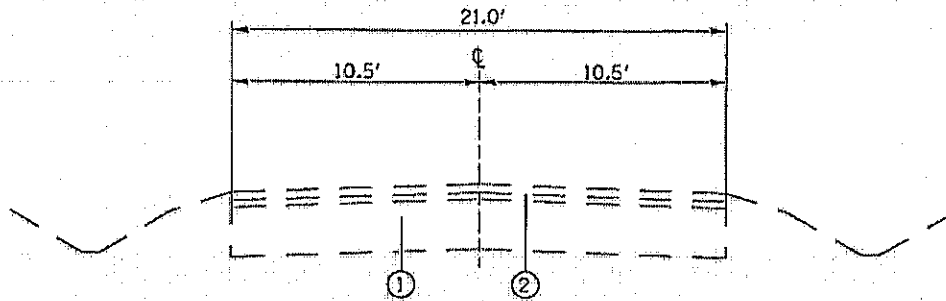

EXISTING TYPICAL SECTION

MI. STA. 0.000 TO STA. .400

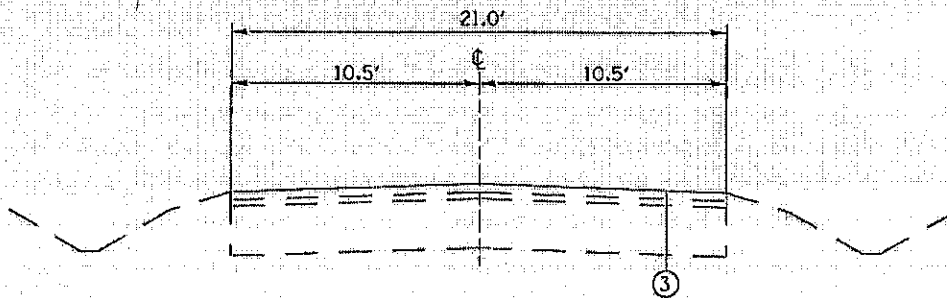

PROPOSED TYPICAL SECTION

MI. STA. 0.000 TO STA. .400

LEGEND

- ① EXISTING P.C.C. PAVEMENT
- ② EXISTING HOT MIX ASPHALT RESURFACING
- ③ PROPOSED BITUMINOUS SURFACE TREATMENT A-1
- ④ PROPOSED BITUMINOUS SURFACE TREATMENT A-2

**TYPICAL SECTION
LOCATION 8**
 OLD RTE 3 RUNAROUND
 VARIOUS ROUTES
 DIST. 8 SEAL COAT 2008-1
 MADISON, BOND, RANDOLPH COUNTIES

PLDT DATE: +DATE-TIME+

DATE: +DATE-TIME+
 2008-08-01

TOTAL SHEETS	SHEET NO.
36	15
CONTRACT NO.: 76A57	

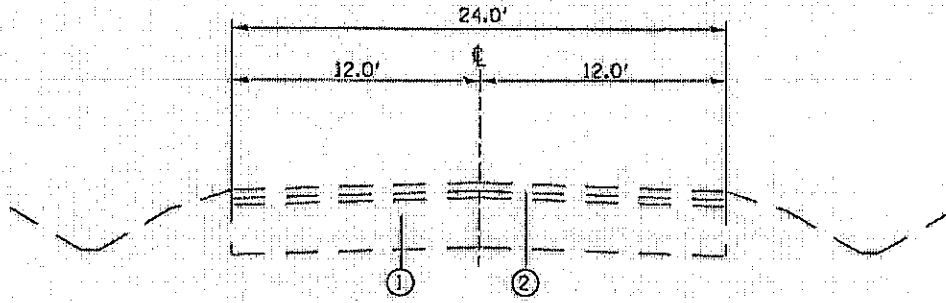

EXISTING TYPICAL SECTION

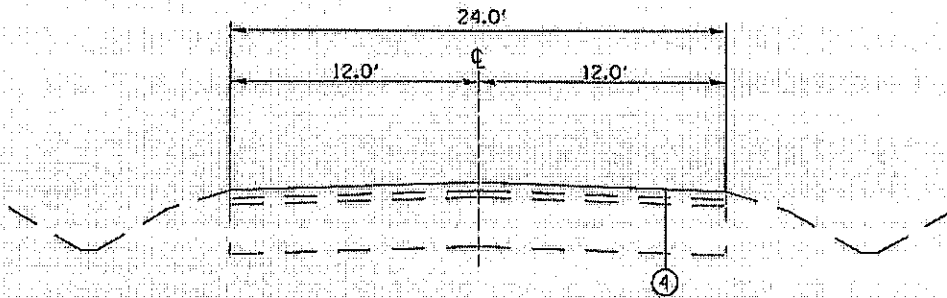

PROPOSED TYPICAL SECTION

LEGEND

- ① EXISTING P.C.C. PAVEMENT
- ② EXISTING HOT MIX ASPHALT RESURFACING
- ③ PROPOSED BITUMINOUS SURFACE TREATMENT A-1
- ④ PROPOSED BITUMINOUS SURFACE TREATMENT A-2

TYPICAL SECTION
LOCATION 10A
 TROY YARD
 VARIOUS ROUTES
 DIST. 8 SEAL COAT 2008-1
 MADISON, BOND, RANDOLPH COUNTIES
 PLOT DATE: -DATE-TIME-

SURVEYED BY: JIMMY J. BROWN
 DRAWN BY: JIMMY J. BROWN

TOTAL SHEETS	SHEET NO.
36	16
CONTRACT NO.: 76A57	

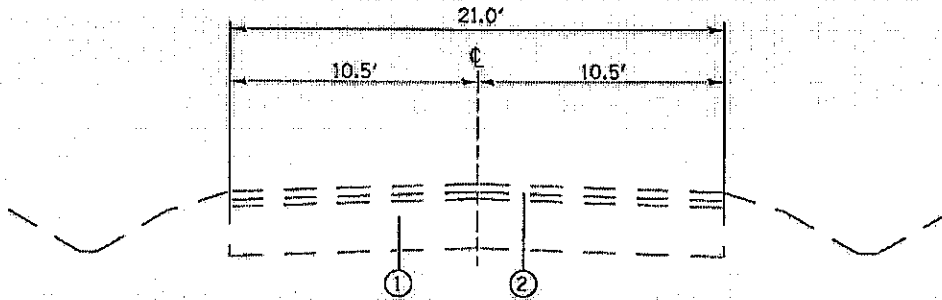

EXISTING TYPICAL SECTION

MI. STA. 0.040 TO STA. 0.150

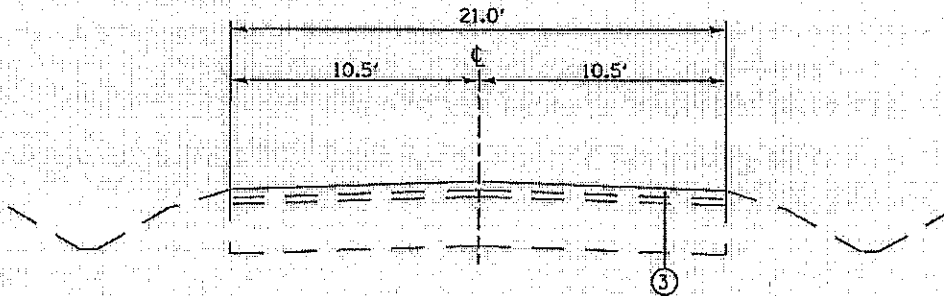

PROPOSED TYPICAL SECTION

MI. STA. 0.040 TO STA. 0.150

LEGEND

- ① EXISTING P.C.C. PAVEMENT
- ② EXISTING HOT MIX ASPHALT RESURFACING
- ③ PROPOSED BITUMINOUS SURFACE TREATMENT A-1
- ④ PROPOSED BITUMINOUS SURFACE TREATMENT A-2

**TYPICAL SECTION
LOCATION 10B**

FRONTAGE RD TO WIDENING OMISSION
VARIOUS ROUTES
DIST. 8 SEAL COAT 2008-1
MADISON, BOND, RANDOLPH COUNTIES

SOURCE**
DATE-TIME*
DGN-SPEC*

PLOT DATE: *DATE-TIME*

TOTAL SHEETS	SHEET NO.
36	17
CONTRACT NO.: 76A57	

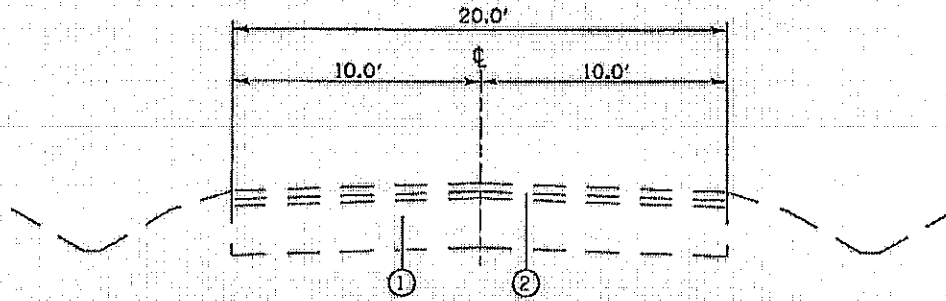

EXISTING TYPICAL SECTION

MI. STA. 0.370 TO STA. 1.820

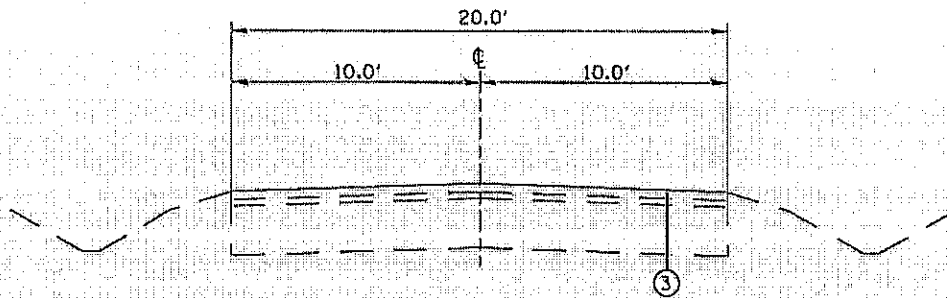

PROPOSED TYPICAL SECTION

MI. STA. 0.370 TO STA. 1.820

LEGEND

- ① EXISTING P.C.C. PAVEMENT
- ② EXISTING HOT MIX ASPHALT RESURFACING
- ③ PROPOSED BITUMINOUS SURFACE TREATMENT A-1
- ④ PROPOSED BITUMINOUS SURFACE TREATMENT A-2

**TYPICAL SECTION
LOCATION 10C**
 WIDENING OMISSION TO MAIN ST.
 VARIOUS ROUTES
 DIST. 8 SEAL COAT 2008-1
 MADISON, BOND, RANDOLPH COUNTIES
 PLOT DATE: DATE-TIME

DATE-TIME
DATE-TIME
DATE-TIME

TOTAL SHEETS	SHEET NO.
36	18
CONTRACT NO.: 76A57	

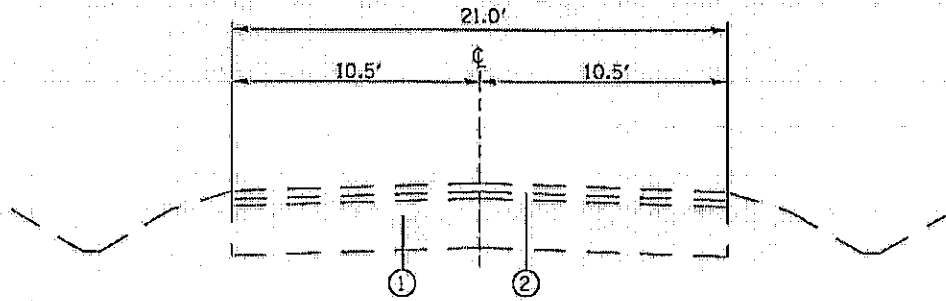

EXISTING TYPICAL SECTION

MI. STA. 0.000 TO STA. 3.720

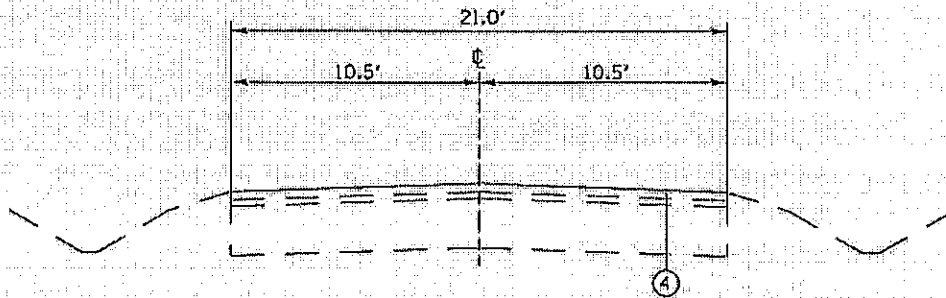

PROPOSED TYPICAL SECTION

MI. STA. 0.000 TO STA. 3.720

LEGEND

- ① EXISTING P.C.C. PAVEMENT
- ② EXISTING HOT MIX ASPHALT RESURFACING
- ③ PROPOSED BITUMINOUS SURFACE TREATMENT A-1
- ④ PROPOSED BITUMINOUS SURFACE TREATMENT A-2

TYPICAL SECTION
LOCATION 11
 N FRONTAGE RD BETWEEN
 POCAHONTAS & MADISON COUNTY
 VARIOUS ROUTES
 DIST. 8 SEAL COAT 2008-1
 MADISON, BOND, RANDOLPH COUNTIES
 PLOT DATE: *DATE-TIME*

DATE-TIME
 DATE-TIME
 DATE-TIME

FAI 70 NORTH FRONTAGE RD, EAST OF IL 4.

TOTAL SHEETS	SHEET NO.
36	19
CONTRACT NO.: 76A57	

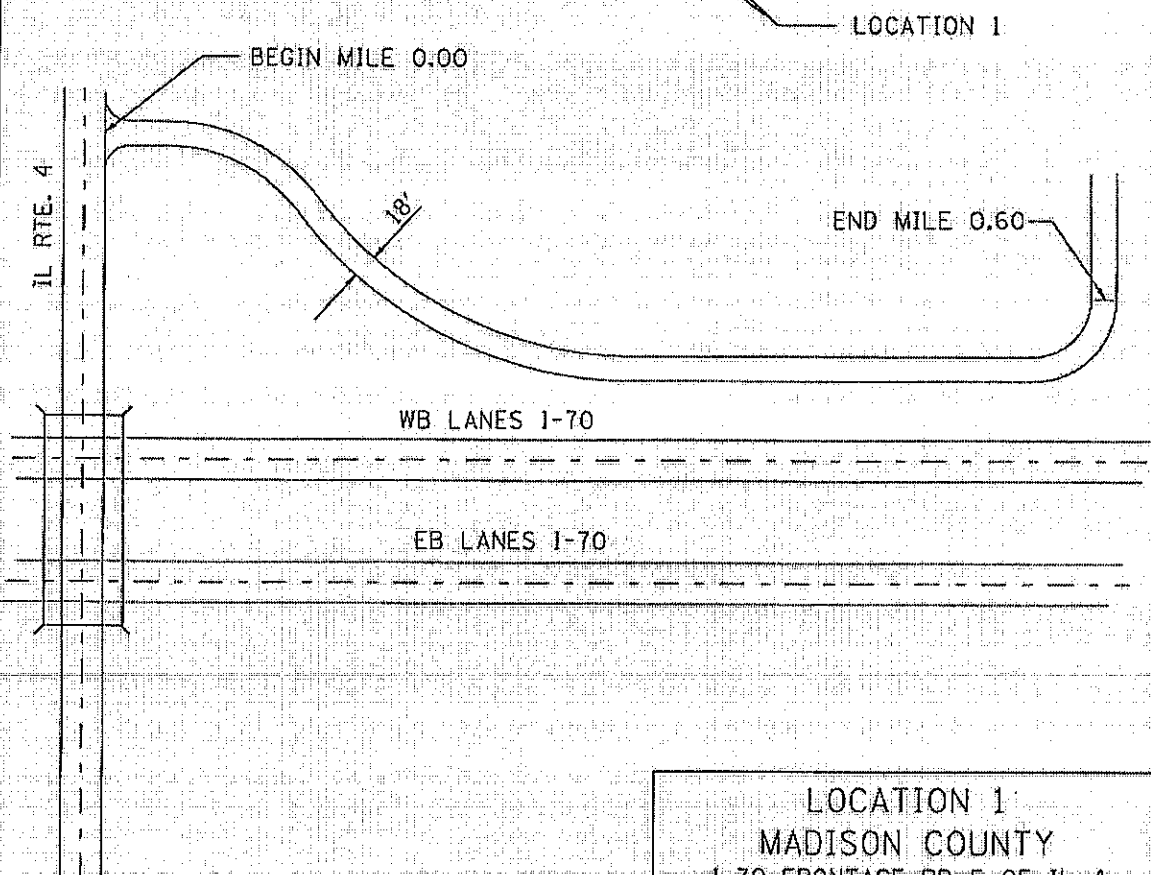
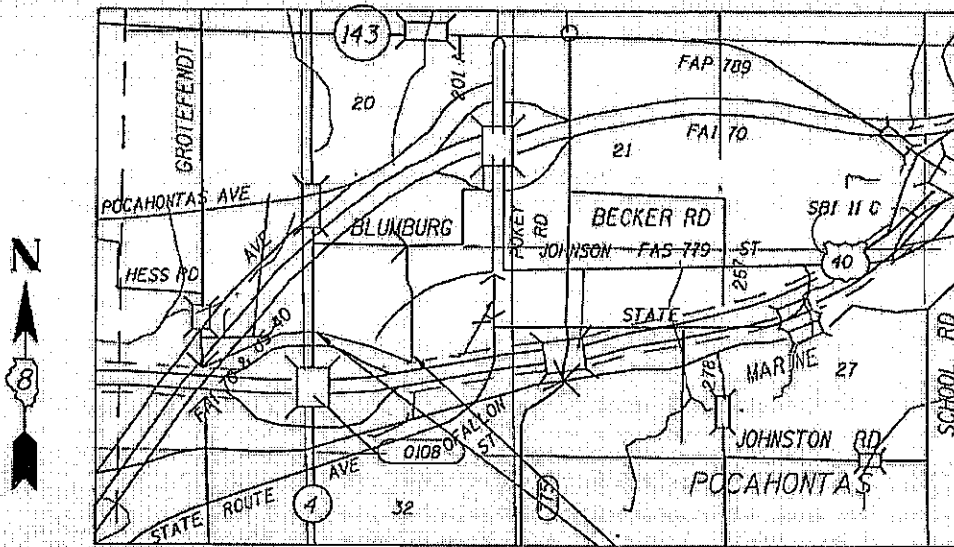

LOCATION 1
 MADISON COUNTY
 I-70 FRONTAGE RD E OF IL 4
 VARIOUS ROUTES
 DIST. 8 SEAL COAT 2008-1
 MADISON, BOND, RANDOLPH COUNTIES
 PLOT DATE: *DATE-TIME*

DATE
 TIME
 DRAW
 SHEET

FAI 70 NORTH FRONTAGE RD, WEST OF IL 4.

TOTAL SHEETS	SHEET NO.
36	20
CONTRACT NO. 16A57	

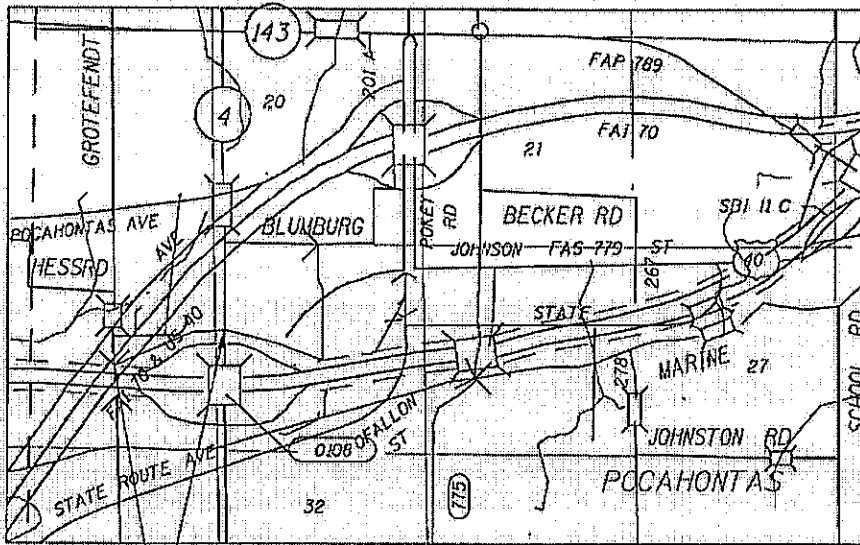

LOCATION 2

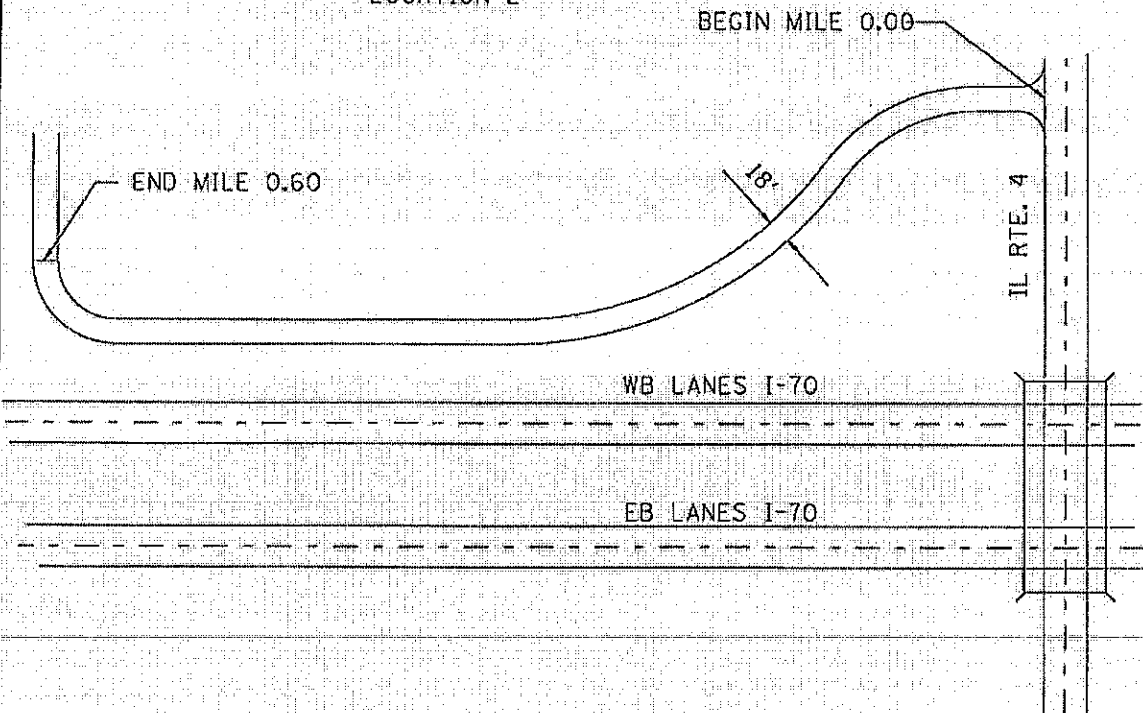

LOCATION 2
 MADISON COUNTY
 I-70 FRONTAGE RD W OF
 IL 4 TO I-70
 VARIOUS ROUTES
 DIST. 8 SEAL COAT 2008-1
 MADISON, BOND, RANDOLPH COUNTIES
 PLOT DATE: *DATE-TIME*

DATE-TIME
 DATE-TIME
 DATE-TIME

55/70 EAST FRONTAGE RD, NORTH OF IL 162.

TOTAL SHEETS	SHEET NO.
36	21
CONTRACT NO.: 76A57	

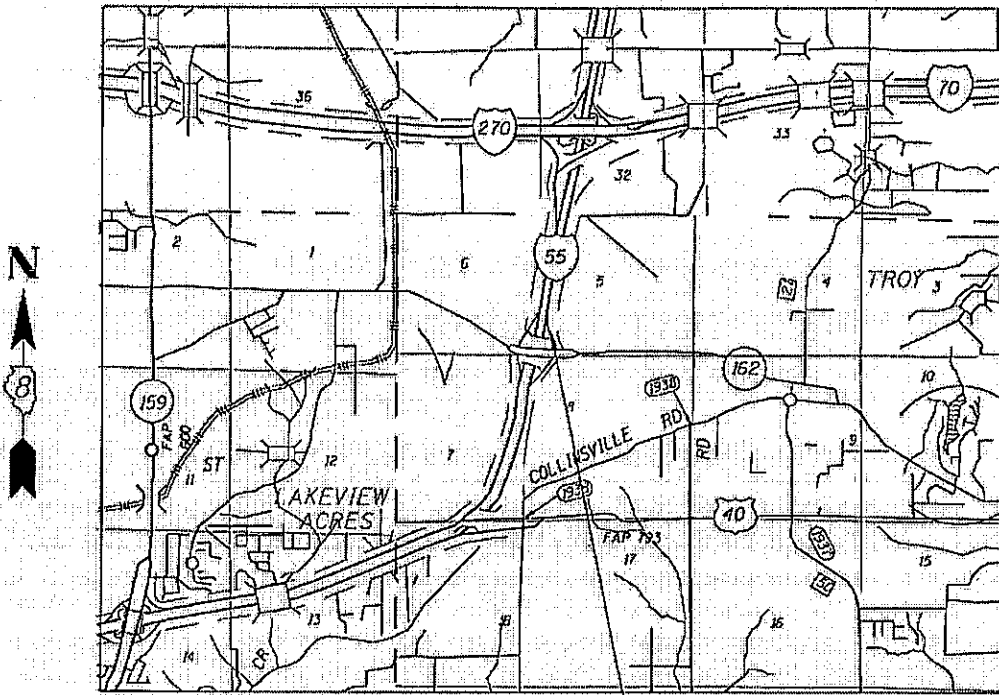

LOCATION 3

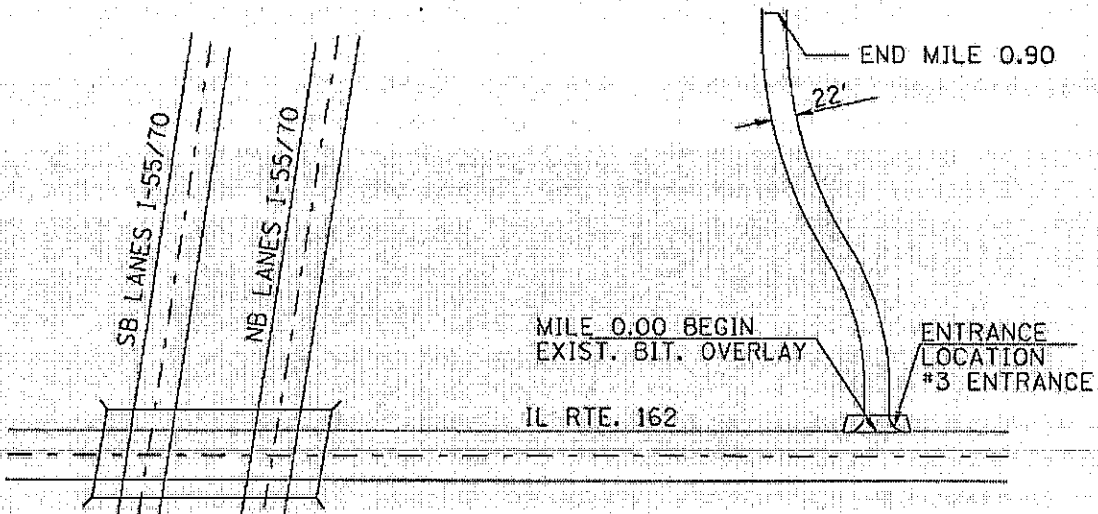

LOCATION 3
 MADISON COUNTY
 I-55/70 FRONTAGE RD N OF IL 162
 VARIOUS ROUTES
 DIST. 8 SEAL COAT 2008-1
 MADISON, BOND, RANDOLPH COUNTIES
 PLOT DATE: *DATE-TIME*

40-TEXT
 DATE-TIME
 BOND-SPEC

55/70 EAST FRONTAGE RD, SOUTH OF IL 162.

TOTAL SHEETS	SHEET NO.
36	22
CONTRACT NO.: 76A57	

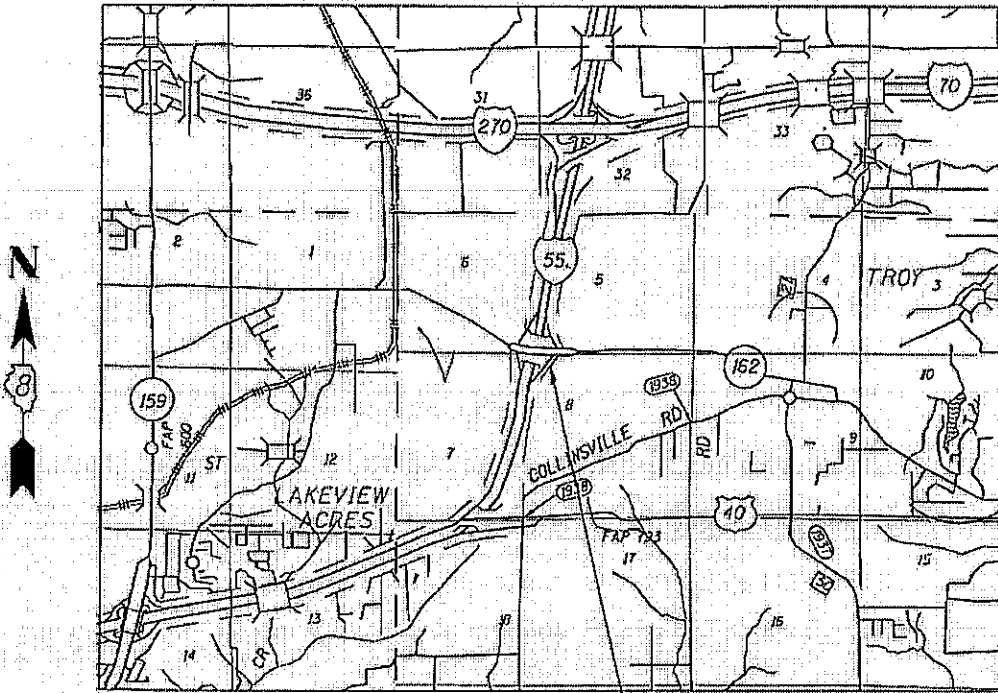

LOCATION 4

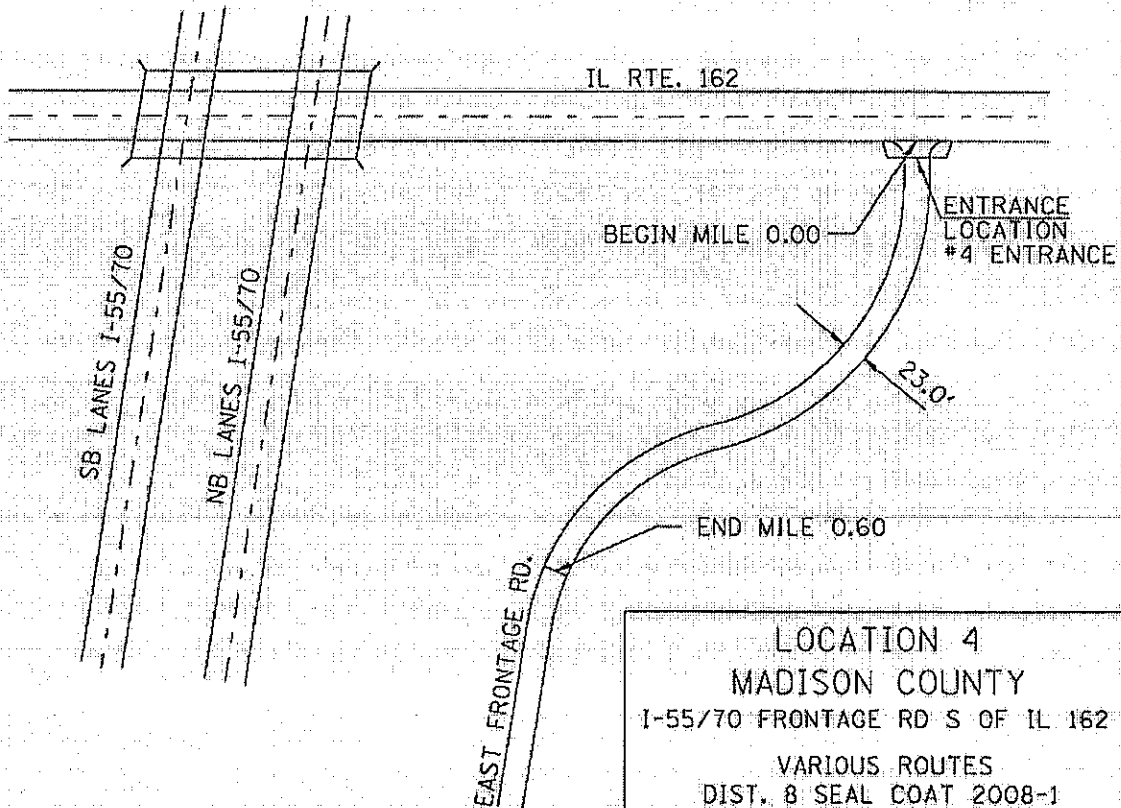

LOCATION 4
 MADISON COUNTY
 I-55/70 FRONTAGE RD S OF IL 162
 VARIOUS ROUTES
 DIST. 8 SEAL COAT 2008-1
 MADISON, BOND, RANDOLPH COUNTIES
 PLOT DATE: *DATE-TIME*

DATE-TIME
 DATE-TIME
 CON-SPEC

TOTAL SHEETS	SHEET NO.
36	23
CONTRACT NO. 76A57	

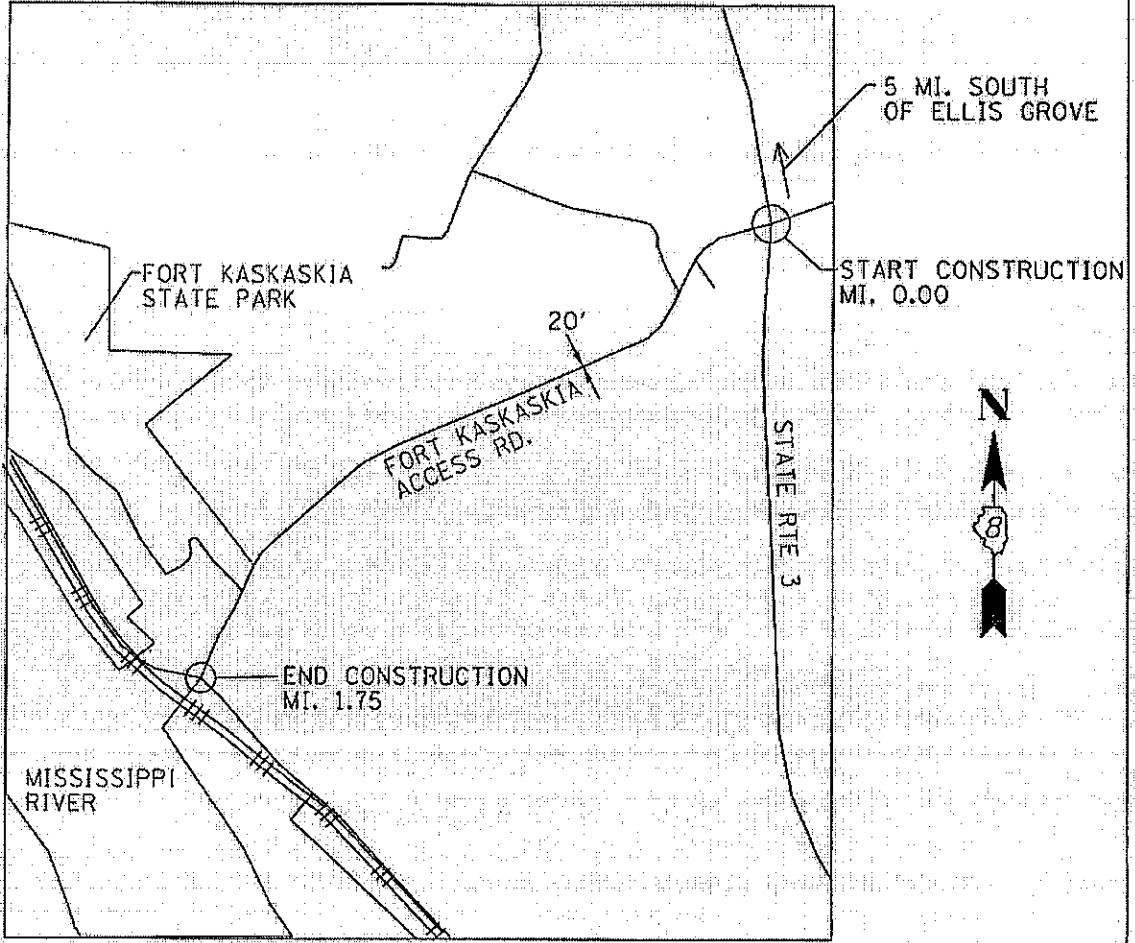

LOCATION 5
 RANDOLPH COUNTY
 FORT KASKASKIA ACCESS RD.
 VARIOUS ROUTES
 DIST. 8 SEAL COAT 2008-1
 MADISON, BOND, RANDOLPH COUNTIES
 PLOT DATE: *DATE-TIME*

DATE
 DATE-TIME
 DIR-SPEC

TOTAL SHEETS	SHEET NO.
36	24
CONTRACT NO.: 76A57	

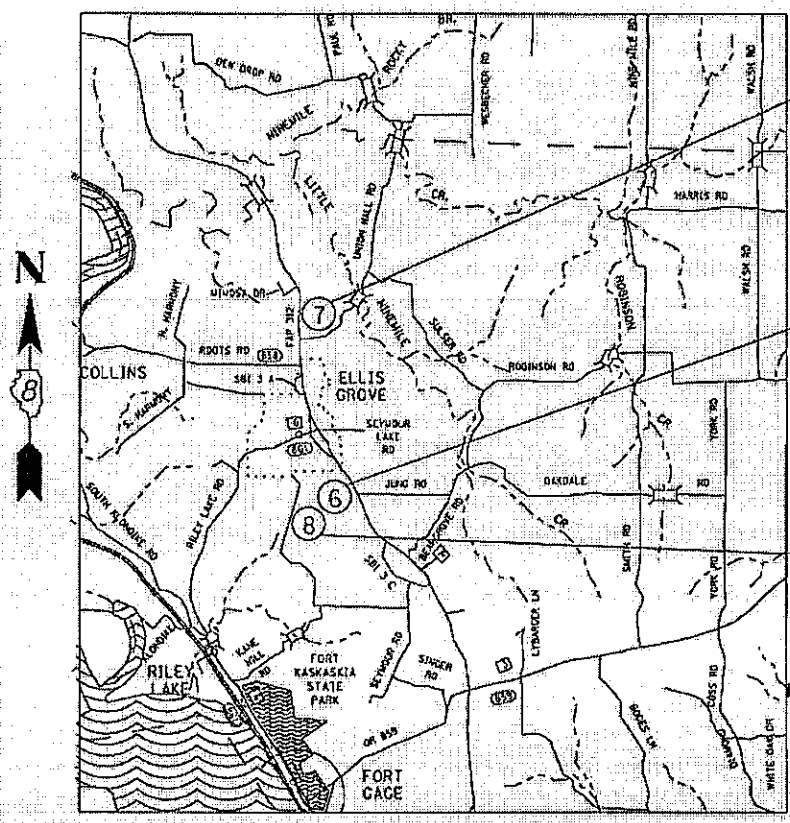

LOCATION 7
 ELLIS GROVE
 HISTORICAL MARKER
 ≈ 2 MI. N ELLIS GROVE
 EAST SIDE OF IL 3

LOCATION 6
 ELLIS GROVE REST AREA
 ≈ 2 MI. S ELLIS GROVE
 WEST SIDE OF IL 3

LOCATION 8
 OLD RTE 3 RUNAROUND
 ROAD THAT ARCS AROUND
 REST AREA

LOCATION 6,7,8
 RANDOLPH COUNTY

VARIOUS ROUTES
 DIST. 8 SEAL COAT 2008-1
 MADISON, BOND, RANDOLPH COUNTIES

PLOT DATE: •DATE-TIME•

•DATE-TIME•
 •DATE-TIME•
 •CON-SPEC•



TOTAL SHEETS	SHEET NO.
36	25
CONTRACT NO.: 76A57	

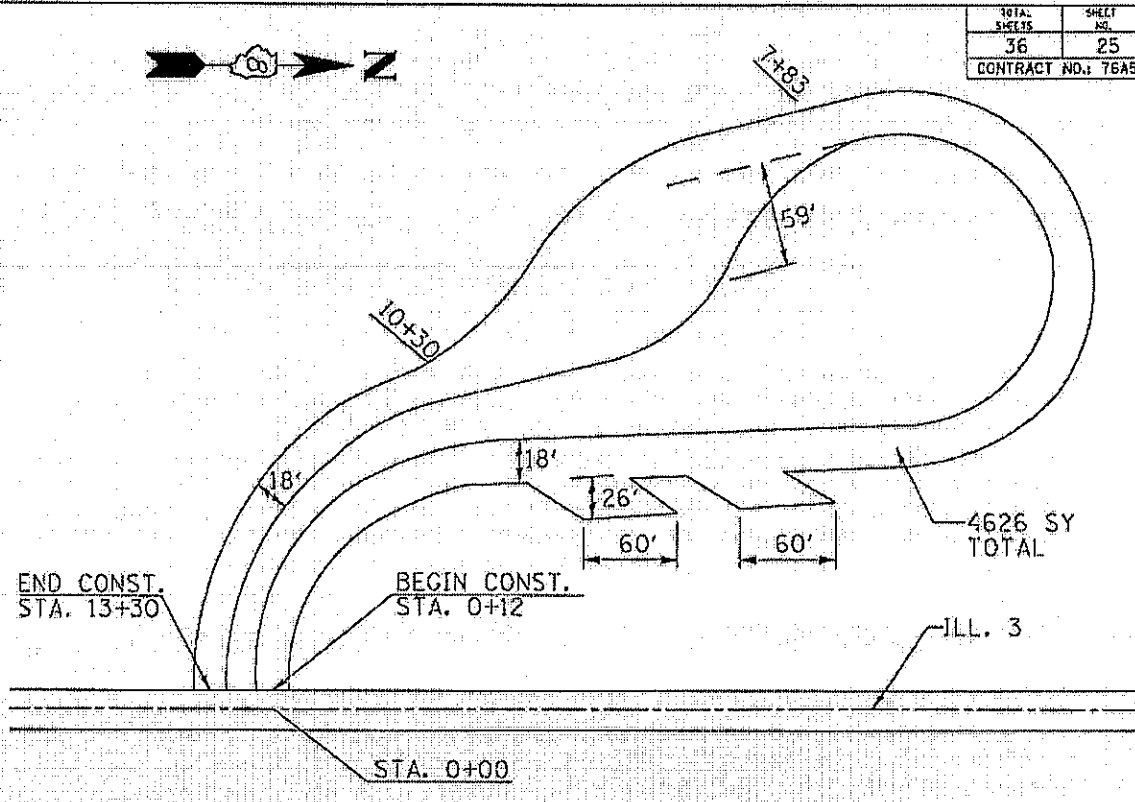

LOCATION 6
ELLIS GROVE REST AREA
RANDOLPH COUNTY
VARIOUS ROUTES
DIST. 8 SEAL COAT 2008-1
MADISON, BOND, RANDOLPH COUNTIES
PLOT DATE: #DATE-33#E-

#DATE##
#DATE-33#E-
#DCN-SPEC#



TOTAL SHEETS	SHEET NO.
36	26
CONTRACT NO. 76A57	

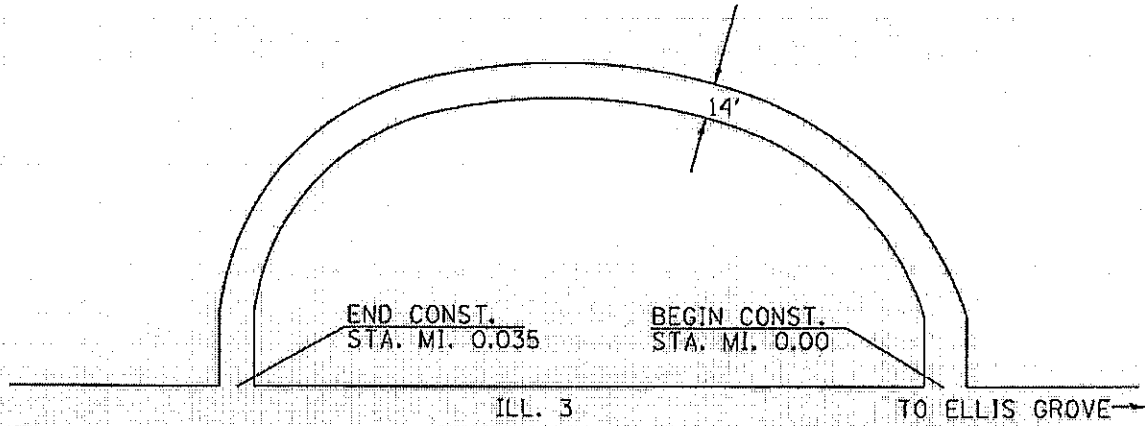

LOCATION 7

LOCATION 7-ELLIS GROVE
HISTORICAL MARKER
RANDOLPH COUNTY
VARIOUS ROUTES
DIST. 8 SEAL COAT 2008-1
MADISON, BOND, RANDOLPH COUNTIES
PLOT DATE: •DATE•TIME•

•DATE•
•TIME•
•DATE•
•TIME•

TOTAL SHEETS	SHEET NO.
36	27
CONTRACT NO.: 76A5T	

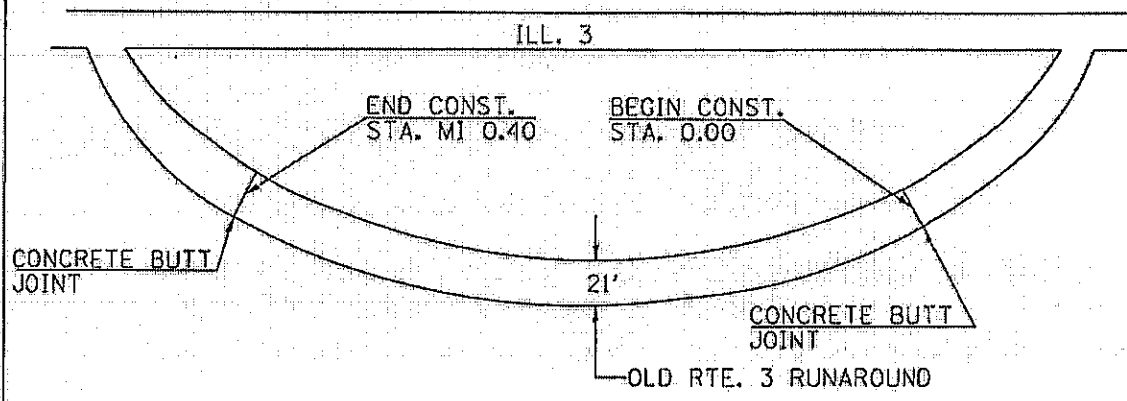
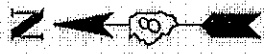

LOCATION 8

LOCATION 8
 OLD RTE 3 TURNAROUND
 RANDOLPH COUNTY
 VARIOUS ROUTES
 DIST. 8 SEAL COAT 2008-1
 MADISON, BOND, RANDOLPH COUNTIES
 PLOT DATE: *DATE* TIME *

DATE
 DATE TIME
 CON-SPEC

TOTAL SHEETS	SHEET NO.
36	28
CONTRACT NO.: 76A57	

GREENVILLE MAINTENANCE YARD

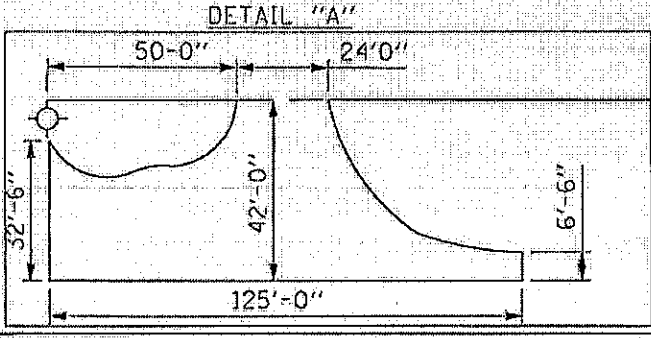
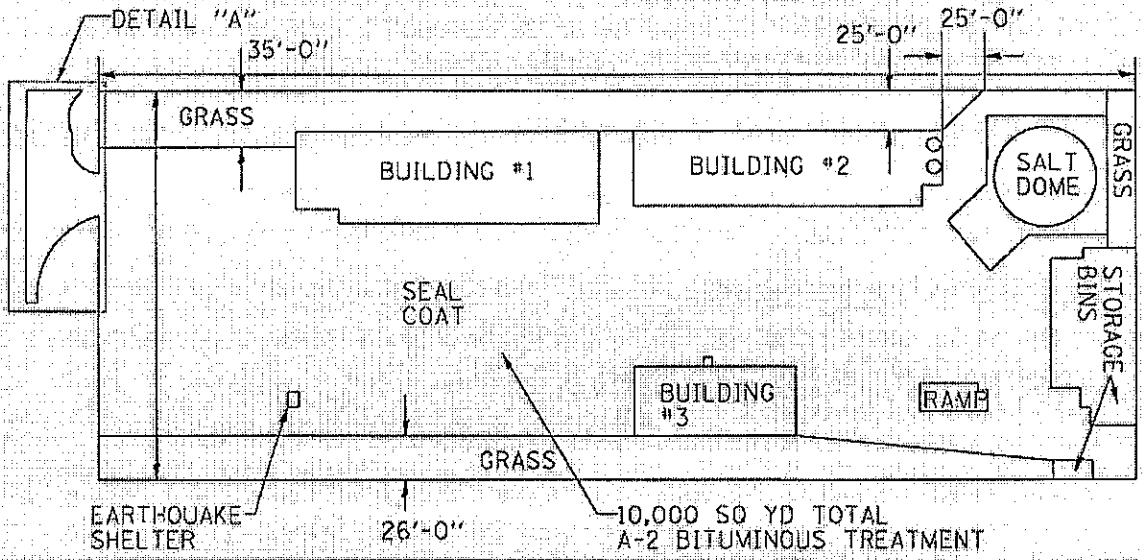
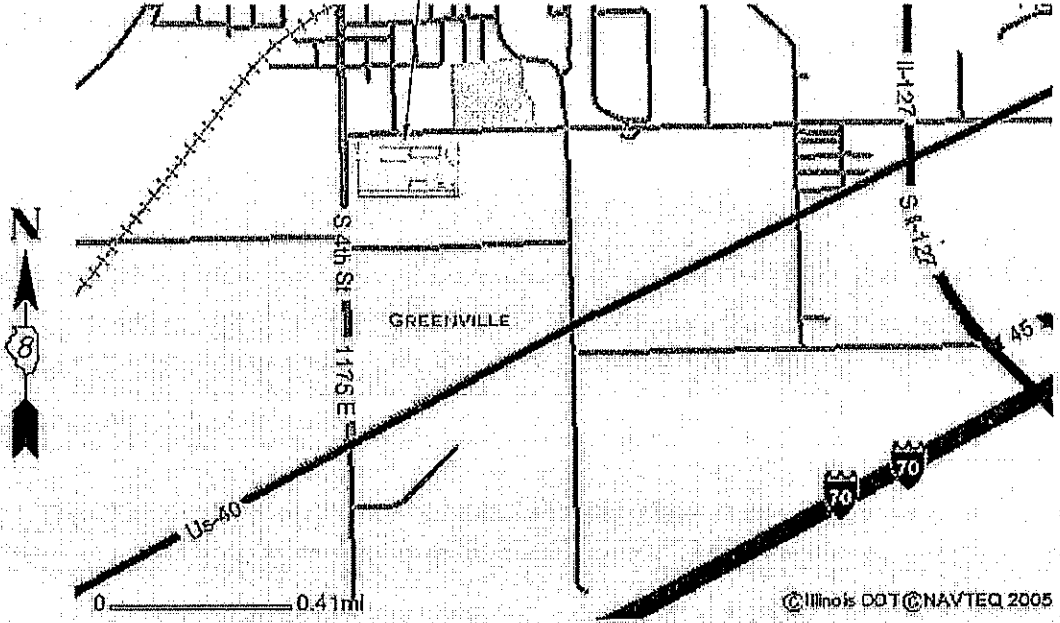

LOCATION 9
BOND COUNTY

VARIOUS ROUTES
DIST. 8 SEAL COAT 2008-1
MADISON, BOND, RANDOLPH COUNTIES
PLOT DATE: *DATE-TIME*

DATE-TIME
DATE-TIME
CON-SPEC

TOTAL SHEETS	SHEET NO.
36	29
CONTRACT NO. 76A57	

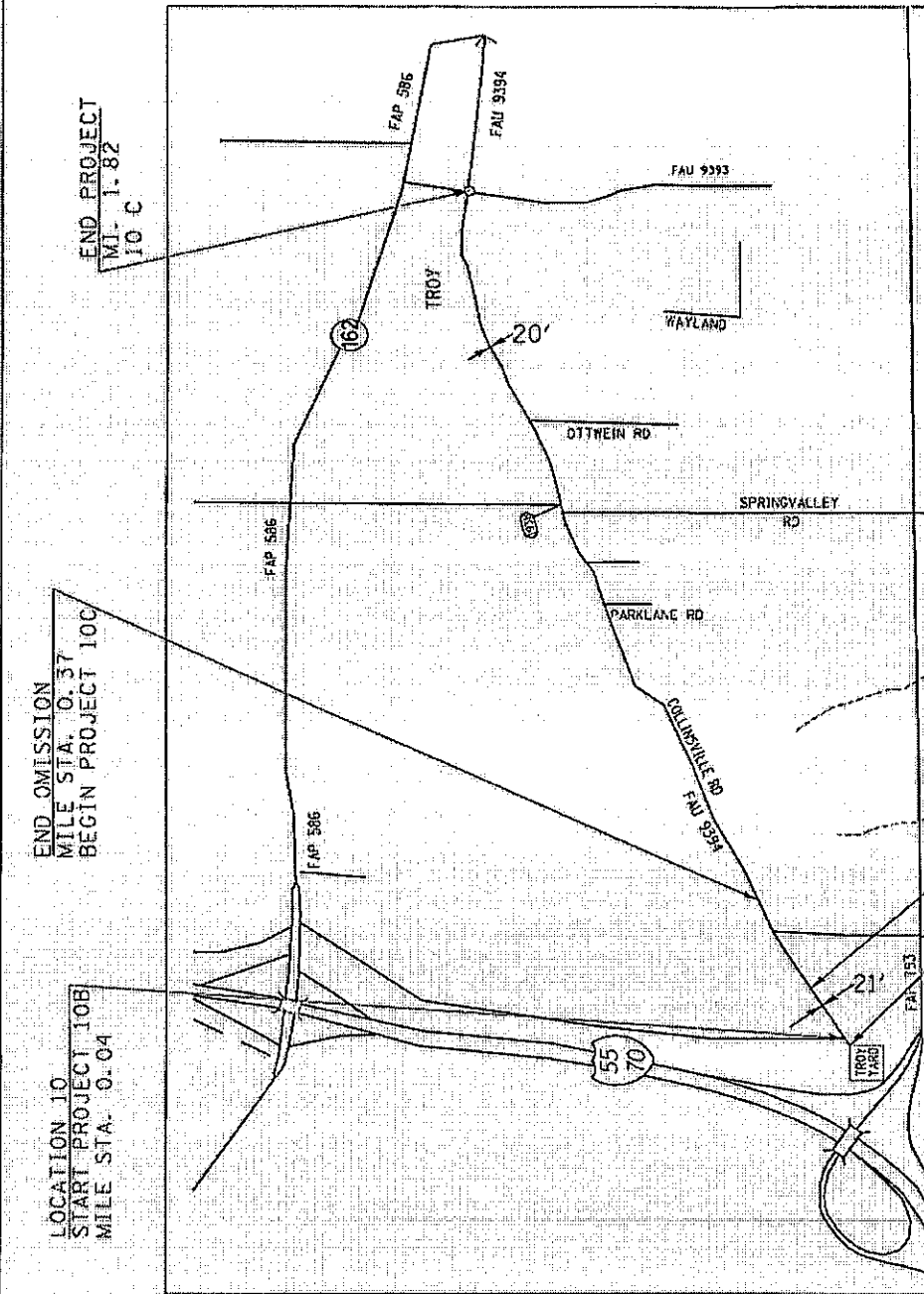

END OMISSION
MILE STA. 0.37
BEGIN PROJECT 10C

LOCATION 10A
START PROJECT 10B
MILE STA. 0.04

LOCATION 10A
SEE DETAIL
FOR SEALCOAT
INSIDE TROY YARD
(SHT. 30)

START OMISSION
MILE STA. 0.15
END PROJECT 10B

END PROJECT
MI. 1.82
TO C

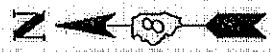

LOCATION 10A,B,C
MADISON COUNTY

VARIOUS ROUTES
DIST. 8 SEAL COAT 2008-1
MADISON, BOND, RANDOLPH COUNTIES

PLOT DATE: *DATE-TIME*

DATE
DATE-TIME
DRAW-SPEC

TOTAL SHEETS	SHEET NO.
36	30
CONTRACT NO.: 76A57	

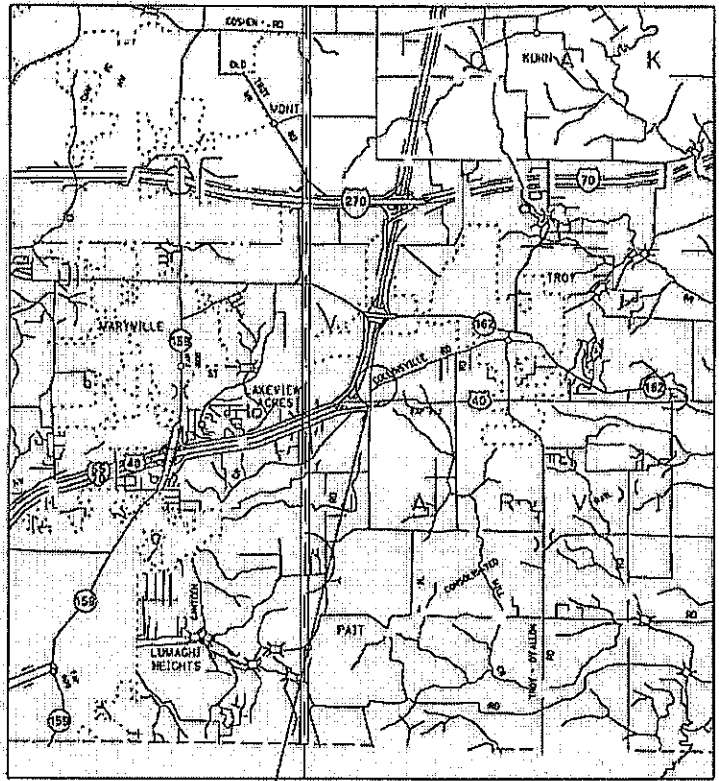

PROJECT LOCATION #10A
TROY OPERATIONS YARD

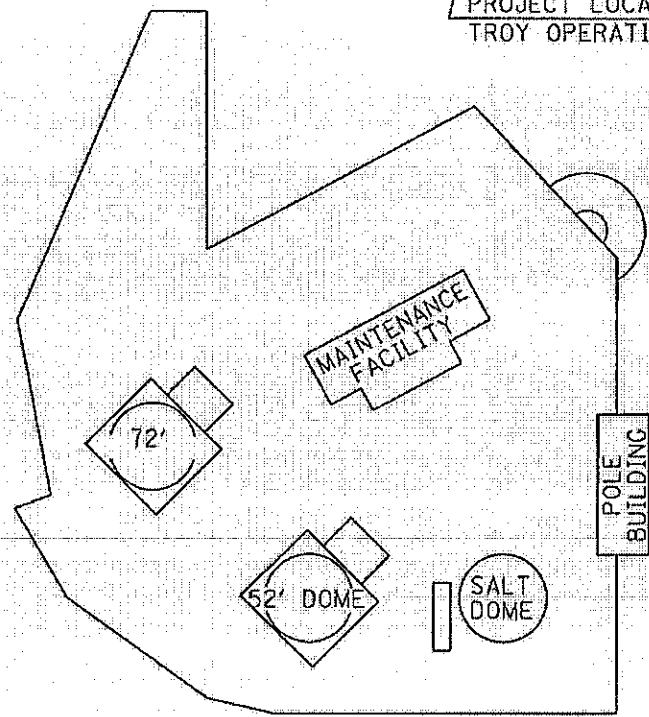

 - A-2 BITUMINOUS TREATMENT

LOCATION #10A
MADISON COUNTY

VARIOUS ROUTES
DIST. 8 SEAL COAT 2008-1
MADISON, BOND, RANDOLPH COUNTIES

PLOT DATE: DATE-TIME: 6TIMES

DATE-TIME
TIMES
DNV-SPEC

LOCATION #11 (FRONTAGE RD,
NORTH SIDE OF I-70 WEST OF
POCAHONTAS)

TOTAL SHEETS	SHEET NO.
36	31
CONTRACT NO.: 76A57	

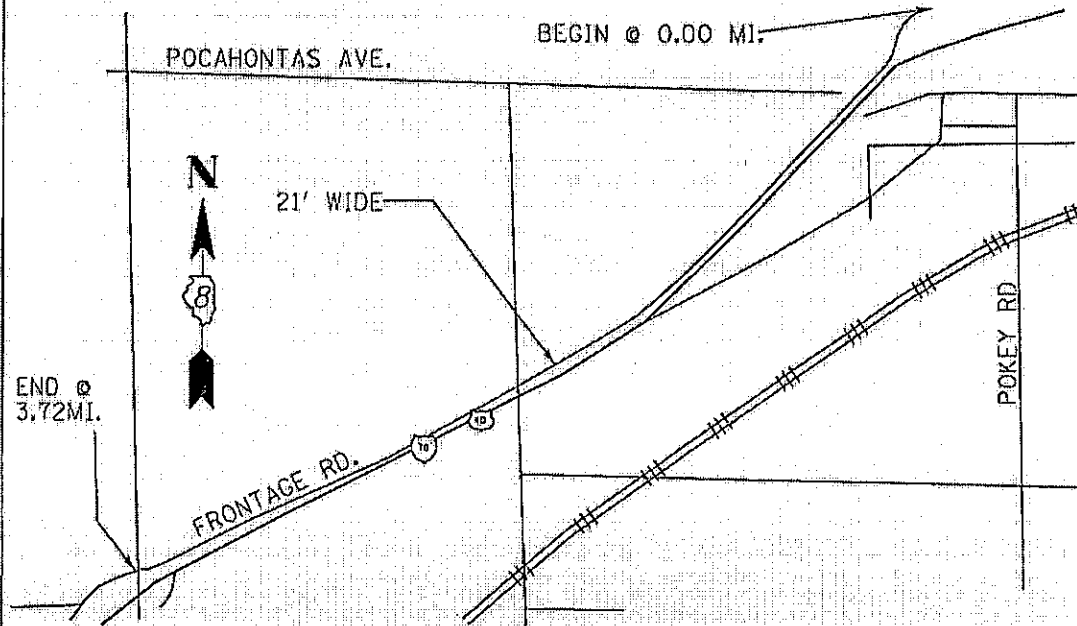

LOCATION 11
BOND COUNTY

VARIOUS ROUTES
DIST. 8 SEAL COAT 2008-1
MADISON, BOND, RANDOLPH COUNTIES

*DATE**
DATE-TIME
DW SPEC

PLDT DATE: *DATE-TIME*

TOTAL SHEETS	SHEET NO.
36	32
CONTRACT NO.: T6A5T	

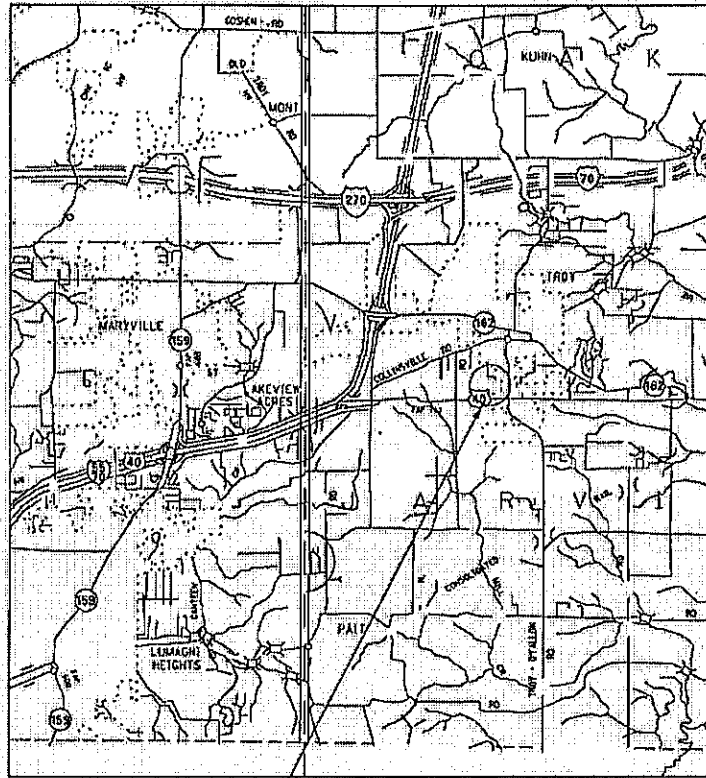

PROJECT LOCATION #12
TROY PARK & RIDE

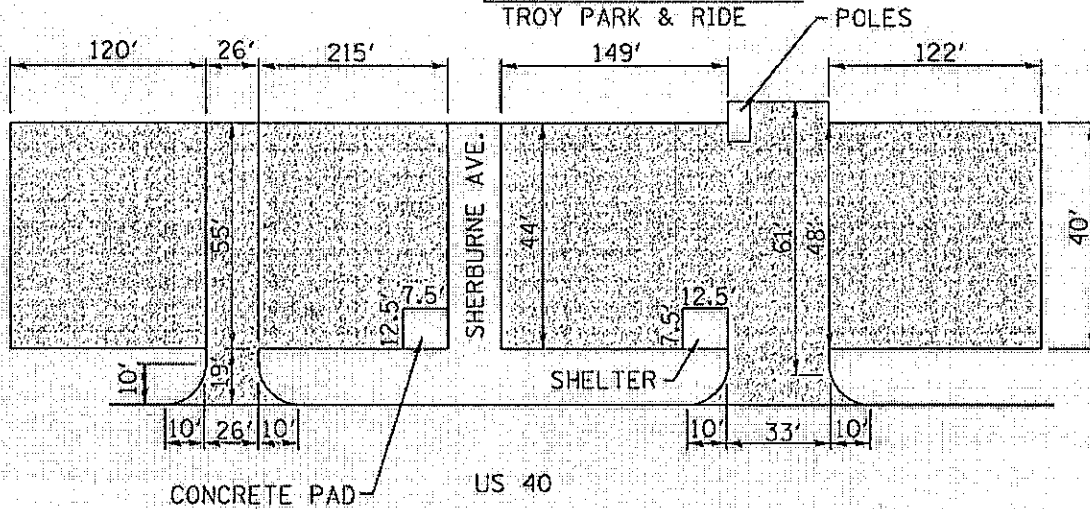

LOCATION #12
MADISON COUNTY

VARIOUS ROUTES
DIST. 8 SEAL COAT 2008-1
MADISON, BOND, RANDOLPH COUNTIES

PLOT DATE: *DATE*TIME* *STIME*

*DATE*TIME*
STIME
*DGN*SPEC*

TOTAL SHEETS	SHEET NO.
36	33
CONTRACT NO. 76A57	

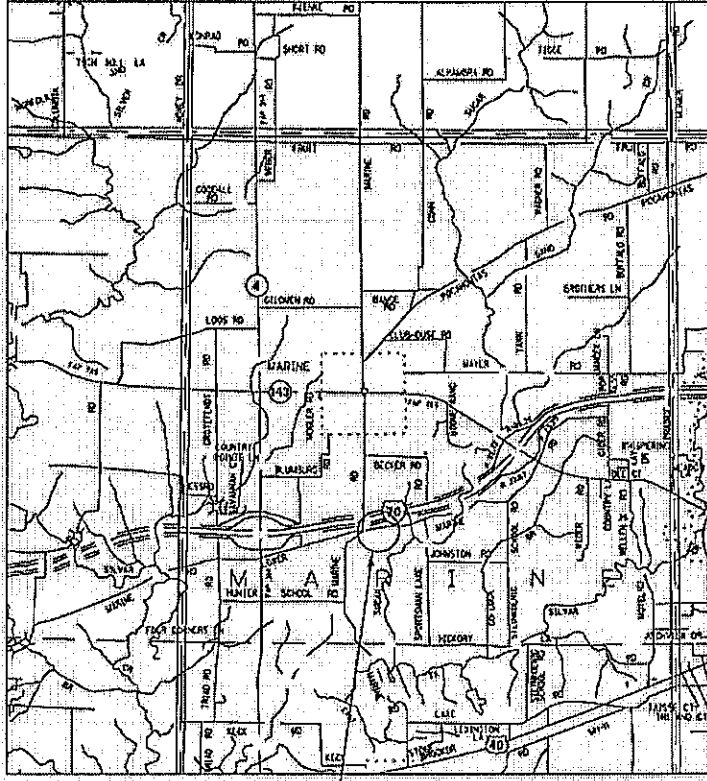

PROJECT LOCATION #13
LOWER MARINE ROAD

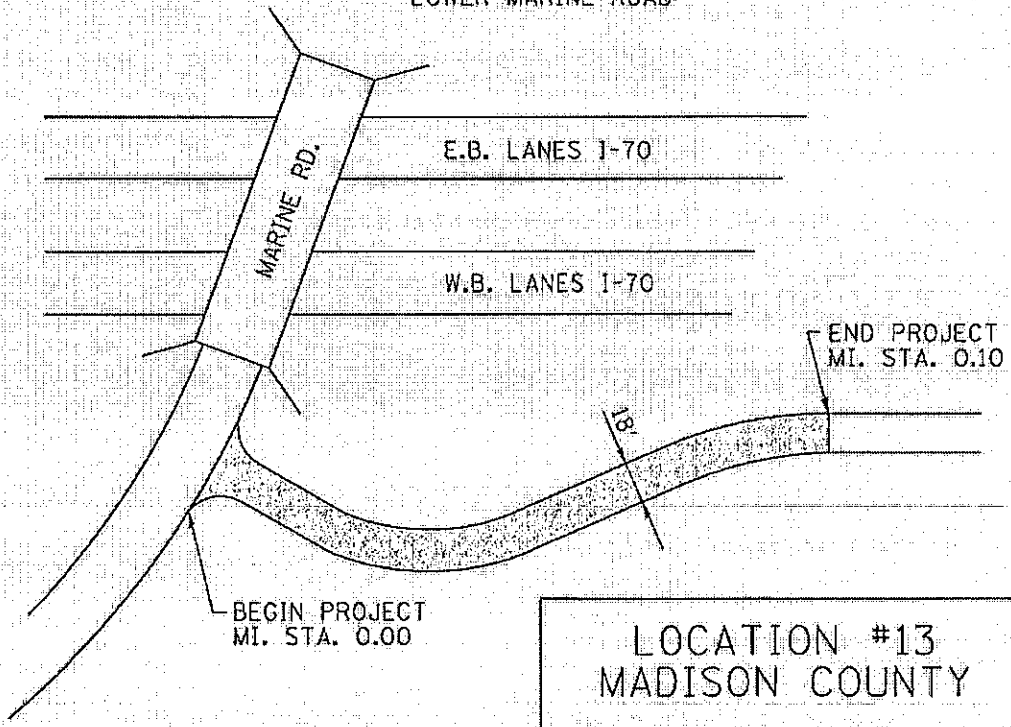

LOCATION #13
MADISON COUNTY

VARIOUS ROUTES
DIST. 8 SEAL COAT 2008-1
MADISON, BOND, RANDOLPH COUNTIES

PLOT DATE: *DATE* TIME: *TIME*

DATE TIME*
TIME
CON-SPEC

TOTAL SHEETS	SHEET NO.
36	34
CONTRACT NO.: 76AS7	

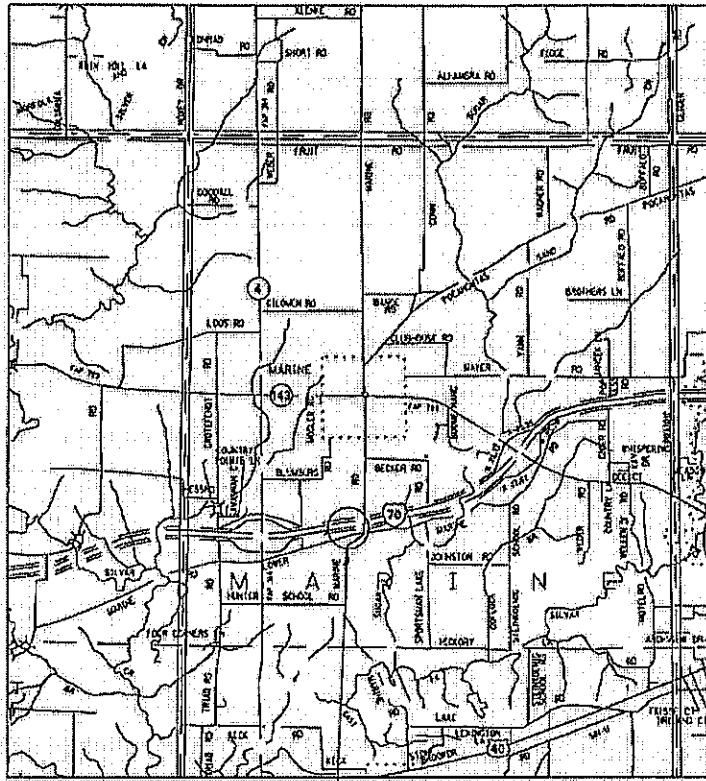

PROJECT LOCATION #13
LOWER MARINE ROAD

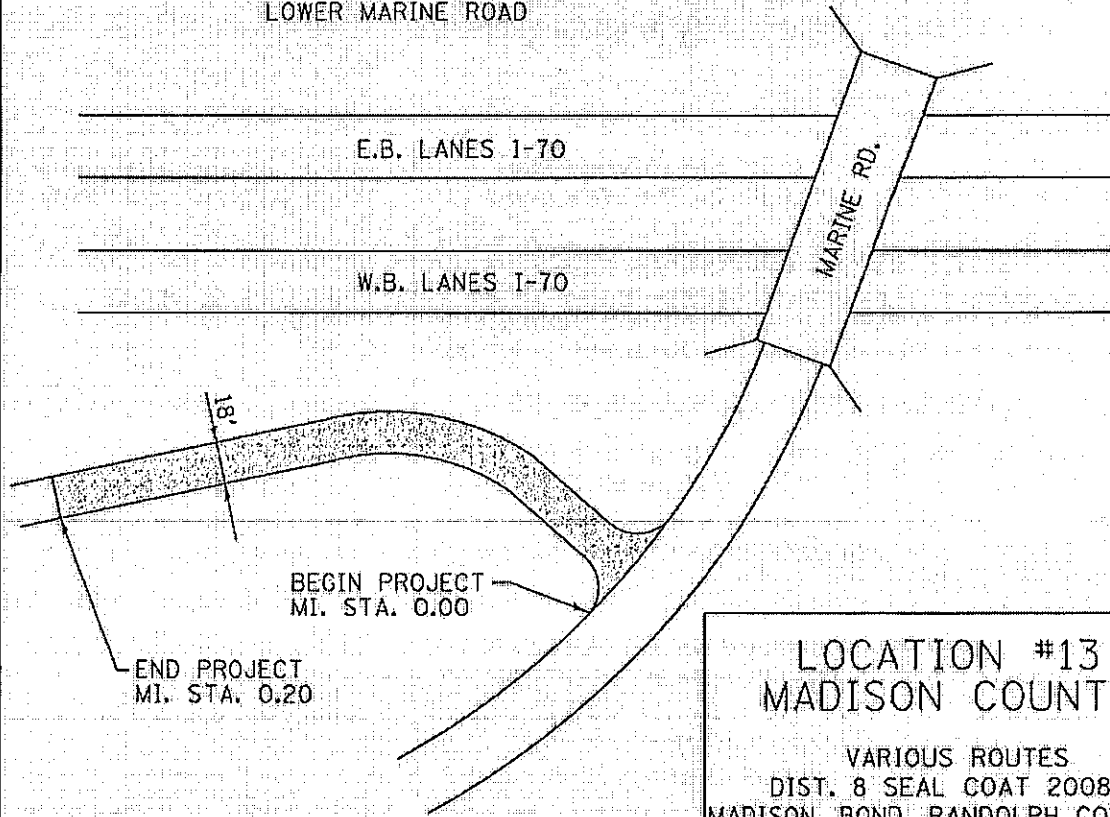

LOCATION #13
MADISON COUNTY
VARIOUS ROUTES
DIST. 8 SEAL COAT 2008-1
MADISON, BOND, RANDOLPH COUNTIES
PLOT DATE: *DATE-TIME* *STIME*

DATE-TIME
STIME
CGN-SPEC

DATE= DATE-TIME
 DATE= DATE-TIME
 DATE= DATE-TIME

BITUMINOUS SURFACE TREATMENT SCHEDULE

LOC	LOCATION DESCRIPTION	LENGTH (MILE)	NOMINAL WIDTH (FEET)	AREA (SQ. YD)	PRIME COAT @ .375 GAL/SY (.0015645 TON)	COVER & SEAL COAT @ .35 GAL/SY (.001460 TON)	SEAL COAT (.01 TON)	AGGREGATE
1	I TO FRONTAGE RD E OF IL 4	0.6	18	6336		9.25	63.4	
2	I TO FRONTAGE RD W OF IL 4	0.6	18	6336		9.25	63.4	
3	I 55/70 FRONTAGE RD N OF IL 162	0.88	22	11358		16.58	113.6	
3ENT	I 55/70 FRONTAGE RD N OF IL 162 ENTRANCE	0.017	66	658		.96	6.6	
4	I 55/70 FRONTAGE RD S OF IL 162	0.59	23	7961		11.63	79.6	
4ENT	I 55/70 FRONTAGE RD S OF IL 162 ENTRANCE	0.014	54	444		0.65	4.4	
5	FORT KASKASKIA ACCESS RD	1.75	20	20533		29.96	205.3	
6	ELLIS GROVE REST AREA	SEE PLAN VIEW		4626		6.76	46.3	
7	ELLIS GROVE HISTORICAL MARKER	0.035	14	287		0.42	2.9	
8	OLD RTE 3 RUNAROUND	0.4	21	4928		7.2	49.3	
9	GREENVILLE YARD	SEE PLAN VIEW		10,000		15.65	100	
10	COLLINSVILLE RD FROM TROY YARD TO MAIN ST.							
10A	TROY YARD							
10B	FRONTAGE ROAD TO WIDENING OMISSION	0.11	21	1355		36.7	125.6	
10C	WIDENING OMISSION TO MAIN STREET	1.45	20	17013		1.98	13.6	
11	N FRONTAGE RD BETWEEN POCANTAS & MADISON COUNTY	3.72	21	45830		24.84	170.1	
12	Troy Park-N-Ride			3850		133.82	458.3	
13	Lower Machine Road	.3	18	3421		1.15	38.5	
	TOTALS					335.46	2224	1575.1

TOTAL SHEETS	SHEET NO.
36	35
CONTRACT NO.: 76A67	

PAVEMENT MARKING SCHEDULE

LOC	LOCATION	SKIP-DASH YELLOW 4" (FEET)	SOLID YELLOW 4" (FEET)	SOLID WHITE 2" (FEET)	SOLID WHITE 12" (FEET)	RPM REMOVAL (EACH)
4	I 55/70 FRONTAGE RD S OF IL 162 DOUBLE YELLOW		680			
5	FORT KASKASKIA ACCESS RD	858	13992			
8	OLD RTE 3 RUNAROUND DOUBLE YELLOW		4224			
10B	FORMOSA RD TO WIDENING OMISSION	140	560	1120		7
10C	WIDENING OMISSION TO MAIN ST.	1915	250	14795	10	92
	SUBTOTAL	2913	19706	15915		
	TOTAL		38534	10		99

SCHEDULES

VARIOUS ROUTES
 DIST. 8 SEAL COAT 2008-1
 MADISON, BOND, RANDOLPH COUNTIES
 PLOT DATE: DATE-TIME

TOTAL SHEETS	SHEET NO.
36	36
CONTRACT NO.: 76A57	

PAVEMENT MARKING SCHEDULE STREET OMISSIONS
LOCATION 10

STREET NAME	LENGTH OF OMISSION	EB/WB
PARK LANE	55	EB
SPRING VALLEY	55	EB
TROY PARK	75	WB
OTTWEIN	55	EB
PARK VIEW	60	WB
COOK AVE	60	EB
COLLINSVILLE	70	WB
BORDER	25	WB
WASHINGTON ST.	35	EB
WASHINGTON ST.	35	WB
TOTAL	525	

LOCATION 5 PAVEMENT MARKING SCHEDULE

MILE STA	MILE LENGTH	FOOT LENGTH	TYPE OF LINE
0.00	0.20	1056	SKIP DASH
0.20	0.10	528	NO PASSING WB
0.30	0.10	528	DOUBLE YELLOW
0.40	0.20	1056	NO PASSING EB
0.60	0.05	264	DOUBLE YELLOW
0.65	0.15	792	NO PASSING WB
0.80	0.95	5016	DOUBLE YELLOW
1.75			

SCHEDULES

VARIOUS ROUTES
DIST. 8 SEAL COAT 2008-1
MADISON, BOND, RANDOLPH COUNTIES

PLOT DATE: -DATE-TIME-

PRINTED
-DATE-TIME-
-CON-SPEC-

ILLINOIS DEPARTMENT OF LABOR

PREVAILING WAGES FOR MADISON-RANDOLPH-BOND COUNTY EFFECTIVE MAY 2008

The Prevailing rates of wages are included in the Contract proposals which are subject to Check Sheet #5 of the Supplemental Specifications and Recurring Special Provisions. The rates have been ascertained and certified by the Illinois Department of Labor for the locality in which the work is to be performed and for each craft or type of work or mechanic needed to execute the work of the Contract. As required by Prevailing Wage Act (820 ILCS 130/0.01, et seq.) and Check Sheet #5 of the Contract, not less than the rates of wages ascertained by the Illinois Department of Labor and as revised during the performance of a Contract shall be paid to all laborers, workers and mechanics performing work under the Contract. Post the scale of wages in a prominent and easily accessible place at the site of work.

If the Illinois Department of Labor revises the prevailing rates of wages to be paid as listed in the specification of rates, the contractor shall post the revised rates of wages and shall pay not less than the revised rates of wages. Current wage rate information shall be obtained by visiting the Illinois Department of Labor web site at <http://www.state.il.us/agency/idol/> or by calling 312-793-2814. It is the responsibility of the contractor to review the rates applicable to the work of the contract at regular intervals in order to insure the timely payment of current rates. Provision of this information to the contractor by means of the Illinois Department of Labor web site satisfies the notification of revisions by the Department to the contractor pursuant to the Act, and the contractor agrees that no additional notice is required. The contractor shall notify each of its subcontractors of the revised rates of wages.

Madison County Prevailing Wage for May 2008

Trade Name	RG	TYP	C	Base	FRMAN	*M-F>8	OSA	OSH	H/W	Pensn	Vac	Trng
=====	==	===	=	=====	=====	=====	===	===	=====	=====	=====	=====
ASBESTOS ABT-GEN	NW	ALL		25.600	26.100	1.5	1.5	2.0	5.050	7.150	0.000	0.600
ASBESTOS ABT-GEN	SE	ALL		25.550	26.050	1.5	1.5	2.0	5.350	7.100	0.000	0.600
ASBESTOS ABT-MEC		BLD		25.690	26.690	1.5	1.5	2.0	5.050	2.500	0.000	0.250
BOILERMAKER		BLD		30.000	32.500	1.5	1.5	2.0	6.820	11.28	1.000	0.300
BRICK MASON		BLD		27.090	28.840	1.5	1.5	2.0	5.250	8.450	2.000	0.400
CARPENTER		ALL		31.230	32.730	1.5	1.5	2.0	5.300	4.000	0.000	0.350
CEMENT MASON		ALL		27.500	28.250	1.5	1.5	2.0	6.000	9.000	0.000	0.200
CERAMIC TILE FNSHER		BLD		23.370	0.000	1.5	1.5	2.0	5.200	4.400	0.000	0.410
ELECTRIC PWR EQMT OP	NW	ALL		32.310	39.460	1.5	2.0	2.0	4.750	8.080	0.000	0.240
ELECTRIC PWR EQMT OP	SE	ALL		31.510	37.980	1.5	2.0	2.0	4.530	7.880	0.000	0.160
ELECTRIC PWR GRNDMAN	NW	ALL		22.000	39.460	1.5	2.0	2.0	4.750	5.500	0.000	0.170
ELECTRIC PWR GRNDMAN	SE	ALL		23.530	37.980	1.5	2.0	2.0	3.380	5.890	0.000	0.120
ELECTRIC PWR LINEMAN	NW	ALL		37.270	39.460	1.5	2.0	2.0	4.750	9.320	0.000	0.280
ELECTRIC PWR LINEMAN	SE	ALL		36.220	37.980	1.5	2.0	2.0	5.210	9.060	0.000	0.180
ELECTRIC PWR TRK DRV	NW	ALL		22.550	39.460	1.5	2.0	2.0	4.750	5.640	0.000	0.170
ELECTRIC PWR TRK DRV	SE	ALL		25.710	37.980	1.5	2.0	2.0	3.700	6.430	0.000	0.130
ELECTRICIAN	NW	ALL		32.660	34.660	1.5	1.5	2.0	5.900	7.875	0.000	0.490
ELECTRICIAN	SE	ALL		33.740	36.760	1.5	1.5	2.0	5.400	6.750	0.000	0.420
ELECTRONIC SYS TECH	NW	BLD		25.000	26.500	1.5	1.5	2.0	5.650	5.475	0.000	0.250
ELECTRONIC SYS TECH	SE	BLD		26.520	28.020	1.5	1.5	2.0	2.800	6.270	0.000	0.250
ELEVATOR CONSTRUCTOR		BLD		38.715	43.550	2.0	2.0	2.0	8.775	6.960	2.320	0.000
FLOOR LAYER		BLD		27.680	28.430	1.5	1.5	2.0	5.300	4.000	0.000	0.350
GLAZIER		BLD		30.140	0.000	2.0	2.0	2.0	8.800	7.520	2.410	0.310
HT/FROST INSULATOR		BLD		31.240	32.240	1.5	1.5	2.0	5.300	8.860	0.000	0.450
IRON WORKER		ALL		27.350	28.850	1.5	1.5	2.0	6.360	9.150	0.000	0.420
LABORER	NW	ALL		25.100	25.600	1.5	1.5	2.0	5.050	7.150	0.000	0.600
LABORER	SE	ALL		25.050	25.550	1.5	1.5	2.0	5.350	7.100	0.000	0.600
MACHINIST		BLD		38.390	40.390	2.0	2.0	2.0	4.880	6.550	2.650	0.000
MARBLE FINISHERS		BLD		23.370	0.000	1.5	1.5	2.0	5.200	4.400	0.000	0.410
MARBLE MASON		BLD		27.090	28.840	1.5	1.5	2.0	5.250	8.450	2.000	0.400
MILLWRIGHT		ALL		31.230	32.730	1.5	1.5	2.0	5.300	4.000	0.000	0.350
OPERATING ENGINEER		ALL	1	27.000	29.000	1.5	1.5	2.0	6.700	12.35	0.000	1.000
OPERATING ENGINEER		ALL	2	25.870	29.000	1.5	1.5	2.0	6.700	12.35	0.000	1.000
OPERATING ENGINEER		ALL	3	21.390	29.000	1.5	1.5	2.0	6.700	12.35	0.000	1.000
OPERATING ENGINEER		ALL	4	21.450	29.000	1.5	1.5	2.0	6.700	12.35	0.000	1.000
OPERATING ENGINEER		ALL	5	21.120	29.000	1.5	1.5	2.0	6.700	12.35	0.000	1.000
OPERATING ENGINEER		ALL	6	27.550	29.000	1.5	1.5	2.0	6.700	12.35	0.000	1.000
OPERATING ENGINEER		ALL	7	27.850	29.000	1.5	1.5	2.0	6.700	12.35	0.000	1.000
OPERATING ENGINEER		ALL	8	28.130	29.000	1.5	1.5	2.0	6.700	12.35	0.000	1.000
PAINTER		BLD		26.700	28.200	1.5	1.5	2.0	4.700	5.570	0.000	0.350
PAINTER		HWY		27.900	29.400	1.5	1.5	2.0	4.700	5.570	0.000	0.350
PAINTER OVER 30FT		BLD		27.700	29.200	1.5	1.5	2.0	4.700	5.570	0.000	0.350
PAINTER PWR EQMT		BLD		27.700	29.200	1.5	1.5	2.0	4.700	5.570	0.000	0.350
PAINTER PWR EQMT		HWY		28.900	30.400	1.5	1.5	2.0	4.700	5.570	0.000	0.350
PILEDRIVER		ALL		31.230	32.730	1.5	1.5	2.0	5.300	4.000	0.000	0.350
PIPEFITTER	N	BLD		31.450	33.020	2.0	2.0	2.0	5.350	6.660	0.000	0.200
PIPEFITTER	S	BLD		30.000	32.000	1.5	1.5	2.0	5.940	7.000	0.000	0.350
PLASTERER		BLD		27.900	28.900	1.5	1.5	2.0	6.000	7.750	0.000	0.250
PLUMBER	N	BLD		31.450	33.020	2.0	2.0	2.0	5.350	6.660	0.000	0.200
PLUMBER	S	BLD		31.700	34.200	1.5	1.5	2.0	5.200	5.450	0.000	0.300
ROOFER		BLD		26.750	28.750	1.5	1.5	2.0	6.100	5.900	0.000	0.200
SHEETMETAL WORKER		ALL		28.080	29.580	1.5	1.5	2.0	6.350	5.650	1.690	0.260
SPRINKLER FITTER		BLD		35.230	37.730	2.0	2.0	2.0	6.650	8.100	0.000	0.650
TERRAZZO FINISHER		BLD		31.240	0.000	1.5	1.5	2.0	0.000	0.000	0.000	0.000
TERRAZZO MASON		BLD		31.530	31.830	1.5	1.5	2.0	0.000	4.250	0.000	0.070
TRUCK DRIVER		ALL	1	27.580	0.000	1.5	1.5	2.0	8.600	3.925	0.000	0.000
TRUCK DRIVER		ALL	2	27.980	0.000	1.5	1.5	2.0	8.600	3.925	0.000	0.000
TRUCK DRIVER		ALL	3	28.180	0.000	1.5	1.5	2.0	8.600	3.925	0.000	0.000

TRUCK DRIVER	ALL	4	28.430	0.000	1.5	1.5	2.0	8.600	3.925	0.000	0.000
TRUCK DRIVER	ALL	5	29.180	0.000	1.5	1.5	2.0	8.600	3.925	0.000	0.000
TRUCK DRIVER	O&C	1	22.060	0.000	1.5	1.5	2.0	8.600	3.925	0.000	0.000
TRUCK DRIVER	O&C	2	22.380	0.000	1.5	1.5	2.0	8.600	3.925	0.000	0.000
TRUCK DRIVER	O&C	3	22.540	0.000	1.5	1.5	2.0	8.600	3.925	0.000	0.000
TRUCK DRIVER	O&C	4	22.740	0.000	1.5	1.5	2.0	8.600	3.925	0.000	0.000
TRUCK DRIVER	O&C	5	23.340	0.000	1.5	1.5	2.0	8.600	3.925	0.000	0.000

Legend:

M-F>8 (Overtime is required for any hour greater than 8 worked each day, Monday through Friday.)

OSA (Overtime is required for every hour worked on Saturday)

OSH (Overtime is required for every hour worked on Sunday and Holidays)

H/W (Health & Welfare Insurance)

Pensn (Pension)

Vac (Vacation)

Trng (Training)

Explanations

MADISON COUNTY

ELECTRICIANS AND ELECTRIC SYSTEMS TECHNICIAN (NORTHWEST) - Townships of Godfrey, Foster and Wood River, and the western one mile of Moro, Ft. Russell and Edwardsville, south to the north side of Hwy. 66 and west to the Mississippi River. This includes SIU-Edwardsville Dental Facility and Alton Mental Health Hospital.

ELECTRICIANS AND ELECTRIC SYSTEMS TECHNICIAN (SOUTHEAST) - Remainder of county not covered by ELECTRICIANS AND ELECTRIC SYSTEMS TECHNICIAN (NW) including SIU-Edwardsville Main Campus.

LABORERS (NORTHWEST) - That area northwest of a diagonal line running from the Mississippi River at the intersection of the waterway known as Wood River at Maple Island, northeast through the highway intersection of Illinois Routes 3 and 143 and following the boundary of Alton/East Alton, then preceding northeast to the county line at a point approximately one mile west of Illinois Route 159.

PLUMBERS AND PIPEFITTERS (SOUTH) - That part of the county South of a line between Mitchell and Highland including the town of Glen Carbon.

The following list is considered as those days for which holiday rates of wages for work performed apply: New Years Day, Memorial/Decoration Day, Fourth of July, Labor Day, Veterans Day, Thanksgiving Day, Christmas Day. Generally, any of these holidays which fall on a Sunday is celebrated on the following Monday. This then makes work performed on that Monday payable at the appropriate overtime rate for holiday pay. Common practice in a given local may alter certain days of celebration such as the day after Thanksgiving for Veterans Day. If in doubt, please check with IDOL.

Oil and chip resealing (O&C) means the application of road oils and liquid asphalt to coat an existing road surface, followed by application of aggregate chips or gravel to coated surface, and subsequent rolling of material to seal the surface.

EXPLANATION OF CLASSES

ASBESTOS - GENERAL - removal of asbestos material/mold and hazardous materials from any place in a building, including mechanical systems where those mechanical systems are to be removed. This includes the removal of asbestos materials/mold and hazardous materials from ductwork or pipes in a building when the building is to be demolished at the time or at some close future date.

ASBESTOS - MECHANICAL - removal of asbestos material from mechanical systems, such as pipes, ducts, and boilers, where the mechanical systems are to remain.

CERAMIC TILE FINISHER AND MARBLE FINISHER

The handling, at the building site, of all sand, cement, tile, marble or stone and all other materials that may be used and installed by [a] tile layer or marble mason. In addition, the grouting, cleaning, sealing, and mixing on the job site, and all other work as required in assisting the setter. The term "Ceramic" is used for naming the classification only and is in no way a limitation of the product handled. Ceramic takes into consideration most hard tiles.

ELECTRONIC SYSTEMS TECHNICIAN

Installation, service and maintenance of low-voltage systems which utilizes the transmission and/or transference of voice, sound, vision, or digital for commercial, education, security and entertainment purposes for the following: TV monitoring and surveillance, background/foreground music, intercom and telephone interconnect, field programming, inventory control systems, microwave transmission, multi-media, multiplex, radio page, school, intercom and sound burglar alarms and low voltage master clock systems.

Excluded from this classification are energy management systems, life safety systems, supervisory controls and data acquisition systems not intrinsic with the above listed systems, fire alarm systems, nurse call systems and raceways exceeding fifteen feet in length.

TRUCK DRIVER - BUILDING, HEAVY AND HIGHWAY CONSTRUCTION

Class 1. Drivers on 2 axle trucks hauling less than 9 ton. Air compressor and welding machines and brooms, including those pulled by separate units, truck driver helpers, warehouse employees, mechanic helpers, greasers and tiremen, pickup trucks when hauling materials, tools, or workers to and from and on-the-job site, and fork lifts up to 6,000 lb. capacity.

Class 2. Two or three axle trucks hauling more than 9 ton but hauling less than 16 ton. A-frame winch trucks, hydrolift trucks, vector trucks or similar equipment when used for transportation purposes. Fork lifts over 6,000 lb. capacity, winch trucks, four axle combination units, and ticket writers.

Class 3. Two, three or four axle trucks hauling 16 ton or more. Drivers on water pulls, articulated dump trucks, mechanics and working forepersons, and dispatchers. Five axle or more combination units.

Class 4. Low Boy and Oil Distributors.

Class 5. Drivers who require special protective clothing while employed on hazardous waste work.

TRUCK DRIVER - OIL AND CHIP RESEALING ONLY.

This shall encompass laborers, workers and mechanics who drive contractor or subcontractor owned, leased, or hired pickup, dump, service, or oil distributor trucks. The work includes transporting materials and equipment (including but not limited to, oils, aggregate supplies, parts, machinery and tools) to or from the job site; distributing oil or liquid asphalt and aggregate; stock piling material when in connection with the actual oil and chip contract. The Truck Driver (Oil & Chip Resealing) wage classification does not include supplier delivered materials.

OPERATING ENGINEERS

GROUP I. Cranes, Dragline, Shovels, Skimmer Scoops, Clamshells or Derrick Boats, Pile Drivers, Crane-Type Backhoes, Asphalt Plant Operators, Concrete Plant Operators, Dredges, Asphalt Spreading Machines, All Locomotives, Cable Ways, or Tower Machines, Hoists, Hydraulic Backhoes, Ditching Machines or Backfiller, Cherrypickers, Overhead Cranes, Roller, Steam or Gas, Concrete Pavers, Excavators, Concrete Breakers, Concrete Pumps, Bulk Cement Plants, Cement Pumps, Derrick-Type Drills, Boat Operators, Motor Graders or Pushcats, Scoops or Tournapulls, Bulldozers, Endloaders or Fork Lifts, Power Blade or Elevating Graders, Winch Cats, Boom or Winch Trucks or Boom Tractors, Pipe Wrapping or Painting Machines, Asphalt Plant Engineer, Journeyman Lubricating Engineer, Drills (other than Derrick Type), Mud Jacks, or Well Drilling Machines, Boring Machines or Track Jacks, Mixers, Conveyors (Two), Air Compressors (Two), Water Pumps regardless of size (Two), Welding Machines (Two), Siphons or Jets (Two), Winch Heads or Apparatuses (Two), Light Plants (Two), Waterblasters (two), All Tractors regardless of size (straight tractor only), Fireman on Stationary Boilers, Automatic Elevators, Form Grading Machines, Finishing Machines, Power Sub-Grader or Ribbon Machines, Longitudinal Floats, Distributor Operators on Trucks, Winch Heads or Apparatuses (One), Mobil Track air and heaters (two to five), Heavy Equipment Greaser, Relief Operator, Assistant Master Mechanic and Heavy Duty Mechanic, all Operators (except those listed below).

GROUP II. Assistant Operators.

GROUP III. Air Compressors (One), Water Pumps, regardless of Size (One), Waterblasters (one), Welding Machine (One), Mixers (One Bag), Conveyor (One), Siphon or Jet (One), Light Plant (One), Heater (One), Immobile Track Air (One), and Self Propelled Walk-Behind Rollers.

GROUP IV. Asphalt Spreader Oilers, Fireman on Whirlies and Heavy Equipment Oilers, Truck Cranes, Dredges, Monigans, Large Cranes - (Over 65-ton rated capacity) Concrete Plant Oiler, Blacktop Plant Oiler, and Creter Crane Oiler (when required).

GROUP V. Oiler.

GROUP VI. Master Mechanics, Operators on equipment with Booms, including jibs, 100 feet and over, and less than 150 feet long.

GROUP VII. Operators on equipment with Booms, including jibs, 150 feet and over, and less than 200 feet long.

GROUP VIII. Operators on Equipment with Booms, including jibs, 200 feet and over; Tower Cranes; Whirlie Cranes; and Operator Foreman.

TERRAZZO FINISHER

The handling of all materials used for Mosaic and Terrazzo work including preparing, mixing by hand, by mixing machine or transporting of pre-mixed materials and distributing with shovel, rake, hoe, or pail, all kinds of concrete foundations necessary for Mosaic and Terrazzo work, all cement terrazzo, magnesite terrazzo, Do-O-Tex terrazzo, epoxy matrix ter-razzo, exposed aggregate, rustic or rough washed for exterior or interior of buildings placed either by machine or by hand, and any other kind of mixture of plastics composed of chips or granules when mixed with cement, rubber, neoprene, vinyl, magnesium chloride or any other resinous or chemical substances used for seamless flooring systems, and all other building materials, all similar materials and all precast terrazzo work on jobs, all scratch coat used for Mosaic and Terrazzo work and sub-bed, tar paper and wire mesh (2x2 etc.) or lath. The rubbing, grinding, cleaning and finishing of same either by hand or by machine or by terrazzo resurfacing equipment on new or existing floors. When necessary finishers shall be allowed to assist the mechanics to spread sand bed, lay tarpaper and wire mesh (2x2 etc.) or lath. The finishing of cement floors where additional aggregate of stone is added by spreading or sprinkling on top of the finished base, and troweled or rolled into the finish and then the surface is ground by grinding machines.

Other Classifications of Work:

For definitions of classifications not otherwise set out, the Department generally has on file such definitions which are available. If a task to be performed is not subject to one of the classifications of pay set out, the Department will upon being contacted state which neighboring county has such a classification and provide such rate, such rate being deemed to exist by reference in this document. If no neighboring county rate applies to the task, the Department shall undertake a special determination, such special determination being then deemed to have existed under this determination. If a project requires these, or any classification not listed, please contact IDOL at 618/993-7271 for wage rates or clarifications.

LANDSCAPING

Landscaping work falls under the existing classifications for laborer, operating engineer and truck driver. The work performed by landscape plantsman and landscape laborer is covered by the existing classification of laborer. The work performed by landscape operators (regardless of equipment used or its size) is covered by the classifications of operating engineer. The work performed by landscape truck drivers (regardless of size of truck driven) is covered by the classifications of truck driver.

Randolph County Prevailing Wage for May 2008

Trade Name	RG	TYP	C	Base	FRMAN	*M-F>8	OSA	OSH	H/W	Pensn	Vac	Trng
=====	==	==	=	=====	=====	=====	==	==	=====	=====	=====	=====
ASBESTOS ABT-GEN		ALL		23.850	24.350	1.5	1.5	2.0	5.350	8.600	0.000	0.600
ASBESTOS ABT-MEC		BLD		25.690	26.690	1.5	1.5	2.0	5.050	2.500	0.000	0.250
BOILERMAKER		BLD		30.000	32.500	1.5	1.5	2.0	6.820	11.28	1.000	0.300
BRICK MASON		BLD		26.010	27.510	1.5	1.5	2.0	6.400	5.700	0.000	0.430
CARPENTER		ALL		31.230	32.730	1.5	1.5	2.0	5.300	4.000	0.000	0.350
CEMENT MASON		BLD		24.000	25.000	1.5	1.5	2.0	5.300	4.050	0.000	0.200
CEMENT MASON		HWY		23.750	24.750	1.5	1.5	2.0	5.300	3.700	0.000	0.300
CERAMIC TILE FNSHER		BLD		24.990	0.000	1.5	1.5	2.0	6.400	5.700	0.000	0.430
ELECTRIC PWR EQMT OP		ALL		31.510	37.980	1.5	2.0	2.0	4.530	7.880	0.000	0.160
ELECTRIC PWR GRNDMAN		ALL		23.530	37.980	1.5	2.0	2.0	3.380	5.890	0.000	0.120
ELECTRIC PWR LINEMAN		ALL		36.220	37.980	1.5	2.0	2.0	5.210	9.060	0.000	0.180
ELECTRIC PWR TRK DRV		ALL		25.710	37.980	1.5	2.0	2.0	3.700	6.430	0.000	0.130
ELECTRICIAN	NW	ALL		33.740	36.760	1.5	1.5	2.0	5.400	6.750	0.000	0.420
ELECTRICIAN	SE	ALL		33.680	35.930	1.5	1.5	2.0	5.150	7.070	0.000	0.500
ELECTRONIC SYS TECH	NW	BLD		26.520	28.020	1.5	1.5	2.0	2.800	6.270	0.000	0.250
ELECTRONIC SYS TECH	SE	BLD		26.740	28.240	1.5	1.5	2.0	5.150	3.470	0.000	0.250
ELEVATOR CONSTRUCTOR		BLD		38.715	43.550	2.0	2.0	2.0	8.775	6.960	2.320	0.000
FLOOR LAYER		BLD		27.680	28.430	1.5	1.5	2.0	5.300	4.000	0.000	0.350
GLAZIER		BLD		30.140	0.000	2.0	2.0	2.0	8.800	7.520	2.410	0.310
HT/FROST INSULATOR		BLD		31.240	32.240	1.5	1.5	2.0	5.300	8.860	0.000	0.450
IRON WORKER		ALL		27.350	28.850	1.5	1.5	2.0	6.360	9.150	0.000	0.420
LABORER		ALL		23.350	23.850	1.5	1.5	2.0	5.350	8.600	0.000	0.600
MACHINIST		BLD		38.390	40.390	2.0	2.0	2.0	4.880	6.550	2.650	0.000
MARBLE FINISHERS		BLD		24.990	0.000	1.5	1.5	2.0	6.000	5.400	0.000	0.425
MARBLE MASON		BLD		26.010	27.510	1.5	1.5	2.0	6.400	5.700	0.000	0.430
MILLWRIGHT		ALL		31.230	32.730	1.5	1.5	2.0	5.300	4.000	0.000	0.350
OPERATING ENGINEER		ALL	1	27.000	29.000	1.5	1.5	2.0	6.700	12.35	0.000	1.000
OPERATING ENGINEER		ALL	2	25.870	29.000	1.5	1.5	2.0	6.700	12.35	0.000	1.000
OPERATING ENGINEER		ALL	3	21.390	29.000	1.5	1.5	2.0	6.700	12.35	0.000	1.000
OPERATING ENGINEER		ALL	4	21.450	29.000	1.5	1.5	2.0	6.700	12.35	0.000	1.000
OPERATING ENGINEER		ALL	5	21.120	29.000	1.5	1.5	2.0	6.700	12.35	0.000	1.000
OPERATING ENGINEER		ALL	6	27.550	29.000	1.5	1.5	2.0	6.700	12.35	0.000	1.000
OPERATING ENGINEER		ALL	7	27.850	29.000	1.5	1.5	2.0	6.700	12.35	0.000	1.000
OPERATING ENGINEER		ALL	8	28.130	29.000	1.5	1.5	2.0	6.700	12.35	0.000	1.000
PAINTER		BLD		23.810	25.310	1.5	1.5	2.0	5.480	4.900	0.000	0.250
PAINTER		HWY		28.110	29.610	1.5	1.5	2.0	5.480	4.900	0.000	0.250
PAINTER OVER 30FT		BLD		24.810	26.310	1.5	1.5	2.0	5.480	4.900	0.000	0.250
PAINTER PWR EQMT		BLD		24.810	26.310	1.5	1.5	2.0	5.480	4.900	0.000	0.250
PAINTER PWR EQMT		HWY		29.110	30.610	1.5	1.5	2.0	5.480	4.900	0.000	0.250
PILEDRIVER		ALL		31.230	32.730	1.5	1.5	2.0	5.300	4.000	0.000	0.350
PIPEFITTER	N	BLD		31.700	34.200	1.5	1.5	2.0	6.400	4.100	0.000	0.525
PIPEFITTER	SE	BLD		31.670	34.840	1.5	2.0	2.0	6.700	5.030	0.000	1.000
PIPEFITTER	W	BLD		30.000	32.000	1.5	1.5	2.0	5.940	7.000	0.000	0.350
PLASTERER		BLD		23.500	24.500	1.5	1.5	2.0	5.200	3.550	0.000	0.100
PLUMBER	N	BLD		31.700	34.200	1.5	1.5	2.0	6.400	4.100	0.000	0.525
PLUMBER	SE	BLD		31.670	34.840	1.5	2.0	2.0	6.700	5.030	0.000	1.000
PLUMBER	W	BLD		31.700	34.200	1.5	1.5	2.0	5.200	5.450	0.000	0.300
ROOFER		BLD		26.750	28.750	1.5	1.5	2.0	6.100	5.900	0.000	0.200
SHEETMETAL WORKER		ALL		28.080	29.580	1.5	1.5	2.0	6.350	5.650	1.690	0.260
SPRINKLER FITTER		BLD		35.230	37.730	2.0	2.0	2.0	6.650	8.100	0.000	0.650
STONE MASON		BLD		26.010	27.510	1.5	1.5	2.0	6.400	5.700	0.000	0.430
TERRAZZO FINISHER		BLD		24.990	0.000	1.5	1.5	2.0	6.000	5.400	0.000	0.425
TERRAZZO MASON		BLD		28.500	28.800	1.5	1.5	2.0	6.400	5.700	0.000	0.430
TRUCK DRIVER		ALL	1	27.580	0.000	1.5	1.5	2.0	8.600	3.925	0.000	0.000
TRUCK DRIVER		ALL	2	27.980	0.000	1.5	1.5	2.0	8.600	3.925	0.000	0.000
TRUCK DRIVER		ALL	3	28.180	0.000	1.5	1.5	2.0	8.600	3.925	0.000	0.000
TRUCK DRIVER		ALL	4	28.430	0.000	1.5	1.5	2.0	8.600	3.925	0.000	0.000
TRUCK DRIVER		ALL	5	29.180	0.000	1.5	1.5	2.0	8.600	3.925	0.000	0.000

TRUCK DRIVER	O&C 1	22.060	0.000	1.5	1.5	2.0	8.600	3.925	0.000	0.000
TRUCK DRIVER	O&C 2	22.380	0.000	1.5	1.5	2.0	8.600	3.925	0.000	0.000
TRUCK DRIVER	O&C 3	22.540	0.000	1.5	1.5	2.0	8.600	3.925	0.000	0.000
TRUCK DRIVER	O&C 4	22.740	0.000	1.5	1.5	2.0	8.600	3.925	0.000	0.000
TRUCK DRIVER	O&C 5	23.340	0.000	1.5	1.5	2.0	8.600	3.925	0.000	0.000
TUCKPOINTER	BLD	26.010	27.510	1.5	1.5	2.0	6.400	5.700	0.000	0.430

Legend:

M-F>8 (Overtime is required for any hour greater than 8 worked each day, Monday through Friday.)

OSA (Overtime is required for every hour worked on Saturday)

OSH (Overtime is required for every hour worked on Sunday and Holidays)

H/W (Health & Welfare Insurance)

Pensn (Pension)

Vac (Vacation)

Trng (Training)

Explanations

RANDOLPH COUNTY

ELECTRICIANS AND ELECTRONIC SYSTEMS TECHNICIAN (NORTHWEST) - Township of Red Bud.

PLUMBERS & PIPEFITTERS (NORTH) - Towns of Red Bud, Prairie, and Ruma.

PLUMBERS & PIPEFITTERS (SOUTHEAST) - That part of the county East of a line between Ste. Genevieve, Mo. and Rt. 155 then south of a diagonal line to the North-East corner of the county.

PLUMBERS & PIPEFITTERS (WEST) - Towns of Roots, Kellog, Modoc and Prairie DuRocher.

The following list is considered as those days for which holiday rates of wages for work performed apply: New Years Day, Memorial/Decoration Day, Fourth of July, Labor Day, Veterans Day, Thanksgiving Day, Christmas Day. Generally, any of these holidays which fall on a Sunday is celebrated on the following Monday. This then makes work performed on that Monday payable at the appropriate overtime rate for holiday pay. Common practice in a given local may alter certain days of celebration such as the day after Thanksgiving for Veterans Day. If in doubt, please check with IDOL.

Oil and chip resealing (O&C) means the application of road oils and liquid asphalt to coat an existing road surface, followed by application of aggregate chips or gravel to coated surface, and subsequent rolling of material to seal the surface.

EXPLANATION OF CLASSES

ASBESTOS - GENERAL - removal of asbestos material/mold and hazardous materials from any place in a building, including mechanical systems where those mechanical systems are to be removed. This includes the

removal of asbestos materials/mold and hazardous materials from ductwork or pipes in a building when the building is to be demolished at the time or at some close future date.

ASBESTOS - MECHANICAL - removal of asbestos material from mechanical systems, such as pipes, ducts, and boilers, where the mechanical systems are to remain.

CERAMIC TILE FINISHER, MARBLE FINISHER, TERRAZZO FINISHER

Assisting, helping or supporting the tile, marble and terrazzo mechanic by performing their historic and traditional work assignments required to complete the proper installation of the work covered by said crafts. The term "Ceramic" is used for naming the classification only, and is in no a limitation of the product handled. Ceramic takes into consideration most hard tiles.

ELECTRONIC SYSTEMS TECHNICIAN

Installation, service and maintenance of low-voltage systems which utilizes the transmission and/or transference of voice, sound, vision, or digital for commercial, education, security and entertainment purposes for the following: TV monitoring and surveillance, background/foreground music, intercom and telephone interconnect, field programming, inventory control systems, microwave transmission, multi-media, multiplex, radio page, school, intercom and sound burglar alarms and low voltage master clock systems.

Excluded from this classification are energy management systems, life safety systems, supervisory controls and data acquisition systems not intrinsic with the above listed systems, fire alarm systems, nurse call systems and raceways exceeding fifteen feet in length.

TRUCK DRIVER - BUILDING, HEAVY AND HIGHWAY CONSTRUCTION

Class 1. Drivers on 2 axle trucks hauling less than 9 ton. Air compressor and welding machines and brooms, including those pulled by separate units, truck driver helpers, warehouse employees, mechanic helpers, greasers and tiremen, pickup trucks when hauling materials, tools, or workers to and from and on-the-job site, and fork lifts up to 6,000 lb. capacity.

Class 2. Two or three axle trucks hauling more than 9 ton but hauling less than 16 ton. A-frame winch trucks, hydrolift trucks, vactor trucks or similar equipment when used for transportation purposes. Fork lifts over 6,000 lb. capacity, winch trucks, four axle combination units, and ticket writers.

Class 3. Two, three or four axle trucks hauling 16 ton or more. Drivers on water pulls, articulated dump trucks, mechanics and working forepersons, and dispatchers. Five axle or more combination units.

Class 4. Low Boy and Oil Distributors.

Class 5. Drivers who require special protective clothing while employed on hazardous waste work.

TRUCK DRIVER - OIL AND CHIP RESEALING ONLY.

This shall encompass laborers, workers and mechanics who drive contractor or subcontractor owned, leased, or hired pickup, dump, service, or oil distributor trucks. The work includes transporting materials and equipment (including but not limited to, oils, aggregate supplies, parts, machinery and tools) to or from the job site; distributing oil or liquid asphalt and aggregate; stock piling

material when in connection with the actual oil and chip contract. The Truck Driver (Oil & Chip Resealing) wage classification does not include supplier delivered materials.

OPERATING ENGINEERS

GROUP I. Cranes, Dragline, Shovels, Skimmer Scoops, Clamshells or Derrick Boats, Pile Drivers, Crane-Type Backhoes, Asphalt Plant Operators, Concrete Plant Operators, Dredges, Asphalt Spreading Machines, All Locomotives, Cable Ways, or Tower Machines, Hoists, Hydraulic Backhoes, Ditching Machines or Backfiller, Cherrypickers, Overhead Cranes, Roller, Steam or Gas, Concrete Pavers, Excavators, Concrete Breakers, Concrete Pumps, Bulk Cement Plants, Cement Pumps, Derrick-Type Drills, Boat Operators, Motor Graders or Pushcats, Scoops or Tournapulls, Bulldozers, Endloaders or Fork Lifts, Power Blade or Elevating Graders, Winch Cats, Boom or Winch Trucks or Boom Tractors, Pipe Wrapping or Painting Machines, Asphalt Plant Engineer, Journeyman Lubricating Engineer, Drills (other than Derrick Type), Mud Jacks, or Well Drilling Machines, Boring Machines or Track Jacks, Mixers, Conveyors (Two), Air Compressors (Two), Water Pumps regardless of size (Two), Welding Machines (Two), Siphons or Jets (Two), Winch Heads or Apparatuses (Two), Light Plants (Two), Waterblasters (two), All Tractors regardless of size (straight tractor only), Fireman on Stationary Boilers, Automatic Elevators, Form Grading Machines, Finishing Machines, Power Sub-Grader or Ribbon Machines, Longitudinal Floats, Distributor Operators on Trucks, Winch Heads or Apparatuses (One), Mobil Track air and heaters (two to five), Heavy Equipment Greaser, Relief Operator, Assistant Master Mechanic and Heavy Duty Mechanic, all Operators (except those listed below).

GROUP II. Assistant Operators.

GROUP III. Air Compressors (One), Water Pumps, regardless of Size (One), Waterblasters (one), Welding Machine (One), Mixers (One Bag), Conveyor (One), Siphon or Jet (One), Light Plant (One), Heater (One), Immobile Track Air (One), and Self Propelled Walk-Behind Rollers.

GROUP IV. Asphalt Spreader Oilers, Fireman on Whirlies and Heavy Equipment Oilers, Truck Cranes, Dredges, Monigans, Large Cranes - (Over 65-ton rated capacity) Concrete Plant Oiler, Blacktop Plant Oiler, and Creter Crane Oiler (when required).

GROUP V. Oiler.

GROUP VI. Master Mechanics, Operators on equipment with Booms, including jibs, 100 feet and over, and less than 150 feet long.

GROUP VII. Operators on equipment with Booms, including jibs, 150 feet and over, and less than 200 feet long.

GROUP VIII. Operators on Equipment with Booms, including jibs, 200 feet and over; Tower Cranes; Whirlie Cranes; and Operator Foreman.

Other Classifications of Work:

For definitions of classifications not otherwise set out, the Department generally has on file such definitions which are available. If a task to be performed is not subject to one of the classifications of pay set out, the Department will upon being contacted state which neighboring county has such a classification and provide such rate, such rate being deemed to exist by reference in this document. If no neighboring county rate applies to the task, the Department shall undertake a special determination, such special

determination being then deemed to have existed under this determination. If a project requires these, or any classification not listed, please contact IDOL at 618/993-7271 for wage rates or clarifications.

LANDSCAPING

Landscaping work falls under the existing classifications for laborer, operating engineer and truck driver. The work performed by landscape plantsman and landscape laborer is covered by the existing classification of laborer. The work performed by landscape operators (regardless of equipment used or its size) is covered by the classifications of operating engineer. The work performed by landscape truck drivers (regardless of size of truck driven) is covered by the classifications of truck driver.

Bond County Prevailing Wage for May 2008

Trade Name	RG	TYP	C	Base	FRMAN	*M-F>8	OSA	OSH	H/W	Pensn	Vac	Trng
=====	==	==	=	=====	=====	=====	==	==	=====	=====	=====	=====
ASBESTOS ABT-GEN		ALL		23.490	23.990	1.5	1.5	2.0	5.050	9.260	0.000	0.600
ASBESTOS ABT-MEC		BLD		25.690	26.690	1.5	1.5	2.0	5.050	2.500	0.000	0.250
BOILERMAKER		BLD		30.000	32.500	1.5	1.5	2.0	6.820	11.28	1.000	0.300
BRICK MASON		BLD		27.090	28.840	1.5	1.5	2.0	5.250	8.450	2.000	0.400
CARPENTER		ALL		31.230	32.730	1.5	1.5	2.0	5.300	4.000	0.000	0.350
CEMENT MASON		ALL		27.500	28.250	1.5	1.5	2.0	6.000	9.000	0.000	0.200
CERAMIC TILE FNSHER		BLD		23.370	0.000	1.5	1.5	2.0	5.200	4.400	0.000	0.410
ELECTRIC PWR EQMT OP		ALL		31.510	37.980	1.5	2.0	2.0	4.530	7.880	0.000	0.160
ELECTRIC PWR GRNDMAN		ALL		23.530	37.980	1.5	2.0	2.0	3.380	5.890	0.000	0.120
ELECTRIC PWR LINEMAN		ALL		36.220	37.980	1.5	2.0	2.0	5.210	9.060	0.000	0.180
ELECTRIC PWR TRK DRV		ALL		25.710	37.980	1.5	2.0	2.0	3.700	6.430	0.000	0.130
ELECTRICIAN	E	ALL		33.680	35.930	1.5	1.5	2.0	5.150	7.070	0.000	0.500
ELECTRICIAN	W	ALL		33.740	36.760	1.5	1.5	2.0	5.400	6.750	0.000	0.420
ELECTRONIC SYS TECH	E	BLD		26.740	28.240	1.5	1.5	2.0	5.150	3.470	0.000	0.250
ELECTRONIC SYS TECH	W	BLD		26.520	28.020	1.5	1.5	2.0	2.800	6.270	0.000	0.250
ELEVATOR CONSTRUCTOR		BLD		38.715	43.550	2.0	2.0	2.0	8.775	6.960	2.320	0.000
FLOOR LAYER		BLD		27.680	28.430	1.5	1.5	2.0	5.300	4.000	0.000	0.350
GLAZIER		BLD		30.140	0.000	2.0	2.0	2.0	8.800	7.520	2.410	0.310
HT/FROST INSULATOR		BLD		31.240	32.240	1.5	1.5	2.0	5.300	8.860	0.000	0.450
IRON WORKER		ALL		27.350	28.850	1.5	1.5	2.0	6.360	9.150	0.000	0.420
LABORER		ALL		22.990	23.490	1.5	1.5	2.0	5.050	9.260	0.000	0.600
MACHINIST		BLD		38.390	40.390	2.0	2.0	2.0	4.880	6.550	2.650	0.000
MARBLE FINISHERS		BLD		23.370	0.000	1.5	1.5	2.0	5.200	4.400	0.000	0.410
MARBLE MASON		BLD		27.090	28.840	1.5	1.5	2.0	5.250	8.450	2.000	0.400
MILLWRIGHT		ALL		31.230	32.730	1.5	1.5	2.0	5.300	4.000	0.000	0.350
OPERATING ENGINEER		ALL	1	27.000	29.000	1.5	1.5	2.0	6.700	12.35	0.000	1.000
OPERATING ENGINEER		ALL	2	25.870	29.000	1.5	1.5	2.0	6.700	12.35	0.000	1.000
OPERATING ENGINEER		ALL	3	21.390	29.000	1.5	1.5	2.0	6.700	12.35	0.000	1.000
OPERATING ENGINEER		ALL	4	21.450	29.000	1.5	1.5	2.0	6.700	12.35	0.000	1.000
OPERATING ENGINEER		ALL	5	21.120	29.000	1.5	1.5	2.0	6.700	12.35	0.000	1.000
OPERATING ENGINEER		ALL	6	27.550	29.000	1.5	1.5	2.0	6.700	12.35	0.000	1.000
OPERATING ENGINEER		ALL	7	27.850	29.000	1.5	1.5	2.0	6.700	12.35	0.000	1.000
OPERATING ENGINEER		ALL	8	28.130	29.000	1.5	1.5	2.0	6.700	12.35	0.000	1.000
PAINTER		BLD		26.700	28.200	1.5	1.5	2.0	4.700	5.570	0.000	0.350
PAINTER		HWY		27.900	29.400	1.5	1.5	2.0	4.700	5.570	0.000	0.350
PAINTER OVER 30FT		BLD		27.700	29.200	1.5	1.5	2.0	4.700	5.570	0.000	0.350
PAINTER PWR EQMT		BLD		27.700	29.200	1.5	1.5	2.0	4.700	5.570	0.000	0.350
PAINTER PWR EQMT		HWY		28.900	30.400	1.5	1.5	2.0	4.700	5.570	0.000	0.350
PILEDRIVER		ALL		31.230	32.730	1.5	1.5	2.0	5.300	4.000	0.000	0.350
PIPEFITTER		BLD		31.450	33.020	2.0	2.0	2.0	5.350	6.660	0.000	0.200
PLASTERER		BLD		27.900	28.900	1.5	1.5	2.0	6.000	7.750	0.000	0.250
PLUMBER		BLD		31.450	33.020	2.0	2.0	2.0	5.350	6.660	0.000	0.200
ROOFER		BLD		26.750	28.750	1.5	1.5	2.0	6.100	5.900	0.000	0.200
SHEETMETAL WORKER		ALL		28.080	29.580	1.5	1.5	2.0	6.350	5.650	1.690	0.260
SPRINKLER FITTER		BLD		35.140	37.690	1.5	1.5	2.0	7.000	6.200	0.000	0.250
TERRAZZO FINISHER		BLD		31.240	0.000	1.5	1.5	2.0	0.000	0.000	0.000	0.000
TERRAZZO MASON		BLD		31.530	31.830	1.5	1.5	2.0	0.000	4.250	0.000	0.070
TRUCK DRIVER		ALL	1	27.580	0.000	1.5	1.5	2.0	8.600	3.925	0.000	0.000
TRUCK DRIVER		ALL	2	27.980	0.000	1.5	1.5	2.0	8.600	3.925	0.000	0.000
TRUCK DRIVER		ALL	3	28.180	0.000	1.5	1.5	2.0	8.600	3.925	0.000	0.000
TRUCK DRIVER		ALL	4	28.430	0.000	1.5	1.5	2.0	8.600	3.925	0.000	0.000
TRUCK DRIVER		ALL	5	29.180	0.000	1.5	1.5	2.0	8.600	3.925	0.000	0.000
TRUCK DRIVER		O&C	1	22.060	0.000	1.5	1.5	2.0	8.600	3.925	0.000	0.000
TRUCK DRIVER		O&C	2	22.380	0.000	1.5	1.5	2.0	8.600	3.925	0.000	0.000
TRUCK DRIVER		O&C	3	22.540	0.000	1.5	1.5	2.0	8.600	3.925	0.000	0.000
TRUCK DRIVER		O&C	4	22.740	0.000	1.5	1.5	2.0	8.600	3.925	0.000	0.000
TRUCK DRIVER		O&C	5	23.340	0.000	1.5	1.5	2.0	8.600	3.925	0.000	0.000

Legend :

M-F>8 (Overtime is required for any hour greater than 8 worked each day, Monday through Friday.)

OSA (Overtime is required for every hour worked on Saturday)

OSH (Overtime is required for every hour worked on Sunday and Holidays)

H/W (Health & Welfare Insurance)

Pensn (Pension)

Vac (Vacation)

Trng (Training)

Explanations

BOND COUNTY

ELECTRICIANS AND ELECTRONIC SYSTEMS TECHNICIAN (EAST) - Townships of Mulberry Grove, Pleasant Mount & Tamalco.

ELECTRICIANS AND ELECTRONIC SYSTEMS TECHNICIAN (WEST) - Townships of Shoal Creek, LaGrange, Old Ripley, Central, Burgess & Mills

The following list is considered as those days for which holiday rates of wages for work performed apply: New Years Day, Memorial/Decoration Day, Fourth of July, Labor Day, Veterans Day, Thanksgiving Day, Christmas Day. Generally, any of these holidays which fall on a Sunday is celebrated on the following Monday. This then makes work performed on that Monday payable at the appropriate overtime rate for holiday pay. Common practice in a given local may alter certain days of celebration such as the day after Thanksgiving for Veterans Day. If in doubt, please check with IDOL.

Oil and chip resealing (O&C) means the application of road oils and liquid asphalt to coat an existing road surface, followed by application of aggregate chips or gravel to coated surface, and subsequent rolling of material to seal the surface.

EXPLANATION OF CLASSES

ASBESTOS - GENERAL - removal of asbestos material/mold and hazardous materials from any place in a building, including mechanical systems where those mechanical systems are to be removed. This includes the removal of asbestos materials/mold and hazardous materials from ductwork or pipes in a building when the building is to be demolished at the time or at some close future date.

ASBESTOS - MECHANICAL - removal of asbestos material from mechanical systems, such as pipes, ducts, and boilers, where the mechanical systems are to remain.

CERAMIC TILE FINISHER AND MARBLE FINISHER

The handling, at the building site, of all sand, cement, tile, marble or stone and all other materials that may be used and installed by [a] tile layer or marble mason. In addition, the grouting, cleaning,

sealing, and mixing on the job site, and all other work as required in assisting the setter. The term "Ceramic" is used for naming the classification only and is in no way a limitation of the product handled. Ceramic takes into consideration most hard tiles.

ELECTRONIC SYSTEMS TECHNICIAN

Installation, service and maintenance of low-voltage systems which utilizes the transmission and/or transference of voice, sound, vision, or digital for commercial, education, security and entertainment purposes for the following: TV monitoring and surveillance, background/foreground music, intercom and telephone interconnect, field programming, inventory control systems, microwave transmission, multi-media, multiplex, radio page, school, intercom and sound burglar alarms and low voltage master clock systems.

Excluded from this classification are energy management systems, life safety systems, supervisory controls and data acquisition systems not intrinsic with the above listed systems, fire alarm systems, nurse call systems and raceways exceeding fifteen feet in length.

TRUCK DRIVER - BUILDING, HEAVY AND HIGHWAY CONSTRUCTION

Class 1. Drivers on 2 axle trucks hauling less than 9 ton. Air compressor and welding machines and brooms, including those pulled by separate units, truck driver helpers, warehouse employees, mechanic helpers, greasers and tiremen, pickup trucks when hauling materials, tools, or workers to and from and on-the-job site, and fork lifts up to 6,000 lb. capacity.

Class 2. Two or three axle trucks hauling more than 9 ton but hauling less than 16 ton. A-frame winch trucks, hydrolift trucks, vector trucks or similar equipment when used for transportation purposes. Fork lifts over 6,000 lb. capacity, winch trucks, four axle combination units, and ticket writers.

Class 3. Two, three or four axle trucks hauling 16 ton or more. Drivers on water pulls, articulated dump trucks, mechanics and working forepersons, and dispatchers. Five axle or more combination units.

Class 4. Low Boy and Oil Distributors.

Class 5. Drivers who require special protective clothing while employed on hazardous waste work.

TRUCK DRIVER - OIL AND CHIP RESEALING ONLY.

This shall encompass laborers, workers and mechanics who drive contractor or subcontractor owned, leased, or hired pickup, dump, service, or oil distributor trucks. The work includes transporting materials and equipment (including but not limited to, oils, aggregate supplies, parts, machinery and tools) to or from the job site; distributing oil or liquid asphalt and aggregate; stock piling material when in connection with the actual oil and chip contract. The Truck Driver (Oil & Chip Resealing) wage classification does not include supplier delivered materials.

OPERATING ENGINEERS

GROUP I. Cranes, Dragline, Shovels, Skimmer Scoops, Clamshells or Derrick Boats, Pile Drivers, Crane-Type Backhoes, Asphalt Plant Operators, Concrete Plant Operators, Dredges, Asphalt Spreading

Machines, All Locomotives, Cable Ways, or Tower Machines, Hoists, Hydraulic Backhoes, Ditching Machines or Backfiller, Cherrypickers, Overhead Cranes, Roller, Steam or Gas, Concrete Pavers, Excavators, Concrete Breakers, Concrete Pumps, Bulk Cement Plants, Cement Pumps, Derrick-Type Drills, Boat Operators, Motor Graders or Pushcats, Scoops or Tournapulls, Bulldozers, Endloaders or Fork Lifts, Power Blade or Elevating Graders, Winch Cats, Boom or Winch Trucks or Boom Tractors, Pipe Wrapping or Painting Machines, Asphalt Plant Engineer, Journeyman Lubricating Engineer, Drills (other than Derrick Type), Mud Jacks, or Well Drilling Machines, Boring Machines or Track Jacks, Mixers, Conveyors (Two), Air Compressors (Two), Water Pumps regardless of size (Two), Welding Machines (Two), Siphons or Jets (Two), Winch Heads or Apparatuses (Two), Light Plants (Two), Waterblasters (two), All Tractors regardless of size (straight tractor only), Fireman on Stationary Boilers, Automatic Elevators, Form Grading Machines, Finishing Machines, Power Sub-Grader or Ribbon Machines, Longitudinal Floats, Distributor Operators on Trucks, Winch Heads or Apparatuses (One), Mobil Track air and heaters (two to five), Heavy Equipment Greaser, Relief Operator, Assistant Master Mechanic and Heavy Duty Mechanic, all Operators (except those listed below).

GROUP II. Assistant Operators.

GROUP III. Air Compressors (One), Water Pumps, regardless of Size (One), Waterblasters (one), Welding Machine (One), Mixers (One Bag), Conveyor (One), Siphon or Jet (One), Light Plant (One), Heater (One), Immobile Track Air (One), and Self Propelled Walk-Behind Rollers.

GROUP IV. Asphalt Spreader Oilers, Fireman on Whirlies and Heavy Equipment Oilers, Truck Cranes, Dredges, Monigans, Large Cranes - (Over 65-ton rated capacity) Concrete Plant Oiler, Blacktop Plant Oiler, and Creter Crane Oiler (when required).

GROUP V. Oiler.

GROUP VI. Master Mechanics, Operators on equipment with Booms, including jibs, 100 feet and over, and less than 150 feet long.

GROUP VII. Operators on equipment with Booms, including jibs, 150 feet and over, and less than 200 feet long.

GROUP VIII. Operators on Equipment with Booms, including jibs, 200 feet and over; Tower Cranes; Whirlie Cranes; and Operator Foreman.

TERRAZZO FINISHER

The handling of all materials used for Mosaic and Terrazzo work including preparing, mixing by hand, by mixing machine or transporting of pre-mixed materials and distributing with shovel, rake, hoe, or pail, all kinds of concrete foundations necessary for Mosaic and Terrazzo work, all cement terrazzo, magnesite terrazzo, Do-O-Tex terrazzo, epoxy matrix ter-razzo, exposed aggregate, rustic or rough washed for exterior or interior of buildings placed either by machine or by hand, and any other kind of mixture of plastics composed of chips or granules when mixed with cement, rubber, neoprene, vinyl, magnesium chloride or any other resinous or chemical substances used for seamless flooring systems, and all other building materials, all similar materials and all precast terrazzo work on jobs, all scratch coat used for Mosaic and Terrazzo work and sub-bed, tar paper and wire mesh (2x2 etc.) or lath. The rubbing, grinding, cleaning and finishing of same either by hand or by machine or by terrazzo resurfacing equipment on new or existing floors. When necessary finishers shall be allowed to assist the mechanics to spread sand bed,

lay tarpaper and wire mesh (2x2 etc.) or lath. The finishing of cement floors where additional aggregate of stone is added by spreading or sprinkling on top of the finished base, and troweled or rolled into the finish and then the surface is ground by grinding machines.

Other Classifications of Work:

For definitions of classifications not otherwise set out, the Department generally has on file such definitions which are available. If a task to be performed is not subject to one of the classifications of pay set out, the Department will upon being contacted state which neighboring county has such a classification and provide such rate, such rate being deemed to exist by reference in this document. If no neighboring county rate applies to the task, the Department shall undertake a special determination, such special determination being then deemed to have existed under this determination. If a project requires these, or any classification not listed, please contact IDOL at 618/993-7271 for wage rates or clarifications.

LANDSCAPING

Landscaping work falls under the existing classifications for laborer, operating engineer and truck driver. The work performed by landscape plantsman and landscape laborer is covered by the existing classification of laborer. The work performed by landscape operators (regardless of equipment used or its size) is covered by the classifications of operating engineer. The work performed by landscape truck drivers (regardless of size of truck driven) is covered by the classifications of truck driver.