

If you plan to submit a bid directly to the Department of Transportation

PREQUALIFICATION

Any contractor who desires to become pre-qualified to bid on work advertised by IDOT must submit the properly completed pre-qualification forms to the Bureau of Construction no later than 4:30 p.m. prevailing time twenty-one days prior to the letting of interest. This pre-qualification requirement applies to first time contractors, contractors renewing expired ratings, contractors maintaining continuous pre-qualification or contractors requesting revised ratings. To be eligible to bid, existing pre-qualification ratings must be effective through the date of letting.

REQUESTS FOR AUTHORIZATION TO BID

Contractors downloading and/or ordering CD-ROM's and are wanting to bid on items included in a particular letting must submit the properly completed "Request for Authorization to Bid/or Not For Bid Status" (BDE 124INT) and the ORIGINAL, signed and notarized, "Affidavit of Availability" (BC 57) to the proper office no later than 4:30 p.m. prevailing time, three (3) days prior to the letting date.

WHO CAN BID ?

Bids will be accepted from only those companies that request and receive written **Authorization to Bid** from IDOT's Central Bureau of Construction.

WHAT CONSTITUTES WRITTEN AUTHORIZATION TO BID? When a prospective prime bidder submits a "Request for Authorization to Bid/or Not For Bid Status"(BDE 124INT) he/she must indicate at that time which items are being requested For Bidding purposes. Only those items requested For Bidding will be analyzed. After the request has been analyzed, the bidder will be issued a **Proposal Denial and/or Authorization Form**, approved by the Central Bureau of Construction, that indicates which items have been approved For Bidding. If **Authorization to Bid** cannot be approved, the **Proposal Denial and/or Authorization Form** will indicate the reason for denial.

ABOUT AUTHORIZATION TO BID: Firms that have not received an authorization form within a reasonable time of complete and correct original document submittal should contact the department as to status. This is critical in the week before the letting. These documents must be received three days before the letting date. Firms unsure as to authorization status should call the Prequalification Section of the Bureau of Construction at the number listed at the end of these instructions.

ADDENDA AND REVISIONS: It is the contractor's responsibility to determine which, if any, addenda or revisions pertain to any project they may be bidding. Failure to incorporate all relevant addenda or revisions may cause the bid to be declared unacceptable.

Each addendum will be placed with the contract number. Addenda and revisions will also be placed on the Addendum/Revision Checklist and each subscription service subscriber will be notified by e-mail of each addendum and revision issued.

The Internet is the Department's primary way of doing business. The subscription server e-mails are an added courtesy the Department provides. It is suggested that bidder check IDOT's website <http://www.dot.il.gov/desenv/delett.html> before submitting final bid information.

IDOT is not responsible for any e-mail related failures.

Addenda Questions may be directed to the Contracts Office at (217)782-7806 or D&Econtracts@dot.il.gov

Technical Questions about downloading these files may be directed to Tim Garman (217)524-1642 or Timothy.Garman@illinois.gov.

WHAT MUST BE INCLUDED WHEN BIDS ARE SUBMITTED?: Bidders need not return the entire proposal when bids are submitted. That portion of the proposal that must be returned includes the following:

1. All documents from the Proposal Cover Sheet through the Proposal Bid Bond
2. Other special documentation and/or information that may be required by the contract special provisions

All proposal documents, including Proposal Guaranty Checks or Proposal Bid Bonds, should be stapled together to prevent loss when bids are processed by IDOT personnel.

ABOUT SUBMITTING BIDS: It is recommended that bidders deliver bids in person to insure they arrive at the proper location prior to the time specified for the receipt of bids. Any bid received at the place of letting after the time specified will not be accepted.

WHO SHOULD BE CALLED IF ASSISTANCE IS NEEDED?

Questions Regarding	Call
Prequalification and/or Authorization to Bid	(217)782-3413
Preparation and submittal of bids	(217)782-7806
Mailing of plans and proposals	(217)782-7806
Electronic plans and proposals	(217)524-1642

ADDENDUMS AND REVISIONS TO THE PROPOSAL FORMS

Planholders should verify that they have received and incorporated the addendum and/or revision prior to submitting their bid. Failure by the bidder to include an addendum could result in a bid being rejected as irregular.

83

RETURN WITH BID

Proposal Submitted By
Name
Address
City

Letting June 13, 2008

BIDDERS NEED NOT RETURN THE ENTIRE PROPOSAL
(See instructions inside front cover)

NOTICE TO PROSPECTIVE BIDDERS

This proposal can be used for bidding purposes by only those companies that request and receive written AUTHORIZATION TO BID from IDOT's Central Bureau of Construction.
(SEE INSTRUCTIONS ON THE INSIDE OF COVER)

Notice To Bidders, Specifications, Proposal, Contract and Contract Bond



Illinois Department
of Transportation

Springfield, Illinois 62764

Contract No. 76C12
Various Counties
Section D-8 ANNUAL PATCHING 2009-2
District 8 Construction Funds
Various Routes

PLEASE MARK THE APPROPRIATE BOX BELOW:

- A Bid Bond is included.
- A Cashier's Check or a Certified Check is included.

Plans Included
Herein

Prepared by

S

Checked by

(Printed by authority of the State of Illinois)

INSTRUCTIONS

ABOUT IDOT PROPOSALS: All proposals issued by IDOT are potential bidding proposals. Each proposal contains all Certifications and Affidavits, a Proposal Signature Sheet and a Proposal Bid Bond required for Prime Contractors to submit a bid after written **Authorization to Bid** has been issued by IDOT's Central Bureau of Construction.

WHO CAN BID?: Bids will be accepted from only those companies that request and receive written **Authorization to Bid** from IDOT's Central Bureau of Construction. To request authorization, a potential bidder must complete and submit Part B of the Request for Authorization to Bid/or Not For Bid Status form (BDE 124 INT) and submit an original Affidavit of Availability (BC 57).

WHAT CONSTITUTES WRITTEN AUTHORIZATION TO BID?: When a prospective prime bidder submits a "Request for Proposal Forms and Plans" he/she must indicate at that time which items are being requested For Bidding purposes. Only those items requested For Bidding will be analyzed. After the request has been analyzed, the bidder will be issued a **Proposal Denial and/or Authorization Form**, approved by the Central Bureau of Construction, that indicates which items have been approved For Bidding. If **Authorization to Bid** cannot be approved, the **Proposal Denial and/or Authorization Form** will indicate the reason for denial. If a contractor has requested to bid but has not received a **Proposal Denial and/or Authorization Form**, they should contact the Central Bureau of Construction in advance of the letting date.

WHAT MUST BE INCLUDED WHEN BIDS ARE SUBMITTED?: Bidders need not return the entire proposal when bids are submitted. That portion of the proposal that must be returned includes the following:

1. All documents from the Proposal Cover Sheet through the Proposal Bid Bond
2. Other special documentation and/or information that may be required by the contract special provisions

All proposal documents, including Proposal Guaranty Checks or Proposal Bid Bonds, should be stapled together to prevent loss when bids are processed by IDOT personnel.

ABOUT SUBMITTING BIDS: It is recommended that bidders deliver bids in person to insure they arrive at the proper location prior to the time specified for the receipt of bids. Any bid received at the place of letting after the time specified will not be accepted.

WHO SHOULD BE CALLED IF ASSISTANCE IS NEEDED?

Questions Regarding	Call
Prequalification and/or Authorization to Bid	217/782-3413
Preparation and submittal of bids	217/782-7806
Mailing of CD-ROMS	217/782-7806

RETURN WITH BID



PROPOSAL

TO THE DEPARTMENT OF TRANSPORTATION

1. Proposal of _____

Taxpayer Identification Number (Mandatory) _____ a

for the improvement identified and advertised for bids in the Invitation for Bids as:

Contract No. 76C12
Various Counties
Section D-8 ANNUAL PATCHING 2009-2
Various Routes
District 8 Construction Funds

Pavement patching at various locations in the district.

2. The undersigned bidder will furnish all labor, material and equipment to complete the above described project in a good and workmanlike manner as provided in the contract documents provided by the Department of Transportation. This proposal will become part of the contract and the terms and conditions contained in the contract documents shall govern performance and payments.

RETURN WITH BID

3. **ASSURANCE OF EXAMINATION AND INSPECTION/WAIVER.** The undersigned further declares that he/she has carefully examined the proposal, plans, specifications, form of contract and contract bond, and special provisions, and that he/she has inspected in detail the site of the proposed work, and that he/she has familiarized themselves with all of the local conditions affecting the contract and the detailed requirements of construction, and understands that in making this proposal he/she waives all right to plead any misunderstanding regarding the same.
4. **EXECUTION OF CONTRACT AND CONTRACT BOND.** The undersigned further agrees to execute a contract for this work and present the same to the department within fifteen (15) days after the contract has been mailed to him/her. The undersigned further agrees that he/she and his/her surety will execute and present within fifteen (15) days after the contract has been mailed to him/her contract bond satisfactory to and in the form prescribed by the Department of Transportation, in the penal sum of the full amount of the contract, guaranteeing the faithful performance of the work in accordance with the terms of the contract.
5. **PROPOSAL GUARANTY.** Accompanying this proposal is either a bid bond on the department form, executed by a corporate surety company satisfactory to the department, or a proposal guaranty check consisting of a bank cashier's check or a properly certified check for not less than 5 per cent of the amount bid or for the amount specified in the following schedule:

<u>Amount of Bid</u>		<u>Proposal Guaranty</u>	<u>Amount of Bid</u>		<u>Proposal Guaranty</u>	
Up to	\$5,000	\$150	\$2,000,000	to	\$3,000,000	\$100,000
\$5,000	to \$10,000	\$300	\$3,000,000	to	\$5,000,000	\$150,000
\$10,000	to \$50,000	\$1,000	\$5,000,000	to	\$7,500,000	\$250,000
\$50,000	to \$100,000	\$3,000	\$7,500,000	to	\$10,000,000	\$400,000
\$100,000	to \$150,000	\$5,000	\$10,000,000	to	\$15,000,000	\$500,000
\$150,000	to \$250,000	\$7,500	\$15,000,000	to	\$20,000,000	\$600,000
\$250,000	to \$500,000	\$12,500	\$20,000,000	to	\$25,000,000	\$700,000
\$500,000	to \$1,000,000	\$25,000	\$25,000,000	to	\$30,000,000	\$800,000
\$1,000,000	to \$1,500,000	\$50,000	\$30,000,000	to	\$35,000,000	\$900,000
\$1,500,000	to \$2,000,000	\$75,000	over		\$35,000,000	\$1,000,000

Bank cashier's checks or properly certified checks accompanying proposals shall be made payable to the Treasurer, State of Illinois, when the state is awarding authority; the county treasurer, when a county is the awarding authority; or the city, village, or town treasurer, when a city, village, or town is the awarding authority.

If a combination bid is submitted, the proposal guaranties which accompany the individual proposals making up the combination will be considered as also covering the combination bid.

The amount of the proposal guaranty check is _____ \$(_____). If this proposal is accepted and the undersigned shall fail to execute a contract bond as required herein, it is hereby agreed that the amount of the proposal guaranty shall become the property of the State of Illinois, and shall be considered as payment of damages due to delay and other causes suffered by the State because of the failure to execute said contract and contract bond; otherwise, the bid bond shall become void or the proposal guaranty check shall be returned to the undersigned.

Attach Cashier's Check or Certified Check Here	
In the event that one proposal guaranty check is intended to cover two or more proposals, the amount must be equal to the sum of the proposal guaranties which would be required for each individual proposal. If the guaranty check is placed in another proposal, state below where it may be found.	
The proposal guaranty check will be found in the proposal for:	Item _____
	Section No. _____
	County _____

Mark the proposal cover sheet as to the type of proposal guaranty submitted.

RETURN WITH BID

6. **COMBINATION BIDS.** The undersigned further agrees that if awarded the contract for the sections contained in the following combination, he/she will perform the work in accordance with the requirements of each individual proposal comprising the combination bid specified in the schedule below, and that the combination bid shall be prorated against each section in proportion to the bid submitted for the same. If an error is found to exist in the gross sum bid for one or more of the individual sections included in a combination, the combination bid shall be corrected as provided in the specifications.

When a combination bid is submitted, the schedule below must be completed in each proposal comprising the combination.

If alternate bids are submitted for one or more of the sections comprising the combination, a combination bid must be submitted for each alternate.

Schedule of Combination Bids

Combination No.	Sections Included in Combination	Combination Bid	
		Dollars	Cents

7. **SCHEDULE OF PRICES.** The undersigned bidder submits herewith, in accordance with the rules and instructions, a schedule of prices for the items of work for which bids are sought. The unit prices bid are in U.S. dollars and cents, and all extensions and summations have been made. The bidder understands that the quantities appearing in the bid schedule are approximate and are provided for the purpose of obtaining a gross sum for the comparison of bids. If there is an error in the extension of the unit prices, the unit prices shall govern. Payment to the contractor awarded the contract will be made only for actual quantities of work performed and accepted or materials furnished according to the contract. The scheduled quantities of work to be done and materials to be furnished may be increased, decreased or omitted as provided elsewhere in the contract.

8. **CERTIFICATE OF AUTHORITY.** The undersigned bidder, if a business organized under the laws of another State, assures the Department that it will furnish a copy of its certificate of authority to do business in the State of Illinois with the return of the executed contract and bond. Failure to furnish the certificate within the time provided for execution of an awarded contract may be cause for cancellation of the award and forfeiture of the proposal guaranty to the State.

ILLINOIS DEPARTMENT OF TRANSPORTATION
 SCHEDULE OF PRICES
 CONTRACT
 NUMBER - 76C12

State Job # - C-98-080-08
 PPS NBR - 8-89313-1901
 County Name - VARIOUS- -
 Code - 0 - -
 District - 8 - -
 Section Number - D-8 ANNUAL PATCHING 2009-2

Project Number

Route
 VARIOUS

Item Number	Pay Item Description	Unit of Measure	Quantity	x	Unit Price	=	Total Price
X0320006	PAVT REPLACEMENT CONC	CU YD	400.000				
X0320007	PAVT REPLACEMENT BIT	CU YD	45.000				
X0322662	TEMPORARY SIGNING	EACH	10.000				
X0329860	PAVT REPLACE CONC SPL	CU YD	15.000				
X0329900	PVT REM FOR PATCH CA	CU YD	200.000				
X0329901	PVT REM FOR PATCH CB	CU YD	150.000				
X0329902	PVT REM FOR PATCH CC	CU YD	100.000				
X7012610	TRAF CONT-PROT 701201	EACH	4.000				
X7012620	TR CONT & PROT 701501	EACH	2.000				
X7012625	TR CONT & PROT 701606	EACH	3.000				
X7012630	TR CONT & PROT 701601	EACH	3.000				
Z0002700	BARRICADES	EACH	100.000				
Z0008759	CALL OUT	EACH	6.000				
Z0017099	DOWEL BAR ASSEMBLY	EACH	8.000				
Z0018900	DRILL-GROUT DOW BARS	EACH	300.000				

ILLINOIS DEPARTMENT OF TRANSPORTATION
 SCHEDULE OF PRICES
 CONTRACT
 NUMBER - 76C12

State Job # - C-98-080-08
 PPS NBR - 8-89313-1901
 County Name - VARIOUS- -
 Code - 0 - -
 District - 8 - -
 Section Number - D-8 ANNUAL PATCHING 2009-2

Project Number

Route
 VARIOUS

Item Number	Pay Item Description	Unit of Measure	Quantity	x	Unit Price	=	Total Price
Z0021400	EXPANSION JOINT SPL	FOOT	50.000				
Z0024430	FLAGGER	HOURL	25.000				
Z0075310	TIE BARS 3/4	EACH	180.000				
44201294	CL B PATCH-EXPAN JT	FOOT	50.000				
44213100	PAVEMENT FABRIC	SQ YD	350.000				
44213200	SAW CUTS	FOOT	4,400.000				
50800105	REINFORCEMENT BARS	POUND	4,400.000				
60100080	FRENCH DRAINS	CU YD	25.000				
60107600	PIPE UNDERDRAINS 4	FOOT	50.000				
70100205	TRAF CONT-PROT 701401	EACH	7.000				
70100315	TRAF CONT-PROT 701422	EACH	4.000				
70100420	TRAF CONT-PROT 701411	EACH	4.000				
70100430	TRAF CONT-PROT 701446	EACH	2.000				
70101805	TRAF CONT & PROT SPL	EACH	4.000				
70103815	TR CONT SURVEILLANCE	CAL DA	15.000				

CONTRACT NUMBER

76C12

THIS IS THE TOTAL BID

\$ _____

NOTES:

- 1. Each PAY ITEM should have a UNIT PRICE and a TOTAL PRICE.**
- 2. The UNIT PRICE shall govern if no TOTAL PRICE is shown or if there is a discrepancy between the product of the UNIT PRICE multiplied by the QUANTITY.**
- 3. If a UNIT PRICE is omitted, the TOTAL PRICE will be divided by the QUANTITY in order to establish a UNIT PRICE.**
- 4. A bid may be declared UNACCEPTABLE if neither a unit price nor a total price is shown.**

RETURN WITH BID

STATE REQUIRED ETHICAL STANDARDS GOVERNING CONTRACT PROCUREMENT: ASSURANCES, CERTIFICATIONS AND DISCLOSURES

I. GENERAL

A. Article 50 of the Illinois Procurement Code establishes the duty of all State chief procurement officers, State purchasing officers, and their designees to maximize the value of the expenditure of public moneys in procuring goods, services, and contracts for the State of Illinois and to act in a manner that maintains the integrity and public trust of State government. In discharging this duty, they are charged by law to use all available information, reasonable efforts, and reasonable actions to protect, safeguard, and maintain the procurement process of the State of Illinois.

B. In order to comply with the provisions of Article 50 and to carry out the duty established therein, all bidders are to adhere to ethical standards established for the procurement process, and to make such assurances, disclosures and certifications required by law. By execution of the Proposal Signature Sheet, the bidder indicates that each of the mandated assurances has been read and understood, that each certification is made and understood, and that each disclosure requirement has been understood and completed.

C. In addition to all other remedies provided by law, failure to comply with any assurance, failure to make any disclosure or the making of a false certification shall be grounds for termination of the contract and the suspension or debarment of the bidder.

II. ASSURANCES

A. The assurances hereinafter made by the bidder are each a material representation of fact upon which reliance is placed should the Department enter into the contract with the bidder. The Department may terminate the contract if it is later determined that the bidder rendered a false or erroneous assurance, and the surety providing the performance bond shall be responsible for the completion of the contract.

B. Felons

1. The Illinois Procurement Code provides:

Section 50-10. Felons. Unless otherwise provided, no person or business convicted of a felony shall do business with the State of Illinois or any state agency from the date of conviction until 5 years after the date of completion of the sentence for that felony, unless no person held responsible by a prosecutorial office for the facts upon which the conviction was based continues to have any involvement with the business.

2. The bidder assures the Department that the award and execution of the contract would not cause a violation of Section 50-10.

C. Conflicts of Interest

1. The Illinois Procurement Code provides in pertinent part:

Section 50-13. Conflicts of Interest.

(a) Prohibition. It is unlawful for any person holding an elective office in this State, holding a seat in the General Assembly, or appointed to or employed in any of the offices or agencies of state government and who receives compensation for such employment in excess of 60% of the salary of the Governor of the State of Illinois, or who is an officer or employee of the Capital Development Board or the Illinois Toll Highway Authority, or who is the spouse or minor child of any such person to have or acquire any contract, or any direct pecuniary interest in any contract therein, whether for stationery, printing, paper, or any services, materials, or supplies, that will be wholly or partially satisfied by the payment of funds appropriated by the General Assembly of the State of Illinois or in any contract of the Capital Development Board or the Illinois Toll Highway authority.

(b) Interests. It is unlawful for any firm, partnership, association or corporation, in which any person listed in subsection (a) is entitled to receive (i) more than 7 1/2% of the total distributable income or (ii) an amount in excess of the salary of the Governor, to have or acquire any such contract or direct pecuniary interest therein.

(c) Combined interests. It is unlawful for any firm, partnership, association, or corporation, in which any person listed in subsection (a) together with his or her spouse or minor children is entitled to receive (i) more than 15%, in the aggregate, of the total distributable income or (ii) an amount in excess of 2 times the salary of the Governor, to have or acquire any such contract or direct pecuniary interest therein.

(d) Securities. Nothing in this Section invalidates the provisions of any bond or other security previously offered or to be offered for sale or sold by or for the State of Illinois.

(e) Prior interests. This Section does not affect the validity of any contract made between the State and an officer or employee of the State or member of the General Assembly, his or her spouse, minor child or any combination of those persons if that contract was in existence before his or her election or employment as an officer, member, or employee. The contract is voidable, however, if it cannot be completed within 365 days after the officer, member, or employee takes office or is employed.

The current salary of the Governor is \$171,000.00. Sixty percent of the salary is \$102,600.00.

RETURN WITH BID

2. The bidder assures the Department that the award and execution of the contract would not cause a violation of Section 50-13, or that an effective exemption has been issued by the Board of Ethics to any individual subject to the Section 50-13 prohibitions pursuant to the provisions of Section 50-20 of the Code and Executive Order Number 3 (1998). Information concerning the exemption process is available from the Department upon request.

D. Negotiations

1. The Illinois Procurement Code provides in pertinent part:

Section 50-15. Negotiations.

(a) It is unlawful for any person employed in or on a continual contractual relationship with any of the offices or agencies of State government to participate in contract negotiations on behalf of that office or agency with any firm, partnership, association, or corporation with whom that person has a contract for future employment or is negotiating concerning possible future employment.

2. The bidder assures the Department that the award and execution of the contract would not cause a violation of Section 50-15, and that the bidder has no knowledge of any facts relevant to the kinds of acts prohibited therein.

E. Inducements

1. The Illinois Procurement Code provides:

Section 50-25. Inducement. Any person who offers or pays any money or other valuable thing to any person to induce him or her not to bid for a State contract or as recompense for not having bid on a State contract is guilty of a Class 4 felony. Any person who accepts any money or other valuable thing for not bidding for a State contract or who withholds a bid in consideration of the promise for the payment of money or other valuable thing is guilty of a Class 4 felony.

2. The bidder assures the Department that the award and execution of the contract would not cause a violation of Section 50-25, and that the bidder has no knowledge of any facts relevant to the kinds of acts prohibited therein.

F. Revolving Door Prohibition

1. The Illinois Procurement Code provides:

Section 50-30. Revolving door prohibition. Chief procurement officers, associate procurement officers, State purchasing officers, their designees whose principal duties are directly related to State procurement, and executive officers confirmed by the Senate are expressly prohibited for a period of 2 years after terminating an affected position from engaging in any procurement activity relating to the State agency most recently employing them in an affected position for a period of at least 6 months. The prohibition includes, but is not limited to: lobbying the procurement process; specifying; bidding; proposing bid, proposal, or contract documents; on their own behalf or on behalf of any firm, partnership, association, or corporation. This Section applies only to persons who terminate an affected position on or after January 15, 1999.

2. The bidder assures the Department that the award and execution of the contract would not cause a violation of Section 50-30, and that the bidder has no knowledge of any facts relevant to the kinds of acts prohibited therein.

G. Reporting Anticompetitive Practices

1. The Illinois Procurement Code provides:

Section 50-40. Reporting anticompetitive practices. When, for any reason, any vendor, bidder, contractor, chief procurement officer, State purchasing officer, designee, elected official, or State employee suspects collusion or other anticompetitive practice among any bidders, offerors, contractors, proposers, or employees of the State, a notice of the relevant facts shall be transmitted to the Attorney General and the chief procurement officer.

2. The bidder assures the Department that it has not failed to report any relevant facts concerning the practices addressed in Section 50-40 which may involve the contract for which the bid is submitted.

H. Confidentiality

1. The Illinois Procurement Code provides:

Section 50-45. Confidentiality. Any chief procurement officer, State purchasing officer, designee, or executive officer who willfully uses or allows the use of specifications, competitive bid documents, proprietary competitive information, proposals, contracts, or selection information to compromise the fairness or integrity of the procurement, bidding, or contract process shall be subject to immediate dismissal, regardless of the Personnel code, any contract, or any collective bargaining agreement, and may in addition be subject to criminal prosecution.

2. The bidder assures the Department that it has no knowledge of any fact relevant to the practices addressed in Section 50-45 which may involve the contract for which the bid is submitted.

RETURN WITH BID

I. Insider Information

1. The Illinois Procurement Act provides:

Section 50-50. Insider information. It is unlawful for any current or former elected or appointed State official or State employee to knowingly use confidential information available only by virtue of that office or employment for actual or anticipated gain for themselves or another person.

2. The bidder assures the Department that it has no knowledge of any facts relevant to the practices addressed in Section 50-50 which may involve the contract for which the bid is submitted.

III. CERTIFICATIONS

A. The certifications hereinafter made by the bidder are each a material representation of fact upon which reliance is placed should the Department enter into the contract with the bidder. The Department may terminate the contract if it is later determined that the bidder rendered a false or erroneous certification, and the surety providing the performance bond shall be responsible for completion of the contract.

B. Bribery

1. The Illinois Procurement Code provides:

Section 50-5. Bribery.

(a) Prohibition. No person or business shall be awarded a contract or subcontract under this Code who:

(1) has been convicted under the laws of Illinois or any other state of bribery or attempting to bribe an officer or employee of the State of Illinois or any other state in that officer's or employee's official capacity; or

(2) has made an admission of guilt of that conduct that is a matter of record but has not been prosecuted for that conduct.

(b) Businesses. No business shall be barred from contracting with any unit of State or local government as a result of a conviction under this Section of any employee or agent of the business if the employee or agent is no longer employed by the business and:

(1) the business has been finally adjudicated not guilty; or

(2) the business demonstrates to the governmental entity with which it seeks to contract, and that entity finds that the commission of the offense was not authorized, requested, commanded, or performed by a director, officer, or high managerial agent on behalf of the business as provided in paragraph (2) of subsection (a) of Section 5-4 of the Criminal Code of 1961.

(c) Conduct on behalf of business. For purposes of this Section, when an official, agent, or employee of a business committed the bribery or attempted bribery on behalf of the business and in accordance with the direction or authorization of a responsible official of the business, the business shall be chargeable with the conduct.

(d) Certification. Every bid submitted to and contract executed by the State shall contain a certification by the contractor that the contractor is not barred from being awarded a contract or subcontract under this Section. A contractor who makes a false statement, material to the certification, commits a Class 3 felony.

2. The bidder certifies that it is not barred from being awarded a contract under Section 50.5.

C. Educational Loan

1. Section 3 of the Educational Loan Default Act provides:

§ 3. No State agency shall contract with an individual for goods or services if that individual is in default, as defined in Section 2 of this Act, on an educational loan. Any contract used by any State agency shall include a statement certifying that the individual is not in default on an educational loan as provided in this Section.

2. The bidder, if an individual as opposed to a corporation, partnership or other form of business organization, certifies that the bidder is not in default on an educational loan as provided in Section 3 of the Act.

D. Bid-Rigging/Bid Rotating

1. Section 33E-11 of the Criminal Code of 1961 provides:

§ 33E-11. (a) Every bid submitted to and public contract executed pursuant to such bid by the State or a unit of local government shall contain a certification by the prime contractor that the prime contractor is not barred from contracting with any unit of State or local government as a result of a violation of either Section 33E-3 or 33E-4 of this Article. The State and units of local government shall provide the appropriate forms for such certification.

RETURN WITH BID

(b) A contractor who makes a false statement, material to the certification, commits a Class 3 felony.

A violation of Section 33E-3 would be represented by a conviction of the crime of bid-rigging which, in addition to Class 3 felony sentencing, provides that any person convicted of this offense or any similar offense of any state or the United States which contains the same elements as this offense shall be barred for 5 years from the date of conviction from contracting with any unit of State or local government. No corporation shall be barred from contracting with any unit of State or local government as a result of a conviction under this Section of any employee or agent of such corporation if the employee so convicted is no longer employed by the corporation and: (1) it has been finally adjudicated not guilty or (2) if it demonstrates to the governmental entity with which it seeks to contract and that entity finds that the commission of the offense was neither authorized, requested, commanded, nor performed by a director, officer or a high managerial agent in behalf of the corporation.

A violation of Section 33E-4 would be represented by a conviction of the crime of bid-rotating which, in addition to Class 2 felony sentencing, provides that any person convicted of this offense or any similar offense of any state or the United States which contains the same elements as this offense shall be permanently barred from contracting with any unit of State or local government. No corporation shall be barred from contracting with any unit of State or local government as a result of a conviction under this Section of any employee or agent of such corporation if the employee so convicted is no longer employed by the corporation and: (1) it has been finally adjudicated not guilty or (2) if it demonstrates to the governmental entity with which it seeks to contract and that entity finds that the commission of the offense was neither authorized, requested, commanded, nor performed by a director, officer or a high managerial agent in behalf of the corporation.

2. The bidder certifies that it is not barred from contracting with the Department by reason of a violation of either Section 33E-3 or Section 33E-4.

E. International Anti-Boycott

1. Section 5 of the International Anti-Boycott Certification Act provides:

§ 5. State contracts. Every contract entered into by the State of Illinois for the manufacture, furnishing, or purchasing of supplies, material, or equipment or for the furnishing of work, labor, or services, in an amount exceeding the threshold for small purchases according to the purchasing laws of this State or \$10,000.00, whichever is less, shall contain certification, as a material condition of the contract, by which the contractor agrees that neither the contractor nor any substantially-owned affiliated company is participating or shall participate in an international boycott in violation of the provisions of the U.S. Export Administration Act of 1979 or the regulations of the U.S. Department of Commerce promulgated under that Act.

2. The bidder makes the certification set forth in Section 5 of the Act.

F. Drug Free Workplace

1. The Illinois "Drug Free Workplace Act" applies to this contract and it is necessary to comply with the provisions of the "Act" if the contractor is a corporation, partnership, or other entity (including a sole proprietorship) which has 25 or more employees.

2. The bidder certifies that if awarded a contract in excess of \$5,000 it will provide a drug free workplace by:

(a) Publishing a statement notifying employees that the unlawful manufacture, distribution, dispensation, possession or use of a controlled substance, including cannabis, is prohibited in the contractor's workplace; specifying the actions that will be taken against employees for violations of such prohibition; and notifying the employee that, as a condition of employment on such contract, the employee shall abide by the terms of the statement, and notify the employer of any criminal drug statute conviction for a violation occurring in the workplace no later than five (5) days after such conviction.

(b) Establishing a drug free awareness program to inform employees about the dangers of drug abuse in the workplace; the contractor's policy of maintaining a drug free workplace; any available drug counseling, rehabilitation, and employee assistance programs; and the penalties that may be imposed upon employees for drug violations.

(c) Providing a copy of the statement required by subparagraph (1) to each employee engaged in the performance of the contract and to post the statement in a prominent place in the workplace.

(d) Notifying the Department within ten (10) days after receiving notice from an employee or otherwise receiving actual notice of the conviction of an employee for a violation of any criminal drug statute occurring in the workplace.

(e) Imposing or requiring, within 30 days after receiving notice from an employee of a conviction or actual notice of such a conviction, an appropriate personnel action, up to and including termination, or the satisfactory participation in a drug abuse assistance or rehabilitation program approved by a federal, state or local health, law enforcement or other appropriate agency.

(f) Assisting employees in selecting a course of action in the event drug counseling, treatment, and rehabilitation is required and indicating that a trained referral team is in place.

(g) Making a good faith effort to continue to maintain a drug free workplace through implementation of the actions and efforts stated in this certification.

G. Debt Delinquency

1. The Illinois Procurement Code provides:

Section 50-11 and 50-12. Debt Delinquency.

The contractor or bidder certifies that it, or any affiliate, is not barred from being awarded a contract under 30 ILCS 500. Section 50-11 prohibits a person from entering into a contract with a State agency if it knows or should know that it, or any affiliate, is delinquent in the payment of any debt to the State as defined by the Debt Collection Board. Section 50-12 prohibits a person from entering into a contract with a State agency if it, or any affiliate, has failed to collect and remit Illinois Use Tax on all sales of tangible personal property into the State of Illinois in accordance with the provisions of the Illinois Use Tax Act. The contractor further acknowledges that the contracting State agency may declare the contract void if this certification is false or if the contractor, or any affiliate, is determined to be delinquent in the payment of any debt to the State during the term of the contract.

H. Sarbanes-Oxley Act of 2002

1. The Illinois Procurement Code provides:

Section 50-60(c).

The contractor certifies in accordance with 30 ILCS 500/50-10.5 that no officer, director, partner or other managerial agent of the contracting business has been convicted of a felony under the Sarbanes-Oxley Act of 2002 or a Class 3 or Class 2 felony under the Illinois Securities Law of 1953 for a period of five years prior to the date of the bid or contract. The contractor acknowledges that the contracting agency shall declare the contract void if this certification is false.

I. Addenda

The contractor or bidder certifies that all relevant addenda have been incorporated in to this contract. Failure to do so may cause the bid to be declared unacceptable.

J. Section 42 of the Environmental Protection Act

The contractor certifies in accordance with 30 ILCS 500/50-12 that the bidder or contractor is not barred from being awarded a contract under this Section which prohibits the bidding on or entering into contracts with the State of Illinois or a State agency by a person or business found by a court or the Pollution Control Board to have committed a willful or knowing violation of Section 42 of the Environmental Protection Act for a period of five years from the date of the order. The contractor acknowledges that the contracting agency may declare the contract void if this certification is false.

K. Apprenticeship and Training Certification (Does not apply to federal aid projects)

In accordance with the provisions of Section 30-22 (6) of the Illinois Procurement Code, the bidder certifies that it is a participant, either as an individual or as part of a group program, in the approved apprenticeship and training programs applicable to each type of work or craft that the bidder will perform with its own forces. The bidder further certifies for work that will be performed by subcontract that each of its subcontractors submitted for approval either (a) is, at the time of such bid, participating in an approved, applicable apprenticeship and training program; or (b) will, prior to commencement of performance of work pursuant to this contract, begin participation in an approved apprenticeship and training program applicable to the work of the subcontract. The Department, at any time before or after award, may require the production of a copy of each applicable Certificate of Registration issued by the United States Department of Labor evidencing such participation by the contractor and any or all of its subcontractors. Applicable apprenticeship and training programs are those that have been approved and registered with the United States Department of Labor. The bidder shall list in the space below, the official name of the program sponsor holding the Certificate of Registration for all of the types of work or crafts in which the bidder is a participant and that will be performed with the bidder's forces. Types of work or craft work that will be subcontracted shall be included and listed as subcontract work. The list shall also indicate any type of work or craft job category that does not have an applicable apprenticeship or training program. **The bidder is responsible for making a complete report and shall make certain that each type of work or craft job category that will be utilized on the project as reported on the Construction Employee Workforce Projection (Form BC-1256) and returned with the bid is accounted for and listed.**

The requirements of this certification and disclosure are a material part of the contract, and the contractor shall require this certification provision to be included in all approved subcontracts. In order to fulfill this requirement, it shall not be necessary that an applicable program sponsor be currently taking or that it will take applications for apprenticeship, training or employment during the performance of the work of this contract.

L. Executive Order Number 1 (2007) Regarding Lobbying on Government Procurements

The bidder hereby warrants and certifies that they have complied and will comply with the requirements set forth in this Order. The requirements of this warrant and certification are a material part of the contract, and the contractor shall require this warrant and certification provision to be included in all approved subcontracts.

M. Disclosure of Business Operations in Iran

Public Act 95-0616 provides that each bid, offer, or proposal submitted for a State contract shall include a disclosure of whether or not the Company acting as the bidder, offeror, or proposing entity, or any of its corporate parents or subsidiaries, within the 24 months before submission of the bid, offer, or proposal had business operations that involved contracts with or provision of supplies or services to the Government of Iran, companies in which the Government of Iran has any direct or indirect equity share, consortiums or projects commissioned by the Government of Iran, or companies involved in consortiums or projects commissioned by the Government of Iran and either of the following conditions apply:

- (1) More than 10% of the Company's revenues produced in or assets located in Iran involve oil-related activities or mineral-extraction activities; less than 75% of the Company's revenues produced in or assets located in Iran involve contracts with or provision of oil-related or mineral-extraction products or services to the Government of Iran or a project or consortium created exclusively by that government; and the Company has failed to take substantial action.
- (2) The Company has, on or after August 5, 1996, made an investment of \$20 million or more, or any combination of investments of at least \$10 million each that in the aggregate equals or exceeds \$20 million in any 12-month period, which directly or significantly contributes to the enhancement of Iran's ability to develop petroleum resources of Iran.

The terms "Business operations", "Company", "Mineral-extraction activities", "Oil-related activities", "Petroleum resources", and "Substantial action" are all defined in the Act.

Failure to make the disclosure required by the Act shall cause the bid, offer or proposal to be considered not responsive. The disclosure will be considered when evaluating the bid, offer, or proposal or awarding the contract. The name of each Company disclosed as doing business or having done business in Iran will be provided to the State Comptroller.

Check the appropriate statement:

Company has no business operations in Iran to disclose.

Company has business operations in Iran as disclosed the attached document.

NOTICE

**PA 95-0635 SUBSTANCE ABUSE PREVENTION PROGRAM (SAPP)
Effective January 1, 2008**

This Public Act requires that all contractors and subcontractors have a SAPP, meeting certain requirements, in place before starting work.

The as read low bidder is required to submit a correctly completed SAPP Certification Form BC 261 within seven (7) working days after the Letting. The Department will not accept a SAPP that does not meet the seven day submittal requirement and the bid will be declared not responsive. In the event the bid is declared not responsive due to failure to comply the Department may elect to cause the forfeiture of the penal sum of the bidder's proposal guaranty, may deny authorization to bid the project if re-advertised for bids and may not allow the bidder to participate on subsequent Lettings.

Submittal and approval of the bidder's SAPP is a condition of award.

The SAPP is to be submitted to the Bureau of Design & Environment, Contracts Office, Room 326, 2300 South Dirksen Parkway, Springfield, IL 62764. Voice 217-782-7806. Fax 217-785-1141. It is the bidder's responsibility to obtain confirmation of delivery.

The requirements of this Public Act are a material part of the contract, and the contractor shall require this provision to be included in all approved subcontracts. The contractor shall submit the correctly completed SAPP Certification Form BC 261 for each subcontractor with the Request for Approval of Subcontractor Form BC 260A.

TO BE RETURNED WITH BID

IV. DISCLOSURES

A. The disclosures hereinafter made by the bidder are each a material representation of fact upon which reliance is placed should the Department enter into the contract with the bidder. The Department may terminate the contract if it is later determined that the bidder rendered a false or erroneous disclosure, and the surety providing the performance bond shall be responsible for completion of the contract.

B. Financial Interests and Conflicts of Interest

1. Section 50-35 of the Illinois Procurement Code provides that all bids of more than \$10,000 shall be accompanied by disclosure of the financial interests of the bidder. This disclosed information for the successful bidder, will be maintained as public information subject to release by request pursuant to the Freedom of Information Act.

The financial interests to be disclosed shall include ownership or distributive income share that is in excess of 5%, or an amount greater than 60% of the annual salary of the Governor, of the bidding entity or its parent entity, whichever is less, unless the contractor or bidder is a publicly traded entity subject to Federal 10K reporting, in which case it may submit its 10K disclosure in place of the prescribed disclosure. If a bidder is a privately held entity that is exempt from Federal 10K reporting, but has more than 400 shareholders, it may submit the information that Federal 10K companies are required to report, and list the names of any person or entity holding any ownership share that is in excess of 5%. The disclosure shall include the names, addresses, and dollar or proportionate share of ownership of each person making the disclosure, their instrument of ownership or beneficial relationship, and notice of any potential conflict of interest resulting from the current ownership or beneficial interest of each person making the disclosure having any of the relationships identified in Section 50-35 and on the disclosure form.

In addition, all disclosures shall indicate any other current or pending contracts, proposals, leases, or other ongoing procurement relationships the bidding entity has with any other unit of state government and shall clearly identify the unit and the contract, proposal, lease, or other relationship.

2. Disclosure Forms. Disclosure Form A is attached for use concerning the individuals meeting the above ownership or distributive share requirements. Subject individuals should be covered each by one form. In addition, a second form (Disclosure Form B) provides for the disclosure of current or pending procurement relationships with other (non-IDOT) state agencies. **The forms must be included with each bid or incorporated by reference.**

C. Disclosure Form Instructions

Form A: For bidders that have previously submitted the information requested in Form A

The Department has retained the Form A disclosures submitted by all bidders responding to these requirements for the April 24, 1998 or any subsequent letting conducted by the Department. The bidder has the option of submitting the information again or the bidder may check the following certification statement indicating that the information previously submitted by the bidder is, as of the date of submission, current and accurate. Before checking this certification, the bidder should carefully review its prior submissions to ensure the Certification is correct. If the Bidder checks the Certification, the Bidder should proceed to Form B instructions.

CERTIFICATION STATEMENT

I have determined that the Form A disclosure information previously submitted is current and accurate, and all forms are hereby incorporated by reference in this bid. Any necessary additional forms or amendments to previously submitted forms are attached to this bid.

(Bidding Company)



Signature of Authorized Representative

Date

Form A: For bidders who have NOT previously submitted the information requested in Form A

If the bidder is a publicly traded entity subject to Federal 10K reporting, the 10K Report may be submitted to meet the requirements of Form A. If a bidder is a privately held entity that is exempt from Federal 10K reporting, but has more than 400 shareholders, it may submit the information that Federal 10K companies are required to report, and list the names of any person or entity holding any ownership share that is in excess of 5%. If a bidder is not subject to Federal 10K reporting, the bidder must determine if any individuals are required by law to complete a financial disclosure form. To do this, the bidder should answer each of the following questions. A "YES" answer indicates Form A must be completed. If the answer to each of the following questions is "NO", then the NOT APPLICABLE STATEMENT on the second page of Form A must be signed and dated by a person that is authorized to execute contracts for the bidding company. Note: These questions are for assistance only and are not required to be completed.

1. Does anyone in your organization have a direct or beneficial ownership share of greater than 5% of the bidding entity or parent entity? YES ___ NO ___
 2. Does anyone in your organization have a direct or beneficial ownership share of less than 5%, but which has a value greater than \$102,600.00? YES ___ NO ___
 3. Does anyone in your organization receive more than \$102,600.00 of the bidding entity's or parent entity's distributive income? (Note: Distributive income is, for these purposes, any type of distribution of profits. An annual salary is not distributive income.) YES ___ NO ___
 4. Does anyone in your organization receive greater than 5% of the bidding entity's or parent entity's total distributive income, but which is less than \$102,600.00? YES ___ NO ___
- (Note: Only one set of forms needs to be completed per person per bid even if a specific individual would require a yes answer to more than one question.)

A "YES" answer to any of these questions requires the completion of Form A. The bidder must determine each individual in the bidding entity or the bidding entity's parent company that would cause the questions to be answered "Yes". Each form must be signed and dated by a person that is authorized to execute contracts for your organization. **Photocopied or stamped signatures are not acceptable.** The person signing can be, but does not have to be, the person for which the form is being completed. The bidder is responsible for the accuracy of any information provided.

If the answer to each of the above questions is "NO", then the NOT APPLICABLE STATEMENT on page 2 of Form A must be signed and dated by a person that is authorized to execute contracts for your company.

Form B: Identifying Other Contracts & Procurement Related Information Disclosure Form B must be completed for each bid submitted by the bidding entity. Note: *Checking the NOT APPLICABLE STATEMENT on Form A does not allow the bidder to ignore Form B. Form B must be completed, checked, and dated or the bidder may be considered nonresponsive and the bid will not be accepted.*

The Bidder shall identify, by checking Yes or No on Form B, whether it has any pending contracts (including leases), bids, proposals, or other ongoing procurement relationship with any other (non-IDOT) State of Illinois agency. If "No" is checked, the bidder only needs to complete the check box on the bottom of Form B. If "Yes" is checked, the bidder must do one of the following:

Option I: If the bidder did not submit an Affidavit of Availability to obtain authorization to bid, the bidder must list all non-IDOT State of Illinois agency pending contracts, leases, bids, proposals, and other ongoing procurement relationships. These items may be listed on Form B or on an attached sheet(s). Do not include IDOT contracts. Contracts with cities, counties, villages, etc. are not considered State of Illinois agency contracts and are not to be included. Contracts with other State of Illinois agencies such as the Department of Natural Resources or the Capital Development Board must be included. Bidders who submit Affidavits of Availability are suggested to use Option II.

Option II: If the bidder is required and has submitted an Affidavit of Availability in order to obtain authorization to bid, the bidder may write or type "See Affidavit of Availability" which indicates that the Affidavit of Availability is incorporated by reference and includes all non-IDOT State of Illinois agency pending contracts, leases, bids, proposals, and other ongoing procurement relationships. For any contracts that are not covered by the Affidavit of Availability, the bidder must identify them on Form B or on an attached sheet(s). These might be such things as leases.

D. Bidders Submitting More Than One Bid

Bidders submitting multiple bids may submit one set of forms consisting of all required Form A disclosures and one Form B for use with all bids. Please indicate in the space provided below the bid item that contains the original disclosure forms and the bid items which incorporate the forms by reference.

- The bid submitted for letting item _____ contains the Form A disclosures or Certification Statement and the Form B disclosures. The following letting items incorporate the said forms by reference:

**ILLINOIS DEPARTMENT
OF TRANSPORTATION**

**Form A
Financial Information &
Potential Conflicts of Interest
Disclosure**

Contractor Name		
Legal Address		
City, State, Zip		
Telephone Number	Email Address	Fax Number (if available)

Disclosure of the information contained in this Form is required by the Section 50-35 of the Illinois Procurement Code (30 ILCS 500). Vendors desiring to enter into a contract with the State of Illinois must disclose the financial information and potential conflict of interest information as specified in this Disclosure Form. This information shall become part of the publicly available contract file. This Form A must be completed for bids in excess of \$10,000, and for all open-ended contracts. **A publicly traded company may submit a 10K disclosure (or equivalent if applicable) in satisfaction of the requirements set forth in Form A. See Disclosure Form Instructions.**

DISCLOSURE OF FINANCIAL INFORMATION

1. Disclosure of Financial Information. The individual named below has an interest in the BIDDER (or its parent) in terms of ownership or distributive income share in excess of 5%, or an interest which has a value of more than \$102,600.00 (60% of the Governor's salary as of 7/1/07). **(Make copies of this form as necessary and attach a separate Disclosure Form A for each individual meeting these requirements)**

FOR INDIVIDUAL (type or print information)

NAME: _____

ADDRESS _____

Type of ownership/distributable income share:

stock _____ sole proprietorship _____ Partnership _____ other: (explain on separate sheet):
% or \$ value of ownership/distributable income share: _____

2. Disclosure of Potential Conflicts of Interest. Check "Yes" or "No" to indicate which, if any, of the following potential conflict of interest relationships apply. If the answer to any question is "Yes", please attach additional pages and describe.

(a) State employment, currently or in the previous 3 years, including contractual employment of services. Yes ___ No ___

If your answer is yes, please answer each of the following questions.

1. Are you currently an officer or employee of either the Capitol Development Board or the Illinois Toll Highway Authority? Yes ___ No ___
2. Are you currently appointed to or employed by any agency of the State of Illinois? If you are currently appointed to or employed by any agency of the State of Illinois, and your annual salary exceeds \$102,600.00, (60% of the Governor's salary as of 7/1/07) provide the name the State agency for which you are employed and your annual salary. _____

RETURN WITH BID/OFFER

- 3. If you are currently appointed to or employed by any agency of the State of Illinois, and your annual salary exceeds \$102,600.00, (60% of the Governor's salary as of 7/1/07) are you entitled to receive (i) more than 7 1/2% of the total distributable income of your firm, partnership, association or corporation, or (ii) an amount in excess of the salary of the Governor? Yes ___ No ___
- 4. If you are currently appointed to or employed by any agency of the State of Illinois, and your annual salary exceeds \$102,600.00, (60% of the Governor's salary as of 7/1/07) are you and your spouse or minor children entitled to receive (i) more than 15 % in the aggregate of the total distributable income of your firm, partnership, association or corporation, or (ii) an amount in excess of 2 times the salary of the Governor? Yes ___ No ___

(b) State employment of spouse, father, mother, son, or daughter, including contractual employment services in the previous 2 years.

Yes ___ No ___

If your answer is yes, please answer each of the following questions.

- 1. Is your spouse or any minor children currently an officer or employee of the Capitol Development Board or the Illinois Toll Highway Authority? Yes ___ No ___
- 2. Is your spouse or any minor children currently appointed to or employed by any agency of the State of Illinois? If your spouse or minor children is/are currently appointed to or employed by any agency of the State of Illinois, and his/her annual salary exceeds \$102,600.00, (60 % of the Governor's salary as of 7/1/07) provide the name of your spouse and/or minor children, the name of the State agency for which he/she is employed and his/her annual salary. _____

- 3. If your spouse or any minor children is/are currently appointed to or employed by any agency of the State of Illinois, and his/her annual salary exceeds \$102,600.00, (60% of the salary of the Governor as of 7/1/07) are you entitled to receive (i) more then 71/2% of the total distributable income of your firm, partnership, association or corporation, or (ii) an amount in excess of the salary of the Governor? Yes ___ No ___
- 4. If your spouse or any minor children are currently appointed to or employed by any agency of the State of Illinois, and his/her annual salary exceeds \$102,600.00, (60% of the Governor's salary as of 7/1/07) are you and your spouse or minor children entitled to receive (i) more than 15 % in the aggregate of the total distributable income of your firm, partnership, association or corporation, or (ii) an amount in excess of 2 times the salary of the Governor? Yes ___ No ___

(c) Elective status; the holding of elective office of the State of Illinois, the government of the United States, any unit of local government authorized by the Constitution of the State of Illinois or the statutes of the State of Illinois currently or in the previous 3 years.

Yes ___ No ___

(d) Relationship to anyone holding elective office currently or in the previous 2 years; spouse, father, mother, son, or daughter.

Yes ___ No ___

(e) Appointive office; the holding of any appointive government office of the State of Illinois, the United States of America, or any unit of local government authorized by the Constitution of the State of Illinois or the statutes of the State of Illinois, which office entitles the holder to compensation in excess of the expenses incurred in the discharge of that office currently or in the previous 3 years.

Yes ___ No ___

(f) Relationship to anyone holding appointive office currently or in the previous 2 years; spouse, father, mother, son, or daughter.

Yes ___ No ___

(g) Employment, currently or in the previous 3 years, as or by any registered lobbyist of the State government.

Yes ___ No ___

RETURN WITH BID/OFFER

(h) Relationship to anyone who is or was a registered lobbyist in the previous 2 years; spouse, father, mother, son, or daughter. Yes ___ No ___

(i) Compensated employment, currently or in the previous 3 years, by any registered election or reelection committee registered with the Secretary of State or any county clerk of the State of Illinois, or any political action committee registered with either the Secretary of State or the Federal Board of Elections. Yes ___ No ___

(j) Relationship to anyone; spouse, father, mother, son, or daughter; who was a compensated employee in the last 2 years by any registered election or re-election committee registered with the Secretary of State or any county clerk of the State of Illinois, or any political action committee registered with either the Secretary of State or the Federal Board of Elections. Yes ___ No ___

APPLICABLE STATEMENT

This Disclosure Form A is submitted on behalf of the INDIVIDUAL named on previous page.

Completed by: _____ Date _____
Signature of Individual or Authorized Representative

NOT APPLICABLE STATEMENT

I have determined that no individuals associated with this organization meet the criteria that would require the completion of this Form A.

This Disclosure Form A is submitted on behalf of the CONTRACTOR listed on the previous page.

_____ Date _____
Signature of Authorized Representative

RETURN WITH BID/OFFER

ILLINOIS DEPARTMENT
OF TRANSPORTATION

Form B
Other Contracts &
Procurement Related Information
Disclosure

Contractor Name		
Legal Address		
City, State, Zip		
Telephone Number	Email Address	Fax Number (if available)

Disclosure of the information contained in this Form is required by the Section 50-35 of the Illinois Procurement Act (30 ILCS 500). This information shall become part of the publicly available contract file. This Form B must be completed for bids in excess of \$10,000, and for all open-ended contracts.

DISCLOSURE OF OTHER CONTRACTS AND PROCUREMENT RELATED INFORMATION

1. Identifying Other Contracts & Procurement Related Information. The BIDDER shall identify whether it has any pending contracts (including leases), bids, proposals, or other ongoing procurement relationship with any other State of Illinois agency: Yes ___ No ___

If "No" is checked, the bidder only needs to complete the signature box on the bottom of this page.

2. If "Yes" is checked. Identify each such relationship by showing State of Illinois agency name and other descriptive information such as bid or project number (attach additional pages as necessary). SEE DISCLOSURE FORM INSTRUCTIONS:

THE FOLLOWING STATEMENT MUST BE CHECKED

<input type="checkbox"/>	_____	_____
	Signature of Authorized Representative	Date

RETURN WITH BID

SPECIAL NOTICE TO CONTRACTORS

The following requirements of the Illinois Department of Human Rights' Rules and Regulations are applicable to bidders on all construction contracts advertised by the Illinois Department of Transportation:

CONSTRUCTION EMPLOYEE UTILIZATION PROJECTION

- (a) All bidders on construction contracts shall complete and submit, along with and as part of their bids, a Bidder's Employee Utilization Form (Form BC-1256) setting forth a projection and breakdown of the total workforce intended to be hired and/or allocated to such contract work by the bidder including a projection of minority and female employee utilization in all job classifications on the contract project.
- (b) The Department of Transportation shall review the Employee Utilization Form, and workforce projections contained therein, of the contract awardee to determine if such projections reflect an underutilization of minority persons and/or women in any job classification in accordance with the Equal Employment Opportunity Clause and Section 7.2 of the Illinois Department of Human Rights' Rules and Regulations for Public Contracts adopted as amended on September 17, 1980. If it is determined that the contract awardee's projections reflect an underutilization of minority persons and/or women in any job classification, it shall be advised in writing of the manner in which it is underutilizing and such awardee shall be considered to be in breach of the contract unless, prior to commencement of work on the contract project, it submits revised satisfactory projections or an acceptable written affirmative action plan to correct such underutilization including a specific timetable geared to the completion stages of the contract.
- (c) The Department of Transportation shall provide to the Department of Human Rights a copy of the contract awardee's Employee Utilization Form, a copy of any required written affirmative action plan, and any written correspondence related thereto. The Department of Human Rights may review and revise any action taken by the Department of Transportation with respect to these requirements.

RETURN WITH BID



**Contract No. 76C12
 Various Counties
 Section D-8 ANNUAL PATCHING 2009-2
 Various Routes
 District 8 Construction Funds**

PART I. IDENTIFICATION

Dept. Human Rights # _____ Duration of Project: _____

Name of Bidder: _____

PART II. WORKFORCE PROJECTION

A. The undersigned bidder has analyzed minority group and female populations, unemployment rates and availability of workers for the location in which this contract work is to be performed, and for the locations from which the bidder recruits employees, and hereby submits the following workforce projection including a projection for minority and female employee utilization in all job categories in the workforce to be allocated to this contract:

TABLE A

TABLE B

TOTAL Workforce Projection for Contract												
JOB CATEGORIES	TOTAL EMPLOYEES		MINORITY EMPLOYEES						TRAINEES			
			BLACK		HISPANIC		*OTHER MINOR.		APPRENTICES		ON THE JOB TRAINEES	
	M	F	M	F	M	F	M	F	M	F	M	F
OFFICIALS (MANAGERS)												
SUPERVISORS												
FOREMEN												
CLERICAL												
EQUIPMENT OPERATORS												
MECHANICS												
TRUCK DRIVERS												
IRONWORKERS												
CARPENTERS												
CEMENT MASONS												
ELECTRICIANS												
PIPEFITTERS, PLUMBERS												
PAINTERS												
LABORERS, SEMI-SKILLED												
LABORERS, UNSKILLED												
TOTAL												

CURRENT EMPLOYEES TO BE ASSIGNED TO CONTRACT			
TOTAL EMPLOYEES		MINORITY EMPLOYEES	
M	F	M	F

TABLE C

TOTAL Training Projection for Contract								
EMPLOYEES IN TRAINING	TOTAL EMPLOYEES		BLACK		HISPANIC		*OTHER MINOR.	
	M	F	M	F	M	F	M	F
APPRENTICES								
ON THE JOB TRAINEES								

FOR DEPARTMENT USE ONLY

* Other minorities are defined as Asians (A) or Native Americans (N).
 Please specify race of each employee shown in Other Minorities column.

Note: See instructions on page 2

RETURN WITH BID

**Contract No. 76C12
Various Counties
Section D-8 ANNUAL PATCHING 2009-2
Various Routes
District 8 Construction Funds**

PART II. WORKFORCE PROJECTION - continued

- B. Included in "Total Employees" under Table A is the total number of **new hires** that would be employed in the event the undersigned bidder is awarded this contract.

The undersigned bidder projects that: (number) _____ new hires would be recruited from the area in which the contract project is located; and/or (number) _____ new hires would be recruited from the area in which the bidder's principal office or base of operation is located.

- C. Included in "Total Employees" under Table A is a projection of numbers of persons to be employed directly by the undersigned bidder as well as a projection of numbers of persons to be employed by subcontractors.

The undersigned bidder estimates that (number) _____ persons will be directly employed by the prime contractor and that (number) _____ persons will be employed by subcontractors.

PART III. AFFIRMATIVE ACTION PLAN

- A. The undersigned bidder understands and agrees that in the event the foregoing minority and female employee utilization projection included under **PART II** is determined to be an underutilization of minority persons or women in any job category, and in the event that the undersigned bidder is awarded this contract, he/she will, prior to commencement of work, develop and submit a written Affirmative Action Plan including a specific timetable (geared to the completion stages of the contract) whereby deficiencies in minority and/or female employee utilization are corrected. Such Affirmative Action Plan will be subject to approval by the contracting agency and the **Department of Human Rights**.
- B. The undersigned bidder understands and agrees that the minority and female employee utilization projection submitted herein, and the goals and timetable included under an Affirmative Action Plan if required, are deemed to be part of the contract specifications.

Company _____ Telephone Number _____

Address _____

NOTICE REGARDING SIGNATURE		
The Bidder's signature on the Proposal Signature Sheet will constitute the signing of this form. The following signature block needs to be completed if revisions are required.		
Signature: <input type="checkbox"/> _____	Title: _____	Date: _____

- Instructions: All tables must include subcontractor personnel in addition to prime contractor personnel.
- Table A - Include both the number of employees that would be hired to perform the contract work and the total number currently employed (Table B) that will be allocated to contract work, and include all apprentices and on-the-job trainees. The "Total Employees" column should include all employees including all minorities, apprentices and on-the-job trainees to be employed on the contract work.
 - Table B - Include all employees currently employed that will be allocated to the contract work including any apprentices and on-the-job trainees currently employed.
 - Table C - Indicate the racial breakdown of the total apprentices and on-the-job trainees shown in Table A.

RETURN WITH BID

**Contract No. 76C12
Various Counties
Section D-8 ANNUAL PATCHING 2009-2
Various Routes
District 8 Construction Funds**

PROPOSAL SIGNATURE SHEET

The undersigned bidder hereby makes and submits this bid on the subject Proposal, thereby assuring the Department that all requirements of the Invitation for Bids and rules of the Department have been met, that there is no misunderstanding of the requirements of paragraph 3 of this Proposal, and that the contract will be executed in accordance with the rules of the Department if an award is made on this bid.

Firm Name _____
(IF AN INDIVIDUAL) Signature of Owner _____
Business Address _____

Firm Name _____
By _____
(IF A CO-PARTNERSHIP) Business Address _____

Name and Address of All Members of the Firm:

Corporate Name _____
By _____
Signature of Authorized Representative

Typed or printed name and title of Authorized Representative
(IF A CORPORATION) Attest _____
Signature
(IF A JOINT VENTURE, USE THIS SECTION
FOR THE MANAGING PARTY AND THE
SECOND PARTY SHOULD SIGN BELOW) Business Address _____

Corporate Name _____
By _____
Signature of Authorized Representative

Typed or printed name and title of Authorized Representative
(IF A JOINT VENTURE) Attest _____
Signature
Business Address _____

If more than two parties are in the joint venture, please attach an additional signature sheet.



Return with Bid

Division of Highways
Proposal Bid Bond
(Effective November 1, 1992)

Item No. _____

Letting Date _____

KNOW ALL MEN BY THESE PRESENTS, That We _____

as PRINCIPAL, and _____

_____ as SURETY, are held jointly, severally and firmly bound unto the STATE OF ILLINOIS in the penal sum of 5 percent of the total bid price, or for the amount specified in Article 102.09 of the "Standard Specifications for Road and Bridge Construction" in effect on the date of invitation for bids, whichever is the lesser sum, well and truly to be paid unto said STATE OF ILLINOIS, for the payment of which we bind ourselves, our heirs, executors, administrators, successors and assigns.

THE CONDITION OF THE FOREGOING OBLIGATION IS SUCH, that whereas, the PRINCIPAL has submitted a bid proposal to the STATE OF ILLINOIS, acting through the Department of Transportation, for the improvement designated by the Transportation Bulletin Item Number and Letting Date indicated above.

NOW, THEREFORE, if the Department shall accept the bid proposal of the PRINCIPAL; and if the PRINCIPAL shall, within the time and as specified in the bidding and contract documents, submit a DBE Utilization Plan that is accepted and approved by the Department; and if, after award by the Department, the PRINCIPAL shall enter into a contract in accordance with the terms of the bidding and contract documents including evidence of the required insurance coverages and providing such bond as specified with good and sufficient surety for the faithful performance of such contract and for the prompt payment of labor and material furnished in the prosecution thereof; or if, in the event of the failure of the PRINCIPAL to make the required DBE submission or to enter into such contract and to give the specified bond, the PRINCIPAL pays to the Department the difference not to exceed the penalty hereof between the amount specified in the bid proposal and such larger amount for which the Department may contract with another party to perform the work covered by said bid proposal, then this obligation shall be null and void, otherwise, it shall remain in full force and effect.

IN THE EVENT the Department determines the PRINCIPAL has failed to comply with any requirement as set forth in the preceding paragraph, then Surety shall pay the penal sum to the Department within fifteen (15) days of written demand therefor. If Surety does not make full payment within such period of time, the Department may bring an action to collect the amount owed. Surety is liable to the Department for all its expenses, including attorney's fees, incurred in any litigation in which it prevails either in whole or in part.

In TESTIMONY WHEREOF, the said PRINCIPAL and the said SURETY have caused this instrument to be signed by their respective officers this _____ day of _____ A.D., _____.

PRINCIPAL

(Company Name)

(Company Name)

By: _____
(Signature & Title)

By: _____
(Signature of Attorney-in-Fact)

Notary Certification for Principal and Surety

STATE OF ILLINOIS,

County of _____

I, _____, a Notary Public in and for said County, do hereby certify that

_____ and _____
(Insert names of individuals signing on behalf of PRINCIPAL & SURETY)

who are each personally known to me to be the same persons whose names are subscribed to the foregoing instrument on behalf of PRINCIPAL and SURETY, appeared before me this day in person and acknowledged respectively, that they signed and delivered said instrument as their free and voluntary act for the uses and purposes therein set forth.

Given under my hand and notarial seal this _____ day of _____ A.D. _____

My commission expires _____

Notary Public

In lieu of completing the above section of the Proposal Bid Form, the Principal may file an Electronic Bid Bond. By signing the proposal and marking the check box next to the Signature and Title line below, the Principal is ensuring the identified electronic bid bond has been executed and the Principal and Surety are firmly bound unto the State of Illinois under the conditions of the bid bond as shown above.

Electronic Bid Bond ID# _____

Company / Bidder Name _____



Signature and Title _____

PROPOSAL ENVELOPE



PROPOSALS

for construction work advertised for bids by the
Illinois Department of Transportation

Item No.	Item No.	Item No.

Submitted By:

Name:
Address:
Phone No.

Bidders should use an IDOT proposal envelope or affix this form to the front of a 10" x 13" envelope for the submittal of bids. If proposals are mailed, they should be enclosed in a second or outer envelope addressed to:

Engineer of Design and Environment - Room 326
Illinois Department of Transportation
2300 South Dirksen Parkway
Springfield, Illinois 62764

NOTICE

Individual bids, including Bid Bond and/or supplemental information if required, should be securely stapled.

CONTRACTOR OFFICE COPY OF CONTRACT SPECIFICATIONS

NOTICE

None of the following material needs to be returned with the bid package unless the special provisions require documentation and/or other information to be submitted.

Contract No. 76C12
Various Counties
Section D-8 ANNUAL PATCHING 2009-2
Various Routes
District 8 Construction Funds



Illinois Department of Transportation



NOTICE TO BIDDERS

1. TIME AND PLACE OF OPENING BIDS. Sealed proposals for the improvement described herein will be received by the Department of Transportation at the Harry R. Hanley Building, 2300 South Dirksen Parkway, in Springfield, Illinois until 10:00 o'clock a.m., June 13, 2008. All bids will be gathered, sorted, publicly opened and read in the auditorium at the Department of Transportation's Harry R. Hanley Building shortly after the 10:00 a.m. cut off time.

2. DESCRIPTION OF WORK. The proposed improvement is identified and advertised for bids in the Invitation for Bids as:

**Contract No. 76C12
Various Counties
Section D-8 ANNUAL PATCHING 2009-2
Various Routes
District 8 Construction Funds**

Pavement patching at various locations in the district.

3. INSTRUCTIONS TO BIDDERS. (a) This Notice, the invitation for bids, proposal and letter of award shall, together with all other documents in accordance with Article 101.09 of the Standard Specifications for Road and Bridge Construction, become part of the contract. Bidders are cautioned to read and examine carefully all documents, to make all required inspections, and to inquire or seek explanation of the same prior to submission of a bid.

(b) State law, and, if the work is to be paid wholly or in part with Federal-aid funds, Federal law requires the bidder to make various certifications as a part of the proposal and contract. By execution and submission of the proposal, the bidder makes the certification contained therein. A false or fraudulent certification shall, in addition to all other remedies provided by law, be a breach of contract and may result in termination of the contract.

4. AWARD CRITERIA AND REJECTION OF BIDS. This contract will be awarded to the lowest responsive and responsible bidder considering conformity with the terms and conditions established by the Department in the rules, Invitation for Bids and contract documents. The issuance of plans and proposal forms for bidding based upon a prequalification rating shall not be the sole determinant of responsibility. The Department reserves the right to determine responsibility at the time of award, to reject any or all proposals, to readvertise the proposed improvement, and to waive technicalities.

By Order of the
Illinois Department of Transportation

Milton R. Sees, Secretary

BD 351 (Rev. 01/2003)

INDEX
FOR
SUPPLEMENTAL SPECIFICATIONS
AND RECURRING SPECIAL PROVISIONS

Adopted January 1, 2008

This index contains a listing of SUPPLEMENTAL SPECIFICATIONS and frequently used RECURRING SPECIAL PROVISIONS.

ERRATA Standard Specifications for Road and Bridge Construction (Adopted 1-1-07) (Revised 1-1-08)

SUPPLEMENTAL SPECIFICATIONS

<u>Std. Spec. Sec.</u>	<u>Page No.</u>
205 Embankment	1
251 Mulch	2
253 Planting Woody Plants	3
280 Temporary Erosion Control	5
443 Reflective Crack Control Treatment	6
502 Excavation for Structures	9
503 Concrete Structures	10
505 Steel Structures	11
540 Box Culverts	12
633 Removing and Reerecting Guardrail and Terminals	13
672 Sealing Abandoned Water Wells	14
701 Work Zone Traffic Control and Protection	15
838 Breakaway Devices	16
1004 Coarse Aggregates	17
1020 Portland Cement Concrete	18
1022 Concrete Curing Materials	20
1042 Precast Concrete Products	21
1062 Reflective Crack Control System	22
1069 Pole and Tower	24
1081 Materials for Planting	27
1083 Elastomeric Bearings	29
1102 Hot-Mix Asphalt Equipment	30

RECURRING SPECIAL PROVISIONS

The following RECURRING SPECIAL PROVISIONS indicated by an "X" are applicable to this contract and are included by reference:

<u>CHECK SHEET #</u>		<u>PAGE NO.</u>
1	Additional State Requirements For Federal-Aid Construction Contracts (Eff. 2-1-69) (Rev. 1-1-07)	31
2	Subletting of Contracts (Federal-Aid Contracts) (Eff. 1-1-88) (Rev. 5-1-93)	33
3	X EEO (Eff. 7-21-78) (Rev. 11-18-80)	34
4	X Specific Equal Employment Opportunity Responsibilities Non Federal-Aid Contracts (Eff. 3-20-69) (Rev. 1-1-94)	44
5	X Required Provisions - State Contracts (Eff. 4-1-65) (Rev. 1-1-07)	49
6	Reserved	54
7	Reserved	55
8	Haul Road Stream Crossings, Other Temporary Stream Crossings, and In-Stream Work Pads (Eff. 1-2-92) (Rev. 1-1-98)	56
9	Construction Layout Stakes Except for Bridges (Eff. 1-1-99) (Rev. 1-1-07)	57
10	Construction Layout Stakes (Eff. 5-1-93) (Rev. 1-1-07)	60
11	Use of Geotextile Fabric for Railroad Crossing (Eff. 1-1-95) (Rev. 1-1-07)	63
12	Subsealing of Concrete Pavements (Eff. 11-1-84) (Rev. 1-1-07)	65
13	Hot-Mix Asphalt Surface Removal (Cold Milling) (Eff. 11-1-87) (Rev. 1-1-07)	69
14	Pavement and Shoulder Resurfacing (Eff. 2-1-00) (Rev. 1-1-07)	71
15	PCC Partial Depth Hot-Mix Asphalt Patching (Eff. 1-1-98) (Rev. 1-1-07)	72
16	Patching with Hot-Mix Asphalt Overlay Removal (Eff. 10-1-95) (Rev. 1-1-07)	74
17	Polymer Concrete (Eff. 8-1-95) (Rev. 1-1-08)	75
18	PVC Pipeliner (Eff. 4-1-04) (Rev. 1-1-07)	77
19	Pipe Underdrains (Eff. 9-9-87) (Rev. 1-1-07)	78
20	Guardrail and Barrier Wall Delineation (Eff. 12-15-93) (Rev. 1-1-97)	79
21	Bicycle Racks (Eff. 4-1-94) (Rev. 1-1-07)	83
22	Temporary Modular Glare Screen System (Eff. 1-1-00) (Rev. 1-1-07)	85
23	Temporary Portable Bridge Traffic Signals (Eff. 8-1-03) (Rev. 1-1-07)	87
24	X Work Zone Public Information Signs (Eff. 9-1-02) (Rev. 1-1-07)	89
25	Night Time Inspection of Roadway Lighting (Eff. 5-1-96)	90
26	English Substitution of Metric Bolts (Eff. 7-1-96)	91
27	English Substitution of Metric Reinforcement Bars (Eff. 4-1-96) (Rev. 1-1-03)	92
28	X Calcium Chloride Accelerator for Portland Cement Concrete (Eff. 1-1-01)	93
29	Quality Control of Concrete Mixtures at the Plant-Single A (Eff. 8-1-00) (Rev. 1-1-04)	94
30	Quality Control of Concrete Mixtures at the Plant-Double A (Eff. 8-1-00) (Rev. 1-1-04)	100
31	Quality Control/Quality Assurance of Concrete Mixtures (Eff. 4-1-92) (Rev. 1-1-07)	108

TABLE OF CONTENTS

.LOCATION OF PROJECT 1

DESCRIPTION OF PROJECT..... 1

MONTHLY LABOR SUMMARY AND ACTIVITY REPORTING SYSTEM 1

COMPLETION DATE..... 4

TRAFFIC CONTROL AND PROTECTION STANDARD 701501 4

TRAFFIC CONTROL PLAN..... 4

CONSTRUCTION AND MAINTENANCE SIGN SUPPORTS 7

STATUS OF UTILITIES TO BE ADJUSTED 7

PAVEMENT FABRIC 7

SAWCUTS 8

REINFORCEMENT BARS..... 8

PAVEMENT REMOVAL FOR PATCHING 8

PAVEMENT REPLACEMENT, CONCRETE 9

PAVEMENT REPLACEMENT, BITUMINOUS..... 9

PAVEMENT REPLACEMENT CONCRETE (SPECIAL) 9

CALL-OUT W/WORK ORDER SHEET 10

DOWEL BAR ASSEMBLY 12

DRILL AND GROUT DOWEL BARS 12

EXPANSION JOINT (SPECIAL)..... 12

TIE BARS, ¾"..... 12

CONTRACT GUARANTY 13

PROGRESS SCHEDULE AND PROSECUTION OF WORK..... 13

WORK RESTRICTIONS 13

FAILURE TO OPEN LANES..... 13

PATCHING GUIDELINES W/TABLE FOR METHOD OF PATCHING..... 14

SALVAGING EXISTING TIE BARS 20

CEMENT (BDE) 20

DOWEL BARS (BDE) 22

EQUIPMENT RENTAL RATES (BDE)..... 23

MULTILANE PAVEMENT PATCHING (BDE)..... 24

PAYMENTS TO SUBCONTRACTORS (BDE) 24

PORTLAND CEMENT CONCRETE PLANTS (BDE) 25

PUBLIC CONVENIENCE AND SAFETY (BDE) 26

REFLECTIVE SHEETING ON CHANNELIZING DEVICES (BDE) 26

REINFORCEMENT BARS (BDE) 27

SUBCONTRACTOR MOBILIZATION PAYMENTS (BDE) 28

STEEL COST ADJUSTMENT (BDE) (RETURN FORM WITH BID) 29

STATE OF ILLINOIS

SPECIAL PROVISIONS

The following Special Provisions supplement the "Standard Specifications for Road and Bridge Construction," adopted January 1, 2007, the latest edition of the "Manual on Uniform Traffic Control Devices for Streets and Highways," and the "Manual of Test Procedures for Materials" in effect on the date of invitation for bids, and the Supplemental Specifications and Recurring Special Provisions indicated on the Check Sheet included herein which apply to and govern the construction of Various Routes; Section D-8 Annual Patching 2009-2; Various Counties; Contract No. 76C12 and in case of conflict with any part or parts of said Specifications, the said Special Provisions shall take precedence and shall govern.

LOCATION OF PROJECT

This project is located in various locations in St. Clair, Clinton, Monroe, Marion, Randolph and Washington Counties.

DESCRIPTION OF PROJECT

The work in this contract includes various types of patching on State maintained roads within the various counties shown.

The quantities included in the contract are estimated quantities only and the final quantities for the different types of patching may vary.

MONTHLY LABOR SUMMARY AND ACTIVITY REPORTING SYSTEM

Effective: 1-1-1995

Revised June 2001

I. Monthly Labor Summary Report, Form SBE 148

The prime contractor and each first and second tier sub-contractor, (hereinafter referred to as "subcontractor") shall submit a certified Monthly Labor Summary Report directly to the District Engineer.

This report is in lieu of submittal of the Monthly Workforce Analysis Report, Form SBE 956.

This report must be received in District Eight no later than the tenth day of the next month.

This Report shall be submitted by the prime contractor and each subcontractor, for each consecutive month, from the start, to the completion of their work on the contract.

The data source for this Report will be a summation of all personnel and hours worked on each subject contract for the month based on weekly payrolls for that month.

The Monthly Labor Summary Report is required to be submitted in one of the following formats:

- a.) For contractors having IDOT contracts valued in the aggregate at \$250,000 or less, the report may be typed or clearly handwritten using Form SBE 148 for submittal to the District Engineer for District Eight.
- b.) For contractors having IDOT contracts valued in the aggregate at more than \$250,000, the report must be submitted in a specific "Fixed Length Comma Delimited ASCII Text File Format". The subject file format is detailed on the next page. Submittal of this file may be by 3.5 inch disk, modem, or by e-mail.

II. Monthly Contract Activity Report, Form SBE 248

The prime contractor and each subcontractor shall submit a monthly report directly to the District Engineer reflecting their contract activity on all Illinois Department of Transportation contracts they have in force in District Eight.

This report shall be submitted for each consecutive month, from the start, to the completion of all contracts in District Eight.

The report must be received in the District Office no later than the tenth day of the next month.

Monthly Labor Summary and Activity Reporting System Codes and Formats

Indicated below for your reference are the Employee Codes and File Formats required for this system.

I.) Monthly Labor Summary Report, Form SBE 148

The following employee codes are to be used to identify each individual on the Summary Report:

1. **Gender:** M - Male F - Female
2. **Ethnic Group:** 1 - White 2 - Black 3 - Hispanic
4 - American Indian/Alaskan Native 5 - Asian/Pacific Islander
3. **Work Classification:** OF - Official SU - Supervisor FO - Foremen
CL - Clerical CA - Carpenter EO - Operator ME - Mechanic
TD - Truck Driver IW - Ironworker PA - Painter OT - Other
EL - Electrician PP - Pipefitter TE - Technical LA - Laborer
CM - Cement Mason
4. **Employee Status:** O - Owner Operator J - Journeyman
C - Company A - Apprentice T - Trainee

Specific “Fixed Length Comma Delimited ASCII File Format”

Order	Field Name	Type	Size
1	Contractor Number	A	4
2	Contractor Reference Number	A	6
3	Contract Number	A	5
4	Period (07/28/2000)	D	10
5	SSN (111-11-1111)	A	11
6	Name	A	40
7	Gender	A	1
8	Ethnic Group	A	1
9	Work Classification	A	1
10	Employee Status	A	1
11	Total Hours (000060.00)	N	10

File Name Conventions: (Contractor Number + Report Month/Year).Txt
i.e. 20001298.Txt

II.) Monthly Contract Activity Report, Form SBE 248

The following activity codes are to be used to identify the contractor’s contract status each month on the Monthly Activity Report, Form SBE 248:

- A. Contract Status: 1 - Not Started 2 - Active 3 - No Work
4 - Suspended 5 - Complete

Failure to comply with this special provision may result in the withholding of payments to the contractor, and/or cancellation, termination, or suspension of the contract in whole or part.

Compliance with this Special Provision shall be considered incidental to the cost of the contract and no additional compensation will be allowed for any costs incurred.

All prime and subcontractors having contracts in the aggregate exceeding \$250,000 must provide a “Fixed Length Comma Delimited ASCII File” for approval prior to the start of construction.

This Special Provision must be included in each subcontract agreement.

The Department of Transportation is requesting disclosure of information necessary to accomplish the statutory purpose as outlined under 23CFR part 230 and 41CFR part 60.4 and the Illinois Human Rights Act. Disclosure of this information is REQUIRED. Failure to comply with this special provision may result in the withholding of payments to the contractor, and/or cancellation, termination, or suspension of the contract in whole or part.

Compliance with this Special Provision shall be considered incidental to the cost of the contract and no additional compensation will be allowed for any costs incurred.

This Special Provision must be included in each subcontract agreement.

COMPLETION DATE

The contract is to run from the date of execution of the contract through June 30, 2009. All work on this contract shall be completed by June 30, 2009.

TRAFFIC CONTROL AND PROTECTION STANDARD 701501

Effective: October 1, 1984

Revised: November 1, 2006

This work shall conform to the applicable portions of Section 700 of the Standard Specifications, the details as shown on the plans, and as specified herein.

Traffic control and protection during patching operations will be in accordance with TRAFFIC CONTROL AND PROTECTION STANDARD 701501 except when the distance between successive patches is less than 700 ft (210 m), the entire operation may be considered as one work area for signing purposes; and, when the distance between successive patches exceeds 700 ft (210 m), additional warning signs and taper shall be placed as shown on the plans.

This work shall be measured according to Article 701.19(c) of the Standard Specifications.

This work will be paid for according to Article 701.20(b) at the contract lump sum price for TRAFFIC CONTROL AND PROTECTION STANDARD 701501.

TRAFFIC CONTROL PLAN

Effective: July 12, 1993

Revised: May 12, 1997

Traffic control shall be in accordance with the applicable sections of the "Standard Specifications for Road and Bridge Construction", the applicable guidelines contained in the "National Manual on Uniform Traffic Control Devices for Streets and Highways", Illinois Supplement to the National Manual of Uniform Traffic Control Devices, these Special Provisions, and any special details and Highway Standards contained herein and in the plans.

Special attention is called to Articles 107.09 and 107.14 of the "Standard Specifications for Road and Bridge Construction and the following Highway Standards relating to traffic control:

701201	701400	701401	701411	701422	701446
	701501	701601	701606	701901	

In addition, the following Special Provision(s) will also govern traffic control for this project:

- Construction and Maintenance Sign Supports
- Failure to Open Lanes
- Public Convenience and Safety
- Traffic Control and Protection Standard 701501
- Work Zone Restrictions
- Reflective Sheeting on Channelizing Devices

Details: Traffic Control and Protection (Special).

Traffic: It is the intention of the Department that all roads be kept open to traffic at all times during the construction of this section. One-lane, two-way traffic will be permitted in the immediate work areas during construction on two-lane pavements and one-lane one-way traffic on divided highways. At all other times, all traffic lanes shall be kept open throughout the project.

At any particular location on a four lane divided highway when the driving lane is closed to traffic, the Contractor shall keep all equipment, materials and vehicles out of the median and off the right of way beyond the median unless the passing lane is closed to traffic in the opposite direction. When the passing lane is closed to traffic, the Contractor shall keep all equipment, materials and vehicles off the right of way beyond the adjacent driving lane that is open to traffic and off the right of way beyond the centerline in the median unless the passing lane in the opposite direction is also closed to traffic.

No overnight closures will be permitted on 2-lane, 2-way traffic roadways.

Infrequently, IDOT personnel working on this project may do layout or inspection outside the limits of traffic control and protection provided during the various Contractor's operations.

In order to provide adequate traffic control and protection during layout and inspection, the Contractor shall furnish signs, barricades, flagmen and other necessary traffic control items as directed by the Engineer. This work will be paid for in accordance with Article 109.04.

Traffic Control for work areas on two-lane rural highways shall be provided in accordance with Standard 701201.

Traffic Control for work areas on Interstate highways shall be provided in accordance with Standard 701400 and Standard 701401.

Traffic Control for work areas that extend through an interchange ramp shall be provided in accordance with Standard 701411.

Traffic Control for work areas on rural multilane non-Interstate highways shall be provided in accordance with Standard 701422.

Traffic Control for work areas on two-lane, two-way undivided urban highways where the posted speed limit is 40 mph or less shall be in accordance with Standard 701501.

Traffic Control for work areas on multilane undivided urban highways with two-way traffic or on multilane divided urban highways with two-way traffic and a mountable median where the posted speed limit is 40 mph or less shall be provided in accordance with Standard 701606. Two arrowboards will be required for Standard 701606.

Traffic Control for work areas on multilane highways with two-way traffic and a non-traversable median or on multilane highways with one-way traffic where the posted speed limit is 40 mph or less shall be provided in accordance with Standard 701601. One arrowboard will be required for Standard 701601.

Traffic Control for work areas on interchange ramps shall be provided in accordance with the "Traffic Control and Protection (Special)".

Traffic Control for two-lane closures on multilane highways shall be provided in accordance with Standard 701400 and Standard 701446 included in the plans.

The Contractor may be required to provide signing in addition to that required by the Traffic Control Standards and Section 701 of the Standard Specifications. When additional signs are required as determined by the Engineer, they will be paid for at the contract unit price bid each for TEMPORARY SIGNING which price shall include furnishing, erecting, maintaining and removing said signs.

Flaggers shall be provided with and positioned as shown on the applicable traffic control standards and the "Special Design for Ramps". Flaggers shall also be positioned in accordance with Article 701.04(c) and will be considered incidental to the Traffic Control Standard specified. When additional flaggers are required by the Engineer, that are above and beyond the Article noted above, flaggers will be paid for at the contract unit price per hour for FLAGGER.

The method of measurement for Traffic Control and Protection shall be in accordance with the applicable portions of Article 701.07 of the Standard Specifications and as follows:

Traffic Control and Protection required under Standards 701201, 701401, 701411, 701422, 701501, 701601, and 701606 will be paid for on an each basis.

Standard 701201 will be paid for each set up for work areas not exceeding 1,000 feet in each lane of traffic. Standard 701401 will be paid for each set up for work areas not exceeding 2,000 feet. The additional barricades/barrels required for work area lengths exceeding 1,000 feet for Standard 701201 and exceeding 2,000 feet for Standard 701401 will be paid for separately at the contract unit price bid EACH for BARRICADES.

If the Standard 701401 work areas are less than 1 mile apart, the lane in which the work areas are located shall remain closed to traffic throughout the work areas.

Standard 701501, Standard 701601 and Standard 701606 will be paid for each set up when the work areas are more than 250 feet apart.

Traffic Control and Protection (Special) will be paid for each set up on an interchange ramp work area. Full width pavement on the ramps shall be open to traffic before night fall. Any damage to the existing shoulders adjacent to the ramp pavement resulting from traffic being directed onto the shoulder around a work area shall be repaired as directed by the Engineer and paid for in accordance with Article 109.04 of the Standard Specifications.

Traffic Control and Protection 701446 will be paid for each set up requiring a two-lane closure on a multilane highway.

The Basis of Payment for Traffic Control and Protection shall be in accordance with the applicable portions of Article 701.08 of the Standard Specifications and as follows:

This work will be paid for at the contract unit price each for TRAFFIC CONTROL AND PROTECTION STANDARD 701201, TRAFFIC CONTROL AND PROTECTION STANDARD 701401, TRAFFIC CONTROL AND PROTECTION STANDARD 701411, TRAFFIC CONTROL AND PROTECTION STANDARD 701422, TRAFFIC CONTROL AND PROTECTION

STANDARD 701501, TRAFFIC CONTROL AND PROTECTION STANDARD 701601, TRAFFIC CONTROL AND PROTECTION STANDARD 701606, TRAFFIC CONTROL AND PROTECTION (SPECIAL) and TRAFFIC CONTROL AND PROTECTION 701446 at locations specified.

Any inconveniences or delays caused by the Contractor in complying with these Special Provisions relating to Traffic Control will be considered as included in the contract unit prices for the various Traffic Control and Protection items and no additional compensation will be allowed.

CONSTRUCTION AND MAINTENANCE SIGN SUPPORTS

Effective: April 21, 1981

Revised: November 1, 2006

This work shall be done according to Section 1106 of the Standard Specifications and Highway Standard 702001 except as herein modified.

All construction signs mounted on permanent support for use in temporary traffic control having an area of 10 square feet (1 square meter) or more shall be mounted on two 4 in x 4 in (100 mm x 100 mm) or two 4 in x 6 in (100 mm x 150 mm) wood posts.

Type A metal post (two for each sign) conforming to Article 1006.29 of the Standard Specifications may be used in lieu of wood posts. Type A metal posts used for these signs may be unfinished.

This work shall not be paid for separately; but shall be considered included in the cost of the traffic control items in this contract.

STATUS OF UTILITIES TO BE ADJUSTED

NO UTILITIES TO BE ADJUSTED

The above represents the best information of the Department and is only included for the convenience of the bidder. The applicable provisions of Sections 102, 103, and Articles 105.07 and 107.20 of the Standard Specifications for Road and Bridge Construction shall apply.

If any utility adjustment or removal has not been completed when required by the Contractor's operation, the Contractor should notify the Engineer in writing. A request for an extension of time will be considered to the extent the Contractor's operations were affected.

PAVEMENT FABRIC

This work shall consist of furnishing and installing pavement fabric meeting the requirements of Article 1006.10 of the Standard Specifications in dowelled patches that are 12 feet or greater in length.

This work will be paid for at the contract unit price per square yard for PAVEMENT FABRIC, which price will be payment in full for furnishing and installing the fabric in place.

SAWCUTS

This work shall consist of providing saw cuts as described in Section 442 of the Standard Specification and the appropriate Highway Standard, except that saw cuts will be mandatory for all patches regardless of the Class and per the Special Provision PAVEMENT REMOVAL FOR PATCHING.

This work will be measured in feet for the length of the required saw cut.

This work will be paid for at the contract unit price per lineal foot for SAWCUTS, measured as specified herein.

REINFORCEMENT BARS

This work shall consist of furnishing and installing reinforcement bars in accordance with Article 442.06 of the Standard Specifications where continuously reinforced patches are required on Interstate highways. 5/8" diameter bars of the required length will be used. The bar spacing is approximately 6 ½ inches. The exact spacing will have to be determined during patching operations.

This work will be paid for at the contract unit price per pound for REINFORCEMENT BARS, which price will be payment in full for furnishing and installing the bars in place.

PAVEMENT REMOVAL FOR PATCHING

This work shall consist of the removal of various types of pavement for patching as follows:

Case C: The hot-mix asphalt and undowelled concrete patches (including CRC Pavement), saw cut or score and remove in accordance with Article 442.05(c) of the Standard Specifications and as directed by the Engineer. The saw cut on previously resurfaced CRC Pavement shall extend through existing reinforcement.

Case B: For doweled concrete patches, saw cut and remove in accordance with Article 442.05(b) of the Standard Specifications and as directed by the Engineer.

Case A: For continuously reinforced concrete pavement patches, saw cut and remove in accordance with Article 442.05(a) of the Standard Specifications and as directed by the Engineer. The depth of the saw cut in CRC Pavement with Drainage Mat Underdrains will be determined by the Engineer in an attempt to prevent damage to the underdrains.

This work will be measured in cubic yards by measuring from the top of pavement to the sub-base for depth (in yards) multiply by the square yards removed.

If additional sub-base or subgrade material is removed due to negligence on the part of the Contractor its removal and replacement will not be measured for payment. Where unsuitable material is encountered in the subgrade and its removal and replacement is required by the Engineer, the additional quantity for removal and replacement will be measured for payment.

This work will be paid for at the contract unit price per cubic yard for PAVEMENT REMOVAL FOR PATCHING (CASE C), PAVEMENT REMOVAL FOR PATCHING (CASE B), and PAVEMENT REMOVAL FOR PATCHING (CASE A), measured as specified herein. Replacement will be paid for separately. All mandatory saw cuts for removal operations will be paid for separately.

PAVEMENT REPLACEMENT, CONCRETE

This work shall consist of pavement patch replacement with P.C. Concrete material in accordance with Section 442 of the Standard Specifications.

This work will be measured in cubic yards by measuring from the top of pavement to the sub-base for depth (in yards) multiplied by the square yards of surface area.

This work will be paid for at the contract unit price per cubic yards for PAVEMENT REPLACEMENT, CONCRETE, which price shall be payment in full for furnishing and placing the P.C. Concrete material, sealing and/or sawing of the joints as specified, and restoring of any disturbed stabilized shoulder areas. Reinforcement and dowel bars along with tie bars and expansion and anchor ties will be paid for separately.

PAVEMENT REPLACEMENT, BITUMINOUS

This work shall consist of pavement patch replacement with bituminous material in accordance with Section 442 of the Standard Specifications except that the bituminous concrete mixture shall conform to the requirements of Section 406 of the Standard Specifications. The Engineer shall contact the District Bureau of Materials for the type of Class 1 bituminous mixture required.

Bituminous patch replacement will be used only between April 15 and December 1 at locations allowed in the Special Provision for "Patching Guideline". Between December 1 and April 15, only P.C. Concrete material will be allowed unless otherwise approved by the Engineer.

This work will be measured in cubic yards by measuring from the top of pavement to the sub-base for depth (in yards) multiplied by the square yard of the surface area.

This work will be paid for at the contract unit price per cubic yards for PAVEMENT REPLACEMENT, BITUMINOUS, which price shall be payment in full for furnishing and placing the bituminous material.

PAVEMENT REPLACEMENT CONCRETE (SPECIAL)

This work shall consist of pavement patch replacement with P.C. Concrete material in accordance with Section 442 of the Standard Specifications and the detail shown in the plans.

This work will be measured in cubic yards by measuring from the top of pavement to the sub-base for depth (in yards) multiplied by the square yards of surface area.

This work will be paid for at the contract unit price per cubic yards for PAVEMENT REPLACEMENT CONCRETE, (SPECIAL), which price shall be payment in full for furnishing and placing the P.C. Concrete material, sealing of the joints as specified, completing work as indicated on detail shown in the plans, and restoring of any disturbed stabilized shoulder areas. Reinforcement and dowel bars along with tie bars and expansion and anchor ties will be paid for separately.

CALL-OUT W/WORK ORDER SHEET

This work shall consist of all preparations and operations necessary for the movement of personnel, equipment, supplies and incidentals for each call-out to various sites as designated by the Engineer with the issuance of a WORK ORDER SHEET.

Individual work order sheets may consist of numerous sites located within St. Clair, Monroe, Randolph, Clinton, and Washington Counties.

This work will be paid for at the contract unit price each for CALL-OUT as described above, regardless of the number of job sites listed on the individual WORK ORDER SHEET and no additional compensation will be allowed.

WORK ORDER SHEET

WORK ORDER NUMBER: _____

To: _____
(Contractor's Name)

DATE & TIME NOTIFICATION:
(When called or presented, whichever is first)

FROM: _____
(Dist. Maintenance Area)
Engineer or his/her
Authorized Representative)

DATE: _____

TIME: _____

PLEASE PROCEED TO PATCH ON:

ROUTE: FROM: TO: COUNTY:

Estimated Number of Patches: _____

Estimated Cu. Yd. Of Removal of Case: _____ = _____

Estimated Cu. Yd. Of Replacement of: _____ = _____

Estimated Ft. of Saw Cuts: _____

SPECIAL NOTES:

Use Traffic Control Protection: _____

Dowell Bars Required:	YES	or	NO
Pavement Fabric:	YES	or	NO
Reinforcement Bars:	YES	or	NO

TRAFFIC CONTROL IN ADDITION TO STANDARD 702001:

701401, 701501, 701606, 701601, 701411, 701201, 701400, 701422, 701446

Traffic Control and Protection (Special) Ramps _____

Engineer

OFFICE INFORMATION:

Work completed on: _____ at _____
(Date) (Time)

Engineer

DOWEL BAR ASSEMBLY

This work shall consist of furnishing and placing a dowel bar assembly as shown on Standard 420001 at locations designated by the Engineer. The dowel bar assembly shall be a minimum of 12 feet long.

This work will be paid for at the contract unit price each for DOWEL BAR ASSEMBLY, which price will be payment in full for all labor and materials to furnish and install the dowel bar assembly complete.

DRILL AND GROUT DOWEL BARS

This work shall consist of furnishing and installing dowels in accordance with Article 442.06 of the Standard Specifications where dowelled patches are required on highways with jointed pavements.

This work will be paid for at the contract unit price each for DRILL AND GROUT DOWEL BARS, which will be payment in full for furnishing and installing each dowel in place.

EXPANSION JOINT (SPECIAL)

This work consist of furnishing all labor, equipment and materials required to install a 3 inch expansion joint near the center of a Class A pavement patch at location(s) shown on the plans or as directed by the Engineer.

Materials of the expansion joint shall conform to Article 1051.08 or 1051.09, Article 1106.11 and Article 1050.02.

Work shall be according to Section 442, Article 420.10 (c), Standard 420001 and plan details.

The expansion joint shall be measured for payment in place in feet. The pavement removal and replacement shall be measured for payment in place in square yards as specified elsewhere without reduction for EXPANSION JOINT (SPECIAL).

The expansion joint will be paid for at the contract unit price bid per foot for EXPANSION JOINT (SPECIAL).

TIE BARS, ¾"

When patching two adjacent lanes and when the patches are 20 feet or longer, ¾ inch (#6) tie bars shall be included at 2' centers under Patching Codes B, C, B (Special) and C (Special) and as directed by the Engineer.

This work will be paid for at the contract unit price per each for TIE BARS ¾', which price shall include all labor, equipment, and materials required to complete drilling and installation and no additional compensation will be allowed.

CONTRACT GUARANTY

The Contractor will be guaranteed work for a minimum of 70 percent of the awarded cost of the contract.

PROGRESS SCHEDULE AND PROSECUTION OF WORK

Article 108.02 and the 10 calendar days allowed in Article 108.03 of the Standard Specifications for beginning the work is hereby waived. Instead, the Contractor will be on a 5 working day response time from the time of notification by the Maintenance Area Field Engineer, or his representative, that the patching is required at a specific location, provided weather conditions permit the work to be performed at that time. If weather conditions do not permit work at that time work shall be performed as soon as conditions permit. Once the work has been started, work will be continuous until completed. The Contractor is not expected to work on weekends or legal holidays.

A written work order will be provided to the Contractor. This will serve either as notification or to confirm a verbal notification and will be provided as soon after verbal notification as practical.

WORK RESTRICTIONS

In St. Clair County, the Contractor shall adhere to the following work restrictions on I-64, I-55/70 (and where these three highways are joined for just a short stretch I-55/70/64).

1. No lane restrictions will be allowed between the hours of 6:00 A. M. to 9:00 A. M. in the westbound direction.
2. No lane restrictions will be allowed between the hours of 3:00 P. M. to 6:00 P. M. in the eastbound direction.

For 3 lane pavement on I-255 two (2) lanes of traffic shall remain open during peak hours. Peak hours are defined as 6:00 a.m. to 9:00 a.m. in both directions as well as from 3:00 p.m. to 6:00 p.m. in both directions.

Adhering to these restrictions will not be paid for separately, but will be considered incidental to the contract.

FAILURE TO OPEN LANES

If the Contractor fails to have all lanes of traffic open along I-64 and I-55/70 and two (2) lanes on I-255 during the lane restrictions period for east or westbound traffic or for northbound and southbound traffic or conducts operations that will impede the flow of traffic during peak hours, the Contractor shall be liable to the Department in the amount of \$1000 for each 15 minute period and any fraction thereof during peak hours, not as a penalty but as liquidated and ascertained damages.

PATCHING GUIDELINES W/TABLE FOR METHOD OF PATCHING

Following are the guidelines to be used for different types of pavement to be patched under this contract unless otherwise directed by the Engineer.

All Type A, B, and Type C (Concrete) Patches shall be edged the entire perimeter of the patch with an edging tool having a 1/4 inch radius.

NON-INTERSTATE HIGHWAYS

1. Non-Jointed Pavement - Previously Resurfaced or Not Previously Resurfaced:
 - a) The minimum patch length shall be 4 feet.
 - b) The minimum distance between undowelled patches shall be 15 feet.
 - c) A full depth undowelled patch in accordance with Section 442 of the Standard Specifications shall be used with the replacement material at the option of the Contractor unless valid reasons exist for the Engineer to specify one type of material.
 - d) PATCHING CODE: C, C (Special) or D.
2. Jointed Pavement - Pavement Not Previously Resurfaced:
 - a) The minimum patch length shall be 6 feet and full lane width.
 - b) A full depth dowelled patch in accordance with Section 442 of the Standard Specifications shall be used providing the Engineer determines that the existing adjacent pavement is sound enough to dowel the patch in. Should the Engineer determine that the existing adjacent pavement is not sufficiently sound enough to dowel the patch in or if the existing surrounding pavement has been successfully patched with undowelled patches previously, the Engineer may determine that undowelled patches will be used.
 - c) The minimum distance between undowelled patches shall be 15 feet, and the minimum distance between doweled patches shall be 20 feet.
 - d) The Engineer shall specify the replacement material for undowelled patches.
 - e) PATCHING CODE: B, C, or D.

3. Jointed Pavement - Pavement Previously Resurfaced:
- a) The minimum patch length shall be 6 feet and full lane width. A full depth undowelled patch in accordance with Section 442 of the Standard Specifications shall be used. However, should the Engineer determine that the existing adjacent pavement is sufficiently sound enough to dowel the patch in or if the existing surrounding pavement has been successfully patched with doweled patches previously, the Engineer may determine that doweled patches will be used.
 - b) The minimum distance between undowelled patches shall be 15 feet, and the minimum distance between doweled patches shall be 20 feet.
 - c) The Engineer will specify the replacement material for undowelled patches.
 - d) PATCHING CODE: B (Special), C (Special) or D.

INTERSTATE HIGHWAYS

1. Jointed Pavement - Pavement Not Previously Resurfaced:
- a) The minimum patch length shall be 6 feet and full lane width.
 - b) A full depth doweled patch in accordance with Section 442 of the Standard Specifications shall be used providing the Engineer determines that the existing adjacent pavement is sound enough to dowel the patch in. Should the engineer determine that the existing adjacent pavement is not sufficiently sound enough to dowel the patch in or if the existing surrounding pavement has been successfully patched with undowelled patches previously, the Engineer may determine that undowelled patches will be used.
 - c) The minimum distance between undowelled patches shall be 15 feet, and the minimum distance between dowelled patches shall be 20 feet.
 - d) The Engineer shall specify the replacement material for undowelled patches.
 - e) PATCHING CODE: B, C, or D.

2. Jointed Pavement - Pavement Previously Resurfaced:
 - a) The minimum patch length shall be 6 feet and full lane width. A full depth undowelled patch in accordance with Section 442 of the Standard Specifications shall be used. However, should the Engineer determine that the existing adjacent pavement is sufficiently sound enough to dowel the patch in or if the existing surrounding pavement has been successfully patched with doweled patches previously, the Engineer may determine that doweled patches will be used.
 - b) The minimum distance between undowelled patches shall be 15 feet, and the minimum distance between doweled patches shall be 20 feet.
 - c) The Engineer will specify the replacement material for undowelled patches.
 - d) PATCHING CODE: B (Special), C (Special) or D.
3. Continuously Reinforced Concrete Pavement - Pavement Not Previously Resurfaced:
 - a) The minimum patch length shall be 4 1/2 feet and half lane width. Half lane width shall not be used unless one edge of the patch is an outside pavement edge.
 - b) A full depth continuous reinforced concrete patch in accordance with Section 442 of the Standard Specifications shall be used.
 - c) PATCHING CODE: A
4. Continuous Reinforced Concrete Pavement - Pavement Previously Resurfaced:
 - a) The minimum patch length shall be 4 1/2 feet and full lane width.
 - b) If the continuous integrity of the existing pavement has been retained, a full depth continuous reinforced concrete patch in accordance with Section 442 of the Standard Specifications shall be used.
 - c) If structural deterioration of the surrounding pavement has taken place to the extent that the continuous integrity of the pavement cannot be retained, or if the continuous

integrity of the surrounding pavement has been previously cut free, a full depth undowelled patch in accordance with Section 442 of the Standard Specifications shall be placed.

- d) The minimum distance between undowelled patches shall be 15 feet.
- e) The Engineer will specify the replacement material for undowelled patches.
- f) PATCHING CODE: A (Special), C (Special) or D.

PATCHING REQUIREMENTS

1. Continuous Reinforced Concrete Patches:

- a) The desirable minimum distance between the partial-depth saw cut and the nearest tight transverse crack in the pavement to remain is 18 inches. However, in areas of close crack spacing where the pavement otherwise appears to be sound, this dimension may be reduced to 6 inches. A tight crack should have no surface spalling and no faulting. The alignment of the partial and full-depth saw cuts may be skewed slightly if necessary to maintain this dimension.
- b) When patching two adjacent lanes in one operation, the longitudinal joint shall be a sawed, longitudinal joint as detailed on Standard 420001; however, tie bars shall only be included for patches 20 feet or longer.

2. Dowelled Patches:

- a) When patching two adjacent lanes in one operation, the longitudinal joint shall be a sawed longitudinal joint as detailed on Standard 420001; however, tie bars shall be included for patches 20 feet or longer.
- b) Patches 40 feet or longer shall have sawed contraction joints, in accordance with Standard 420001, at 40 feet maximum intervals and be in prolongation with joints or cracks in the adjacent lane whenever possible.
- c) Centerline joints, transverse joints and saw-cut extension into stabilized shoulders shall be sealed in accordance with Article 442.06(j) of the Standard Specifications.
- d) For patches on 11 feet wide lanes, the 18 inch dimension from the centerline to the dowel bars shown on Standard 442101 shall be reduced to 12 inches.

3. Undowelled Concrete Patches:
 - a) Longitudinal joints shall be as detailed on Standard 420001 except that the tie bars are not required for patches less than 20 feet in length. Existing tie bars shall be either cut or removed. Marginal bars shall be cut.
 - b) When patching two adjacent lanes in one operation, tie bars shall be included in the sawed longitudinal joint for patches 20 feet or longer.
 - c) Centerline joints, transverse joints, and saw-cut extensions into stabilized shoulders shall be sealed in accordance with Article 442.06(j) of the Standard Specifications.
4. Bituminous Patches: Existing tie bars shall be either cut or removed. Marginal bars shall be cut.
5. General Requirements:
 - a) The Contractor shall have the option of sealing joints on doweled or undowelled patches with hot poured joint sealer or with a 1¼ inches wide. Preformed Elastomeric Joint Seal placed in accordance with Article 420.14(b) of the Standard Specifications and as shown on Standard 420001, except for patches on ramps or pavements that are superelevated more than 3 percent where the hot poured joint sealer may not be used.
 - b) Saw cut extension into pavement that is to remain in place will not be permitted.
 - c) After the forms are removed from the patch but prior to opening the patch to traffic, the disturbed stabilized shoulder area shall be restored to the existing line and grade with material designated by the Engineer.
 - d) The final finish of the patch at the transverse edges shall conform to any existing longitudinal surface variations.

Patching Material:

The Maintenance Area Field Engineer will determine the PATCHING CODE (A, B, C, D, A(Special) B(Special) or C(Special) for each patch and include this information in the written work order. It will not be possible for the Field Engineer to determine the PATCHING CODE for Continuous Reinforced Concrete Pavement that has been previously resurfaced until the existing pavement has been removed. Also, the Field Engineer may not be able to determine the PATCHING CODE on Jointed Pavement until the existing pavement has been removed.

TABLE FOR METHOD OF PATCHING

PATCHING CODE	TYPE OF PATCHING	CONSTRUCTION SPECS.	PAYMENT FOR REMOVAL	PAYMENT FOR REPLACEMENT
TYPE A	CRC CONCRETE	Section 442	CASE A	Pavement Replacement Concrete
TYPE B	DOWELLED CONCRETE	Section 442	CASE B	Pavement Replacement Concrete
TYPE C	UNDOWELLED CONCRETE	Section 442	CASE C	Pavement Replacement Concrete
TYPE D	BITUMINOUS	Section 442	CASE C	Pavement Replacement Bituminous
TYPE A (Special)	CRC Concrete Previously Resurfaced	Section 442 and Special Provisions	CASE A	Pavement Replacement Concrete (Special)
TYPE B (Special)	Doweled Concrete Previously Resurfaced	Section 442 and Special Provisions	CASE B	Pavement Replacement Concrete (Special)
TYPE C (Special)	Undowelled Concrete	Section 442 and Special Provisions	Case C	Pavement Replacement Concrete (Special)

SALVAGING EXISTING TIE BARS

The existing tie bars between the existing pavement and existing medians, gutters and/or combination curb and gutters that are found suitable for reuse shall be cleaned, straightened and incorporated into the new construction. Any existing tie bars that are found unsuitable to be incorporated into the proposed construction due to excessive rusting or distress shall be removed flush with the face of the existing concrete and disposed of outside the limits of the right-of-way in accordance with Article 202.03 of the Standard Specifications.

This work will not be paid for separately but shall be considered included in the various removal pay items and no additional compensation will be allowed.

CEMENT (BDE)

Effective: January 1, 2007

Revised: November 1, 2007

Revise Section 1001 of the Standard Specifications to read:

“SECTION 1001. CEMENT

1001.01 Cement Types. Cement shall be according to the following.

- (a) Portland Cement. Acceptance of portland cement shall be according to the current Bureau of Materials and Physical Research’s Policy Memorandum, “Portland or Blended Cement Acceptance Procedure for Qualified and Non-Qualified Plants”.

Portland cement shall be according to ASTM C 150, and shall meet the standard physical and chemical requirements. Type I or Type II may be used for cast-in-place, precast, and precast prestressed concrete. Type III may be used according to Article 1020.04, or when approved by the Engineer. All other cements referenced in ASTM C 150 may be used when approved by the Engineer.

The total of all organic processing additions shall be a maximum of 1.0 percent by weight (mass) of the cement and the total of all inorganic processing additions shall be a maximum of 4.0 percent by weight (mass) of the cement. Organic processing additions shall be limited to grinding aids that improve the flowability of cement, reduce pack set, and improve grinding efficiency. Inorganic processing additions shall be limited to granulated blast-furnace slag according to the chemical requirements of AASHTO M 302 and Class C fly ash according to the chemical requirements of AASHTO M 295.

- (b) Portland-Pozzolan Cement. Acceptance of portland-pozzolan cement shall be according to the current Bureau of Materials and Physical Research’s Policy Memorandum, “Portland or Blended Cement Acceptance Procedure for Qualified and Non-Qualified Plants”.

Portland-pozzolan cement shall be according to ASTM C 595 and shall meet the standard physical and chemical requirements. Type IP or I(PM) may be used for cast-in-place, precast, and precast prestressed concrete, except when Class PP concrete is

used. The pozzolan constituent for Type IP shall be a maximum of 21 percent of the weight (mass) of the portland-pozzolan cement. All other cements referenced in ASTM C 595 may be used when approved by the Engineer.

For cast-in-place construction, portland-pozzolan cements shall not be used in concrete mixtures when the air temperature is below 40 °F (4 °C) without permission of the Engineer. If permission is given, the mix design strength requirement may require the Contractor to increase the cement or eliminate the cement factor reduction for a water-reducing or high range water-reducing admixture which is permitted according to Article 1020.05(b).

The total of all organic processing additions shall be a maximum of 1.0 percent by weight (mass) of the cement. Organic processing additions shall be limited to grinding aids as defined in (a) above. Inorganic processing additions shall not be used.

- (c) Portland Blast-Furnace Slag Cement. Acceptance of portland blast-furnace slag cement shall be according to the current Bureau of Materials and Physical Research's Policy Memorandum, "Portland or Blended Cement Acceptance Procedure for Qualified and Non-Qualified Plants".

Portland blast-furnace slag cement shall be according to ASTM C 595 and shall meet the standard physical and chemical requirements. Type I(SM) slag-modified portland cement may be used for cast-in-place, precast, and precast prestressed concrete, except when Class PP concrete is used. All other cements referenced in ASTM C 595 may be used when approved by the Engineer.

For cast-in-place construction, portland blast-furnace slag cements shall not be used in concrete mixtures when the air temperature is below 40 °F (4 °C) without permission of the Engineer. If permission is given, the mix design strength requirement may require the Contractor to increase the cement or eliminate the cement factor reduction for a water-reducing or high range water-reducing admixture which is permitted according to Article 1020.05(b).

The total of all organic processing additions shall be a maximum of 1.0 percent by weight (mass) of the cement. Organic processing additions shall be limited to grinding aids as defined in (a) above. Inorganic processing additions shall not be used.

- (d) Rapid Hardening Cement. Rapid hardening cement shall be used according to Article 1020.04 or when approved by the Engineer. The cement shall be on the Department's current "Approved List of Packaged, Dry, Rapid Hardening Cementitious Materials for Concrete Repairs", and shall be according to the following.

- (1) The cement shall have a maximum final set of 25 minutes, according to Illinois Modified ASTM C 191.
- (2) The cement shall have a minimum compressive strength of 2000 psi (13,800 kPa) at 3.0 hours, and 4000 psi (27,600 kPa) at 24.0 hours, according to Illinois Modified ASTM C 109.

- (3) The cement shall have a maximum drying shrinkage of 0.050 percent at seven days, according to Illinois Modified ASTM C 596.
 - (4) The cement shall have a maximum expansion of 0.020 percent at 14 days, according to Illinois Modified ASTM C 1038.
 - (5) The cement shall have a minimum 80 percent relative dynamic modulus of elasticity; and shall not have a weight (mass) gain in excess of 0.15 percent or a weight (mass) loss in excess of 1.0 percent, after 100 cycles, according to Illinois Modified AASHTO T 161, Procedure B. At 100 cycles, the specimens are measured and weighed at 73 °F (23 °C).
- (e) Calcium Aluminate Cement. Calcium aluminate cement shall be used when specified by the Engineer. The cement shall meet the standard physical requirements for Type I cement according to ASTM C 150, except the time of setting shall not apply. The chemical requirements shall be determined according to ASTM C 114 and shall be as follows: minimum 38 percent aluminum oxide (Al_2O_3), maximum 42 percent calcium oxide (CaO), maximum 1 percent magnesium oxide (MgO), maximum 0.4 percent sulfur trioxide (SO_3), maximum 1 percent loss on ignition, and maximum 3.5 percent insoluble residue.

1001.02 Uniformity of Color. Cement contained in single loads or in shipments of several loads to the same project shall not have visible differences in color.

1001.03 Mixing Brands and Types. Different brands or different types of cement from the same manufacturing plant, or the same brand or type from different plants shall not be mixed or used alternately in the same item of construction unless approved by the Engineer.

1001.04 Storage. Cement shall be stored and protected against damage, such as dampness which may cause partial set or hardened lumps. Different brands or different types of cement from the same manufacturing plant, or the same brand or type from different plants shall be kept separate.”

DOWEL BARS (BDE)

Effective: April 1, 2007

Revised: January 1, 2008

Revise the fifth and sixth sentences of Article 1006.11(b) of the Standard Specifications to read:

“The bars shall be epoxy coated according to AASHTO M 284, except the thickness of the epoxy shall be 7 to 12 mils (0.18 to 0.30 mm) and patching of the ends will not be required. The epoxy coating applicator shall be certified according to the current Bureau of Materials and Physical Research Policy Memorandum, “Epoxy Coating Plant Certification Procedure”. The Department will maintain an approved list.”

EQUIPMENT RENTAL RATES (BDE)

Effective: August 2, 2007

Revised: January 2, 2008

Replace the second and third paragraphs of Article 105.07(b)(4)a. of the Standard Specifications with the following:

“Equipment idled which cannot be used on other work, and which is authorized to standby on the project site by the Engineer, will be paid for according to Article 109.04(b)(4).”

Replace Article 109.04(b)(4) of the Standard Specifications with the following:

“(4) Equipment. Equipment used for extra work shall be authorized by the Engineer. The equipment shall be specifically described, be of suitable size and capacity for the work to be performed, and be in good operating condition. For such equipment, the Contractor will be paid as follows.

- a. Contractor Owned Equipment. Contractor owned equipment will be paid for by the hour using the applicable FHWA hourly rate from the “Equipment Watch Rental Rate Blue Book” (Blue Book) in effect when the force account work begins. The FHWA hourly rate is calculated as follows.

$$\text{FHWA hourly rate} = (\text{monthly rate}/176) \times (\text{model year adj.}) \times (\text{Illinois adj.}) + \text{EOC}$$

Where: EOC = Estimated Operating Costs per hour (from the Blue Book)

The time allowed will be the actual time the equipment is operating on the extra work. For the time required to move the equipment to and from the site of the extra work and any authorized idle (standby) time, payment will be made at the following hourly rate: $0.5 \times (\text{FHWA hourly rate} - \text{EOC})$.

All time allowed shall fall within the working hours authorized for the extra work.

The rates above include the cost of fuel, oil, lubrication, supplies, small tools, necessary attachments, repairs, overhaul and maintenance of any kind, depreciation, storage, overhead, profits, insurance, and all incidentals. The rates do not include labor.

The Contractor shall submit to the Engineer sufficient information for each piece of equipment and its attachments to enable the Engineer to determine the proper equipment category. If a rate is not established in the Blue Book for a particular piece of equipment, the Engineer will establish a rate for that piece of equipment that is consistent with its cost and use in the industry.

- b. Rented Equipment. Whenever it is necessary for the Contractor to rent equipment to perform extra work, the rental and transportation costs of the equipment plus five percent for overhead will be paid. In no case shall the rental rates exceed those of established distributors or equipment rental agencies.

All prices shall be agreed to in writing before the equipment is used.”

MULTILANE PAVEMENT PATCHING (BDE)

Effective: November 1, 2002

Pavement broken and holes opened for patching shall be completed prior to weekend or holiday periods. Should delays of any type or for any reason prevent the completion of the work, temporary patches shall be constructed. Material able to support the average daily traffic and meeting the approval of the Engineer shall be used for the temporary patches. The cost of furnishing, placing, maintaining, removing and disposing of the temporary work, including traffic control, shall be the responsibility of the Contractor.

PAYMENTS TO SUBCONTRACTORS (BDE)

Effective: June 1, 2000

Revised: January 1, 2006

Federal regulations found at 49 CFR §26.29 mandate the Department to establish a contract clause to require Contractors to pay subcontractors for satisfactory performance of their subcontracts and to set the time for such payments.

State law also addresses the timing of payments to be made to subcontractors and material suppliers. Section 7 of the Prompt Payment Act, 30 ILCS 540/7, requires that when a Contractor receives any payment from the Department, the Contractor shall make corresponding, proportional payments to each subcontractor and material supplier performing work or supplying material within 15 calendar days after receipt of the Department payment. Section 7 of the Act further provides that interest in the amount of two percent per month, in addition to the payment due, shall be paid to any subcontractor or material supplier by the Contractor if the payment required by the Act is withheld or delayed without reasonable cause. The Act also provides that the time for payment required and the calculation of any interest due applies to transactions between subcontractors and lower-tier subcontractors and material suppliers throughout the contracting chain.

This Special Provision establishes the required federal contract clause, and adopts the 15 calendar day requirement of the State Prompt Payment Act for purposes of compliance with the federal regulation regarding payments to subcontractors. This contract is subject to the following payment obligations.

When progress payments are made to the Contractor according to Article 109.07 of the Standard Specifications, the Contractor shall make a corresponding payment to each subcontractor and material supplier in proportion to the work satisfactorily completed by each subcontractor and for the material supplied to perform any work of the contract. The proportionate amount of partial payment due to each subcontractor and material supplier throughout the contracting chain shall be determined by the quantities measured or otherwise determined as eligible for payment by the Department and included in the progress payment to the Contractor. Subcontractors and material suppliers shall be paid by the Contractor within 15 calendar days after the receipt of payment from the Department. The Contractor shall not hold retainage from the subcontractors. These obligations shall also apply to any payments made by

subcontractors and material suppliers to their subcontractors and material suppliers; and to all payments made to lower tier subcontractors and material suppliers throughout the contracting chain. Any payment or portion of a payment subject to this provision may only be withheld from the subcontractor or material supplier to whom it is due for reasonable cause.

This Special Provision does not create any rights in favor of any subcontractor or material supplier against the State or authorize any cause of action against the State on account of any payment, nonpayment, delayed payment, or interest claimed by application of the State Prompt Payment Act. The Department will not approve any delay or postponement of the 15 day requirement except for reasonable cause shown after notice and hearing pursuant to Section 7(b) of the State Prompt Payment Act. State law creates other and additional remedies available to any subcontractor or material supplier, regardless of tier, who has not been paid for work properly performed or material furnished. These remedies are a lien against public funds set forth in Section 23(c) of the Mechanics Lien Act, 770 ILCS 60/23(c), and a recovery on the Contractor's payment bond according to the Public Construction Bond Act, 30 ILCS 550.

PORTLAND CEMENT CONCRETE PLANTS (BDE)

Effective: January 1, 2007

Add the following to Article 1020.11(a) of the Standard Specifications.

- “(9) Use of Multiple Plants in the Same Construction Item. The Contractor may simultaneously use central-mixed, truck-mixed, and shrink-mixed concrete from more than one plant, for the same construction item, on the same day, and in the same pour. However, the following criteria shall be met.
- a. Each plant shall use the same cement, finely divided minerals, aggregates, admixtures, and fibers.
 - b. Each plant shall use the same mix design. However, material proportions may be altered slightly in the field to meet slump and air content criteria. Field water adjustments shall not result in a difference that exceeds 0.02 between plants for water/cement ratio. The required cement factor for central-mixed concrete shall be increased to match truck-mixed or shrink-mixed concrete, if the latter two types of mixed concrete are used in the same pour.
 - c. The maximum slump difference between deliveries of concrete shall be 3/4 in. (19 mm) when tested at the jobsite. If the difference is exceeded, but test results are within specification limits, the concrete may be used. The Contractor shall take immediate corrective action and shall test subsequent deliveries of concrete until the slump difference is corrected. For each day, the first three truck loads of delivered concrete from each plant shall be tested for slump by the Contractor. Thereafter, when a specified test frequency for slump is to be performed, it shall be conducted for each plant at the same time.
 - d. The maximum air content difference between deliveries of concrete shall be 1.5 percent when tested at the jobsite. If the difference is exceeded, but test results are within specification limits, the concrete may be used. The Contractor

shall take immediate corrective action and shall test subsequent deliveries of concrete until the air content difference is corrected. For each day, the first three truck loads of delivered concrete from each plant shall be tested for air content by the Contractor. Thereafter, when a specified test frequency for air content is to be performed, it shall be conducted for each plant at the same time.

- e. Strength tests shall be performed and taken at the jobsite for each plant. When a specified strength test is to be performed, it shall be conducted for each plant at the same time. The difference between plants for their mean strength shall not exceed 450 psi (3100 kPa) compressive and 80 psi (550 kPa) flexural. The strength standard deviation for each plant shall not exceed 650 psi (4480 kPa) compressive and 110 psi (760 kPa) flexural. The mean and standard deviation requirements shall apply to the test of record. If the strength difference requirements are exceeded, the Contractor shall take corrective action.
- f. The maximum haul time difference between deliveries of concrete shall be 15 minutes. If the difference is exceeded, but haul time is within specification limits, the concrete may be used. The Contractor shall take immediate corrective action and check subsequent deliveries of concrete until the haul time difference is corrected.”

PUBLIC CONVENIENCE AND SAFETY (BDE)

Effective: January 1, 2000

Add the following paragraph after the fourth paragraph of Article 107.09 of the Standard Specifications.

“On weekends, excluding holidays, roadways with Average Daily Traffic of 25,000 or greater, all lanes shall be open to traffic from 3:00 P.M. Friday to midnight Sunday except where structure construction or major rehabilitation makes it impractical.”

REFLECTIVE SHEETING ON CHANNELIZING DEVICES (BDE)

Effective: April 1, 2007

Revise the seventh paragraph of Article 1106.02 of the Standard Specifications to read:

“At the time of manufacturing, the retroreflective prismatic sheeting used on channelizing devices shall meet or exceed the initial minimum coefficient of retroreflection as specified in the following table. Measurements shall be conducted according to ASTM E 810, without averaging. Sheeting used on cones, drums and flexible delineators shall be reboundable as tested according to ASTM D 4956. Prestriped sheeting for rigid substrates on barricades shall be white and orange.

Initial Minimum Coefficient of Retroreflection candelas/foot candle/sq ft (candelas/lux/sq m) of material				
Observation Angle (deg.)	Entrance Angle (deg.)	White	Orange	Fluorescent Orange
0.2	-4	365	160	150
0.2	+30	175	80	70
0.5	-4	245	100	95
0.5	+30	100	50	40"

Revise the first sentence of the first paragraph of Article 1106.02(c) of the Standard Specifications to read:

“Barricades and vertical panels shall have alternating white and orange stripes sloping downward at 45 degrees toward the side on which traffic will pass.”

Revise the third sentence of the first paragraph of Article 1106.02(d) of the Standard Specifications to read:

“The bottom panels shall be 8 x 24 in. (200 x 600 mm) with alternating white and orange stripes sloping downward at 45 degrees toward the side on which traffic will pass.”

REINFORCEMENT BARS (BDE)

Effective: November 1, 2005

Revised: January 2, 2008

Revise Article 1006.10(a) of the Standard Specifications to read:

“ (a) Reinforcement Bars. Reinforcement bars will be accepted according to the current Bureau of Materials and Physical Research Policy Memorandum, “Reinforcement Bar and/or Dowel Bar Plant Certification Procedure”. The Department will maintain an approved list of producers.

(1) Reinforcement Bars (Non-Coated). Reinforcement bars shall be according to ASTM A 706 (A 706M), Grade 60 (420) for deformed bars and the following.

- a. For straight bars furnished in cut lengths and with a well-defined yield point, the yield point shall be determined as the elastic peak load, identified by a halt or arrest of the load indicator before plastic flow is sustained by the bar and dividing it by the nominal cross-sectional area of the bar.
- b. For bars without a well-defined yield point, including bars straightened from coils, the yield strength shall be determined by taking the corresponding load at 0.005 strain as measured by an extensometer (0.5% elongation under load) and dividing it by the nominal cross-sectional area of the bar.
- c. For bars straightened from coils or bars bent from fabrication, there shall be no upper limit on yield strength; and for bar designation Nos. 3 - 6 (10 - 19), the elongation after rupture shall be at least 9%.

- d. Heat Numbers. Bundles or bars at the construction site shall be marked or tagged with heat identification numbers of the bar producer.
 - e. Guided Bend Test. Bars may be subject to a guided bend test across two pins which are free to rotate, where the bending force shall be centrally applied with a fixed or rotating pin of a certain diameter as specified in Table 3 of ASTM A 706 (A 706M). The dimensions and clearances of this guided bend test shall be according to ASTM E 190.
 - f. Spiral Reinforcement. Spiral reinforcement shall be deformed or plain bars conforming to the above requirements or cold-drawn steel wire conforming to AASHTO M 32.
- (2) Epoxy Coated Reinforcement Bars. Epoxy coated reinforcement bars shall be according to Article 1006.10(a)(1) and shall be epoxy coated according to AASHTO M 284 (M 284M) and the following.
- a. Certification. The epoxy coating applicator shall be certified according to the current Bureau of Materials and Physical Research Policy Memorandum, "Epoxy Coating Plant Certification Procedure". The Department will maintain an approved list.
 - b. Coating Thickness. The thickness of the epoxy coating shall be 7 to 12 mils (0.18 to 0.30 mm). When spiral reinforcement is coated after fabrication, the thickness of the epoxy coating shall be 7 to 20 mils (0.18 to 0.50 mm).
 - c. Cutting Reinforcement. Reinforcement bars may be sheared or sawn to length after coating, providing the end damage to the coating does not extend more than 0.5 in. (13 mm) back and the cut is patched before any visible rusting appears. Flame cutting will not be permitted."

SUBCONTRACTOR MOBILIZATION PAYMENTS (BDE)

Effective: April 2, 2005

To account for the preparatory work and operations necessary for the movement of subcontractor personnel, equipment, supplies, and incidentals to the project site and for all other work or operations that must be performed or costs incurred when beginning work approved for subcontracting in accordance with Article 108.01 of the Standard Specifications, the Contractor shall make a mobilization payment to each subcontractor.

This mobilization payment shall be made at least 14 days prior to the subcontractor starting work. The amount paid shall be equal to 3 percent of the amount of the subcontract reported on form BC 260A submitted for the approval of the subcontractor's work.

This provision shall be incorporated directly or by reference into each subcontract approved by the Department.

STEEL COST ADJUSTMENT (BDE) (RETURN FORM WITH BID)

Effective: April 2, 2004

Revised: April 1, 2007

Description. Steel cost adjustments will be made to provide additional compensation to the Contractor, or a credit to the Department, for fluctuations in steel prices when optioned by the Contractor. The bidder shall indicate on the attached form whether or not this special provision will be part of the contract and submit the completed form with his/her bid. Failure to submit the form, or failure to fill out the form completely, shall make this contract exempt of steel cost adjustments.

Types of Steel Products. An adjustment will be made for fluctuations in the cost of steel used in the manufacture of the following items:

- Metal Piling (excluding temporary sheet piling)
- Structural Steel
- Reinforcing Steel

Other steel materials such as dowel bars, tie bars, mesh reinforcement, guardrail, steel traffic signal and light poles, towers and mast arms, metal railings (excluding wire fence), frames and grates, and other miscellaneous items will be subject to a steel cost adjustment when the pay item they are used in has a contract value of \$10,000 or greater.

Documentation. Sufficient documentation shall be furnished to the Engineer to verify the following:

- (a) Evidence that increased or decreased steel costs have been passed on to the Contractor.
- (b) The dates and quantity of steel, in lb (kg), shipped from the mill to the fabricator.
- (c) The quantity of steel, in lb (kg), incorporated into the various items of work covered by this special provision. The Department reserves the right to verify submitted quantities.

Method of Adjustment. Steel cost adjustments will be computed as follows:

$$SCA = Q \times D$$

Where: SCA = steel cost adjustment, in dollars
Q = quantity of steel incorporated into the work, in lb (kg)
D = price factor, in dollars per lb (kg)

$$D = CBP_M - CBP_L$$

Where: CBP_M = The average of the Consumer Buying Price indices for Shredded Auto Scrap (Chicago) and No. 1 Heavy Melt (Chicago) as published by the American Metal Market (AMM) for the day the steel is shipped from the mill. The indices will be converted from dollars per ton to dollars per lb (kg).

$CBP_L =$ The average of the Consumer Buying Price indices for Shredded Auto Scrap (Chicago) and No. 1 Heavy Melt (Chicago) as published by the AMM for the day the contract is let. The indices will be converted from dollars per ton to dollars per lb (kg).

The unit weights (masses) of steel that will be used to calculate the steel cost adjustment for the various items are shown in the attached table.

No steel cost adjustment will be made for any products manufactured from steel having a mill shipping date prior to the letting date.

If the Contractor fails to provide the required documentation, the method of adjustment will be calculated as described above; however, the CBP_M will be based on the date the steel arrives at the job site. In this case, an adjustment will only be made when there is a decrease in steel costs.

Basis of Payment. Steel cost adjustments may be positive or negative but will only be made when there is a difference between the CBP_L and CBP_M in excess of five percent, as calculated by:

$$\text{Percent Difference} = \{(CBP_L - CBP_M) \div CBP_L\} \times 100$$

Steel cost adjustments will be calculated by the Engineer and will be paid or deducted when all other contract requirements for the items of work are satisfied. Adjustments will only be made for fluctuations in the cost of the steel as described herein. No adjustment will be made for changes in the cost of manufacturing, fabrication, shipping, storage, etc.

The adjustments shall not apply during contract time subject to liquidated damages for completion of the entire contract.

Attachment

Item	Unit Mass (Weight)
Metal Piling (excluding temporary sheet piling) Furnishing Metal Pile Shells 12 in. (305 mm), 0.179 in. (3.80 mm) wall thickness) Furnishing Metal Pile Shells 12 in. (305 mm), 0.250 in. (6.35 mm) wall thickness) Furnishing Metal Pile Shells 14 in. (356 mm), 0.250 in. (6.35 mm) wall thickness) Other piling	23 lb/ft (34 kg/m) 32 lb/ft (48 kg/m) 37 lb/ft (55 kg/m) See plans
Structural Steel	See plans for weights (masses)
Reinforcing Steel	See plans for weights (masses)
Dowel Bars and Tie Bars	6 lb (3 kg) each
Mesh Reinforcement	63 lb/100 sq ft (310 kg/sq m)
Guardrail Steel Plate Beam Guardrail, Type A w/steel posts Steel Plate Beam Guardrail, Type B w/steel posts Steel Plate Beam Guardrail, Types A and B w/wood posts Steel Plate Beam Guardrail, Type 2 Steel Plate Beam Guardrail, Type 6 Traffic Barrier Terminal, Type 1 Special (Tangent) Traffic Barrier Terminal, Type 1 Special (Flared)	20 lb/ft (30 kg/m) 30 lb/ft (45 kg/m) 8 lb/ft (12 kg/m) 305 lb (140 kg) each 1260 lb (570 kg) each 730 lb (330 kg) each 410 lb (185 kg) each
Steel Traffic Signal and Light Poles, Towers and Mast Arms Traffic Signal Post Light Pole, Tenon Mount and Twin Mount, 30 - 40 ft (9 - 12 m) Light Pole, Tenon Mount and Twin Mount, 45 - 55 ft (13.5 - 16.5 m) Light Pole w/Mast Arm, 30 - 50 ft (9 - 15.2 m) Light Pole w/Mast Arm, 55 - 60 ft (16.5 - 18 m) Light Tower w/Luminaire Mount, 80 - 110 ft (24 - 33.5 m) Light Tower w/Luminaire Mount, 120 - 140 ft (36.5 - 42.5 m) Light Tower w/Luminaire Mount, 150 - 160 ft (45.5 - 48.5 m)	11 lb/ft (16 kg/m) 14 lb/ft (21 kg/m) 21 lb/ft (31 kg/m) 13 lb/ft (19 kg/m) 19 lb/ft (28 kg/m) 31 lb/ft (46 kg/m) 65 lb/ft (97 kg/m) 80 lb/ft (119 kg/m)
Metal Railings (excluding wire fence) Steel Railing, Type SM Steel Railing, Type S-1 Steel Railing, Type T-1 Steel Bridge Rail	64 lb/ft (95 kg/m) 39 lb/ft (58 kg/m) 53 lb/ft (79 kg/m) 52 lb/ft (77 kg/m)
Frames and Grates Frame Lids and Grates	250 lb (115 kg) 150 lb (70 kg)

Return With Bid

**ILLINOIS DEPARTMENT
OF TRANSPORTATION**

**OPTION FOR
STEEL COST ADJUSTMENT**

The bidder shall submit this completed form with his/her bid. Failure to submit the form, or failure to fill out the form completely, shall make this contract exempt of steel cost adjustments. After award, this form, when submitted shall become part of the contract.

Contract No.: _____

Company Name: _____

Contractor's Option:

Is your company opting to include this special provision as part of the contract plans?

Yes No

Signature: _____ **Date:** _____

DATE-TIME
DRAWN-SPEC

STATE OF ILLINOIS

DEPARTMENT OF TRANSPORTATION

PLANS FOR PROPOSED

VARIOUS ROUTES
D-8 ANNUAL
PATCHING 2009-2
VARIOUS COUNTIES

(ST. CLAIR, CLINTON, MONROE,
MARION, RANDOLPH & WASHINGTON)

C-98-080-08

FOR INDEX OF SHEETS SEE SHEET NO. 3



LOCATION OF SECTION INDICATED THUS 

D-98-086-08

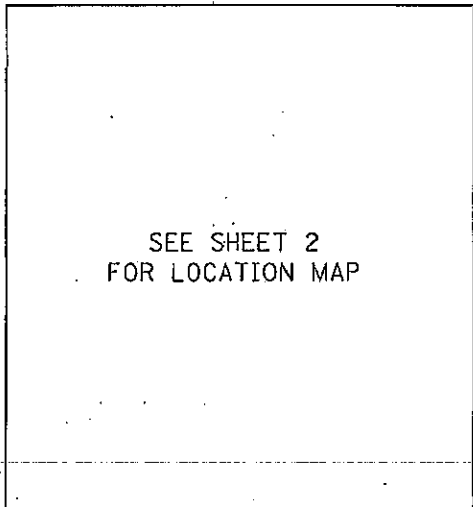

SEE SHEET 2
FOR LOCATION MAP

PROJECT ENGINEER: PATTI LEBEAU (618) 346-3179
PROJECT LEADER: DANA COUGHLIN (618) 346-3174
SQUAD LEADER: CHERYL KEPLAR (618) 346-3186

JOINT UTILITY LOCATION
INFORMATION FOR EXCAVATIONS
PHONE: (800) 892-0123

SUBMITTED March 27, 2008

Mary C. Jamie
DEPUTY DIRECTOR OF HIGHWAYS
REGION FIVE ENGINEER

PASSED _____

ENGINEER OF DESIGN & ENVIRONMENT

APPROVED _____

DIRECTOR, DIVISION OF HIGHWAYS

CONTRACT NO. 76C12

PRINTED BY THE AUTHORITY OF THE STATE OF ILLINOIS
PLOT DATE: *DATE-TIME*

TOTAL SHEETS	SHEET NO.
13	2
CONTRACT NO. T6C12	

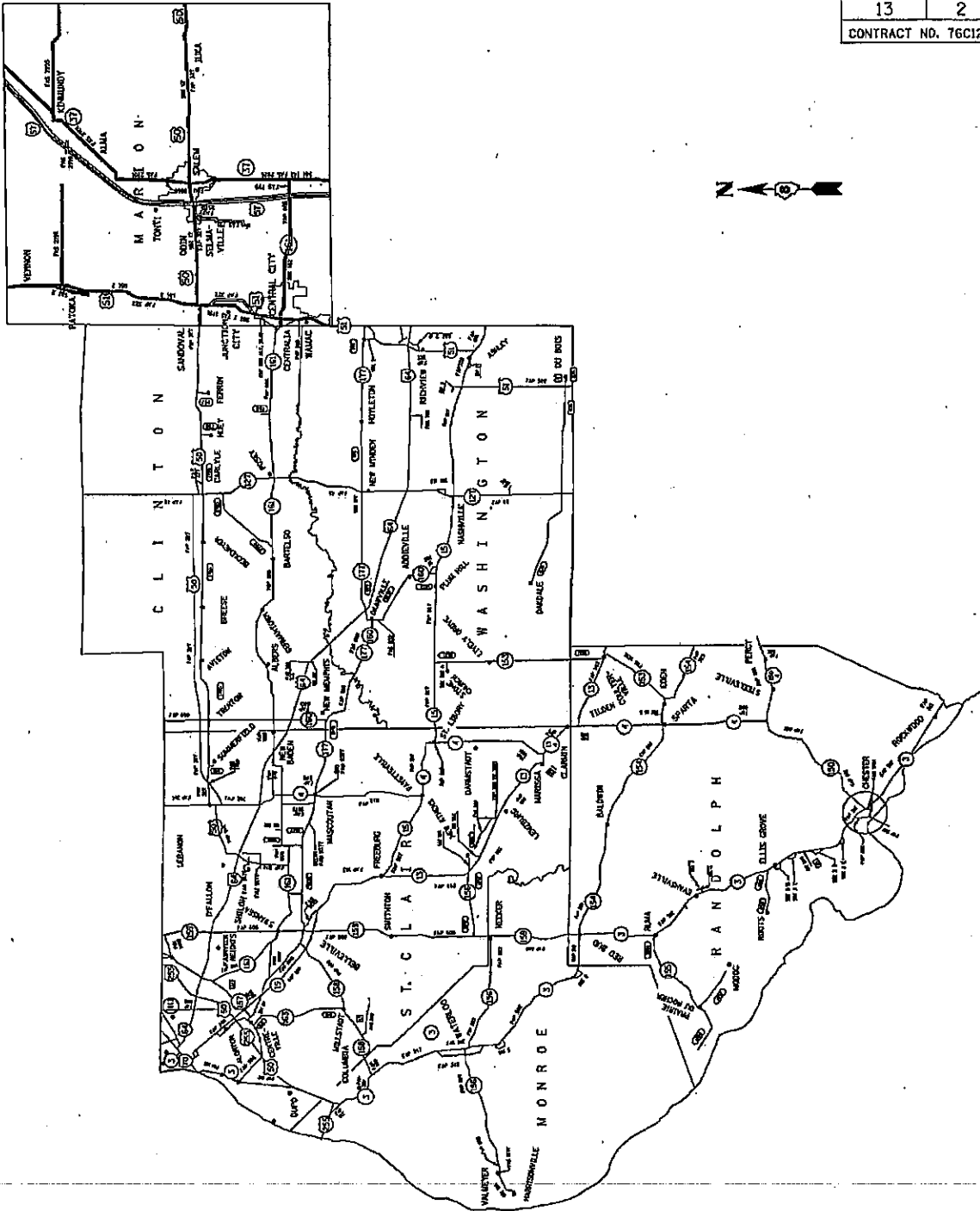

NOT TO SCALE

LOCATION MAP

VARIOUS ROUTES
D-8 ANNUAL PATCHING 2009-2
VARIOUS COUNTIES

PLOT DATE: *DAYE-TIME*

*DATE**
DATE-TIME
DGN-SPEC

TOTAL SHEETS	SHEET NO.
13	3
CONTRACT NO. 76C12	

INDEX OF SHEETS

- 1 COVER SHEET
- 2 LOCATION MAP
- 3 INDEX OF SHEETS AND HIGHWAY STANDARDS
- 4-5 GENERAL NOTES
- 6-7 SUMMARY OF QUANTITIES
- 8 I.D.O.T. CONTACT PERSONS
- 9-11 TRAFFIC CONTROL AND PROTECTION (SPECIAL)
- 12 EXPANSION JOINT (SPECIAL) DETAIL
- 13 PAVEMENT REPLACEMENT, CONCRETE (SPECIAL) DETAIL

HIGHWAY STANDARDS

420001-07	701201-02
420101-04	701400-02
420106-04	701401-04
420601-05	701411-04
420701-02	701422-01
421001-02	701446
421101-07	701501-04
442001-04	701601-05
442101-07	701606-05
442201-03	701901
601001-02	

INDEX OF SHEETS AND STANDARDS

VARIOUS ROUTES
D-8 ANNUAL PATCHING 2009-2
VARIOUS COUNTIES

PLOT DATE: *DATE-TIME*

DATE
 DATE-TIME
 DGN-SPEC

GENERAL NOTES

TOTAL SHEETS	SHEET NO.
13	4
CONTRACT NO. 76C12	

1. FOR EXIT RAMPS THE TAPER SHALL BEGIN AS SHOWN AND EXTEND TO THE LOCATION OF THE FIRST PATCH; FOR ENTRANCE RAMPS; THE TAPER SHALL BEGIN AT THE EDGE OF PAVEMENT AND EXTEND TO THE LOCATION OF THE FIRST PATCH FOR ENTRANCE RAMPS.
2. A FLAGGER SHALL BE REQUIRED AT ALL TIMES WHEN MEN OR EQUIPMENT ARE ENCROACHING THE LANE OF TRAFFIC.
3. WHEN NO WORK IS BEING PERFORMED, THE FLAGGERS WILL NOT BE REQUIRED. IF THE FLAGGERS ARE NOT PRESENT, THE FLAGGER SIGNS SHALL BE REMOVED OR COVERED.
4. BARRICADES OR DRUMS SHALL BE PLACED ALONG THE CENTER LINE OF THE RAMP. THE CHANNELIZING DEVICES SHALL BE PLACED AT A MAXIMUM OF 50 FOOT CENTERS.
5. TWO ADDITIONAL CHANNELIZING DEVICES SHALL BE PLACED AT EACH OPEN HOLE ON THE APPROACH SIDE OF THE OPEN HOLE.
6. LIGHTS WILL NOT BE REQUIRED FOR DAY OPERATIONS.
7. ALL SIGNS SHALL BE POST MOUNTED IF THE CLOSURE TIME EXCEEDS FOUR DAYS.
8. LONGITUDINAL DIMENSIONS MAY BE ADJUSTED TO FIT FIELD CONDITIONS. THE LATERAL PLACEMENT OF THE FLAGGER MAY BE VARIED FROM THAT SHOWN.
9. FORM BT725 IS REQUIRED.
10. FLASHING LIGHTS SHALL BE INSTALLED ON TOP OF THE FIRST TWO BARRICADES IN A SERIES.
11. A QUANTITY OF 30 HOURS FOR FLAGGER IS INCLUDED IN THE PLANS TO BE USED WHEN ADDITIONAL FLAGGERS ARE USED ABOVE AND BEYOND THE REQUIREMENT OF ARTICLE 701.04(C)(3) OF THE STANDARD SPECIFICATIONS FOR ROAD AND BRIDGE CONSTRUCTION.
12. NO OVERNIGHT LANE CLOSURES WILL BE ALLOWED ON TWO-LANE, TWO-WAY PAVEMENT.
13. FLAGMEN SHALL BE PRESENT DURING ALL CLOSURE HOURS INCLUDING LUNCH HOUR AND NO ADDITIONAL COMPENSATION SHALL BE ALLOWED.
14. ILLINOIS STATE LAW REQUIRES A 48-HOUR NOTICE TO BE GIVEN TO UTILITIES BEFORE DIGGING. FIELD MARKING OF FACILITIES MAY BE OBTAINED BY CONTACTING J.U.L.I.E. (PHONE: 800 892-0123) OR FOR NON-MEMBER, THE UTILITY COMPANY DIRECTLY.
15. THERE ARE NO COMMITMENTS FOR THE WORK BEING PERFORMED.
16. PIPE UNDERDRAINS SHALL UTILIZE FA1, FA2 OR CA16.
17. ALL CONCRETE AND BITUMINOUS TESTING WILL BE PERFORMED BY IDOT PERSONNEL.

GENERAL NOTES

VARIOUS ROUTES
D-8 ANNUAL PATCHING 2009-2
VARIOUS COUNTIES

PLOT DATE: *DATE-TIME*

##DATE##
DATE-TIME
DGN-SEC

TOTAL SHEETS	SHEET NO.
13	5
CONTRACT NO. 76C12	

GENERAL NOTES CONTINUED

18. THE FOLLOWING MIXTURE REQUIREMENTS ARE APPLICABLE FOR THIS PROJECT:

MIXTURE USE	BINDER
AC/PG	PG 64-22
RAP % (MAX)	10%
DESIGN AIR Voids	4.0% @ Ndes=90
MIX COMPOSITION (GRADATION MIXTURE)	
FRICTION AGG	MIXTURE B

PLAN QUANTITIES FOR BITUMINOUS CONCRETE SURFACE COURSE ITEMS ARE CALCULATED USING A UNIT WEIGHT OF 112 LB/SQ YD/IN (59.8 KG/SQ M/25MM THICKNESS).

GENERAL NOTES

VARIOUS ROUTES
D-8 ANNUAL PATCHING 2009-2
VARIOUS COUNTIES

PLOT DATE: *DATE-TIME*

DATE
DATE-TIME
IGN-SPEC

SUMMARY OF QUANTITIES

TOTAL SHEETS	SHEET NO.
13	6
CONTRACT NO. 76C12	

CODE NO.	ITEM	UNIT	100% STATE TOTAL QUANTITIES J000
44201294	CLASS B PATCH-EXPANSION JOINT	FOOT	50
44213100	PAVEMENT FABRIC	SQ YD	350
44213200	SAW CUTS	FOOT	4400
50800105	REINFORCEMENT BARS	POUND	4400
60100080	FRENCH DRAINS	CU YD	25
60107600	PIPE UNDERDRAINS 4"	FOOT	50
70100205	TRAFFIC CONTROL AND PROTECTION, STANDARD 701401	EACH	7
70100315	TRAFFIC CONTROL AND PROTECTION, STANDARD 701422	EACH	4
70100420	TRAFFIC CONTROL AND PROTECTION, STANDARD 701411	EACH	4
70100430	TRAFFIC CONTROL AND PROTECTION, STANDARD 701446	EACH	2
70101805	TRAFFIC CONTROL AND PROTECTION, (SPECIAL)	EACH	4
70103815	TRAFFIC CONTROL SURVEILLANCE	CAL DA	15
X0320006	PAVEMENT REPLACEMENT, CONCRETE	CU YD	400
X0320007	PAVEMENT REPLACEMENT, BITUMINOUS	CU YD	45
X0322662	TEMPORARY SIGNING	EACH	10
X0329860	PAVEMENT REPLACEMENT, CONCRETE (SPECIAL)	CU YD	15

SUMMARY OF QUANTITIES

VARIOUS ROUTES
D-8 ANNUAL PATCHING 2009-2
VARIOUS COUNTIES

PLOT DATE: DATE-TIME

SHEET NO.
 DATE-TIME
 JOB-SPEC

SUMMARY OF QUANTITIES

TOTAL SHEETS	SHEET NO.
13	7
CONTRACT NO. 78C12	

CODE NO	ITEM	UNIT	100% STATE TOTAL QUANTITIES J000.
X0329900	PAVEMENT REMOVAL FOR PATCHING, CASE A	CU YD	200
X0329901	PAVEMENT REMOVAL FOR PATCHING, CASE B	CU YD	150
X0329902	PAVEMENT REMOVAL FOR PATCHING, CASE C	CU YD	100
X7012610	TRAFFIC CONTROL AND PROTECTION, STANDARD 701201	EACH	4
X7012620	TRAFFIC CONTROL AND PROTECTION, STANDARD 701501	EACH	2
X7012625	TRAFFIC CONTROL AND PROTECTION, STANDARD 701606	EACH	3
X7012630	TRAFFIC CONTROL AND PROTECTION, STANDARD 701601	EACH	3
Z0002700	BARRICADES	EACH	100
Z0008759	CALL OUT	EACH	6
Z0017099	DOWEL BAR ASSEMBLY	EACH	8
Z0018900	DRILL AND GROUT DOWEL BARS	EACH	300
Z0021400	EXPANSION JOINT (SPECIAL)	FOOT	50
Z0024430	FLAGGER	HOUR	25
Z0075310	TIE BARS 3/4"	EACH	180

SUMMARY OF QUANTITIES

VARIOUS ROUTES
D-8 ANNUAL PATCHING 2009-2
VARIOUS COUNTIES

PLOT DATE: *DATE-TIME*

DATE
DATE-TIME
DGN-SPEC

TOTAL SHEETS	SHEET NO.
13	8
CONTRACT NO. 76C12	

I.D.O.T. CONTACT PERSONS

JEFF ABEL, AREA FIELD ENGINEER: OFFICE PHONE (618) 346-3283
MONROE COUNTY

DANA COUGHLIN, AREA FIELD ENGINEER: OFFICE PHONE (618) 346-3174
RANDOLPH, CLINTON, MARION, WASHINGTON
& ST. CLAIR COUNTIES

MARK HARRIS, FIELD TECHNICIAN
HECKER YARD (MONROE) OFFICE PHONE (618) 473-2583
COLUMBIA YARD (MONROE) OFFICE PHONE (618) 281-4565

TOM SHANK, FIELD TECHNICIAN OFFICE PHONE (618) 235-1466
BELLEVILLE YARD (ST. CLAIR)

MARK GARD, FIELD TECHNICIAN
STEELEVILLE YARD (RANDOLPH) OFFICE PHONE (618) 965-9611
NASHVILLE YARD (WASHINGTON) OFFICE PHONE (618) 327-3914

MIKE COX, FIELD TECHNICIAN OFFICE PHONE (618) 875-0177
BOWMAN YARD (ST. CLAIR)

JASON ROECKENHAUS, FIELD TECHNICIAN
CARLYLE YARD (CLINTON) OFFICE PHONE (618) 594-3001
SALEM YARD (MARION) OFFICE PHONE (618) 548-0463

I.D.O.T. CONTACT
PERSONS

VARIOUS ROUTES
D-8 ANNUAL PATCHING 2009-2
VARIOUS COUNTIES

PLOT DATE: *DATE-TIME*

DATE
DATE-TIME
DATE-SPEC

TOTAL SHEETS	SHEET NO.
13	9
CONTRACT NO. 76C12	

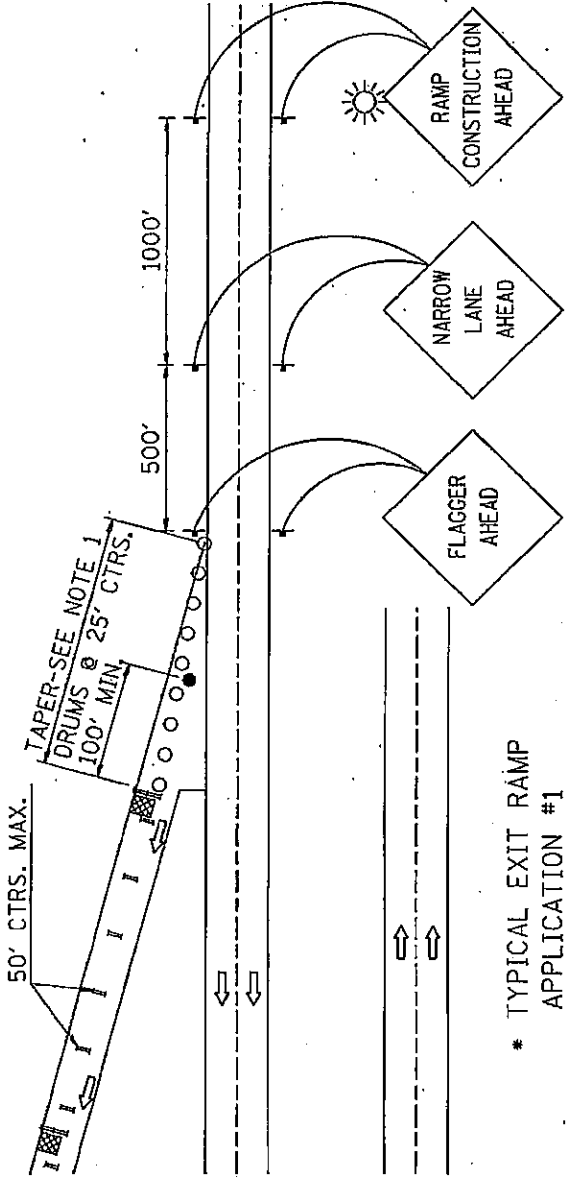

* TYPICAL EXIT RAMP APPLICATION #1

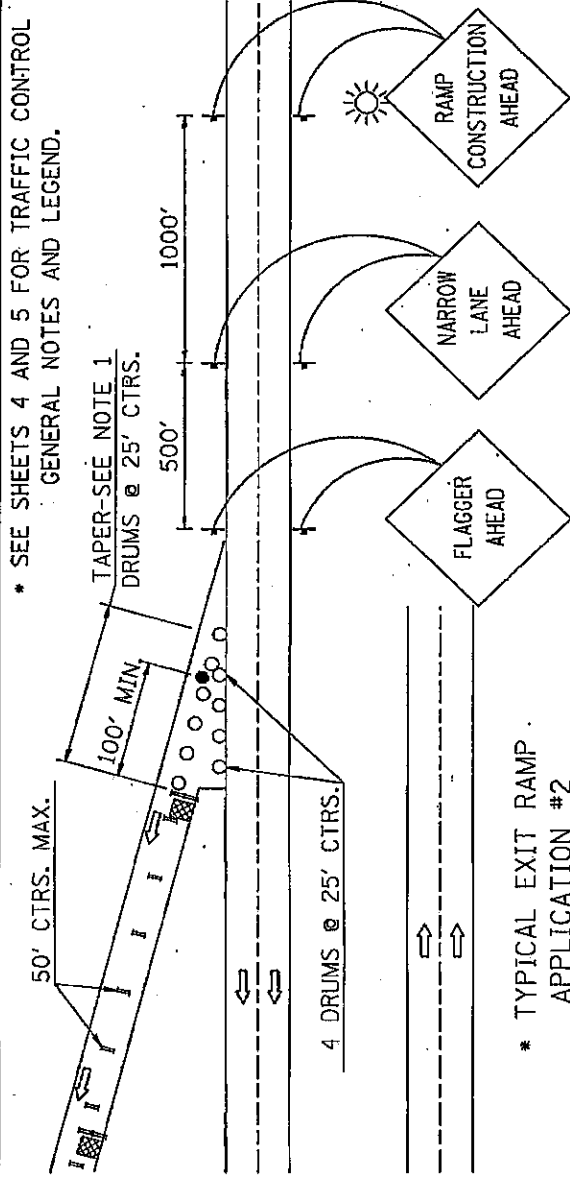

* TYPICAL EXIT RAMP APPLICATION #2

* SEE SHEETS 4 AND 5 FOR TRAFFIC CONTROL GENERAL NOTES AND LEGEND.

LEGEND

- PATCH
- FLAGGER WITH TRAFFIC CONTROL SIGN
- BARRICADE OR DRUM
- SIGN ON PORTABLE OR PERMANENT SUPPORT
- DRUM WITH STEADY BURNING LIGHT
- FLASHING LIGHTS

TRAFFIC CONTROL AND PROTECTION (SPECIAL)
 RAMPS
 VARIOUS ROUTES
 D-8 ANNUAL PATCHING 2009-2
 VARIOUS COUNTIES
 PLOT DATE: *DATE-TIME*





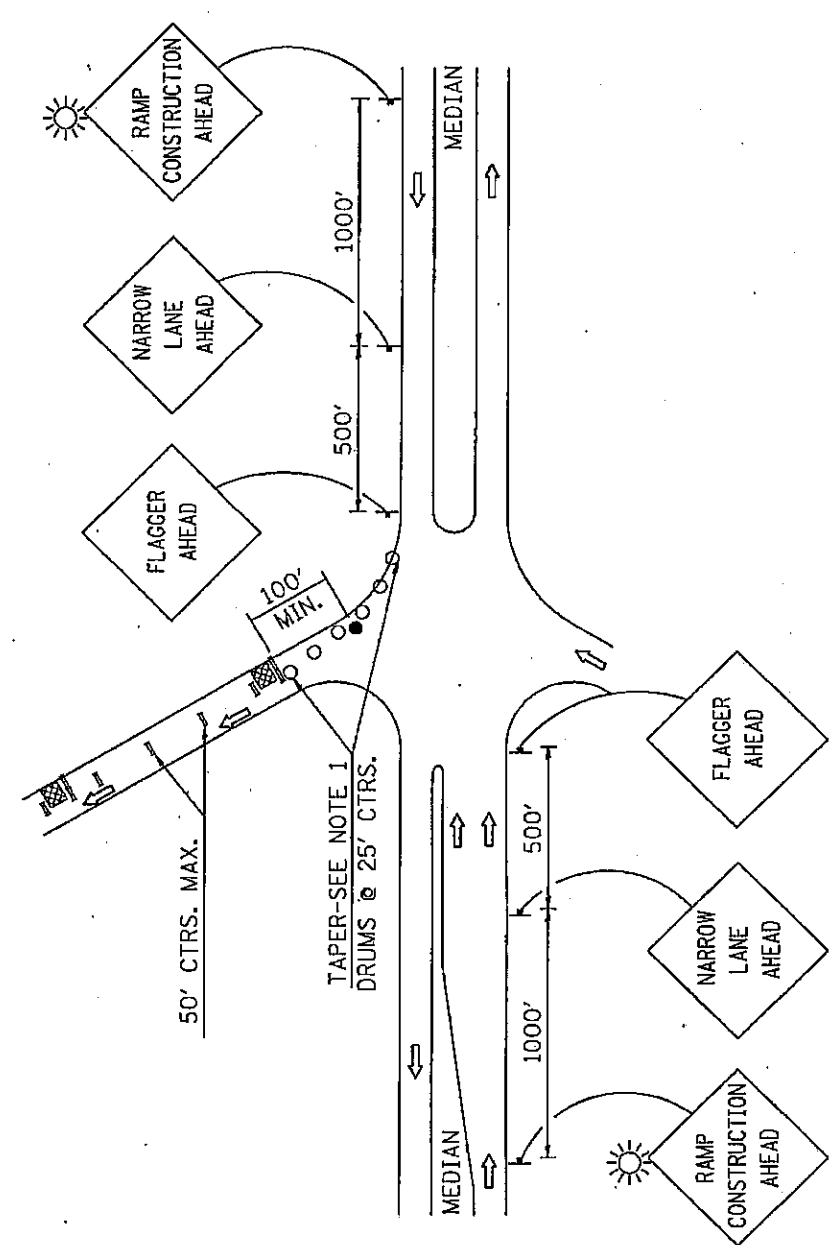

DATE
 DATE-TIME
 CON-SPEC

TOTAL SHEETS	SHEET NO.
13	10
CONTRACT NO. 76C12	



TYPICAL ENTRANCE RAMP
APPLICATION #3
SEE SHEETS 4 AND 5 FOR TRAFFIC CONTROL
GENERAL NOTES AND LEGEND

LEGEND

-  PATCH
-  FLAGGER WITH TRAFFIC CONTROL SIGN
-  BARRICADE OR DRUM
-  SIGN ON PORTABLE OR PERMANENT SUPPORT
-  DRUM WITH STEADY BURNING LIGHT
-  FLASHING LIGHTS

TRAFFIC CONTROL AND PROTECTION (SPECIAL)
RAMPS
VARIOUS ROUTES
D-8 ANNUAL PATCHING 2009-2
VARIOUS COUNTIES
PLOT DATE: *DATE-TIME*





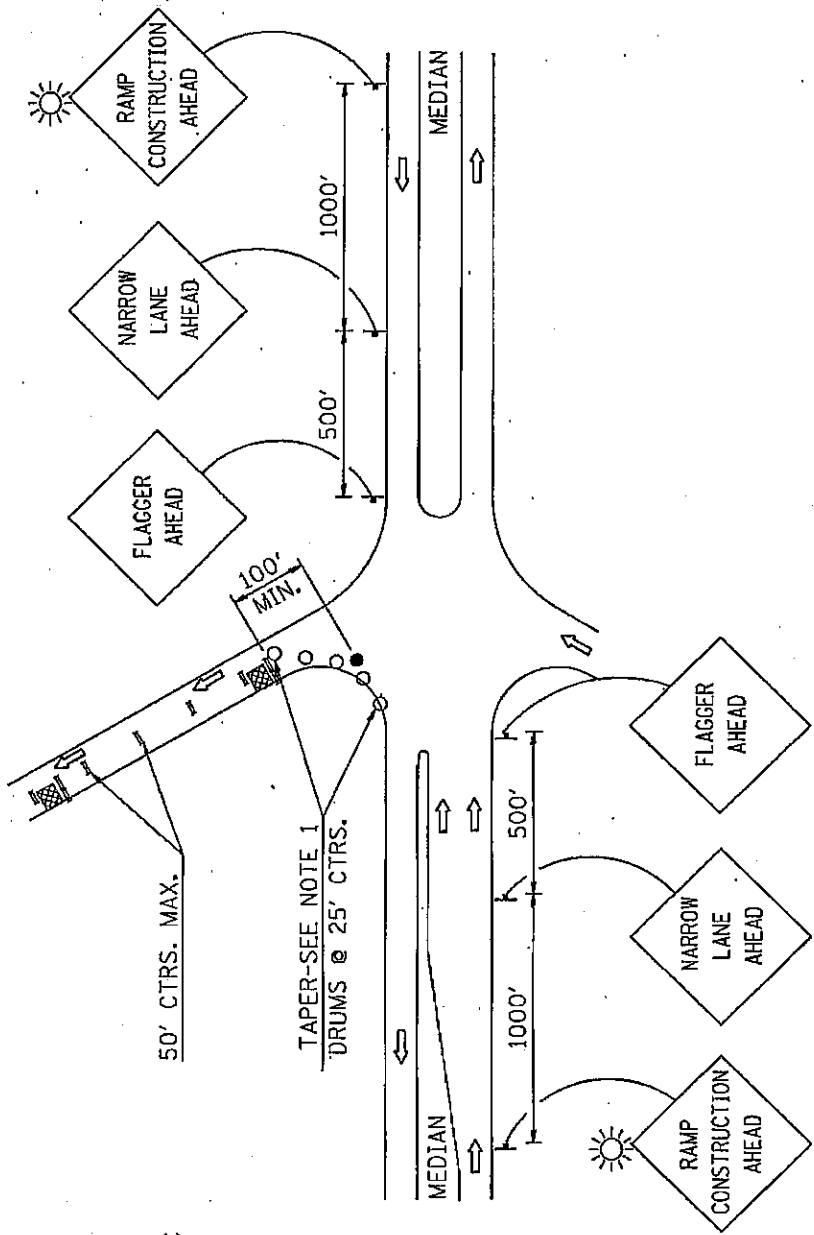

DATE
DATE-TIME
DIM-SPEC

TOTAL SHEETS	SHEET NO.
13	11
CONTRACT NO. 76C12	



TYPICAL ENTRANCE RAMP
APPLICATION #4
SEE SHEETS 4 AND 5 FOR TRAFFIC CONTROL
GENERAL NOTES AND LEGEND

LEGEND

-  PATCH
-  FLAGGER WITH TRAFFIC CONTROL SIGN
-  BARRICADE OR DRUM
-  SIGN ON PORTABLE OR PERMANENT SUPPORT
-  DRUM WITH STEADY BURNING LIGHT
-  FLASHING LIGHTS

TRAFFIC CONTROL AND PROTECTION (SPECIAL) RAMP
VARIOUS ROUTES
D-8 ANNUAL PATCHING 2009-2
VARIOUS COUNTIES

•DATE•
•DATE-TIME•
•SIGN-SPEC•

PLOT DATE: •DATE-TIME•

TOTAL SHEETS	SHEET NO.
13	12
CONTRACT NO. 76C12	

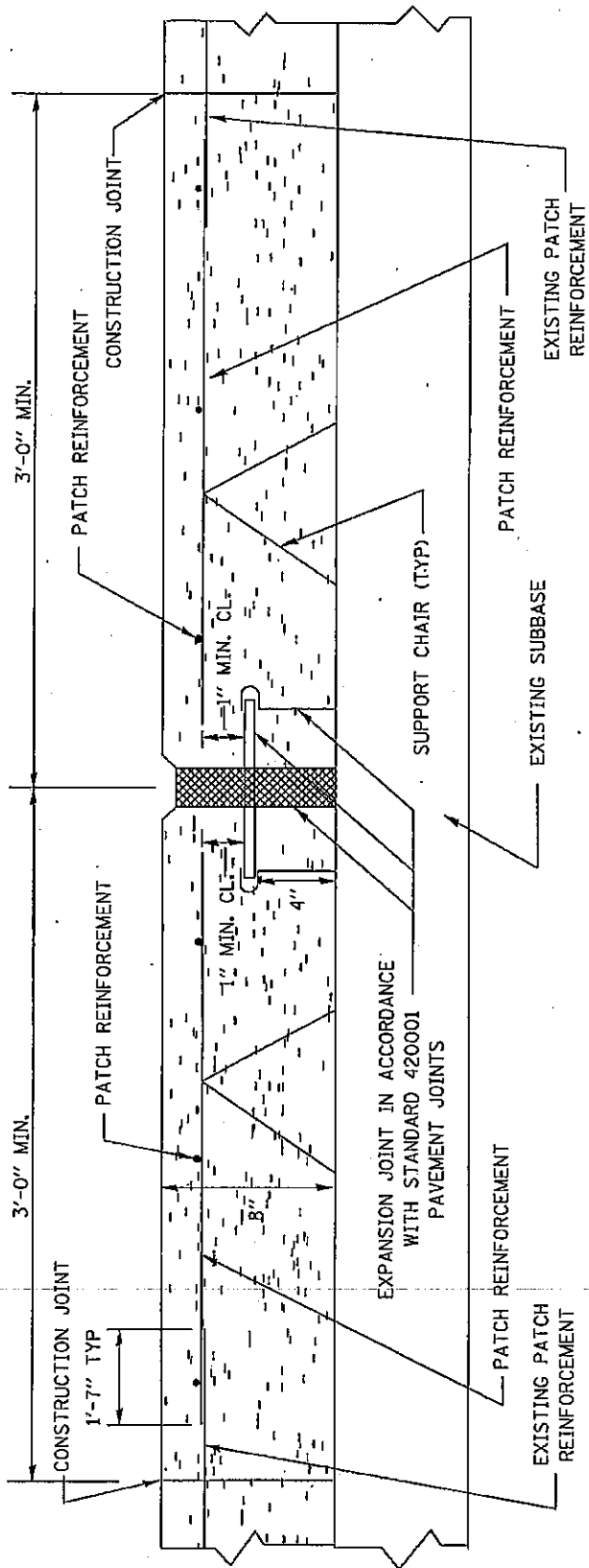

EXPANSION JOINT (SPECIAL)

EXPANSION JOINT
SPECIAL

VARIOUS ROUTES
D-8 ANNUAL PATCHING 2009-2
VARIOUS COUNTIES

PLOT DATE: *DATE-TIME*

DATE
DATE-TIME
CON-SPEC

TOTAL SHEETS	SHEET NO.
13	13
CONTRACT NO. 76C12	

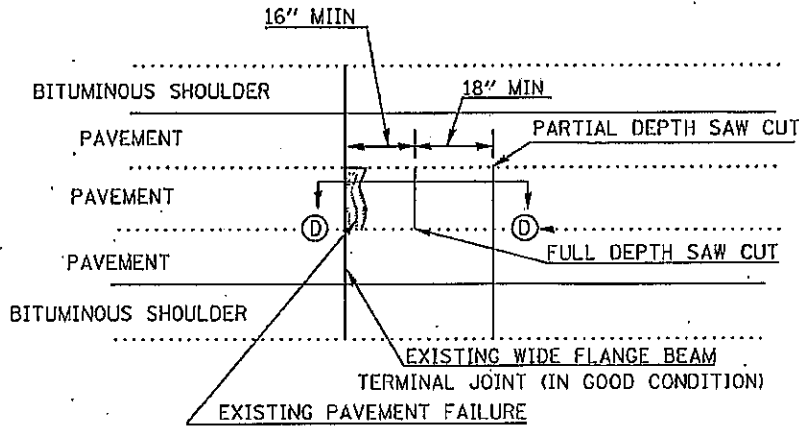

PAVEMENT SAWING DETAIL

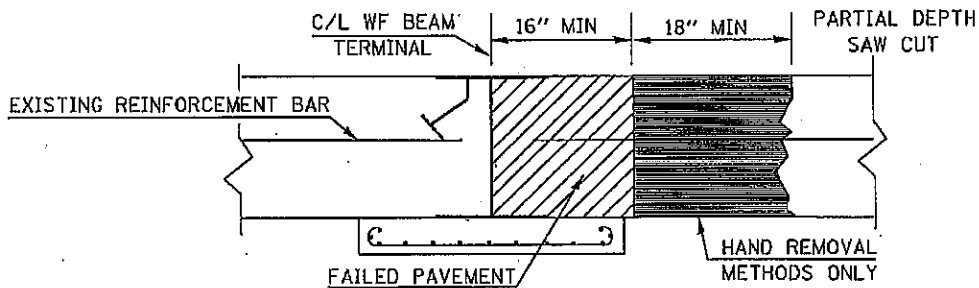

SECTION D-D

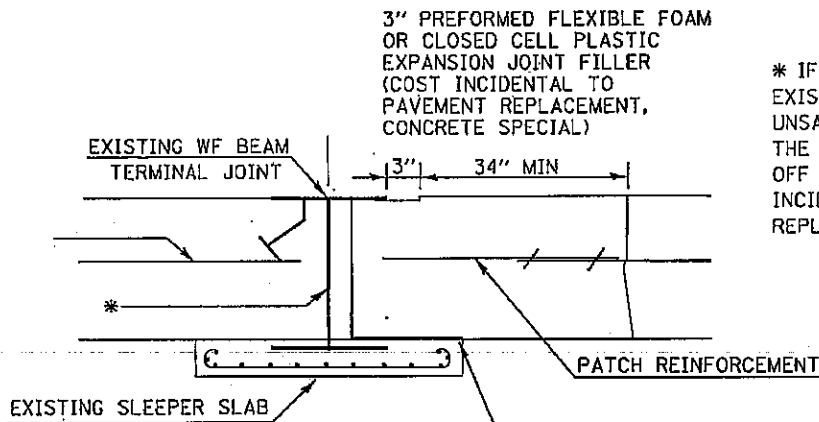

10 mm POLYETHYLENE PLACED BETWEEN SLEEPER SLAB AND NEW CLASS A PATCH TO ACT AS BOND BREAKER. (COST INCIDENTAL TO PAVEMENT REPLACEMENT CONCRETE SPECIAL)

PROPOSED REPAIRS

* IF R.E. DETERMINES EXISTING W.F. BEAM IS IN UNSATISFACTORY CONDITION, THE BEAM WILL BE CUT OFF AND REMOVED (COST INCIDENTAL TO PAVEMENT REPLACEMENT CONC. SPL.)

DETAILS FOR PAVEMENT REPLACEMENT CONCRETE SPECIAL

VARIOUS ROUTES
D-8 ANNUAL PATCHING 2009-2
VARIOUS COUNTIES

PLOT DATE: *DATE-TIME*

PROTECT DATE-TIME *DOB-SPEC*

ILLINOIS DEPARTMENT OF LABOR

PREVAILING WAGES FOR VARIOUS COUNTY EFFECTIVE MAY 2008

The Prevailing rates of wages are included in the Contract proposals which are subject to Check Sheet #5 of the Supplemental Specifications and Recurring Special Provisions. The rates have been ascertained and certified by the Illinois Department of Labor for the locality in which the work is to be performed and for each craft or type of work or mechanic needed to execute the work of the Contract. As required by Prevailing Wage Act (820 ILCS 130/0.01, et seq.) and Check Sheet #5 of the Contract, not less than the rates of wages ascertained by the Illinois Department of Labor and as revised during the performance of a Contract shall be paid to all laborers, workers and mechanics performing work under the Contract. Post the scale of wages in a prominent and easily accessible place at the site of work.

If the Illinois Department of Labor revises the prevailing rates of wages to be paid as listed in the specification of rates, the contractor shall post the revised rates of wages and shall pay not less than the revised rates of wages. Current wage rate information shall be obtained by visiting the Illinois Department of Labor web site at <http://www.state.il.us/agency/idol/> or by calling 312-793-2814. It is the responsibility of the contractor to review the rates applicable to the work of the contract at regular intervals in order to insure the timely payment of current rates. Provision of this information to the contractor by means of the Illinois Department of Labor web site satisfies the notification of revisions by the Department to the contractor pursuant to the Act, and the contractor agrees that no additional notice is required. The contractor shall notify each of its subcontractors of the revised rates of wages.

Clinton County Prevailing Wage for May 2008

Trade Name	RG	TYP	C	Base	FRMAN	*M-F>8	OSA	OSH	H/W	Pensn	Vac	Trng
=====	==	==	=	=====	=====	=====	==	==	=====	=====	=====	=====
ASBESTOS ABT-GEN		ALL		23.000	23.500	1.5	1.5	2.0	5.350	9.450	0.000	0.600
ASBESTOS ABT-MEC		BLD		25.690	26.690	1.5	1.5	2.0	5.050	2.500	0.000	0.250
BOILERMAKER		BLD		30.000	32.500	1.5	1.5	2.0	6.820	11.28	1.000	0.300
BRICK MASON		BLD		27.090	28.840	1.5	1.5	2.0	5.250	8.450	2.000	0.400
CARPENTER		ALL		31.230	32.730	1.5	1.5	2.0	5.300	4.000	0.000	0.350
CEMENT MASON		ALL		27.500	28.250	1.5	1.5	2.0	6.000	9.000	0.000	0.200
CERAMIC TILE FNSHER		BLD		23.370	0.000	1.5	1.5	2.0	5.200	4.400	0.000	0.410
ELECTRIC PWR EQMT OP		ALL		31.510	37.980	1.5	2.0	2.0	4.530	7.880	0.000	0.160
ELECTRIC PWR GRNDMAN		ALL		23.530	37.980	1.5	2.0	2.0	3.380	5.890	0.000	0.120
ELECTRIC PWR LINEMAN		ALL		36.220	37.980	1.5	2.0	2.0	5.210	9.060	0.000	0.180
ELECTRIC PWR TRK DRV		ALL		25.710	37.980	1.5	2.0	2.0	3.700	6.430	0.000	0.130
ELECTRICIAN	E	ALL		33.680	35.930	1.5	1.5	2.0	5.150	7.070	0.000	0.500
ELECTRICIAN	W	ALL		33.740	36.760	1.5	1.5	2.0	5.400	6.750	0.000	0.420
ELECTRONIC SYS TECH	E	BLD		26.740	28.240	1.5	1.5	2.0	5.150	3.470	0.000	0.250
ELECTRONIC SYS TECH	W	BLD		26.520	28.020	1.5	1.5	2.0	2.800	6.270	0.000	0.250
ELEVATOR CONSTRUCTOR		BLD		38.715	43.550	2.0	2.0	2.0	8.775	6.960	2.320	0.000
FLOOR LAYER		BLD		27.680	28.430	1.5	1.5	2.0	5.300	4.000	0.000	0.350
GLAZIER		BLD		30.140	0.000	2.0	2.0	2.0	8.800	7.520	2.410	0.310
HT/FROST INSULATOR		BLD		31.240	32.240	1.5	1.5	2.0	5.300	8.860	0.000	0.450
IRON WORKER		ALL		27.350	28.850	1.5	1.5	2.0	6.360	9.150	0.000	0.420
LABORER		ALL		22.500	23.000	1.5	1.5	2.0	5.350	9.450	0.000	0.600
MACHINIST		BLD		38.390	40.390	2.0	2.0	2.0	4.880	6.550	2.650	0.000
MARBLE FINISHERS		BLD		23.370	0.000	1.5	1.5	2.0	5.200	4.400	0.000	0.410
MILLWRIGHT		ALL		31.230	32.730	1.5	1.5	2.0	5.300	4.000	0.000	0.350
OPERATING ENGINEER		ALL	1	27.000	29.000	1.5	1.5	2.0	6.700	12.35	0.000	1.000
OPERATING ENGINEER		ALL	2	25.870	29.000	1.5	1.5	2.0	6.700	12.35	0.000	1.000
OPERATING ENGINEER		ALL	3	21.390	29.000	1.5	1.5	2.0	6.700	12.35	0.000	1.000
OPERATING ENGINEER		ALL	4	21.450	29.000	1.5	1.5	2.0	6.700	12.35	0.000	1.000
OPERATING ENGINEER		ALL	5	21.120	29.000	1.5	1.5	2.0	6.700	12.35	0.000	1.000
OPERATING ENGINEER		ALL	6	27.550	29.000	1.5	1.5	2.0	6.700	12.35	0.000	1.000
OPERATING ENGINEER		ALL	7	27.850	29.000	1.5	1.5	2.0	6.700	12.35	0.000	1.000
OPERATING ENGINEER		ALL	8	28.130	29.000	1.5	1.5	2.0	6.700	12.35	0.000	1.000
PAINTER		BLD		26.700	28.200	1.5	1.5	2.0	4.700	5.570	0.000	0.350
PAINTER		HWY		27.900	29.400	1.5	1.5	2.0	4.700	5.570	0.000	0.350
PAINTER OVER 30FT		BLD		27.700	29.200	1.5	1.5	2.0	4.700	5.570	0.000	0.350
PAINTER PWR EQMT		BLD		27.700	29.200	1.5	1.5	2.0	4.700	5.570	0.000	0.350
PAINTER PWR EQMT		HWY		28.900	30.400	1.5	1.5	2.0	4.700	5.570	0.000	0.350
PILEDRIVER		ALL		31.230	32.730	1.5	1.5	2.0	5.300	4.000	0.000	0.350
PIPEFITTER	E	BLD		30.000	33.000	1.5	1.5	2.0	5.650	5.000	0.000	0.850
PIPEFITTER	NW	BLD		30.000	32.000	1.5	1.5	2.0	5.940	7.000	0.000	0.350
PIPEFITTER	SW	BLD		31.700	34.200	1.5	1.5	2.0	6.400	4.100	0.000	0.525
PLASTERER		BLD		27.900	28.900	1.5	1.5	2.0	6.000	7.750	0.000	0.250
PLUMBER	E	BLD		30.000	33.000	1.5	1.5	2.0	5.650	5.000	0.000	0.850
PLUMBER	NW	BLD		31.700	34.200	1.5	1.5	2.0	5.200	5.450	0.000	0.300
PLUMBER	SW	BLD		31.700	34.200	1.5	1.5	2.0	6.400	4.100	0.000	0.525
ROOFER		BLD		26.750	28.750	1.5	1.5	2.0	6.100	5.900	0.000	0.200
SHEETMETAL WORKER		ALL		28.080	29.580	1.5	1.5	2.0	6.350	5.650	1.690	0.260
SPRINKLER FITTER		BLD		35.230	37.730	2.0	2.0	2.0	6.650	8.100	0.000	0.650
TERRAZZO FINISHER		BLD		31.240	0.000	1.5	1.5	2.0	0.000	0.000	0.000	0.000
TERRAZZO MASON		BLD		31.530	31.830	1.5	1.5	2.0	0.000	4.250	0.000	0.070
TRUCK DRIVER		ALL	1	27.580	0.000	1.5	1.5	2.0	8.600	3.925	0.000	0.000
TRUCK DRIVER		ALL	2	27.980	0.000	1.5	1.5	2.0	8.600	3.925	0.000	0.000
TRUCK DRIVER		ALL	3	28.180	0.000	1.5	1.5	2.0	8.600	3.925	0.000	0.000
TRUCK DRIVER		ALL	4	28.430	0.000	1.5	1.5	2.0	8.600	3.925	0.000	0.000
TRUCK DRIVER		ALL	5	29.180	0.000	1.5	1.5	2.0	8.600	3.925	0.000	0.000
TRUCK DRIVER		O&C	1	22.060	0.000	1.5	1.5	2.0	8.600	3.925	0.000	0.000
TRUCK DRIVER		O&C	2	22.380	0.000	1.5	1.5	2.0	8.600	3.925	0.000	0.000
TRUCK DRIVER		O&C	3	22.540	0.000	1.5	1.5	2.0	8.600	3.925	0.000	0.000

TRUCK DRIVER	O&C 4	22.740	0.000	1.5	1.5	2.0	8.600	3.925	0.000	0.000
TRUCK DRIVER	O&C 5	23.340	0.000	1.5	1.5	2.0	8.600	3.925	0.000	0.000

Legend:

M-F>8 (Overtime is required for any hour greater than 8 worked each day, Monday through Friday.)

OSA (Overtime is required for every hour worked on Saturday)

OSH (Overtime is required for every hour worked on Sunday and Holidays)

H/W (Health & Welfare Insurance)

Pensn (Pension)

Vac (Vacation)

Trng (Training)

Explanations

CLINTON COUNTY

ELECTRICIANS (WEST) - Townships of St. Rose, Wheatfield, Sugar Creek, Breese, Wade, Carlyle, Looking Glass, and German Town.

ELECTRONIC SYSTEMS TECHNICIAN (WEST) - Townships of St. Rose, Wheatfield, Sugar Creek, Breese, Wade, Carlyle, Looking Glass, and Germantown.

ELECTRONIC SYSTEMS TECHNICIAN (EAST) - Townships not included in WEST.

PLUMBERS & PIPEFITTERS (EAST) - That part of the county East of a North-South line 2.5 miles East of Rt. 127.

PLUMBERS & PIPEFITTERS (SOUTHWEST) - That part of the county South of New Route 50 and West of Route 127 inclusive.

The following list is considered as those days for which holiday rates of wages for work performed apply: New Years Day, Memorial/Decoration Day, Fourth of July, Labor Day, Veterans Day, Thanksgiving Day, Christmas Day. Generally, any of these holidays which fall on a Sunday is celebrated on the following Monday. This then makes work performed on that Monday payable at the appropriate overtime rate for holiday pay. Common practice in a given local may alter certain days of celebration such as the day after Thanksgiving for Veterans Day. If in doubt, please check with IDOL.

Oil and chip resealing (O&C) means the application of road oils and liquid asphalt to coat an existing road surface, followed by application of aggregate chips or gravel to coated surface, and subsequent rolling of material to seal the surface.

EXPLANATION OF CLASSES

ASBESTOS - GENERAL - removal of asbestos material/mold and hazardous materials from any place in a building, including mechanical systems where those mechanical systems are to be removed. This includes the removal of asbestos materials/mold and hazardous materials from

ductwork or pipes in a building when the building is to be demolished at the time or at some close future date.

ASBESTOS - MECHANICAL - removal of asbestos material from mechanical systems, such as pipes, ducts, and boilers, where the mechanical systems are to remain.

CERAMIC TILE FINISHER AND MARBLE FINISHER

The handling, at the building site, of all sand, cement, tile, marble or stone and all other materials that may be used and installed by [a] tile layer or marble mason. In addition, the grouting, cleaning, sealing, and mixing on the job site, and all other work as required in assisting the setter. The term "Ceramic" is used for naming the classification only and is in no way a limitation of the product handled. Ceramic takes into consideration most hard tiles.

ELECTRONIC SYSTEMS TECHNICIAN

Installation, service and maintenance of low-voltage systems which utilizes the transmission and/or transference of voice, sound, vision, or digital for commercial, education, security and entertainment purposes for the following: TV monitoring and surveillance, background/foreground music, intercom and telephone interconnect, field programming, inventory control systems, microwave transmission, multi-media, multiplex, radio page, school, intercom and sound burglar alarms and low voltage master clock systems.

Excluded from this classification are energy management systems, life safety systems, supervisory controls and data acquisition systems not intrinsic with the above listed systems, fire alarm systems, nurse call systems and raceways exceeding fifteen feet in length.

TRUCK DRIVER - BUILDING, HEAVY AND HIGHWAY CONSTRUCTION

Class 1. Drivers on 2 axle trucks hauling less than 9 ton. Air compressor and welding machines and brooms, including those pulled by separate units, truck driver helpers, warehouse employees, mechanic helpers, greasers and tiremen, pickup trucks when hauling materials, tools, or workers to and from and on-the-job site, and fork lifts up to 6,000 lb. capacity.

Class 2. Two or three axle trucks hauling more than 9 ton but hauling less than 16 ton. A-frame winch trucks, hydrolift trucks, vector trucks or similar equipment when used for transportation purposes. Fork lifts over 6,000 lb. capacity, winch trucks, four axle combination units, and ticket writers.

Class 3. Two, three or four axle trucks hauling 16 ton or more. Drivers on water pulls, articulated dump trucks, mechanics and working forepersons, and dispatchers. Five axle or more combination units.

Class 4. Low Boy and Oil Distributors.

Class 5. Drivers who require special protective clothing while employed on hazardous waste work.

TRUCK DRIVER - OIL AND CHIP RESEALING ONLY.

This shall encompass laborers, workers and mechanics who drive contractor or subcontractor owned, leased, or hired pickup, dump, service, or oil distributor trucks. The work includes transporting materials and equipment (including but not limited to, oils, aggregate supplies, parts, machinery and tools) to or from the job site;

distributing oil or liquid asphalt and aggregate; stock piling material when in connection with the actual oil and chip contract. The Truck Driver (Oil & Chip Resealing) wage classification does not include supplier delivered materials.

OPERATING ENGINEERS

GROUP I. Cranes, Dragline, Shovels, Skimmer Scoops, Clamshells or Derrick Boats, Pile Drivers, Crane-Type Backhoes, Asphalt Plant Operators, Concrete Plant Operators, Dredges, Asphalt Spreading Machines, All Locomotives, Cable Ways, or Tower Machines, Hoists, Hydraulic Backhoes, Ditching Machines or Backfiller, Cherrypickers, Overhead Cranes, Roller, Steam or Gas, Concrete Pavers, Excavators, Concrete Breakers, Concrete Pumps, Bulk Cement Plants, Cement Pumps, Derrick-Type Drills, Boat Operators, Motor Graders or Pushcats, Scoops or Tournapulls, Bulldozers, Endloaders or Fork Lifts, Power Blade or Elevating Graders, Winch Cats, Boom or Winch Trucks or Boom Tractors, Pipe Wrapping or Painting Machines, Asphalt Plant Engineer, Journeyman Lubricating Engineer, Drills (other than Derrick Type), Mud Jacks, or Well Drilling Machines, Boring Machines or Track Jacks, Mixers, Conveyors (Two), Air Compressors (Two), Water Pumps regardless of size (Two), Welding Machines (Two), Siphons or Jets (Two), Winch Heads or Apparatuses (Two), Light Plants (Two), Waterblasters (two), All Tractors regardless of size (straight tractor only), Fireman on Stationary Boilers, Automatic Elevators, Form Grading Machines, Finishing Machines, Power Sub-Grader or Ribbon Machines, Longitudinal Floats, Distributor Operators on Trucks, Winch Heads or Apparatuses (One), Mobil Track air and heaters (two to five), Heavy Equipment Greaser, Relief Operator, Assistant Master Mechanic and Heavy Duty Mechanic, all Operators (except those listed below).

GROUP II. Assistant Operators.

GROUP III. Air Compressors (One), Water Pumps, regardless of Size (One), Waterblasters (one), Welding Machine (One), Mixers (One Bag), Conveyor (One), Siphon or Jet (One), Light Plant (One), Heater (One), Immobile Track Air (One), and Self Propelled Walk-Behind Rollers.

GROUP IV. Asphalt Spreader Oilers, Fireman on Whirlies and Heavy Equipment Oilers, Truck Cranes, Dredges, Monigans, Large Cranes - (Over 65-ton rated capacity) Concrete Plant Oiler, Blacktop Plant Oiler, and Creter Crane Oiler (when required).

GROUP V. Oiler.

GROUP VI. Master Mechanics, Operators on equipment with Booms, including jibs, 100 feet and over, and less than 150 feet long.

GROUP VII. Operators on equipment with Booms, including jibs, 150 feet and over, and less than 200 feet long.

GROUP VIII. Operators on Equipment with Booms, including jibs, 200 feet and over; Tower Cranes; Whirlie Cranes; and Operator Foreman.

TERRAZZO FINISHER

The handling of all materials used for Mosaic and Terrazzo work including preparing, mixing by hand, by mixing machine or transporting of pre-mixed materials and distributing with shovel, rake, hoe, or pail, all kinds of concrete foundations necessary for Mosaic and Terrazzo work, all cement terrazzo, magnesite terrazzo, Do-O-Tex terrazzo, epoxy matrix ter-razzo, exposed aggregate, rustic or rough washed for exterior or interior of buildings placed either by machine

or by hand, and any other kind of mixture of plastics composed of chips or granules when mixed with cement, rubber, neoprene, vinyl, magnesium chloride or any other resinous or chemical substances used for seamless flooring systems, and all other building materials, all similar materials and all precast terrazzo work on jobs, all scratch coat used for Mosaic and Terrazzo work and sub-bed, tar paper and wire mesh (2x2 etc.) or lath. The rubbing, grinding, cleaning and finishing of same either by hand or by machine or by terrazzo resurfacing equipment on new or existing floors. When necessary finishers shall be allowed to assist the mechanics to spread sand bed, lay tarpaper and wire mesh (2x2 etc.) or lath. The finishing of cement floors where additional aggregate of stone is added by spreading or sprinkling on top of the finished base, and troweled or rolled into the finish and then the surface is ground by grinding machines.

Other Classifications of Work:

For definitions of classifications not otherwise set out, the Department generally has on file such definitions which are available. If a task to be performed is not subject to one of the classifications of pay set out, the Department will upon being contacted state which neighboring county has such a classification and provide such rate, such rate being deemed to exist by reference in this document. If no neighboring county rate applies to the task, the Department shall undertake a special determination, such special determination being then deemed to have existed under this determination. If a project requires these, or any classification not listed, please contact IDOL at 618/993-7271 for wage rates or clarifications.

LANDSCAPING

Landscaping work falls under the existing classifications for laborer, operating engineer and truck driver. The work performed by landscape plantsman and landscape laborer is covered by the existing classification of laborer. The work performed by landscape operators (regardless of equipment used or its size) is covered by the classifications of operating engineer. The work performed by landscape truck drivers (regardless of size of truck driven) is covered by the classifications of truck driver.

Marion County Prevailing Wage for May 2008

Trade Name	RG	TYP	C	Base	FRMAN	*M-F>8	OSA	OSH	H/W	Pensn	Vac	Trng
=====	==	==	=	=====	=====	=====	==	==	=====	=====	=====	=====
ASBESTOS ABT-GEN		ALL		21.000	21.450	1.5	1.5	2.0	5.350	6.500	0.000	0.700
ASBESTOS ABT-MEC		BLD		25.690	26.690	1.5	1.5	2.0	5.050	2.500	0.000	0.250
BOILERMAKER		BLD		30.000	32.500	1.5	1.5	2.0	6.820	11.28	1.000	0.300
BRICK MASON		BLD		27.090	28.840	1.5	1.5	2.0	5.250	8.450	2.000	0.400
CARPENTER		BLD		28.530	30.030	1.5	1.5	2.0	5.300	4.000	0.000	0.350
CARPENTER		HWY		28.480	30.230	1.5	1.5	2.0	5.300	4.000	0.000	0.350
CEMENT MASON		BLD		24.000	25.000	1.5	1.5	2.0	5.300	4.050	0.000	0.200
CEMENT MASON		HWY		23.500	25.000	1.5	1.5	2.0	5.300	3.700	0.000	0.200
CERAMIC TILE FNSHER		BLD		23.370	0.000	1.5	1.5	2.0	5.200	4.400	0.000	0.410
ELECTRICIAN		ALL		33.680	35.930	1.5	1.5	2.0	5.150	7.070	0.000	0.500
ELECTRONIC SYS TECH		BLD		26.740	28.240	1.5	1.5	2.0	5.150	3.470	0.000	0.250
FLOOR LAYER		BLD		27.680	28.430	1.5	1.5	2.0	5.300	4.000	0.000	0.350
GLAZIER		BLD		30.140	0.000	2.0	2.0	2.0	8.800	7.520	2.410	0.310
HT/FROST INSULATOR		BLD		31.240	32.240	1.5	1.5	2.0	5.300	8.860	0.000	0.450
IRON WORKER		ALL		27.350	28.850	1.5	1.5	2.0	6.360	9.150	0.000	0.420
LABORER		BLD		21.000	21.450	1.5	1.5	2.0	5.350	6.500	0.000	0.600
LABORER		HWY		21.000	21.450	1.5	1.5	2.0	5.350	6.150	0.000	0.600
MACHINIST		BLD		38.390	40.390	2.0	2.0	2.0	4.880	6.550	2.650	0.000
MARBLE FINISHERS		BLD		23.370	0.000	1.5	1.5	2.0	5.200	4.400	0.000	0.410
MARBLE MASON		BLD		27.090	28.840	1.5	1.5	2.0	5.250	8.450	2.000	0.400
MILLWRIGHT		BLD		28.530	30.030	1.5	1.5	2.0	5.300	4.000	0.000	0.350
MILLWRIGHT		HWY		28.480	30.230	1.5	1.5	2.0	5.300	4.000	0.000	0.350
OPERATING ENGINEER		ALL	1	27.000	29.000	1.5	1.5	2.0	6.700	12.35	0.000	1.000
OPERATING ENGINEER		ALL	2	25.870	29.000	1.5	1.5	2.0	6.700	12.35	0.000	1.000
OPERATING ENGINEER		ALL	3	21.390	29.000	1.5	1.5	2.0	6.700	12.35	0.000	1.000
OPERATING ENGINEER		ALL	4	21.450	29.000	1.5	1.5	2.0	6.700	12.35	0.000	1.000
OPERATING ENGINEER		ALL	5	21.120	29.000	1.5	1.5	2.0	6.700	12.35	0.000	1.000
OPERATING ENGINEER		ALL	6	27.550	29.000	1.5	1.5	2.0	6.700	12.35	0.000	1.000
OPERATING ENGINEER		ALL	7	27.850	29.000	1.5	1.5	2.0	6.700	12.35	0.000	1.000
OPERATING ENGINEER		ALL	8	28.130	29.000	1.5	1.5	2.0	6.700	12.35	0.000	1.000
PAINTER		ALL		21.320	21.820	1.5	1.5	2.0	4.700	4.650	0.000	0.230
PAINTER OVER 30FT		ALL		24.420	24.920	1.5	1.5	2.0	4.700	4.650	0.000	0.230
PAINTER PWR EQMT		ALL		24.420	24.920	1.5	1.5	2.0	4.700	4.650	0.000	0.230
PILEDRIVER		BLD		28.530	30.030	1.5	1.5	2.0	5.300	4.000	0.000	0.350
PILEDRIVER		HWY		28.480	30.230	1.5	1.5	2.0	5.300	4.000	0.000	0.350
PIPEFITTER		BLD		30.000	33.000	1.5	1.5	2.0	5.650	5.000	0.000	0.850
PLASTERER		BLD		23.500	24.500	1.5	1.5	2.0	5.200	3.550	0.000	0.100
PLUMBER		BLD		30.000	33.000	1.5	1.5	2.0	5.650	5.000	0.000	0.850
ROOFER		BLD		20.450	21.450	1.5	1.5	2.0	6.200	3.800	0.000	0.000
SHEETMETAL WORKER		ALL		28.080	29.580	1.5	1.5	2.0	6.350	5.650	1.690	0.260
SPRINKLER FITTER		BLD		35.140	37.690	1.5	1.5	2.0	7.000	6.200	0.000	0.250
TERRAZZO FINISHER		BLD		31.240	0.000	1.5	1.5	2.0	0.000	0.000	0.000	0.000
TERRAZZO MASON		BLD		31.530	31.830	1.5	1.5	2.0	0.000	4.250	0.000	0.070
TRUCK DRIVER		ALL	1	27.580	0.000	1.5	1.5	2.0	8.600	3.925	0.000	0.000
TRUCK DRIVER		ALL	2	27.980	0.000	1.5	1.5	2.0	8.600	3.925	0.000	0.000
TRUCK DRIVER		ALL	3	28.180	0.000	1.5	1.5	2.0	8.600	3.925	0.000	0.000
TRUCK DRIVER		ALL	4	28.430	0.000	1.5	1.5	2.0	8.600	3.925	0.000	0.000
TRUCK DRIVER		ALL	5	29.180	0.000	1.5	1.5	2.0	8.600	3.925	0.000	0.000
TRUCK DRIVER		O&C	1	22.060	0.000	1.5	1.5	2.0	8.600	3.925	0.000	0.000
TRUCK DRIVER		O&C	2	22.380	0.000	1.5	1.5	2.0	8.600	3.925	0.000	0.000
TRUCK DRIVER		O&C	3	22.540	0.000	1.5	1.5	2.0	8.600	3.925	0.000	0.000
TRUCK DRIVER		O&C	4	22.740	0.000	1.5	1.5	2.0	8.600	3.925	0.000	0.000
TRUCK DRIVER		O&C	5	23.340	0.000	1.5	1.5	2.0	8.600	3.925	0.000	0.000

Legend:

M-F>8 (Overtime is required for any hour greater than 8 worked each day, Monday through Friday).

OSA (Overtime is required for every hour worked on Saturday)

OSH (Overtime is required for every hour worked on Sunday and Holidays)

H/W (Health & Welfare Insurance)

Pensn (Pension)

Vac (Vacation)

Trng (Training)

Explanations

MARION COUNTY

The following list is considered as those days for which holiday rates of wages for work performed apply: New Years Day, Memorial/Decoration Day, Fourth of July, Labor Day, Veterans Day, Thanksgiving Day, Christmas Day. Generally, any of these holidays which fall on a Sunday is celebrated on the following Monday. This then makes work performed on that Monday payable at the appropriate overtime rate for holiday pay. Common practice in a given local may alter certain days of celebration such as the day after Thanksgiving for Veterans Day. If in doubt, please check with IDOL.

Oil and chip resealing (O&C) means the application of road oils and liquid asphalt to coat an existing road surface, followed by application of aggregate chips or gravel to coated surface, and subsequent rolling of material to seal the surface.

EXPLANATION OF CLASSES

ASBESTOS - GENERAL - removal of asbestos material/mold and hazardous materials from any place in a building, including mechanical systems where those mechanical systems are to be removed. This includes the removal of asbestos materials/mold and hazardous materials from ductwork or pipes in a building when the building is to be demolished at the time or at some close future date.

ASBESTOS - MECHANICAL - removal of asbestos material from mechanical systems, such as pipes, ducts, and boilers, where the mechanical systems are to remain.

CERAMIC TILE FINISHER AND MARBLE FINISHER

The handling, at the building site, of all sand, cement, tile, marble or stone and all other materials that may be used and installed by [a] tile layer or marble mason. In addition, the grouting, cleaning, sealing, and mixing on the job site, and all other work as required in assisting the setter. The term "Ceramic" is used for naming the classification only and is in no way a limitation of the product handled. Ceramic takes into consideration most hard tiles.

ELECTRONIC SYSTEMS TECHNICIAN

Installation, service and maintenance of low-voltage systems which utilizes the transmission and/or transference of voice, sound, vision, or digital for commercial, education, security and entertainment

purposes for the following: TV monitoring and surveillance, background/foreground music, intercom and telephone interconnect, field programming, inventory control systems, microwave transmission, multi-media, multiplex, radio page, school, intercom and sound burglar alarms and low voltage master clock systems.

Excluded from this classification are energy management systems, life safety systems, supervisory controls and data acquisition systems not intrinsic with the above listed systems, fire alarm systems, nurse call systems and raceways exceeding fifteen feet in length.

TRUCK DRIVER - BUILDING, HEAVY AND HIGHWAY CONSTRUCTION

Class 1. Drivers on 2 axle trucks hauling less than 9 ton. Air compressor and welding machines and brooms, including those pulled by separate units, truck driver helpers, warehouse employees, mechanic helpers, greasers and tiremen, pickup trucks when hauling materials, tools, or workers to and from and on-the-job site, and fork lifts up to 6,000 lb. capacity.

Class 2. Two or three axle trucks hauling more than 9 ton but hauling less than 16 ton. A-frame winch trucks, hydrolift trucks, vector trucks or similar equipment when used for transportation purposes. Fork lifts over 6,000 lb. capacity, winch trucks, four axle combination units, and ticket writers.

Class 3. Two, three or four axle trucks hauling 16 ton or more. Drivers on water pulls, articulated dump trucks, mechanics and working forepersons, and dispatchers. Five axle or more combination units.

Class 4. Low Boy and Oil Distributors.

Class 5. Drivers who require special protective clothing while employed on hazardous waste work.

TRUCK DRIVER - OIL AND CHIP RESEALING ONLY.

This shall encompass laborers, workers and mechanics who drive contractor or subcontractor owned, leased, or hired pickup, dump, service, or oil distributor trucks. The work includes transporting materials and equipment (including but not limited to, oils, aggregate supplies, parts, machinery and tools) to or from the job site; distributing oil or liquid asphalt and aggregate; stock piling material when in connection with the actual oil and chip contract. The Truck Driver (Oil & Chip Resealing) wage classification does not include supplier delivered materials.

OPERATING ENGINEERS

GROUP I. Cranes, Dragline, Shovels, Skimmer Scoops, Clamshells or Derrick Boats, Pile Drivers, Crane-Type Backhoes, Asphalt Plant Operators, Concrete Plant Operators, Dredges, Asphalt Spreading Machines, All Locomotives, Cable Ways, or Tower Machines, Hoists, Hydraulic Backhoes, Ditching Machines or Backfiller, Cherrypickers, Overhead Cranes, Roller, Steam or Gas, Concrete Pavers, Excavators, Concrete Breakers, Concrete Pumps, Bulk Cement Plants, Cement Pumps, Derrick-Type Drills, Boat Operators, Motor Graders or Pushcats, Scoops or Tournapulls, Bulldozers, Endloaders or Fork Lifts, Power Blade or Elevating Graders, Winch Cats, Boom or Winch Trucks or Boom Tractors, Pipe Wrapping or Painting Machines, Asphalt Plant Engineer, Journeyman Lubricating Engineer, Drills (other than Derrick Type), Mud Jacks, or Well Drilling Machines, Boring Machines or Track Jacks, Mixers, Conveyors (Two), Air Compressors (Two), Water Pumps regardless of size (Two), Welding Machines (Two), Siphons or Jets

(Two), Winch Heads or Apparatuses (Two), Light Plants (Two), Waterblasters (two), All Tractors regardless of size (straight tractor only), Fireman on Stationary Boilers, Automatic Elevators, Form Grading Machines, Finishing Machines, Power Sub-Grader or Ribbon Machines, Longitudinal Floats, Distributor Operators on Trucks, Winch Heads or Apparatuses (One), Mobil Track air and heaters (two to five), Heavy Equipment Greaser, Relief Operator, Assistant Master Mechanic and Heavy Duty Mechanic, all Operators (except those listed below).

GROUP II. Assistant Operators.

GROUP III. Air Compressors (One), Water Pumps, regardless of Size (One), Waterblasters (one), Welding Machine (One), Mixers (One Bag), Conveyor (One), Siphon or Jet (One), Light Plant (One), Heater (One), Immobile Track Air (One), and Self Propelled Walk-Behind Rollers.

GROUP IV. Asphalt Spreader Oilers, Fireman on Whirlies and Heavy Equipment Oilers, Truck Cranes, Dredges, Monigans, Large Cranes - (Over 65-ton rated capacity) Concrete Plant Oiler, Blacktop Plant Oiler, and Creter Crane Oiler (when required).

GROUP V. Oiler.

GROUP VI. Master Mechanics, Operators on equipment with Booms, including jibs, 100 feet and over, and less than 150 feet long.

GROUP VII. Operators on equipment with Booms, including jibs, 150 feet and over, and less than 200 feet long.

GROUP VIII. Operators on Equipment with Booms, including jibs, 200 feet and over; Tower Cranes; Whirlie Cranes; and Operator Foreman.

TERRAZZO FINISHER

The handling of all materials used for Mosaic and Terrazzo work including preparing, mixing by hand, by mixing machine or transporting of pre-mixed materials and distributing with shovel, rake, hoe, or pail, all kinds of concrete foundations necessary for Mosaic and Terrazzo work, all cement terrazzo, magnesite terrazzo, Do-O-Tex terrazzo, epoxy matrix ter-razzo, exposed aggregate, rustic or rough washed for exterior or interior of buildings placed either by machine or by hand, and any other kind of mixture of plastics composed of chips or granules when mixed with cement, rubber, neoprene, vinyl, magnesium chloride or any other resinous or chemical substances used for seamless flooring systems, and all other building materials, all similar materials and all precast terrazzo work on jobs, all scratch coat used for Mosaic and Terrazzo work and sub-bed, tar paper and wire mesh (2x2 etc.) or lath. The rubbing, grinding, cleaning and finishing of same either by hand or by machine or by terrazzo resurfacing equipment on new or existing floors. When necessary finishers shall be allowed to assist the mechanics to spread sand bed, lay tarpaper and wire mesh (2x2 etc.) or lath. The finishing of cement floors where additional aggregate of stone is added by spreading or sprinkling on top of the finished base, and troweled or rolled into the finish and then the surface is ground by grinding machines.

Other Classifications of Work:

For definitions of classifications not otherwise set out, the Department generally has on file such definitions which are available.

If a task to be performed is not subject to one of the classifications of pay set out, the Department will upon being contacted state which neighboring county has such a classification and provide such rate, such rate being deemed to exist by reference in this document. If no neighboring county rate applies to the task, the Department shall undertake a special determination, such special determination being then deemed to have existed under this determination. If a project requires these, or any classification not listed, please contact IDOL at 618/993-7271 for wage rates or clarifications.

LANDSCAPING

Landscaping work falls under the existing classifications for laborer, operating engineer and truck driver. The work performed by landscape plantsman and landscape laborer is covered by the existing classification of laborer. The work performed by landscape operators (regardless of equipment used or its size) is covered by the classifications of operating engineer. The work performed by landscape truck drivers (regardless of size of truck driven) is covered by the classifications of truck driver.

Monroe County Prevailing Wage for May 2008

Trade Name	RG	TYP	C	Base	FRMAN	*M-F>8	OSA	OSH	H/W	Pensn	Vac	Trng
=====	==	==	=	=====	=====	=====	==	==	=====	=====	=====	=====
ASBESTOS ABT-GEN		ALL		23.450	23.950	1.5	1.5	2.0	5.350	9.000	0.000	0.600
ASBESTOS ABT-MEC		BLD		25.690	26.690	1.5	1.5	2.0	5.050	2.500	0.000	0.250
BOILERMAKER		BLD		30.000	32.500	1.5	1.5	2.0	6.820	11.28	1.000	0.300
BRICK MASON		BLD		27.090	28.840	1.5	1.5	2.0	5.250	8.450	2.000	0.400
CARPENTER		ALL		31.230	32.730	1.5	1.5	2.0	5.300	4.000	0.000	0.350
CEMENT MASON		ALL		27.500	28.250	1.5	1.5	2.0	6.000	9.000	0.000	0.200
CERAMIC TILE FNSHER		BLD		23.370	0.000	1.5	1.5	2.0	5.200	4.400	0.000	0.410
ELECTRIC PWR EQMT OP		ALL		31.510	37.980	1.5	2.0	2.0	4.530	7.880	0.000	0.160
ELECTRIC PWR GRNDMAN		ALL		23.530	37.980	1.5	2.0	2.0	3.380	5.890	0.000	0.120
ELECTRIC PWR LINEMAN		ALL		36.220	37.980	1.5	2.0	2.0	5.210	9.060	0.000	0.180
ELECTRIC PWR TRK DRV		ALL		25.710	37.980	1.5	2.0	2.0	3.700	6.430	0.000	0.130
ELECTRICIAN		ALL		33.740	36.760	1.5	1.5	2.0	5.400	6.750	0.000	0.420
ELECTRONIC SYS TECH		BLD		26.520	28.020	1.5	1.5	2.0	2.800	6.270	0.000	0.250
ELEVATOR CONSTRUCTOR		BLD		38.715	43.550	2.0	2.0	2.0	8.775	6.960	2.320	0.000
FLOOR LAYER		BLD		27.680	28.430	1.5	1.5	2.0	5.300	4.000	0.000	0.350
GLAZIER		BLD		30.140	0.000	2.0	2.0	2.0	8.800	7.520	2.410	0.310
HT/FROST INSULATOR		BLD		31.240	32.240	1.5	1.5	2.0	5.300	8.860	0.000	0.450
IRON WORKER		ALL		27.350	28.850	1.5	1.5	2.0	6.360	9.150	0.000	0.420
LABORER		ALL		22.950	23.450	1.5	1.5	2.0	5.350	9.000	0.000	0.600
MACHINIST		BLD		38.390	40.390	2.0	2.0	2.0	4.880	6.550	2.650	0.000
MARBLE FINISHERS		BLD		23.370	0.000	1.5	1.5	2.0	5.200	4.400	0.000	0.410
MARBLE MASON		BLD		27.090	28.840	1.5	1.5	2.0	5.250	8.450	2.000	0.400
MILLWRIGHT		ALL		31.230	32.730	1.5	1.5	2.0	5.300	4.000	0.000	0.350
OPERATING ENGINEER		ALL	1	27.000	29.000	1.5	1.5	2.0	6.700	12.35	0.000	1.000
OPERATING ENGINEER		ALL	2	25.870	29.000	1.5	1.5	2.0	6.700	12.35	0.000	1.000
OPERATING ENGINEER		ALL	3	21.390	29.000	1.5	1.5	2.0	6.700	12.35	0.000	1.000
OPERATING ENGINEER		ALL	4	21.450	29.000	1.5	1.5	2.0	6.700	12.35	0.000	1.000
OPERATING ENGINEER		ALL	5	21.120	29.000	1.5	1.5	2.0	6.700	12.35	0.000	1.000
OPERATING ENGINEER		ALL	6	27.550	29.000	1.5	1.5	2.0	6.700	12.35	0.000	1.000
OPERATING ENGINEER		ALL	7	27.850	29.000	1.5	1.5	2.0	6.700	12.35	0.000	1.000
OPERATING ENGINEER		ALL	8	28.130	29.000	1.5	1.5	2.0	6.700	12.35	0.000	1.000
PAINTER		BLD		26.700	28.200	1.5	1.5	2.0	4.700	5.570	0.000	0.350
PAINTER		HWY		27.900	29.400	1.5	1.5	2.0	4.700	5.570	0.000	0.350
PAINTER OVER 30FT		BLD		27.700	29.200	1.5	1.5	2.0	4.700	5.570	0.000	0.350
PAINTER PWR EQMT		BLD		27.700	29.200	1.5	1.5	2.0	4.700	5.570	0.000	0.350
PAINTER PWR EQMT		HWY		28.900	30.400	1.5	1.5	2.0	4.700	5.570	0.000	0.350
PILEDRIVER		ALL		31.230	32.730	1.5	1.5	2.0	5.300	4.000	0.000	0.350
PIPEFITTER		BLD		30.000	32.000	1.5	1.5	2.0	5.940	7.000	0.000	0.350
PLASTERER		BLD		27.900	28.900	1.5	1.5	2.0	6.000	7.750	0.000	0.250
PLUMBER		BLD		31.700	34.200	1.5	1.5	2.0	5.200	5.450	0.000	0.300
ROOFER		BLD		26.750	28.750	1.5	1.5	2.0	6.100	5.900	0.000	0.200
SHEETMETAL WORKER		ALL		28.080	29.580	1.5	1.5	2.0	6.350	5.650	1.690	0.260
SPRINKLER FITTER		BLD		35.230	37.730	2.0	2.0	2.0	6.650	8.100	0.000	0.650
TERRAZZO FINISHER		BLD		31.240	0.000	1.5	1.5	2.0	0.000	0.000	0.000	0.000
TERRAZZO MASON		BLD		31.530	31.830	1.5	1.5	2.0	0.000	4.250	0.000	0.070
TRUCK DRIVER		ALL	1	27.580	0.000	1.5	1.5	2.0	8.600	3.925	0.000	0.000
TRUCK DRIVER		ALL	2	27.980	0.000	1.5	1.5	2.0	8.600	3.925	0.000	0.000
TRUCK DRIVER		ALL	3	28.180	0.000	1.5	1.5	2.0	8.600	3.925	0.000	0.000
TRUCK DRIVER		ALL	4	28.430	0.000	1.5	1.5	2.0	8.600	3.925	0.000	0.000
TRUCK DRIVER		ALL	5	29.180	0.000	1.5	1.5	2.0	8.600	3.925	0.000	0.000
TRUCK DRIVER		O&C	1	22.060	0.000	1.5	1.5	2.0	8.600	3.925	0.000	0.000
TRUCK DRIVER		O&C	2	22.380	0.000	1.5	1.5	2.0	8.600	3.925	0.000	0.000
TRUCK DRIVER		O&C	3	22.540	0.000	1.5	1.5	2.0	8.600	3.925	0.000	0.000
TRUCK DRIVER		O&C	4	22.740	0.000	1.5	1.5	2.0	8.600	3.925	0.000	0.000
TRUCK DRIVER		O&C	5	23.340	0.000	1.5	1.5	2.0	8.600	3.925	0.000	0.000

Legend:

M-F>8 (Overtime is required for any hour greater than 8 worked each day, Monday through Friday.)

OSA (Overtime is required for every hour worked on Saturday)

OSH (Overtime is required for every hour worked on Sunday and Holidays)

H/W (Health & Welfare Insurance)

Pensn (Pension)

Vac (Vacation)

Trng (Training)

Explanations

MONROE COUNTY

The following list is considered as those days for which holiday rates of wages for work performed apply: New Years Day, Memorial/Decoration Day, Fourth of July, Labor Day, Veterans Day, Thanksgiving Day, Christmas Day. Generally, any of these holidays which fall on a Sunday is celebrated on the following Monday. This then makes work performed on that Monday payable at the appropriate overtime rate for holiday pay. Common practice in a given local may alter certain days of celebration such as the day after Thanksgiving for Veterans Day. If in doubt, please check with IDOL.

Oil and chip resealing (O&C) means the application of road oils and liquid asphalt to coat an existing road surface, followed by application of aggregate chips or gravel to coated surface, and subsequent rolling of material to seal the surface.

EXPLANATION OF CLASSES

ASBESTOS - GENERAL - removal of asbestos material/mold and hazardous materials from any place in a building, including mechanical systems where those mechanical systems are to be removed. This includes the removal of asbestos materials/mold and hazardous materials from ductwork or pipes in a building when the building is to be demolished at the time or at some close future date.

ASBESTOS - MECHANICAL - removal of asbestos material from mechanical systems, such as pipes, ducts, and boilers, where the mechanical systems are to remain.

CERAMIC TILE FINISHER AND MARBLE FINISHER

The handling, at the building site, of all sand, cement, tile, marble or stone and all other materials that may be used and installed by [a] tile layer or marble mason. In addition, the grouting, cleaning, sealing, and mixing on the job site, and all other work as required in assisting the setter. The term "Ceramic" is used for naming the classification only and is in no way a limitation of the product handled. Ceramic takes into consideration most hard tiles.

ELECTRONIC SYSTEMS TECHNICIAN

Installation, service and maintenance of low-voltage systems which utilizes the transmission and/or transference of voice, sound, vision, or digital for commercial, education, security and entertainment purposes for the following: TV monitoring and surveillance, background/foreground music, intercom and telephone interconnect, field programming, inventory control systems, microwave transmission, multi-media, multiplex, radio page, school, intercom and sound burglar alarms and low voltage master clock systems.

Excluded from this classification are energy management systems, life safety systems, supervisory controls and data acquisition systems not intrinsic with the above listed systems, fire alarm systems, nurse call systems and raceways exceeding fifteen feet in length.

TRUCK DRIVER - BUILDING, HEAVY AND HIGHWAY CONSTRUCTION

Class 1. Drivers on 2 axle trucks hauling less than 9 ton. Air compressor and welding machines and brooms, including those pulled by separate units, truck driver helpers, warehouse employees, mechanic helpers, greasers and tiremen, pickup trucks when hauling materials, tools, or workers to and from and on-the-job site, and fork lifts up to 6,000 lb. capacity.

Class 2. Two or three axle trucks hauling more than 9 ton but hauling less than 16 ton. A-frame winch trucks, hydrolift trucks, vector trucks or similar equipment when used for transportation purposes. Fork lifts over 6,000 lb. capacity, winch trucks, four axle combination units, and ticket writers.

Class 3. Two, three or four axle trucks hauling 16 ton or more. Drivers on water pulls, articulated dump trucks, mechanics and working forepersons, and dispatchers. Five axle or more combination units.

Class 4. Low Boy and Oil Distributors.

Class 5. Drivers who require special protective clothing while employed on hazardous waste work.

TRUCK DRIVER - OIL AND CHIP RESEALING ONLY.

This shall encompass laborers, workers and mechanics who drive contractor or subcontractor owned, leased, or hired pickup, dump, service, or oil distributor trucks. The work includes transporting materials and equipment (including but not limited to, oils, aggregate supplies, parts, machinery and tools) to or from the job site; distributing oil or liquid asphalt and aggregate; stock piling material when in connection with the actual oil and chip contract. The Truck Driver (Oil & Chip Resealing) wage classification does not include supplier delivered materials.

OPERATING ENGINEERS

GROUP I. Cranes, Dragline, Shovels, Skimmer Scoops, Clamshells or Derrick Boats, Pile Drivers, Crane-Type Backhoes, Asphalt Plant Operators, Concrete Plant Operators, Dredges, Asphalt Spreading Machines, All Locomotives, Cable Ways, or Tower Machines, Hoists, Hydraulic Backhoes, Ditching Machines or Backfiller, Cherrypickers, Overhead Cranes, Roller, Steam or Gas, Concrete Pavers, Excavators, Concrete Breakers, Concrete Pumps, Bulk Cement Plants, Cement Pumps, Derrick-Type Drills, Boat Operators, Motor Graders or Pushcats, Scoops or Tournapulls, Bulldozers, Endloaders or Fork Lifts, Power Blade or Elevating Graders, Winch Cats, Boom or Winch Trucks or Boom Tractors,

Pipe Wrapping or Painting Machines, Asphalt Plant Engineer, Journeyman Lubricating Engineer, Drills (other than Derrick Type), Mud Jacks, or Well Drilling Machines, Boring Machines or Track Jacks, Mixers, Conveyors (Two), Air Compressors (Two), Water Pumps regardless of size (Two), Welding Machines (Two), Siphons or Jets (Two), Winch Heads or Apparatuses (Two), Light Plants (Two), Waterblasters (two), All Tractors regardless of size (straight tractor only), Fireman on Stationary Boilers, Automatic Elevators, Form Grading Machines, Finishing Machines, Power Sub-Grader or Ribbon Machines, Longitudinal Floats, Distributor Operators on Trucks, Winch Heads or Apparatuses (One), Mobil Track air and heaters (two to five), Heavy Equipment Greaser, Relief Operator, Assistant Master Mechanic and Heavy Duty Mechanic, all Operators (except those listed below).

GROUP II. Assistant Operators.

GROUP III. Air Compressors (One), Water Pumps, regardless of Size (One), Waterblasters (one), Welding Machine (One), Mixers (One Bag), Conveyor (One), Siphon or Jet (One), Light Plant (One), Heater (One), Immobile Track Air (One), and Self Propelled Walk-Behind Rollers.

GROUP IV. Asphalt Spreader Oilers, Fireman on Whirlies and Heavy Equipment Oilers, Truck Cranes, Dredges, Monigans, Large Cranes - (Over 65-ton rated capacity) Concrete Plant Oiler, Blacktop Plant Oiler, and Creter Crane Oiler (when required). GROUP V. Oiler.

GROUP VI. Master Mechanics, Operators on equipment with Booms, including jibs, 100 feet and over, and less than 150 feet long.

GROUP VII. Operators on equipment with Booms, including jibs, 150 feet and over, and less than 200 feet long.

GROUP VIII. Operators on Equipment with Booms, including jibs, 200 feet and over; Tower Cranes; Whirlie Cranes; and Operator Foreman.

TERRAZZO FINISHER

The handling of all materials used for Mosaic and Terrazzo work including preparing, mixing by hand, by mixing machine or transporting of pre-mixed materials and distributing with shovel, rake, hoe, or pail, all kinds of concrete foundations necessary for Mosaic and Terrazzo work, all cement terrazzo, magnesite terrazzo, Do-O-Tex terrazzo, epoxy matrix ter-razzo, exposed aggregate, rustic or rough washed for exterior or interior of buildings placed either by machine or by hand, and any other kind of mixture of plastics composed of chips or granules when mixed with cement, rubber, neoprene, vinyl, magnesium chloride or any other resinous or chemical substances used for seamless flooring systems, and all other building materials, all similar materials and all precast terrazzo work on jobs, all scratch coat used for Mosaic and Terrazzo work and sub-bed, tar paper and wire mesh (2x2 etc.) or lath. The rubbing, grinding, cleaning and finishing of same either by hand or by machine or by terrazzo resurfacing equipment on new or existing floors. When necessary finishers shall be allowed to assist the mechanics to spread sand bed, lay tarpaper and wire mesh (2x2 etc.) or lath. The finishing of cement floors where additional aggregate of stone is added by spreading or sprinkling on top of the finished base, and troweled or rolled into the finish and then the surface is ground by grinding machines.

Other Classifications of Work:

For definitions of classifications not otherwise set out, the Department generally has on file such definitions which are available. If a task to be performed is not subject to one of the classifications of pay set out, the Department will upon being contacted state which neighboring county has such a classification and provide such rate, such rate being deemed to exist by reference in this document. If no neighboring county rate applies to the task, the Department shall undertake a special determination, such special determination being then deemed to have existed under this determination. If a project requires these, or any classification not listed, please contact IDOL at 618/993-7271 for wage rates or clarifications.

LANDSCAPING

Landscaping work falls under the existing classifications for laborer, operating engineer and truck driver. The work performed by landscape plantsman and landscape laborer is covered by the existing classification of laborer. The work performed by landscape operators (regardless of equipment used or its size) is covered by the classifications of operating engineer. The work performed by landscape truck drivers (regardless of size of truck driven) is covered by the classifications of truck driver.

Randolph County Prevailing Wage for May 2008

Trade Name	RG	TYP	C	Base	FRMAN	*M-F>8	OSA	OSH	H/W	Pensn	Vac	Trng
=====	==	==	=	=====	=====	=====	==	==	=====	=====	=====	=====
ASBESTOS ABT-GEN		ALL		23.850	24.350	1.5	1.5	2.0	5.350	8.600	0.000	0.600
ASBESTOS ABT-MEC		BLD		25.690	26.690	1.5	1.5	2.0	5.050	2.500	0.000	0.250
BOILERMAKER		BLD		30.000	32.500	1.5	1.5	2.0	6.820	11.28	1.000	0.300
BRICK MASON		BLD		26.010	27.510	1.5	1.5	2.0	6.400	5.700	0.000	0.430
CARPENTER		ALL		31.230	32.730	1.5	1.5	2.0	5.300	4.000	0.000	0.350
CEMENT MASON		BLD		24.000	25.000	1.5	1.5	2.0	5.300	4.050	0.000	0.200
CEMENT MASON		HWY		23.750	24.750	1.5	1.5	2.0	5.300	3.700	0.000	0.300
CERAMIC TILE FNSHER		BLD		24.990	0.000	1.5	1.5	2.0	6.400	5.700	0.000	0.430
ELECTRIC PWR EQMT OP		ALL		31.510	37.980	1.5	2.0	2.0	4.530	7.880	0.000	0.160
ELECTRIC PWR GRNDMAN		ALL		23.530	37.980	1.5	2.0	2.0	3.380	5.890	0.000	0.120
ELECTRIC PWR LINEMAN		ALL		36.220	37.980	1.5	2.0	2.0	5.210	9.060	0.000	0.180
ELECTRIC PWR TRK DRV		ALL		25.710	37.980	1.5	2.0	2.0	3.700	6.430	0.000	0.130
ELECTRICIAN	NW	ALL		33.740	36.760	1.5	1.5	2.0	5.400	6.750	0.000	0.420
ELECTRICIAN	SE	ALL		33.680	35.930	1.5	1.5	2.0	5.150	7.070	0.000	0.500
ELECTRONIC SYS TECH	NW	BLD		26.520	28.020	1.5	1.5	2.0	2.800	6.270	0.000	0.250
ELECTRONIC SYS TECH	SE	BLD		26.740	28.240	1.5	1.5	2.0	5.150	3.470	0.000	0.250
ELEVATOR CONSTRUCTOR		BLD		38.715	43.550	2.0	2.0	2.0	8.775	6.960	2.320	0.000
FLOOR LAYER		BLD		27.680	28.430	1.5	1.5	2.0	5.300	4.000	0.000	0.350
GLAZIER		BLD		30.140	0.000	2.0	2.0	2.0	8.800	7.520	2.410	0.310
HT/FROST INSULATOR		BLD		31.240	32.240	1.5	1.5	2.0	5.300	8.860	0.000	0.450
IRON WORKER		ALL		27.350	28.850	1.5	1.5	2.0	6.360	9.150	0.000	0.420
LABORER		ALL		23.350	23.850	1.5	1.5	2.0	5.350	8.600	0.000	0.600
MACHINIST		BLD		38.390	40.390	2.0	2.0	2.0	4.880	6.550	2.650	0.000
MARBLE FINISHERS		BLD		24.990	0.000	1.5	1.5	2.0	6.000	5.400	0.000	0.425
MARBLE MASON		BLD		26.010	27.510	1.5	1.5	2.0	6.400	5.700	0.000	0.430
MILLWRIGHT		ALL		31.230	32.730	1.5	1.5	2.0	5.300	4.000	0.000	0.350
OPERATING ENGINEER		ALL	1	27.000	29.000	1.5	1.5	2.0	6.700	12.35	0.000	1.000
OPERATING ENGINEER		ALL	2	25.870	29.000	1.5	1.5	2.0	6.700	12.35	0.000	1.000
OPERATING ENGINEER		ALL	3	21.390	29.000	1.5	1.5	2.0	6.700	12.35	0.000	1.000
OPERATING ENGINEER		ALL	4	21.450	29.000	1.5	1.5	2.0	6.700	12.35	0.000	1.000
OPERATING ENGINEER		ALL	5	21.120	29.000	1.5	1.5	2.0	6.700	12.35	0.000	1.000
OPERATING ENGINEER		ALL	6	27.550	29.000	1.5	1.5	2.0	6.700	12.35	0.000	1.000
OPERATING ENGINEER		ALL	7	27.850	29.000	1.5	1.5	2.0	6.700	12.35	0.000	1.000
OPERATING ENGINEER		ALL	8	28.130	29.000	1.5	1.5	2.0	6.700	12.35	0.000	1.000
PAINTER		BLD		23.810	25.310	1.5	1.5	2.0	5.480	4.900	0.000	0.250
PAINTER		HWY		28.110	29.610	1.5	1.5	2.0	5.480	4.900	0.000	0.250
PAINTER OVER 30FT		BLD		24.810	26.310	1.5	1.5	2.0	5.480	4.900	0.000	0.250
PAINTER PWR EQMT		BLD		24.810	26.310	1.5	1.5	2.0	5.480	4.900	0.000	0.250
PAINTER PWR EQMT		HWY		29.110	30.610	1.5	1.5	2.0	5.480	4.900	0.000	0.250
PILEDRIVER		ALL		31.230	32.730	1.5	1.5	2.0	5.300	4.000	0.000	0.350
PIPEFITTER	N	BLD		31.700	34.200	1.5	1.5	2.0	6.400	4.100	0.000	0.525
PIPEFITTER	SE	BLD		31.670	34.840	1.5	2.0	2.0	6.700	5.030	0.000	1.000
PIPEFITTER	W	BLD		30.000	32.000	1.5	1.5	2.0	5.940	7.000	0.000	0.350
PLASTERER		BLD		23.500	24.500	1.5	1.5	2.0	5.200	3.550	0.000	0.100
PLUMBER	N	BLD		31.700	34.200	1.5	1.5	2.0	6.400	4.100	0.000	0.525
PLUMBER	SE	BLD		31.670	34.840	1.5	2.0	2.0	6.700	5.030	0.000	1.000
PLUMBER	W	BLD		31.700	34.200	1.5	1.5	2.0	5.200	5.450	0.000	0.300
ROOFER		BLD		26.750	28.750	1.5	1.5	2.0	6.100	5.900	0.000	0.200
SHEETMETAL WORKER		ALL		28.080	29.580	1.5	1.5	2.0	6.350	5.650	1.690	0.260
SPRINKLER FITTER		BLD		35.230	37.730	2.0	2.0	2.0	6.650	8.100	0.000	0.650
STONE MASON		BLD		26.010	27.510	1.5	1.5	2.0	6.400	5.700	0.000	0.430
TERRAZZO FINISHER		BLD		24.990	0.000	1.5	1.5	2.0	6.000	5.400	0.000	0.425
TERRAZZO MASON		BLD		28.500	28.800	1.5	1.5	2.0	6.400	5.700	0.000	0.430
TRUCK DRIVER		ALL	1	27.580	0.000	1.5	1.5	2.0	8.600	3.925	0.000	0.000
TRUCK DRIVER		ALL	2	27.980	0.000	1.5	1.5	2.0	8.600	3.925	0.000	0.000
TRUCK DRIVER		ALL	3	28.180	0.000	1.5	1.5	2.0	8.600	3.925	0.000	0.000
TRUCK DRIVER		ALL	4	28.430	0.000	1.5	1.5	2.0	8.600	3.925	0.000	0.000
TRUCK DRIVER		ALL	5	29.180	0.000	1.5	1.5	2.0	8.600	3.925	0.000	0.000

TRUCK DRIVER	O&C 1	22.060	0.000	1.5	1.5	2.0	8.600	3.925	0.000	0.000
TRUCK DRIVER	O&C 2	22.380	0.000	1.5	1.5	2.0	8.600	3.925	0.000	0.000
TRUCK DRIVER	O&C 3	22.540	0.000	1.5	1.5	2.0	8.600	3.925	0.000	0.000
TRUCK DRIVER	O&C 4	22.740	0.000	1.5	1.5	2.0	8.600	3.925	0.000	0.000
TRUCK DRIVER	O&C 5	23.340	0.000	1.5	1.5	2.0	8.600	3.925	0.000	0.000
TUCKPOINTER	BLD	26.010	27.510	1.5	1.5	2.0	6.400	5.700	0.000	0.430

Legend:

M-F>8 (Overtime is required for any hour greater than 8 worked each day, Monday through Friday.)

OSA (Overtime is required for every hour worked on Saturday)

OSH (Overtime is required for every hour worked on Sunday and Holidays)

H/W (Health & Welfare Insurance)

Pensn (Pension)

Vac (Vacation)

Trng (Training)

Explanations

RANDOLPH COUNTY

ELECTRICIANS AND ELECTRONIC SYSTEMS TECHNICIAN (NORTHWEST) - Township of Red Bud.

PLUMBERS & PIPEFITTERS (NORTH) - Towns of Red Bud, Prairie, and Ruma.

PLUMBERS & PIPEFITTERS (SOUTHEAST) - That part of the county East of a line between Ste. Genevieve, Mo. and Rt. 155 then south of a diagonal line to the North-East corner of the county.

PLUMBERS & PIPEFITTERS (WEST) - Towns of Roots, Kellog, Modoc and Prairie DuRocher.

The following list is considered as those days for which holiday rates of wages for work performed apply: New Years Day, Memorial/Decoration Day, Fourth of July, Labor Day, Veterans Day, Thanksgiving Day, Christmas Day. Generally, any of these holidays which fall on a Sunday is celebrated on the following Monday. This then makes work performed on that Monday payable at the appropriate overtime rate for holiday pay. Common practice in a given local may alter certain days of celebration such as the day after Thanksgiving for Veterans Day. If in doubt, please check with IDOL.

Oil and chip resealing (O&C) means the application of road oils and liquid asphalt to coat an existing road surface, followed by application of aggregate chips or gravel to coated surface, and subsequent rolling of material to seal the surface.

EXPLANATION OF CLASSES

ASBESTOS - GENERAL - removal of asbestos material/mold and hazardous materials from any place in a building, including mechanical systems where those mechanical systems are to be removed. This includes the

removal of asbestos materials/mold and hazardous materials from ductwork or pipes in a building when the building is to be demolished at the time or at some close future date.

ASBESTOS - MECHANICAL - removal of asbestos material from mechanical systems, such as pipes, ducts, and boilers, where the mechanical systems are to remain.

CERAMIC TILE FINISHER, MARBLE FINISHER, TERRAZZO FINISHER

Assisting, helping or supporting the tile, marble and terrazzo mechanic by performing their historic and traditional work assignments required to complete the proper installation of the work covered by said crafts. The term "Ceramic" is used for naming the classification only, and is in no a limitation of the product handled. Ceramic takes into consideration most hard tiles.

ELECTRONIC SYSTEMS TECHNICIAN

Installation, service and maintenance of low-voltage systems which utilizes the transmission and/or transference of voice, sound, vision, or digital for commercial, education, security and entertainment purposes for the following: TV monitoring and surveillance, background/foreground music, intercom and telephone interconnect, field programming, inventory control systems, microwave transmission, multi-media, multiplex, radio page, school, intercom and sound burglar alarms and low voltage master clock systems.

Excluded from this classification are energy management systems, life safety systems, supervisory controls and data acquisition systems not intrinsic with the above listed systems, fire alarm systems, nurse call systems and raceways exceeding fifteen feet in length.

TRUCK DRIVER - BUILDING, HEAVY AND HIGHWAY CONSTRUCTION

Class 1. Drivers on 2 axle trucks hauling less than 9 ton. Air compressor and welding machines and brooms, including those pulled by separate units, truck driver helpers, warehouse employees, mechanic helpers, greasers and tiremen, pickup trucks when hauling materials, tools, or workers to and from and on-the-job site, and fork lifts up to 6,000 lb. capacity.

Class 2. Two or three axle trucks hauling more than 9 ton but hauling less than 16 ton. A-frame winch trucks, hydrolift trucks, vactor trucks or similar equipment when used for transportation purposes. Fork lifts over 6,000 lb. capacity, winch trucks, four axle combination units, and ticket writers.

Class 3. Two, three or four axle trucks hauling 16 ton or more. Drivers on water pulls, articulated dump trucks, mechanics and working forepersons, and dispatchers. Five axle or more combination units.

Class 4. Low Boy and Oil Distributors.

Class 5. Drivers who require special protective clothing while employed on hazardous waste work.

TRUCK DRIVER - OIL AND CHIP RESEALING ONLY.

This shall encompass laborers, workers and mechanics who drive contractor or subcontractor owned, leased, or hired pickup, dump, service, or oil distributor trucks. The work includes transporting materials and equipment (including but not limited to, oils, aggregate supplies, parts, machinery and tools) to or from the job site; distributing oil or liquid asphalt and aggregate; stock piling

material when in connection with the actual oil and chip contract. The Truck Driver (Oil & Chip Resealing) wage classification does not include supplier delivered materials.

OPERATING ENGINEERS

GROUP I. Cranes, Dragline, Shovels, Skimmer Scoops, Clamshells or Derrick Boats, Pile Drivers, Crane-Type Backhoes, Asphalt Plant Operators, Concrete Plant Operators, Dredges, Asphalt Spreading Machines, All Locomotives, Cable Ways, or Tower Machines, Hoists, Hydraulic Backhoes, Ditching Machines or Backfiller, Cherrypickers, Overhead Cranes, Roller, Steam or Gas, Concrete Pavers, Excavators, Concrete Breakers, Concrete Pumps, Bulk Cement Plants, Cement Pumps, Derrick-Type Drills, Boat Operators, Motor Graders or Pushcats, Scoops or Tournapulls, Bulldozers, Endloaders or Fork Lifts, Power Blade or Elevating Graders, Winch Cats, Boom or Winch Trucks or Boom Tractors, Pipe Wrapping or Painting Machines, Asphalt Plant Engineer, Journeyman Lubricating Engineer, Drills (other than Derrick Type), Mud Jacks, or Well Drilling Machines, Boring Machines or Track Jacks, Mixers, Conveyors (Two), Air Compressors (Two), Water Pumps regardless of size (Two), Welding Machines (Two), Siphons or Jets (Two), Winch Heads or Apparatuses (Two), Light Plants (Two), Waterblasters (two), All Tractors regardless of size (straight tractor only), Fireman on Stationary Boilers, Automatic Elevators, Form Grading Machines, Finishing Machines, Power Sub-Grader or Ribbon Machines, Longitudinal Floats, Distributor Operators on Trucks, Winch Heads or Apparatuses (One), Mobil Track air and heaters (two to five), Heavy Equipment Greaser, Relief Operator, Assistant Master Mechanic and Heavy Duty Mechanic, all Operators (except those listed below).

GROUP II. Assistant Operators.

GROUP III. Air Compressors (One), Water Pumps, regardless of Size (One), Waterblasters (one), Welding Machine (One), Mixers (One Bag), Conveyor (One), Siphon or Jet (One), Light Plant (One), Heater (One), Immobile Track Air (One), and Self Propelled Walk-Behind Rollers.

GROUP IV. Asphalt Spreader Oilers, Fireman on Whirlies and Heavy Equipment Oilers, Truck Cranes, Dredges, Monigans, Large Cranes - (Over 65-ton rated capacity) Concrete Plant Oiler, Blacktop Plant Oiler, and Creter Crane Oiler (when required).

GROUP V. Oiler.

GROUP VI. Master Mechanics, Operators on equipment with Booms, including jibs, 100 feet and over, and less than 150 feet long.

GROUP VII. Operators on equipment with Booms, including jibs, 150 feet and over, and less than 200 feet long.

GROUP VIII. Operators on Equipment with Booms, including jibs, 200 feet and over; Tower Cranes; Whirlie Cranes; and Operator Foreman.

Other Classifications of Work:

For definitions of classifications not otherwise set out, the Department generally has on file such definitions which are available. If a task to be performed is not subject to one of the classifications of pay set out, the Department will upon being contacted state which neighboring county has such a classification and provide such rate, such rate being deemed to exist by reference in this document. If no neighboring county rate applies to the task, the Department shall undertake a special determination, such special

determination being then deemed to have existed under this determination. If a project requires these, or any classification not listed, please contact IDOL at 618/993-7271 for wage rates or clarifications.

LANDSCAPING

Landscaping work falls under the existing classifications for laborer, operating engineer and truck driver. The work performed by landscape plantsman and landscape laborer is covered by the existing classification of laborer. The work performed by landscape operators (regardless of equipment used or its size) is covered by the classifications of operating engineer. The work performed by landscape truck drivers (regardless of size of truck driven) is covered by the classifications of truck driver.

Saint Clair County Prevailing Wage for May 2008

Trade Name	RG	TYP	C	Base	FRMAN	*M-F>8	OSA	OSH	H/W	Pensn	Vac	Trng
=====	==	==	=	=====	=====	=====	==	==	=====	=====	=====	=====
ASBESTOS ABT-GEN		BLD		25.550	26.050	1.5	1.5	2.0	5.350	7.100	0.000	0.600
ASBESTOS ABT-MEC		BLD		25.690	26.690	1.5	1.5	2.0	5.050	2.500	0.000	0.250
BOILERMAKER		BLD		30.000	32.500	1.5	1.5	2.0	6.820	11.28	1.000	0.300
BRICK MASON		BLD		27.090	28.840	1.5	1.5	2.0	5.250	8.450	2.000	0.400
CARPENTER		ALL		31.230	32.730	1.5	1.5	2.0	5.300	4.000	0.000	0.350
CEMENT MASON		ALL		27.500	28.250	1.5	1.5	2.0	6.000	9.000	0.000	0.200
CERAMIC TILE FNSHER		BLD		23.370	0.000	1.5	1.5	2.0	5.200	4.400	0.000	0.410
ELECTRIC PWR EQMT OP		ALL		31.510	37.980	1.5	2.0	2.0	4.530	7.880	0.000	0.160
ELECTRIC PWR GRNDMAN		ALL		23.530	37.980	1.5	2.0	2.0	3.380	5.890	0.000	0.120
ELECTRIC PWR LINEMAN		ALL		36.220	37.980	1.5	2.0	2.0	5.210	9.060	0.000	0.180
ELECTRIC PWR TRK DRV		ALL		25.710	37.980	1.5	2.0	2.0	3.700	6.430	0.000	0.130
ELECTRICIAN		ALL		33.740	36.760	1.5	1.5	2.0	5.400	6.750	0.000	0.420
ELECTRONIC SYS TECH		BLD		26.520	28.020	1.5	1.5	2.0	2.800	6.270	0.000	0.250
ELEVATOR CONSTRUCTOR		BLD		38.715	43.550	2.0	2.0	2.0	8.775	6.960	2.320	0.000
FLOOR LAYER		BLD		27.680	28.430	1.5	1.5	2.0	5.300	4.000	0.000	0.350
GLAZIER		BLD		30.140	0.000	2.0	2.0	2.0	8.800	7.520	2.410	0.310
HT/FROST INSULATOR		BLD		31.240	32.240	1.5	1.5	2.0	5.300	8.860	0.000	0.450
IRON WORKER		ALL		27.350	28.850	1.5	1.5	2.0	6.360	9.150	0.000	0.420
LABORER	N	ALL		25.050	25.550	1.5	1.5	2.0	5.350	7.100	0.000	0.600
LABORER	S	ALL		23.350	23.850	1.5	1.5	2.0	5.350	8.600	0.000	0.600
MACHINIST		BLD		38.390	40.390	2.0	2.0	2.0	4.880	6.550	2.650	0.000
MARBLE FINISHERS		BLD		23.370	0.000	1.5	1.5	2.0	5.200	4.400	0.000	0.410
MARBLE MASON		BLD		27.090	28.840	1.5	1.5	2.0	5.250	8.450	2.000	0.400
MILLWRIGHT		ALL		31.230	32.730	1.5	1.5	2.0	5.300	4.000	0.000	0.350
OPERATING ENGINEER		ALL	1	27.000	29.000	1.5	1.5	2.0	6.700	12.35	0.000	1.000
OPERATING ENGINEER		ALL	2	25.870	29.000	1.5	1.5	2.0	6.700	12.35	0.000	1.000
OPERATING ENGINEER		ALL	3	21.390	29.000	1.5	1.5	2.0	6.700	12.35	0.000	1.000
OPERATING ENGINEER		ALL	4	21.450	29.000	1.5	1.5	2.0	6.700	12.35	0.000	1.000
OPERATING ENGINEER		ALL	5	21.120	29.000	1.5	1.5	2.0	6.700	12.35	0.000	1.000
OPERATING ENGINEER		ALL	6	27.550	29.000	1.5	1.5	2.0	6.700	12.35	0.000	1.000
OPERATING ENGINEER		ALL	7	27.850	29.000	1.5	1.5	2.0	6.700	12.35	0.000	1.000
OPERATING ENGINEER		ALL	8	28.130	29.000	1.5	1.5	2.0	6.700	12.35	0.000	1.000
PAINTER		BLD		26.700	28.200	1.5	1.5	2.0	4.700	5.570	0.000	0.350
PAINTER		HWY		27.900	29.400	1.5	1.5	2.0	4.700	5.570	0.000	0.350
PAINTER OVER 30FT		BLD		27.700	29.200	1.5	1.5	2.0	4.700	5.570	0.000	0.350
PAINTER PWR EQMT		BLD		27.700	29.200	1.5	1.5	2.0	4.700	5.570	0.000	0.350
PAINTER PWR EQMT		HWY		28.900	30.400	1.5	1.5	2.0	4.700	5.570	0.000	0.350
PILEDRIVER		ALL		31.230	32.730	1.5	1.5	2.0	5.300	4.000	0.000	0.350
PIPEFITTER	NW	BLD		30.000	32.000	1.5	1.5	2.0	5.940	7.000	0.000	0.350
PIPEFITTER	SE	BLD		31.700	34.200	1.5	1.5	2.0	6.400	4.100	0.000	0.525
PLASTERER		BLD		27.900	28.900	1.5	1.5	2.0	6.000	7.750	0.000	0.250
PLUMBER	NW	BLD		31.700	34.200	1.5	1.5	2.0	5.200	5.450	0.000	0.300
PLUMBER	SE	BLD		31.700	34.200	1.5	1.5	2.0	6.400	4.100	0.000	0.525
ROOFER		BLD		26.750	28.750	1.5	1.5	2.0	6.100	5.900	0.000	0.200
SHEETMETAL WORKER		ALL		28.080	29.580	1.5	1.5	2.0	6.350	5.650	1.690	0.260
SPRINKLER FITTER		BLD		35.230	37.730	2.0	2.0	2.0	6.650	8.100	0.000	0.650
TERRAZZO FINISHER		BLD		31.240	0.000	1.5	1.5	2.0	0.000	0.000	0.000	0.000
TERRAZZO MASON		BLD		31.530	31.830	1.5	1.5	2.0	0.000	4.250	0.000	0.070
TRUCK DRIVER		ALL	1	27.580	0.000	1.5	1.5	2.0	8.600	3.925	0.000	0.000
TRUCK DRIVER		ALL	2	27.980	0.000	1.5	1.5	2.0	8.600	3.925	0.000	0.000
TRUCK DRIVER		ALL	3	28.180	0.000	1.5	1.5	2.0	8.600	3.925	0.000	0.000
TRUCK DRIVER		ALL	4	28.430	0.000	1.5	1.5	2.0	8.600	3.925	0.000	0.000
TRUCK DRIVER		ALL	5	29.180	0.000	1.5	1.5	2.0	8.600	3.925	0.000	0.000
TRUCK DRIVER		O&C	1	22.060	0.000	1.5	1.5	2.0	8.600	3.925	0.000	0.000
TRUCK DRIVER		O&C	2	22.380	0.000	1.5	1.5	2.0	8.600	3.925	0.000	0.000
TRUCK DRIVER		O&C	3	22.540	0.000	1.5	1.5	2.0	8.600	3.925	0.000	0.000
TRUCK DRIVER		O&C	4	22.740	0.000	1.5	1.5	2.0	8.600	3.925	0.000	0.000
TRUCK DRIVER		O&C	5	23.340	0.000	1.5	1.5	2.0	8.600	3.925	0.000	0.000

Legend :

M-F>8 (Overtime is required for any hour greater than 8 worked each day, Monday through Friday.)

OSA (Overtime is required for every hour worked on Saturday)

OSH (Overtime is required for every hour worked on Sunday and Holidays)

H/W (Health & Welfare Insurance)

Pensn (Pension)

Vac (Vacation)

Trng (Training)

Explanations

ST. CLAIR COUNTY

LABORERS (NORTH) - The area bounded by Route 159 to a point south of Fairview Heights and west-southwest to Route 3 at Monroe County line.

PLUMBERS & PIPEFITTERS (SOUTHEAST) - That part of the county bordered by Rt. 50 on the North and West including Belleville.

PLUMBERS (NORTHWEST) - Towns of Aloraton, Brooklyn, Cahokia, Caseyville, Centreville, Dupo, East Carondelet, E. St. Louis, Fairview Heights, French Village, National City, O'Fallon, Sauget, and Washington Park.

The following list is considered as those days for which holiday rates of wages for work performed apply: New Years Day, Memorial/Decoration Day, Fourth of July, Labor Day, Veterans Day, Thanksgiving Day, Christmas Day. Generally, any of these holidays which fall on a Sunday is celebrated on the following Monday. This then makes work performed on that Monday payable at the appropriate overtime rate for holiday pay. Common practice in a given local may alter certain days of celebration such as the day after Thanksgiving for Veterans Day. If in doubt, please check with IDOL.

Oil and chip resealing (O&C) means the application of road oils and liquid asphalt to coat an existing road surface, followed by application of aggregate chips or gravel to coated surface, and subsequent rolling of material to seal the surface.

EXPLANATION OF CLASSES

ASBESTOS - GENERAL - removal of asbestos material/mold and hazardous materials from any place in a building, including mechanical systems where those mechanical systems are to be removed. This includes the removal of asbestos materials/mold and hazardous materials from ductwork or pipes in a building when the building is to be demolished at the time or at some close future date.

ASBESTOS - MECHANICAL - removal of asbestos material from mechanical systems, such as pipes, ducts, and boilers, where the mechanical systems are to remain.

CERAMIC TILE FINISHER AND MARBLE FINISHER

The handling, at the building site, of all sand, cement, tile, marble or stone and all other materials that may be used and installed by [a] tile layer or marble mason. In addition, the grouting, cleaning, sealing, and mixing on the job site, and all other work as required in assisting the setter. The term "Ceramic" is used for naming the classification only and is in no way a limitation of the product handled. Ceramic takes into consideration most hard tiles.

ELECTRONIC SYSTEMS TECHNICIAN

Installation, service and maintenance of low-voltage systems which utilizes the transmission and/or transference of voice, sound, vision, or digital for commercial, education, security and entertainment purposes for the following: TV monitoring and surveillance, background/foreground music, intercom and telephone interconnect, field programming, inventory control systems, microwave transmission, multi-media, multiplex, radio page, school, intercom and sound burglar alarms and low voltage master clock systems.

Excluded from this classification are energy management systems, life safety systems, supervisory controls and data acquisition systems not intrinsic with the above listed systems, fire alarm systems, nurse call systems and raceways exceeding fifteen feet in length.

TRUCK DRIVER - BUILDING, HEAVY AND HIGHWAY CONSTRUCTION

Class 1. Drivers on 2 axle trucks hauling less than 9 ton. Air compressor and welding machines and brooms, including those pulled by separate units, truck driver helpers, warehouse employees, mechanic helpers, greasers and tiremen, pickup trucks when hauling materials, tools, or workers to and from and on-the-job site, and fork lifts up to 6,000 lb. capacity.

Class 2. Two or three axle trucks hauling more than 9 ton but hauling less than 16 ton. A-frame winch trucks, hydrolift trucks, vector trucks or similar equipment when used for transportation purposes. Fork lifts over 6,000 lb. capacity, winch trucks, four axle combination units, and ticket writers.

Class 3. Two, three or four axle trucks hauling 16 ton or more. Drivers on water pulls, articulated dump trucks, mechanics and working forepersons, and dispatchers. Five axle or more combination units.

Class 4. Low Boy and Oil Distributors.

Class 5. Drivers who require special protective clothing while employed on hazardous waste work.

TRUCK DRIVER - OIL AND CHIP RESEALING ONLY.

This shall encompass laborers, workers and mechanics who drive contractor or subcontractor owned, leased, or hired pickup, dump, service, or oil distributor trucks. The work includes transporting materials and equipment (including but not limited to, oils, aggregate supplies, parts, machinery and tools) to or from the job site; distributing oil or liquid asphalt and aggregate; stock piling material when in connection with the actual oil and chip contract. The Truck Driver (Oil & Chip Resealing) wage classification does not include supplier delivered materials.

OPERATING ENGINEERS

GROUP I. Cranes, Dragline, Shovels, Skimmer Scoops, Clamshells or Derrick Boats, Pile Drivers, Crane-Type Backhoes, Asphalt Plant Operators, Concrete Plant Operators, Dredges, Asphalt Spreading Machines, All Locomotives, Cable Ways, or Tower Machines, Hoists, Hydraulic Backhoes, Ditching Machines or Backfiller, Cherrypickers, Overhead Cranes, Roller, Steam or Gas, Concrete Pavers, Excavators, Concrete Breakers, Concrete Pumps, Bulk Cement Plants, Cement Pumps, Derrick-Type Drills, Boat Operators, Motor Graders or Pushcats, Scoops or Tournapulls, Bulldozers, Endloaders or Fork Lifts, Power Blade or Elevating Graders, Winch Cats, Boom or Winch Trucks or Boom Tractors, Pipe Wrapping or Painting Machines, Asphalt Plant Engineer, Journeyman Lubricating Engineer, Drills (other than Derrick Type), Mud Jacks, or Well Drilling Machines, Boring Machines or Track Jacks, Mixers, Conveyors (Two), Air Compressors (Two), Water Pumps regardless of size (Two), Welding Machines (Two), Siphons or Jets (Two), Winch Heads or Apparatuses (Two), Light Plants (Two), Waterblasters (two), All Tractors regardless of size (straight tractor only), Fireman on Stationary Boilers, Automatic Elevators, Form Grading Machines, Finishing Machines, Power Sub-Grader or Ribbon Machines, Longitudinal Floats, Distributor Operators on Trucks, Winch Heads or Apparatuses (One), Mobil Track air and heaters (two to five), Heavy Equipment Greaser, Relief Operator, Assistant Master Mechanic and Heavy Duty Mechanic, all Operators (except those listed below).

GROUP II. Assistant Operators.

GROUP III. Air Compressors (One), Water Pumps, regardless of Size (One), Waterblasters (one), Welding Machine (One), Mixers (One Bag), Conveyor (One), Siphon or Jet (One), Light Plant (One), Heater (One), Immobile Track Air (One), and Self Propelled Walk-Behind Rollers.

GROUP IV. Asphalt Spreader Oilers, Fireman on Whirlies and Heavy Equipment Oilers, Truck Cranes, Dredges, Monigans, Large Cranes - (Over 65-ton rated capacity) Concrete Plant Oiler, Blacktop Plant Oiler, and Creter Crane Oiler (when required).

GROUP V. Oiler.

GROUP VI. Master Mechanics, Operators on equipment with Booms, including jibs, 100 feet and over, and less than 150 feet long.

GROUP VII. Operators on equipment with Booms, including jibs, 150 feet and over, and less than 200 feet long.

GROUP VIII. Operators on Equipment with Booms, including jibs, 200 feet and over; Tower Cranes; Whirlie Cranes; and Operator Foreman.

TERRAZZO FINISHER

The handling of all materials used for Mosaic and Terrazzo work including preparing, mixing by hand, by mixing machine or transporting of pre-mixed materials and distributing with shovel, rake, hoe, or pail, all kinds of concrete foundations necessary for Mosaic and Terrazzo work, all cement terrazzo, magnesite terrazzo, Do-O-Tex terrazzo, epoxy matrix ter-razzo, exposed aggregate, rustic or rough washed for exterior or interior of buildings placed either by machine or by hand, and any other kind of mixture of plastics composed of chips or granules when mixed with cement, rubber, neoprene, vinyl, magnesium chloride or any other resinous or chemical substances used for seamless flooring systems, and all other building materials, all similar materials and all precast terrazzo work on jobs, all scratch

coat used for Mosaic and Terrazzo work and sub-bed, tar paper and wire mesh (2x2 etc.) or lath. The rubbing, grinding, cleaning and finishing of same either by hand or by machine or by terrazzo resurfacing equipment on new or existing floors. When necessary finishers shall be allowed to assist the mechanics to spread sand bed, lay tarpaper and wire mesh (2x2 etc.) or lath. The finishing of cement floors where additional aggregate of stone is added by spreading or sprinkling on top of the finished base, and troweled or rolled into the finish and then the surface is ground by grinding machines.

Other Classifications of Work:

For definitions of classifications not otherwise set out, the Department generally has on file such definitions which are available. If a task to be performed is not subject to one of the classifications of pay set out, the Department will upon being contacted state which neighboring county has such a classification and provide such rate, such rate being deemed to exist by reference in this document. If no neighboring county rate applies to the task, the Department shall undertake a special determination, such special determination being then deemed to have existed under this determination. If a project requires these, or any classification not listed, please contact IDOL at 618/993-7271 for wage rates or clarifications.

LANDSCAPING

Landscaping work falls under the existing classifications for laborer, operating engineer and truck driver. The work performed by landscape plantsman and landscape laborer is covered by the existing classification of laborer. The work performed by landscape operators (regardless of equipment used or its size) is covered by the classifications of operating engineer. The work performed by landscape truck drivers (regardless of size of truck driven) is covered by the classifications of truck driver.

Washington County Prevailing Wage for May 2008

Trade Name	RG	TYP	C	Base	FRMAN	*M-F>8	OSA	OSH	H/W	Pensn	Vac	Trng
=====	==	==	=	=====	=====	=====	==	==	=====	=====	=====	=====
ASBESTOS ABT-GEN		ALL		23.850	24.350	1.5	1.5	2.0	5.350	8.600	0.000	0.600
ASBESTOS ABT-MEC		BLD		25.690	26.690	1.5	1.5	2.0	5.050	2.500	0.000	0.250
BOILERMAKER		BLD		30.000	32.500	1.5	1.5	2.0	6.820	11.28	1.000	0.300
BRICK MASON		BLD		27.090	28.840	1.5	1.5	2.0	5.250	8.450	2.000	0.400
CARPENTER		ALL		31.230	32.730	1.5	1.5	2.0	5.300	4.000	0.000	0.350
CEMENT MASON		BLD		24.000	25.000	1.5	1.5	2.0	5.300	4.050	0.000	0.200
CEMENT MASON		HWY		28.800	29.300	1.5	1.5	2.0	5.300	7.850	0.000	0.400
CERAMIC TILE FNSHER		BLD		23.370	0.000	1.5	1.5	2.0	5.200	4.400	0.000	0.410
ELECTRIC PWR EQMT OP		ALL		31.510	37.980	1.5	2.0	2.0	4.530	7.880	0.000	0.160
ELECTRIC PWR GRNDMAN		ALL		23.530	37.980	1.5	2.0	2.0	3.380	5.890	0.000	0.120
ELECTRIC PWR LINEMAN		ALL		36.220	37.980	1.5	2.0	2.0	5.210	9.060	0.000	0.180
ELECTRIC PWR TRK DRV		ALL		25.710	37.980	1.5	2.0	2.0	3.700	6.430	0.000	0.130
ELECTRICIAN	NW	ALL		33.740	36.760	1.5	1.5	2.0	5.400	6.750	0.000	0.420
ELECTRICIAN	SE	ALL		33.680	35.930	1.5	1.5	2.0	5.150	7.070	0.000	0.500
ELECTRONIC SYS TECH		BLD		26.740	28.240	1.5	1.5	2.0	5.150	3.470	0.000	0.250
ELEVATOR CONSTRUCTOR		BLD		38.715	43.550	2.0	2.0	2.0	8.775	6.960	2.320	0.000
FLOOR LAYER		BLD		27.680	28.430	1.5	1.5	2.0	5.300	4.000	0.000	0.350
GLAZIER		BLD		30.140	0.000	2.0	2.0	2.0	8.800	7.520	2.410	0.310
HT/FROST INSULATOR		BLD		31.240	32.240	1.5	1.5	2.0	5.300	8.860	0.000	0.450
IRON WORKER		ALL		27.350	28.850	1.5	1.5	2.0	6.360	9.150	0.000	0.420
LABORER		ALL		23.350	23.850	1.5	1.5	2.0	5.350	8.600	0.000	0.600
MACHINIST		BLD		38.390	40.390	2.0	2.0	2.0	4.880	6.550	2.650	0.000
MARBLE FINISHERS		BLD		23.370	0.000	1.5	1.5	2.0	5.200	4.400	0.000	0.410
MARBLE MASON		BLD		27.090	28.840	1.5	1.5	2.0	5.250	8.450	2.000	0.400
MILLWRIGHT		ALL		31.230	32.730	1.5	1.5	2.0	5.300	4.000	0.000	0.350
OPERATING ENGINEER		ALL	1	27.000	29.000	1.5	1.5	2.0	6.700	12.35	0.000	1.000
OPERATING ENGINEER		ALL	2	25.870	29.000	1.5	1.5	2.0	6.700	12.35	0.000	1.000
OPERATING ENGINEER		ALL	3	21.390	29.000	1.5	1.5	2.0	6.700	12.35	0.000	1.000
OPERATING ENGINEER		ALL	4	21.450	29.000	1.5	1.5	2.0	6.700	12.35	0.000	1.000
OPERATING ENGINEER		ALL	5	21.120	29.000	1.5	1.5	2.0	6.700	12.35	0.000	1.000
OPERATING ENGINEER		ALL	6	27.550	29.000	1.5	1.5	2.0	6.700	12.35	0.000	1.000
OPERATING ENGINEER		ALL	7	27.850	29.000	1.5	1.5	2.0	6.700	12.35	0.000	1.000
OPERATING ENGINEER		ALL	8	28.130	29.000	1.5	1.5	2.0	6.700	12.35	0.000	1.000
PAINTER		BLD		26.700	28.200	1.5	1.5	2.0	4.700	5.570	0.000	0.350
PAINTER		HWY		27.900	29.400	1.5	1.5	2.0	4.700	5.570	0.000	0.350
PAINTER OVER 30FT		BLD		27.700	29.200	1.5	1.5	2.0	4.700	5.570	0.000	0.350
PAINTER PWR EQMT		BLD		27.700	29.200	1.5	1.5	2.0	4.700	5.570	0.000	0.350
PAINTER PWR EQMT		HWY		28.900	30.400	1.5	1.5	2.0	4.700	5.570	0.000	0.350
PILEDRIVER		ALL		31.230	32.730	1.5	1.5	2.0	5.300	4.000	0.000	0.350
PIPEFITTER	E	BLD		30.000	33.000	1.5	1.5	2.0	5.650	5.000	0.000	0.850
PIPEFITTER	W	BLD		31.700	34.200	1.5	1.5	2.0	6.400	4.100	0.000	0.525
PLASTERER		BLD		23.500	24.500	1.5	1.5	2.0	5.200	3.550	0.000	0.100
PLUMBER	E	BLD		30.000	33.000	1.5	1.5	2.0	5.650	5.000	0.000	0.850
PLUMBER	W	BLD		31.700	34.200	1.5	1.5	2.0	6.400	4.100	0.000	0.525
ROOFER		BLD		26.750	28.750	1.5	1.5	2.0	6.100	5.900	0.000	0.200
SHEETMETAL WORKER		ALL		28.080	29.580	1.5	1.5	2.0	6.350	5.650	1.690	0.260
SPRINKLER FITTER		BLD		35.230	37.730	2.0	2.0	2.0	6.650	8.100	0.000	0.650
TERRAZZO FINISHER		BLD		31.240	0.000	1.5	1.5	2.0	0.000	0.000	0.000	0.000
TERRAZZO MASON		BLD		31.530	31.830	1.5	1.5	2.0	0.000	4.250	0.000	0.070
TRUCK DRIVER		ALL	1	27.580	0.000	1.5	1.5	2.0	8.600	3.925	0.000	0.000
TRUCK DRIVER		ALL	2	27.980	0.000	1.5	1.5	2.0	8.600	3.925	0.000	0.000
TRUCK DRIVER		ALL	3	28.180	0.000	1.5	1.5	2.0	8.600	3.925	0.000	0.000
TRUCK DRIVER		ALL	4	28.430	0.000	1.5	1.5	2.0	8.600	3.925	0.000	0.000
TRUCK DRIVER		ALL	5	29.180	0.000	1.5	1.5	2.0	8.600	3.925	0.000	0.000
TRUCK DRIVER		O&C	1	22.060	0.000	1.5	1.5	2.0	8.600	3.925	0.000	0.000
TRUCK DRIVER		O&C	2	22.380	0.000	1.5	1.5	2.0	8.600	3.925	0.000	0.000
TRUCK DRIVER		O&C	3	22.540	0.000	1.5	1.5	2.0	8.600	3.925	0.000	0.000
TRUCK DRIVER		O&C	4	22.740	0.000	1.5	1.5	2.0	8.600	3.925	0.000	0.000

TRUCK DRIVER O&C 5 23.340 0.000 1.5 1.5 2.0 8.600 3.925 0.000 0.000

Legend:

M-F>8 (Overtime is required for any hour greater than 8 worked each day, Monday through Friday.)

OSA (Overtime is required for every hour worked on Saturday)

OSH (Overtime is required for every hour worked on Sunday and Holidays)

H/W (Health & Welfare Insurance)

Pensn (Pension)

Vac (Vacation)

Trng (Training)

Explanations

WASHINGTON COUNTY

ELECTRICIANS (NORTHWEST) - Township of Venedy.

PLUMBERS & PIPEFITTERS (WEST) - That part of the county West of a line 2.5 miles East of Rt. 127 including the towns of Posin, Beacoup and New Minden.

PLUMBERS & PIPEFITTERS (EAST) - That part of the county East of a North-South line 2.5 miles East of Rt. 127.

The following list is considered as those days for which holiday rates of wages for work performed apply: New Years Day, Memorial/Decoration Day, Fourth of July, Labor Day, Veterans Day, Thanksgiving Day, Christmas Day. Generally, any of these holidays which fall on a Sunday is celebrated on the following Monday. This then makes work performed on that Monday payable at the appropriate overtime rate for holiday pay. Common practice in a given local may alter certain days of celebration such as the day after Thanksgiving for Veterans Day. If in doubt, please check with IDOL.

Oil and chip resealing (O&C) means the application of road oils and liquid asphalt to coat an existing road surface, followed by application of aggregate chips or gravel to coated surface, and subsequent rolling of material to seal the surface.

EXPLANATION OF CLASSES

ASBESTOS - GENERAL - removal of asbestos material/mold and hazardous materials from any place in a building, including mechanical systems where those mechanical systems are to be removed. This includes the removal of asbestos materials/mold and hazardous materials from ductwork or pipes in a building when the building is to be demolished at the time or at some close future date.

ASBESTOS - MECHANICAL - removal of asbestos material from mechanical systems, such as pipes, ducts, and boilers, where the mechanical systems are to remain.

CERAMIC TILE FINISHER AND MARBLE FINISHER

The handling, at the building site, of all sand, cement, tile, marble or stone and all other materials that may be used and installed by [a] tile layer or marble mason. In addition, the grouting, cleaning, sealing, and mixing on the job site, and all other work as required in assisting the setter. The term "Ceramic" is used for naming the classification only and is in no way a limitation of the product handled. Ceramic takes into consideration most hard tiles.

ELECTRONIC SYSTEMS TECHNICIAN

Installation, service and maintenance of low-voltage systems which utilizes the transmission and/or transference of voice, sound, vision, or digital for commercial, education, security and entertainment purposes for the following: TV monitoring and surveillance, background/foreground music, intercom and telephone interconnect, field programming, inventory control systems, microwave transmission, multi-media, multiplex, radio page, school, intercom and sound burglar alarms and low voltage master clock systems.

Excluded from this classification are energy management systems, life safety systems, supervisory controls and data acquisition systems not intrinsic with the above listed systems, fire alarm systems, nurse call systems and raceways exceeding fifteen feet in length.

TRUCK DRIVER - BUILDING, HEAVY AND HIGHWAY CONSTRUCTION

Class 1. Drivers on 2 axle trucks hauling less than 9 ton. Air compressor and welding machines and brooms, including those pulled by separate units, truck driver helpers, warehouse employees, mechanic helpers, greasers and tiremen, pickup trucks when hauling materials, tools, or workers to and from and on-the-job site, and fork lifts up to 6,000 lb. capacity.

Class 2. Two or three axle trucks hauling more than 9 ton but hauling less than 16 ton. A-frame winch trucks, hydrolift trucks, vector trucks or similar equipment when used for transportation purposes. Fork lifts over 6,000 lb. capacity, winch trucks, four axle combination units, and ticket writers.

Class 3. Two, three or four axle trucks hauling 16 ton or more. Drivers on water pulls, articulated dump trucks, mechanics and working forepersons, and dispatchers. Five axle or more combination units.

Class 4. Low Boy and Oil Distributors.

Class 5. Drivers who require special protective clothing while employed on hazardous waste work. Jurisdiction in Bond, Calhoun, Clinton, Fayette, Greene, Jefferson, Jersey, Macoupin, Madison, Marion, Monroe, Montgomery, Perry, Randolph, St. Clair, and Washington.

TRUCK DRIVER - OIL AND CHIP RESEALING ONLY.

This shall encompass laborers, workers and mechanics who drive contractor or subcontractor owned, leased, or hired pickup, dump, service, or oil distributor trucks. The work includes transporting materials and equipment (including but not limited to, oils, aggregate supplies, parts, machinery and tools) to or from the job site; distributing oil or liquid asphalt and aggregate; stock piling material when in connection with the actual oil and chip contract. The Truck Driver (Oil & Chip Resealing) wage classification does not include supplier delivered materials.

OPERATING ENGINEERS

GROUP I. Cranes, Dragline, Shovels, Skimmer Scoops, Clamshells or Derrick Boats, Pile Drivers, Crane-Type Backhoes, Asphalt Plant Operators, Concrete Plant Operators, Dredges, Asphalt Spreading Machines, All Locomotives, Cable Ways, or Tower Machines, Hoists, Hydraulic Backhoes, Ditching Machines or Backfiller, Cherrypickers, Overhead Cranes, Roller, Steam or Gas, Concrete Pavers, Excavators, Concrete Breakers, Concrete Pumps, Bulk Cement Plants, Cement Pumps, Derrick-Type Drills, Boat Operators, Motor Graders or Pushcats, Scoops or Tournapulls, Bulldozers, Endloaders or Fork Lifts, Power Blade or Elevating Graders, Winch Cats, Boom or Winch Trucks or Boom Tractors, Pipe Wrapping or Painting Machines, Asphalt Plant Engineer, Journeyman Lubricating Engineer, Drills (other than Derrick Type), Mud Jacks, or Well Drilling Machines, Boring Machines or Track Jacks, Mixers, Conveyors (Two), Air Compressors (Two), Water Pumps regardless of size (Two), Welding Machines (Two), Siphons or Jets (Two), Winch Heads or Apparatuses (Two), Light Plants (Two), Waterblasters (two), All Tractors regardless of size (straight tractor only), Fireman on Stationary Boilers, Automatic Elevators, Form Grading Machines, Finishing Machines, Power Sub-Grader or Ribbon Machines, Longitudinal Floats, Distributor Operators on Trucks, Winch Heads or Apparatuses (One), Mobil Track air and heaters (two to five), Heavy Equipment Greaser, Relief Operator, Assistant Master Mechanic and Heavy Duty Mechanic, all Operators (except those listed below).

GROUP II. Assistant Operators.

GROUP III. Air Compressors (One), Water Pumps, regardless of Size (One), Waterblasters (one), Welding Machine (One), Mixers (One Bag), Conveyor (One), Siphon or Jet (One), Light Plant (One), Heater (One), Immobile Track Air (One), and Self Propelled Walk-Behind Rollers.

GROUP IV. Asphalt Spreader Oilers, Fireman on Whirlies and Heavy Equipment Oilers, Truck Cranes, Dredges, Monigans, Large Cranes - (Over 65-ton rated capacity) Concrete Plant Oiler, Blacktop Plant Oiler, and Creter Crane Oiler (when required).

GROUP V. Oiler.

GROUP VI. Master Mechanics, Operators on equipment with Booms, including jibs, 100 feet and over, and less than 150 feet long.

GROUP VII. Operators on equipment with Booms, including jibs, 150 feet and over, and less than 200 feet long.

GROUP VIII. Operators on Equipment with Booms, including jibs, 200 feet and over; Tower Cranes; Whirlie Cranes; and Operator Foreman.

TERRAZZO FINISHER

The handling of all materials used for Mosaic and Terrazzo work including preparing, mixing by hand, by mixing machine or transporting of pre-mixed materials and distributing with shovel, rake, hoe, or pail, all kinds of concrete foundations necessary for Mosaic and Terrazzo work, all cement terrazzo, magnesite terrazzo, Do-O-Tex terrazzo, epoxy matrix ter-razzo, exposed aggregate, rustic or rough washed for exterior or interior of buildings placed either by machine or by hand, and any other kind of mixture of plastics composed of chips or granules when mixed with cement, rubber, neoprene, vinyl, magnesium chloride or any other resinous or chemical substances used for seamless flooring systems, and all other building materials, all similar materials and all precast terrazzo work on jobs, all scratch

coat used for Mosaic and Terrazzo work and sub-bed, tar paper and wire mesh (2x2 etc.) or lath. The rubbing, grinding, cleaning and finishing of same either by hand or by machine or by terrazzo resurfacing equipment on new or existing floors. When necessary finishers shall be allowed to assist the mechanics to spread sand bed, lay tarpaper and wire mesh (2x2 etc.) or lath. The finishing of cement floors where additional aggregate of stone is added by spreading or sprinkling on top of the finished base, and troweled or rolled into the finish and then the surface is ground by grinding machines.

Other Classifications of Work:

For definitions of classifications not otherwise set out, the Department generally has on file such definitions which are available. If a task to be performed is not subject to one of the classifications of pay set out, the Department will upon being contacted state which neighboring county has such a classification and provide such rate, such rate being deemed to exist by reference in this document. If no neighboring county rate applies to the task, the Department shall undertake a special determination, such special determination being then deemed to have existed under this determination. If a project requires these, or any classification not listed, please contact IDOL at 618/993-7271 for wage rates or clarifications.

LANDSCAPING

Landscaping work falls under the existing classifications for laborer, operating engineer and truck driver. The work performed by landscape plantsman and landscape laborer is covered by the existing classification of laborer. The work performed by landscape operators (regardless of equipment used or its size) is covered by the classifications of operating engineer. The work performed by landscape truck drivers (regardless of size of truck driven) is covered by the classifications of truck driver.