

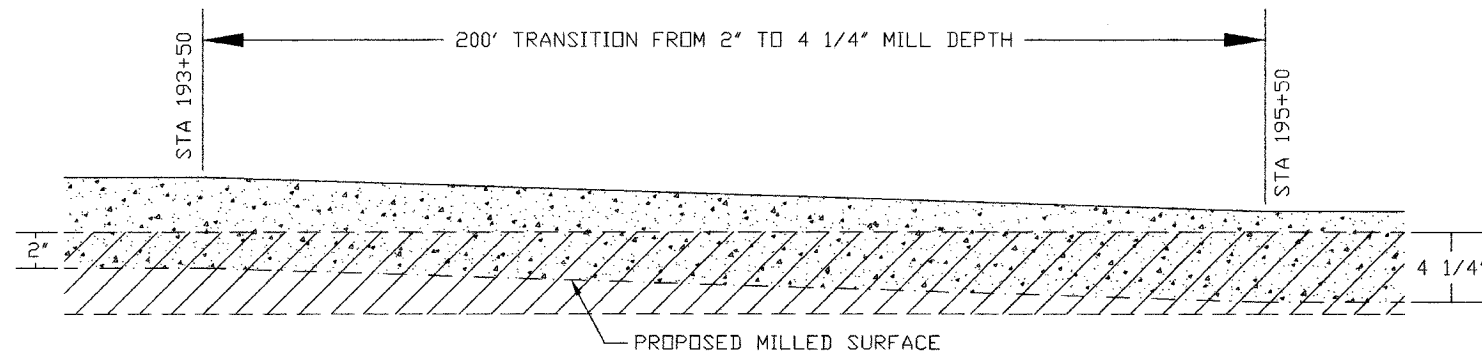

SURFACE REMOVAL TRANSITION DETAILS

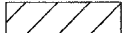

STA 193+50 TO STA 195+50

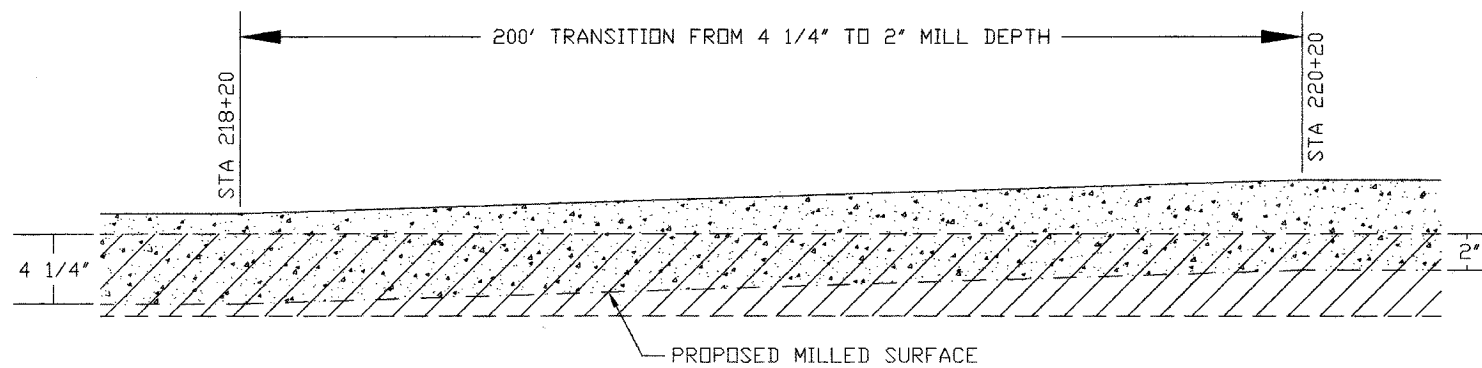

-  EXISTING HMA W/ A-2 SEAL COAT
-  PROPOSED PCC PAVEMENT 5"

STA 218+20 TO STA 220+20

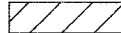

-  EXISTING HMA W/ A-2 SEAL COAT
-  PROPOSED PCC PAVEMENT 5"

SURFACE REMOVAL TYPICAL SECTIONS

ROUTE	SECTION	COUNTY	SHEET NO.	TOTAL SHEETS
FAS 798	92-00063-01-RS	CLAY	4	11
FEDERAL ROAD DISTRICT 7		ILLINOIS	FEDERAL AID PROJ.	
CONTRACT NO. 95551				

STA 0+22 TO STA 195+50
STA 218+20 TO STA 228+81

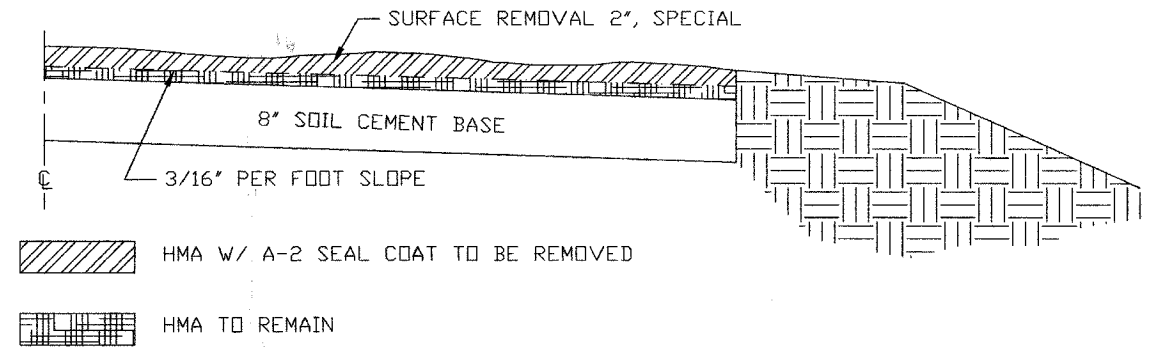

STA 195+50 TO STA 218+20

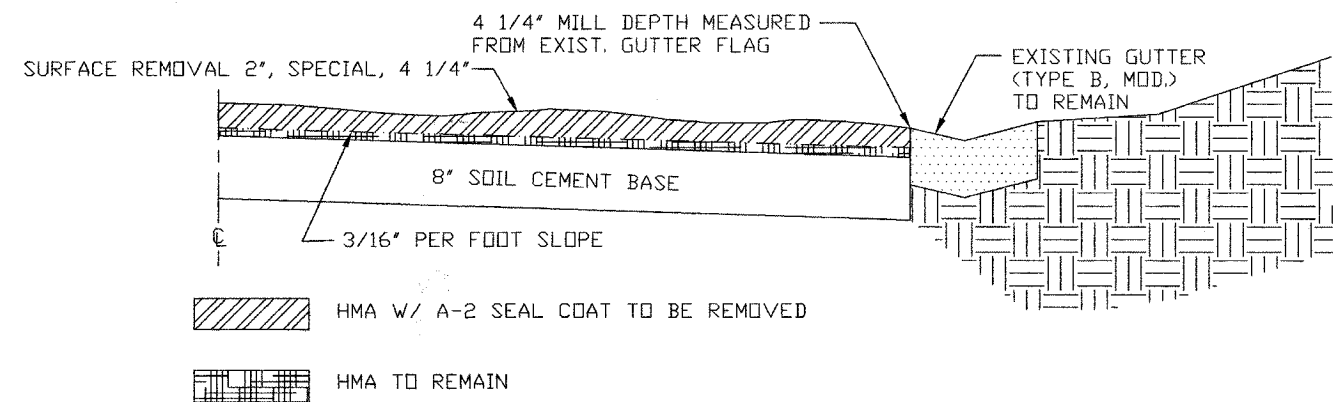

STA 228+81 TO STA 394+19.6

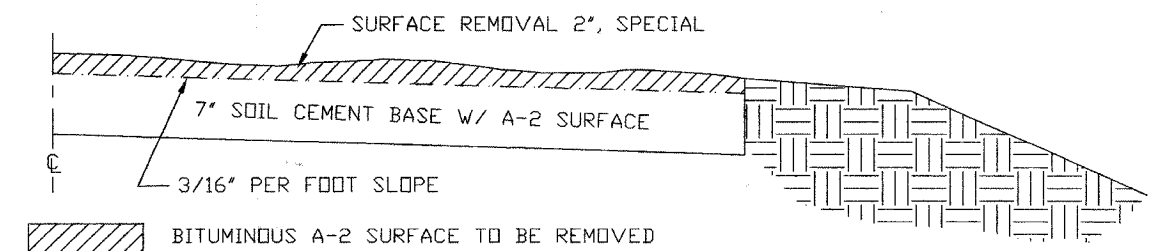

NOTE: SQUARE YARDAGE OF SURFACE REMOVAL WAS CALCULATED USING THE WIDTH OF THE PROPOSED SURFACE, ANY ADDITIONAL REMOVAL NEEDED FOR PROPER OPERATION OF PAVING EQUIPMENT WILL BE THE CONTRACTORS RESPONSIBILITY AND NO ADDITIONAL COMPENSATION WILL BE ALLOWED.