

RETURN WITH BID

State of _____)
) ss.
County of _____)

AFFIDAVIT

_____ (name of affiant), of _____,

_____, being first duly sworn upon oath, states as follows:

1. That I am the _____ (officer or position) of _____ (bidder) and have personal knowledge of the facts herein stated.
2. That, if selected under this proposal, _____ (bidder) will maintain a business office in the State of Illinois which will be located in _____ County, Illinois.
3. That this business office will serve as the primary place of employment for any persons employed in the construction contemplated by this proposal.
4. That this Affidavit is given as a requirement of state law as provided in Section 30-22(8) of the Illinois Procurement Code.

Signature

Print Name of Affiant

This instrument was acknowledged before me on the _____ day of _____, 20__ by _____.

Notary Public

(SEAL)

INSTRUCTIONS

ABOUT IDOT PROPOSALS: All proposals are potential bidding proposals. Each proposal contains all certifications and affidavits, a proposal signature sheet and a proposal bid bond.

PREQUALIFICATION

Any contractor who desires to become pre-qualified to bid on work advertised by IDOT must submit the properly completed pre-qualification forms to the Bureau of Construction no later than 4:30 p.m. prevailing time twenty-one days prior to the letting of interest. This pre-qualification requirement applies to first time contractors, contractors renewing expired ratings, contractors maintaining continuous pre-qualification or contractors requesting revised ratings. To be eligible to bid, existing pre-qualification ratings must be effective through the date of letting.

WHO CAN BID ?

Bids will be accepted from only those companies that request and receive written Authorization to Bid from IDOT's Central Bureau of Construction.

REQUESTS FOR AUTHORIZATION TO BID

Contractors wanting to bid on items included in a particular letting must submit the properly completed "Request for Authorization to Bid/or Not For Bid Status" (BDE 124) and the ORIGINAL "Affidavit of Availability" (BC 57) to the proper office no later than 4:30 p.m. prevailing time, three (3) days prior to the letting date.

WHAT CONSTITUTES WRITTEN AUTHORIZATION TO BID?: When a prospective prime bidder submits a "Request for Authorization to Bid/or Not For Bid Status"(BDE 124) he/she must indicate at that time which items are being requested For Bidding purposes. Only those items requested For Bidding will be analyzed. After the request has been analyzed, the bidder will be issued an **Authorization to Bid or Not for Bid Report**, approved by the Central Bureau of Construction and the Chief Procurement Officer that indicates which items have been approved For Bidding. If **Authorization to Bid** cannot be approved, the **Authorization to Bid or Not for Bid Report** will indicate the reason for denial.

ABOUT AUTHORIZATION TO BID: Firms that have not received an Authorization to Bid or Not For Bid Report within a reasonable time of complete and correct original document submittal should contact the department as to the status. Firms unsure as to authorization status should call the Prequalification Section of the Bureau of Construction at the number listed at the end of these instructions. These documents must be received three days before the letting date.

ADDENDA AND REVISIONS: It is the bidder's responsibility to determine which, if any, addenda or revisions pertain to any project they may be bidding. Failure to incorporate all relevant addenda or revisions may cause the bid to be declared unacceptable.

Each addendum or revision will be included with the Electronic Plans and Proposals. Addenda and revisions will also be placed on the Addendum/Revision Checklist and each subscription service subscriber will be notified by e-mail of each addendum and revision issued.

The Internet is the Department's primary way of doing business. The subscription service emails are an added courtesy the Department provides. It is suggested that bidders check IDOT's website at <http://www.dot.il.gov/desenv/delett.html> before submitting final bid information.

IDOT IS NOT RESPONSIBLE FOR ANY E-MAIL FAILURES.

Addenda questions may be directed to the Contracts Office at (217)782-7806 or D&Econtracts@dot.il.gov

Technical questions about downloading these files may be directed to Tim Garman at (217)524-1642 or Timothy.Garman@illinois.gov.

BID SUBMITTAL GUIDELINES AND CHECKLIST

In an effort to eliminate confusion and standardize the bid submission process the Contracts Office has created the following guidelines and checklist for submitting bids.

This information has been compiled from questions received from contractors and from inconsistencies noted on submitted bids. If you have additional questions please refer to the contact information listed below.

ABOUT SUBMITTING BIDS: It is recommended that bidders deliver bid proposals in person to ensure they arrive at the proper location prior to the time specified for the receipt of bids. Any proposals received at the place of letting after the time specified will not be read.

STANDARD GUIDELINES FOR SUBMITTING BIDS

- All pages should be single sided.
- Use the Cover Page that is provided in the Bid Proposal (posted on the IDOT Web Site) as the first page of your submitted bid. This page has the Item number in the upper left-hand corner and lines provided for your company name and address in the upper right-hand corner.
- Do not use report covers, presentation folders or special bindings and do not staple multiple times on left side like a book. Use only 1 staple in the upper left hand corner. Make sure all elements of your bid are stapled together including the bid bond or guaranty check (if required).
- Do not include any certificates of eligibility, your authorization to bid, Addendum Letters or affidavit of availability.
- Do not include the Subcontractor Documentation with your bid (pages i – iii and pages a – g). This documentation is required only after you are awarded the contract.
- Use the envelope cover sheet (provided with the proposal) as the cover for the proposal envelope.
- Do not rely on overnight services to deliver your proposal prior to 10 AM on letting day. It will not be read if it is delivered after 10 AM.
- Do not submit your Substance Abuse Prevention Program (SAPP) with your bid. If you are awarded the contract this form is to be submitted to the district engineer at the pre-construction conference.

Use the following checklist to ensure completeness and the correct order in assembling your bid

Illinois Office Affidavit (Not applicable to federally funded projects) insert your affidavit after page 4 along with your Cost Adjustments for Steel, Bituminous and Fuel (if applicable).

Cover page (the sheet that has the item number on it) **followed by your bid (the Pay Items)**. If you are using special software or CBID to generate your schedule of prices, do not include the blank pages of the schedule of prices that came with the proposal package.

Page 4 (Item 9) – Check “YES” if you will use a subcontractor(s). Include the subcontractor(s) name, address, general type of work to be performed and the dollar amount (if over \$50,000). If you will use subcontractor(s) but are uncertain who or the dollar amount; check “YES” but leave the lines blank.

Page 10 (Paragraph J) – Check “YES” or “NO” whether your company has any business in Iran.

Page 10 (Paragraph K) – (Not applicable to federally funded projects) List the Union Local Name and number or certified training programs that you have in place. **Your bid will not be read if this is not completed.** Do not include certificates with your bid. Keep the certificates in your office in case they are requested by IDOT.

Page 11 (Paragraph L) - A copy of your State Board of Elections certificate of registration is no longer required with your bid.

Page 11 (Paragraph M) – Indicate if your company has hired a lobbyist in connection with the job for which you are submitting the bid proposal.

Page 12 (Paragraph C) – This is a work sheet to determine if a completed Form A is required. It is not part of the form and you do not need to make copies for each Form A that is filled out.

Pages 14-17 (Form A) – One Form A (4 pages) is required for each applicable person in your company. Copies of the Forms can be used and only need to be changed when the financial information changes. The certification signature and date must be original for each letting. Do not staple the forms together.

If you answered “NO” to all of the questions in Paragraph C (page 12), complete the first section (page 14) with your company information and then sign and date the Not Applicable statement on page 17.

Page 18 (Form B) - If you check “YES” to having other current or pending contracts it is acceptable to use the phrase, “See Affidavit of Availability on file”. **Ownership Certification** (at the bottom of the page) - Check N/A if the Form A you submitted accounts for 100 percent of the company ownership. Check YES if any percentage of ownership falls outside of the parameters that require reporting on the Form A. Checking NO indicates that the Form A you submitted is not correct and you will be required to submit a revised Form A.

Page 20 (Workforce Projection) – Be sure to include the Duration of the Project. It is acceptable to use the phrase “Per Contract Specifications”.

Bid Bond – Submit your bid bond using the current Bid Bond Form provided in the proposal package. The Power of Attorney page should be stapled to the Bid Bond. If you are using an electronic bond, include your bid bond number on the form and attach the Proof of Insurance printed from the electronic bond Web Site.

Disadvantaged Business Utilization Plan and/or Good Faith Effort – The last item in your bid should be the DBE Utilization Plan (SBE 2026), followed by the DBE Participation Statement (SBE 2025) and supporting paperwork. If you have documentation for a Good Faith Effort, it should follow the SBE Forms.

The Bid Letting is now available in streaming Audio/Video from the IDOT Web Site. A link to the stream will be placed on the main page of the current letting on the day of the Letting. The stream will not begin until 10 AM. The actual reading of the bids does not begin until approximately 10:20 AM.

Following the Letting, the As-Read Tabulation of Bids will be posted by the end of the day. You will find the link on the main page of the current letting.

QUESTIONS: pre-letting up to execution of the contract

Contractor/Subcontractor pre-qualification -----217-782-3413
Small Business, Disadvantaged Business Enterprise (DBE) -----217-785-4611
Contracts, Bids, Letting process or Internet downloads-----217-782-7806
Estimates Unit -----217-785-3483
Aeronautics -----217-785-8515
IDNR (Land Reclamation, Water Resources, Natural Resources) -----217-782-6302

QUESTIONS: following contract execution

Including Subcontractor documentation, payments -----217-782-3413
Railroad Insurance -----217-785-0275

197

RETURN WITH BID

Proposal Submitted By
Name
Address
City

Letting June 14, 2013

NOTICE TO PROSPECTIVE BIDDERS

This proposal can be used for bidding purposes by only those companies that request and receive written **AUTHORIZATION TO BID** from IDOT's Central Bureau of Construction.
BIDDERS NEED NOT RETURN THE ENTIRE PROPOSAL

Notice to Bidders, Specifications, Proposal, Contract and Contract Bond



**Illinois Department
of Transportation**

Springfield, Illinois 62764

**Contract No. 46270
Various Counties
Section INT ATTRACT SIGN 2014-09
Various Routes
District TR Construction Funds**

PLEASE MARK THE APPROPRIATE BOX BELOW:

- A Bid Bond is included.
- A Cashier's Check or a Certified Check is included.

Plans Included
Herein

Prepared by

S

Checked by

(Printed by authority of the State of Illinois)

Page intentionally left blank

RETURN WITH BID



PROPOSAL

TO THE DEPARTMENT OF TRANSPORTATION

1. Proposal of _____

Taxpayer Identification Number (Mandatory) _____ a

For the improvement identified and advertised for bids in the Invitation for Bids as:

**Contract No. 46270
Various Counties
Section INT ATTRACT SIGN 2014-09
Various Routes
District TR Construction Funds**

This project consists of installing or replacing signage and supports at various locations as described in work orders.

2. The undersigned bidder will furnish all labor, material and equipment to complete the above described project in a good and workmanlike manner as provided in the contract documents provided by the Department of Transportation. This proposal will become part of the contract and the terms and conditions contained in the contract documents shall govern performance and payments.

RETURN WITH BID

3. **ASSURANCE OF EXAMINATION AND INSPECTION/WAIVER.** The undersigned further declares that he/she has carefully examined the proposal, plans, specifications, addenda, form of contract and contract bond, and special provisions, and that he/she has inspected in detail the site of the proposed work, and that he/she has familiarized themselves with all of the local conditions affecting the contract and the detailed requirements of construction, and understands that in making this proposal he/she waives all right to plead any misunderstanding regarding the same.
4. **EXECUTION OF CONTRACT AND CONTRACT BOND.** The undersigned further agrees to execute a contract for this work and present the same to the department within fifteen (15) days after the contract has been mailed to him/her. The undersigned further agrees that he/she and his/her surety will execute and present within fifteen (15) days after the contract has been mailed to him/her contract bond satisfactory to and in the form prescribed by the Department of Transportation, in the penal sum of the full amount of the contract, guaranteeing the faithful performance of the work in accordance with the terms of the contract.
5. **PROPOSAL GUARANTY.** Accompanying this proposal is either a bid bond on the department form, executed by a corporate surety company satisfactory to the department, or a proposal guaranty check consisting of a bank cashier's check or a properly certified check for not less than 5 per cent of the amount bid or for the amount specified in the following schedule:

<u>Amount of Bid</u>		<u>Proposal Guaranty</u>	<u>Amount of Bid</u>		<u>Proposal Guaranty</u>	
Up to	\$5,000	\$150	\$2,000,000	to	\$3,000,000	\$100,000
\$5,000	to	\$10,000	\$3,000,000	to	\$5,000,000	\$150,000
\$10,000	to	\$50,000	\$5,000,000	to	\$7,500,000	\$250,000
\$50,000	to	\$100,000	\$7,500,000	to	\$10,000,000	\$400,000
\$100,000	to	\$150,000	\$10,000,000	to	\$15,000,000	\$500,000
\$150,000	to	\$250,000	\$15,000,000	to	\$20,000,000	\$600,000
\$250,000	to	\$500,000	\$20,000,000	to	\$25,000,000	\$700,000
\$500,000	to	\$1,000,000	\$25,000,000	to	\$30,000,000	\$800,000
\$1,000,000	to	\$1,500,000	\$30,000,000	to	\$35,000,000	\$900,000
\$1,500,000	to	\$2,000,000	over		\$35,000,000	\$1,000,000

Bank cashier's checks or properly certified checks accompanying proposals shall be made payable to the Treasurer, State of Illinois, when the state is awarding authority; the county treasurer, when a county is the awarding authority; or the city, village, or town treasurer, when a city, village, or town is the awarding authority.

If a combination bid is submitted, the proposal guaranties which accompany the individual proposals making up the combination will be considered as also covering the combination bid.

The amount of the proposal guaranty check is _____ \$(_____). If this proposal is accepted and the undersigned shall fail to execute a contract bond as required herein, it is hereby agreed that the amount of the proposal guaranty shall become the property of the State of Illinois, and shall be considered as payment of damages due to delay and other causes suffered by the State because of the failure to execute said contract and contract bond; otherwise, the bid bond shall become void or the proposal guaranty check shall be returned to the undersigned.

Attach Cashier's Check or Certified Check Here

In the event that one proposal guaranty check is intended to cover two or more proposals, the amount must be equal to the sum of the proposal guaranties which would be required for each individual proposal. If the guaranty check is placed in another proposal, state below where it may be found.

The proposal guaranty check will be found in the proposal for:

Item _____

Section No. _____

County _____

Mark the proposal cover sheet as to the type of proposal guaranty submitted.

RETURN WITH BID

6. **COMBINATION BIDS.** The undersigned further agrees that if awarded the contract for the sections contained in the following combination, he/she will perform the work in accordance with the requirements of each individual proposal comprising the combination bid specified in the schedule below, and that the combination bid shall be prorated against each section in proportion to the bid submitted for the same. If an error is found to exist in the gross sum bid for one or more of the individual sections included in a combination, the combination bid shall be corrected as provided in the specifications.

When a combination bid is submitted, the schedule below must be completed in each proposal comprising the combination.

If alternate bids are submitted for one or more of the sections comprising the combination, a combination bid must be submitted for each alternate.

Schedule of Combination Bids

Combination No.	Sections Included in Combination	Combination Bid	
		Dollars	Cents

7. **SCHEDULE OF PRICES.** The undersigned bidder submits herewith, in accordance with the rules and instructions, a schedule of prices for the items of work for which bids are sought. The unit prices bid are in U.S. dollars and cents, and all extensions and summations have been made. The bidder understands that the quantities appearing in the bid schedule are approximate and are provided for the purpose of obtaining a gross sum for the comparison of bids. If there is an error in the extension of the unit prices, the unit prices shall govern. Payment to the contractor awarded the contract will be made only for actual quantities of work performed and accepted or materials furnished according to the contract. The scheduled quantities of work to be done and materials to be furnished may be increased, decreased or omitted as provided elsewhere in the contract.

8. **AUTHORITY TO DO BUSINESS IN ILLINOIS.** Section 20-43 of the Illinois Procurement Code (the Code) (30 ILCS 500/20-43) provides that a person (other than an individual acting as a sole proprietor) must be a legal entity authorized to do business in the State of Illinois prior to submitting the bid.

9. **The services of a subcontractor will be used.**

Check box Yes
 Check box No

For known subcontractors with subcontracts with an annual value of more than \$50,000, the contract shall include their name, address, general type of work to be performed, and the dollar allocation for each subcontractor.
 (30 ILCS 500/20-120)

10. **EXECUTION OF CONTRACT:** The Department of Transportation will, in accordance with the rules governing Department procurements, execute the contract and shall be the sole entity having the authority to accept performance and make payments under the contract. Execution of the contract by the Chief Procurement Officer (CPO) or the State Purchasing Officer (SPO) is for approval of the procurement process and execution of the contract by the Department. Neither the CPO nor the SPO shall be responsible for administration of the contract or determinations respecting performance or payment there under except as otherwise permitted in the Code.

ILLINOIS DEPARTMENT OF TRANSPORTATION
 SCHEDULE OF PRICES
 CONTRACT
 NUMBER - 46270

State Job # - C-60-009-14

Project Number

Route

County Name - VARIOUS- -

VARIOUS

Code - 0 - -

District - 0 - -

Section Number - *INT ATTRACT SIGN 2014-09

Item Number	Pay Item Description	Unit of Measure	Quantity	x	Unit Price	=	Total Price
X7010216	TRAF CONT & PROT SPL	L SUM	1.000				
X7200075	REM & REIN SIGN PANEL	SQ FT	900.000				
X7240195	REM EX SIGN PANEL	EACH	40.000				
X7240207	REM EX SIGN COMPL	EACH	50.000				
X7270025	REM EX SIGN SUPPORT	EACH	35.000				
Z0030905	INS SER SN OR MILE PL	EACH	160.000				
Z0030907	REM SER OR MILE PLATE	EACH	50.000				
Z0030910	TRANSFER SERVICE SIGN	EACH	75.000				
67100100	MOBILIZATION	L SUM	1.000				
72000300	SIGN PANEL T3	SQ FT	23,000.000				
72700100	STR STL SIN SUP BA	POUND	55,000.000				
73400100	CONC FOUNDATION	CU YD	100.000				
73700200	REM CONC FDN-GR MT	EACH	30.000				

CONTRACT NUMBER 46270

THIS IS THE TOTAL BID \$ _____

NOTES:

1. Each PAY ITEM should have a UNIT PRICE and a TOTAL PRICE.
2. The UNIT PRICE shall govern if no TOTAL PRICE is shown or if there is a discrepancy between the product of the UNIT PRICE multiplied by the QUANTITY.
3. If a UNIT PRICE is omitted, the TOTAL PRICE will be divided by the QUANTITY in order to establish a UNIT PRICE.
4. A bid may be declared UNACCEPTABLE if neither a unit price nor a total price is shown.

RETURN WITH BID

STATE REQUIRED ETHICAL STANDARDS GOVERNING CONTRACT PROCUREMENT: ASSURANCES, CERTIFICATIONS AND DISCLOSURES

I. GENERAL

A. Article 50 of the Code establishes the duty of all State CPOs, SPOs, and their designees to maximize the value of the expenditure of public moneys in procuring goods, services, and contracts for the State of Illinois and to act in a manner that maintains the integrity and public trust of State government. In discharging this duty, they are charged by law to use all available information, reasonable efforts, and reasonable actions to protect, safeguard, and maintain the procurement process of the State of Illinois.

B. In order to comply with the provisions of Article 50 and to carry out the duty established therein, all bidders are to adhere to ethical standards established for the procurement process, and to make such assurances, disclosures and certifications required by law. Except as otherwise required in subsection III, paragraphs J-M, by execution of the Proposal Signature Sheet, the bidder indicates that each of the mandated assurances have been read and understood, that each certification is made and understood, and that each disclosure requirement has been understood and completed.

C. In addition to all other remedies provided by law, failure to comply with any assurance, failure to make any disclosure or the making of a false certification shall be grounds for the CPO to void the contract, and may result in the suspension or debarment of the bidder or subcontractor. If a false certification is made by a subcontractor the contractor's submitted bid and the executed contract may not be declared void unless the contractor refuses to terminate the subcontract upon the State's request after a finding that the subcontractor's certification was false.

II. ASSURANCES

The assurances hereinafter made by the bidder are each a material representation of fact upon which reliance is placed should the Department enter into the contract with the bidder.

A. Conflicts of Interest

1. The Code provides in pertinent part:

Section 50-13. Conflicts of Interest.

(a) Prohibition. It is unlawful for any person holding an elective office in this State, holding a seat in the General Assembly, or appointed to or employed in any of the offices or agencies of state government and who receives compensation for such employment in excess of 60% of the salary of the Governor of the State of Illinois, or who is an officer or employee of the Capital Development Board or the Illinois Toll Highway Authority, or who is the spouse or minor child of any such person to have or acquire any contract, or any direct pecuniary interest in any contract therein, whether for stationery, printing, paper, or any services, materials, or supplies, that will be wholly or partially satisfied by the payment of funds appropriated by the General Assembly of the State of Illinois or in any contract of the Capital Development Board or the Illinois Toll Highway authority.

(b) Interests. It is unlawful for any firm, partnership, association or corporation, in which any person listed in subsection (a) is entitled to receive (i) more than 7 1/2% of the total distributable income or (ii) an amount in excess of the salary of the Governor, to have or acquire any such contract or direct pecuniary interest therein.

(c) Combined interests. It is unlawful for any firm, partnership, association, or corporation, in which any person listed in subsection (a) together with his or her spouse or minor children is entitled to receive (i) more than 15%, in the aggregate, of the total distributable income or (ii) an amount in excess of 2 times the salary of the Governor, to have or acquire any such contract or direct pecuniary interest therein.

(d) Securities. Nothing in this Section invalidates the provisions of any bond or other security previously offered or to be offered for sale or sold by or for the State of Illinois.

(e) Prior interests. This Section does not affect the validity of any contract made between the State and an officer or employee of the State or member of the General Assembly, his or her spouse, minor child or any combination of those persons if that contract was in existence before his or her election or employment as an officer, member, or employee. The contract is voidable, however, if it cannot be completed within 365 days after the officer, member, or employee takes office or is employed.

The current salary of the Governor is \$177,412.00. Sixty percent of the salary is \$106,447.20.

RETURN WITH BID

2. The bidder assures the Department that the award and execution of the contract would not cause a violation of Section 50-13, or that an effective exemption has been issued by the Board of Ethics to any individual subject to the Section 50-13 prohibitions pursuant to the provisions of Section 50-20 of the Code and Executive Order Number 3 (1998). Information concerning the exemption process is available from the Department upon request.

B. Negotiations

1. The Code provides in pertinent part:

Section 50-15. Negotiations.

(a) It is unlawful for any person employed in or on a continual contractual relationship with any of the offices or agencies of State government to participate in contract negotiations on behalf of that office or agency with any firm, partnership, association, or corporation with whom that person has a contract for future employment or is negotiating concerning possible future employment.

2. The bidder assures the Department that the award and execution of the contract would not cause a violation of Section 50-15, and that the bidder has no knowledge of any facts relevant to the kinds of acts prohibited therein.

C. Inducements

1. The Code provides:

Section 50-25. Inducement. Any person who offers or pays any money or other valuable thing to any person to induce him or her not to bid for a State contract or as recompense for not having bid on a State contract is guilty of a Class 4 felony. Any person who accepts any money or other valuable thing for not bidding for a State contract or who withholds a bid in consideration of the promise for the payment of money or other valuable thing is guilty of a Class 4 felony.

2. The bidder assures the Department that the award and execution of the contract would not cause a violation of Section 50-25, and that the bidder has no knowledge of any facts relevant to the kinds of acts prohibited therein.

D. Revolving Door Prohibition

1. The Code provides:

Section 50-30. Revolving door prohibition. CPOs, SPOs, procurement compliance monitors, their designees whose principal duties are directly related to State procurement, and executive officers confirmed by the Senate are expressly prohibited for a period of 2 years after terminating an affected position from engaging in any procurement activity relating to the State agency most recently employing them in an affected position for a period of at least 6 months. The prohibition includes, but is not limited to: lobbying the procurement process; specifying; bidding; proposing bid, proposal, or contract documents; on their own behalf or on behalf of any firm, partnership, association, or corporation. This Section applies only to persons who terminate an affected position on or after January 15, 1999.

2. The bidder assures the Department that the award and execution of the contract would not cause a violation of Section 50-30, and that the bidder has no knowledge of any facts relevant to the kinds of acts prohibited therein.

E. Reporting Anticompetitive Practices

1. The Code provides:

Section 50-40. Reporting anticompetitive practices. When, for any reason, any vendor, bidder, contractor, CPO, SPO, designee, elected official, or State employee suspects collusion or other anticompetitive practice among any bidders, offerors, contractors, proposers, or employees of the State, a notice of the relevant facts shall be transmitted to the Attorney General and the CPO.

2. The bidder assures the Department that it has not failed to report any relevant facts concerning the practices addressed in Section 50-40 which may involve the contract for which the bid is submitted.

F. Confidentiality

1. The Code provides:

Section 50-45. Confidentiality. Any CPO, SPO, designee, or executive officer who willfully uses or allows the use of specifications, competitive bid documents, proprietary competitive information, proposals, contracts, or selection information to compromise the fairness or integrity of the procurement, bidding, or contract process shall be subject to immediate dismissal, regardless of the Personnel code, any contract, or any collective bargaining agreement, and may in addition be subject to criminal prosecution.

2. The bidder assures the Department that it has no knowledge of any fact relevant to the practices addressed in Section 50-45 which may involve the contract for which the bid is submitted.

RETURN WITH BID

G. Insider Information

1. The Code provides:

Section 50-50. Insider information. It is unlawful for any current or former elected or appointed State official or State employee to knowingly use confidential information available only by virtue of that office or employment for actual or anticipated gain for themselves or another person.

2. The bidder assures the Department that it has no knowledge of any facts relevant to the practices addressed in Section 50-50 which may involve the contract for which the bid is submitted.

III. CERTIFICATIONS

The certifications hereinafter made by the bidder are each a material representation of fact upon which reliance is placed should the Department enter into the contract with the bidder. Section 50-2 of the Code provides that every person that has entered into a multi-year contract and every subcontractor with a multi-year subcontract shall certify, by July 1 of each fiscal year covered by the contract after the initial fiscal year, to the responsible CPO whether it continues to satisfy the requirements of Article 50 pertaining to the eligibility for a contract award. If a contractor or subcontractor is not able to truthfully certify that it continues to meet all requirements, it shall provide with its certification a detailed explanation of the circumstances leading to the change in certification status. A contractor or subcontractor that makes a false statement material to any given certification required under Article 50 is, in addition to any other penalties or consequences prescribed by law, subject to liability under the Whistleblower Reward and Protection Act for submission of a false claim.

A. Bribery

1. The Code provides:

Section 50-5. Bribery.

(a) Prohibition. No person or business shall be awarded a contract or subcontract under this Code who:

(1) has been convicted under the laws of Illinois or any other state of bribery or attempting to bribe an officer or employee of the State of Illinois or any other state in that officer's or employee's official capacity; or

(2) has made an admission of guilt of that conduct that is a matter of record but has not been prosecuted for that conduct.

(b) Businesses. No business shall be barred from contracting with any unit of State or local government, or subcontracting under such a contract, as a result of a conviction under this Section of any employee or agent of the business if the employee or agent is no longer employed by the business and:

(1) the business has been finally adjudicated not guilty; or

(2) the business demonstrates to the governmental entity with which it seeks to contract, or which is signatory to the contract which the subcontract relates, and that entity finds that the commission of the offense was not authorized, requested, commanded, or performed by a director, officer, or high managerial agent on behalf of the business as provided in paragraph (2) of subsection (a) of Section 5-4 of the Criminal Code of 1961.

(c) Conduct on behalf of business. For purposes of this Section, when an official, agent, or employee of a business committed the bribery or attempted bribery on behalf of the business and in accordance with the direction or authorization of a responsible official of the business, the business shall be chargeable with the conduct.

(d) Certification. Every bid submitted to and contract executed by the State, and every subcontract subject to Section 20-120 of the Code shall contain a certification by the contractor or the subcontractor, respectively, that the contractor or subcontractor is not barred from being awarded a contract or subcontract under this Section and acknowledges that the CPO may declare the related contract void if any certifications required by this Section are false. A contractor who makes a false statement, material to the certification, commits a Class 3 felony.

2. The contractor or subcontractor certifies that it is not barred from being awarded a contract under Section 50.5.

B. Felons

1. The Code provides:

Section 50-10. Felons. Unless otherwise provided, no person or business convicted of a felony shall do business with the State of Illinois or any State agency, or enter into a subcontract, from the date of conviction until 5 years after the date of completion of the sentence for that felony, unless no person held responsible by a prosecutorial office for the facts upon which the conviction was based continues to have any involvement with the business.

2. Certification. Every bid submitted to and contract executed by the State and every subcontract subject to Section 20-120 of the Code shall contain a certification by the bidder or contractor or subcontractor, respectively, that the bidder, contractor, or subcontractor is not barred from being awarded a contract or subcontract under this Section and acknowledges that the CPO may declare the related contract void if any of the certifications required by this Section are false.

RETURN WITH BID

C. Debt Delinquency

1. The Code provides:

Section 50-11 and 50-12. Debt Delinquency.

The contractor or bidder or subcontractor, respectively, certifies that it, or any affiliate, is not barred from being awarded a contract or subcontract under the Code. Section 50-11 prohibits a person from entering into a contract with a State agency, or entering into a subcontract, if it knows or should know that it, or any affiliate, is delinquent in the payment of any debt to the State as defined by the Debt Collection Board. Section 50-12 prohibits a person from entering into a contract with a State agency, or entering into a subcontract, if it, or any affiliate, has failed to collect and remit Illinois Use Tax on all sales of tangible personal property into the State of Illinois in accordance with the provisions of the Illinois Use Tax Act. The bidder or contractor or subcontractor, respectively, further acknowledges that the CPO may declare the related contract void if this certification is false or if the bidder, contractor, or subcontractor, or any affiliate, is determined to be delinquent in the payment of any debt to the State during the term of the contract.

D. Prohibited Bidders, Contractors and Subcontractors

1. The Code provides:

Section 50-10.5 and 50-60(c). Prohibited bidders, contractors and subcontractors.

The bidder or contractor or subcontractor, respectively, certifies in accordance with 30 ILCS 500/50-10.5 that no officer, director, partner or other managerial agent of the contracting business has been convicted of a felony under the Sarbanes-Oxley Act of 2002 or a Class 3 or Class 2 felony under the Illinois Securities Law of 1953 or if in violation of Subsection (c) for a period of five years from the date of conviction. Every bid submitted to and contract executed by the State and every subcontract subject to Section 20-120 of the Code shall contain a certification by the bidder, contractor, or subcontractor, respectively, that the bidder, contractor, or subcontractor is not barred from being awarded a contract or subcontract under this Section and acknowledges that the CPO shall declare the related contract void if any of the certifications completed pursuant to this Section are false.

E. Section 42 of the Environmental Protection Act

The bidder or contractor or subcontractor, respectively, certifies in accordance with 30 ILCS 500/50-14 that the bidder, contractor, or subcontractor, is not barred from being awarded a contract or entering into a subcontract under this Section which prohibits the bidding on or entering into contracts with the State of Illinois or a State agency, or entering into any subcontract, that is subject to the Code by a person or business found by a court or the Pollution Control Board to have committed a willful or knowing violation of Section 42 of the Environmental Protection Act for a period of five years from the date of the order. The bidder or contractor or subcontractor, respectively, acknowledges that the CPO may declare the contract void if this certification is false.

F. Educational Loan

1. Section 3 of the Educational Loan Default Act provides:

§ 3. No State agency shall contract with an individual for goods or services if that individual is in default, as defined in Section 2 of this Act, on an educational loan. Any contract used by any State agency shall include a statement certifying that the individual is not in default on an educational loan as provided in this Section.

2. The bidder, if an individual as opposed to a corporation, partnership or other form of business organization, certifies that the bidder is not in default on an educational loan as provided in Section 3 of the Act.

G. Bid-Rigging/Bid Rotating

1. Section 33E-11 of the Criminal Code of 1961 provides:

§ 33E-11. (a) Every bid submitted to and public contract executed pursuant to such bid by the State or a unit of local government shall contain a certification by the prime contractor that the prime contractor is not barred from contracting with any unit of State or local government as a result of a violation of either Section 33E-3 or 33E-4 of this Article. The State and units of local government shall provide the appropriate forms for such certification.

(b) A contractor who makes a false statement, material to the certification, commits a Class 3 felony.

A violation of Section 33E-3 would be represented by a conviction of the crime of bid-rigging which, in addition to Class 3 felony sentencing, provides that any person convicted of this offense or any similar offense of any state or the United States which contains the same elements as this offense shall be barred for 5 years from the date of conviction from contracting with any unit of State or local government. No corporation shall be barred from contracting with any unit of State or local government as a result of a conviction under this Section of any employee or agent of such corporation if the employee so convicted is no longer employed by the corporation and: (1) it has been finally adjudicated not guilty or (2) if it demonstrates to the governmental entity with which it seeks to contract and that entity finds that the commission of the offense was neither authorized, requested, commanded, nor performed by a director, officer or a high managerial agent in behalf of the corporation.

RETURN WITH BID

A violation of Section 33E-4 would be represented by a conviction of the crime of bid-rotating which, in addition to Class 2 felony sentencing, provides that any person convicted of this offense or any similar offense of any state or the United States which contains the same elements as this offense shall be permanently barred from contracting with any unit of State or local government. No corporation shall be barred from contracting with any unit of State or local government as a result of a conviction under this Section of any employee or agent of such corporation if the employee so convicted is no longer employed by the corporation and: (1) it has been finally adjudicated not guilty or (2) if it demonstrates to the governmental entity with which it seeks to contract and that entity finds that the commission of the offense was neither authorized, requested, commanded, nor performed by a director, officer or a high managerial agent in behalf of the corporation.

2. The bidder certifies that it is not barred from contracting with the Department by reason of a violation of either Section 33E-3 or Section 33E-4.

H. International Anti-Boycott

1. Section 5 of the International Anti-Boycott Certification Act provides:

§ 5. State contracts. Every contract entered into by the State of Illinois for the manufacture, furnishing, or purchasing of supplies, material, or equipment or for the furnishing of work, labor, or services, in an amount exceeding the threshold for small purchases according to the purchasing laws of this State or \$10,000.00, whichever is less, shall contain certification, as a material condition of the contract, by which the contractor agrees that neither the contractor nor any substantially-owned affiliated company is participating or shall participate in an international boycott in violation of the provisions of the U.S. Export Administration Act of 1979 or the regulations of the U.S. Department of Commerce promulgated under that Act.

2. The bidder makes the certification set forth in Section 5 of the Act.

I. Drug Free Workplace

1. The Illinois "Drug Free Workplace Act" applies to this contract and it is necessary to comply with the provisions of the "Act" if the contractor is a corporation, partnership, or other entity (including a sole proprietorship) which has 25 or more employees.

2. The bidder certifies that if awarded a contract in excess of \$5,000 it will provide a drug free workplace by:

(a) Publishing a statement notifying employees that the unlawful manufacture, distribution, dispensation, possession or use of a controlled substance, including cannabis, is prohibited in the contractor's workplace; specifying the actions that will be taken against employees for violations of such prohibition; and notifying the employee that, as a condition of employment on such contract, the employee shall abide by the terms of the statement, and notify the employer of any criminal drug statute conviction for a violation occurring in the workplace no later than five (5) days after such conviction.

(b) Establishing a drug free awareness program to inform employees about the dangers of drug abuse in the workplace; the contractor's policy of maintaining a drug free workplace; any available drug counseling, rehabilitation, and employee assistance programs; and the penalties that may be imposed upon employees for drug violations.

(c) Providing a copy of the statement required by subparagraph (1) to each employee engaged in the performance of the contract and to post the statement in a prominent place in the workplace.

(d) Notifying the Department within ten (10) days after receiving notice from an employee or otherwise receiving actual notice of the conviction of an employee for a violation of any criminal drug statute occurring in the workplace.

(e) Imposing or requiring, within 30 days after receiving notice from an employee of a conviction or actual notice of such a conviction, an appropriate personnel action, up to and including termination, or the satisfactory participation in a drug abuse assistance or rehabilitation program approved by a federal, state or local health, law enforcement or other appropriate agency.

(f) Assisting employees in selecting a course of action in the event drug counseling, treatment, and rehabilitation is required and indicating that a trained referral team is in place.

(g) Making a good faith effort to continue to maintain a drug free workplace through implementation of the actions and efforts stated in this certification.

RETURN WITH BID

J. Disclosure of Business Operations in Iran

Section 50-36 of the Code, 30ILCS 500/50-36 provides that each bid, offer, or proposal submitted for a State contract shall include a disclosure of whether or not the Company acting as the bidder, offeror, or proposing entity, or any of its corporate parents or subsidiaries, within the 24 months before submission of the bid, offer, or proposal had business operations that involved contracts with or provision of supplies or services to the Government of Iran, companies in which the Government of Iran has any direct or indirect equity share, consortiums or projects commissioned by the Government of Iran, or companies involved in consortiums or projects commissioned by the Government of Iran and either of the following conditions apply:

- (1) More than 10% of the Company's revenues produced in or assets located in Iran involve oil-related activities or mineral-extraction activities; less than 75% of the Company's revenues produced in or assets located in Iran involve contracts with or provision of oil-related or mineral-extraction products or services to the Government of Iran or a project or consortium created exclusively by that government; and the Company has failed to take substantial action.
- (2) The Company has, on or after August 5, 1996, made an investment of \$20 million or more, or any combination of investments of at least \$10 million each that in the aggregate equals or exceeds \$20 million in any 12-month period, which directly or significantly contributes to the enhancement of Iran's ability to develop petroleum resources of Iran.

The terms "Business operations", "Company", "Mineral-extraction activities", "Oil-related activities", "Petroleum resources", and "Substantial action" are all defined in the Code.

Failure to make the disclosure required by the Code shall cause the bid, offer or proposal to be considered not responsive. The disclosure will be considered when evaluating the bid, offer, or proposal or awarding the contract. The name of each Company disclosed as doing business or having done business in Iran will be provided to the State Comptroller.

Check the appropriate statement:

Company has no business operations in Iran to disclose.

Company has business operations in Iran as disclosed the attached document.

K. Apprenticeship and Training Certification (Does not apply to federal aid projects)

In accordance with the provisions of Section 30-22 (6) of the Code, the bidder certifies that it is a participant, either as an individual or as part of a group program, in the approved apprenticeship and training programs applicable to each type of work or craft that the bidder will perform with its own forces. The bidder further certifies for work that will be performed by subcontract that each of its subcontractors submitted for approval either (a) is, at the time of such bid, participating in an approved, applicable apprenticeship and training program; or (b) will, prior to commencement of performance of work pursuant to this contract, begin participation in an approved apprenticeship and training program applicable to the work of the subcontract. The Department, at any time before or after award, may require the production of a copy of each applicable Certificate of Registration issued by the United States Department of Labor evidencing such participation by the contractor and any or all of its subcontractors. Applicable apprenticeship and training programs are those that have been approved and registered with the United States Department of Labor. The bidder shall list in the space below, the official name of the program sponsor holding the Certificate of Registration for all of the types of work or crafts in which the bidder is a participant and that will be performed with the bidder's forces. Types of work or craft work that will be subcontracted shall be included and listed as subcontract work. The list shall also indicate any type of work or craft job category that does not have an applicable apprenticeship or training program. **The bidder is responsible for making a complete report and shall make certain that each type of work or craft job category that will be utilized on the project as reported on the Construction Employee Workforce Projection (Form BC-1256) and returned with the bid is accounted for and listed.**

The requirements of this certification and disclosure are a material part of the contract, and the contractor shall require this certification provision to be included in all approved subcontracts. In order to fulfill this requirement, it shall not be necessary that an applicable program sponsor be currently taking or that it will take applications for apprenticeship, training or employment during the performance of the work of this contract.

TO BE RETURNED WITH BID

L. Political Contributions and Registration with the State Board of Elections

Sections 20-160 and 50-37 of the Code regulate political contributions from business entities and any affiliated entities or affiliated persons bidding on or contracting with the state. Generally under Section 50-37, any business entity, and any affiliated entity or affiliated person of the business entity, whose current year contracts with all state agencies exceed an awarded value of \$50,000, are prohibited from making any contributions to any political committees established to promote the candidacy of the officeholder responsible for the awarding of the contracts or any other declared candidate for that office for the duration of the term of office of the incumbent officeholder or a period 2 years after the termination of the contract, whichever is longer. Any business entity and affiliated entities or affiliated persons whose state contracts in the current year do not exceed an awarded value of \$50,000, but whose aggregate pending bids and proposals on state contracts exceed \$50,000, either alone or in combination with contracts not exceeding \$50,000, are prohibited from making any political contributions to any political committee established to promote the candidacy of the officeholder responsible for awarding the pending contract during the period beginning on the date the invitation for bids or request for proposals is issued and ending on the day after the date of award or selection if the entity was not awarded or selected. Section 20-160 requires certification of registration of affected business entities in accordance with procedures found in Section 9-35 of The Election Code.

By submission of a bid, the contractor business entity acknowledges and agrees that it has read and understands Sections 20-160 and 50-37 of the Code, and that it makes the following certification:

The undersigned business entity certifies that it has registered as a business with the State Board of Elections and acknowledges a continuing duty to update the registration in accordance with the above referenced statutes. If the business entity is required to register, the CPO shall verify that it is in compliance on the date the bid or proposal is due. The CPO shall not accept a bid or proposal if the business entity is not in compliance with the registration requirements.

These requirements and compliance with the above referenced statutory sections are a material part of the contract, and any breach thereof shall be cause to void the contract under Section 50-60 of the Code. This provision does not apply to Federal-aid contracts.

M. Lobbyist Disclosure

Section 50-38 of the Code requires that any bidder or offeror on a State contract that hires a person required to register under the Lobbyist Registration Act to assist in obtaining a contract shall:

- (i) Disclose all costs, fees, compensation, reimbursements, and other remunerations paid or to be paid to the lobbyist related to the contract,
- (ii) Not bill or otherwise cause the State of Illinois to pay for any of the lobbyist's costs, fees, compensation, reimbursements, or other remuneration, and
- (iii) Sign a verification certifying that none of the lobbyist's costs, fees, compensation, reimbursements, or other remuneration were billed to the State.

This information, along with all supporting documents, shall be filed with the agency awarding the contract and with the Secretary of State. The CPO shall post this information, together with the contract award notice, in the online Procurement Bulletin.

Pursuant to Subsection (c) of this Section, no person or entity shall retain a person or entity to attempt to influence the outcome of a procurement decision made under the Code for compensation contingent in whole or in part upon the decision or procurement. Any person who violates this subsection is guilty of a business offense and shall be fined not more than \$10,000.

Bidder acknowledges that it is required to disclose the hiring of any person required to register pursuant to the Illinois Lobbyist Registration Act (25 ILCS 170) in connection with this contract.

Bidder has not hired any person required to register pursuant to the Illinois Lobbyist Registration Act in connection with this contract.

Or

Bidder has hired the following persons required to register pursuant to the Illinois Lobbyist Registration Act in connection with the contract:

Name and address of person: _____
All costs, fees, compensation, reimbursements and other remuneration paid to said person: _____

RETURN WITH BID

IV. DISCLOSURES

- A. The disclosures hereinafter made by the bidder are each a material representation of fact upon which reliance is placed should the Department enter into the contract with the bidder. The bidder further certifies that the Department has received the disclosure forms for each bid.

The CPO may void the bid, or contract, respectively, if it is later determined that the bidder or subcontractor rendered a false or erroneous disclosure. A contractor or subcontractor may be suspended or debarred for violations of the Code. Furthermore, the CPO may void the contract and the surety providing the performance bond shall be responsible for completion of the contract.

B. Financial Interests and Conflicts of Interest

1. Section 50-35 of the Code provides that all bids of more than \$25,000 shall be accompanied by disclosure of the financial interests of the bidder. This disclosed information for the successful bidder, will be maintained as public information subject to release by request pursuant to the Freedom of Information Act, filed with the Procurement Policy Board, and shall be incorporated as a material term of the contract. Furthermore, pursuant to Section 5-5, the Procurement Policy Board may review a proposal, bid, or contract and issue a recommendation to void a contract or reject a proposal or bid based on any violation of the Code or the existence of a conflict of interest as provided in subsections (b) and (d) of Section 50-35.

The financial interests to be disclosed shall include ownership or distributive income share that is in excess of 5%, or an amount greater than 60% of the annual salary of the Governor, of the bidding entity or its parent entity, whichever is less, unless the contractor or bidder is a publicly traded entity subject to Federal 10K reporting, in which case it may submit its 10K disclosure in place of the prescribed disclosure. If a bidder is a privately held entity that is exempt from Federal 10K reporting, but has more than 200 shareholders, it may submit the information that Federal 10K companies are required to report, and list the names of any person or entity holding any ownership share that is in excess of 5%. The disclosure shall include the names, addresses, and dollar or proportionate share of ownership of each person making the disclosure, their instrument of ownership or beneficial relationship, and notice of any potential conflict of interest resulting from the current ownership or beneficial interest of each person making the disclosure having any of the relationships identified in Section 50-35 and on the disclosure form.
The current annual salary of the Governor is \$177,412.00

In addition, all disclosures shall indicate any other current or pending contracts, proposals, leases, or other ongoing procurement relationships the bidding entity has with any other unit of state government and shall clearly identify the unit and the contract, proposal, lease, or other relationship.

2. Disclosure Forms. Disclosure Form A is attached for use concerning the individuals meeting the above ownership or distributive share requirements. A separate Disclosure Form A must be submitted with the bid for each individual meeting the above requirements. In addition, a second form (Disclosure Form B) provides for the disclosure of current or pending procurement relationships with other (non-IDOT) state agencies and a total ownership certification. **The forms must be included with each bid.**

C. Disclosure Form Instructions

Form A Instructions for Financial Information & Potential Conflicts of Interest

If the bidder is a publicly traded entity subject to Federal 10K reporting, the 10K Report may be submitted to meet the requirements of Form A. If a bidder is a privately held entity that is exempt from Federal 10K reporting, but has more than 200 shareholders, it may submit the information that Federal 10K companies are required to report, and list the names of any person or entity holding any ownership share that is in excess of 5%. If a bidder is not subject to Federal 10K reporting, the bidder must determine if any individuals are required by law to complete a financial disclosure form. To do this, the bidder should answer each of the following questions. A "YES" answer indicates Form A must be completed. If the answer to each of the following questions is "NO", then the NOT APPLICABLE STATEMENT on Form A must be signed and dated by a person that is authorized to execute contracts for the bidding company. Note: These questions are for assistance only and are not required to be completed.

1. Does anyone in your organization have a direct or beneficial ownership share of greater than 5% of the bidding entity or parent entity? YES ___ NO ___
2. Does anyone in your organization have a direct or beneficial ownership share of less than 5%, but which has a value greater than 60% of the annual salary of the Governor? YES ___ NO ___
3. Does anyone in your organization receive more than 60% of the annual salary of the Governor of the bidding entity's or parent entity's distributive income? YES ___ NO ___

(Note: Distributive income is, for these purposes, any type of distribution of profits. An annual salary is not distributive income.)

4. Does anyone in your organization receive greater than 5% of the bidding entity's or parent entity's total distributive income, but which is less than 60% of the annual salary of the Governor? YES ___ NO ___

(Note: Only one set of forms needs to be completed per person per bid even if a specific individual would require a yes answer to more than one question.)

A "YES" answer to any of these questions requires the completion of Form A. The bidder must determine each individual in the bidding entity or the bidding entity's parent company that would cause the questions to be answered "Yes". Each form must be signed and dated by a person that is authorized to execute contracts for your organization. **Photocopied or stamped signatures are not acceptable.** The person signing can be, but does not have to be, the person for which the form is being completed. The bidder is responsible for the accuracy of any information provided.

If the answer to each of the above questions is "NO", then the NOT APPLICABLE STATEMENT of Form A must be signed and dated by a person that is authorized to execute contracts for your company.

RETURN WITH BID

Form B: Instructions for Identifying Other Contracts & Procurement Related Information

Disclosure Form B must be completed for each bid submitted by the bidding entity. *Note: Checking the NOT APPLICABLE STATEMENT on Form A does not allow the bidder to ignore Form B. Form B must be completed, checked, and dated or the bidder may be considered nonresponsive and the bid will not be accepted.*

The Bidder shall identify, by checking Yes or No on Form B, whether it has any pending contracts (including leases), bids, proposals, or other ongoing procurement relationship with any other (non-IDOT) State of Illinois agency. If "No" is checked, the bidder only needs to complete the check box on the bottom of Form B. If "Yes" is checked, the bidder must do one of the following:

Option I: If the bidder did not submit an Affidavit of Availability to obtain authorization to bid, the bidder must list all non-IDOT State of Illinois agency pending contracts, leases, bids, proposals, and other ongoing procurement relationships. These items may be listed on Form B or on an attached sheet(s). Do not include IDOT contracts. Contracts with cities, counties, villages, etc. are not considered State of Illinois agency contracts and are not to be included. Contracts with other State of Illinois agencies such as the Department of Natural Resources or the Capital Development Board must be included. Bidders who submit Affidavits of Availability are suggested to use Option II.

Option II: If the bidder is required and has submitted an Affidavit of Availability in order to obtain authorization to bid, the bidder may write or type "See Affidavit of Availability" which indicates that the Affidavit of Availability is incorporated by reference and includes all non-IDOT State of Illinois agency pending contracts, leases, bids, proposals, and other ongoing procurement relationships. For any contracts that are not covered by the Affidavit of Availability, the bidder must identify them on Form B or on an attached sheet(s). These might be such things as leases.

ILLINOIS DEPARTMENT OF TRANSPORTATION

Form A Financial Information & Potential Conflicts of Interest Disclosure

Contractor Name, Legal Address, City, State, Zip, Telephone Number, Email Address, Fax Number (if available)

Disclosure of the information contained in this Form is required by the Section 50-35 of the Code (30 ILCS 500). Vendors desiring to enter into a contract with the State of Illinois must disclose the financial information and potential conflict of interest information as specified in this Disclosure Form. This information shall become part of the publicly available contract file. This Form A must be completed for bids in excess of \$25,000, and for all open-ended contracts. A publicly traded company may submit a 10K disclosure (or equivalent if applicable) in satisfaction of the requirements set forth in Form A. See Disclosure Form Instructions.

The current annual salary of the Governor is \$177,412.00.

DISCLOSURE OF FINANCIAL INFORMATION

1. Disclosure of Financial Information. The individual named below has an interest in the BIDDER (or its parent) in terms of ownership or distributive income share in excess of 5%, or an interest which has a value of more than 60% of the annual salary of the Governor. (Make copies of this form as necessary and attach a separate Disclosure Form A for each individual meeting these requirements)

FOR INDIVIDUAL (type or print information) NAME: ADDRESS Type of ownership/distributable income share: stock sole proprietorship Partnership other: (explain on separate sheet): % or \$ value of ownership/distributable income share:

2. Disclosure of Potential Conflicts of Interest. Check "Yes" or "No" to indicate which, if any, of the following potential conflict of interest relationships apply. If the answer to any question is "Yes", please attach additional pages and describe.

(a) State employment, currently or in the previous 3 years, including contractual employment of services. Yes ___ No ___

If your answer is yes, please answer each of the following questions.

1. Are you currently an officer or employee of either the Capitol Development Board or the Illinois State Toll Highway Authority? Yes ___ No ___

2. Are you currently appointed to or employed by any agency of the State of Illinois? If you are currently appointed to or employed by any agency of the State of Illinois, and your annual salary exceeds 60% of the annual salary of the Governor, provide the name the State agency for which you are employed and your annual salary.

RETURN WITH BID

3. If you are currently appointed to or employed by any agency of the State of Illinois, and your annual salary exceeds 60% of the annual salary of the Governor, are you entitled to receive (i) more than 7 1/2% of the total distributable income of your firm, partnership, association or corporation, or (ii) an amount in excess of 100% of the annual salary of the Governor?
Yes ___ No ___

4. If you are currently appointed to or employed by any agency of the State of Illinois, and your annual salary exceeds 60% of the annual salary of the Governor, are you and your spouse or minor children entitled to receive (i) more than 15 % in the aggregate of the total distributable income of your firm, partnership, association or corporation, or (ii) an amount in excess of two times the salary of the Governor?
Yes ___ No ___

(b) State employment of spouse, father, mother, son, or daughter, including contractual employment for services in the previous 2 years.
Yes ___ No ___

If your answer is yes, please answer each of the following questions.

1. Is your spouse or any minor children currently an officer or employee of the Capitol Development Board or the Illinois State Toll Highway Authority?
Yes ___ No ___

2. Is your spouse or any minor children currently appointed to or employed by any agency of the State of Illinois? If your spouse or minor children is/are currently appointed to or employed by any agency of the State of Illinois, and his/her annual salary exceeds 60% of the annual salary of the Governor, provide the name of your spouse and/or minor children, the name of the State agency for which he/she is employed and his/her annual salary. _____

3. If your spouse or any minor children is/are currently appointed to or employed by any agency of the State of Illinois, and his/her annual salary exceeds 60% of the annual salary of the Governor, are you entitled to receive (i) more than 7 1/2% of the total distributable income of your firm, partnership, association or corporation, or (ii) an amount in excess of 100% of the annual salary of the Governor?
Yes ___ No ___

4. If your spouse or any minor children are currently appointed to or employed by any agency of the State of Illinois, and his/her annual salary exceeds 60% of the annual salary of the Governor, are you and your spouse or minor children entitled to receive (i) more than 15 % in the aggregate of the total distributable income of your firm, partnership, association or corporation, or (ii) an amount in excess of two times the salary of the Governor?
Yes ___ No ___

(c) Elective status; the holding of elective office of the State of Illinois, the government of the United States, any unit of local government authorized by the Constitution of the State of Illinois or the statutes of the State of Illinois currently or in the previous 3 years.
Yes ___ No ___

(d) Relationship to anyone holding elective office currently or in the previous 2 years; spouse, father, mother, son, or daughter.
Yes ___ No ___

(e) Appointive office; the holding of any appointive government office of the State of Illinois, the United States of America, or any unit of local government authorized by the Constitution of the State of Illinois or the statutes of the State of Illinois, which office entitles the holder to compensation in excess of the expenses incurred in the discharge of that office currently or in the previous 3 years.
Yes ___ No ___

(f) Relationship to anyone holding appointive office currently or in the previous 2 years; spouse, father, mother, son, or daughter.
Yes ___ No ___

(g) Employment, currently or in the previous 3 years, as or by any registered lobbyist of the State government.
Yes ___ No ___

RETURN WITH BID

(h) Relationship to anyone who is or was a registered lobbyist in the previous 2 years; spouse, father, mother, son, or daughter. Yes ___ No ___

(i) Compensated employment, currently or in the previous 3 years, by any registered election or reelection committee registered with the Secretary of State or any county clerk of the State of Illinois, or any political action committee registered with either the Secretary of State or the Federal Board of Elections. Yes ___ No ___

(j) Relationship to anyone; spouse, father, mother, son, or daughter; who was a compensated employee in the last 2 years by any registered election or re-election committee registered with the Secretary of State or any county clerk of the State of Illinois, or any political action committee registered with either the Secretary of State or the Federal Board of Elections. Yes ___ No ___

3. Communication Disclosure.

Disclose the name and address of each lobbyist and other agent of the bidder or offeror who is not identified in Section 2 of this form, who is has communicated, is communicating, or may communicate with any State officer or employee concerning the bid or offer. This disclosure is a continuing obligation and must be promptly supplemented for accuracy throughout the process and throughout the term of the contract. If no person is identified, enter "None" on the line below:

Name and address of person(s): _____

RETURN WITH BID

4. Debarment Disclosure. For each of the persons identified under Sections 2 and 3 of this form, disclose whether any of the following has occurred within the previous 10 years: debarment from contracting with any governmental entity; professional licensure discipline; bankruptcies; adverse civil judgments and administrative findings; and criminal felony convictions. This disclosure is a continuing obligation and must be promptly supplemented for accuracy throughout the procurement process and term of the contract. If no person is identified, enter "None" on the line below:

Name of person(s): _____

Nature of disclosure: _____

APPLICABLE STATEMENT

This Disclosure Form A is submitted on behalf of the INDIVIDUAL named on previous page. Under penalty of perjury, I certify the contents of this disclosure to be true and accurate to the best of my knowledge.

Completed by: _____ Date _____
Signature of Individual or Authorized Representative

NOT APPLICABLE STATEMENT

Under penalty of perjury, I have determined that no individuals associated with this organization meet the criteria that would require the completion of this Form A.

This Disclosure Form A is submitted on behalf of the CONTRACTOR listed on the previous page.

_____ Date _____
Signature of Authorized Representative

The bidder has a continuing obligation to supplement these disclosures under Sec. 50-35 of the Code.

RETURN WITH BID

ILLINOIS DEPARTMENT OF TRANSPORTATION

Form B Other Contracts & Financial Related Information Disclosure

Contractor Name, Legal Address, City, State, Zip, Telephone Number, Email Address, Fax Number (if available)

Disclosure of the information contained in this Form is required by the Section 50-35 of the Code (30 ILCS 500). This information shall become part of the publicly available contract file. This Form B must be completed for bids in excess of \$25,000, and for all open-ended contracts.

DISCLOSURE OF OTHER CONTRACTS AND PROCUREMENT RELATED INFORMATION

1. Identifying Other Contracts & Procurement Related Information. The BIDDER shall identify whether it has any pending contracts (including leases), bids, proposals, or other ongoing procurement relationship with any other State of Illinois agency: Yes ___ No ___

If "No" is checked, the bidder only needs to complete the signature box on the bottom of this page.

2. If "Yes" is checked. Identify each such relationship by showing State of Illinois agency name and other descriptive information such as bid or project number (attach additional pages as necessary). SEE DISCLOSURE FORM INSTRUCTIONS:

THE FOLLOWING STATEMENT MUST BE CHECKED

Signature of Authorized Representative, Date

OWNERSHIP CERTIFICATION

Please certify that the following statement is true if the individuals for all submitted Form A disclosures do not total 100% of ownership.

Any remaining ownership interest is held by individuals receiving less than \$106,447.20 of the bidding entity's or parent entity's distributive income or holding less than a 5% ownership interest.

Yes No N/A (Form A disclosure(s) established 100% ownership)

RETURN WITH BID

SPECIAL NOTICE TO CONTRACTORS

The following requirements of the Illinois Department of Human Rights' Rules and Regulations are applicable to bidders on all construction contracts advertised by the Illinois Department of Transportation:

CONSTRUCTION EMPLOYEE UTILIZATION PROJECTION

- (a) All bidders on construction contracts shall complete and submit, along with and as part of their bids, a Bidder's Employee Utilization Form (Form BC-1256) setting forth a projection and breakdown of the total workforce intended to be hired and/or allocated to such contract work by the bidder including a projection of minority and female employee utilization in all job classifications on the contract project.
- (b) The Department of Transportation shall review the Employee Utilization Form, and workforce projections contained therein, of the contract awardee to determine if such projections reflect an underutilization of minority persons and/or women in any job classification in accordance with the Equal Employment Opportunity Clause and Section 7.2 of the Illinois Department of Human Rights' Rules and Regulations for Public Contracts adopted as amended on September 17, 1980. If it is determined that the contract awardee's projections reflect an underutilization of minority persons and/or women in any job classification, it shall be advised in writing of the manner in which it is underutilizing and such awardee shall be considered to be in breach of the contract unless, prior to commencement of work on the contract project, it submits revised satisfactory projections or an acceptable written affirmative action plan to correct such underutilization including a specific timetable geared to the completion stages of the contract.
- (c) The Department of Transportation shall provide to the Department of Human Rights a copy of the contract awardee's Employee Utilization Form, a copy of any required written affirmative action plan, and any written correspondence related thereto. The Department of Human Rights may review and revise any action taken by the Department of Transportation with respect to these requirements.

RETURN WITH BID



**Contract No. 46270
Various Counties
Section INT ATTRACT SIGN 2014-09
Various Routes
District TR Construction Funds**

PART I. IDENTIFICATION

Dept. Human Rights # _____ Duration of Project: _____

Name of Bidder: _____

PART II. WORKFORCE PROJECTION

A. The undersigned bidder has analyzed minority group and female populations, unemployment rates and availability of workers for the location in which this contract work is to be performed, and for the locations from which the bidder recruits employees, and hereby submits the following workforce projection including a projection for minority and female employee utilization in all job categories in the workforce to be allocated to this contract:

TABLE A

TOTAL Workforce Projection for Contract												
JOB CATEGORIES	TOTAL EMPLOYEES		MINORITY EMPLOYEES						TRAINEES			
			BLACK		HISPANIC		*OTHER MINOR.		APPREN- TICES		ON THE JOB TRAINEES	
	M	F	M	F	M	F	M	F	M	F	M	F
OFFICIALS (MANAGERS)												
SUPERVISORS												
FOREMEN												
CLERICAL												
EQUIPMENT OPERATORS												
MECHANICS												
TRUCK DRIVERS												
IRONWORKERS												
CARPENTERS												
CEMENT MASONS												
ELECTRICIANS												
PIPEFITTERS, PLUMBERS												
PAINTERS												
LABORERS, SEMI-SKILLED												
LABORERS, UNSKILLED												
TOTAL												

TABLE B

CURRENT EMPLOYEES TO BE ASSIGNED TO CONTRACT			
TOTAL EMPLOYEES		MINORITY EMPLOYEES	
M	F	M	F

TABLE C

TOTAL Training Projection for Contract								
EMPLOYEES IN TRAINING	TOTAL EMPLOYEES		BLACK		HISPANIC		*OTHER MINOR.	
	M	F	M	F	M	F	M	F
APPRENTICES								
ON THE JOB TRAINEES								

FOR DEPARTMENT USE ONLY

--

* Other minorities are defined as Asians (A) or Native Americans (N).
Please specify race of each employee shown in Other Minorities column.

Note: See instructions on page 2

RETURN WITH BID

**Contract No. 46270
Various Counties
Section INT ATTRACT SIGN 2014-09
Various Routes
District TR Construction Funds**

PART II. WORKFORCE PROJECTION - continued

- B. Included in "Total Employees" under Table A is the total number of **new hires** that would be employed in the event the undersigned bidder is awarded this contract.

The undersigned bidder projects that: (number) _____ new hires would be recruited from the area in which the contract project is located; and/or (number) _____ new hires would be recruited from the area in which the bidder's principal office or base of operation is located.

- C. Included in "Total Employees" under Table A is a projection of numbers of persons to be employed directly by the undersigned bidder as well as a projection of numbers of persons to be employed by subcontractors.

The undersigned bidder estimates that (number) _____ persons will be directly employed by the prime contractor and that (number) _____ persons will be employed by subcontractors.

PART III. AFFIRMATIVE ACTION PLAN

- A. The undersigned bidder understands and agrees that in the event the foregoing minority and female employee utilization projection included under **PART II** is determined to be an underutilization of minority persons or women in any job category, and in the event that the undersigned bidder is awarded this contract, he/she will, prior to commencement of work, develop and submit a written Affirmative Action Plan including a specific timetable (geared to the completion stages of the contract) whereby deficiencies in minority and/or female employee utilization are corrected. Such Affirmative Action Plan will be subject to approval by the contracting agency and the **Department of Human Rights**.
- B. The undersigned bidder understands and agrees that the minority and female employee utilization projection submitted herein, and the goals and timetable included under an Affirmative Action Plan if required, are deemed to be part of the contract specifications.

Company _____ Telephone Number _____

Address _____

NOTICE REGARDING SIGNATURE

The Bidder's signature on the Proposal Signature Sheet will constitute the signing of this form. The following signature block needs to be completed if revisions are required.

Signature: _____ Title: _____ Date: _____

- Instructions: All tables must include subcontractor personnel in addition to prime contractor personnel.
- Table A - Include both the number of employees that would be hired to perform the contract work and the total number currently employed (Table B) that will be allocated to contract work, and include all apprentices and on-the-job trainees. The "Total Employees" column should include all employees including all minorities, apprentices and on-the-job trainees to be employed on the contract work.
- Table B - Include all employees currently employed that will be allocated to the contract work including any apprentices and on-the-job trainees currently employed.
- Table C - Indicate the racial breakdown of the total apprentices and on-the-job trainees shown in Table A.

RETURN WITH BID
Contract No. 46270
Various Counties
Section INT ATTRACT SIGN 2014-09
Various Routes
District TR Construction Funds

PROPOSAL SIGNATURE SHEET

The undersigned bidder hereby makes and submits this bid on the subject Proposal, thereby assuring the Department that all requirements of the Invitation for Bids and rules of the Department have been met, that there is no misunderstanding of the requirements of paragraph 3 of this Proposal, and that the contract will be executed in accordance with the rules of the Department if an award is made on this bid.

(IF AN INDIVIDUAL)

Firm Name _____

Signature of Owner _____

Business Address _____

(IF A CO-PARTNERSHIP)

Firm Name _____

By _____

Business Address _____

Name and Address of All Members of the Firm:

(IF A CORPORATION)

Corporate Name _____

By _____

Signature of Authorized Representative

Typed or printed name and title of Authorized Representative

Attest _____

Signature

(IF A JOINT VENTURE, USE THIS SECTION FOR THE MANAGING PARTY AND THE SECOND PARTY SHOULD SIGN BELOW)

Business Address _____

(IF A JOINT VENTURE)

Corporate Name _____

By _____

Signature of Authorized Representative

Typed or printed name and title of Authorized Representative

Attest _____

Signature

Business Address _____

If more than two parties are in the joint venture, please attach an additional signature sheet.



Return with Bid

Division of Highways
Proposal Bid Bond
(Effective November 1, 1992)

Item No.
Letting Date

KNOW ALL MEN BY THESE PRESENTS, That We

as PRINCIPAL, and

as SURETY, are held jointly, severally and firmly bound unto the STATE OF ILLINOIS in the penal sum of 5 percent of the total bid price, or for the amount specified in the bid proposal under "Proposal Guaranty" in effect on the date of the Invitation for Bids, whichever is the lesser sum, well and truly to be paid unto said STATE OF ILLINOIS, for the payment of which we bind ourselves, our heirs, executors, administrators, successors and assigns.

THE CONDITION OF THE FOREGOING OBLIGATION IS SUCH, that whereas, the PRINCIPAL has submitted a bid proposal to the STATE OF ILLINOIS, acting through the Department of Transportation, for the improvement designated by the Transportation Bulletin Item Number and Letting Date indicated above.

NOW, THEREFORE, if the Department shall accept the bid proposal of the PRINCIPAL; and if the PRINCIPAL shall, within the time and as specified in the bidding and contract documents, submit a DBE Utilization Plan that is accepted and approved by the Department; and if, after award by the Department, the PRINCIPAL shall enter into a contract in accordance with the terms of the bidding and contract documents including evidence of the required insurance coverages and providing such bond as specified with good and sufficient surety for the faithful performance of such contract and for the prompt payment of labor and material furnished in the prosecution thereof; or if, in the event of the failure of the PRINCIPAL to make the required DBE submission or to enter into such contract and to give the specified bond, the PRINCIPAL pays to the Department the difference not to exceed the penalty hereof between the amount specified in the bid proposal and such larger amount for which the Department may contract with another party to perform the work covered by said bid proposal, then this obligation shall be null and void, otherwise, it shall remain in full force and effect.

IN THE EVENT the Department determines the PRINCIPAL has failed to comply with any requirement as set forth in the preceding paragraph, then Surety shall pay the penal sum to the Department within fifteen (15) days of written demand therefor. If Surety does not make full payment within such period of time, the Department may bring an action to collect the amount owed. Surety is liable to the Department for all its expenses, including attorney's fees, incurred in any litigation in which it prevails either in whole or in part.

In TESTIMONY WHEREOF, the said PRINCIPAL and the said SURETY have caused this instrument to be signed by their respective officers this day of A.D.,

PRINCIPAL SURETY
(Company Name) (Company Name)
By (Signature & Title) By: (Signature of Attorney-in-Fact)

Notary Certification for Principal and Surety

STATE OF ILLINOIS,
County of
I, a Notary Public in and for said County, do hereby certify that
and
(Insert names of individuals signing on behalf of PRINCIPAL & SURETY)

who are each personally known to me to be the same persons whose names are subscribed to the foregoing instrument on behalf of PRINCIPAL and SURETY, appeared before me this day in person and acknowledged respectively, that they signed and delivered said instrument as their free and voluntary act for the uses and purposes therein set forth.

Given under my hand and notarial seal this day of A.D.

My commission expires Notary Public

In lieu of completing the above section of the Proposal Bid Form, the Principal may file an Electronic Bid Bond. By signing the proposal and marking the check box next to the Signature and Title line below, the Principal is ensuring the identified electronic bid bond has been executed and the Principal and Surety are firmly bound unto the State of Illinois under the conditions of the bid bond as shown above.

Electronic Bid Bond ID# Company / Bidder Name Signature and Title

(1) Policy

It is public policy that disadvantageded businesses as defined in 49 CFR Part 26 and the Special Provision shall have the maximum opportunity to participate in the performance of contracts financed in whole or in part with Federal or State funds. Consequently the requirements of 49 CFR Part 26 apply to this contract.

(2) Obligation

The contractor agrees to ensure that disadvantageded businesses as defined in 49 CFR Part 26 and the Special Provision have the maximum opportunity to participate in the performance of contracts or subcontracts financed in whole or in part with Federal or State funds. The contractor shall take all necessary and reasonable steps in accordance with 49 CFR Part 26 and the Special Provision to ensure that said businesses have the maximum opportunity to compete for and perform under this contract. The contractor shall not discriminate on the basis of race, color, national origin or sex in the award and performance of contracts.

(3) Project and Bid Identification

Complete the following information concerning the project and bid:

Route _____	Total Bid _____
Section _____	Contract DBE Goal _____
Project _____	(Percent) (Dollar Amount)
County _____	
Letting Date _____	
Contract No. _____	
Letting Item No. _____	

(4) Assurance

I, acting in my capacity as an officer of the undersigned bidder (or bidders if a joint venture), hereby assure the Department that on this project my company : (check one)

Meets or exceeds contract award goals and has provided documented participation as follows:
Disadvantaged Business Participation _____ percent

Attached are the signed participation statements, forms SBE 2025, required by the Special Provision evidencing availability and use of each business participating in this plan and assuring that each business will perform a commercially useful function in the work of the contract.

Failed to meet contract award goals and has included good faith effort documentation to meet the goals and that my company has provided participation as follows:

Disadvantaged Business Participation _____ percent

The contract goals should be accordingly modified or waived. Attached is all information required by the Special Provision in support of this request including good faith effort. Also attached are the signed participation statements, forms SBE 2025, required by the Special Provision evidencing availability and use of each business participating in this plan and assuring that each business will perform a commercially useful function in the work of the contract.

_____ Company

By _____

Title _____

Date _____

The "as read" Low Bidder is required to comply with the Special Provision.

Submit only one utilization plan for each project. The utilization plan shall be submitted in accordance with the special provision.

Bureau of Small Business Enterprises 2300 South Dirksen Parkway Springfield, Illinois 62764	Local Let Projects Submit forms to the Local Agency
---------------------------------------------------------------------------------------------------	------------------------------------------------------------------



Illinois Department of Transportation

DBE Participation Statement

Subcontractor Registration _____

Letting _____

Participation Statement

Item No. _____

(1) Instructions

Contract _____

This form must be completed for each disadvantaged business participating in the Utilization Plan. This form shall be submitted in accordance with the special provision and will be attached to the Utilization Plan form. If additional space is needed complete an additional form for the firm.

(2) Work

Pay Item No.	Description	Quantity	Unit Price	Total
Total				

(3) Partial Payment Items

For any of the above items which are partial pay items, specifically describe the work and subcontract dollar amount:

(4) Commitment

The undersigned certify that the information included herein is true and correct, and that the DBE firm listed below has agreed to perform a commercially useful function in the work of the contract item(s) listed above and to execute a contract with the prime contractor. The undersigned further understand that no changes to this statement may be made without prior approval from the Department's Bureau of Small Business Enterprises and that complete and accurate information regarding actual work performed on this project and the payment therefore must be provided to the Department.

Signature for Prime Contractor

Signature for DBE Firm

Title _____

Title _____

Date _____

Date _____

Contact _____

Contact _____

Phone _____

Phone _____

Firm Name _____

Firm Name _____

Address _____

Address _____

City/State/Zip _____

City/State/Zip _____

E _____

WC _____

The Department of Transportation is requesting disclosure of information that is necessary to accomplish the statutory purpose as outlined under the state and federal law. Disclosure of this information is **REQUIRED**. Failure to provide any information will result in the contract not being awarded. This form has been approved by the State Forms Management Center.

PROPOSAL ENVELOPE



PROPOSALS

for construction work advertised for bids by the
Illinois Department of Transportation

Item No.	Item No.	Item No.

Submitted By:

Name:
Address:
Phone No.

Bidders should use an IDOT proposal envelope or affix this form to the front of a 10" x 13" envelope for the submittal of bids. If proposals are mailed, they should be enclosed in a second or outer envelope addressed to:

Engineer of Design and Environment - Room 326
Illinois Department of Transportation
2300 South Dirksen Parkway
Springfield, Illinois 62764

NOTICE

Individual bids, including Bid Bond and/or supplemental information if required, should be securely stapled.

CONTRACTOR OFFICE COPY OF CONTRACT SPECIFICATIONS

NOTICE

None of the following material needs to be returned with the bid package unless the special provisions require documentation and/or other information to be submitted.

Contract No. 46270
Various Counties
Section INT ATTRACT SIGN 2014-09
Various Routes
District TR Construction Funds



Illinois Department of Transportation

SUBCONTRACTOR DOCUMENTATION

Public Acts 96-0795, 96-0920, and 97-0895 enacted substantial changes to the provisions of the Code (30 ILCS 500). Among the changes are provisions affecting subcontractors. The Contractor awarded this contract will be required as a material condition of the contract to implement and enforce the contract requirements applicable to subcontractors that entered into a contractual agreement with a total value of \$50,000 or more with a person or entity who has a contract subject to the Code and approved in accordance with article 108.01 of the Standard Specifications for Road and Bridge Construction.

If the Contractor seeks approval of subcontractors to perform a portion of the work, and approval is granted by the Department, the Contractor shall provide a copy of the subcontract to the Illinois Department of Transportation's CPO upon request within 15 calendar days after execution of the subcontract.

Financial disclosures required pursuant to Sec. 50-35 of the Code must be submitted for all applicable subcontractors. The subcontract shall contain the certifications required to be made by subcontractors pursuant to Article 50 of the Code. This Notice to Bidders includes a document incorporating all required subcontractor certifications and disclosures for use by the Contractor in compliance with this mandate. The document is entitled State Required Ethical Standards Governing Subcontractors.

RETURN WITH SUBCONTRACT

STATE ETHICAL STANDARDS GOVERNING SUBCONTRACTORS

Article 50 of the Code establishes the duty of all State CPOs, SPOs, and their designees to maximize the value of the expenditure of public moneys in procuring goods, services, and contracts for the State of Illinois and to act in a manner that maintains the integrity and public trust of State government. In discharging this duty, they are charged by law to use all available information, reasonable efforts, and reasonable actions to protect, safeguard, and maintain the procurement process of the State of Illinois.

The certifications hereinafter made by the subcontractor are each a material representation of fact upon which reliance is placed should the Department approve the subcontractor. The CPO may terminate or void the contract approval if it is later determined that the bidder or subcontractor rendered a false or erroneous certification. If a false certification is made by a subcontractor the contractor's submitted bid and the executed contract may not be declared void unless the contractor refuses to terminate the subcontract upon the State's request after a finding that the subcontractor's certification was false.

Section 50-2 of the Code provides that every person that has entered into a multi-year contract and every subcontractor with a multi-year subcontract shall certify, by July 1 of each fiscal year covered by the contract after the initial fiscal year, to the responsible CPO whether it continues to satisfy the requirements of Article 50 pertaining to the eligibility for a contract award. If a contractor or subcontractor is not able to truthfully certify that it continues to meet all requirements, it shall provide with its certification a detailed explanation of the circumstances leading to the change in certification status. A contractor or subcontractor that makes a false statement material to any given certification required under Article 50 is, in addition to any other penalties or consequences prescribed by law, subject to liability under the Whistleblower Reward and Protection Act for submission of a false claim.

A. Bribery

1. The Code provides:

Section 50-5. Bribery.

(a) Prohibition. No person or business shall be awarded a contract or subcontract under this Code who:

(1) has been convicted under the laws of Illinois or any other state of bribery or attempting to bribe an officer or employee of the State of Illinois or any other state in that officer's or employee's official capacity; or

(2) has made an admission of guilt of that conduct that is a matter of record but has not been prosecuted for that conduct.

(b) Businesses. No business shall be barred from contracting with any unit of State or local government, or subcontracting under such a contract, as a result of a conviction under this Section of any employee or agent of the business if the employee or agent is no longer employed by the business and:

(1) the business has been finally adjudicated not guilty; or

(2) the business demonstrates to the governmental entity with which it seeks to contract, or which is signatory to the contract to which the subcontract relates, and that entity finds that the commission of the offense was not authorized, requested, commanded, or performed by a director, officer, or high managerial agent on behalf of the business as provided in paragraph (2) of subsection (a) of Section 5-4 of the Criminal Code of 1961.

(c) Conduct on behalf of business. For purposes of this Section, when an official, agent, or employee of a business committed the bribery or attempted bribery on behalf of the business and in accordance with the direction or authorization of a responsible official of the business, the business shall be chargeable with the conduct.

(d) Certification. Every bid submitted to and contract executed by the State, and every subcontract subject to Section 20-120 of the Code shall contain a certification by the contractor or the subcontractor, respectively, that the contractor or subcontractor is not barred from being awarded a contract or subcontract under this Section and acknowledges that the CPO may declare the related contract void if any certifications required by this Section are false. A contractor who makes a false statement, material to the certification, commits a Class 3 felony.

2. The contractor or subcontractor certifies that it is not barred from being awarded a contract under Section 50.5.

B. Felons

1. The Code provides:

Section 50-10. Felons. Unless otherwise provided, no person or business convicted of a felony shall do business with the State of Illinois or any State agency, or enter into a subcontract, from the date of conviction until 5 years after the date of completion of the sentence for that felony, unless no person held responsible by a prosecutorial office for the facts upon which the conviction was based continues to have any involvement with the business.

2. Certification. Every bid submitted to and contract executed by the State and every subcontract subject to Section 20-120 of the Code shall contain a certification by the bidder or contractor or subcontractor, respectively, that the bidder, contractor, or subcontractor is not barred from being awarded a contract or subcontract under this Section and acknowledges that the CPO may declare the related contract void if any of the certifications required by this Section are false.

RETURN WITH SUBCONTRACT

C. Debt Delinquency

1. The Code provides:

Section 50-11 and 50-12. Debt Delinquency.

The contractor or bidder or subcontractor, respectively, certifies that it, or any affiliate, is not barred from being awarded a contract or subcontract under the Code. Section 50-11 prohibits a person from entering into a contract with a State agency, or entering into a subcontract, if it knows or should know that it, or any affiliate, is delinquent in the payment of any debt to the State as defined by the Debt Collection Board. Section 50-12 prohibits a person from entering into a contract with a State agency, or entering into a subcontract, if it, or any affiliate, has failed to collect and remit Illinois Use Tax on all sales of tangible personal property into the State of Illinois in accordance with the provisions of the Illinois Use Tax Act. The bidder or contractor or subcontractor, respectively, further acknowledges that the CPO may declare the related contract void if this certification is false or if the bidder, contractor, or subcontractor, or any affiliate, is determined to be delinquent in the payment of any debt to the State during the term of the contract.

D. Prohibited Bidders, Contractors and Subcontractors

1. The Code provides:

Section 50-10.5 and 50-60(c). Prohibited bidders, contractors and subcontractors.

The bidder or contractor or subcontractor, respectively, certifies in accordance with 30 ILCS 500/50-10.5 that no officer, director, partner or other managerial agent of the contracting business has been convicted of a felony under the Sarbanes-Oxley Act of 2002 or a Class 3 or Class 2 felony under the Illinois Securities Law of 1953 or if in violation of Subsection (c) for a period of five years from the date of conviction. Every bid submitted to and contract executed by the State and every subcontract subject to Section 20-120 of the Code shall contain a certification by the bidder, contractor, or subcontractor, respectively, that the bidder, contractor, or subcontractor is not barred from being awarded a contract or subcontract under this Section and acknowledges that the CPO shall declare the related contract void if any of the certifications completed pursuant to this Section are false.

E. Section 42 of the Environmental Protection Act

The bidder or contractor or subcontractor, respectively, certifies in accordance with 30 ILCS 500/50-12 that the bidder, contractor, or subcontractor, is not barred from being awarded a contract or entering into a subcontract under this Section which prohibits the bidding on or entering into contracts with the State of Illinois or a State agency, or entering into any subcontract, that is subject to the Code by a person or business found by a court or the Pollution Control Board to have committed a willful or knowing violation of Section 42 of the Environmental Protection Act for a period of five years from the date of the order. The bidder or contractor or subcontractor, respectively, acknowledges that the CPO may declare the contract void if this certification is false.

The undersigned, on behalf of the subcontracting company, has read and understands the above certifications and makes the certifications as required by law.

Name of Subcontracting Company

Authorized Officer

Date

RETURN WITH SUBCONTRACT
SUBCONTRACTOR DISCLOSURES

I. DISCLOSURES

- A.** The disclosures hereinafter made by the subcontractor are each a material representation of fact upon which reliance is placed. The subcontractor further certifies that the Department has received the disclosure forms for each subcontract.

The CPO may void the bid, contract, or subcontract, respectively, if it is later determined that the bidder or subcontractor rendered a false or erroneous disclosure. A contractor or subcontractor may be suspended or debarred for violations of the Code. Furthermore, the CPO may void the contract.

B. Financial Interests and Conflicts of Interest

1. Section 50-35 of the Code provides that all subcontracts with a total value of \$50,000 or more from subcontractors identified in Section 20-120 of the Code, shall be accompanied by disclosure of the financial interests of the subcontractor. This disclosed information for the subcontractor, will be maintained as public information subject to release by request pursuant to the Freedom of Information Act, filed with the Procurement Policy Board, and shall be incorporated as a material term of the Prime Contractor's contract. Furthermore, pursuant to this Section, the Procurement Policy Board may recommend to allow or void a contract or subcontract based on a potential conflict of interest.

The financial interests to be disclosed shall include ownership or distributive income share that is in excess of 5%, or an amount greater than 60% of the annual salary of the Governor, of the subcontracting entity or its parent entity, whichever is less, unless the subcontractor is a publicly traded entity subject to Federal 10K reporting, in which case it may submit its 10K disclosure in place of the prescribed disclosure. If a subcontractor is a privately held entity that is exempt from Federal 10K reporting, but has more than 200 shareholders, it may submit the information that Federal 10K companies are required to report, and list the names of any person or entity holding any ownership share that is in excess of 5%. The disclosure shall include the names, addresses, and dollar or proportionate share of ownership of each person making the disclosure, their instrument of ownership or beneficial relationship, and notice of any potential conflict of interest resulting from the current ownership or beneficial interest of each person making the disclosure having any of the relationships identified in Section 50-35 and on the disclosure form.

The current annual salary of the Governor is \$177,412.00.

In addition, all disclosures shall indicate any other current or pending contracts, subcontracts, proposals, leases, or other ongoing procurement relationships the subcontracting entity has with any other unit of state government and shall clearly identify the unit and the contract, subcontract, proposal, lease, or other relationship.

2. Disclosure Forms. Disclosure Form A is attached for use concerning the individuals meeting the above ownership or distributive share requirements. A separate Disclosure Form A must be submitted with the bid for each individual meeting the above requirements. In addition, a second form (Disclosure Form B) provides for the disclosure of current or pending procurement relationships with other (non-IDOT) state agencies and a total ownership certification. **The forms must be included with each bid.**

C. Disclosure Form Instructions

Form A Instructions for Financial Information & Potential Conflicts of Interest

If the subcontractor is a publicly traded entity subject to Federal 10K reporting, the 10K Report may be submitted to meet the requirements of Form A. If a subcontractor is a privately held entity that is exempt from Federal 10K reporting, but has more than 200 shareholders, it may submit the information that Federal 10K companies are required to report, and list the names of any person or entity holding any ownership share that is in excess of 5%. If a subcontractor is not subject to Federal 10K reporting, the subcontractor must determine if any individuals are required by law to complete a financial disclosure form. To do this, the subcontractor should answer each of the following questions. A "YES" answer indicates Form A must be completed. If the answer to each of the following questions is "NO", then the **NOT APPLICABLE STATEMENT** on the second page of Form A must be signed and dated by a person that is authorized to execute contracts for the subcontracting company. Note: These questions are for assistance only and are not required to be completed.

1. Does anyone in your organization have a direct or beneficial ownership share of greater than 5% of the bidding entity or parent entity? YES ___ NO ___
2. Does anyone in your organization have a direct or beneficial ownership share of less than 5%, but which has a value greater than 60% of the annual salary of the Governor? YES ___ NO ___
3. Does anyone in your organization receive more than 60% of the annual salary of the Governor of the subcontracting entity's or parent entity's distributive income? YES ___ NO ___

(Note: Distributive income is, for these purposes, any type of distribution of profits. An annual salary is not distributive income.)

4. Does anyone in your organization receive greater than 5% of the subcontracting entity's or parent entity's total distributive income, but which is less than 60% of the annual salary of the Governor? YES ___ NO ___

(Note: Only one set of forms needs to be completed per person per subcontract even if a specific individual would require a yes answer to more than one question.)

A "YES" answer to any of these questions requires the completion of Form A. The subcontractor must determine each individual in the subcontracting entity or the subcontracting entity's parent company that would cause the questions to be answered "Yes". Each form must be signed and dated by a person that is authorized to execute contracts for your organization. **Photocopied or stamped signatures are not acceptable.** The person signing can be, but does not have to be, the person for which the form is being completed. The subcontractor is responsible for the accuracy of any information provided.

If the answer to each of the above questions is "NO", then the **NOT APPLICABLE STATEMENT** on page 2 of Form A must be signed and dated by a person that is authorized to execute contracts for your company.

RETURN WITH SUBCONTRACT

Form B: Instructions for Identifying Other Contracts & Procurement Related Information

Disclosure Form B must be completed for each subcontract submitted by the subcontracting entity. *Note: Checking the NOT APPLICABLE STATEMENT on Form A does not allow the subcontractor to ignore Form B. Form B must be completed, checked, and dated or the subcontract will not be approved.*

The Subcontractor shall identify, by checking Yes or No on Form B, whether it has any pending contracts, subcontracts, leases, bids, proposals, or other ongoing procurement relationship with any other (non-IDOT) State of Illinois agency. If "No" is checked, the subcontractor only needs to complete the check box on the bottom of Form B. If "Yes" is checked, the subcontractor must list all non-IDOT State of Illinois agency pending contracts, subcontracts, leases, bids, proposals, and other ongoing procurement relationships. These items may be listed on Form B or on an attached sheet(s). Contracts with cities, counties, villages, etc. are not considered State of Illinois agency contracts and are not to be included. Contracts or subcontracts with other State of Illinois agencies such as the Department of Natural Resources or the Capital Development Board must be included.

RETURN WITH SUBCONTRACT

**ILLINOIS DEPARTMENT
OF TRANSPORTATION**

**Form A
Subcontractor: Financial
Information & Potential Conflicts
of Interest Disclosure**

Subcontractor Name		
Legal Address		
City, State, Zip		
Telephone Number	Email Address	Fax Number (if available)

Disclosure of the information contained in this Form is required by the Section 50-35 of the Code (30 ILCS 500). Subcontractors desiring to enter into a subcontract of a State of Illinois contract must disclose the financial information and potential conflict of interest information as specified in this Disclosure Form. This information shall become part of the publicly available contract file. This Form A must be completed for subcontracts with a total value of \$50,000 or more, from subcontractors identified in Section 20-120 of the Code, and for all open-ended contracts. **A publicly traded company may submit a 10K disclosure (or equivalent if applicable) in satisfaction of the requirements set forth in Form A. See Disclosure Form Instructions.**

The current annual salary of the Governor is \$177,412.00.

DISCLOSURE OF FINANCIAL INFORMATION

1. Disclosure of Financial Information. The individual named below has an interest in the SUBCONTRACTOR (or its parent) in terms of ownership or distributive income share in excess of 5%, or an interest which has a value of more than 60% of the annual salary of the Governor. **(Make copies of this form as necessary and attach a separate Disclosure Form A for each individual meeting these requirements)**

FOR INDIVIDUAL (type or print information)	
NAME:	_____
ADDRESS	_____
Type of ownership/distributable income share:	
stock _____ sole proprietorship _____ Partnership _____ other: (explain on separate sheet):	
% or \$ value of ownership/distributable income share:	_____

2. Disclosure of Potential Conflicts of Interest. Check "Yes" or "No" to indicate which, if any, of the following potential conflict of interest relationships apply. If the answer to any question is "Yes", please attach additional pages and describe.

(a) State employment, currently or in the previous 3 years, including contractual employment of services.

Yes ___ No ___

If your answer is yes, please answer each of the following questions.

1. Are you currently an officer or employee of either the Capitol Development Board or the Illinois State Toll Highway Authority? Yes ___ No ___

2. Are you currently appointed to or employed by any agency of the State of Illinois? If you are currently appointed to or employed by any agency of the State of Illinois, and your annual salary exceeds 60% of the annual salary of the Governor, provide the name the State agency for which you are employed and your annual salary. _____

RETURN WITH SUBCONTRACT

3. If you are currently appointed to or employed by any agency of the State of Illinois, and your annual salary exceeds 60% of the annual salary of the Governor, are you entitled to receive (i) more than 7 1/2% of the total distributable income of your firm, partnership, association or corporation, or (ii) an amount in excess of 100% of the annual salary of the Governor?
Yes ___ No ___

4. If you are currently appointed to or employed by any agency of the State of Illinois, and your annual salary exceeds 60% of the annual salary of the Governor, are you and your spouse or minor children entitled to receive (i) more than 15 % in the aggregate of the total distributable income of your firm, partnership, association or corporation, or (ii) an amount in excess of two times the salary of the Governor?
Yes ___ No ___

(b) State employment of spouse, father, mother, son, or daughter, including contractual employment services in the previous 2 years.

Yes ___ No ___

If your answer is yes, please answer each of the following questions.

1. Is your spouse or any minor children currently an officer or employee of the Capitol Development Board or the Illinois Toll Highway Authority?
Yes ___ No ___

2. Is your spouse or any minor children currently appointed to or employed by any agency of the State of Illinois? If your spouse or minor children is/are currently appointed to or employed by any agency of the State of Illinois, and his/her annual salary exceeds 60% of the annual salary of the Governor, provide the name of your spouse and/or minor children, the name of the State agency for which he/she is employed and his/her annual salary. _____

3. If your spouse or any minor children is/are currently appointed to or employed by any agency of the State of Illinois, and his/her annual salary exceeds 60% of the annual salary of the Governor, as of 7/1/07) are you entitled to receive (i) more then 7 1/2% of the total distributable income of your firm, partnership, association or corporation, or (ii) an amount in excess of 100% of the annual salary of the Governor?
Yes ___ No ___

4. If your spouse or any minor children are currently appointed to or employed by any agency of the State of Illinois, and his/her annual salary exceeds 60% of the annual salary of the Governor, are you and your spouse or minor children entitled to receive (i) more than 15 % in the aggregate of the total distributable income of your firm, partnership, association or corporation, or (ii) an amount in excess of two times the annual salary of the Governor?
Yes ___ No ___

(c) Elective status; the holding of elective office of the State of Illinois, the government of the United States, any unit of local government authorized by the Constitution of the State of Illinois or the statutes of the State of Illinois currently or in the previous 3 years.
Yes ___ No ___

(d) Relationship to anyone holding elective office currently or in the previous 2 years; spouse, father, mother, son, or daughter.
Yes ___ No ___

(e) Appointive office; the holding of any appointive government office of the State of Illinois, the United States of America, or any unit of local government authorized by the Constitution of the State of Illinois or the statutes of the State of Illinois, which office entitles the holder to compensation in excess of the expenses incurred in the discharge of that office currently or in the previous 3 years.
Yes ___ No ___

(f) Relationship to anyone holding appointive office currently or in the previous 2 years; spouse, father, mother, son, or daughter.
Yes ___ No ___

(g) Employment, currently or in the previous 3 years, as or by any registered lobbyist of the State government.
Yes ___ No ___

RETURN WITH SUBCONTRACT

(h) Relationship to anyone who is or was a registered lobbyist in the previous 2 years; spouse, father, mother, son, or daughter. Yes ___ No ___

(i) Compensated employment, currently or in the previous 3 years, by any registered election or reelection committee registered with the Secretary of State or any county clerk of the State of Illinois, or any political action committee registered with either the Secretary of State or the Federal Board of Elections. Yes ___ No ___

(j) Relationship to anyone; spouse, father, mother, son, or daughter; who was a compensated employee in the last 2 years by any registered election or re-election committee registered with the Secretary of State or any county clerk of the State of Illinois, or any political action committee registered with either the Secretary of State or the Federal Board of Elections. Yes ___ No ___

3 Communication Disclosure.

Disclose the name and address of each lobbyist and other agent of the bidder or offeror who is not identified in Section 2 of this form, who is has communicated, is communicating, or may communicate with any State officer or employee concerning the bid or offer. This disclosure is a continuing obligation and must be promptly supplemented for accuracy throughout the process and throughout the term of the contract. If no person is identified, enter "None" on the line below:

Name and address of person(s): _____

RETURN WITH SUBCONTRACT

4. Debarment Disclosure. For each of the persons identified under Sections 2 and 3 of this form, disclose whether any of the following has occurred within the previous 10 years: debarment from contracting with any governmental entity; professional licensure discipline; bankruptcies; adverse civil judgments and administrative findings; and criminal felony convictions. This disclosure is a continuing obligation and must be promptly supplemented for accuracy throughout the procurement process and term of the contract. If no person is identified, enter "None" on the line below:

Name of person(s): _____

Nature of disclosure: _____

APPLICABLE STATEMENT

This Disclosure Form A is submitted on behalf of the INDIVIDUAL named on previous page. Under penalty of perjury, I certify the contents of this disclosure to be true and accurate to the best of my knowledge.

Completed by: _____ Date _____
Signature of Individual or Authorized Officer

NOT APPLICABLE STATEMENT

Under penalty of perjury, I have determined that no individuals associated with this organization meet the criteria that would require the completion of this Form A.

This Disclosure Form A is submitted on behalf of the SUBCONTRACTOR listed on the previous page.

_____ Date _____
Signature of Authorized Officer

RETURN WITH SUBCONTRACT

ILLINOIS DEPARTMENT OF TRANSPORTATION

Form B
Subcontractor: Other Contracts & Financial Related Information Disclosure

Form with fields: Subcontractor Name, Legal Address, City, State, Zip, Telephone Number, Email Address, Fax Number (if available)

Disclosure of the information contained in this Form is required by the Section 50-35 of the Code (30 ILCS 500). This information shall become part of the publicly available contract file. This Form B must be completed for subcontracts with a total value of \$50,000 or more, from subcontractors identified in Section 20-120 of the Code, and for all open-ended contracts.

DISCLOSURE OF OTHER CONTRACTS, SUBCONTRACTS, AND PROCUREMENT RELATED INFORMATION

1. Identifying Other Contracts & Procurement Related Information. The SUBCONTRACTOR shall identify whether it has any pending contracts, subcontracts, including leases, bids, proposals, or other ongoing procurement relationship with any other State of Illinois agency: Yes ___ No ___

If "No" is checked, the subcontractor only needs to complete the signature box on the bottom of this page.

2. If "Yes" is checked. Identify each such relationship by showing State of Illinois agency name and other descriptive information such as bid or project number (attach additional pages as necessary). SEE DISCLOSURE FORM INSTRUCTIONS:

THE FOLLOWING STATEMENT MUST BE CHECKED

Signature box with fields: Signature of Authorized Representative, Date

OWNERSHIP CERTIFICATION

Please certify that the following statement is true if the individuals for all submitted Form A disclosures do not total 100% of ownership

Any remaining ownership interest is held by individuals receiving less than \$106,447.20 of the bidding entity's or parent entity's distributive income or holding less than a 5% ownership interest.

Yes No N/A (Form A disclosure(s) established 100% ownership)



NOTICE TO BIDDERS

- 1. TIME AND PLACE OF OPENING BIDS.** Sealed proposals for the improvement described herein will be received by the Department of Transportation at the Harry R. Hanley Building, 2300 South Dirksen Parkway, in Springfield, Illinois until 10:00 o'clock a.m., June 14, 2013. All bids will be gathered, sorted, publicly opened and read in the auditorium at the Department of Transportation's Harry R. Hanley Building shortly after the 10:00 a.m. cut off time.
- 2. DESCRIPTION OF WORK.** The proposed improvement is identified and advertised for bids in the Invitation for Bids as:

**Contract No. 46270
Various Counties
Section INT ATTRACT SIGN 2014-09
Various Routes
District TR Construction Funds**

This project consists of installing or replacing signage and supports at various locations as described in work orders.

- 3. INSTRUCTIONS TO BIDDERS.** (a) This Notice, the invitation for bids, proposal and letter of award shall, together with all other documents in accordance with Article 101.09 of the Standard Specifications for Road and Bridge Construction, become part of the contract. Bidders are cautioned to read and examine carefully all documents, to make all required inspections, and to inquire or seek explanation of the same prior to submission of a bid.

(b) State law, and, if the work is to be paid wholly or in part with Federal-aid funds, Federal law requires the bidder to make various certifications as a part of the proposal and contract. By execution and submission of the proposal, the bidder makes the certification contained therein. A false or fraudulent certification shall, in addition to all other remedies provided by law, be a breach of contract and may result in termination of the contract.
- 4. AWARD CRITERIA AND REJECTION OF BIDS.** This contract will be awarded to the lowest responsive and responsible bidder considering conformity with the terms and conditions established by the Department in the rules, Invitation for Bids and contract documents. The issuance of plans and proposal forms for bidding based upon a prequalification rating shall not be the sole determinant of responsibility. The Department reserves the right to determine responsibility at the time of award, to reject any or all proposals, to readvertise the proposed improvement, and to waive technicalities.

By Order of the
Illinois Department of Transportation

Ann L. Schneider,
Secretary

INDEX
FOR
SUPPLEMENTAL SPECIFICATIONS
AND RECURRING SPECIAL PROVISIONS

Adopted January 1, 2013

This index contains a listing of SUPPLEMENTAL SPECIFICATIONS, frequently used RECURRING SPECIAL PROVISIONS, and LOCAL ROADS AND STREETS RECURRING SPECIAL PROVISIONS.

ERRATA Standard Specifications for Road and Bridge Construction (Adopted 1-1-12) (Revised 1-1-13)

SUPPLEMENTAL SPECIFICATIONS

<u>Std. Spec. Sec.</u>	<u>Page No.</u>
105 Control of Work	1
107 Legal Regulations and Responsibility to Public	2
202 Earth and Rock Excavation	4
211 Topsoil and Compost	5
407 Hot-Mix Asphalt Pavement (Full-Depth)	6
420 Portland Cement Concrete Pavement	10
424 Portland Cement Concrete Sidewalk	12
503 Concrete Structures	13
504 Precast Concrete Structures	14
540 Box Culverts	15
603 Adjusting Frames and Grates of Drainage and Utility Structures	16
610 Shoulder Inlets with Curb	18
642 Shoulder Rumble Strips	19
643 Impact Attenuators	20
701 Work Zone Traffic Control and Protection	22
706 Impact Attenuators, Temporary	24
780 Pavement Striping	26
860 Master Controller	27
1006 Metals	28
1042 Precast Concrete Products	29
1073 Controller	30
1083 Elastomeric Bearings	31
1101 General Equipment	32
1106 Work Zone Traffic Control Devices	34

RECURRING SPECIAL PROVISIONS

The following RECURRING SPECIAL PROVISIONS indicated by an "X" are applicable to this contract and are included by reference:

<u>CHECK SHEET #</u>		<u>PAGE NO.</u>
1	Additional State Requirements for Federal-Aid Construction Contracts (Eff. 2-1-69) (Rev. 1-1-10)	35
2	Subletting of Contracts (Federal-Aid Contracts) (Eff. 1-1-88) (Rev. 5-1-93)	38
3	X EEO (Eff. 7-21-78) (Rev. 11-18-80)	39
4	X Specific Equal Employment Opportunity Responsibilities Non Federal-Aid Contracts (Eff. 3-20-69) (Rev. 1-1-94)	49
5	X Required Provisions - State Contracts (Eff. 4-1-65) (Rev. 1-1-13)	54
6	Asbestos Bearing Pad Removal (Eff. 11-1-03)	59
7	Asbestos Waterproofing Membrane and Asbestos Hot-Mix Asphalt Surface Removal (Eff. 6-1-89) (Rev. 1-1-09)	60
8	Haul Road Stream Crossings, Other Temporary Stream Crossings, and In-Stream Work Pads (Eff. 1-2-92) (Rev. 1-1-98)	61
9	Construction Layout Stakes Except for Bridges (Eff. 1-1-99) (Rev. 1-1-07)	62
10	Construction Layout Stakes (Eff. 5-1-93) (Rev. 1-1-07)	65
11	Use of Geotextile Fabric for Railroad Crossing (Eff. 1-1-95) (Rev. 1-1-07)	68
12	Subsealing of Concrete Pavements (Eff. 11-1-84) (Rev. 1-1-07)	70
13	Hot-Mix Asphalt Surface Correction (Eff. 11-1-87) (Rev. 1-1-09)	74
14	Pavement and Shoulder Resurfacing (Eff. 2-1-00) (Rev. 1-1-09)	76
15	PCC Partial Depth Hot-Mix Asphalt Patching (Eff. 1-1-98) (Rev. 1-1-07)	77
16	Patching with Hot-Mix Asphalt Overlay Removal (Eff. 10-1-95) (Rev. 1-1-07)	79
17	Polymer Concrete (Eff. 8-1-95) (Rev. 1-1-08)	80
18	PVC Pipeliner (Eff. 4-1-04) (Rev. 1-1-07)	82
19	Pipe Underdrains (Eff. 9-9-87) (Rev. 1-1-07)	83
20	Guardrail and Barrier Wall Delineation (Eff. 12-15-93) (Rev. 1-1-12)	84
21	Bicycle Racks (Eff. 4-1-94) (Rev. 1-1-12)	88
22	Temporary Modular Glare Screen System (Eff. 1-1-00) (Rev. 1-1-07)	90
23	Temporary Portable Bridge Traffic Signals (Eff. 8-1-03) (Rev. 1-1-07)	92
24	Work Zone Public Information Signs (Eff. 9-1-02) (Rev. 1-1-07)	94
25	Night Time Inspection of Roadway Lighting (Eff. 5-1-96)	95
26	English Substitution of Metric Bolts (Eff. 7-1-96)	96
27	English Substitution of Metric Reinforcement Bars (Eff. 4-1-96) (Rev. 1-1-03)	97
28	Calcium Chloride Accelerator for Portland Cement Concrete (Eff. 1-1-01) (Rev. 1-1-13)	98
29	Portland Cement Concrete Inlay or Overlay for Pavements (Eff. 11-1-08) (Rev. 1-1-13)	99
30	Quality Control of Concrete Mixtures at the Plant (Eff. 8-1-00) (Rev. 1-1-11)	102
31	Quality Control/Quality Assurance of Concrete Mixtures (Eff. 4-1-92) (Rev. 1-1-11)	110
32	Digital Terrain Modeling for Earthwork Calculations (Eff. 4-1-07)	122

TABLE OF CONTENTS

LOCATION OF IMPROVEMENT	1
COMPLETION DATE.....	1
DESCRIPTION OF IMPROVEMENTS.....	1
WORK ORDERS.....	1
FAILURE TO COMPLETE A WORK ORDER ON TIME	2
QUANTITIES.....	2
REIMBURSEMENT FROM THIRD PARTY FOR REPAIRS OR DAMAGES	3
LOCATING UNDERGROUND CABLE	3
FINAL CLEANING UP	3
TRAFFIC CONTROL AND PROTECTION.....	3
FURNISH AND ERECT SIGN PANEL – LOGO	4
INSTALL SERVICE SIGN OR MILEAGE PLATE.....	5
REMOVE SERVICE SIGN OR MILEAGE PLATE.....	6
TRANSFER SERVICE SIGNS	6
REMOVE AND REINSTALL SIGN PANEL	6
REMOVE EXISTING SIGN PANEL	7
REMOVE EXISTING SIGN COMPLETE.....	7
REMOVE EXISTING SIGN SUPPORT	7
CONCRETE FOUNDATIONS FOR SIGN SUPPORTS	8
REMOVE CONCRETE FOUNDATIONS.....	8
ANCHOR BOLTS (BDE)	9
CONCRETE MIX DESIGN – DEPARTMENT PROVIDED (BDE)	9
DISADVANTAGED BUSINESS ENTERPRISE PARTICIPATION (BDE)	10
LIQUIDATED DAMAGES (BDE)	19
PAYMENTS TO SUBCONTRACTORS (BDE).....	20
PLACING AND CONSOLIDATING CONCRETE (BDE).....	21
PORTLAND CEMENT CONCRETE (BDE).....	23
REMOVAL AND DISPOSAL OF REGULATED SUBSTANCES (BDE)	63
REMOVAL AND DISPOSAL OF SURPLUS MATERIALS (BDE)	67
SUBCONTRACTOR MOBILIZATION PAYMENTS (BDE).....	68
TRACKING THE USE OF PESTICIDES (BDE)	68
TRAFFIC CONTROL DEFICIENCY DEDUCTION (BDE).....	68
UTILITY COORDINATION AND CONFLICTS (BDE)	69
WEEKLY DBE TRUCKING REPORTS (BDE)	74
STEEL COST ADJUSTMENT (BDE) (RETURN FORM WITH BID)	75

STATE OF ILLINOIS

SPECIAL PROVISIONS

The following Special Provisions supplement the “Standard Specifications for Road and Bridge Construction, Adopted January 1, 2012, the latest edition of the “Manual on Uniform Traffic Control Devices for Streets and Highways”, and the “Manual of Test Procedures for Materials” in effect on the date of invitation for bids, and the “Supplemental Specifications and Recurring Special Provisions” indicated on the Check Sheet included herein, which apply to and govern the construction of Various Routes, Section INT ATTRACT SIGN 2014-09, in Various Counties, Contract, Contract 46270 and in case of conflict with any part, or parts, of said Specifications, the said Special Provisions shall take precedence and shall govern.

LOCATION OF IMPROVEMENT

The work to be done under this contract will be on interstate routes throughout the State, although work may be required to be done on other State-maintained highways at various locations.

COMPLETION DATE

All work on this contract shall be completed on or before December 31, 2016. Should the Contractor fail to complete all work by December 31, 2016, the Contractor shall be liable in accordance with Article 108.09 with of the Standard Specifications.

DESCRIPTION OF IMPROVEMENTS

The work shall consist of installing or replacing tourist attraction or business logo signs, guide signs and supports at locations described in a work order.

WORK ORDERS

No work of any kind is to be performed by the Contractor, unless a work order authorizing work has been issued by the Engineer. A work order will show the date of issue, job number, location, code number(s), pay item(s), quantity of such pay item, and total cost. A work order will normally indicate the amount of work required to complete the attraction signing required for an interstate interchange. Only the amount of work shown on the work order is to be done by the Contractor. The Contractor shall notify the District Contact at least 72 hours before beginning any work in the field and shall obtain permission to begin such work.

It shall be the contractor’s responsibility to verify all dimensions and conditions existing in the field prior to construction and ordering materials.

Some work orders may require that the Contractor complete the work outlined in the work order during a district's night-time hours.

The Contractor shall complete all the work required on a work order within **90 days** after the date of issue of the work order or its revision unless otherwise extended in the work order or agreed in writing between the Contractor and the Engineer.

For the purpose of completing work orders a day shall be defined as any day on the calendar. No days shall be charged under the following conditions:

- (a) When adverse weather at the field work site prevents work on the controlling item of a work order.
- (b) When job conditions at the field work site due to recent weather conditions prevent work on the controlling item of a work order.
- (c) When work has been suspended by an act or omission of the Department or the Engineer.

FAILURE TO COMPLETE A WORK ORDER ON TIME

Should the Contractor fail to complete a work order on time, or such extended time as may have been allowed by the Department, a monetary deduction equal to \$75.00 per day per work order will be applied to monies due or that may become due the Contractor.

For the purpose of calculating the monetary deduction, a day shall be any day (or portion of) excluding the following.

- (a) When adverse weather at the field work site prevents work on the controlling item of a work order.
- (b) When job conditions at the field work site due to recent weather conditions prevent work on the controlling item of a work order.
- (c) When work on the controlling item has been suspended by an act or omission by the Department or Engineer.

QUANTITIES

The quantities specified in this contract indicate the estimated amount of work required for the duration of the contract. This is merely an estimate to allow Contractors to establish unit prices and permit the Department to determine the low bidder. It shall be understood that the unit prices of this contract shall prevail throughout the period of this contract regardless of the quantity.

REIMBURSEMENT FROM THIRD PARTY FOR REPAIRS OR DAMAGES

The Department reserves the right to make recovery from Third Party or Parties for damage to any part of the existing installations and no part of such recovery or recoveries shall inure to the benefit of the Contractor.

To enable the Department to assess damages against said Third Party or Parties, the Contractor shall, upon request, furnish the Engineer an itemized statement of the cost of any repairs to Third Party damage, separating the cost of labor, materials, and equipment.

LOCATING UNDERGROUND CABLE

At those locations, where concrete foundations are to be installed, **the Contractor shall notify the District Contact at least 72 hours before beginning any work in the field. The Contractor shall request that the Department locate and mark all underground electric cable owned and maintained by the Department which may be in conflict with the construction operations.** In the event the Contractor fails to notify the District Contact and cable is damaged, the Contractor shall replace the entire length of cable or conductors in conduit, in a manner satisfactory to the District Contact, at his/her own expense. Splicing below grade will not be permitted.

FINAL CLEANING UP

The final cleaning up shall conform to the requirements set forth in Article 104.06. Each time the Contractor accomplishes work at any location, he will be required to clean up the work area before payment for that work will be submitted.

All costs due to compliance with this Special Provision will be included in pay items of the contract and no additional compensation will be allowed.

TRAFFIC CONTROL AND PROTECTION

The Contractor shall arrange his work in such a manner so as to keep interruptions to traffic flow at a minimum.

Traffic control and protection shall conform to Article 107.09 and Section 701 and to the following standards as required by the Engineer.

Standards 701006, 701101, 701106, 701201, 701301, 701400, 701401, 701406, 701411, 701426, 701901

Conformance to the traffic control and protection standards will not be paid for separately, but shall be included in the contract lump sum price for TRAFFIC CONTROL AND PROTECTION, (SPECIAL).

FURNISH AND ERECT SIGN PANEL – LOGO

This work shall consist of furnishing and erecting extruded sign panels, complete with reflectorized sign face, legend, and supplemental panels or plates, on existing sign supports for tourist attraction, and logo signing along the Interstate. Typical layouts and sign designs are shown in the plans. Specific details and locations will be described in the work order(s).

The aluminum extrusions and the installation shall be in accordance to the requirements of Section 1090 of the Standard Specification, as shown on the plans and/or as directed by the Engineer.

All sign sheeting used on this contract shall be in accordance with the requirements of Section 1091.

All Type III reflectorized signs, supplemental signs and supplemental panels shall be fabricated using faces and legend of Type ZZ retroreflective sheeting. This shall include mainline and ramp signs. All remaining signing shall be fabricated using a background material of Type AP retroreflective sheeting. All signs shall be fabricated such that the copy or text and background material is applied in the preferred orientation for the maximum retroreflectivity per the manufacturer's recommendation.

No nesting of legend copy will be permitted. Background sheeting and legend shall be provided by the same manufacturer.

This specification shall apply to all colors of sheeting used in this contract except for blue and brown. Signs fabricated with blue and brown sheeting shall use Type AP sheeting for the background material with the border and legend material of Type ZZ reflective sheeting.

The supplemental business panels and mileage plates will be furnished by others and made available to the Contractor at the appropriate District Sign Shop or at a location agreed upon by the Contractor and Engineer. The supplemental panels and plates will be riveted onto the main sign panel as shown in the work order(s). In addition to the holes in the sign panel, necessary to install the supplemental panels and plates, the Contractor shall also drill the upper left hole for all other possible supplemental business panels. (This is to facilitate spacing of future business panels).

The attraction sign designs will be similar in design to the sample logo signs included in the plans. This work may also include the design and fabrication of state park signs, the fabrication and replacement of guide signs in order to accommodate the

Installation of the tourist attraction and state park signs. Each individual work order will include the appropriate sign design for each location.

This work will be measured for payment in square feet from edge-to-edge (horizontally and vertically).

The Contractor shall package all signs so as to prevent damage during shipment.

This work will be paid, for at the contract unit price per square foot, for SIGN PANEL – TYPE 3. This price shall include, furnishing and installing all materials, including demountable borders and arrows, fabricating the sign panel (including sign face and sign legend), and furnishing all mounting hardware, installing all supplemental business panels and mileage plates and installing the sign panel on previously erected sign supports and removing any existing sign panel as required for the proper installation of the new panel. Removal of any existing sign panel(s) will be paid for in accordance with REMOVE EXISTING SIGN PANEL.

The steel supports and concrete foundations for sign panels will be paid for under STRUCTURAL STEEL SIGN SUPPORT-BREAKAWAY and CONCRETE FOUNDATIONS respectively.

INSTALL SERVICE SIGN OR MILEAGE PLATE

This work shall consist of installing a service plate advertising gas, food, lodging camping or tourist attraction business service establishment or a mileage plate **on a previously erected business service panel**. The service plates are fabricated from flat sheet aluminum and will be furnished predrilled by the business establishments and made available to the Contractor at the District Sign Shop where work is being performed or at such other location agreed upon by the Engineer and the Contractor.

Mileage plates are fabricated from flat sheet aluminum and will be furnished predrilled by the District Sign Shop and made available to the Contractor at the District Sign Shop where work is being performed or at such other location agreed upon by the Engineer and the Contractor.

The plates shall be installed using 5 mm (3/16-inch) aluminum rivets with 3 mm (0.125 inch) to 6 mm (0.250 inch) grip range to fully penetrate the sign panel extrusions and firmly attach the plates. Any plate damaged by the Contractor shall be replaced in exact kind at no cost to the Department. The business logo panel shall not be removed when installing a service or mileage plate

This work will be paid for at the contract unit price each for INSTALL SERVICE OR MILEAGE PLATE, which price shall include payment in full for installing a service or mileage plate on a previously erected business logo panel.

REMOVE SERVICE SIGN OR MILEAGE PLATE

This work shall consist of removing an existing business service plate advertising a business establishment or a mileage plate from a previously erected business service panel.

Extreme care shall be taken not to damage or mar the plate in any way. Any plate damaged by the Contractor shall be replaced in exact kind at no cost to the Department. The plates shall be delivered to the District Sign Shop where work is being performed or at such other location agreed upon by the Engineer.

This work will be paid for at the contract unit price each for REMOVE SERVICE OR MILEAGE PLATE, which price shall include payment in full for removing a service or mileage plate from a previously erected business logo panel.

TRANSFER SERVICE SIGNS

This work shall consist of removing an existing business service sign advertising a business establishment from a previously erected business panel and reinstalling the business service sign on a newly erected business panel.

Extreme care shall be taken not to damage or mar the sign in any way. Any sign damaged by the Contractor shall be replaced in exact kind at no cost to the Department.

This work will be paid for at the contract unit price each for TRANSFER SERVICE SIGN, which price shall include payment in full for removing an existing service sign from a previously erected business logo panel and reinstalling the existing service sign on a newly erected business logo panel. The cost of transferring existing mileage plates and directional arrows for the service signs shall be considered included with this pay item.

REMOVE AND REINSTALL SIGN PANEL

This work shall consist of removing an existing sign panel from steel sign supports and reinstalling it on previously erected new sign supports. In the case of guide signs this may require the Contractor to remove the guide sign and install it on a bridge mount or overhead sign structure.

The removal of steel sign supports will not be included under this pay item but will be paid for as REMOVE EXISTING SIGN SUPPORT.

The replacement of any damaged or missing mounting hardware shall meet the requirements of Article 1090.03.

This work will be paid for at the contract unit price per square foot for REMOVE AND REINSTALL SIGN PANEL. This price shall include removing the sign panel from existing steel supports, installing the sign panel on new supports, and replacing any damaged or missing hardware where applicable.

REMOVE EXISTING SIGN PANEL

This work shall consist of removing an existing ground-mounted sign. The sign panel shall be removed completely, including exit panel and all hardware, and transported from the right-of-way. The panel and hardware shall become the property of the State and shall be delivered to the District Sign Shop in the District in which the work is being performed unless several sign panels are being removed in the District then the resident may request the sign panels be delivered to the Central office sign shop.

This work will be paid for at the contract unit price each for REMOVE EXISTING SIGN PANEL, which price shall include complete removal of the sign, including exit panel, if any, from the right-of-way.

REMOVE EXISTING SIGN COMPLETE

This work shall consist of removing an existing ground-mounted sign and supports as shown in the work order. The removal items shall consist of the sign panel and exit panel, and the structural steel supports. The sign panel shall become the property of the State and shall be delivered to the District Sign Shop in the District in which the work is being performed unless several signs in the district are removed and then it may be requested the signs be delivered to the Central Office Sign Shop. The supports, including hardware, shall become the property of the Contractor. The bid price shall reflect any salvage value for the supports and hardware.

Where the existing sign and supports are to be removed and be replaced by a new sign and new supports, the new sign shall be completely installed prior to the removal of the existing sign. However, duplicate signs are not to exist for periods in excess of 24 hours.

This work will be paid for at the contract unit price each for REMOVE EXISTING SIGN COMPLETE and shall be payment in full for all labor and equipment necessary to remove the sign and supports as herein specified and no additional compensation will be allowed.

The removal of any concrete foundations will be paid for as REMOVE CONCRETE FOUNDATION-GROUND MOUNT.

REMOVE EXISTING SIGN SUPPORT

This work shall consist of removing an existing steel sign support. The support, including hardware, shall become the property of the Contractor, and the bid price shall reflect any salvage value.

This work will be paid for at the contract unit price each for REMOVE EXISTING SIGN SUPPORT, which price shall include complete removal of the sign support, including hardware, from the right-of-way.

The removal of any concrete foundations will be paid for as REMOVE CONCRETE FOUNDATION - GROUND MOUNT.

CONCRETE FOUNDATIONS FOR SIGN SUPPORTS

This work shall consist of constructing Class SI concrete foundations for the installation of structural steel sign supports.

The concrete shall be obtained from a predetermined approved source. A list of approved suppliers may be obtained from each District.

Concrete foundations of the type and size as specified in the work order shall be constructed in accordance with the applicable requirements of Section 734. The top segment of the foundations shall be formed down to a depth of at least one (1) foot below the ground line. The top of the foundation shall be finished level, and all exposed surfaces shall be rubbed in accordance with Article 503.16.

The excavated material removed for installation of the foundations shall be disposed of outside the right-of-way at the Contractor's expense.

Concrete foundations will be measured for payment in accordance with the requirements of Article 503.21.

This work will be paid for at the contract unit price per cubic yard of CONCRETE FOUNDATIONS. This price shall be payment in full for all necessary excavating, back-filling, form-work, and furnishing and placing all materials, including the Class SI Concrete, reinforcing steel, anchor bolts, nuts, and washers complete in place.

REMOVE CONCRETE FOUNDATIONS

This work shall consist of removing a concrete foundation for a ground-mounted sign support. All components of the concrete foundation, including the concrete, reinforcing, and stub post, shall be removed to at least one foot below the grade line.

The use of explosives of any kind will not be permitted in removing concrete foundations. The hole shall be back-filled with suitable material approved by the Engineer. The surface of the filled hole shall be treated to match the surrounding area.

All debris resulting from this operation shall be removed from the right-of-way at the Contractor's expense.

This work will be paid for at the contract unit price each for REMOVE CONCRETE FOUNDATION-GROUND MOUNT, which price shall be payment in full for all equipment and labor necessary to complete the work and backfill the hole as herein described.

ANCHOR BOLTS (BDE)

Effective: January 1, 2013

Revise the fourth sentence of the first paragraph of Article 1006.09 of the Standard Specifications to read:

“Stud bolts or fully threaded rods shall be according to either ASTM A 354 Grade BC, ASTM A 193 Grade B7, or ASTM F 1554 Grade 105.”

Revise the second paragraph of Article 1006.09 of the Standard Specifications to read:

“Washers and nuts shall match with the hardness of the anchor bolt, stud, or rod. For ASTM F 1554 Grade 36 (Grade 250) or Grade 55 (Grade 380) anchor rods or bolts, washers shall be according to ASTM F 844 or ASTM F 436, and nuts shall be according to AASHTO M 291 Grade A. For ASTM F 1554 Grade 105 (Grade 725) bolts, ASTM A 354, or ASTM A 193 stud bolts, washers shall be according to AASHTO M 293 Type 1 or Type 3, and nuts shall be according to AASHTO M 291 Grade DH or DH3.”

Revise the seventh paragraph of Article 1006.09 of the Standard Specifications to read:

“Anchor bolts, rods, studs, nuts, and washers requiring galvanizing shall be hot dipped, with zinc coatings conforming to the requirements of ASTM F 2329.”

Revise the fourth paragraph of Article 1070.01 of the Standard Specifications to read:

“Fully threaded and galvanized anchor rods or stud bolts with washers and nuts shall be furnished with the foundations and shall be according to Article 1006.09. Anchors furnished according to ASTM F 1554 shall be Grade 105 (Grade 725).”

Revise the second paragraph of Article 1070.03 of the Standard Specifications to read:

“Top anchor rod nuts for all towers shall be the self-locking type with nylon or steel inserts.”

CONCRETE MIX DESIGN – DEPARTMENT PROVIDED (BDE)

Effective: January 1, 2012

For the “Portland Cement Concrete (BDE)” special provision included in this project, specifically Article 1020.05(a), the Contractor has the option to request the Engineer determine mix design material proportions for Class PV, PP, RR, BS, DS, SC, and SI concrete. A single mix design for each class of concrete will be provided. Acceptance by the Contractor to use the mix design developed by the Engineer shall not relieve the Contractor from meeting specification requirements.

DISADVANTAGED BUSINESS ENTERPRISE PARTICIPATION (DBE)

Effective: September 1, 2000

Revised: August 2, 2011

FEDERAL OBLIGATION. The Department of Transportation, as a recipient of federal financial assistance, is required to take all necessary and reasonable steps to ensure nondiscrimination in the award and administration of contracts. Consequently, the federal regulatory provisions of 49 CFR Part 26 apply to this contract concerning the utilization of disadvantaged business enterprises. For the purposes of this Special Provision, a disadvantaged business enterprise (DBE) means a business certified by the Department in accordance with the requirements of 49 CFR Part 26 and listed in the Illinois Unified Certification Program (IL UCP) DBE Directory.

STATE OBLIGATION. This Special Provision will also be used by the Department to satisfy the requirements of the Business Enterprise for Minorities, Females, and Persons with Disabilities Act, 30 ILCS 575. When this Special Provision is used to satisfy state law requirements on 100 percent state-funded contracts, the federal government has no involvement in such contracts (not a federal-aid contract) and no responsibility to oversee the implementation of this Special Provision by the Department on those contracts. DBE participation on 100 percent state-funded contracts will not be credited toward fulfilling the Department's annual overall DBE goal required by the US Department of Transportation to comply with the federal DBE program requirements.

CONTRACTOR ASSURANCE. The Contractor makes the following assurance and agrees to include the assurance in each subcontract that the Contractor signs with a subcontractor.

The Contractor, subrecipient, or subcontractor shall not discriminate on the basis of race, color, national origin, or sex in the performance of this contract. The Contractor shall carry out applicable requirements of 49 CFR Part 26 in the award and administration of contracts funded in whole or in part with federal or state funds. Failure by the Contractor to carry out these requirements is a material breach of this contract, which may result in the termination of this contract or such other remedy as the recipient deems appropriate.

OVERALL GOAL SET FOR THE DEPARTMENT. As a requirement of compliance with 49 CFR Part 26, the Department has set an overall goal for DBE participation in its federally assisted contracts. That goal applies to all federal-aid funds the Department will expend in its federally assisted contracts for the subject reporting fiscal year. The Department is required to make a good faith effort to achieve the overall goal. The dollar amount paid to all approved DBE companies performing work called for in this contract is eligible to be credited toward fulfillment of the Department's overall goal.

CONTRACT GOAL TO BE ACHIEVED BY THE CONTRACTOR. This contract includes a specific DBE utilization goal established by the Department. The goal has been included because the Department has determined that the work of this contract has subcontracting opportunities that may be suitable for performance by DBE companies. The determination is based on an assessment of the type of work, the location of the work, and the availability of DBE companies to do a part of the work. The assessment indicates that, in the absence of unlawful discrimination, and in an arena of fair and open competition, DBE companies can be expected to perform 0.00% of the work. This percentage is set as the DBE participation goal for this contract. Consequently, in addition to the other award criteria established for this contract, the Department will only award this contract to a bidder who makes a good faith effort to meet this goal of DBE participation in the performance of the work. A bidder makes a good faith effort for award consideration if either of the following is done in accordance with the procedures set for in this Special Provision:

- (a) The bidder documents that enough DBE participation has been obtained to meet the goal: or
- (b) The bidder documents that a good faith effort has been made to meet the goal, even though the effort did not succeed in obtaining enough DBE participation to meet the goal.

DBE LOCATOR REFERENCES. Bidders shall consult the IL UCP DBE Directory as a reference source for DBE-certified companies. In addition, the Department maintains a letting and item specific DBE locator information system whereby DBE companies can register their interest in providing quotes on particular bid items advertised for letting. Information concerning DBE companies willing to quote work for particular contracts may be obtained by contacting the Department's Bureau of Small Business Enterprises at telephone number (217)785-4611, or by visiting the Department's website at www.dot.il.gov.

BIDDING PROCEDURES. Compliance with this Special Provision is a material bidding requirement. The failure of the bidder to comply will render the bid not responsive.

- (a) The bidder shall submit a Disadvantaged Business Utilization Plan on Department forms SBE 2025 and 2026 with the bid.
- (b) The Utilization Plan shall indicate that the bidder either has obtained sufficient DBE participation commitments to meet the contract goal or has not obtained enough DBE participation commitments in spite of a good faith effort to meet the goal. The Utilization Plan shall further provide the name, telephone number, and telefax number of a responsible official of the bidder designated for purposes of notification of plan approval or disapproval under the procedures of this Special Provision.
- (c) The Utilization Plan shall include a DBE Participation Commitment Statement, Department form SBE 2025, for each DBE proposed for the performance of work to achieve the contract goal. For bidding purposes, submission of the completed SBE 2025 forms, signed by the DBEs and faxed to the bidder will be acceptable as long as the original is available and provided upon request. All elements of information indicated on the said form shall be provided, including but not limited to the following:

- (1) The names and addresses of DBE firms that will participate in the contract;
- (2) A description, including pay item numbers, of the work each DBE will perform;
- (3) The dollar amount of the participation of each DBE firm participating. The dollar amount of participation for identified work shall specifically state the quantity, unit price, and total subcontract price for the work to be completed by the DBE. If partial pay items are to be performed by the DBE, indicate the portion of each item, a unit price where appropriate and the subcontract price amount;
- (4) DBE Participation Commitment Statements, form SBE 2025, signed by the bidder and each participating DBE firm documenting the commitment to use the DBE subcontractors whose participation is submitted to meet the contract goal;
- (5) if the bidder is a joint venture comprised of DBE companies and non-DBE companies, the plan must also include a clear identification of the portion of the work to be performed by the DBE partner(s); and,
- (6) If the contract goal is not met, evidence of good faith efforts.

GOOD FAITH EFFORT PROCEDURES. The contract will not be awarded until the Utilization Plan submitted by the apparent successful bidder is approved. All information submitted by the bidder must be complete, accurate and adequately document that enough DBE participation has been obtained or document that good faith efforts of the bidder, in the event enough DBE participation has not been obtained, before the Department will commit to the performance of the contract by the bidder. The Utilization Plan will be approved by the Department if the Utilization Plan documents sufficient commercially useful DBE work performance to meet the contract goal or the bidder submits sufficient documentation of a good faith effort to meet the contract goal pursuant to 49 CFR Part 26, Appendix A. The Utilization Plan will not be approved by the Department if the Utilization Plan does not document sufficient DBE participation to meet the contract goal unless the apparent successful bidder documented in the Utilization Plan that it made a good faith effort to meet the goal. This means that the bidder must show that all necessary and reasonable steps were taken to achieve the contract goal. Necessary and reasonable steps are those which, by their scope, intensity and appropriateness to the objective, could reasonably be expected to obtain sufficient DBE participation, even if they were not successful. The Department will consider the quality, quantity, and intensity of the kinds of efforts that the bidder has made. Mere *pro forma* efforts, in other words, efforts done as a matter of form, are not good faith efforts; rather, the bidder is expected to have taken genuine efforts that would be reasonably expected of a bidder actively and aggressively trying to obtain DBE participation sufficient to meet the contract goal.

- (a) The following is a list of types of action that the Department will consider as part of the evaluation of the bidder's good faith efforts to obtain participation. These listed factors are not intended to be a mandatory checklist and are not intended to be exhaustive. Other factors or efforts brought to the attention of the Department may be relevant in appropriate cases, and will be considered by the Department.

- (1) Soliciting through all reasonable and available means (e.g. attendance at pre-bid meetings, advertising and/or written notices) the interest of all certified DBE companies that have the capability to perform the work of the contract. The bidder must solicit this interest within sufficient time to allow the DBE companies to respond to the solicitation. The bidder must determine with certainty if the DBE companies are interested by taking appropriate steps to follow up initial solicitations.
- (2) Selecting portions of the work to be performed by DBE companies in order to increase the likelihood that the DBE goals will be achieved. This includes, where appropriate, breaking out contract work items into economically feasible units to facilitate DBE participation, even when the prime Contractor might otherwise prefer to perform these work items with its own forces.
- (3) Providing interested DBE companies with adequate information about the plans, specifications, and requirements of the contract in a timely manner to assist them in responding to a solicitation.
- (4) a. Negotiating in good faith with interested DBE companies. It is the bidder's responsibility to make a portion of the work available to DBE subcontractors and suppliers and to select those portions of the work or material needs consistent with the available DBE subcontractors and suppliers, so as to facilitate DBE participation. Evidence of such negotiation includes the names, addresses, and telephone numbers of DBE companies that were considered; a description of the information provided regarding the plans and specifications for the work selected for subcontracting; and evidence as to why additional agreements could not be reached for DBE companies to perform the work.

b. A bidder using good business judgment would consider a number of factors in negotiating with subcontractors, including DBE subcontractors, and would take a firm's price and capabilities as well as contract goals into consideration. However, the fact that there may be some additional costs involved in finding and using DBE companies is not in itself sufficient reason for a bidder's failure to meet the contract DBE goal, as long as such costs are reasonable. Also the ability or desire of a bidder to perform the work of a contract with its own organization does not relieve the bidder of the responsibility to make good faith efforts. Bidders are not, however, required to accept higher quotes from DBE companies if the price difference is excessive or unreasonable.
- (5) Not rejecting DBE companies as being unqualified without sound reasons based on a thorough investigation of their capabilities. The bidder's standing within its industry, membership in specific groups, organizations, or associations and political or social affiliations (for example union vs. non-union employee status) are not legitimate causes for the rejection or non-solicitation of bids in the bidder's efforts to meet the project goal.
- (6) Making efforts to assist interested DBE companies in obtaining bonding, lines of credit, or insurance as required by the recipient or Contractor.

- (7) Making efforts to assist interested DBE companies in obtaining necessary equipment, supplies, materials, or related assistance or services.
 - (8) Effectively using the services of available minority/women community organizations; minority/women contractors' groups; local, state, and federal minority/women business assistance offices; and other organizations as allowed on a case-by-case basis to provide assistance in the recruitment and placement of DBE companies.
- (b) If the Department determines that the apparent successful bidder has made a good faith effort to secure the work commitment of DBE companies to meet the contract goal, the Department will award the contract provided that it is otherwise eligible for award. If the Department determines that the bidder has failed to meet the requirements of this Special Provision or that a good faith effort has not been made, the Department will notify the responsible company official designated in the Utilization Plan that the bid is not responsive. The notification shall include a statement of reasons for the determination.
- (c) The bidder may request administrative reconsideration of a determination adverse to the bidder within the five working days after the receipt of the notification date of the determination by delivering the request to the Department of Transportation, Bureau of Small Business Enterprises, Contract Compliance Section, 2300 South Dirksen Parkway, Room 319, Springfield, Illinois 62764 (Telefax: (217)785-1524). Deposit of the request in the United States mail on or before the fifth business day shall not be deemed delivery. The determination shall become final if a request is not made and delivered. A request may provide additional written documentation and/or argument concerning the issues raised in the determination statement of reasons, provided the documentation and arguments address efforts made prior to submitting the bid. The request will be forwarded to the Department's Reconsideration Officer. The Reconsideration Officer will extend an opportunity to the bidder to meet in person in order to consider all issues of documentation and whether the bidder made a good faith effort to meet the goal. After the review by the Reconsideration Officer, the bidder will be sent a written decision within ten working days after receipt of the request for consideration, explaining the basis for finding that the bidder did or did not meet the goal or make adequate good faith efforts to do so. A final decision by the Reconsideration Officer that a good faith effort was made shall approve the Utilization Plan submitted by the bidder and shall clear the contract for award. A final decision that a good faith effort was not made shall render the bid not responsive.

CALCULATING DBE PARTICIPATION. The Utilization Plan values represent work anticipated to be performed and paid for upon satisfactory completion. The Department is only able to count toward the achievement of the overall goal and the contract goal the value of payments made for the work actually performed by DBE companies. In addition, a DBE must perform a commercially useful function on the contract to be counted. A commercially useful function is generally performed when the DBE is responsible for the work and is carrying out its responsibilities by actually performing, managing, and supervising the work involved. The Department and Contractor are governed by the provisions of 49 CFR Part 26.55(c) on questions of commercially useful functions as it affects the work. Specific counting guidelines are provided in 49 CFR Part 26.55, the provisions of which govern over the summary contained herein.

- (a) DBE as the Contractor: 100 percent goal credit for that portion of the work performed by the DBE's own forces, including the cost of materials and supplies. Work that a DBE subcontracts to a non-DBE does not count toward the DBE goals.
- (b) DBE as a joint venture Contractor: 100 percent goal credit for that portion of the total dollar value of the contract equal to the distinct, clearly defined portion of the work performed by the DBE's own forces.
- (c) DBE as a subcontractor: 100 percent goal credit for the work of the subcontract performed by the DBE's own forces, including the cost of materials and supplies, excluding the purchase of materials and supplies or the lease of equipment by the DBE subcontractor from the prime Contractor or its affiliates. Work that a DBE subcontractor in turn subcontracts to a non-DBE does not count toward the DBE goal.
- (d) DBE as a trucker: 100 percent goal credit for trucking participation provided the DBE is responsible for the management and supervision of the entire trucking operation for which it is responsible. At least one truck owned, operated, licensed, and insured by the DBE must be used on the contract. Credit will be given for the following:
 - (1) The DBE may lease trucks from another DBE firm, including an owner-operator who is certified as a DBE. The DBE who leases trucks from another DBE receives credit for the total value of the transportation services the lessee DBE provides on the contract.
 - (2) The DBE may also lease trucks from a non-DBE firm, including from an owner-operator. The DBE who leases trucks from a non-DBE is entitled to credit only for the fee or commission is receives as a result of the lease arrangement.
- (e) DBE as a material supplier:
 - (1) 60 percent goal credit for the cost of the materials or supplies purchased from a DBE regular dealer.
 - (2) 100 percent goal credit for the cost of materials of supplies obtained from a DBE manufacturer.
 - (3) 100 percent credit for the value of reasonable fees and commissions for the procurement of materials and supplies if not a regular dealer or manufacturer.

CONTRACT COMPLIANCE. Compliance with this Special Provision is an essential part of the contract. The Department is prohibited by federal regulations from crediting the participation of a DBE included in the Utilization Plan toward either the contract goal or the Department's overall goal until the amount to be applied toward the goals has been paid to the DBE. The following administrative procedures and remedies govern the compliance by the Contractor with the contractual obligations established by the Utilization Plan. After approval of the Utilization Plan and award of the contract, the Utilization Plan and individual DBE Participation Statements become part of the contract. If the Contractor did not succeed in obtaining enough DBE participation to achieve the advertised contract goal, and the Utilization Plan was approved and contract awarded based upon a determination of good faith, the total dollar value of DBE work calculated in the approved Utilization Plan as a percentage of the awarded contract value shall become the amended contract goal. All work indicated for performance by an approved DBE shall be performed, managed, and supervised by the DBE executing the Participation Statement.

- (a) NO AMENDMENT. No amendment to the Utilization Plan may be made without prior written approval from the Department's Bureau of Small Business Enterprises. All requests for amendment to the Utilization Plan shall be submitted to the Department of Transportation, Bureau of Small Business Enterprises, Contract Compliance Section, 2300 South Dirksen Parkway, Room 319, Springfield, Illinois 62764. Telephone number (217)785-4611. Telefax number (217)785-1524.
- (b) TERMINATION OR REPLACEMENT. The Contractor shall not terminate or replace a DBE listed on the approved Utilization Plan, or perform with other forces work designated for a listed DBE except as provided in the Special Provision.
- (c) CHANGES TO WORK. Any deviation from the DBE condition-of-award or contract plans, specifications, or special provisions must be approved, in writing, by the Department as provided elsewhere in the Contract. The Contractor shall notify affected DBEs in writing of any changes in the scope of work which result in a reduction in the dollar amount condition-of-award to the contract. Where the revision includes work committed to a new DBE subcontractor, not previously involved in the project, then a Request for Approval of Subcontractor, Department form BC 260A, must be signed and submitted. If the commitment of work is in the form of additional tasks assigned to an existing subcontract, then a new Request for Approval of Subcontractor shall not be required. However, the Contractor must document efforts to assure that the existing DBE subcontractor is capable of performing the additional work and has agreed in writing to the change.

(d) ALTERNATIVE WORK METHODS. In addition to the above requirements for reductions in the condition of award, additional requirements apply to the two cases of Contractor-initiated work substitution proposals. Where the contract allows alternate work methods which serve to delete or create underruns in condition of award DBE work, and the Contractor selects that alternate method or, where the Contractor proposes a substitute work method or material that serves to diminish or delete work committed to a DBE and replace it with other work, then the Contractor must demonstrate one of the following:

- (1) That the replacement work will be performed by the same DBE (as long as the DBE is certified in the respective item of work) in a modification of the condition of award; or
- (2) That the DBE is aware that its work will be deleted or will experience underruns and has agreed in writing to the change. If this occurs, the Contractor shall substitute other work of equivalent value to a certified DBE or provide documentation of good faith efforts to do so; or
- (3) That the DBE is not capable of performing the replacement work or has declined to perform the work at a reasonable competitive price. If this occurs, the Contractor shall substitute other work of equivalent value to a certified DBE or provide documentation of good faith efforts to do so.

(e) TERMINATION AND REPLACEMENT PROCEDURES. The Contractor shall not terminate or replace a DBE subcontractor listed in the approved Utilization Plan without prior written consent. This includes, but is not limited to, instances in which the Contractor seeks to perform work originally designated for a DBE subcontractor with its own forces or those of an affiliate, a non-DBE firm, or with another DBE firm. Written consent will be granted only if the Bureau of Small Business Enterprises agrees, for reasons stated in its concurrence document, that the Contractor has good cause to terminate or replace the DBE firm. Before transmitting to the Bureau of Small Business Enterprises any request to terminate and/or substitute a DBE subcontractor, the Contractor shall give notice in writing to the DBE subcontractor, with a copy to the Bureau, of its intent to request to terminate and/or substitute, and the reason for the request. The Contractor shall give the DBE five days to respond to the Contractor's notice. The DBE so notified shall advise the Bureau and the Contractor of the reasons, if any, why it objects to the proposed termination of its subcontract and why the Bureau should not approve the Contractor's action. If required in a particular case as a matter of public necessity, the Bureau may provide a response period shorter than five days.

For purposes of this paragraph, good cause includes the following circumstances:

- (1) The listed DBE subcontractor fails or refuses to execute a written contract;
- (2) The listed DBE subcontractor fails or refuses to perform the work of its subcontract in a way consistent with normal industry standards. Provided, however, that good cause does not exist if the failure or refusal of the DBE subcontractor to perform its work on the subcontract results from the bad faith or discriminatory action of the prime contractor;
- (3) The listed DBE subcontractor fails or refuses to meet the prime Contractor's reasonable, nondiscriminatory bond requirements;

- (4) The listed DBE subcontractor becomes bankrupt, insolvent, or exhibits credit unworthiness;
- (5) The listed DBE subcontractor is ineligible to work on public works projects because of suspension and debarment proceedings pursuant 2 CFR Parts 180, 215 and 1,200 or applicable state law.
- (6) You have determined that the listed DBE subcontractor is not a responsible contractor;
- (7) The listed DBE subcontractor voluntarily withdraws from the projects and provides to you written notice of its withdrawal;
- (8) The listed DBE is ineligible to receive DBE credit for the type of work required;
- (9) A DBE owner dies or becomes disabled with the result that the listed DBE contractor is unable to complete its work on the contract;
- (10) Other documented good cause that compels the termination of the DBE subcontractor. Provided, that good cause does not exist if the prime Contractor seeks to terminate a DBE it relied upon to obtain the contract so that the prime Contractor can self-perform the work for which the DBE contractor was engaged or so that the prime Contractor can substitute another DBE or non-DBE contractor after contract award.

When a DBE is terminated, or fails to complete its work on the Contract for any reason the Contractor shall make a good faith effort to find another DBE to substitute for the original DBE to perform at least the same amount of work under the contract as the terminated DBE to the extent needed to meet the established Contract goal.

- (f) PAYMENT RECORDS. The Contractor shall maintain a record of payments for work performed to the DBE participants. The records shall be made available to the Department for inspection upon request. After the performance of the final item of work or delivery of material by a DBE and final payment therefore to the DBE by the Contractor, but not later than thirty calendar days after payment has been made by the Department to the Contractor for such work or material, the Contractor shall submit a DBE Payment Agreement on Department form SBE 2115 to the Regional Engineer. If full and final payment has not been made to the DBE, the DBE Payment Agreement shall indicate whether a disagreement as to the payment required exists between the Contractor and the DBE or if the Contractor believes that the work has not been satisfactorily completed. If the Contractor does not have the full amount of work indicated in the Utilization Plan performed by the BDE companies indicated in the Utilization Plan and after good faith efforts are reviewed, the Department may deduct from contract payments to the Contractor the amount of the goal not achieved as liquidated and ascertained damages. The Contractor may request an administrative reconsideration of any amount deducted as damages pursuant to subsection (h) of this part.

- (g) **ENFORCEMENT**. The Department reserves the right to withhold payment to the Contractor to enforce the provisions of this Special Provision. Final payment shall not be made on the contract until such time as the Contractor submits sufficient documentation demonstrating achievement of the goal in accordance with this Special Provision or after liquidated damages have been determined and collected.
- (h) **RECONSIDERATION**. Notwithstanding any other provision of the contract, including but not limited to Article 109.09 of the Standard Specifications, the Contractor may request administrative reconsideration of a decision to deduct the amount of the goal not achieved as liquidated damages. A request to reconsider shall be delivered to the Contract Compliance Section and shall be handled and considered in the same manner as set forth in paragraph (c) of "Good Faith Effort Procedures" of this Special Provision, except a final decision that a good faith effort was not made during contract performance to achieve the goal agreed to in the Utilization Plan shall be the final administrative decision of the Department.

LIQUIDATED DAMAGES (BDE)

Effective: April 1, 2013

Revise the table in Article 108.09 of the Standard Specifications to read:

"Schedule of Deductions for Each Day of Overrun in Contract Time"			
Original Contract Amount		Daily Charges	
From More Than	To and Including	Calendar Day	Work Day
\$ 0	\$ 100,000	\$ 475	\$ 675
100,000	500,000	750	1,050
500,000	1,000,000	1,025	1,425
1,000,000	3,000,000	1,275	1,725
3,000,000	6,000,000	1,425	2,000
6,000,000	12,000,000	2,300	3,450
12,000,000	And over	6,775	9,525"

PAYMENTS TO SUBCONTRACTORS (BDE)

Effective: June 1, 2000

Revised: January 1, 2006

Federal regulations found at 49 CFR §26.29 mandate the Department to establish a contract clause to require Contractors to pay subcontractors for satisfactory performance of their subcontracts and to set the time for such payments.

State law also addresses the timing of payments to be made to subcontractors and material suppliers. Section 7 of the Prompt Payment Act, 30 ILCS 540/7, requires that when a Contractor receives any payment from the Department, the Contractor shall make corresponding, proportional payments to each subcontractor and material supplier performing work or supplying material within 15 calendar days after receipt of the Department payment. Section 7 of the Act further provides that interest in the amount of two percent per month, in addition to the payment due, shall be paid to any subcontractor or material supplier by the Contractor if the payment required by the Act is withheld or delayed without reasonable cause. The Act also provides that the time for payment required and the calculation of any interest due applies to transactions between subcontractors and lower-tier subcontractors and material suppliers throughout the contracting chain.

This Special Provision establishes the required federal contract clause, and adopts the 15 calendar day requirement of the State Prompt Payment Act for purposes of compliance with the federal regulation regarding payments to subcontractors. This contract is subject to the following payment obligations.

When progress payments are made to the Contractor according to Article 109.07 of the Standard Specifications, the Contractor shall make a corresponding payment to each subcontractor and material supplier in proportion to the work satisfactorily completed by each subcontractor and for the material supplied to perform any work of the contract. The proportionate amount of partial payment due to each subcontractor and material supplier throughout the contracting chain shall be determined by the quantities measured or otherwise determined as eligible for payment by the Department and included in the progress payment to the Contractor. Subcontractors and material suppliers shall be paid by the Contractor within 15 calendar days after the receipt of payment from the Department. The Contractor shall not hold retainage from the subcontractors. These obligations shall also apply to any payments made by subcontractors and material suppliers to their subcontractors and material suppliers; and to all payments made to lower tier subcontractors and material suppliers throughout the contracting chain. Any payment or portion of a payment subject to this provision may only be withheld from the subcontractor or material supplier to whom it is due for reasonable cause.

This Special Provision does not create any rights in favor of any subcontractor or material supplier against the State or authorize any cause of action against the State on account of any payment, nonpayment, delayed payment, or interest claimed by application of the State Prompt Payment Act. The Department will not approve any delay or postponement of the 15 day requirement except for reasonable cause shown after notice and hearing pursuant to Section 7(b) of the State Prompt Payment Act. State law creates other and additional remedies available to any subcontractor or material supplier, regardless of tier, who has not been paid for work properly performed or material furnished. These remedies are a lien against public funds set forth in Section 23(c) of the Mechanics Lien Act, 770 ILCS 60/23(c), and a recovery on the Contractor's payment bond according to the Public Construction Bond Act, 30 ILCS 550.

PLACING AND CONSOLIDATING CONCRETE (BDE)

Effective: January 1, 2013

Revise the first paragraph of Article 503.06 of the Standard Specifications to read:

“503.06 Forms. Forms shall be set and maintained to the lines and grades shown on the plans, and shall be tight to prevent concrete leakage.”

Revise Article 503.07 of the Standard Specifications to read:

“503.07 Placing and Consolidating. No concrete shall be placed on ice, snow, or frozen foundation material.

The method and manner of placing concrete shall be such as to avoid segregation or separation of the aggregates or the displacement of the reinforcement. The external surface of all concrete shall be thoroughly worked during the operations of placing in such a manner as to work the mortar against the forms to produce a smooth finish free of honeycomb and with a minimum of water and air pockets.

Open troughs and chutes shall extend as nearly as practicable to the point of deposit. Dropping the concrete a distance of more than 5 ft (1.5 m) or depositing a large quantity at any point and running or working it along the forms will not be permitted. The concrete for walls with an average thickness of 12 in. (300 mm) or less shall be placed with tubes so that the drop is not greater than 5 ft (1.5 m).

For self-consolidating concrete, the maximum distance of horizontal flow from the point of deposit shall be 15 ft (4.6 m). The distance may be increased if the dynamic segregation index (DSI) at the maximum flow distance is 10.0 percent or less according to Illinois Test Procedure SCC-8 (Option C). The maximum distance using the DSI shall be 25 ft (7.6 m). In addition, this specified horizontal flow distance shall apply to precast products. In the case of precast prestressed concrete products, refer to the Department's "Manual of Fabrication for Precast Prestressed Concrete Products" for the specified horizontal flow distance requirements.

When the form height for placing the self-consolidating concrete is greater than 10 ft (3.0 m), direct monitoring of form pressure shall be performed by the Contractor according to Illinois Test Procedure SCC-10. The monitoring requirement is a minimum, and the Contractor shall remain responsible for adequate design of the falsework and forms. The Contractor shall record the formwork pressure during concrete placement. This information shall be used by the Contractor to prevent the placement rate from exceeding the maximum formwork pressure allowed, to monitor the thixotropic change in the concrete during the pour, and to make appropriate adjustments to the mix design. This information shall be provided to the Engineer during the pour.

When concrete is pumped, the equipment shall be suitable in kind and adequate in capacity for the work and arranged so that vibrations will not damage freshly placed concrete. Aluminum pipe or conduit will not be permitted in pumping or placing concrete. Mixed concrete shall be supplied to maintain continuous operation of the pumping equipment.

When air entrained concrete is pumped, an accessory or accessories shall be incorporated in the discharge components to minimize air loss. The maximum allowable air loss caused by the pumping operation shall be 3.0 percent with the minimum air content at the point of discharge meeting the requirements of Article 1020.04.

Placing of concrete shall be regulated so that the pressures caused by the wet concrete will not exceed those used in the design of the forms. Special care shall be taken to fill each part of the forms by depositing the concrete as near its final position as possible, to work the coarser aggregates back from the face, and to force the concrete under and around the reinforcement bars without displacing them. Leakage through forms onto beams or girders shall not be allowed to harden and shall be removed while in a plastic state.

The concrete shall be consolidated by internal vibration unless self-consolidating concrete is used. Self-consolidating concrete may be used for inaccessible locations where consolidation by internal vibration is not practicable. The self consolidating concrete shall be rodded with a piece of lumber, conduit, or vibrator if the material has lost its fluidity prior to placement of additional concrete. The vibrator may only be permitted if it can be used in a manner that does not cause segregation as determined by the Engineer. Any other method for restoring the fluidity of the concrete shall be approved by the Engineer.

The Contractor shall provide and use a sufficient number of vibrators to ensure that consolidation can be started immediately after the concrete has been deposited in the forms.

The vibrators shall be inserted into the concrete immediately after it is deposited and shall be moved throughout the mass so as to thoroughly work the concrete around the reinforcement, embedded fixtures, and into the corners and angles of the forms. Vibrators shall not be attached to the forms, reinforcement bars, or the surface of the concrete.

Application of vibrators shall be at points uniformly spaced and not farther apart than twice the radius over which the vibration is visibly effective. The duration of the vibration at the points of insertion shall be sufficient to thoroughly consolidate the concrete into place but shall not be continued so as to cause segregation. When consolidating concrete in bridge decks, the vibrator shall be vertically inserted into the concrete for 3 - 5 seconds or for a period of time determined by the Engineer. Vibration shall be supplemented by spading when required by the Engineer. In addition to the internal vibration required herein, formed surfaces which will be exposed to view after completion of the work shall be spaded with a spading tool approved by the Engineer.

Concrete shall be placed in continuous horizontal layers. When it is necessary by reason of an emergency to place less than a complete horizontal layer in one operation, such layer shall terminate in a vertical bulkhead. Separate batches shall follow each other closely and in no case shall the interval of time between the placing of successive batches be greater than 20 minutes.

If mix foaming or detrimental material is observed during placement or at the completion of a pour, the material shall be removed while the concrete is still plastic

After the concrete has taken its initial set, care shall be exercised to avoid jarring the forms or placing any strain on the ends of projecting reinforcement.”

Revise Article 516.12(a) of the Standard Specifications to read:

“(a) Free Fall Placement. The free fall placement shall only be permitted in shafts that can be dewatered to ensure less than 3 in. (75 mm) of standing water exist at the time of placement without causing side wall instability. The height of free fall placement shall be a maximum of 60 ft (18.3 m) as measured from the discharge end, but it shall be reduced to a maximum of 30 ft (9.1 m) when self-consolidating concrete is used. The Contractor shall obtain approval from the Engineer to place self-consolidating concrete by free fall.

Concrete placed by free fall shall fall directly to the base without contacting either the rebar cage or shaft sidewall. Drop chutes may be used to direct concrete to the base during free fall placement.

Drop chutes used to direct placement of free fall concrete shall consist of a smooth tube of either one continuous section or multiple pieces that can be added and removed. Concrete may be placed through either a hopper at the top of the tube or side openings as the drop chute is retrieved during concrete placement. The drop chute shall be supported so that free fall does not exceed the specified maximum 60 ft (18.3 m) or 30 ft (9.1 m) at all times from the discharge end, and to ensure the concrete does not strike the rebar cage. If placement cannot be satisfactorily accomplished by free fall in the opinion of the Engineer, either a tremie or pump shall be used to accomplish the pour.”

PORTLAND CEMENT CONCRETE (BDE)

Effective: January 1, 2012

Revised: January 1, 2013

Revise Notes 1 and 2 of Article 312.24 of the Standard Specifications to read:

“Note 1. Coarse aggregate shall be gradation CA 6, CA 7, CA 9, CA 10, or CA 11, Class D quality or better. Article 1020.05(d) shall apply.

Note 2. Fine aggregate shall be FA 1 or FA 2. Article 1020.05(d) shall apply.”

Revise the first paragraph of Article 312.26 of the Standard Specifications to read:

“**312.26 Proportioning and Mix Design.** At least 60 days prior to start of placing CAM II, the Contractor shall submit samples of materials for proportioning and testing. The mixture shall contain a minimum of 200 lb (90 kg) of cement per cubic yard (cubic meter). Portland cement may be replaced with fly ash according to Article 1020.05(c)(1), however the minimum portland cement content in the mixture shall be 170 lbs/cu yd (101 kg/cu m). Blends of coarse and fine aggregates will be permitted, provided the volume of fine aggregate does not exceed the volume of coarse aggregate. The Engineer will determine the proportions of materials for the mixture. However, the Contractor may substitute their own mix design. Article 1020.05(a) shall apply and a Level III PCC Technician shall develop the mix design.”

Revise the second paragraph of Article 503.22 of the Standard Specifications to read:

Other cast-in-place concrete for structures will be paid for at the contract unit price per cubic yard (cubic meter) for CONCRETE HANDRAIL, CONCRETE ENCASEMENT, and SEAL COAT CONCRETE.”

Add the following to Article 1003.02 of the Standard Specifications:

(e) Alkali Reaction.

- (1) ASTM C 1260. Each fine aggregate will be tested by the Department for alkali reaction according to ASTM C 1260. The test will be performed with Type I or II portland cement having a total equivalent alkali content ($\text{Na}_2\text{O} + 0.658\text{K}_2\text{O}$) of 0.90 percent or greater. The Engineer will determine the assigned expansion value for each aggregate, and these values will be made available on the Department's Alkali-Silica Potential Reactivity Rating List. The Engineer may differentiate aggregate based on ledge, production method, gradation number, or other factors. An expansion value of 0.03 percent will be assigned to limestone or dolomite fine aggregates (manufactured stone sand). However, the Department reserves the right to perform the ASTM C 1260 test.
- (2) ASTM C 1293 by Department. In some instances, such as chert natural sand or other fine aggregates, testing according to ASTM C 1260 may not provide accurate test results. In this case, the Department may only test according to ASTM C 1293.
- (3) ASTM C 1293 by Contractor. If an individual aggregate has an ASTM C 1260 expansion value that is unacceptable to the Contractor, an ASTM C 1293 test may be performed by the Contractor to evaluate the Department's ASTM C 1260 test result. The laboratory performing the ASTM C 1293 test shall be approved by the Department according to the current Bureau of Materials and Physical Research Policy Memorandum "Minimum Laboratory Requirements for Alkali-Silica Reactivity (ASR) Testing".

The ASTM C 1293 test shall be performed with Type I or II portland cement having a total equivalent alkali content ($\text{Na}_2\text{O} + 0.658\text{K}_2\text{O}$) of 0.80 percent or greater. The interior vertical wall of the ASTM C 1293 recommended container (pail) shall be half covered with a wick of absorbent material consisting of blotting paper. If the testing laboratory desires to use an alternate container, wick of absorbent material, or amount of coverage inside the container with blotting paper, ASTM C 1293 test results with an alkali-reactive aggregate of known expansion characteristics shall be provided to the Engineer for review and approval. If the expansion is less than 0.040 percent after one year, the aggregate will be assigned an ASTM C 1260 expansion value of 0.08 percent that will be valid for two years, unless the Engineer determines the aggregate has changed significantly. If the aggregate is manufactured into multiple gradation numbers, and the other gradation numbers have the same or lower ASTM C 1260 value, the ASTM C 1293 test result may apply to multiple gradation numbers.

The Engineer reserves the right to verify a Contractor's ASTM C 1293 test result. When the Contractor performs the test, a split sample shall be provided to the Engineer. The Engineer may also independently obtain a sample at any time. The aggregate will be considered reactive if the Contractor or Engineer obtains an expansion value of 0.040 percent or greater.

Revise the first paragraph of Article 1004.01(e)(5) of the Standard Specifications to read:

“Crushed concrete, crushed slag, or lightweight aggregate for portland cement concrete shall be stockpiled in a moist condition (saturated surface dry or greater) and the moisture content shall be maintained uniformly throughout the stockpile by periodic sprinkling.”

Revise Article 1004.02(d) of the Standard Specifications to read:

“(d)Combining Sizes. Each size shall be stored separately and care shall be taken to prevent them from being mixed until they are ready to be proportioned. Separate compartments shall be provided to proportion each size.

(1) When Class BS concrete is to be pumped, the coarse aggregate gradation shall have a minimum of 45 percent passing the 1/2 in. (12.5 mm) sieve. The Contractor may combine two or more coarse aggregate sizes, consisting of CA 7, CA 11, CA 13, CA 14, and CA 16, provided a CA 7 or CA 11 is included in the blend.

(2) If the coarse aggregate is furnished in separate sizes, they shall be combined in proportions to provide a uniformly graded coarse aggregate grading within the following limits.

Class of Concrete ^{1/}	Combined Sizes	Sieve Size and Percent Passing						
		2 1/2 in.	2 in.	1 3/4 in.	1 1/2 in.	1 in.	1/2 in.	No. 4
PV ^{2/}	CA 5 & CA 7	---	---	100	98±2	72±22	22±12	3±3
	CA 5 & CA 11	---	---	100	98±2	72±22	22±12	3±3
SI and SC ^{2/}	CA 3 & CA 7	100	95±5	---	---	55±25	20±10	3±3
	CA 3 & CA 11	100	95±5	---	---	55±25	20±10	3±3
	CA 5 & CA 7	---	---	100	98±2	72±22	22±12	3±3
	CA 5 & CA 11	---	---	100	98±2	72±22	22±12	3±3

Class of Concrete ^{1/}	Combined Sizes	Sieve Size (metric) and Percent Passing						
		63 mm	50 mm	45 mm	37.5 mm	25 mm	12.5 mm	4.75 mm
PV ^{2/}	CA 5 & CA 7	---	---	100	98±2	72±22	22±12	3±3
	CA 5 & CA 11	---	---	100	98±2	72±22	22±12	3±3
SI and SC ^{2/}	CA 3 & CA 7	100	95±5	---	---	55±25	20±10	3±3
	CA 3 & CA 11	100	95±5	---	---	55±25	20±10	3±3
	CA 5 & CA 7	---	---	100	98±2	72±22	22±12	3±3
	CA 5 & CA 11	---	---	100	98±2	72±22	22±12	3±3

1/ See Table 1 of Article 1020.04.

2/ Any of the listed combination of sizes may be used.”

Add the following to Article 1004.02 of the Standard Specifications:

(g) Alkali Reaction.

- (1) ASTM C 1260. Each coarse aggregate will be tested by the Department for alkali reaction according to ASTM C 1260. The test will be performed with Type I or II portland cement having a total equivalent alkali content ($\text{Na}_2\text{O} + 0.658\text{K}_2\text{O}$) of 0.90 percent or greater. The Engineer will determine the assigned expansion value for each aggregate, and these values will be made available on the Department's Alkali-Silica Potential Reactivity Rating List. The Engineer may differentiate aggregate based on ledge, production method, gradation number, or other factors. An expansion value of 0.05 percent will be assigned to limestone or dolomite coarse aggregates. However, the Department reserves the right to perform the ASTM C 1260 test.
- (2) ASTM C 1293 by Department. In some instances testing a coarse aggregate according to ASTM C 1260 may not provide accurate test results. In this case, the Department may only test according to ASTM C 1293.
- (3) ASTM C 1293 by Contractor. If an individual aggregate has an ASTM C 1260 expansion value that is unacceptable to the Contractor, an ASTM C 1293 test may be performed by the Contractor according to Article 1003.02(e)(3).

Revise the first paragraph of Article 1019.06 of the Standard Specifications to read:

“1019.06 Contractor Mix Design. A Contractor may submit their own mix design and may propose alternate fine aggregate materials, fine aggregate gradations, or material proportions. Article 1020.05(a) shall apply and a Level III PCC Technician shall develop the mix design.”

Revise Section 1020 of the Standard Specifications to read:

“SECTION 1020. PORTLAND CEMENT CONCRETE

1020.01 Description. This item shall consist of the materials, mix design, production, testing, curing, low air temperature protection, and temperature control of concrete.

1020.02 Materials. Materials shall be according to the following.

Item	Article/Section
(a) Cement	1001
(b) Water	1002
(c) Fine Aggregate	1003
(d) Coarse Aggregate	1004
(e) Concrete Admixtures	1021
(f) Finely Divided Minerals	1010
(g) Concrete Curing Materials	1022
(h) Straw	1081.06(a)(1)
(i) Calcium Chloride	1013.01

1020.03 Equipment. Equipment shall be according to the following.

Item	Article/Section
(a) Concrete Mixers and Trucks	1103.01
(b) Batching and Weighing Equipment	1103.02
(c) Automatic and Semi-Automatic Batching Equipment	1103.03
(d) Water Supply Equipment	1103.11
(e) Membrane Curing Equipment	1101.09
(f) Mobile Portland Cement Concrete Plants	1103.04

1020.04 Concrete Classes and General Mix Design Criteria. The classes of concrete shown in Table 1 identify the various mixtures by the general uses and mix design criteria. If the class of concrete for a specific item of construction is not specified, Class SI concrete shall be used.

For the minimum cement factor in Table 1, it shall apply to portland cement, portland-pozzolan cement, and portland blast-furnace slag except when a particular cement is specified in the Table.

The Contractor shall not assume that the minimum cement factor indicated in Table 1 will produce a mixture that will meet the specified strength. In addition, the Contractor shall not assume that the maximum finely divided mineral allowed in a mix design according to Article 1020.05(c) will produce a mixture that will meet the specified strength. The Contractor shall select a cement factor within the allowable range that will obtain the specified strength. The Contractor shall take into consideration materials selected, seasonal temperatures, and other factors which may require the Contractor to submit multiple mix designs.

For a portland-pozzolan cement, portland blast-furnace slag cement, or when replacing portland cement with finely divided minerals per Articles 1020.05(c) and 1020.05(d), the portland cement content in the mixture shall be a minimum of 375 lbs/cu yd (222 kg/cu m). When the total of organic processing additions, inorganic processing additions, and limestone exceed 5.0 percent in the cement, the minimum portland cement content in the mixture shall be 400 lbs/cu yd (237 kg/cu m). When calculating the portland cement portion in the portland-pozzolan or portland blast-furnace slag cement, the AASHTO M 240 tolerance may be ignored.

Special classifications may be made for the purpose of including the concrete for a particular use or location as a separate pay item in the contract. The concrete used in such cases shall conform to this section.

Various Routes
Section INT ATTRACT SIGN 2014-09
Various Counties
Contract No. 46270

TABLE 1. CLASSES OF CONCRETE AND MIX DESIGN CRITERIA												
Class of Conc.	Use	Specification Section Reference	Cement Factor		Water / Cement Ratio lb/lb	Slump in. (4)	Mix Design Compressive Strength (Flexural Strength) psi, minimum			Air Content %	Coarse Aggregate Gradations (14)	
			cwt/cu yd (3)	Min.			Max.	Days				
								3	14			28
PV	Pavement Base Course	420 or 421 353			0.32 - 0.42	2 - 4 (5)	Ty III 3500 (650)	3500 (650)		5.0 - 8.0 (5)	CA 5 & CA 7, CA 5 & CA 11, CA 7, CA 11, or CA 14	
	Base Course Widening	354	5.65 (1)	7.05								
	Driveway Pavement	423	6.05 (2)									
	Shoulders	483										
	Shoulder Curb	662										
PP	Pavement Patching Bridge Deck Patching (10)	442					3200 (600) Article 701.17(e)(3)b.				CA 7, CA 11, CA 13, CA 14, or CA 16	
	PP-1		6.50 6.20 (Ty III)	7.50 7.20 (Ty III)	0.32 - 0.44	2 - 4	at 48 hours			4.0 - 7.0		
	PP-2		7.35	8.20	0.32 - 0.38	2 - 6	at 24 hours			4.0 - 6.0		
	PP-3		7.35 (Ty III) (8)	7.35 (Ty III) (8)	0.32 - 0.35	2 - 4	at 16 hours			4.0 - 6.0		
	PP-4		6.00 (9)	6.25 (9)	0.32 - 0.50	2 - 6	at 8 hours			4.0 - 6.0		
	PP-5		6.75 (9)	6.75 (9)	0.32 - 0.40	2 - 8	at 4 hours			4.0 - 6.0		
RR	Railroad Crossing	422	6.50 6.20 (Ty III)	7.50 7.20 (Ty III)	0.32 - 0.44	2 - 4	3500 (650) at 48 hours			4.0 - 7.0	CA 7, CA 11, or CA 14	
BS	Bridge Superstructure Bridge Approach Slab	503	6.05	7.05	0.32 - 0.44	2 - 4 (5)		4000 (675)		5.0 - 8.0 (5)	CA 7, CA 11, or CA 14 (7)	
PC	Various Precast Concrete Items Wet Cast Dry Cast	1042	5.65 5.65 (TY III)	7.05 7.05 (TY III)	0.32 - 0.44 0.25 - 0.40	1 - 4 0 - 1	See Section 1042			5.0 - 8.0 N/A	CA7, CA11, CA 13, CA 14, CA 16, or CA 7 & CA 16	
PS	Precast Prestressed Members	504			0.32 - 0.44	1 - 4			Plans	5.0 - 8.0	CA 11 (11), CA 13, CA 14 (11), or CA 16	
	Precast Prestressed Piles and Extensions	512	5.65 5.65 (TY III)	7.05 7.05 (TY III)					5000			
	Precast Prestressed Sight Screen	639							3500			

Various Routes
Section INT ATTRACT SIGN 2014-09
Various Counties
Contract No. 46270

TABLE 1. CLASSES OF CONCRETE AND MIX DESIGN CRITERIA												
Class of Conc.	Use	Specification Section Reference	Cement Factor		Water / Cement Ratio lb/lb	Slump in. (4)	Mix Design Compressive Strength (Flexural Strength) psi, minimum			Air Content %	Coarse Aggregate Gradations (14)	
			cwt/cu yd (3)	Min.			Max.	Days				
								3	14			28
DS	Drilled Shaft (12) Metal Shell Piles (12) Sign Structures Drilled Shaft (12) Light Tower Foundation (12)	516 512 734 837	6.65	7.05	0.32 - 0.44	6 - 8 (6)		4000 (675)		5.0 - 8.0	CA 13, CA 14, CA 16, or a blend of these gradations.	
SC	Seal Coat	503	5.65 (1) 6.05 (2)	7.05	0.32 - 0.44	3 - 5		3500 (650)		Optional 6.0 max.	CA 3 & CA 7, CA 3 & CA 11, CA 5 & CA 7, CA 5 & CA 11, CA 7, or CA 11	
SI	Structures (except Superstructure) Sidewalk Slope Wall Encasement Box Culverts End Section and Collar Curb, Gutter, Curb & Gutter, Median, and Paved Ditch Concrete Barrier Sign Structures Spread Footing Concrete Foundation Pole Foundation (12) Traffic Signal Foundation Drilled Shaft (12) Square or Rectangular	503 424 511 512 540 542 606 637 734 836 878	5.65 (1) 6.05 (2)	7.05	0.32 - 0.44	2 - 4 (5)		3500 (650)		5.0 - 8.0 (5)	CA 3 & CA 7, CA 3 & CA 11, CA 5 & CA 7, CA 5 & CA 11, CA 7, CA 11, CA 13, CA 14, or CA 16 (13)	

- Notes:
- (1) Central-mixed.
 - (2) Truck-mixed or shrink-mixed.
 - (3) For Class SC concrete and for any other class of concrete that is to be placed underwater, except Class DS concrete, the cement factor shall be increased by ten percent.
 - (4) The maximum slump may be increased to 7 in. when a high range water-reducing admixture is used for all classes of concrete, except Class PV, SC, and PP. For Class SC, the maximum slump may be increased to 8 in. For Class PP-1, the maximum slump may be increased to 6 in. For Class PS, the 7 in. maximum slump may be increased to 8 1/2 in. if the high range water-reducing admixture is the polycarboxylate type.
 - (5) The slump range for slipform construction shall be 1/2 to 2 1/2 in. and the air content range shall be 5.5 to 8.0 percent.
 - (6) If concrete is placed to displace drilling fluid, or against temporary casing, the slump shall be 8 - 10 in. at the point of placement. If a water-reducing admixture is used in lieu of a high range water-reducing admixture according to Article 1020.05(b)(7), the slump shall be 2 - 4 in.
 - (7) For Class BS concrete used in bridge deck patching, the coarse aggregate gradation shall be CA 13, CA 14, or CA 16, except CA 11 may be used for full-depth patching.
 - (8) In addition to the Type III portland cement, 100 lb/cu yd of ground granulated blast-furnace slag and 50 lb/cu yd of microsilica (silica fume) shall be used. For an air temperature greater than 85 °F, the Type III portland cement may be replaced with Type I or II portland cement.
 - (9) The cement shall be a rapid hardening cement from the Department's "Approved List of Packaged, Dry, Rapid Hardening Cementitious Materials for Concrete Repairs" for PP-4 and calcium aluminate cement for PP-5.
 - (10) For Class PP concrete used in bridge deck patching, the coarse aggregate gradation shall be CA 13, CA 14, or CA 16, except CA 11 may be used for full-depth patching. In addition, the mix design shall have 72 hours to obtain a 4,000 psi compressive or 675 psi flexural strength for all PP mix designs.
 - (11) The nominal maximum size permitted is 3/4 in. Nominal maximum size is defined as the largest sieve which retains any of the aggregate sample particles.
 - (12) The concrete mix shall be designed to remain fluid throughout the anticipated duration of the pour plus one hour. At the Engineer's discretion, the Contractor may be required to conduct a minimum 2 cu yd trial batch to verify the mix design.
 - (13) CA 3 or CA 5 may be used when the nominal maximum size does not exceed two-thirds the clear distance between parallel reinforcement bars, or between the reinforcement bar and the form. Nominal maximum size is defined in Note 11.
 - (14) Alternate combinations of gradation sizes may be used with the approval of the Engineer. Refer also to Article 1004.02(d) for additional information on combining sizes.

Various Routes
Section INT ATTRACT SIGN 2014-09
Various Counties
Contract No. 46270

TABLE 1. CLASSES OF CONCRETE AND MIX DESIGN CRITERIA (metric)											
Class of Conc.	Use	Specification Section Reference	Cement Factor		Water / Cement Ratio kg/kg	S l u m p mm (4)	Mix Design Compressive Strength (Flexural Strength) kPa, minimum			Air Content %	Coarse Aggregate Gradations (14)
			kg/cu m (3)				Days				
			Min.	Max			3	14	28		
PV	Pavement Base Course	420 or 421 353									CA 5 & CA 7, CA 5 & CA 11, CA 7, CA 11, or CA 14
	Base Course Widening	354	335 (1)	418	0.32 - 0.42	50 - 100	Ty III 24,000 (4500)	24,000 (4500)		5.0 - 8.0 (5)	
	Driveway Pavement	423	360 (2)								
	Shoulders	483									
	Shoulder Curb	662									
PP	Pavement Patching Bridge Deck Patching (10)	442					22,100 (4150) Article 701.17(e)(3)b.				CA 7, CA 11, CA 13, CA 14, or CA 16
	PP-1		385 365 (Ty III)	445 425 (Ty III)	0.32 - 0.44	50 - 100	at 48 hours			4.0 - 7.0	
	PP-2		435	485	0.32 - 0.38	50 - 150	at 24 hours			4.0 - 6.0	
	PP-3		435 (Ty III) (8)	435 (Ty III) (8)	0.32 - 0.35	50 - 100	at 16 hours			4.0 - 6.0	
	PP-4		355 (9)	370 (9)	0.32 - 0.50	50 - 150	at 8 hours			4.0 - 6.0	
	PP-5		400 (9)	400 (9)	0.32 - 0.40	50 - 200	at 4 hours			4.0 - 6.0	
RR	Railroad Crossing	422	385 365 (Ty III)	445 425 (Ty III)	0.32 - 0.44	50 - 100	24,000 (4500) at 48 hours			4.0 - 7.0	CA 7, CA 11, or CA 14
BS	Bridge Superstructure Bridge Approach Slab	503	360	418	0.32 - 0.44	50 - 100 (5)		27,500 (4650)		5.0 - 8.0 (5)	CA 7, CA 11, or CA 14 (7)
PC	Various Precast Concrete Items Wet Cast Dry Cast	1042	335 335 (TY III)	418 418 (TY III)	0.32 - 0.44 0.25 - 0.40	25 - 100 0 - 25	See Section 1042			5.0 - 8.0 N/A	CA7, CA11, CA13, CA 14, CA 16, or CA 7 & CA 16
PS	Precast Prestressed Members	504							Plans	5.0 - 8.0	CA 11 (11), CA 13, CA 14 (11), or CA 16
	Precast Prestressed Piles and Extensions	512	335 335 (TY III)	418 418 (TY III)	0.32 - 0.44	25 - 100			34,500		
	Precast Prestressed Sight Screen	639							24,000		

Various Routes
Section INT ATTRACT SIGN 2014-09
Various Counties
Contract No. 46270

TABLE 1. CLASSES OF CONCRETE AND MIX DESIGN CRITERIA (metric)											
Class of Conc.	Use	Specification Section Reference	Cement Factor		Water / Cement Ratio kg/kg	S l u m p mm (4)	Mix Design Compressive Strength (Flexural Strength)			Air Content %	Coarse Aggregate Gradations (14)
			kg/cu m (3)				kPa, minimum				
			Min.	Max			Days				
						3	14	28			
DS	Drilled Shaft (12) Metal Shell Piles (12) Sign Structures Drilled Shaft (12) Light Tower Foundation (12)	516 512 734 837	395	418	0.32 - 0.44	150 -200 (6)		27,500 (4650)		5.0 - 8.0	CA 13, CA 14, CA 16, or a blend of these gradations.
SC	Seal Coat	503	335 (1) 360 (2)	418	0.32 - 0.44	75 - 125		24,000 (4500)		Optional 6.0 max.	CA 3 & CA 7, CA 3 & CA 11, CA 5 & CA 7, CA 5 & CA 11, CA 7, or CA 11
SI	Structures (except Superstructure) Sidewalk Slope Wall Encasement Box Culverts End Section and Collar Curb, Gutter, Curb & Gutter, Median, and Paved Ditch Concrete Barrier Sign Structures Spread Footing Concrete Foundation Pole Foundation (12) Traffic Signal Foundation Drilled Shaft (12) Square or Rectangular	503 424 511 512 540 542 606 637 734 836 878	335 (1) 360 (2)	418	0.32 - 0.44	50 - 100 (5)		24,000 (4500)		5.0 - 8.0 (5)	CA 3 & CA 7, CA 3 & CA 11, CA 5 & CA 7, CA 5 & CA 11, CA 7, CA 11, CA 13, CA 14, or CA 16 (13)

- Notes:
- (1) Central-mixed.
 - (2) Truck-mixed or shrink-mixed.
 - (3) For Class SC concrete and for any other class of concrete that is to be placed underwater, except Class DS concrete, the cement factor shall be increased by ten percent.
 - (4) The maximum slump may be increased to 175 mm when a high range water-reducing admixture is used for all classes of concrete except Class PV, SC, and PP. For Class SC, the maximum slump may be increased to 200 mm. For Class PP-1, the maximum slump may be increased to 150 mm. For Class PS, the 175 mm maximum slump may be increased to 215 mm if the high range water-reducing admixture is the polycarboxylate type.
 - (5) The slump range for slipform construction shall be 13 to 64 mm and the air content range shall be 5.5 to 8.0 percent.
 - (6) If concrete is placed to displace drilling fluid, or against temporary casing, the slump shall be 200 - 250 mm at the point of placement. If a water-reducing admixture is used in lieu of a high range water-reducing admixture according to Article 1020.05(b)(7), the slump shall be 50 – 100 mm.
 - (7) For Class BS concrete used in bridge deck patching, the coarse aggregate gradation shall be CA 13, CA 14, or CA 16, except CA 11 may be used for full-depth patching.
 - (8) In addition to the Type III portland cement, 60 kg/cu m of ground granulated blast-furnace slag and 30 kg/cu m of microsilica (silica fume) shall be used. For an air temperature greater than 30 °C, the Type III portland cement may be replaced with Type I or II portland cement.
 - (9) The cement shall be a rapid hardening cement from the Department's "Approved List of Packaged, Dry, Rapid Hardening Cementitious Materials for Concrete Repairs" for PP-4 and calcium aluminate cement for PP-5.
 - (10) For Class PP concrete used in bridge deck patching, the coarse aggregate gradation shall be CA 13, CA 14, or CA 16, except CA 11 may be used for full-depth patching. In addition, the mix design shall have 72 hours to obtain a 27,500 kPa compressive or 4,650 kPa flexural.
 - (11) The nominal maximum size permitted is 19 mm. Nominal maximum size is defined as the largest sieve which retains any of the aggregate sample particles.
 - (12) The concrete mix shall be designed to remain fluid throughout the anticipated duration of the pour plus one hour. At the Engineer's discretion, the Contractor may be required to conduct a minimum 1.5 cu m trial batch to verify the mix design.
 - (13) CA 3 or CA 5 may be used when the nominal maximum size does not exceed two-thirds the clear distance between parallel reinforcement bars, or between the reinforcement bar and the form. Nominal maximum size is defined in Note 11.
 - (14) Alternate combinations of gradation sizes may be used with the approval of the Engineer. Refer also to Article 1004.02(d) for additional information on combining sizes.

Self-consolidating concrete is a flowable mixture that does not require mechanical vibration for consolidation. Self-consolidating concrete mix designs may be developed for Class BS, PC, PS, DS, and SI concrete. Self-consolidating concrete mix designs may also be developed for precast concrete products that are not subjected to Class PC concrete requirements according to Section 1042. The mix design criteria for the concrete mixture shall be according to Article 1020.04 with the following exceptions.

- (a) The slump requirements shall not apply.
- (b) The concrete mixture should be uniformly graded, and information in the "Portland Cement Concrete Level III Technician Course – Manual of Instructions for Design of Concrete Mixtures" may be used to develop the uniformly graded mix design. The coarse aggregate gradations shall be CA 11, CA 13, CA 14, CA 16, or a blend of these gradations. However, the final gradation when using a single coarse aggregate or combination of coarse aggregates shall have 100 percent pass the 1 in. (25 mm) sieve, and minimum 95 percent pass the 3/4 in. (19 mm) sieve. The fine aggregate proportion shall be a maximum 50 percent by weight (mass) of the total aggregate used.
- (c) The slump flow range shall be 22 in. (560 mm) minimum to 28 in. (710 mm) maximum and tested according to Illinois Test Procedure SCC-2.
- (d) The visual stability index shall be a maximum of 1 and tested according to Illinois Test Procedure SCC-2.
- (e) The J-Ring value shall be a maximum of 2 in. (50 mm) and tested according to Illinois Test Procedure SCC-3. The L-Box blocking ratio shall be a minimum of 80 percent and tested according to Illinois Test Procedure SCC-3. The Contractor has the option to select either test.
- (f) The hardened visual stability index shall be a maximum of 1 and tested according to Illinois Test Procedure SCC-6.
- (g) If Class PC concrete requirements do not apply to the precast concrete product according to Section 1042, the maximum cement factor shall be 7.05 cwt/cu yd (418 kg/cu m) and the maximum allowable water/cement ratio shall be 0.44.
- (h) If the measured slump flow, visual stability index, J-Ring value, or L-Box blocking ratio fall outside the limits specified, a check test will be made. In the event of a second failure, the Engineer may refuse to permit the use of the batch of concrete represented.

The Contractor may use water or self-consolidating admixtures at the jobsite to obtain the specified slump flow, visual stability index, J-ring value, or L-box blocking ratio. The maximum design water/cement ratio shall not be exceeded.

1020.05 Other Concrete Criteria. The concrete shall be according to the following.

- (a) Proportioning and Mix Design. For all Classes of concrete, it shall be the Contractor's responsibility to determine mix design material proportions and to proportion each batch of concrete. A Level III PCC Technician shall develop the mix design for all Classes of concrete, except Classes PC and PS. The mix design, submittal information, trial batch, and Engineer verification shall be according to the "Portland Cement Concrete Level III Technician" course material.

The Contractor shall provide the mix designs a minimum of 45 calendar days prior to production. More than one mix design may be submitted for each class of concrete.

The Engineer will verify the mix design submitted by the Contractor. Verification of a mix design shall in no manner be construed as acceptance of any mixture produced. Once a mix design has been verified, the Engineer shall be notified of any proposed changes.

Tests performed at the jobsite will determine if a mix design can meet specifications. If the tests indicate it cannot, the Contractor shall make adjustments to a mix design, or submit a new mix design if necessary, to comply with the specifications.

- (b) Admixtures. The Contractor shall be responsible for using admixtures and determining dosages for all Classes of concrete, cement aggregate mixture II, and controlled low-strength material that will produce a mixture with suitable workability, consistency, and plasticity. In addition, admixture dosages shall result in the mixture meeting the specified plastic and hardened properties. The Contractor shall obtain approval from the Engineer to use an accelerator when the concrete temperature is greater than 60 °F (16 °C). However, this accelerator approval by the Engineer will not be required for Class PP, RR, PC, and PS concrete. The accelerator shall be the non-chloride type unless otherwise specified in the contract plans.

The Department will maintain an Approved List of Corrosion Inhibitors. Corrosion inhibitor dosage rates shall be according to Article 1020.05(b)(10). For information on approved controlled low-strength material air-entraining admixtures, refer to Article 1019.02. The Department will also maintain an Approved List of Concrete Admixtures, and an admixture technical representative shall be consulted by the Contractor prior to the pour when determining an admixture dosage from this list or when making minor admixture dosage adjustments at the jobsite. The dosage shall be within the range indicated on the approved list unless the influence by other admixtures, jobsite conditions (such as a very short haul time), or other circumstances warrant a dosage outside the range. The Engineer shall be notified when a dosage is proposed outside the range. To determine an admixture dosage, air temperature, concrete temperature, cement source and quantity, finely divided mineral sources and quantity, influence of other admixtures, haul time, placement conditions, and other factors as appropriate shall be considered. The Engineer may request the Contractor to have a batch of concrete mixed in the lab or field to verify the admixture dosage is correct. An admixture dosage or combination of admixture dosages shall not delay the initial set of concrete by more than one hour. When a retarding admixture is required or appropriate for a bridge deck or bridge deck overlay pour, the initial set time shall be delayed until the deflections due to the concrete dead load are no longer a concern for inducing cracks in the completed work. However, a retarding admixture shall not be used to further extend the pour time and justify the alteration of a bridge deck pour sequence.

When determining water in admixtures for water/cement ratio, the Contractor shall calculate 70 percent of the admixture dosage as water, except a value of 50 percent shall be used for a latex admixture used in bridge deck latex concrete overlays.

The sequence, method, and equipment for adding the admixtures shall be approved by the Engineer. Admixtures shall be added to the concrete separately. An accelerator shall always be added prior to a high range water-reducing admixture, if both are used.

Admixture use shall be according to the following.

- (1) When the atmosphere or concrete temperature is 65 °F (18 °C) or higher, a retarding admixture shall be used in the Class BS concrete and concrete bridge deck overlays. The proportions of the ingredients of the concrete shall be the same as without the retarding admixture, except that the amount of mixing water shall be reduced, as may be necessary, in order to maintain the consistency of the concrete as required. In addition, a high range water-reducing admixture shall be used in bridge deck concrete. At the option of the Contractor, a water-reducing admixture may be used with the high range water-reducing admixture in Class BS concrete.
- (2) At the Contractor's option, admixtures in addition to an air-entraining admixture may be used for Class PP-1 or RR concrete. When the air temperature is less than 55 °F (13 °C) and an accelerator is used, the non-chloride accelerator shall be calcium nitrite.
- (3) When Class C fly ash or ground granulated blast-furnace slag is used in Class PP-1 or RR concrete, a water-reducing or high range water-reducing admixture shall be used.

(4) For Class PP-2 or PP-3 concrete, a non-chloride accelerator followed by a high range water-reducing admixture shall be used, in addition to the air-entraining admixture. The Contractor has the option to use a water-reducing admixture with the high range water-reducing admixture. For Class PP-3 concrete, the non-chloride accelerator shall be calcium nitrite. For Class PP-2 concrete, the non-chloride accelerator shall be calcium nitrite when the air temperature is less than 55 °F (13 °C).

(5) For Class PP-4 concrete, a high range water-reducing admixture shall be used in addition to the air-entraining admixture. The Contractor has the option to use a water-reducing admixture with the high range water-reducing admixture. An accelerator shall not be used. For stationary or truck-mixed concrete, a retarding admixture shall be used to allow for haul time. The Contractor has the option to use a mobile portland cement concrete plant, but a retarding admixture shall not be used unless approved by the Engineer.

For PP-5 concrete, a non-chloride accelerator, high range water-reducing admixture, and air-entraining admixture shall be used. The accelerator, high range water-reducing admixture, and air-entraining admixture shall be per the Contractor's recommendation and dosage. The approved list of concrete admixtures shall not apply. A mobile portland cement concrete plant shall be used to produce the patching mixture.

(6) When a calcium chloride accelerator is specified in the contract, the maximum chloride dosage shall be 1.0 quart (1.0 L) of solution per 100 lb (45 kg) of cement. The dosage may be increased to a maximum 2.0 quarts (2.0 L) per 100 lb (45 kg) of cement if approved by the Engineer. When a calcium chloride accelerator for Class PP-2 concrete is specified in the contract, the maximum chloride dosage shall be 1.3 quarts (1.3 L) of solution per 100 lb (45 kg) of cement. The dosage may be increased to a maximum 2.6 quarts (2.6 L) per 100 lb (45 kg) of cement if approved by the Engineer.

(7) For Class DS concrete a retarding admixture and a high range water-reducing admixture shall be used. For dry excavations that are 10 ft (3 m) or less, the high range water-reducing admixture may be replaced with a water-reducing admixture if the concrete is vibrated. The use of admixtures shall take into consideration the slump loss limits specified in Article 516.12 and the fluidity requirement in Article 1020.04 (Note 12).

(8) At the Contractor's option, when a water-reducing admixture or a high range water-reducing admixture is used for Class PV, PP-1, RR, SC, and SI concrete, the cement factor may be reduced a maximum 0.30 hundredweight/cu yd (18 kg/cu m). However, a cement factor reduction will not be allowed for concrete placed underwater.

(9) When Type F or Type G high range water-reducing admixtures are used, the initial slump shall be a minimum of 1 1/2 in. (40 mm) prior to addition of the Type F or Type G admixture, except as approved by the Engineer.

- (10) When specified, a corrosion inhibitor shall be added to the concrete mixture utilized in the manufacture of precast, prestressed concrete members and/or other applications. It shall be added, at the same rate, to all grout around post-tensioning steel when specified.

When calcium nitrite is used, it shall be added at the rate of 4 gal/cu yd (20 L/cu m), and shall be added to the mix immediately after all compatible admixtures have been introduced to the batch.

When Rheocrete 222+ is used, it shall be added at the rate of 1.0 gal/cu yd (5.0 L/cu m), and the batching sequence shall be according to the manufacturer's instructions.

- (c) Finely Divided Minerals. Use of finely divided minerals shall be according to the following.

- (1) Fly Ash. At the Contractor's option, fly ash from approved sources may partially replace portland cement in cement aggregate mixture II, Class PV, PP-1, PP-2, RR, BS, PC, PS, DS, SC, and SI concrete.

The use of fly ash shall be according to the following.

- a. Measurements of fly ash and portland cement shall be rounded up to the nearest 5 lb (2.5 kg).
 - b. When Class F fly ash is used in cement aggregate mixture II, Class PV, BS, PC, PS, DS, SC, and SI concrete, the amount of portland cement replaced shall not exceed 25 percent by weight (mass).
 - c. When Class C fly ash is used in cement aggregate mixture II, Class PV, PP-1, PP-2, RR, BS, PC, PS, DS, SC, and SI concrete, the amount of portland cement replaced shall not exceed 30 percent by weight (mass).
 - d. Fly ash may be used in concrete mixtures when the air temperature is below 40 °F (4 °C), but the Engineer may request a trial batch of the concrete mixture to show the mix design strength requirement will be met.
- (2) Ground Granulated Blast-Furnace (GGBF) Slag. At the Contractor's option, GGBF slag may partially replace portland cement in Class PV, PP-1, PP-2, RR, BS, PC, PS, DS, SC, and SI concrete. For Class PP-3 concrete, GGBF slag shall be used according to Article 1020.04.

The use of GGBF slag shall be according to the following.

- a. Measurements of GGBF slag and portland cement shall be rounded up to the nearest 5 lb (2.5 kg).
- b. When GGBF slag is used in Class PV, PP-1, PP-2, RR, BS, PC, PS, DS, SC and SI concrete, the amount of portland cement replaced shall not exceed 35 percent by weight (mass).

- c. GGBF slag may be used in concrete mixtures when the air temperature is below 40 °F (4 °C), but the Engineer may request a trial batch of the concrete mixture to show the mix design strength requirement will be met.
- (3) Microsilica. At the Contractor's option, microsilica may be added at a maximum of 5.0 percent by weight (mass) of the cement and finely divided minerals summed together.

Microsilica shall be used in Class PP-3 concrete according to Article 1020.04.

- (4) High Reactivity Metakaolin (HRM). At the Contractor's option, HRM may be added at a maximum of 5.0 percent by weight (mass) of the cement and finely divided minerals summed together.
- (5) Mixtures with Multiple Finely Divided Minerals. Except as specified for Class PP-3 concrete, the Contractor has the option to use more than one finely divided mineral in Class PV, PP-1, PP-2, RR, BS, PC, PS, DS, SC, and SI concrete as follows.
- a. The mixture shall contain a maximum of two finely divided minerals. The finely divided mineral in portland-pozzolan cement or portland blast-furnace slag cement shall count toward the total number of finely divided minerals allowed. The finely divided minerals shall constitute a maximum of 35.0 percent of the total cement plus finely divided minerals. The fly ash portion shall not exceed 30.0 percent for Class C fly ash or 25.0 percent for Class F fly ash. The Class C and F fly ash combination shall not exceed 30.0 percent. The ground granulated blast-furnace slag portion shall not exceed 35.0 percent. The microsilica or high-reactivity metakaolin portion used together or separately shall not exceed ten percent. The finely divided mineral in the portland-pozzolan cement or portland blast-furnace slag blended cement shall apply to the maximum 35.0 percent.
 - b. Central Mixed. For Class PV, SC, and SI concrete, the mixture shall contain a minimum of 565 lbs/cu yd (335 kg/cu m) of cement and finely divided minerals summed together. If a water-reducing or high-range water-reducing admixture is used, the Contractor has the option to use a minimum of 535 lbs/cu yd (320 kg/cu m).
 - c. Truck-Mixed or Shrink-Mixed. For Class PV, SC, and SI concrete, the mixture shall contain a minimum of 605 lbs/cu yd (360 kg/cu m) of cement and finely divided minerals summed together. If a water-reducing or high-range water-reducing admixture is used, the Contractor has the option to use a minimum of 575 lbs/cu yd (345 kg/cu m).
 - d. Central-Mixed, Truck-Mixed or Shrink-Mixed. For Class PP-1 and RR concrete, the mixture shall contain a minimum of 650 lbs/cu yd (385 kg/cu m) of cement and finely divided minerals summed together. For Class PP-1 and RR concrete using Type III portland cement, the mixture shall contain a minimum of 620 lbs/cu yd (365 kg/cu m).

For Class PP-2 concrete, the mixture shall contain a minimum of 735 lbs/cu yd (435 kg/cu m) of cement and finely divided minerals summed together. For Class BS concrete, the mixture shall contain a minimum of 605 lbs/cu yd (360 kg/cu m). For Class DS concrete, the mixture shall contain a minimum of 665 lbs/cu yd (395 kg/cu m).

If a water-reducing or high range water-reducing admixture is used in Class PP-1 and RR concrete, the Contractor has the option to use a minimum of 620 lbs/cu yd (365 kg/cu m) of cement and finely divided minerals summed together. If a water-reducing or high-range water-reducing admixture is used with Type III portland cement in Class PP-1 and RR concrete, the Contractor has the option to use a minimum of 590 lbs/cu yd (350 kg/cu m).

- e. Central-Mixed or Truck-Mixed. For Class PC and PS concrete, the mixture shall contain a minimum of 565 lbs/cu yd (335 kg/cu m) of cement and finely divided minerals summed together.
 - f. The mixture shall contain a maximum of 705 lbs/cu yd (418 kg/cu m) of cement and finely divided mineral(s) summed together for Class PV, BS, PC, PS, DS, SC, and SI concrete. For Class PP-1 and RR concrete, the mixture shall contain a maximum of 750 lbs/cu yd (445 kg/cu m). For Class PP-1 and RR concrete using Type III portland cement, the mixture shall contain a maximum of 720 lbs/cu yd (425 kg/cu m). For Class PP-2 concrete, the mixture shall contain a maximum of 820 lbs/cu yd (485 kg/cu m).
 - g. For Class SC concrete and for any other class of concrete that is to be placed underwater, except Class DS concrete, the allowable cement and finely divided minerals summed together shall be increased by ten percent.
 - h. The combination of cement and finely divided minerals shall comply with Article 1020.05(d).
- (d) Alkali-Silica Reaction. For cast-in-place (includes cement aggregate mixture II and latex mixtures), precast, and precast prestressed concrete, one of the mixture options provided in Article 1020.05(d)(2) shall be used to reduce the risk of a deleterious alkali-silica reaction in concrete exposed to humid or wet conditions. The mixture options are not intended or adequate for concrete exposed to potassium acetate, potassium formate, sodium acetate, or sodium formate. The mixture options will not be required for the dry environment (humidity less than 60 percent) found inside buildings for residential or commercial occupancy.

The mixture options shall not apply to concrete revetment mats, insertion lining of pipe culverts, portland cement mortar fairing course, controlled low-strength material, miscellaneous grouts that are not prepackaged, Class PP-3 concrete, Class PP-4 concrete, and Class PP-5 concrete.

- (1) Aggregate Groups. Each combination of aggregates used in a mixture will be assigned to an aggregate group. The point at which the coarse aggregate and fine aggregate expansion values intersect in the following table will determine the group.

Aggregate Groups			
Coarse Aggregate or Coarse Aggregate Blend ASTM C 1260 Expansion	Fine Aggregate Or Fine Aggregate Blend ASTM C 1260 Expansion		
	≤0.16%	>0.16% - 0.27%	>0.27%
≤0.16%	Group I	Group II	Group III
>0.16% - 0.27%	Group II	Group II	Group III
>0.27%	Group III	Group III	Group IV

- (2) Mixture Options. Based upon the aggregate group, the following mixture options shall be used. However, the Department may prohibit a mixture option if field performance shows a deleterious alkali-silica reaction or Department testing indicates the mixture may experience a deleterious alkali-silica reaction.

Reduction of Risk for Deleterious Alkali-Silica Reaction					
Aggregate Groups	Mixture Options				
	Option 1	Option 2	Option 3	Option 4	Option 5
Group I	Mixture options are not applicable. Use any cement or finely divided mineral.				
Group II	X	X	X	X	X
Group III	X	Combine Option 2 with Option 3	Combine Option 2 with Option 3	X	X
Group IV	X	Combine Option 2 with Option 4	Invalid Option	Combine Option 2 with Option 4	X

“X” denotes valid mixture option for aggregate group.

- a. Mixture Option 1. The coarse or fine aggregates shall be blended to place the material in a group that will allow the selected cement or finely divided mineral to be used. Coarse aggregate may only be blended with another coarse aggregate. Fine aggregate may only be blended with another fine aggregate. Blending of coarse with fine aggregate to place the material in another group will not be permitted.

When a coarse or fine aggregate is blended, the weighted expansion value shall be calculated separately for the coarse and fine aggregate as follows:

$$\text{Weighted Expansion Value} = (a/100 \times A) + (b/100 \times B) + (c/100 \times C) + \dots$$

Where: a, b, c... = percentage of aggregate in the blend;
A, B, C... = expansion value for that aggregate.

- b. Mixture Option 2. A finely divided mineral shall be used as described in 1), 2), 3), or 4) that follow. In addition, a blended cement with a finely divided mineral may be added to a separate finely divided mineral to meet the following requirements, provided the finely divided minerals are the same material. However, adding together two different finely divided minerals to obtain the specified minimum percentage of one material will not be permitted for 1), 2), 3), and 4). Refer to Mixture Option 5 to address this situation.

1. Class F Fly Ash. For cement aggregate mixture II, Class PV, BS, PC, PS, MS, DS, SC and SI concrete, the Class F fly ash shall be a minimum 25.0 percent by weight (mass) of the cement and finely divided minerals summed together.

If the maximum total equivalent available alkali content ($\text{Na}_2\text{O} + 0.658\text{K}_2\text{O}$) exceeds 4.50 percent for the Class F fly ash, it may be used only if it complies with Mixture Option 5.

2. Class C Fly Ash. For cement aggregate mixture II, Class PV, PP-1, PP-2, RR, BS, PC, PS, DS, SC, and SI concrete, Class C fly ash shall be a minimum of 25.0 percent by weight (mass) of the cement and finely divided minerals summed together.

If the maximum total equivalent available alkali content ($\text{Na}_2\text{O} + 0.658\text{K}_2\text{O}$) exceeds 4.50 percent or the calcium oxide exceeds 26.50 percent for the Class C fly ash, it may be used only per Mixture Option 5.

3. Ground Granulated Blast-Furnace Slag. For Class PV, PP-1, PP-2, RR, BS, PC, PS, DS, SC, and SI concrete, ground granulated blast-furnace slag shall be a minimum of 25.0 percent by weight (mass) of the cement and finely divided minerals summed together.

If the maximum total equivalent available alkali content ($\text{Na}_2\text{O} + 0.658\text{K}_2\text{O}$) exceeds 1.00 percent for the ground granulated blast-furnace slag, it may be used only per Mixture Option 5.

4. Microsilica or High Reactivity Metakaolin, Microsilica solids or high reactivity metakaolin shall be a minimum 5.0 percent by weight (mass) of the cement and finely divided minerals summed together.

If the maximum total equivalent available alkali content ($\text{Na}_2\text{O} + 0.658\text{K}_2\text{O}$) exceeds 1.00 percent for the Microsilica or High Reactivity Metakaolin, it may be used only if it complies with Mixture Option 5.

- c. Mixture Option 3. The cement used shall have a maximum total equivalent alkali content ($\text{Na}_2\text{O} + 0.658\text{K}_2\text{O}$) of 0.60 percent. When aggregate in Group II is involved and the Contractor desires to use a finely divided mineral, any finely divided mineral may be used with the cement unless the maximum total equivalent available alkali content ($\text{Na}_2\text{O} + 0.658\text{K}_2\text{O}$) exceeds 4.50 percent for the fly ash; or 1.00 percent for the ground granulated blast-furnace slag, microsilica or high reactivity metakaolin. If the alkali content is exceeded, the finely divided mineral may be used only per Mixture Option 5.
- d. Mixture Option 4. The cement used shall have a maximum total equivalent alkali content ($\text{Na}_2\text{O} + 0.658\text{K}_2\text{O}$) of 0.45 percent. When aggregate in Group II or III is involved and the Contractor desires to use a finely divided mineral, any finely divided mineral may be used with the cement unless the maximum total equivalent available alkali content ($\text{Na}_2\text{O} + 0.658\text{K}_2\text{O}$) exceeds 4.50 percent for the fly ash; or 1.00 percent for the ground granulated blast-furnace slag, microsilica, or high reactivity metakaolin. If the alkali content is exceeded, the finely divided mineral may be used only per Mixture Option 5.
- e. Mixture Option 5. The proposed cement or finely divided mineral may be used if the ASTM C 1567 expansion value is ≤ 0.16 percent when performed on the aggregate in the concrete mixture with the highest ASTM C 1260 test result. The laboratory performing the ASTM C 1567 test shall be approved by the Department according to the current Bureau of Materials and Physical Research Policy Memorandum "Minimum Laboratory Requirements for Alkali-Silica Reactivity (ASR) Testing". The ASTM C 1567 test will be valid for two years, unless the Engineer determines the materials have changed significantly.

For latex concrete, the ASTM C 1567 test shall be performed without the latex.

The 0.20 percent autoclave expansion limit in ASTM C 1567 shall not apply.

If during the two year time period the Contractor needs to replace the cement, and the replacement cement has an equal or lower total equivalent alkali content ($\text{Na}_2\text{O} + 0.658\text{K}_2\text{O}$), a new ASTM C 1567 test will not be required.

The Engineer reserved the right to verify a Contractor's ASTM C 1567 test result. When the Contractor performs the test, a split sample may be requested by the Engineer. The Engineer may also independently obtain a sample at any time. The proposed cement or finely divided mineral will not be allowed for use if the Contractor or Engineer obtains an expansion value greater than 0.16 percent.

1020.06 Water/Cement Ratio. The water/cement ratio shall be determined on a weight (mass) basis. When a maximum water/cement ratio is specified, the water shall include mixing water, water in admixtures, free moisture on the aggregates, and water added at the jobsite. The quantity of water may be adjusted within the limit specified to meet slump requirements.

When fly ash, ground granulated blast-furnace slag, high-reactivity metakaolin, or microsilica (silica fume) are used in a concrete mix, the water/cement ratio will be based on the total cement and finely divided minerals contained in the mixture.

1020.07 Slump. The slump shall be determined according to Illinois Modified AASHTO T 119.

If the measured slump falls outside the limits specified, a check test will be made. In the event of a second failure, the Engineer may refuse to permit the use of the batch of concrete represented.

If the Contractor is unable to add water to prepare concrete of the specified slump without exceeding the maximum design water/cement ratio, a water-reducing admixture shall be added.

1020.08 Air Content. The air content shall be determined according to Illinois Modified AASHTO T 152 or Illinois Modified AASHTO T 196. The air-entrainment shall be obtained by the use of cement with an approved air-entraining admixture added during the mixing of the concrete or the use of air-entraining cement.

If the air-entraining cement furnished is found to produce concrete having air content outside the limits specified, its use shall be discontinued immediately and the Contractor shall provide other air-entraining cement which will produce air contents within the specified limits.

If the air content obtained is above the specified maximum limit at the jobsite, the Contractor may have the concrete further mixed, within the limits of time and revolutions specified, to reduce the air content. If the air content obtained is below the specified minimum limit, the Contractor may add to the concrete a sufficient quantity of an approved air-entraining admixture at the jobsite to bring the air content within the specified limits.

1020.09 Strength Tests. The specimens shall be molded and cured according to Illinois Modified AASHTO T 23. Specimens shall be field cured with the construction item as specified in Illinois Modified AASHTO T 23. The compressive strength shall be determined according to Illinois Modified AASHTO T 22. The flexural strength shall be determined according to Illinois Modified AASHTO T 177.

Except for Class PC and PS concrete, the Contractor shall transport the strength specimens from the site of the work to the field laboratory or other location as instructed by the Engineer. During transportation in a suitable light truck, the specimens shall be embedded in straw, burlap, or other acceptable material in a manner meeting with the approval of the Engineer to protect them from damage; care shall be taken to avoid impacts during hauling and handling. For strength specimens, the Contractor shall provide a field curing box for initial curing and a water storage tank for final curing. The field curing box will be required when an air temperature below 60 °F (16 °C) is expected during the initial curing period. The device shall maintain the initial curing temperature range specified in Illinois Modified AASHTO T 23, and may be insulated or power operated as appropriate.

1020.10 Handling, Measuring, and Batching Materials. Aggregates shall be handled in a manner to prevent mixing with soil and other foreign material.

Aggregates shall be handled in a manner which produces a uniform gradation, before placement in the plant bins. Aggregates delivered to the plant in a nonuniform gradation condition shall be stockpiled. The stockpiled aggregate shall be mixed uniformly before placement in the plant bins.

Aggregates shall have a uniform moisture content before placement in the plant bins. This may require aggregates to be stockpiled for 12 hours or more to allow drainage, or water added to the stockpile, or other methods approved by the Engineer. Moisture content requirements for crushed concrete, crushed slag or lightweight aggregate shall be according to Article 1004.01(e)(5).

Aggregates, cement, and finely divided minerals shall be measured by weight (mass). Water and admixtures shall be measured by volume or weight (mass).

The Engineer may permit aggregates, cement, and finely divided minerals to be measured by volume for small isolated structures and for miscellaneous items. Aggregates, cement, and finely divided minerals shall be measured individually. The volume shall be based upon dry, loose materials.

1020.11 Mixing Portland Cement Concrete. The mixing of concrete shall be according to the following.

(a) Ready-Mixed Concrete. Ready-mixed concrete is central-mixed, truck-mixed, or shrink-mixed concrete transported and delivered in a plastic state ready for placement in the work and shall be according to the following.

(1) Central-Mixed Concrete. Central-mixed concrete is concrete which has been completely mixed in a stationary mixer and delivered in a truck agitator, a truck mixer operating at agitating speed, or a nonagitator truck.

The stationary mixer shall operate at the drum speed for which it was designed. The batch shall be charged into the drum so that some of the water shall enter in advance of the cement, finely divided minerals, and aggregates. The flow of the water shall be uniform and all water shall be in the drum by the end of the first 15 seconds of the mixing period. Water shall begin to enter the drum from zero to two seconds in advance of solid material and shall stop flowing within two seconds of the beginning of mixing time.

Some coarse aggregate shall enter in advance of other solid materials. For the balance of the charging time for solid materials, the aggregates, finely divided minerals, and cement (to assure thorough blending) shall each flow at acceptably uniform rates, as determined by visual observation. Coarse aggregate shall enter two seconds in advance of other solid materials and a uniform rate of flow shall continue to within two seconds of the completion of charging time.

The entire contents of the drum, or of each single compartment of a multiple-drum mixer, shall be discharged before the succeeding batch is introduced.

The volume of concrete mixed per batch shall not exceed the mixer's rated capacity as shown on the standard rating plate on the mixer by more than ten percent.

The minimum mixing time shall be 75 seconds for a stationary mixer having a capacity greater than 2 cu yd (1.5 cu m). For a mixer with a capacity equal to or less than 2 cu yd (1.5 cu m) the mixing time shall be 60 seconds. Transfer time in multiple drum mixers is included in the mixing time. Mixing time shall begin when all materials are in the mixing compartment and shall end when the discharge of any part of the batch is started. The required mixing times will be established by the Engineer for all types of stationary mixers.

When central-mixed concrete is to be transported in a truck agitator or a truck mixer, the stationary-mixed batch shall be transferred to the agitating unit without delay and without loss of any portion of the batch. Agitating shall start immediately thereafter and shall continue without interruption until the batch is discharged from the agitator. The ingredients of the batch shall be completely discharged from the agitator before the succeeding batch is introduced. Drums and auxiliary parts of the equipment shall be kept free from accumulations of materials.

The vehicles used for transporting the mixed concrete shall be of such capacity, or the batches shall be so proportioned, that the entire contents of the mixer drum can be discharged into each vehicle load.

- (2) Truck-Mixed Concrete. Truck-mixed concrete is completely mixed and delivered in a truck mixer. When the mixer is charged with fine and coarse aggregates simultaneously, not less than 60 nor more than 100 revolutions of the drum or blades at mixing speed shall be required, after all of the ingredients including water are in the drum. When fine and coarse aggregates are charged separately, not less than 70 revolutions will be required. For self-consolidating concrete, a minimum of 100 revolutions is required in all cases. Additional mixing beyond 100 revolutions shall be at agitating speed unless additions of water, admixtures, or other materials are made at the jobsite. The mixing operation shall begin immediately after the cement and water, or the cement and wet aggregates, come in contact. The ingredients of the batch shall be completely discharged from the drum before the succeeding batch is introduced. The drum and auxiliary parts of the equipment shall be kept free from accumulations of materials. If additional water or an admixture is added at the jobsite, the concrete batch shall be mixed a minimum of 40 additional revolutions after each addition.

- (3) Shrink-Mixed Concrete. Shrink-mixed concrete is mixed partially in a stationary mixer and completed in a truck mixer for delivery. The mixing time of the stationary mixer may be reduced to a minimum of 30 seconds to intermingle the ingredients, before transferring to the truck mixer. All ingredients for the batch shall be in the stationary mixer and partially mixed before any of the mixture is discharged into the truck mixer. The partially mixed batch shall be transferred to the truck mixer without delay and without loss of any portion of the batch, and mixing in the truck mixer shall start immediately. The mixing time in the truck mixer shall be not less than 50 nor more than 100 revolutions of the drum or blades at mixing speed. For self-consolidating concrete, a minimum of 100 revolutions is required in the truck mixer. Additional mixing beyond 100 revolutions shall be at agitating speed, unless additions of water, admixtures, or other materials are made at the jobsite. Units designed as agitators shall not be used for shrink mixing. The ingredients of the batch shall be completely discharged from the drum before the succeeding batch is introduced. The drum and auxiliary parts of the equipment shall be kept free from accumulations of materials. If additional water or an admixture is added at the jobsite, the concrete batch shall be mixed a minimum of 40 additional revolutions after each addition.
- (4) Mixing Water. Wash water shall be completely discharged from the drum or container before a batch is introduced. All mixing water shall be added at the plant and any adjustment of water at the jobsite by the Contractor shall not exceed the specified maximum water/cement ratio or slump. If strength specimens have been made for a batch of concrete, and subsequently during discharge there is more water added, additional strength specimens shall be made for the batch of concrete. No additional water may be added at the jobsite to central-mixed concrete if the mix design has less than 565 lbs/cu yd (335 kg/cu m) of cement and finely divided minerals summed together.
- (5) Mixing and Agitating Speeds. The mixing or agitating speeds used for truck mixers or truck agitators shall be per the manufacturer's rating plate.
- (6) Capacities. The volume of plastic concrete in a given batch will be determined according to AASHTO T 121, based on the total weight (mass) of the batch, determined either from the weight (masses) of all materials, including water, entering the batch or directly from the net weight (mass) of the concrete in the batch as delivered.

The volume of mixed concrete in truck mixers or truck agitators shall in no case be greater than the rated capacity determined according to the Truck Mixer, Agitator, and Front Discharge Concrete Carrier Standards of the Truck Mixer Manufacturer's Bureau, as shown by the rating plate attached to the truck. If the truck mixer does not have a rating plate, the volume of mixed concrete shall not exceed 63 percent of the gross volume of the drum or container, disregarding the blades. For truck agitators, the value is 80 percent.

- (7) Time of Haul. Haul time shall begin when the delivery ticket is stamped. The delivery ticket shall be stamped no later than five minutes after the addition of the mixing water to the cement, or after the addition of the cement to the aggregate when the combined aggregates contain free moisture in excess of two percent by weight (mass). If more than one batch is required for charging a truck using a stationary mixer, the time of haul shall start with mixing of the first batch. Haul time shall end when the truck is emptied for incorporation of the concrete into the work.

The time elapsing from when water is added to the mix until it is deposited in place at the site of the work shall not exceed 30 minutes when the concrete is transported in nonagitating trucks.

The maximum haul time for concrete transported in truck mixers or truck agitators shall be according to the following.

Concrete Temperature at Point of Discharge °F (°C)	Haul Time	
	Hours	Minutes
50-64 (10-17.5)	1	30
>64 (>17.5) - without retarder	1	0
>64 (>17.5) - with retarder	1	30

To encourage start-up testing for mix adjustments at the plant, the first two trucks will be allowed an additional 15 minutes haul time whenever such testing is performed.

For a mixture which is not mixed on the jobsite, a delivery ticket shall be required for each load. The following information shall be recorded on each delivery ticket: (1) ticket number; (2) name of producer and plant location; (3) contract number; (4) name of Contractor; (5) stamped date and time batched; (6) truck number; (7) quantity batched; (8) amount of admixture(s) in the batch; (9) amount of water in the batch; and (10) Department mix design number.

For concrete mixed in jobsite stationary mixers, the above delivery ticket may be waived, but a method of verifying the haul time shall be established to the satisfaction of the Engineer.

- (8) Production and Delivery. The production of ready-mixed concrete shall be such that the operations of placing and finishing will be continuous insofar as the job operations require. The Contractor shall be responsible for producing concrete that will have the required workability, consistency, and plasticity when delivered to the work. Concrete which is unsuitable for placement as delivered will be rejected. The Contractor shall minimize the need to adjust the mixture at the jobsite, such as adding water and admixtures prior to discharging.
- (9) Use of Multiple Plants in the Same Construction Item. The Contractor may simultaneously use central-mixed, truck-mixed, and shrink-mixed concrete from more than one plant, for the same construction item, on the same day, and in the same pour. However, the following criteria shall be met.
- a. Each plant shall use the same cement, finely divided minerals, aggregates, admixtures, and fibers.

- b. Each plant shall use the same mix design. However, material proportions may be altered slightly in the field to meet slump and air content criteria. Field water adjustments shall not result in a difference that exceeds 0.02 between plants for water/cement ratio. The required cement factor for central-mixed concrete shall be increased to match truck-mixed or shrink-mixed concrete, if the latter two types of mixed concrete are used in the same pour.
 - c. The maximum slump difference between deliveries of concrete shall be 3/4 in. (19 mm) when tested at the jobsite. If the difference is exceeded, but test results are within specification limits, the concrete may be used. The Contractor shall take immediate corrective action and shall test subsequent deliveries of concrete until the slump difference is corrected. For each day, the first three truck loads of delivered concrete from each plant shall be tested for slump by the Contractor. Thereafter, when a specified test frequency for slump is to be performed, it shall be conducted for each plant at the same time.
 - d. The maximum air content difference between deliveries of concrete shall be 1.5 percent when tested at the jobsite. If the difference is exceeded, but test results are within specification limits, the concrete may be used. The Contractor shall take immediate corrective action and shall test subsequent deliveries of concrete until the air content difference is corrected. For each day, the first three truck loads of delivered concrete from each plant shall be tested for air content by the Contractor. Thereafter, when a specified test frequency for air content is to be performed, it shall be conducted for each plant at the same time.
 - e. Strength tests shall be performed and taken at the jobsite for each plant. When a specified strength test is to be performed, it shall be conducted for each plant at the same time. The difference between plants for strength shall not exceed 900 psi (6200 kPa) compressive and 90 psi (620 kPa) flexural. If the strength difference requirements are exceeded, the Contractor shall take corrective action.
 - f. The maximum haul time difference between deliveries of concrete shall be 15 minutes. If the difference is exceeded, but haul time is within specification limits, the concrete may be used. The Contractor shall take immediate corrective action and check subsequent deliveries of concrete.
- (b) Class PC Concrete. The concrete shall be central-mixed or truck-mixed. Variations in plastic concrete properties shall be minimized between batches.
- (c) Class PV Concrete. The concrete shall be central-mixed, truck-mixed, or shrink-mixed.

The required mixing time for stationary mixers with a capacity greater than 2 cu yd (1.5 cu m) may be less than 75 seconds upon satisfactory completion of a mixer performance test. Mixer performance tests may be requested by the Contractor when the quantity of concrete to be placed exceeds 50,000 sq yd (42,000 sq m). The testing shall be conducted according to the current Bureau of Materials and Physical Research's Policy Memorandum, "Field Test Procedures for Mixer Performance and Concrete Uniformity Tests".

The Contractor will be allowed to test two mixing times within a range of 50 to 75 seconds. If satisfactory results are not obtained from the required tests, the mixing time shall continue to be 75 seconds for the remainder of the contract. If satisfactory results are obtained, the mixing time may be reduced. In no event will mixing time be less than 50 seconds.

The Contractor shall furnish the labor, equipment, and material required to perform the testing according to the current Bureau of Materials and Physical Research's Policy Memorandum, "Field Test Procedures for Mixer Performance and Concrete Uniformity Tests".

A contract which has 12 ft (3.6 m) wide pavement or base course, and a continuous length of 1/2 mile (0.8 km) or more, shall have the following additional requirements.

- (1) The plant and truck delivery operation shall be able to provide a minimum of 50 cu yd (38 cu m) of concrete per hour.
- (2) The plant shall have automatic or semi-automatic batching equipment.

(d) All Other Classes of Concrete. The concrete shall be central-mixed, truck-mixed, or shrink-mixed concrete.

1020.12 Mobile Portland Cement Concrete Plants. The use of a mobile portland cement concrete plant may be approved under the provisions of Article 1020.10 for volumetric proportioning in small isolated structures, thin overlays, and for miscellaneous and incidental concrete items.

The first 1 cu ft (0.03 cu m) of concrete produced may not contain sufficient mortar and shall not be incorporated in the work. The side plate on the cement feeder shall be removed periodically (normally the first time the mixer is used each day) to see if cement is building up on the feed drum.

Sufficient mixing capacity of mixers shall be provided to enable continuous placing and finishing insofar as the job operations and the specifications require.

Slump and air tests made immediately after discharge of the mix may be misleading, since the aggregates may absorb a significant amount of water for four or five minutes after mixing.

1020.13 Curing and Protection. The method of curing, curing period, and method of protection for each type of concrete construction is included in the following Index Table.

INDEX TABLE OF CURING AND PROTECTION OF CONCRETE CONSTRUCTION			
TYPE OF CONSTRUCTION	CURING METHODS	CURING PERIOD DAYS	LOW AIR TEMPERATURE PROTECTION METHODS
Cast-in-Place Concrete ^{11/}			
Pavement			
Shoulder	1020.13(a)(1)(2)(3)(4)(5) ^{3/ 5/}	3	1020.13(c)
Base Course			
Base Course Widening	1020.13(a)(1)(2)(3)(4)(5) ^{2/}	3	1020.13(c)
Driveway			
Median			
Barrier			
Curb			
Gutter	1020.13(a)(1)(2)(3)(4)(5) ^{4/ 5/}	3	1020.13(c) ^{16/}
Curb & Gutter			
Sidewalk			
Slope Wall			
Paved Ditch			
Catch Basin			
Manhole	1020.13(a)(1)(2)(3)(4)(5) ^{4/}	3	1020.13(c)
Inlet			
Valve Vault			
Pavement Patching	1020.13(a)(1)(2)(3)(4)(5) ^{2/}	3 ^{12/}	1020.13(c)
Bridge Deck Patching	1020.13(a)(3)(5)	3 or 7 ^{12/}	1020.13(c)
Railroad Crossing	1020.13(a)(3)(5)	1	1020.13(c)
Piles and Drilled Shafts	1020.13(a)(3)(5)	7	1020.13(d)(1)(2)(3)
Foundations & Footings			
Seal Coat	1020.13(a)(1)(2)(3)(4)(5) ^{4/ 6/}	7	1020.13(d)(1)(2)(3)
Substructure	1020.13(a)(1)(2)(3)(4)(5) ^{1/ 7/}	7	1020.13(d)(1)(2)(3)
Superstructure (except deck)	1020.13(a)(1)(2)(3)(5) ^{8/}	7	1020.13(d)(1)(2)
Deck			
Bridge Approach Slab	1020.13(a)(5)	7	1020.13(d)(1)(2) ^{17/}
Retaining Walls	1020.13(a)(1)(2)(3)(4)(5) ^{1/ 7/}	7	1020.13(d)(1)(2)
Pump Houses	1020.13(a)(1)(2)(3)(4)(5) ^{1/}	7	1020.13(d)(1)(2)
Culverts	1020.13(a)(1)(2)(3)(4)(5) ^{4/ 6/}	7	1020.13(d)(1)(2) ^{18/}
Other Incidental Concrete	1020.13(a)(1)(2)(3)(5)	3	1020.13(c)
Precast Concrete ^{11/}			
Bridge Slabs			
Piles and Pile Caps	1020.13(a)(3)(5) ^{9/ 10/}	As ^{13/}	9/
Other Structural Members		Required	
All Other Precast Items	1020.13(a)(3)(4)(5) ^{2/ 9/ 10/}	As ^{14/}	9/
		Required	
Precast, Prestressed Concrete ^{11/}			
All Items	1020(a)(3)(5) ^{9/ 10/}	Until Strand Tensioning is Released ^{15/}	9/

Notes-General:

- 1/ Type I, membrane curing only
- 2/ Type II, membrane curing only
- 3/ Type III, membrane curing only
- 4/ Type I, II and III membrane curing
- 5/ Membrane Curing will not be permitted between November 1 and April 15.

- 6/ The use of water to inundate foundations and footings, seal coats or the bottom slab of culverts is permissible when approved by the Engineer, provided the water temperature can be maintained at 45 °F (7 °C) or higher.
- 7/ Asphalt emulsion for waterproofing may be used in lieu of other curing methods when specified and permitted according to Article 503.18.
- 8/ On non-traffic surfaces which receive protective coat according to Article 503.19, a linseed oil emulsion curing compound may be used as a substitute for protective coat and other curing methods. The linseed oil emulsion curing compound will be permitted between April 16 and October 31 of the same year, provided it is applied with a mechanical sprayer according to Article 1101.09(b).
- 9/ Steam, supplemental heat, or insulated blankets (with or without steam/supplemental heat) are acceptable and shall be according to the Bureau of Materials and Physical Research's Policy Memorandum "Quality Control/Quality Assurance Program for Precast Concrete Products" and the "Manual for Fabrication of Precast, Prestressed Concrete Products".
- 10/ A moist room according to AASHTO M 201 is acceptable for curing.
- 11/ If curing is required and interrupted because of form removal for cast-in-place concrete items, precast concrete products, or precast prestressed concrete products, the curing shall be resumed within two hours from the start of the form removal.
- 12/ Curing maintained only until opening strength is attained for pavement patching, with a maximum curing period of three days. For bridge deck patching the curing period shall be three days if Class PP concrete is used and 7 days if Class BS concrete is used.
- 13/ The curing period shall end when the concrete has attained the mix design strength. The producer has the option to discontinue curing when the concrete has attained 80 percent of the mix design strength or after seven days. All strength test specimens shall remain with the units and shall be subjected to the same curing method and environmental condition as the units, until the time of testing.
- 14/ The producer shall determine the curing period or may elect to not cure the product. All strength test specimens shall remain with the units and shall be subjected to the same curing method and environmental condition as the units, until the time of testing.
- 15/ The producer has the option to continue curing after strand release.
- 16/ When structural steel or structural concrete is in place above slope wall, Article 1020.13(c) shall not apply. The protection method shall be according to Article 1020.13(d)(1).
- 17/ When Article 1020.13(d)(2) is used to protect the deck, the housing may enclose only the bottom and sides. The top surface shall be protected according to Article 1020.13(d)(1).

18/ For culverts having a waterway opening of 10 sq ft (1 sq m) or less, the culverts may be protected according to Article 1020.13(d)(3).

(a) Methods of Curing. Except as provided for in the Index Table of Curing and Protection of Concrete Construction, curing shall be accomplished by one of the following described methods. When water is required to wet the surface, it shall be applied as a fine spray so that it will not mar or pond on the surface. Except where otherwise specified, the curing period shall be at least 72 hours.

(1) Waterproof Paper Method. The surface of the concrete shall be covered with waterproof paper as soon as the concrete has hardened sufficiently to prevent marring the surface. The surface of the concrete shall be wetted immediately before the paper is placed. The blankets shall be lapped at least 12 in. (300 mm) end to end, and these laps shall be securely weighted with a windrow of earth, or other approved method, to form a closed joint. The same requirements shall apply to the longitudinal laps where separate strips are used for curing edges, except the lap shall be at least 9 in. (225 mm). The edges of the blanket shall be weighted securely with a continuous windrow of earth or any other means satisfactory to the Engineer to provide an air-tight cover. Any torn places or holes in the paper shall be repaired immediately by patches cemented over the openings, using a bituminous cement having a melting point of not less than 180 °F (82 °C). The blankets may be reused, provided they are air-tight and kept serviceable by proper repairs.

A longitudinal pleat shall be provided in the blanket to permit shrinkage where the width of the blanket is sufficient to cover the entire surface. The pleat will not be required where separate strips are used for the edges. Joints in the blanket shall be sewn or cemented together in such a manner that they will not separate during use.

(2) Polyethylene Sheeting Method. The surface of the concrete shall be covered with white polyethylene sheeting as soon as the concrete has hardened sufficiently to prevent marring the surface. The surface of the concrete shall be wetted immediately before the sheeting is placed. The edges of the sheeting shall be weighted securely with a continuous windrow of earth or any other means satisfactory to the Engineer to provide an air-tight cover. Adjoining sheets shall overlap not less than 12 in. (300 mm) and the laps shall be securely weighted with earth, or any other means satisfactory to the Engineer, to provide an air tight cover. For surface and base course concrete, the polyethylene sheets shall be not less than 100 ft (30 m) in length nor longer than can be conveniently handled, and shall be of such width that, when in place, they will cover the full width of the surface, including the edges, except that separate strips may be used to cover the edges. Any tears or holes in the sheeting shall be repaired. When sheets are no longer serviceable as a single unit, the Contractor may select from such sheets and reuse those which will serve for further applications, provided two sheets are used as a single unit; however, the double sheet units will be rejected when the Engineer deems that they no longer provide an air tight cover.

- (3) Wetted Burlap Method. The surface of the concrete shall be covered with wetted burlap blankets as soon as the concrete has hardened sufficiently to prevent marring the surface. The blankets shall overlap 6 in. (150 mm). At least two layers of wetted burlap shall be placed on the finished surface. The burlap shall be kept saturated by means of a mechanically operated sprinkling system. In place of the sprinkling system, at the Contractor's option, two layers of burlap covered with impermeable covering shall be used. The burlap shall be kept saturated with water. Plastic coated burlap may be substituted for one layer of burlap and impermeable covering.

The blankets shall be placed so that they are in contact with the edges of the concrete, and that portion of the material in contact with the edges shall be kept saturated with water.

- (4) Membrane Curing Method. Membrane curing will not be permitted where a protective coat, concrete sealer, or waterproofing is to be applied, or at areas where rubbing or a normal finish is required, or at construction joints other than those necessary in pavement or base course. Concrete at these locations shall be cured by another method specified in Article 1020.13(a).

After all finishing work to the concrete surface has been completed, it shall be sealed with membrane curing compound of the type specified within ten minutes. The seal shall be maintained for the specified curing period. The edges of the concrete shall, likewise, be sealed within ten minutes after the forms are removed. Two separate applications, applied at least one minute apart, each at the rate of not less than 1 gal/250 sq ft (0.16 L/sq m) will be required upon the surfaces and edges of the concrete. These applications shall be made with the mechanical equipment specified. Type III compound shall be agitated immediately before and during the application.

At locations where the coating is discontinuous or where pin holes show or where the coating is damaged due to any cause and on areas adjacent to sawed joints, immediately after sawing is completed, an additional coating of membrane curing compound shall be applied at the above specified rate. The equipment used may be of the same type as that used for coating variable widths of pavement. Before the additional coating is applied adjacent to sawed joints, the cut faces of the joint shall be protected by inserting a suitable flexible material in the joint, or placing an adhesive width of impermeable material over the joint, or by placing the permanent sealing compound in the joint. Material, other than the permanent sealing compound, used to protect cut faces of the joint, shall remain in place for the duration of the curing period. In lieu of applying the additional coating, the area of the sawed joint may be cured according to any other method permitted.

When rain occurs before an application of membrane curing compound has dried, and the coating is damaged, the Engineer may require another application be made in the same manner and at the same rate as the original coat. The Engineer may order curing by another method specified, if unsatisfactory results are obtained with membrane curing compound.

(5) **Wetted Cotton Mat Method.** After the surface of concrete has been textured or finished, it shall be covered immediately with dry or damp cotton mats. The cotton mats shall be placed in a manner which will not mar the concrete surface. A texture resulting from the cotton mat material is acceptable. The cotton mats shall then be wetted immediately and thoroughly soaked with a gentle spray of water. For bridge decks, a foot bridge shall be used to place and wet the cotton mats.

The cotton mats shall be maintained in a wetted condition until the concrete has hardened sufficiently to place soaker hoses without marring the concrete surface. The soaker hoses shall be placed on top of the cotton mats at a maximum 4 ft (1.2 m) spacing. The cotton mats shall be kept wet with a continuous supply of water for the remainder of the curing period. Other continuous wetting systems may be used if approved by the Engineer.

After placement of the soaker hoses, the cotton mats shall be covered with white polyethylene sheeting or burlap-polyethylene blankets.

For construction items other than bridge decks, soaker hoses or a continuous wetting system will not be required if the alternative method keeps the cotton mats wet. Periodic wetting of the cotton mats is acceptable.

For areas inaccessible to the cotton mats on bridge decks, curing shall be according to Article 1020.13(a)(3).

(b) **Removing and Replacing Curing Covering.** When curing methods specified above in Article 1020.13(a), (1), (2), or (3) are used for concrete pavement, the curing covering for each day's paving shall be removed to permit testing of the pavement surface with a profilograph or straightedge, as directed by the Engineer.

Immediately after testing, the surface of the pavement shall be wetted thoroughly and the curing coverings replaced. The top surface and the edges of the concrete shall not be left unprotected for a period of more than 1/2 hour.

(c) **Protection of Concrete, Other Than Structures, From Low Air Temperatures.** When the official National Weather Service forecast for the construction area predicts a low of 32 °F (0 °C), or lower, or if the actual temperature drops to 32 °F (0 °C), or lower, concrete less than 72 hours old shall be provided at least the following protection.

Minimum Temperature	Protection
25 – 32 °F (-4 – 0 °C)	Two layers of polyethylene sheeting, one layer of polyethylene and one layer of burlap, or two layers of waterproof paper.
Below 25 °F (-4 °C)	6 in. (150 mm) of straw covered with one layer of polyethylene sheeting or waterproof paper.

These protective covers shall remain in place until the concrete is at least 96 hours old. When straw is required on pavement cured with membrane curing compound, the compound shall be covered with a layer of burlap, polyethylene sheeting or waterproof paper before the straw is applied.

After September 15, there shall be available to the work within four hours, sufficient clean, dry straw to cover at least two days production. Additional straw shall be provided as needed to afford the protection required. Regardless of the precautions taken, the Contractor shall be responsible for protection of the concrete placed and any concrete damaged by cold temperatures shall be removed and replaced.

- (d) Protection of Concrete Structures From Low Air Temperatures. When the official National Weather Service forecast for the construction area predicts a low below 45 °F (7 °C), or if the actual temperature drops below 45 °F (7 °C), concrete less than 72 hours old shall be provided protection. Concrete shall also be provided protection when placed during the winter period of December 1 through March 15. Concrete shall not be placed until the materials, facilities, and equipment for protection are approved by the Engineer.

When directed by the Engineer, the Contractor may be required to place concrete during the winter period. When winter construction is specified, the Contractor shall proceed with the construction, including excavation, pile driving, concrete, steel erection, and all appurtenant work required for the complete construction of the item, except at times when weather conditions make such operations impracticable.

Regardless of the precautions taken, the Contractor shall be responsible for protection of the concrete placed and any concrete damaged by cold temperatures shall be removed and replaced.

- (1) Protection Method I. The concrete shall be completely covered with insulating material such as fiberglass, rock wool, or other approved commercial insulating material having the minimum thermal resistance R, as defined in ASTM C 168, for the corresponding minimum dimension of the concrete unit being protected as shown in the following table.

Minimum Pour Dimension		Thermal Resistance R
in.	(mm)	
6 or less	(150 or less)	R=16
> 6 to 12	(> 150 to 300)	R=10
> 12 to 18	(> 300 to 450)	R=6
> 18	(> 450)	R=4

The insulating material manufacturer shall clearly mark the insulating material with the thermal resistance R value.

The insulating material shall be completely enclosed on sides and edges with an approved waterproof liner and shall be maintained in a serviceable condition. Any tears in the liner shall be repaired in a manner approved by the Engineer. The Contractor shall provide means for checking the temperature of the surface of the concrete during the protection period.

On formed surfaces, the insulating material shall be attached to the outside of the forms with wood cleats or other suitable means to prevent any circulation of air under the insulation and shall be in place before the concrete is placed. The blanket insulation shall be applied tightly against the forms. The edges and ends shall be attached so as to exclude air and moisture. If the blankets are provided with nailing flanges, the flanges shall be attached to the studs with cleats. Where tie rods or reinforcement bars protrude, the areas adjacent to the rods or bars shall be adequately protected in a manner satisfactory to the Engineer. Where practicable, the insulation shall overlap any previously placed concrete by at least 1 ft (300 mm). Insulation on the underside of floors on steel members shall cover the top flanges of supporting members. On horizontal surfaces, the insulating material shall be placed as soon as the concrete has set, so that the surface will not be marred and shall be covered with canvas or other waterproof covering. The insulating material shall remain in place for a period of seven days after the concrete is placed.

The Contractor may remove the forms, providing the temperature is 35 °F (2 °C) and rising and the Contractor is able to wrap the particular section within two hours from the time of the start of the form removal. The insulation shall remain in place for the remainder of the seven days curing period.

- (2) Protection Method II. The concrete shall be enclosed in adequate housing and the air surrounding the concrete kept at a temperature of not less than 50 °F (10 °C) nor more than 80 °F (27 °C) for a period of seven days after the concrete is placed. The Contractor shall provide means for checking the temperature of the surface of the concrete or air temperature within the housing during the protection period. All exposed surfaces within the housing shall be cured according to the Index Table.

The Contractor shall provide adequate fire protection where heating is in progress and such protection shall be accessible at all times. The Contractor shall maintain labor to keep the heating equipment in continuous operation.

At the close of the heating period, the temperature shall be decreased to the approximate temperature of the outside air at a rate not to exceed 15 °F (8 °C) per 12 hour period, after which the housing maybe removed. The surface of the concrete shall be permitted to dry during the cooling period.

- (3) Protection Method III. As soon as the surface is sufficiently set to prevent marring, the concrete shall be covered with 12 in. (300 mm) of loose, dry straw followed by a layer of impermeable covering. The edges of the covering shall be sealed to prevent circulation of air and prevent the cover from flapping or blowing. The protection shall remain in place until the concrete is seven days old. If construction operations require removal, the protection removed shall be replaced immediately after completion or suspension of such operations.

1020.14 Temperature Control for Placement. Temperature control for concrete placement shall be according to the following.

- (a) Concrete other than Structures. Concrete may be placed when the air temperature is above 35 °F (2 °C) and rising, and concrete placement shall stop when the falling temperature reaches 40 °F (4 °C) or below, unless otherwise approved by the Engineer.

The temperature of concrete immediately before placement shall be a minimum of 50 °F (10 °C) and a maximum of 90 °F (32 °C). If concrete is pumped, the temperature of the concrete at point of placement shall be a minimum of 50 °F (10 °C) and a maximum of 90 °F (32 °C). A maximum concrete temperature shall not apply to Class PP concrete.

- (b) Concrete in Structures. Concrete may be placed when the air temperature is above 40 °F (4 °C) and rising, and concrete placement shall stop when the falling temperature reaches 45 °F (7 °C) or below, unless otherwise approved by the Engineer.

The temperature of the concrete immediately before placement shall be a minimum of 50 °F (10 °C) and a maximum of 90 °F (32 °C). If concrete is pumped, the temperature of the concrete at point of placement shall be a minimum of 50 °F (10 °C) and a maximum of 90 °F (32 °C).

When insulated forms are used according to Article 1020.13(d)(1), the maximum temperature of the concrete mixture immediately before placement shall be 80 °F (25 °C).

When concrete is placed in contact with previously placed concrete, the temperature of the freshly mixed concrete may be increased to 80 °F (25 °C) by the Contractor to offset anticipated heat loss.

- (c) All Classes of Concrete. Aggregates and water shall be heated or cooled uniformly and as necessary to produce concrete within the specified temperature limits. No frozen aggregates shall be used in the concrete.
- (d) Temperature. The concrete temperature shall be determined according to Illinois Modified AASHTO T 309.

1020.15 Heat of Hydration Control for Concrete Structures. The Contractor shall control the heat of hydration for concrete structures when the least dimension for a drilled shaft, foundation, footing, substructure, or superstructure concrete pour exceeds 5.0 ft (1.5 m). The work shall be according to the following.

- (a) Temperature Restrictions. The maximum temperature of the concrete after placement shall not exceed 150 °F (66 °C). The maximum temperature differential between the internal concrete core and concrete 2 to 3 in. (50 to 75 mm) from the exposed surface shall not exceed 35 °F (19 °C). The Contractor shall perform temperature monitoring to ensure compliance with the temperature restrictions.

(b) Thermal Control Plan. The Contractor shall provide a thermal control plan a minimum of 28 calendar days prior to concrete placement for review by the Engineer. Acceptance of the thermal control plan by the Engineer shall not preclude the Contractor from specification compliance, and from preventing cracks in the concrete. At a minimum, the thermal control plan shall provide detailed information on the following requested items and shall comply with the specific specifications indicated for each item.

(1) Concrete mix design(s) to be used. Grout mix design if post-cooling with embedded pipe.

The mix design requirements in Articles 1020.04 and 1020.05 shall be revised to include the following additional requirements to control the heat of hydration.

- a. The concrete mixture should be uniformly graded and preference for larger size aggregate should be used in the mix design. Article 1004.02(d)(2) shall apply and information in the "Portland Cement Concrete Level III Technician Course – Manual of Instructions for Design of Concrete Mixtures" may be used to develop the uniformly graded mixture.
- b. The following shall apply to all concrete except Class DS concrete or when self-consolidating concrete is desired. For central-mixed concrete, the Contractor shall have the option to develop a mixture with a minimum of 520 lbs/cu yd (309 kg/cu m) of cement and finely divided minerals summed together. For truck-mixed or shrink-mixed concrete, the Contractor shall have the option to develop a mixture with a minimum of 550 lbs/cu yd (326 kg/cu m) of cement and finely divided minerals summed together. A water-reducing or high range water-reducing admixture shall be used in the central mixed, truck-mixed or shrink-mixed concrete mixture. For any mixture to be placed underwater, the minimum cement and finely divided minerals shall be 550 lbs/cu yd (326 kg/cu m) for central-mixed concrete, and 580 lbs/cu yd (344 kg/cu m) for truck-mixed or shrink-mixed concrete.

For Class DS concrete, CA 11 may be used. If CA 11 is used, the Contractor shall have the option to develop a mixture with a minimum cement and finely divided minerals of 605 lbs/cu yd (360 kg/cu m) summed together. If CA 11 is used and either Class DS concrete is placed underwater or a self-consolidating concrete mixture is desired, the Contractor shall have the option to develop a mixture with a minimum cement and finely divided minerals of 635 lbs/cu yd (378 kg/cu m) summed together.

- c. The minimum portland cement content in the mixture shall be 375 lbs/cu yd (222 kg/cu m). When the total of organic processing additions, inorganic processing additions, and limestone addition exceed 5.0 percent in the cement, the minimum portland cement content in the mixture shall be 400 lbs/cu yd (237 kg/cu m). For a drilled shaft, foundation, footing, or substructure, the minimum portland cement may be reduced to as low as 330 lbs/cu yd (196 kg/cu m) if the concrete has adequate freeze/thaw durability. The Contractor shall provide freeze/thaw test results according to AASHTO T 161 Procedure A or B, and the relative dynamic modulus of elasticity of the mix design shall be a minimum of 80 percent. Freeze/thaw testing will not be required for concrete that will not be exposed to freezing and thawing conditions as determined by the Engineer.
- d. The maximum cement replacement with fly ash shall be 40.0 percent. The maximum cement replacement with ground granulated blast-furnace slag shall be 65.0 percent. When cement replacement with ground granulated blast-furnace slag exceeds 35.0 percent, only Grade 100 shall be used.
- e. The mixture may contain a maximum of two finely divided minerals. The finely divided mineral in portland-pozzolan cement or portland blast-furnace slag cement shall count toward the total number of finely divided minerals allowed. The finely divided minerals shall constitute a maximum of 65.0 percent of the total cement plus finely divided minerals. The fly ash portion shall not exceed 40.0 percent. The ground granulated blast-furnace slag portion shall not exceed 65.0 percent. The microsilica or high-reactivity metakaolin portion used together or separately shall not exceed 5.0 percent.
- f. The time to obtain the specified strength may be increased to a maximum 56 days, provided the curing period specified in Article 1020.13 is increased to a minimum of 14 days.

The minimum grout strength for filling embedded pipe shall be as specified for the concrete, and testing shall be according to AASHTO T 106.

- (2) The selected mathematical method for evaluating heat of hydration thermal effects, which shall include the calculated adiabatic temperature rise, calculated maximum concrete temperature, and calculated maximum temperature differential between the internal concrete core and concrete 2 to 3 in. (50 to 75 mm) from the exposed surface. The time when the maximum concrete temperature and maximum temperature differential will occur is required.

Acceptable mathematical methods include ACI 207.2R "Report on Thermal and Volume Change Effects on Cracking of Mass Concrete" as well as other proprietary methods. The Contractor shall perform heat of hydration testing on the cement and finely divided minerals to be used in the concrete mixture. The test shall be according to ASTM C 186 or other applicable test methods, and the result for heat shall be used in the equation to calculate adiabatic temperature rise. Other required test parameters for the mathematical model may be assumed if appropriate.

The Contractor has the option to propose a higher maximum temperature differential between the internal concrete core and concrete 2 to 3 in. (50 to 75 mm) from the exposed surface, but the proposed value shall not exceed 50 °F (28 °C). In addition, based on strength gain of the concrete, multiple maximum temperature differentials at different times may be proposed. The proposed value shall be justified through a mathematical method.

- (3) Proposed maximum concrete temperature or temperature range prior to placement.

Article 1020.14 shall apply except a minimum 40 °F (4 °C) concrete temperature will be permitted.

- (4) Pre-cooling, post-cooling, and surface insulation methods that will be used to ensure the concrete will comply with the specified maximum temperature and specified or proposed temperature differential. For reinforcement that extends beyond the limits of the pour, the Contractor shall indicate if the reinforcement is required to be covered with insulation.

Refer to ACI 207.4R “Cooling and Insulating Systems for Mass Concrete” for acceptable methods that will be permitted. If embedded pipe is used for post-cooling, the material shall be polyvinyl chloride or polyethylene. The embedded pipe system shall be properly supported, and the Contractor shall subsequently inspect glued joints to ensure they are able to withstand free falling concrete. The embedded pipe system shall be leak tested after inspection of the glued joints, and prior to the concrete placement. The leak test shall be performed at maximum service pressure or higher for a minimum of 15 minutes. All leaks shall be repaired. The embedded pipe cooling water may be from natural sources such as streams and rivers, but shall be filtered to prevent system stoppages. When the embedded pipe is no longer needed, the surface connections to the pipe shall be removed to a depth of 4 in. (100 mm) below the surface of the concrete. The remaining pipe shall be completely filled with grout. The 4 in. (100 mm) deep concrete hole shall be filled with nonshrink grout. Form and insulation removal shall be done in a manner to prevent cracking and ensure the maximum temperature differential is maintained. Insulation shall be in good condition as determined by the Engineer and properly attached.

- (5) Dimensions of each concrete pour, location of construction joints, placement operations, pour pattern, lift heights, and time delays between lifts.

Refer to ACI 207.1R “Guide to Mass Concrete” for acceptable placement operations that will be permitted.

- (6) Type of temperature monitoring system, the number of temperature sensors, and location of sensors.

A minimum of two independent temperature monitoring systems and corresponding sensors shall be used.

The temperature monitoring system shall have a minimum temperature range of 32 °F (0 °C) to 212 °F (100 °C), an accuracy of ± 2 °F (± 1 °C), and be able to automatically record temperatures without external power. Temperature monitoring shall begin once the sensor is encased in concrete, and with a maximum interval of one hour. Temperature monitoring may be discontinued after the maximum concrete temperature has been reached, post-cooling is no longer required, and the maximum temperature differential between the internal concrete core and the ambient air temperature does not exceed 35 °F (19 °C). The Contractor has the option to select a higher maximum temperature differential, but the proposed value shall not exceed 50 °F (28 °C). The proposed value shall be justified through a mathematical method.

At a minimum, a temperature sensor shall be located at the theoretical hottest portion of the concrete, normally the geometric center, and at the exterior face that will provide the maximum temperature differential. At the exterior face, the sensor shall be located 2 to 3 in. (50 to 75 mm) from the surface of the concrete. Sensors shall also be located a minimum of 1 in. (25 mm) away from reinforcement, and equidistant between cooling pipes if either applies. A sensor will also be required to measure ambient air temperature. The entrant/exit cooling water temperature for embedded pipe shall also be monitored.

Temperature monitoring results shall be provided to the Engineer a minimum of once each day and whenever requested by the Engineer. The report may be electronic or hard copy. The report shall indicate the location of each sensor, the temperature recorded, and the time recorded. The report shall be for all sensors and shall include ambient air temperature and entrant/exit cooling water temperatures. The temperature data in the report may be provided in tabular or graphical format, and the report shall indicate any corrective actions during the monitoring period. At the completion of the monitoring period, the Contractor shall provide the Engineer a final report that includes all temperature data and corrective actions.

(7) Indicate contingency operations to be used if the maximum temperature or temperature differential of the concrete is reached after placement.

(c) Temperature Restriction Violations. If the maximum temperature of the concrete after placement exceeds 150 °F (66 °C), but is equal to or less than 158 °F (70 °C), the concrete will be accepted if no cracking or other unacceptable defects are identified. If cracking or unacceptable defects are identified, Article 105.03 shall apply. If the concrete temperature exceeds 158 °F (70 °C), Article 105.03 shall apply.

If a temperature differential between the internal concrete core and concrete 2 to 3 in. (50 to 75 mm) from the exposed surface exceeds the specified or proposed maximum value allowed, the concrete will be accepted if no cracking or other unacceptable defects are identified. If unacceptable defects are identified, Article 105.03 shall apply.

When the maximum 150 °F (66 °C) concrete temperature or the maximum allowed temperature differential is violated, the Contractor shall implement corrective action prior to the next pour. In addition, the Engineer reserves the right to request a new thermal control plan for acceptance before the Contractor is allowed to pour again.

- (d) Inspection and Repair of Cracks. The Engineer will inspect the concrete for cracks after the temperature monitoring is discontinued, and the Contractor shall provide access for the Engineer to do the inspection. A crack may require repair by the Contractor as determined by the Engineer. The Contractor shall be responsible for the repair of all cracks. Protective coat or a concrete sealer shall be applied to a crack less than 0.007 in. (0.18 mm) in width. A crack that is 0.007 in. (0.18 mm) or greater shall be pressure injected with epoxy according to Section 590.

REMOVAL AND DISPOSAL OF REGULATED SUBSTANCES (BDE)

Effective: January 1, 2012

Revised: November 2, 2012

Revise Article 669.01 of the Standard Specifications to read:

“669.01 Description. This work shall consist of the transportation and proper disposal of contaminated soil and water. This work shall also consist of the removal, transportation, and proper disposal of underground storage tanks (UST), their content and associated underground piping to the point where the piping is above the ground, including determining the content types and estimated quantities.”

Revise Article 669.08 of the Standard Specifications to read:

“669.08 Contaminated Soil and/or Groundwater Monitoring. The Contractor shall hire a qualified environmental firm to monitor the area containing the regulated substances. The affected area shall be monitored with a photoionization detector (PID) utilizing a lamp of 10.6eV or greater or a flame ionization detector (FID). Any field screen reading on the PID or FID in excess of background levels indicates the potential presence of contaminated material requiring handling as a non-special waste, special waste, or hazardous waste. No excavated soils can be taken to a clean construction and demolition debris (CCDD) facility or an uncontaminated soil fill operation with detectable PID or FID meter readings that are above background. The PID or FID meter shall be calibrated on-site and background level readings taken and recorded daily. All testing shall be done by a qualified engineer/technician. Such testing and monitoring shall be included in the work. The Contractor shall identify the exact limits of removal of non-special waste, special waste, or hazardous waste. All limits shall be approved by the Engineer prior to excavation. The Contractor shall take all necessary precautions.

Based upon the land use history of the subject property and/or PID or FID readings indicating contamination, a soil or groundwater sample shall be taken from the same location and submitted to an approved laboratory. Soil or groundwater samples shall be analyzed for the contaminants of concern, including pH, based on the property's land use history or the parameters listed in the maximum allowable concentration (MAC) for chemical constituents in uncontaminated soil established pursuant to Subpart F of 35 Illinois Administrative Code 1100.605. The analytical results shall serve to document the level of soil contamination. Soil and groundwater samples may be required at the discretion of the Engineer to verify the level of soil and groundwater contamination.

Samples shall be grab samples (not combined with other locations). The samples shall be taken with decontaminated or disposable instruments. The samples shall be placed in sealed containers and transported in an insulated container to the laboratory. The container shall maintain a temperature of 39 °F (4 °C). All samples shall be clearly labeled. The labels shall indicate the sample number, date sampled, location and elevation, and any other observations.

The laboratory shall use analytical methods which are able to meet the lowest appropriate practical quantitation limits (PQL) or estimated quantitation limit (EQL) specified in "Test Methods for Evaluating Solid Wastes, Physical/Chemical Methods", EPA Publication No. SW-846 and "Methods for the Determination of Organic Compounds in Drinking Water", EPA, EMSL, EPA-600/4-88/039. For parameters where the specified cleanup objective is below the acceptable detection limit (ADL), the ADL shall serve as the cleanup objective. For other parameters the ADL shall be equal to or below the specified cleanup objective."

Replace the first two paragraphs of Article 669.09 of the Standard Specifications with the following:

"669.09 Contaminated Soil and/or Groundwater Management and Disposal. The management and disposal of contaminated soil and/or groundwater shall be according to the following:

- (a) Soil Analytical Results Exceed Most Stringent MAC. When the soil analytical results indicate that detected levels exceed the most stringent maximum allowable concentration (MAC) for chemical constituents in uncontaminated soil established pursuant to Subpart F of 35 Illinois Administrative Code 1100.605, the soil shall be managed as follows:
 - (1) When analytical results indicate inorganic chemical constituents exceed the most stringent MAC but they are still considered within area background levels by the Engineer, the excavated soil can be utilized within the construction limits as fill, when suitable. Such soil excavated for storm sewers can be placed back into the excavated trench as backfill, when suitable, unless trench backfill is specified. If the soils cannot be utilized within the construction limits, they shall be managed and disposed of off-site as a non-special waste, special waste, or hazardous waste as applicable.
 - (2) When analytical results indicate chemical constituents exceed the most stringent MAC but do not exceed the MAC for a Metropolitan Statistical Area (MSA) County, the excavated soil can be utilized within the construction limits as fill, when suitable, or managed and disposed of off-site as "uncontaminated soil" at a CCDD facility or an uncontaminated soil fill operation within an MSA County provided the pH of the soil is within the range of 6.25 - 9.0, inclusive.
 - (3) When analytical results indicate chemical constituents exceed the most stringent MAC but do not exceed the MAC for an MSA County excluding Chicago, or the MAC within the Chicago corporate limits, the excavated soil can be utilized within the construction limits as fill, when suitable, or managed and disposed of off-site as "uncontaminated soil" at a CCDD facility or an uncontaminated soil fill operation within an MSA County excluding Chicago or within the Chicago corporate limits provided the pH of the soil is within the range of 6.25 - 9.0, inclusive.

- (4) When analytical results indicate chemical constituents exceed the most stringent MAC but do not exceed the MAC for an MSA County excluding Chicago, the excavated soil can be utilized within the construction limits as fill, when suitable, or managed and disposed of off-site as “uncontaminated soil” at a CCDD facility or an uncontaminated soil fill operation within an MSA County excluding Chicago provided the pH of the soil is within the range of 6.25 - 9.0, inclusive.
- (5) When the Engineer determines soil cannot be managed according to Articles 669.09(a)(1) through (a)(4) above, the soil shall be managed and disposed of off-site as a non-special waste, special waste, or hazardous waste as applicable.
- (b) Soil Analytical Results Do Not Exceed Most Stringent MAC. When the soil analytical results indicate that detected levels do not exceed the most stringent MAC but the pH of the soil is less than 6.25 or greater than 9.0, the excavated soil can be utilized within the construction limits or managed and disposed of off-site as “uncontaminated soil” according to Article 202.03. However the excavated soil cannot be taken to a CCDD facility or an uncontaminated soil fill operation.
- (c) Groundwater. When groundwater analytical results indicate the detected levels are above Appendix B, Table E of 35 Illinois Administrative Code 742, the most stringent Tier 1 Groundwater Remediation Objectives for Groundwater Component of the Groundwater Ingestion Route for Class 1 groundwater, the groundwater shall be managed off-site as a special waste.

All groundwater encountered within lateral trenches may be managed within the trench and allowed to infiltrate back into the ground. If the groundwater cannot be managed within the trench it must be removed as a special or hazardous waste. The Contractor is prohibited from managing groundwater within the trench by discharging it through any existing or new storm sewer. The Contractor shall install backfill plugs within the area of groundwater contamination.

One backfill plug shall be placed down gradient to the area of groundwater contamination. Backfill plugs shall be installed at intervals not to exceed 50 ft (15 m). Backfill plugs are to be 4 ft (1.2 m) long, measured parallel to the trench, full trench width and depth. Backfill plugs shall not have any fine aggregate bedding or backfill, but shall be entirely cohesive soil or any class of concrete. The Contractor shall provide test data that the material has a permeability of less than 10^{-7} cm/sec according to ASTM D 5084, Method A or per another test method approved by the Engineer.”

Revise Article 669.14 of the Standard Specifications to read:

“669.14 Final Environmental Construction Report. At the end of the project, the Contractor will prepare and submit three copies of the Environmental Construction Report on the activities conducted during the life of the project, one copy shall be submitted to the Resident Engineer, one copy shall be submitted to the District's Environmental Studies Unit, and one copy shall be submitted with an electronic copy in Adode.pdf format to the Geologic and Waste Assessment Unit, Bureau of Design and Environment, IDOT, 2300 South Dirksen Parkway, Springfield, Illinois 62764. The technical report shall include all pertinent information regarding the project including, but not limited to:

- (a) Measures taken to identify, monitor, handle, and dispose of soil or groundwater containing regulated substances, to prevent further migration of regulated substances, and to protect workers,
- (b) Cost of identifying, monitoring, handling, and disposing of soil or groundwater containing regulated substances, the cost of preventing further migration of regulated substances, and the cost for worker protection from the regulated substances. All cost should be in the format of the contract pay items listed in the contract plans (identified by the preliminary environmental site investigation (PESA) site number),
- (c) Plan sheets showing the areas containing the regulated substances,
- (d) Field sampling and testing results used to identify the nature and extent of the regulated substances,
- (e) Waste manifests (identified by the preliminary environmental site investigation (PESA) site number) for special or hazardous waste disposal, and
- (f) Landfill tickets (identified by the preliminary environmental site investigation (PESA) site number) for non-special waste disposal.”

Revise the second paragraph of Article 669.16 of the Standard Specifications to read:

“The transportation and disposal of soil and other materials from an excavation determined to be contaminated will be paid for at the contract unit price per cubic yard (cubic meter) for NON-SPECIAL WASTE DISPOSAL, SPECIAL WASTE DISPOSAL, or HAZARDOUS WASTE DISPOSAL.”

REMOVAL AND DISPOSAL OF SURPLUS MATERIALS (BDE)

Effective: November 2, 2012

Revise the first four paragraphs of Article 202.03 of the Standard Specifications to read:

“202.03 Removal and Disposal of Surplus, Unstable, Unsuitable, and Organic Materials. Suitable excavated materials shall not be wasted without permission of the Engineer. The Contractor shall dispose of all surplus, unstable, unsuitable, and organic materials, in such a manner that public or private property will not be damaged or endangered.

Suitable earth, stones and boulders naturally occurring within the right-of-way may be placed in fills or embankments in lifts and compacted according to Section 205. Broken concrete without protruding metal bars, bricks, rock, stone, reclaimed asphalt pavement with no expansive aggregate, or uncontaminated dirt and sand generated from construction or demolition activities may be used in embankment or in fill. If used in fills or embankments, these materials shall be placed and compacted to the satisfaction of the Engineer; shall be buried under a minimum of 2 ft (600 mm) of earth cover (except when the materials include only uncontaminated dirt); and shall not create an unsightly appearance or detract from the natural topographic features of an area. Broken concrete without protruding metal bars, bricks, rock, or stone may be used as riprap as approved by the Engineer. If the materials are used for fill in locations within the right-of-way but outside project construction limits, the Contractor must specify to the Engineer, in writing, how the landscape restoration of the fill areas will be accomplished. Placement of fill in such areas shall not commence until the Contractor’s landscape restoration plan is approved by the Engineer.

Aside from the materials listed above, all other construction and demolition debris or waste shall be disposed of in a licensed landfill, recycled, reused, or otherwise disposed of as allowed by State or Federal laws and regulations. When the Contractor chooses to dispose of uncontaminated soil at a clean construction and demolition debris (CCDD) facility or at an uncontaminated soil fill operation, it shall be the Contractor’s responsibility to have the pH of the material tested to ensure the value is between 6.25 and 9.0, inclusive. A copy of the pH test results shall be provided to the Engineer.

A permit shall be obtained from IEPA and made available to the Engineer prior to open burning of organic materials (i.e., plant refuse resulting from pruning or removal of trees or shrubs) or other construction or demolition debris. Organic materials originating within the right-of-way limits may be chipped or shredded and placed as mulch around landscape plantings within the right-of-way when approved by the Engineer. Chipped or shredded material to be placed as mulch shall not exceed a depth of 6 in. (150 mm).”

SUBCONTRACTOR MOBILIZATION PAYMENTS (BDE)

Effective: April 2, 2005

Revised: April 1, 2011

To account for the preparatory work and operations necessary for the movement of subcontractor personnel, equipment, supplies, and incidentals to the project site and for all other work or operations that must be performed or costs incurred when beginning work approved for subcontracting according to Article 108.01 of the Standard Specifications, the Contractor shall make a mobilization payment to each subcontractor.

This mobilization payment shall be made at least 14 days prior to the subcontractor starting work. The amount paid shall be equal to 3 percent of the amount of the subcontract reported on form BC 260A submitted for the approval of the subcontractor's work.

The mobilization payment to the subcontractor is an advance payment of the reported amount of the subcontract and is not a payment in addition to the amount of the subcontract; therefore, the amount of the advance payment will be deducted from future progress payments.

This provision shall be incorporated directly or by reference into each subcontract approved by the Department.

TRACKING THE USE OF PESTICIDES (BDE)

Effective: August 1, 2012

Add the following paragraph after the first paragraph of Article 107.23 of the Standard Specifications:

“Within 48 hours of the application of pesticides, including but not limited to herbicides, insecticides, algaecides, and fungicides, the Contractor shall complete and return to the Engineer, Operations form “OPER 2720”.”

TRAFFIC CONTROL DEFICIENCY DEDUCTION (BDE)

Effective: August 1, 2011

Revise the third sentence of the third paragraph of Article 105.03(b) of the Standard Specifications to read:

“The daily monetary deduction will be \$2,500.”

UTILITY COORDINATION AND CONFLICTS (BDE)

Effective: April 1, 2011

Revised: January 1, 2012

Revise Article 105.07 of the Standard Specifications to read:

“105.07 Cooperation with Utilities. The Department reserves the right at any time to allow work by utilities on or near the work covered by the contract. The Contractor shall conduct his/her work so as not to interfere with or hinder the progress or completion of the work being performed by utilities. The Contractor shall also arrange the work and shall place and dispose of the materials being used so as not to interfere with the operations of utility work in the area.

The Contractor shall cooperate with the owners of utilities in their removal and rearrangement operations so work may progress in a reasonable manner, duplication or rearrangement of work may be reduced to a minimum, and services rendered by those parties will not be unnecessarily interrupted.

The Contractor shall coordinate with any planned utility adjustment or new installation and the Contractor shall take all precautions to prevent disturbance or damage to utility facilities. Any failure on the part of the utility owner, or their representative, to proceed with any planned utility adjustment or new installation shall be reported promptly by the Contractor to the Engineer.”

Revise the first sentence of the last paragraph of Article 107.19 of the Standard Specifications to read:

“When the Contractor encounters unexpected regulated substances due to the presence of utilities in unanticipated locations, the provisions of Article 107.40 shall apply; otherwise, if the Engineer does not direct a resumption of operations, the provisions of Article 108.07 shall apply.”

Revise Article 107.31 of the Standard Specification to read:

“107.31 Reserved.”

Add the following four Articles to Section 107 of the Standard Specifications:

“107.37 Locations of Utilities within the Project Limits. All known utilities existing within the limits of construction are either indicated on the plans or visible above ground. For the purpose of this Article, the limits of proposed construction are defined as follows:

(a) Limits of Proposed Construction for Utilities Paralleling the Roadway.

- (1) The horizontal limits shall be a vertical plane, outside of, parallel to, and 2 ft (600 mm) distant at right angles from the plan or revised slope limits.

In cases where the limits of excavation for structures are not shown on the plans, the horizontal limits shall be a vertical plane 4 ft (1.2 m) outside the edges of structure footings or the structure where no footings are required.

- (2) The upper vertical limits shall be the regulations governing the roadbed clearance for the specific utility involved.
 - (3) The lower vertical limits shall be either the top of the utility at the depth below the proposed grade as prescribed by the governing agency or the limits of excavation, whichever is less.
- (b) Limits of Proposed Construction for Utilities Crossing the Roadway in a Generally Transverse Direction.
- (1) Utilities crossing excavations for structures that are normally made by trenching such as sewers, underdrains, etc. and all minor structures such as manholes, inlets, foundations for signs, foundations for traffic signals, etc., the limits shall be the space to be occupied by the proposed permanent construction, unless otherwise required by the regulations governing the specific utility involved.
 - (2) For utilities crossing the proposed site of major structures such as bridges, sign trusses, etc., the limits shall be as defined above for utilities extending in the same general direction as the roadway.

It is understood and agreed that the Contractor has considered in the bid all of the permanent and temporary utilities in their present and/or adjusted positions as indicated in the contract. It is further understood the actual location of the utilities may be located anywhere within the tolerances provided in 220 ILCS 50/2.8 or Administrative Code Title 92 Part 530.40(c), and the proximity of some utilities to construction may require extraordinary measures by the Contractor to protect those utilities.

No additional compensation will be allowed for any delays, inconveniences, or damages sustained by the Contractor due to the presence of or any claimed interference from known utility facilities or any adjustment of them, except as specifically provided in the contract.

107.38 Adjustments of Utilities within the Project Limits. The adjustment of utilities consists of the relocation, removal, replacement, rearrangements, reconstruction, improvement, disconnection, connection, shifting, new installation, or altering of an existing utility facility in any manner.

Utilities which are to be adjusted shall be adjusted by the utility owner or the owner's representative or by the Contractor as a contract item. Generally, arrangements for adjusting known utilities will be made by the Department prior to project construction; however, utilities will not necessarily be adjusted in advance of project construction and, in some cases, utilities will not be removed from the proposed construction limits as described in Article 107.37. When utility adjustments must be performed in conjunction with construction, the utility adjustment work will be indicated in the contract.

The Contractor may make arrangements for adjustment of utilities indicated in the contract, but not scheduled by the Department for adjustment, provided the Contractor furnishes the Department with a signed agreement with the utility owner covering the adjustments to be made. The cost of any such adjustments shall be the responsibility of the Contractor.

107.39 Contractor’s Responsibility for Locating and Protecting Utility Property and Services. At points where the Contractor’s operations are adjacent to properties or facilities of utility companies, or are adjacent to other property, damage to which might result in considerable expense, loss, or inconvenience, work shall not be commenced until all arrangements necessary for the protection thereof have been made.

Within the State of Illinois, a State-Wide One Call Notice System has been established for notifying utilities. Outside the city limits of the City of Chicago, the system is known as the Joint Utility Locating Information for Excavators (JULIE) System. Within the city limits of the City of Chicago the system is known as DIGGER. All utility companies and municipalities which have buried utility facilities in the State of Illinois are a part of this system.

The Contractor shall call JULIE (800-892-0123) or DIGGER (312-744-7000), a minimum of 48 hours in advance of work being done in the area, and they will notify all member utility companies involved their respective utility should be located.

For utilities which are not members of JULIE or DIGGER, the Contractor shall contact the owners directly. The plan general notes will indicate which utilities are not members of JULIE or DIGGER.

The following table indicates the color of markings required of the State-Wide One Call Notification System.

Utility Service	Color
Electric Power, Distribution and Transmission	Safety Red
Municipal Electric Systems	Safety Red
Gas Distribution and Transmission	High Visibility Safety Yellow
Oil Distribution and Transmission	High Visibility Safety Yellow
Telephone and Telegraph System	Safety Alert Orange
Community Antenna Television Systems	Safety Alert Orange
Water Systems	Safety Precaution Blue
Sewer Systems	Safety Green
Non-Potable Water and Slurry Lines	Safety Purple
Temporary Survey	Safety Pink
Proposed Excavation	Safety White (Black when snow is on the ground)

The State-Wide One Call Notification System will provide for horizontal locations of utilities. When it is determined that the vertical location of the utility is necessary to facilitate construction, the Engineer may make the request for location from the utility after receipt of notice from the Contractor. If the utility owner does not field locate their facilities to the satisfaction of the Engineer, the Engineer will authorize the Contractor in writing to proceed to locate the facilities in the most economical and reasonable manner, subject to the approval of the Engineer, and be paid according to Article 109.04.

The Contractor shall be responsible for maintaining the excavations or markers provided by the utility owners.

The Contractor shall take all necessary precautions for the protection of the utility facilities. The Contractor shall be responsible for any damage or destruction of utility facilities resulting from neglect, misconduct, or omission in the Contractor's manner or method of execution or nonexecution of the work, or caused by defective work or the use of unsatisfactory materials. Whenever any damage or destruction of a utility facility occurs as a result of work performed by the Contractor, the utility company will be immediately notified. The utility company will make arrangements to restore such facility to a condition equal to that existing before any such damage or destruction was done.

In the event of interruption of utility services as a result of accidental breakage or as a result of being exposed or unsupported, the Contractor shall promptly notify the proper authority and shall cooperate with the said authority in the restoration of service. If water service is interrupted, repair work shall be continuous until the service is restored. No work shall be undertaken around fire hydrants until provisions for continued service have been approved by the local fire authority.

107.40 Conflicts with Utilities. Except as provided hereinafter, the discovery of a utility in an unanticipated location will be evaluated according to Article 104.03. It is understood and agreed that the Contractor has considered in the bid all facilities not meeting the definition of a utility in an unanticipated location and no additional compensation will be allowed for any delays, inconveniences, or damages sustained by the Contractor due to the presence of or any claimed interference from such facilities.

When the Contractor discovers a utility in an unanticipated location, the Contractor shall not interfere with said utility, shall take proper precautions to prevent damage or interruption of the utility, and shall promptly notify the Engineer of the nature and location of said utility.

- (a) Definition. A utility in an unanticipated location is defined as an active or inactive utility, which is either:
- (1) Located underground and (a) not shown in any way in any location on the contract documents; (b) not identified in writing by the Department to the Contractor prior to the letting; or (c) not located relative to the location shown in the contract within the tolerances provided in 220 ILCS 50/2.8 or Administrative Code Title 92 Part 530.40(c); or
 - (2) Located above ground or underground and not relocated as provided in the contract.

Service connections shall not be considered to be utilities in unanticipated locations.

- (b) Compensation. Compensation will not be allowed for delays, inconveniences, or damages sustained by the Contractor from conflicts with facilities not meeting the above definition; or if a conflict with a utility in an unanticipated location does not cause a shutdown of the work applicable to the utility or a documentable reduction in the rate of progress exceeding the limits set herein. The provisions of Article 104.03 notwithstanding, compensation for delays caused by a utility in an unanticipated location will be paid according to the provisions of this Article governing minor and major delays or reduced rate of production which are defined as follows:

- (1) Minor Delay. A minor delay occurs when the Contractor's operation is completely stopped by a utility in an unanticipated location for more than two hours, but not to exceed three weeks.
 - (2) Major Delay. A major delay occurs when the Contractor's operation is completely stopped by a utility in an unanticipated location for more than three weeks.
 - (3) Reduced Rate of Production Delay. A reduced rate of production delay occurs when the contractor's rate of production decreases by more than 25 percent and lasts longer than seven days.
- (c) Payment. Payment for Minor, Major and Reduced Rate of Production Delays will be made as follows.

- (1) Minor Delay. Labor idled which cannot be used on other work will be paid for according to Article 109.04(b)(1) and (2) for the time between start of the delay and the minimum remaining hours in the work shift required by the prevailing practice in the area.

Equipment idled which cannot be used on other work, and which is authorized to standby on the project site by the Engineer, will be paid for according to Article 109.04(b)(4).

- (2) Major Delay. Labor will be the same as for a minor delay.

Equipment will be the same as for a minor delay, except Contractor-owned equipment will be limited to three weeks plus the cost of move-out to either the Contractor's yard or another job, whichever is less. Rental equipment may be paid for longer than three weeks provided the Contractor presents adequate support to the Department (including lease agreement) to show retaining equipment on the job is the most economical course to follow and in the public interest.

- (3) Reduced Rate of Production Delay. The Contractor will be compensated for the reduced productivity for labor and equipment time in excess of the 25 percent threshold for that portion of the delay in excess of seven days. Determination of compensation will be in accordance with Article 104.02, except labor and material additives will not be permitted.

Whether covered by (1), (2) or (3) above, additional traffic control required as a result of the operation(s) delayed will be paid for according to Article 109.04 for the total length of the delay.

If the delay is clearly shown to have caused work, which would have otherwise been completed, to be done after material or labor costs have increased, such increases may be paid. Payment for materials will be limited to increased cost substantiated by documentation furnished by the Contractor. Payment for increased labor rates will include those items in Article 109.04(b)(1) and (2), except the 35 percent and ten percent additives will not be permitted. On a working day contract, a delay occurring between November 30 and May 1, when work has not started, will not be considered as eligible for payment of measured labor and material costs.

Project overhead (not including interest) will be allowed when all progress on the contract has been delayed, and will be calculated as 15 percent of the delay claim.

- (d) Other Obligations of Contractor. Upon payment of a claim under this provision, the Contractor shall assign subrogation rights to the Department for the Department's efforts of recovery from any other party for monies paid by the Department as a result of any claim under this Provision. The Contractor shall fully cooperate with the Department in its efforts to recover from another party any money paid to the Contractor for delay damages under this Provision."

WEEKLY DBE TRUCKING REPORTS (BDE)

Effective: June 2, 2012

The Contractor shall provide a weekly report of Disadvantaged Business Enterprise (DBE) trucks hired by the Contractor or subcontractors (i.e. not owned by the Contractor or subcontractors) that are used on the jobsite; or used for the delivery and/or removal of equipment/material to and from the jobsite. The jobsite shall also include offsite locations, such as plant sites or storage sites, when those locations are used solely for this contract.

The report shall be submitted on the form provided by the Department within ten business days following the reporting period. The reporting period shall be Monday through Sunday for each week reportable trucking activities occur. The report shall be submitted to the Engineer and a copy shall be provided to the district EEO Officer.

Any costs associated with providing weekly DBE trucking reports shall be considered as included in the contract unit prices bid for the various items of work involved and no additional compensation will be allowed.

STEEL COST ADJUSTMENT (BDE) (RETURN FORM WITH BID)

Effective: April 2, 2004

Revised: April 1, 2009

Description. Steel cost adjustments will be made to provide additional compensation to the Contractor, or a credit to the Department, for fluctuations in steel prices when optioned by the Contractor. The bidder shall indicate on the attached form whether or not this special provision will be part of the contract and submit the completed form with his/her bid. Failure to submit the form or failure to indicate contract number, company name, and sign and date the form shall make this contract exempt of steel cost adjustments for all items of steel. Failure to indicate "Yes" for any item of work will make that item of steel exempt from steel cost adjustment.

Types of Steel Products. An adjustment will be made for fluctuations in the cost of steel used in the manufacture of the following items:

- Metal Piling (excluding temporary sheet piling)
- Structural Steel
- Reinforcing Steel

Other steel materials such as dowel bars, tie bars, mesh reinforcement, guardrail, steel traffic signal and light poles, towers and mast arms, metal railings (excluding wire fence), and frames and grates will be subject to a steel cost adjustment when the pay items they are used in has a contract value of \$10,000 or greater.

Documentation. Sufficient documentation shall be furnished to the Engineer to verify the following:

- (a) The dates and quantity of steel, in lb (kg), shipped from the mill to the fabricator.
- (b) The quantity of steel, in lb (kg), incorporated into the various items of work covered by this special provision. The Department reserves the right to verify submitted quantities.

Method of Adjustment. Steel cost adjustments will be computed as follows:

$$SCA = Q \times D$$

Where: SCA = steel cost adjustment, in dollars
Q = quantity of steel incorporated into the work, in lb (kg)
D = price factor, in dollars per lb (kg)

$$D = MPI_M - MPI_L$$

Where: MPI_M = The Materials Cost Index for steel as published by the Engineering News-Record for the month the steel is shipped from the mill. The indices will be converted from dollars per 100 lb to dollars per lb (kg).

MPI_L = The Materials Cost Index for steel as published by the Engineering News-Record for the month prior to the letting. The indices will be converted from dollars per 100 lb to dollars per lb (kg).

The unit weights (masses) of steel that will be used to calculate the steel cost adjustment for the various items are shown in the attached table.

No steel cost adjustment will be made for any products manufactured from steel having a mill shipping date prior to the letting date.

If the Contractor fails to provide the required documentation, the method of adjustment will be calculated as described above; however, the MPI_M will be based on the date the steel arrives at the job site. In this case, an adjustment will only be made when there is a decrease in steel costs.

Basis of Payment. Steel cost adjustments may be positive or negative but will only be made when there is a difference between the MPI_L and MPI_M in excess of five percent, as calculated by:

$$\text{Percent Difference} = \{(MPI_L - MPI_M) \div MPI_L\} \times 100$$

Steel cost adjustments will be calculated by the Engineer and will be paid or deducted when all other contract requirements for the items of work are satisfied. Adjustments will only be made for fluctuations in the cost of the steel as described herein. No adjustment will be made for changes in the cost of manufacturing, fabrication, shipping, storage, etc.

The adjustments shall not apply during contract time subject to liquidated damages for completion of the entire contract.

Attachment

Item	Unit Mass (Weight)
Metal Piling (excluding temporary sheet piling)	
Furnishing Metal Pile Shells 12 in. (305 mm), 0.179 in. (3.80 mm) wall thickness)	23 lb/ft (34 kg/m)
Furnishing Metal Pile Shells 12 in. (305 mm), 0.250 in. (6.35 mm) wall thickness)	32 lb/ft (48 kg/m)
Furnishing Metal Pile Shells 14 in. (356 mm), 0.250 in. (6.35 mm) wall thickness)	37 lb/ft (55 kg/m)
Other piling	See plans
Structural Steel	See plans for weights (masses)
Reinforcing Steel	See plans for weights (masses)
Dowel Bars and Tie Bars	6 lb (3 kg) each
Mesh Reinforcement	63 lb/100 sq ft (310 kg/sq m)
Guardrail	
Steel Plate Beam Guardrail, Type A w/steel posts	20 lb/ft (30 kg/m)
Steel Plate Beam Guardrail, Type B w/steel posts	30 lb/ft (45 kg/m)
Steel Plate Beam Guardrail, Types A and B w/wood posts	8 lb/ft (12 kg/m)
Steel Plate Beam Guardrail, Type 2	305 lb (140 kg) each
Steel Plate Beam Guardrail, Type 6	1260 lb (570 kg) each
Traffic Barrier Terminal, Type 1 Special (Tangent)	730 lb (330 kg) each
Traffic Barrier Terminal, Type 1 Special (Flared)	410 lb (185 kg) each
Steel Traffic Signal and Light Poles, Towers and Mast Arms	
Traffic Signal Post	11 lb/ft (16 kg/m)
Light Pole, Tenon Mount and Twin Mount, 30 - 40 ft (9 - 12 m)	14 lb/ft (21 kg/m)
Light Pole, Tenon Mount and Twin Mount, 45 - 55 ft (13.5 - 16.5 m)	21 lb/ft (31 kg/m)
Light Pole w/Mast Arm, 30 - 50 ft (9 - 15.2 m)	13 lb/ft (19 kg/m)
Light Pole w/Mast Arm, 55 - 60 ft (16.5 - 18 m)	19 lb/ft (28 kg/m)
Light Tower w/Luminaire Mount, 80 - 110 ft (24 - 33.5 m)	31 lb/ft (46 kg/m)
Light Tower w/Luminaire Mount, 120 - 140 ft (36.5 - 42.5 m)	65 lb/ft (97 kg/m)
Light Tower w/Luminaire Mount, 150 - 160 ft (45.5 - 48.5 m)	80 lb/ft (119 kg/m)
Metal Railings (excluding wire fence)	
Steel Railing, Type SM	64 lb/ft (95 kg/m)
Steel Railing, Type S-1	39 lb/ft (58 kg/m)
Steel Railing, Type T-1	53 lb/ft (79 kg/m)
Steel Bridge Rail	52 lb/ft (77 kg/m)
Frames and Grates	
Frame	250 lb (115 kg)
Lids and Grates	150 lb (70 kg)

Return With Bid

**ILLINOIS DEPARTMENT
OF TRANSPORTATION**

**OPTION FOR
STEEL COST ADJUSTMENT**

The bidder shall submit this completed form with his/her bid. Failure to submit the form or properly complete contract number, company name, and sign and date the form shall make this contract exempt of steel cost adjustments for all items of steel. Failure to indicate "Yes" for any item of work will make that item of steel exempt from steel cost adjustment. After award, this form, when submitted shall become part of the contract.

Contract No.: _____

Company Name: _____

Contractor's Option:

Is your company opting to include this special provision as part of the contract plans for the following items of work?

- | | | |
|------------------------------------------------------------|-----|--------------------------|
| Metal Piling | Yes | <input type="checkbox"/> |
| Structural Steel | Yes | <input type="checkbox"/> |
| Reinforcing Steel | Yes | <input type="checkbox"/> |
| Dowel Bars, Tie Bars and Mesh Reinforcement | Yes | <input type="checkbox"/> |
| Guardrail | Yes | <input type="checkbox"/> |
| Steel Traffic Signal and Light Poles, Towers and Mast Arms | Yes | <input type="checkbox"/> |
| Metal Railings (excluding wire fence) | Yes | <input type="checkbox"/> |
| Frames and Grates | Yes | <input type="checkbox"/> |

Signature: _____ **Date:** _____

STATE OF ILLINOIS
DEPARTMENT OF TRANSPORTATION
INT ATTRACT SIGN 2014-09
C-60-009-14

INDEX OF SHEETS

1	COVER SHEET	1
2	ESTIMATED SUMMARY OF QUANTITIES	2
3	SAMPLE WORK ORDER	3
4	CLEAR HEIGHT DETAIL	4
5 - 6	BREAK - AWAY STEEL SIGN POST DETAILS	5
7 - 17	LOGO SIGN DETAILS	7

STANDARDS

701006-04	701401-07
701101-03	701406-06
701106-02	701411-08
701201-04	701426-05
701301-04	701901-02
701400-06	720021-02

SUMMARY OF QUANTITIES

CODE NUMBER	PAY ITEM	UNIT	0021 100% STATE TOTAL QUANTITY
67100100	MOBILIZATION	L SUM	1
72000300	SIGN PANEL - TYPE 3	SQ FT	23000
72700100	STRUCTURAL STEEL SIGN SUPPORT - BREAKAWAY	POUND	55000
73400100	CONCRETE FOUNDATIONS	CU YD	100
73700200	REMOVE CONCRETE FOUNDATION - GROUND MOUNT	EACH	30
X7010216	TRAFFIC CONTROL AND PROTECTION, (SPECIAL)	L SUM	1
X7200075	REMOVE AND REINSTALL SIGN PANEL	SQ FT	900
X7240195	REMOVE EXISTING SIGN PANEL	EACH	40
X7240207	REMOVE EXISTING SIGN COMPLETE	EACH	50
X7270025	REMOVE EXISTING SIGN SUPPORT	EACH	35
Z0030905	INSTALL SERVICE SIGN OR MILEAGE PLATE	EACH	160
Z0030907	REMOVE SERVICE OR MILEAGE PLATE	EACH	50
Z0030910	TRANSFER SERVICE SIGN	EACH	75

↳

CLEAR HEIGHT DETAIL

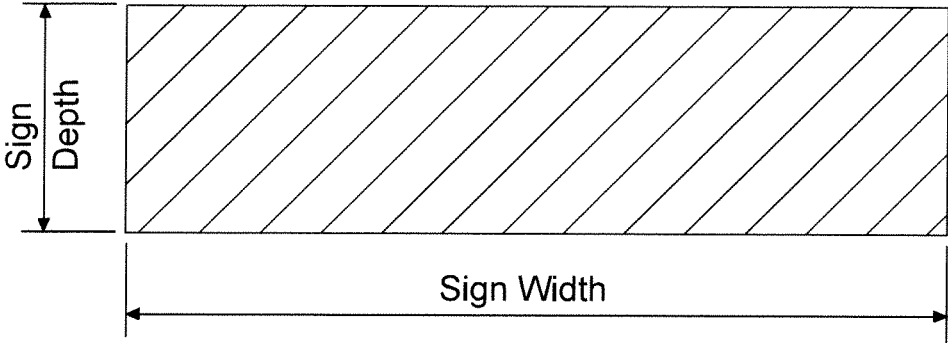

Figure 1

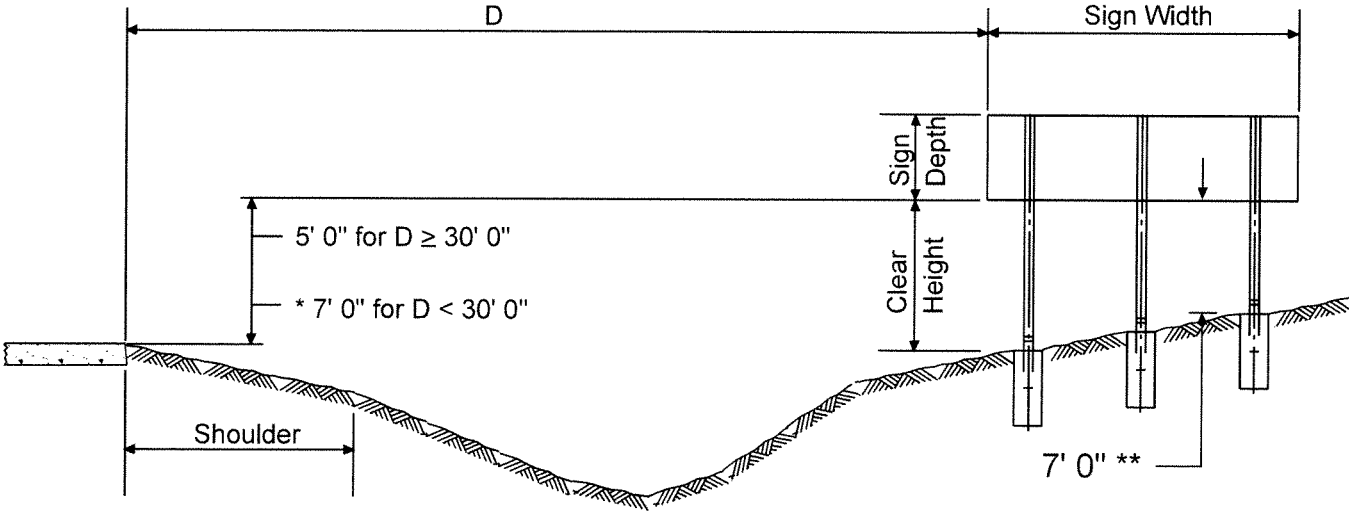
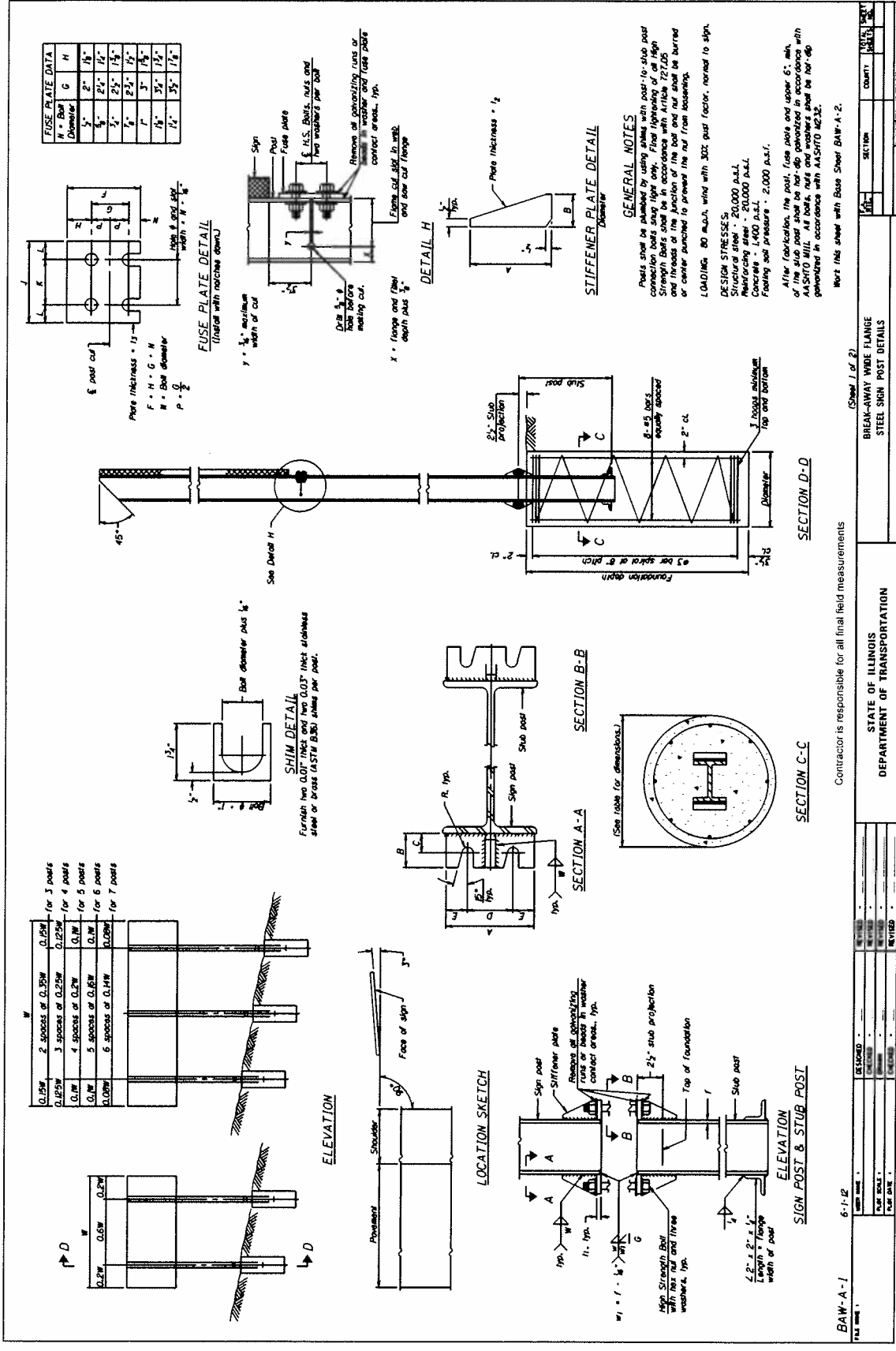

Figure 2

- * May be reduced to 6' 0" when a supplemental panel is mounted below the main panel.
- ** Between top of stud post and fuse plate. May be reduced to 5' 0" when $D = 30' 0''$ and the slope is 2:1 or steeper or where it would be unlikely for an out of control vehicle to reach the post.

The criteria illustrated in Figure 2 above is for expressways or fully access controlled freeways. All mounting heights shall be in accordance with the latest edition of the Illinois Manual on Uniform Traffic Control Devices.



Contractor is responsible for all final field measurements

STATE OF ILLINOIS
 DEPARTMENT OF TRANSPORTATION

BAW-A-1
 6-1-12

DATE	BY	REVISION

SECTION	COUNTY	DATE
BREAK-AWAY WIDE FLANGE STEEL SIGN POST DETAILS		

POST	CONCRETE FOUNDATION TABLE			REINFORCEMENT		SUB POST		POST TO STUB POST CONNECTION DATA											FUSE PLATE DATA				
	Diameter	Minimum Depth	Concrete (cu. yds.)	Vertical Base Length	Vertical Base Diameter	Length	Length	Bar Size	A	B	C	D	E	F	G	H	I	J	K	L	M		
W6-9	2'-0"	6'-0"	0.70	5'-9"	1'-8 1/2"	79'-0"	78	2'-0"	6"	2 1/2"	1 1/2"	3 1/2"	1 1/2"	3 1/2"	1 1/2"	3 1/2"	1 1/2"	3 1/2"	1 1/2"	3 1/2"	1 1/2"	3 1/2"	
W6-15	2'-0"	6'-0"	0.70	5'-9"	1'-8 1/2"	79'-0"	78	2'-0"	6"	2 1/2"	1 1/2"	3 1/2"	1 1/2"	3 1/2"	1 1/2"	3 1/2"	1 1/2"	3 1/2"	1 1/2"	3 1/2"	1 1/2"	3 1/2"	
W8-18	2'-0"	6'-0"	0.70	5'-9"	1'-8 1/2"	79'-0"	78	2'-0"	6"	2 1/2"	1 1/2"	3 1/2"	1 1/2"	3 1/2"	1 1/2"	3 1/2"	1 1/2"	3 1/2"	1 1/2"	3 1/2"	1 1/2"	3 1/2"	
W10-22	2'-6"	6'-6"	1.18	6'-3"	2'-2 1/2"	105'-0"	92	3'-0"	7"	3 1/2"	2 1/2"	4"	2 1/2"	4"	2 1/2"	4"	2 1/2"	4"	2 1/2"	4"	2 1/2"	4"	
W12-26	2'-6"	7'-0"	1.27	6'-9"	2'-2 1/2"	109'-0"	98	3'-0"	7"	3 1/2"	2 1/2"	4"	2 1/2"	4"	2 1/2"	4"	2 1/2"	4"	2 1/2"	4"	2 1/2"	4"	
W14-30	3'-0"	7'-3"	1.50	7'-0"	2'-6 1/2"	145'-0"	113	3'-0"	8"	4"	3 1/2"	4"	3 1/2"	4"	3 1/2"	4"	3 1/2"	4"	3 1/2"	4"	3 1/2"	4"	
W16-45	3'-0"	8'-6"	2.23	8'-3"	2'-8 1/2"	182'-0"	130	3'-6"	1'-0"	4 1/2"	4"	4 1/2"	4"	4 1/2"	4"	4 1/2"	4"	4 1/2"	4"	4 1/2"	4"	4 1/2"	

*Dimensional changes required for varying site conditions shall be approved by the Engineer.

POST	FUSE PLATE BOLT SIZE											SUB POST										
	4'-0"	5'-0"	6'-0"	7'-0"	8'-0"	9'-0"	10'-0"	11'-0"	12'-0"	13'-0"	14'-0"	15'-0"	16'-0"	17'-0"	18'-0"	19'-0"	20'-0"	21'-0"	22'-0"	23'-0"	24'-0"	
W6-9	1/2" x 1 1/2"	1/2" x 1 1/2"	1/2" x 1 1/2"	1/2" x 1 1/2"	1/2" x 1 1/2"	1/2" x 1 1/2"	1/2" x 1 1/2"	1/2" x 1 1/2"	1/2" x 1 1/2"	1/2" x 1 1/2"	1/2" x 1 1/2"	1/2" x 1 1/2"	1/2" x 1 1/2"	1/2" x 1 1/2"	1/2" x 1 1/2"	1/2" x 1 1/2"	1/2" x 1 1/2"	1/2" x 1 1/2"	1/2" x 1 1/2"	1/2" x 1 1/2"	1/2" x 1 1/2"	1/2" x 1 1/2"
W6-15	1/2" x 1 1/2"	1/2" x 1 1/2"	1/2" x 1 1/2"	1/2" x 1 1/2"	1/2" x 1 1/2"	1/2" x 1 1/2"	1/2" x 1 1/2"	1/2" x 1 1/2"	1/2" x 1 1/2"	1/2" x 1 1/2"	1/2" x 1 1/2"	1/2" x 1 1/2"	1/2" x 1 1/2"	1/2" x 1 1/2"	1/2" x 1 1/2"	1/2" x 1 1/2"	1/2" x 1 1/2"	1/2" x 1 1/2"	1/2" x 1 1/2"	1/2" x 1 1/2"	1/2" x 1 1/2"	1/2" x 1 1/2"
W8-18	1/2" x 1 1/2"	1/2" x 1 1/2"	1/2" x 1 1/2"	1/2" x 1 1/2"	1/2" x 1 1/2"	1/2" x 1 1/2"	1/2" x 1 1/2"	1/2" x 1 1/2"	1/2" x 1 1/2"	1/2" x 1 1/2"	1/2" x 1 1/2"	1/2" x 1 1/2"	1/2" x 1 1/2"	1/2" x 1 1/2"	1/2" x 1 1/2"	1/2" x 1 1/2"	1/2" x 1 1/2"	1/2" x 1 1/2"	1/2" x 1 1/2"	1/2" x 1 1/2"	1/2" x 1 1/2"	1/2" x 1 1/2"
W10-22	1/2" x 2"	1/2" x 2"	1/2" x 2"	1/2" x 2"	1/2" x 2"	1/2" x 2"	1/2" x 2"	1/2" x 2"	1/2" x 2"	1/2" x 2"	1/2" x 2"	1/2" x 2"	1/2" x 2"	1/2" x 2"	1/2" x 2"	1/2" x 2"	1/2" x 2"	1/2" x 2"	1/2" x 2"	1/2" x 2"	1/2" x 2"	1/2" x 2"
W12-26	1/2" x 2"	1/2" x 2"	1/2" x 2"	1/2" x 2"	1/2" x 2"	1/2" x 2"	1/2" x 2"	1/2" x 2"	1/2" x 2"	1/2" x 2"	1/2" x 2"	1/2" x 2"	1/2" x 2"	1/2" x 2"	1/2" x 2"	1/2" x 2"	1/2" x 2"	1/2" x 2"	1/2" x 2"	1/2" x 2"	1/2" x 2"	1/2" x 2"
W14-30	1/2" x 2"	1/2" x 2"	1/2" x 2"	1/2" x 2"	1/2" x 2"	1/2" x 2"	1/2" x 2"	1/2" x 2"	1/2" x 2"	1/2" x 2"	1/2" x 2"	1/2" x 2"	1/2" x 2"	1/2" x 2"	1/2" x 2"	1/2" x 2"	1/2" x 2"	1/2" x 2"	1/2" x 2"	1/2" x 2"	1/2" x 2"	1/2" x 2"
W16-45	1/2" x 2"	1/2" x 2"	1/2" x 2"	1/2" x 2"	1/2" x 2"	1/2" x 2"	1/2" x 2"	1/2" x 2"	1/2" x 2"	1/2" x 2"	1/2" x 2"	1/2" x 2"	1/2" x 2"	1/2" x 2"	1/2" x 2"	1/2" x 2"	1/2" x 2"	1/2" x 2"	1/2" x 2"	1/2" x 2"	1/2" x 2"	1/2" x 2"

- ① Quantity includes all concrete necessary for one foundation.
- ② Includes reinforcement bars and spiral hooping for one foundation.

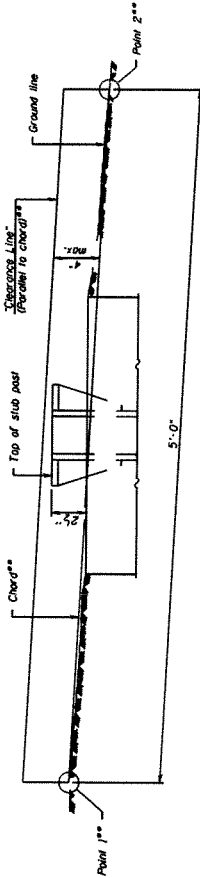

ELEVATION
 GROUND LINE & STUB POST

** For all "Point 1" and "Point 2" locations, "Clearance" Line must be at or above top of stub post.

6-1-12

BAW-A-2

Contractor is responsible for all final field measurements

(Sheet 2 of 2)

DESIGNED	REVISION	STATE OF ILLINOIS	BREAK-AWAY WIDE FLANGE	SECTION	POST	POST	POST
CHECKED	REVISION	DEPARTMENT OF TRANSPORTATION	STEEL SIGN POST TABLES	SECTION	POST	POST	POST
DRAWN	REVISION			SECTION	POST	POST	POST
PLT DATE	REVISION			SECTION	POST	POST	POST

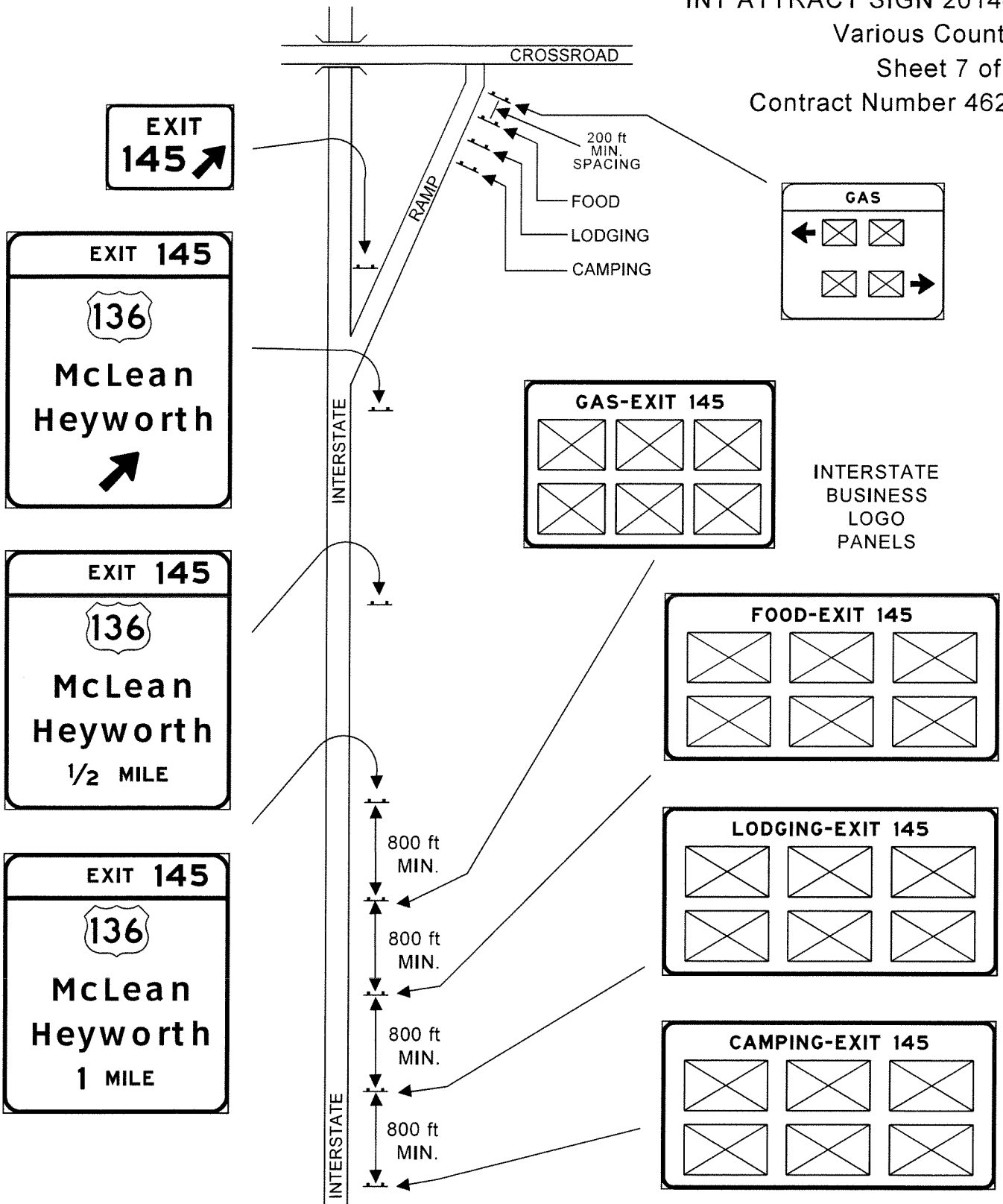

 BUSINESS LOGO

LOGO SERVICE SIGN DETAILS

TYPICAL LOGO SIGNING
 SIGN LAYOUT

MAINLINE SUPPLEMENTAL SERVICE SIGN DETAILS

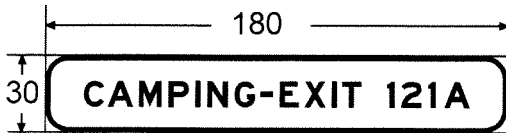
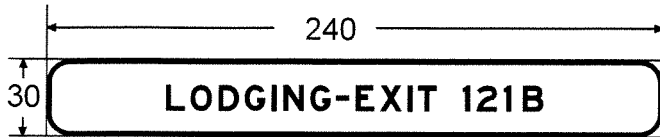

**MAINLINE SUPPLEMENTAL SERVICE SIGNS
 ONLY USED FOR THE FOLLOWING SERVICES.
 GAS, FOOD, LODGING, AND CAMPING**

MAINLINE SUPPLEMENTAL SERVICE SIGN NOTES:

1. To be placed beneath Logo Service Signs where indicated.
2. Same general notes and legend sizes apply here as to other mainline Logo Service Signs.

MAINLINE SIGN WORD SPACING

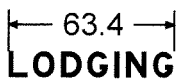
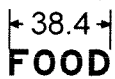
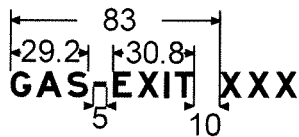

**MAINLINE SERVICE PLATE HOLE SPACING DETAILS
 (PLATES FURNISHED BY OTHERS)**

Hole spacing for 60" wide by 36" high FOOD, LODGING, CAMPING, ATTRACTIONS, 24-HR PHARMACY logos.

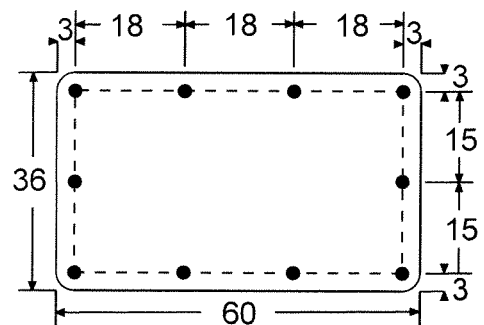

Hole spacing for 48" wide by 36" high GAS logo.

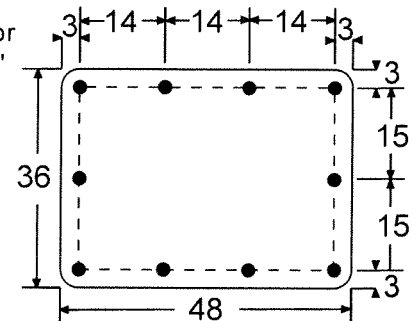

GENERAL NOTES FOR MAINLINE SIGNS:

1. All legends are 10 inch E Modified.
2. All borders are 2 inches wide.
3. All corners have a 9 inch radius.
4. Background is Blue.
5. Legend and border is white.
6. All dimensions are shown in inches.
7. Multiple services on a single panel shall be listed by priority, from left to right or top to bottom. Priority order is GAS, FOOD, LODGING, CAMPING, ATTRACTIONS, 24-HOUR PHARMACY.

SERVICE PLATE NOTES:

1. Holes must be $\frac{3}{16}$ " (0.1875 in. dia.).
2. All Service Plate corners have a 3 inch radius.

LOGO SERVICE SIGN DETAILS

**MAINLINE SIGN
 SPECIFICATIONS**

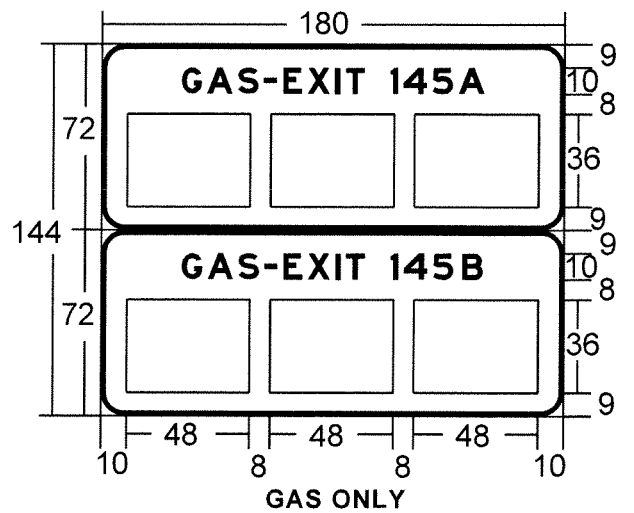
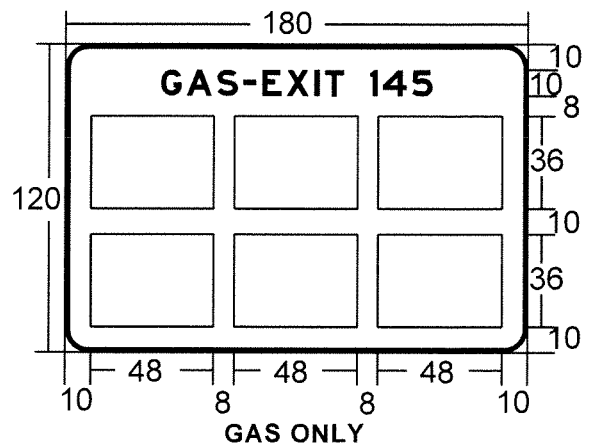
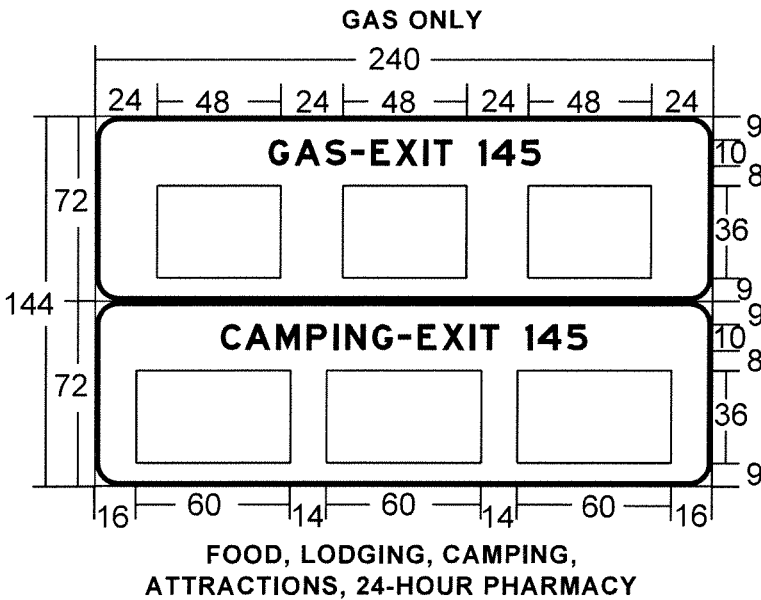
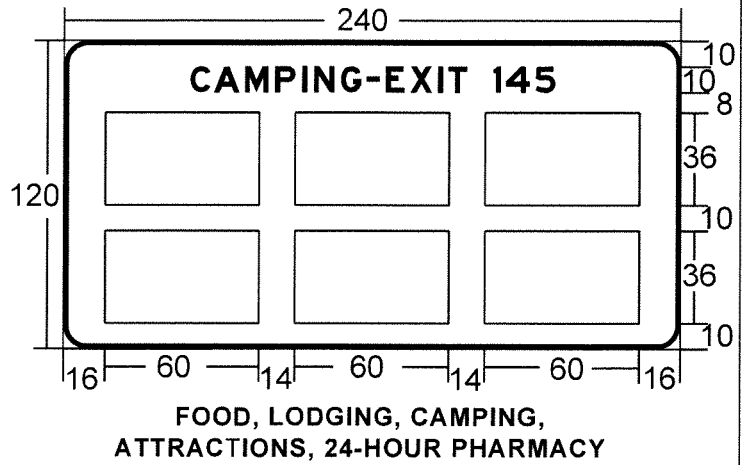
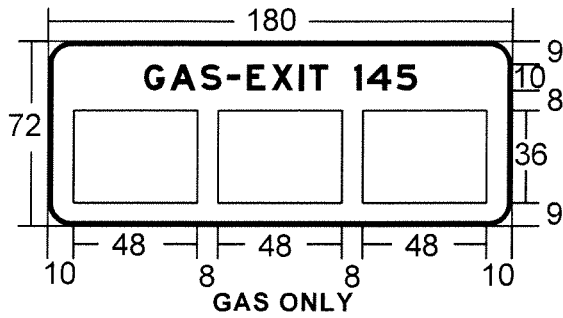
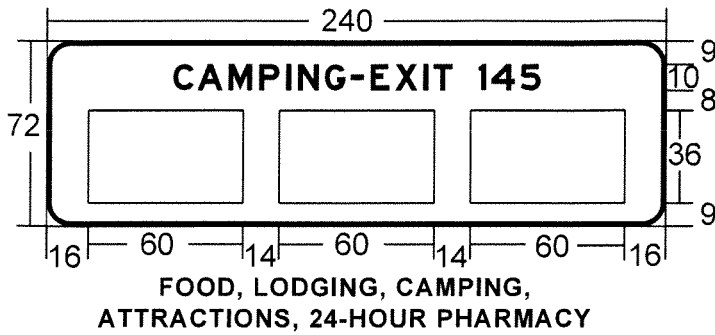

GENERAL NOTES FOR MAINLINE SIGNS:

1. All legends are 10 inch E Modified.
2. All borders are 2 inches wide.
3. All corners have a 9 inch radius.
4. Background is Blue.
5. Legend and border is white.
6. All dimensions are shown in inches.
7. Multiple services on a single panel shall be listed by priority, from left to right or top to bottom. Priority order is GAS, FOOD, LODGING, CAMPING, ATTRACTIONS, 24-HOUR PHARMACY.

LOGO SERVICE SIGN DETAILS

**STATE OF ILLINOIS
 DEPARTMENT OF TRANSPORTATION**

**MAINLINE SIGN
 EXAMPLES**

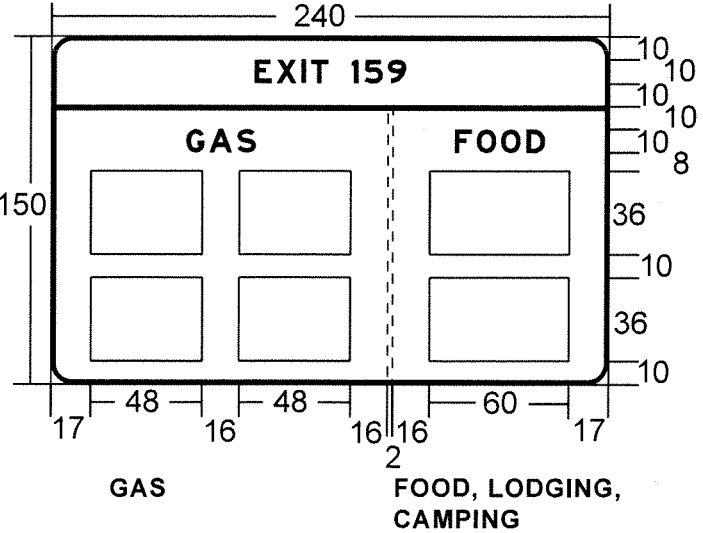
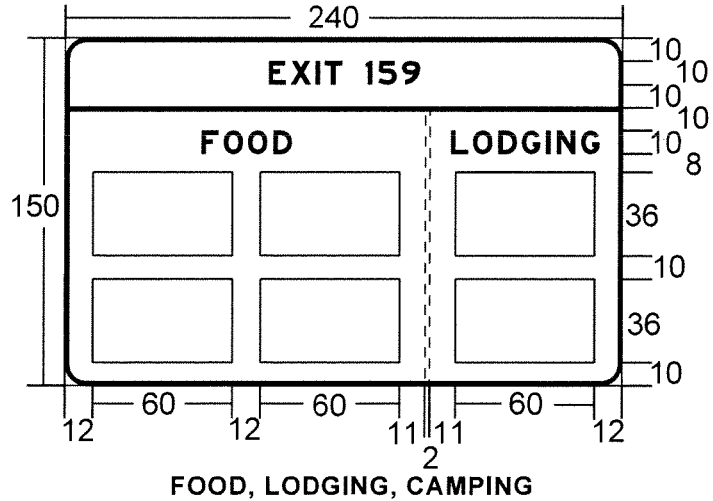
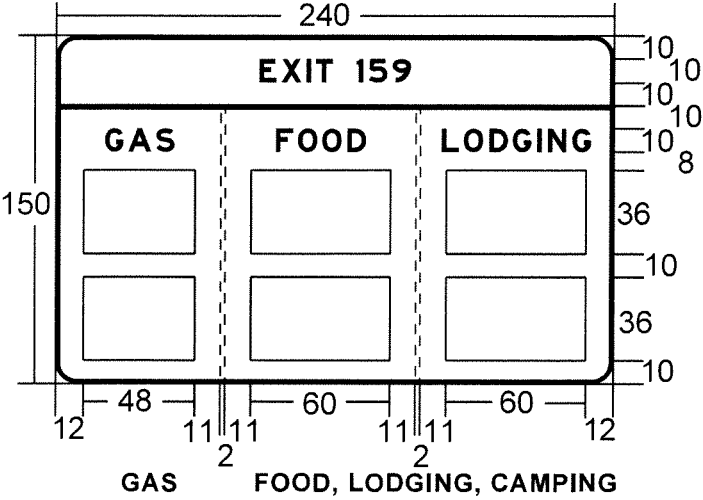
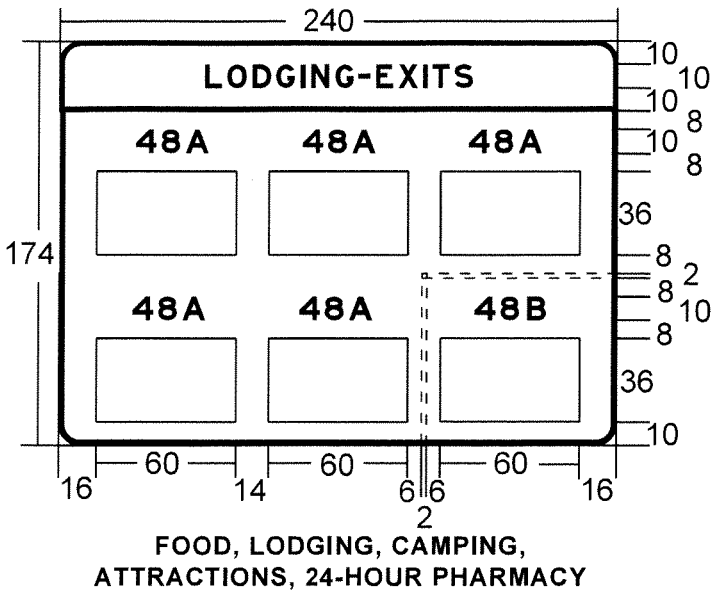

GENERAL NOTES FOR MAINLINE SIGNS:

1. All legends are 10 inch E Modified.
2. All borders are 2 inches wide.
3. All corners have a 9 inch radius.
4. Background is Blue.
5. Legend and border is white.
6. All dimensions are shown in inches.
7. Multiple services on a single panel shall be listed by priority, from left to right or top to bottom. Priority order is GAS, FOOD, LODGING, CAMPING, ATTRACTIONS, 24-HOUR PHARMACY.

DETACHABLE BORDER

When using a detachable border, secure with a rivet at the beginning, end and every 2 feet in between.

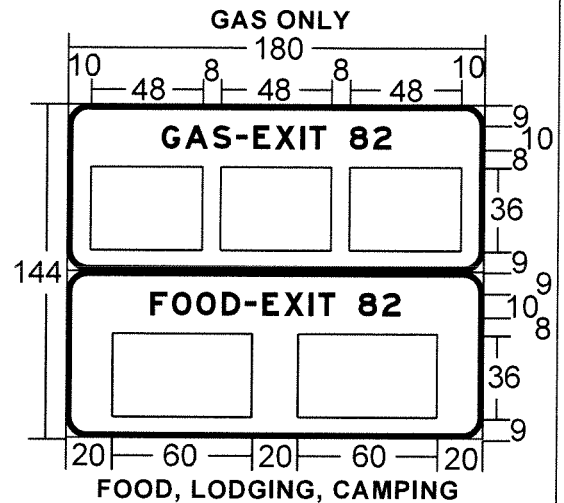
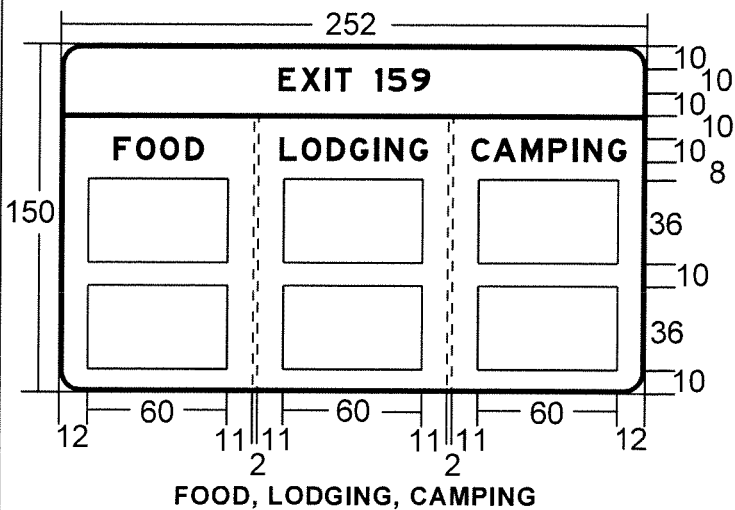
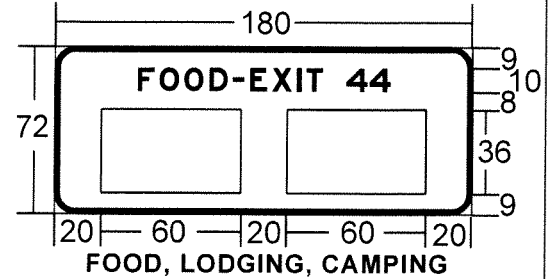
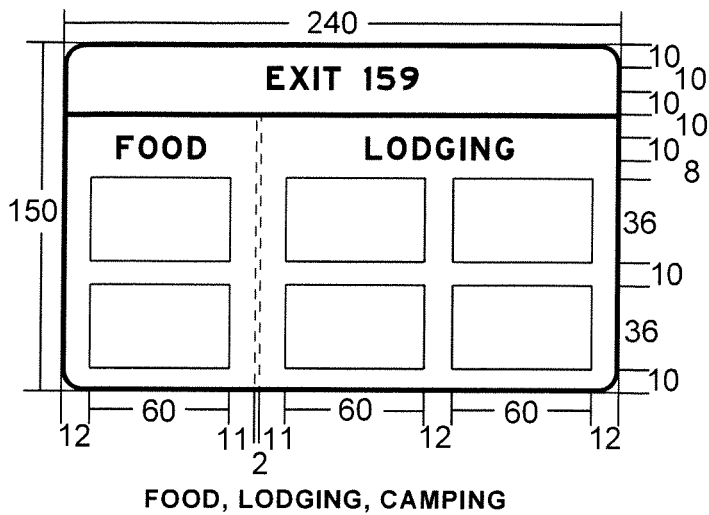

DETACHABLE BORDER

When using a detachable border, secure with a rivet at the beginning, end and every 2 feet in between.

GENERAL NOTES FOR MAINLINE SIGNS:

1. All legends are 10 inch E Modified.
2. All borders are 2 inches wide.
3. All corners have a 9 inch radius.
4. Background is Blue.
5. Legend and border is white.
6. All dimensions are shown in inches.
7. Multiple services on a single panel shall be listed by priority, from left to right or top to bottom. Priority order is GAS, FOOD, LODGING, CAMPING, ATTRACTIONS, 24-HOUR PHARMACY.

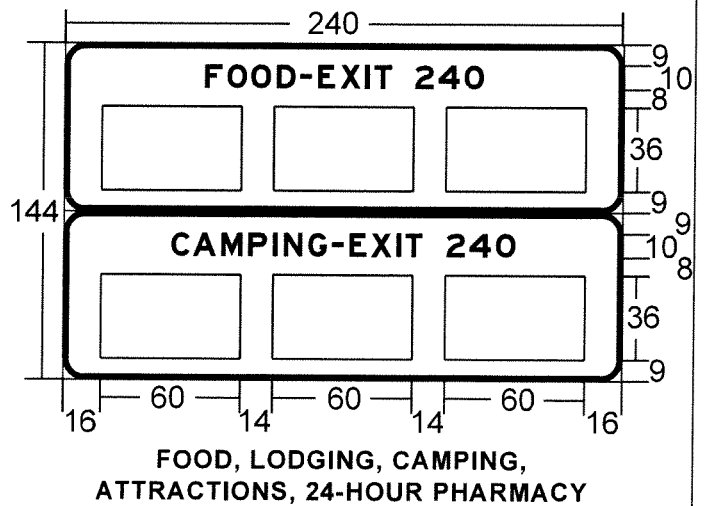

LOGO SERVICE SIGN DETAILS

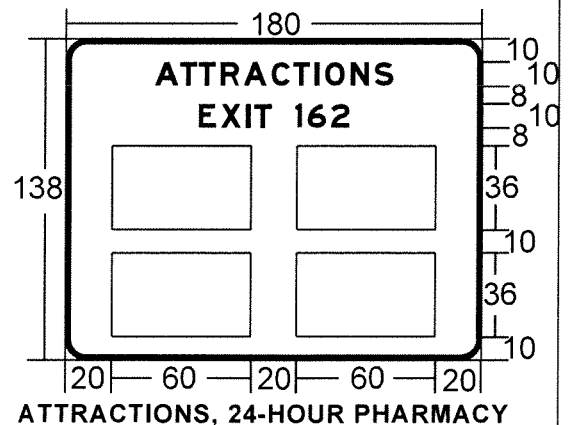
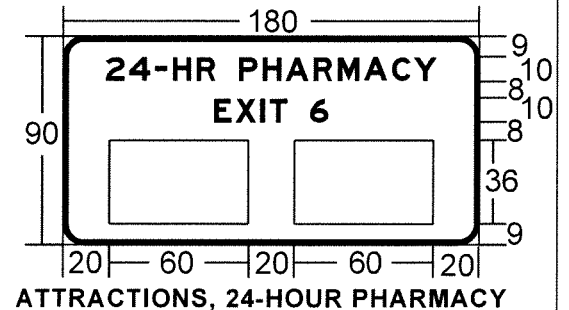
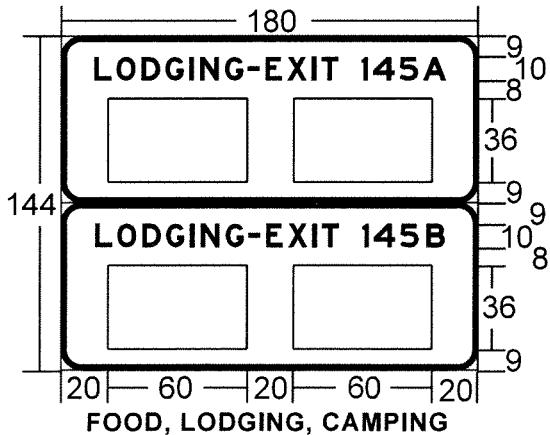
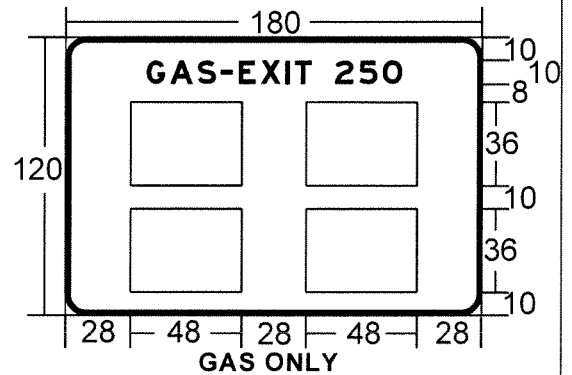
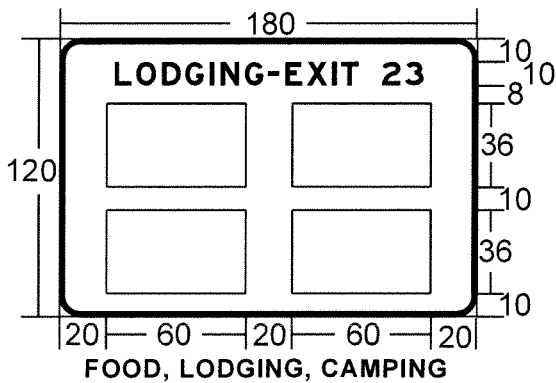
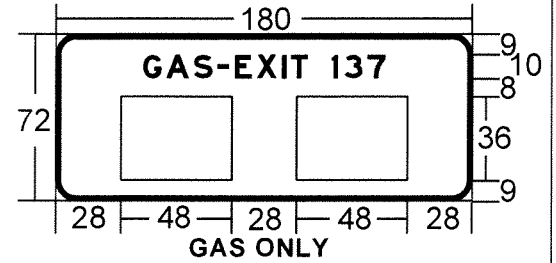
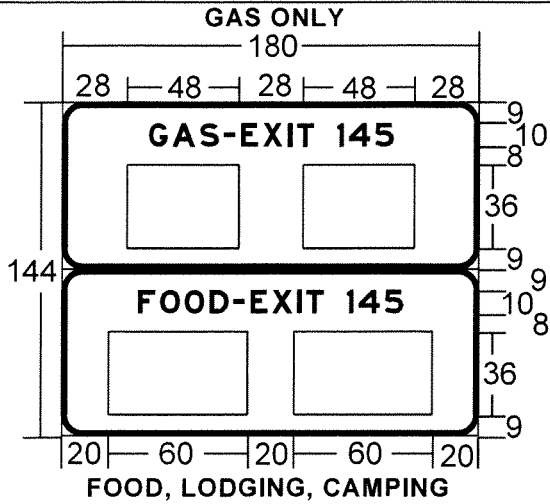

GENERAL NOTES FOR MAINLINE SIGNS:

1. All legends are 10 inch E Modified.
2. All borders are 2 inches wide.
3. All corners have a 9 inch radius.
4. Background is Blue.
5. Legend and border is white.
6. All dimensions are shown in inches.
7. Multiple services on a single panel shall be listed by priority, from left to right or top to bottom. Priority order is GAS, FOOD, LODGING, CAMPING, ATTRACTIONS, 24-HOUR PHARMACY.

LOGO SERVICE SIGN DETAILS

**STATE OF ILLINOIS
 DEPARTMENT OF TRANSPORTATION**

**MAINLINE SIGN
 EXAMPLES**

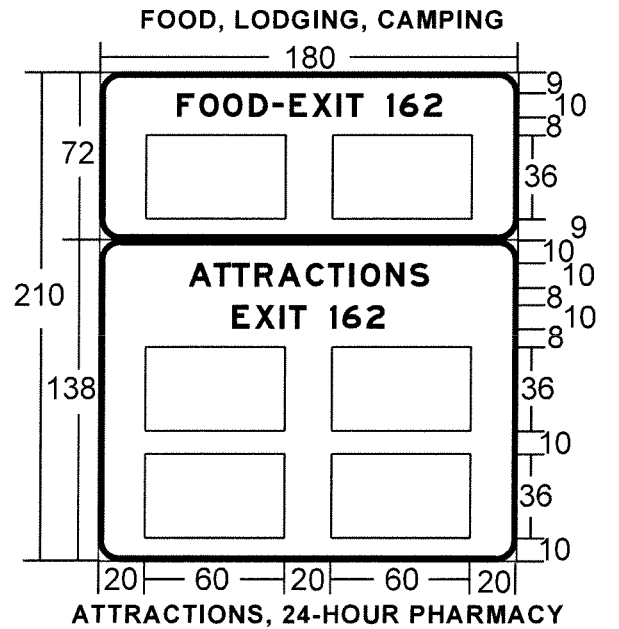
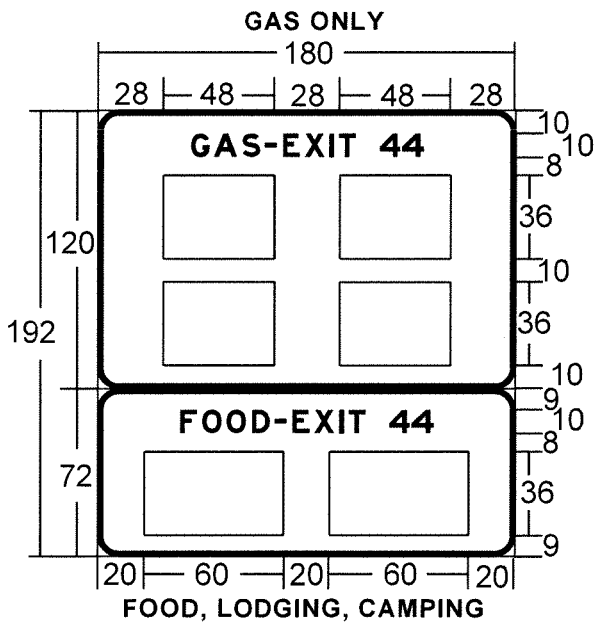
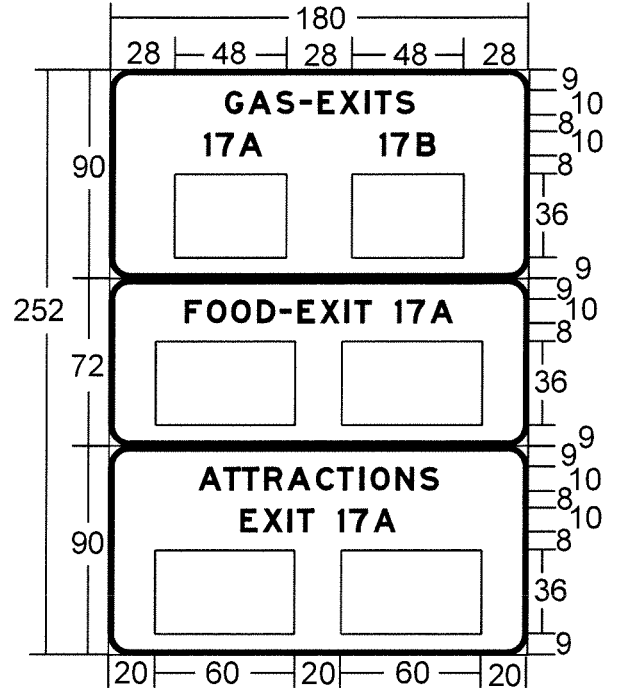
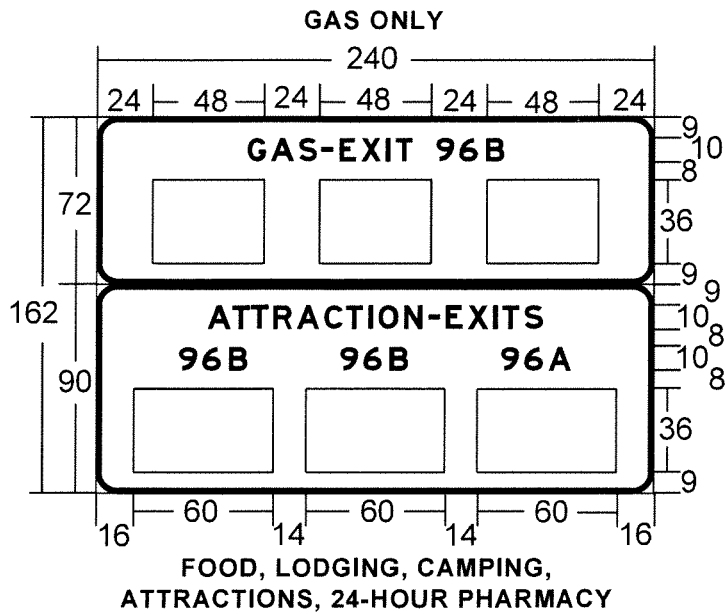

GENERAL NOTES FOR MAINLINE SIGNS:

1. All legends are 10 inch E Modified.
2. All borders are 2 inches wide.
3. All corners have a 9 inch radius.
4. Background is Blue.
5. Legend and border is white.
6. All dimensions are shown in inches.
7. Multiple services on a single panel shall be listed by priority, from left to right or top to bottom. Priority order is GAS, FOOD, LODGING, CAMPING, ATTRACTIONS, 24-HOUR PHARMACY.

LOGO SERVICE SIGN DETAILS

**STATE OF ILLINOIS
 DEPARTMENT OF TRANSPORTATION**

**MAINLINE SIGN
 EXAMPLES**

RAMP SUPPLEMENTAL SERVICE SIGN DETAILS

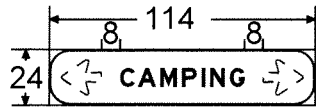
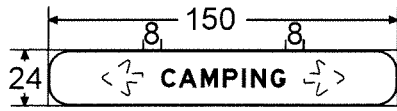
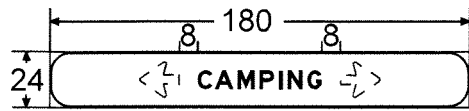

RAMP SUPPLEMENTAL SERVICE SIGNS ONLY USED FOR THE FOLLOWING SERVICES. GAS, FOOD, LODGING, AND CAMPING

Various Routes
INT ATTRACT SIGN 2014-09
Various Counties
Sheet 14 of 17
Contract Number 46270

MILEAGE PLATE HOLE SPACING DETAIL

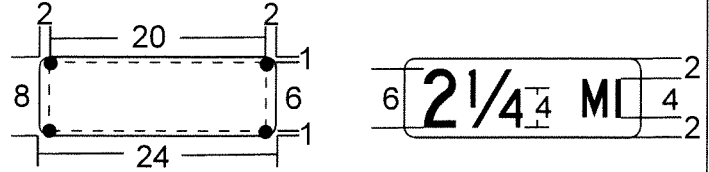

RAMP SUPPLEMENTAL SERVICE SIGN NOTES:

1. To be placed beneath Logo Service Signs where indicated.
2. Same general notes and legend sizes apply here as to other ramp Logo Service Signs.

MILEAGE PLATE NOTES:

1. Holes must be 3/16" (0.1875 in. dia.).
2. All legends are C series.
3. All legends are centered.
4. All dimensions are shown in inches.
5. Legend is white.
6. Background is Blue.

RAMP SIGN WORD SPACING

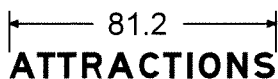
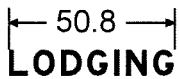
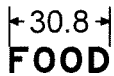

RAMP SERVICE PLATE HOLE SPACING DETAILS (PLATES FURNISHED BY OTHERS)

Hole spacing for 24" wide by 18" high GAS, FOOD, LODGING, CAMPING, ATTRACTIONS, or 24-HR PHARMACY logos.

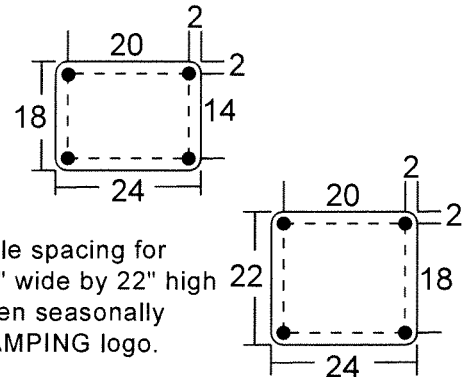

Hole spacing for 24" wide by 22" high open seasonally CAMPING logo.

RAMP SERVICE PLATE NOTES:

1. Holes must be 3/16" (0.1875 in. dia.).
2. All Ramp Service Plate corners have a 2 inch radius.

ARROW HOLE SPACING DETAILS:



RAMP SERVICE PLATE NOTES:

1. Holes must be 3/16" (0.1875 in. dia.).
2. All Ramp Service Plate corners have a 2 inch radius.

GENERAL NOTES FOR RAMP SIGNS:

1. All legends are 8 inch E Modified.
2. All borders are 1 inches wide.
3. All corners have a 9 inch radius.
4. Background is Blue.
5. Legend and border is white.
6. All dimensions are shown in inches.
7. Multiple services on a single panel shall be listed by priority, from left to right or top to bottom. Priority order is GAS, FOOD, LODGING, CAMPING, ATTRACTIONS, 24-HOUR PHARMACY.

LOGO SERVICE SIGN DETAILS

RAMP SIGN SPECIFICATIONS

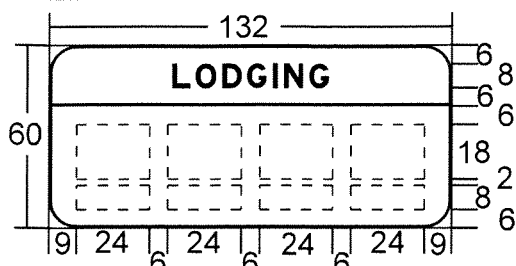

GAS, FOOD, LODGING, CAMPING, ATTRACTIONS, 24-HOUR PHARMACY

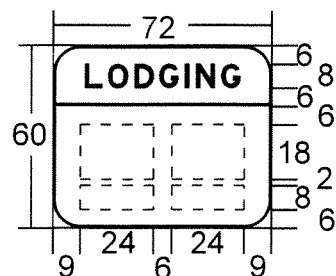

GAS, FOOD, LODGING, CAMPING

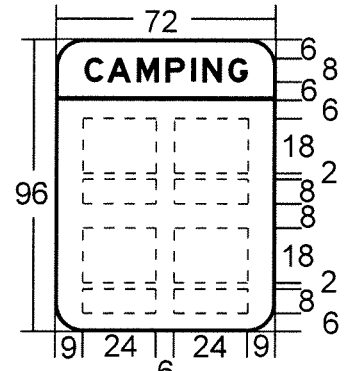

GAS, FOOD, LODGING, CAMPING

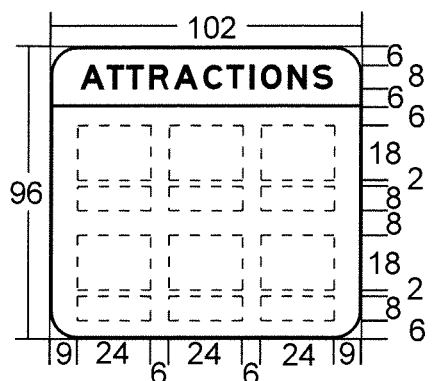

GAS, FOOD, LODGING, CAMPING, ATTRACTIONS

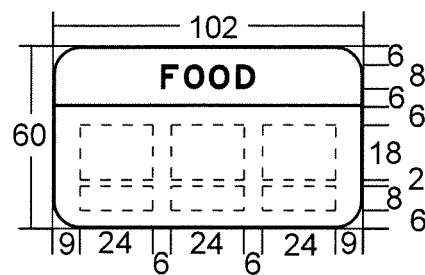

GAS, FOOD, LODGING, CAMPING, ATTRACTIONS

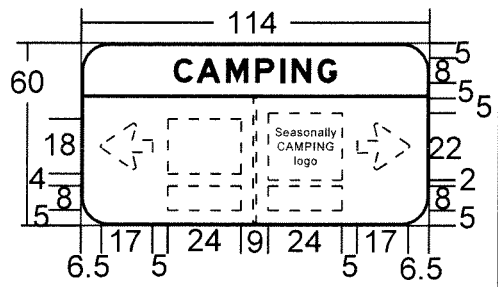

CAMPING

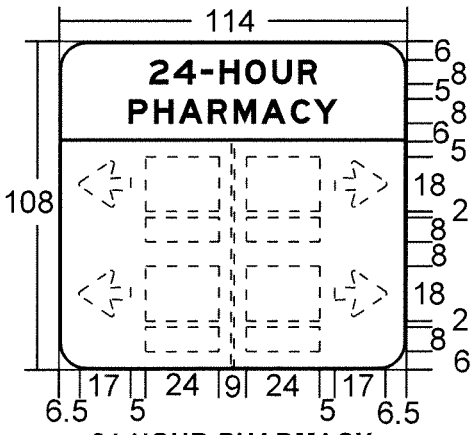

24-HOUR PHARMACY

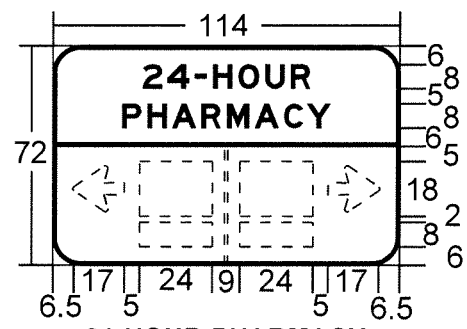



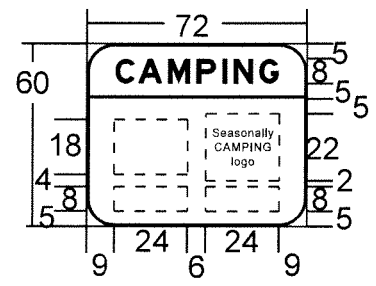

24-HOUR PHARMACY



CAMPING

GENERAL NOTES FOR RAMP SIGNS:

1. All legends are 8 inch E Modified.
2. All borders and vertical bars are 1 inch wide.
3. All corners have a 9 inch radius.
4. Background is Blue.
5. Legend and border is white.
6. All dimensions are shown in inches.
7. Multiple services on a single panel shall be listed by priority, from left to right or top to bottom. Priority order is GAS, FOOD, LODGING, CAMPING, ATTRACTIONS, 24-HOUR PHARMACY.



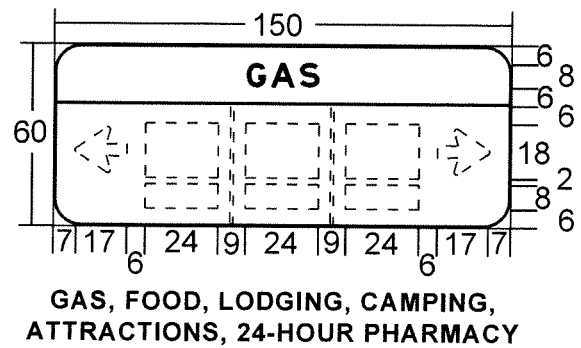
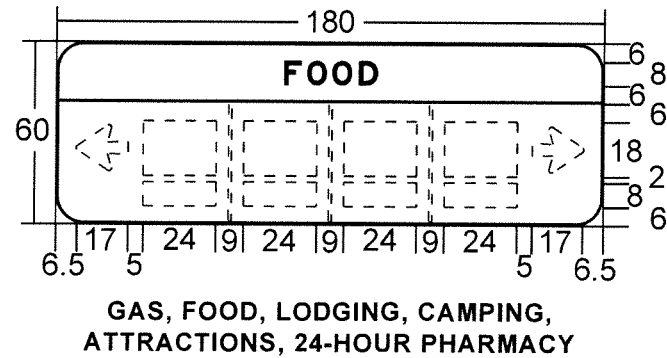
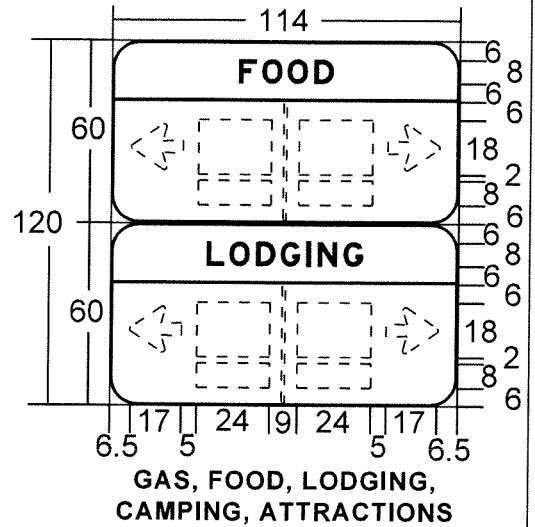
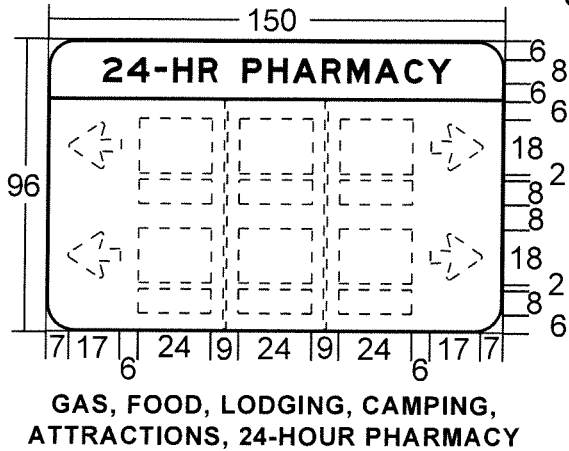
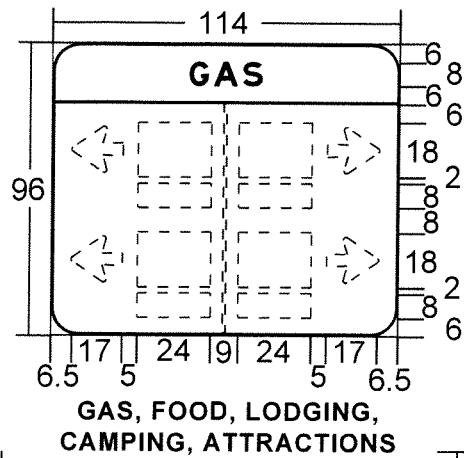
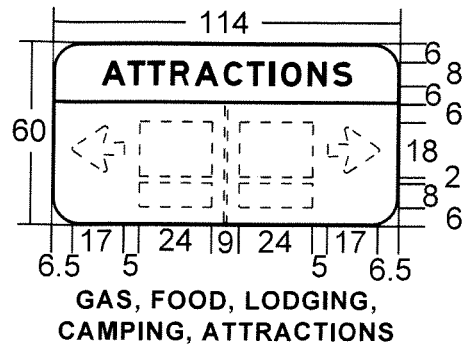

-  POSSIBLE VERTICAL BAR LOCATIONS
-  POSSIBLE RAMP SERVICE PLATE LOCATIONS
-  POSSIBLE RAMP MILEAGE PLATE LOCATIONS
-  POSSIBLE ARROW LOCATIONS

LOGO SERVICE SIGN DETAILS



GENERAL NOTES FOR RAMP SIGNS:

1. All legends are 8 inch E Modified.
2. All borders and vertical bars are 1 inch wide.
3. All corners have a 9 inch radius.
4. Background is Blue.
5. Legend and border is white.
6. All dimensions are shown in inches.
7. Multiple services on a single panel shall be listed by priority, from left to right or top to bottom. Priority order is GAS, FOOD, LODGING, CAMPING, ATTRACTIONS, 24-HOUR PHARMACY.

-  POSSIBLE VERTICAL BAR LOCATIONS
-  POSSIBLE RAMP SERVICE PLATE LOCATIONS
-  POSSIBLE RAMP MILEAGE PLATE LOCATIONS
-  POSSIBLE ARROW LOCATIONS

LOGO SERVICE SIGN DETAILS

**STATE OF ILLINOIS
 DEPARTMENT OF TRANSPORTATION**

**RAMP SIGN
 EXAMPLES**

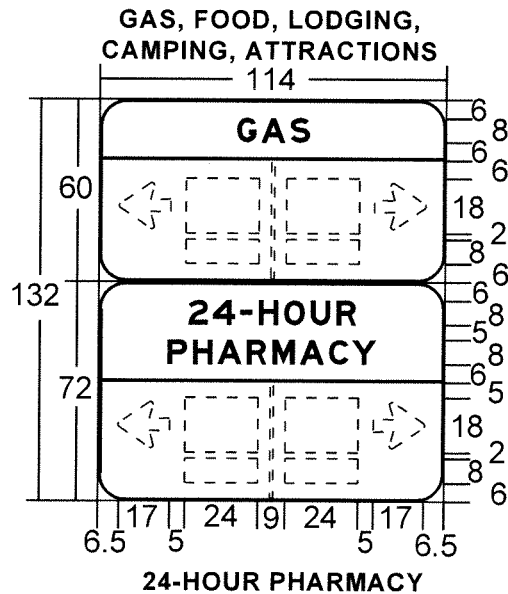
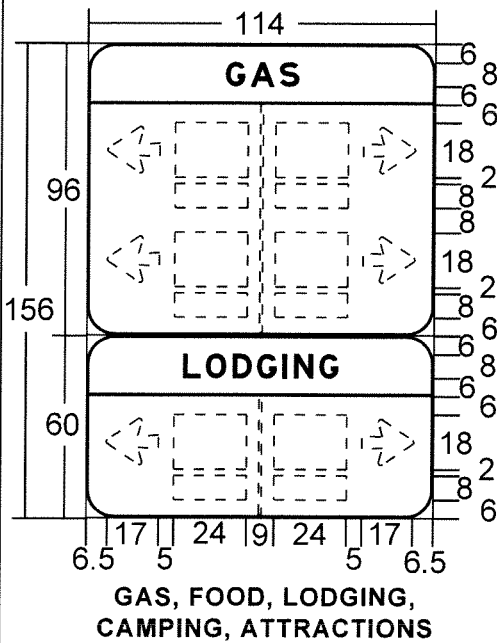
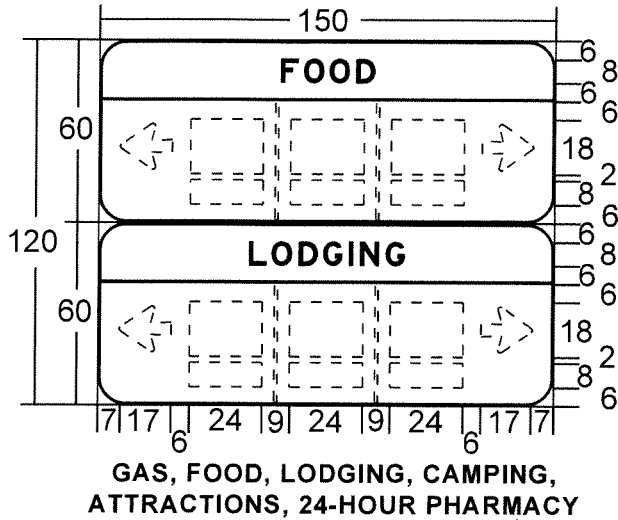
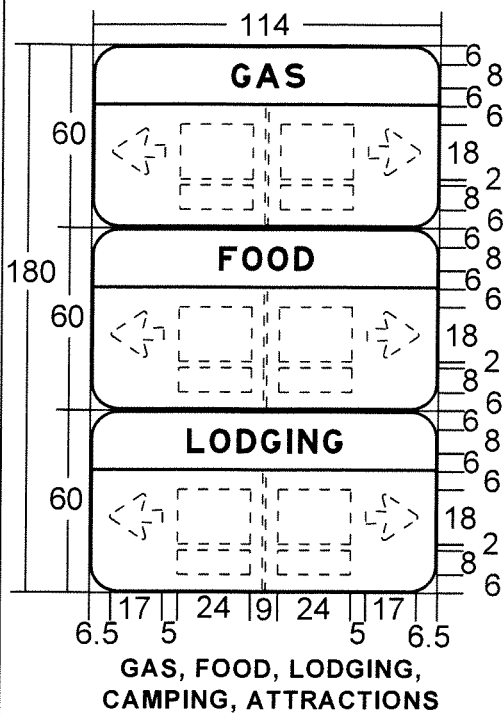

GENERAL NOTES FOR RAMP SIGNS:

1. All legends are 8 inch E Modified.
2. All borders and vertical bars are 1 inch wide.
3. All corners have a 9 inch radius.
4. Background is Blue.
5. Legend and border is white.
6. All dimensions are shown in inches.
7. Multiple services on a single panel shall be listed by priority, from left to right or top to bottom. Priority order is GAS, FOOD, LODGING, CAMPING, ATTRACTIONS, 24-HOUR PHARMACY.

- POSSIBLE VERTICAL BAR LOCATIONS
- POSSIBLE RAMP SERVICE PLATE LOCATIONS
- POSSIBLE RAMP MILEAGE PLATE LOCATIONS
- POSSIBLE ARROW LOCATIONS

LOGO SERVICE SIGN DETAILS

**STATE OF ILLINOIS
DEPARTMENT OF TRANSPORTATION**

**RAMP SIGN
EXAMPLES**

ILLINOIS DEPARTMENT OF LABOR

PREVAILING WAGES FOR J5 F-CI G COUNT-9G EFFECTIVE MAY 2013

The Prevailing rates of wages are included in the Contract proposals which are subject to Check Sheet #5 of the Supplemental Specifications and Recurring Special Provisions. The rates have been ascertained and certified by the Illinois Department of Labor for the locality in which the work is to be performed and for each craft or type of work or mechanic needed to execute the work of the Contract. As required by Prevailing Wage Act (820 ILCS 130/0.01, et seq.) and Check Sheet #5 of the Contract, not less than the rates of wages ascertained by the Illinois Department of Labor and as revised during the performance of a Contract shall be paid to all laborers, workers and mechanics performing work under the Contract. Post the scale of wages in a prominent and easily accessible place at the site of work.

If the Illinois Department of Labor revises the prevailing rates of wages to be paid as listed in the specification of rates, the contractor shall post the revised rates of wages and shall pay not less than the revised rates of wages. Current wage rate information shall be obtained by visiting the Illinois Department of Labor web site at <http://www.state.il.us/agency/idol/> or by calling 312-793-2814. It is the responsibility of the contractor to review the rates applicable to the work of the contract at regular intervals in order to insure the timely payment of current rates. Provision of this information to the contractor by means of the Illinois Department of Labor web site satisfies the notification of revisions by the Department to the contractor pursuant to the Act, and the contractor agrees that no additional notice is required. The contractor shall notify each of its subcontractors of the revised rates of wages.

Adams County Prevailing Wage for May 2013

(See explanation of column headings at bottom of wages)

Trade Name	RG	TYP	C	Base	FRMAN	M-F>8	OSA	OSH	H/W	Pensn	Vac	Trng
=====	==	===	=	=====	=====	=====	===	===	=====	=====	=====	=====
ASBESTOS ABT-GEN		BLD		21.510	22.260	1.5	1.5	2.0	7.550	10.63	0.000	0.800
ASBESTOS ABT-MEC		BLD		29.860	30.860	1.5	1.5	2.0	6.950	3.000	0.000	0.000
BOILERMAKER		BLD		31.500	34.000	1.5	1.5	2.0	7.070	18.73	1.000	0.350
BRICK MASON		BLD		29.250	30.250	1.5	1.5	2.0	8.200	8.330	0.000	0.580
CARPENTER		BLD		28.640	30.890	1.5	1.5	2.0	7.450	13.61	0.000	0.520
CARPENTER		HWY		28.990	30.740	1.5	1.5	2.0	7.450	13.61	0.000	0.520
CEMENT MASON		BLD		25.200	26.700	1.5	1.5	2.0	6.600	12.10	0.000	0.500
CEMENT MASON		HWY		24.850	25.850	1.5	1.5	2.0	6.600	11.85	0.000	0.500
CERAMIC TILE FNSHER		BLD		25.600	0.000	1.5	1.5	2.0	8.200	7.230	0.000	0.000
ELECTRIC PWR EQMT OP		ALL		35.440	0.000	1.5	1.5	2.0	5.000	10.98	0.000	0.270
ELECTRIC PWR GRNDMAN		ALL		24.320	0.000	1.5	1.5	2.0	5.000	7.540	0.000	0.180
ELECTRIC PWR LINEMAN		ALL		39.370	41.910	1.5	1.5	2.0	5.000	12.20	0.000	0.300
ELECTRIC PWR TRK DRV		ALL		25.510	0.000	1.5	1.5	2.0	5.000	7.920	0.000	0.190
ELECTRICIAN		BLD		28.360	30.860	1.5	1.5	2.0	5.350	8.550	0.000	0.400
ELECTRONIC SYS TECH		BLD		27.430	29.180	1.5	1.5	2.0	5.350	9.320	0.000	0.400
ELEVATOR CONSTRUCTOR		BLD		40.520	45.585	2.0	2.0	2.0	11.88	12.71	3.240	0.600
GLAZIER		BLD		30.780	32.780	1.5	2.0	2.0	6.630	8.150	0.000	0.380
HT/FROST INSULATOR		BLD		37.260	38.260	1.5	1.5	2.0	7.850	11.16	0.000	0.500
IRON WORKER		ALL		24.440	25.690	1.5	1.5	2.0	7.010	9.890	0.000	0.570
LABORER		BLD		20.010	20.760	1.5	1.5	2.0	7.550	10.63	0.000	0.800
LABORER		HWY		24.000	25.000	1.5	1.5	2.0	7.550	11.54	0.000	0.800
LATHER		BLD		28.640	30.890	1.5	1.5	2.0	7.450	13.61	0.000	0.520
MACHINIST		BLD		43.550	46.050	1.5	1.5	2.0	6.130	8.950	1.850	0.000
MARBLE FINISHERS		BLD		25.600	0.000	1.5	1.5	2.0	8.200	7.230	0.000	0.000
MARBLE MASON		BLD		27.100	27.850	1.5	1.5	2.0	8.200	7.230	0.000	0.000
MILLWRIGHT		BLD		29.620	31.870	1.5	1.5	2.0	7.450	13.09	0.000	0.520
MILLWRIGHT		HWY		31.690	33.440	1.5	1.5	2.0	7.450	13.54	0.000	0.520
OPERATING ENGINEER		BLD	1	33.900	35.400	1.5	1.5	2.0	10.05	7.600	0.000	1.300
OPERATING ENGINEER		BLD	2	31.550	35.400	1.5	1.5	2.0	10.05	7.600	0.000	1.300
OPERATING ENGINEER		BLD	3	27.950	35.400	1.5	1.5	2.0	10.05	7.600	0.000	1.300
OPERATING ENGINEER		BLD	4	35.400	35.400	1.5	1.5	2.0	10.05	7.600	0.000	1.300
OPERATING ENGINEER		HWY	1	37.600	39.100	1.5	1.5	2.0	10.05	8.100	0.000	1.300
OPERATING ENGINEER		HWY	2	33.660	39.100	1.5	1.5	2.0	10.05	8.100	0.000	1.300
OPERATING ENGINEER		HWY	3	27.630	39.100	1.5	1.5	2.0	10.05	8.100	0.000	1.300
OPERATING ENGINEER		HWY	4	39.100	39.100	1.5	1.5	2.0	10.05	8.100	0.000	1.300
PAINTER		ALL		28.580	30.080	1.5	1.5	2.0	5.000	8.580	0.000	0.550
PAINTER OVER 30FT		ALL		29.580	31.080	1.5	1.5	2.0	5.000	8.580	0.000	0.550
PAINTER PWR EQMT		ALL		29.580	31.080	1.5	1.5	2.0	5.000	8.580	0.000	0.550
PILEDRIVER		BLD		29.140	31.390	1.5	1.5	2.0	7.450	13.61	0.000	0.520
PILEDRIVER		HWY		29.990	31.740	1.5	1.5	2.0	7.450	13.61	0.000	0.520
PIPEFITTER		ALL		36.550	40.210	1.5	1.5	2.0	5.650	12.15	0.000	1.000
PLASTERER		BLD		28.500	30.250	1.5	1.5	2.0	7.330	11.29	0.000	0.500
PLUMBER		ALL		36.550	40.210	1.5	1.5	2.0	5.650	12.15	0.000	1.000
ROOFER		BLD		28.580	30.010	1.5	1.5	2.0	8.450	7.220	0.000	0.250
SHEETMETAL WORKER		BLD		26.150	27.950	1.5	1.5	2.0	7.140	9.340	0.000	0.540
SPRINKLER FITTER		BLD		36.390	39.140	1.5	1.5	2.0	8.420	8.500	0.000	0.450
STONE MASON		BLD		29.250	30.250	1.5	1.5	2.0	8.200	8.330	0.000	0.580
TERRAZZO FINISHER		BLD		25.600	0.000	1.5	1.5	2.0	8.200	7.230	0.000	0.000
TERRAZZO MASON		BLD		27.100	27.850	1.5	1.5	2.0	8.200	7.230	0.000	0.000
TILE LAYER		BLD		29.100	31.350	1.5	1.5	2.0	7.350	12.50	0.000	0.420
TILE MASON		BLD		27.100	27.850	1.5	1.5	2.0	8.200	7.230	0.000	0.000
TRUCK DRIVER		ALL	1	31.340	0.000	1.5	1.5	2.0	10.30	5.010	0.000	0.250
TRUCK DRIVER		ALL	2	31.780	0.000	1.5	1.5	2.0	10.30	5.010	0.000	0.250
TRUCK DRIVER		ALL	3	32.020	0.000	1.5	1.5	2.0	10.30	5.010	0.000	0.250
TRUCK DRIVER		ALL	4	32.280	0.000	1.5	1.5	2.0	10.30	5.010	0.000	0.250
TRUCK DRIVER		ALL	5	33.130	0.000	1.5	1.5	2.0	10.30	5.010	0.000	0.250
TRUCK DRIVER		O&C	1	25.070	0.000	1.5	1.5	2.0	10.30	5.010	0.000	0.250
TRUCK DRIVER		O&C	2	25.420	0.000	1.5	1.5	2.0	10.30	5.010	0.000	0.250
TRUCK DRIVER		O&C	3	25.620	0.000	1.5	1.5	2.0	10.30	5.010	0.000	0.250

TRUCK DRIVER	O&C 4	25.820	0.000	1.5	1.5	2.0	10.30	5.010	0.000	0.250
TRUCK DRIVER	O&C 5	26.500	0.000	1.5	1.5	2.0	10.30	5.010	0.000	0.250
TUCKPOINTER	BLD	29.250	30.250	1.5	1.5	2.0	8.200	8.330	0.000	0.580

Legend :

RG (Region)

TYP (Trade Type - All,Highway,Building,Floating,Oil & Chip,Rivers)

C (Class)

Base (Base Wage Rate)

FRMAN (Foreman Rate)

M-F>8 (OT required for any hour greater than 8 worked each day, Mon through Fri.)

OSA (Overtime (OT) is required for every hour worked on Saturday)

OSH (Overtime is required for every hour worked on Sunday and Holidays)

H/W (Health & Welfare Insurance)

Pensn (Pension)

Vac (Vacation)

Trng (Training)

Explanations

The following list is considered as those days for which holiday rates of wages for work performed apply: New Years Day, Memorial Day, Fourth of July, Labor Day, Thanksgiving Day, Christmas Day and Veterans Day in some classifications/counties. Generally, any of these holidays which fall on a Sunday is celebrated on the following Monday. This then makes work performed on that Monday payable at the appropriate overtime rate for holiday pay. Common practice in a given local may alter certain days of celebration. If in doubt, please check with IDOL.

Oil and chip resealing (O&C) means the application of road oils and liquid asphalt to coat an existing road surface, followed by application of aggregate chips or gravel to coated surface, and subsequent rolling of material to seal the surface.

EXPLANATION OF CLASSES

ASBESTOS - GENERAL - removal of asbestos material/mold and hazardous materials from any place in a building, including mechanical systems where those mechanical systems are to be removed. This includes the removal of asbestos materials/mold and hazardous materials from ductwork or pipes in a building when the building is to be demolished at the time or at some close future date.

ASBESTOS - MECHANICAL - removal of asbestos material from mechanical systems, such as pipes, ducts, and boilers, where the mechanical systems are to remain.

CERAMIC TILE FINISHER, MARBLE FINISHER, TERRAZZO FINISHER

Assisting, helping or supporting the tile, marble and terrazzo mechanic by performing their historic and traditional work assignments required to complete the proper installation of the work covered by said crafts. The term "Ceramic" is used for naming the classification only and is in no way a limitation of the product handled. Ceramic takes into consideration most hard tiles.

ELECTRONIC SYSTEMS TECHNICIAN

Installation, service and maintenance of low-voltage systems which utilizes the transmission and/or transference of voice, sound, vision, or digital for commercial, education, security and entertainment purposes for the following: TV monitoring and surveillance, background/foreground music, intercom and telephone interconnect, field programming, inventory control systems, microwave transmission, multi-media, multiplex, radio page, school, intercom and sound burglar alarms and low voltage master clock systems.

Excluded from this classification are energy management systems, life safety systems, supervisory controls and data acquisition systems not intrinsic with the above listed systems, fire alarm systems, nurse call systems and raceways exceeding fifteen feet in length

TRUCK DRIVER - BUILDING, HEAVY AND HIGHWAY CONSTRUCTION

Class 1. Drivers on 2 axle trucks hauling less than 9 ton. Air compressor and welding machines and brooms, including those pulled by separate units, truck driver helpers, warehouse employees, mechanic helpers, greasers and tiremen, pickup trucks when hauling materials, tools, or workers to and from and on-the-job site, and fork lifts up to 6,000 lb. capacity.

Class 2. Two or three axle trucks hauling more than 9 ton but hauling less than 16 ton. A-frame winch trucks, hydrolift trucks, vector trucks or similar equipment when used for transportation purposes. Fork lifts over 6,000 lb. capacity, winch trucks, four axle combination units, and ticket writers.

Class 3. Two, three or four axle trucks hauling 16 ton or more. Drivers on water pulls, articulated dump trucks, mechanics and working forepersons, and dispatchers. Five axle or more combination units.

Class 4. Low Boy and Oil Distributors.

Class 5. Drivers who require special protective clothing while employed on hazardous waste work.

TRUCK DRIVER - OIL AND CHIP RESEALING ONLY.

This shall encompass laborers, workers and mechanics who drive contractor or subcontractor owned, leased, or hired pickup, dump, service, or oil distributor trucks. The work includes transporting materials and equipment (including but not limited to, oils, aggregate supplies, parts, machinery and tools) to or from the job site; distributing oil or liquid asphalt and aggregate; stock piling material when in connection with the actual oil and chip contract. The Truck Driver (Oil & Chip Resealing) wage classification does not include supplier delivered materials.

OPERATING ENGINEERS - BUILDING

CLASS 1. Asphalt Screed Man; Aspco Concrete Spreaders; Asphalt

Pavers; Asphalt Plant Engineer; Asphalt Rollers on Bituminous Concrete; Athey Loaders; Backfillers, Crane Type; Backhoes; Barber Green Loaders; Bulldozers; Cableways; Cherry Pickers; Clam Shells; C.M.I. & similar type autograde formless paver, autograde placer & finisher; Concrete Breakers; Concrete Pumps; Derricks; Derrick Boats; Draglines; Earth Auger or Boring Machines; Elevating Graders; Engineers on Dredges; Gravel Processing Machines; Head Equipment Greaser; High Lifts or Fork Lifts; Hoists with two or more drums or two or more load lines; Locomotives, All; Mechanics; Motor Graders or Auto Patrols; Operators or Leverman on Dredges; Operators, Power Boat; Operators, Pug Mill (Asphalt Plants); Orange Peels; Overhead Cranes; Paving Mixers; Piledrivers; Pipe Wrapping and Painting Machines; Pushdozers, or Push Cats; Robotic Controlled Equipment in this Classification; Rock Crushers; Ross Carrier or Similar Machines; Rotomill; Scoops, Skimmer, two cu. yd. capacity and under; Scoops, All or Tournapull; Sheep-Foot Roller (Self Propelled); Shovels; Skid Steer; Skimmer Scoops; Temporary Concrete Plant Operators; Test Hole Drilling Machines; Tower Machines; Tower Mixers; Track Type End Loaders; Track Type Fork Lifts or High Lifts; Track Jacks and Tampers; Tractors, Sideboom; Trenching or Ditching Machine; Tunnelluggers; Vermeer Type Saws; Water Blaster Cutting Head; Wheel Type End Loaders; Winch Cat.

CLASS 2. Air Compressors (six to eight)*; Asphalt Boosters and Heaters; Asphalt Distributors; Asphalt Plant Fireman; Oiler on Two Paving Mixers When Used in Tandem; Boom or Winch Trucks; Bull Floats or Flexplanes; Concrete Finishing Machine; Concrete Saws, Self-Propelled; Concrete Spreading Machines; Conveyors (six to eight)*; Generators (six to eight)*; Gravel or Stone Spreader, Power Operated; Hoist (with One Drum and One Load Line); Light Plants (six to eight)*; Mechanical Heaters (six to eight)*; Mud Jacks; Post Hole Digger, Mechanical; Pug Mills when used for other than Asphalt operation; Robotic Controlled Equipment in this Classification; Road or Street Sweeper, Self Propelled; Rollers (except bituminous concrete); Seaman Tiller; Straw Machine; Vibratory Compactor; Water Blaster, Power Unit; Welding Machines (six to eight)*; Well Drill Machines.

CLASS 3. Air Compressors(one to five)*; Air Compressors, Track or Self-Propelled; Automatic Hoist; Building Elevators; Bulk Cement Batching Plants; Conveyors (one to five)*; Concrete Mixers (Except Plant, Paver, or Tower); Firemen; Generators (one to five)*; Greasers; Helper on Single Paving Mixer; Hoist, Automatic; Light Plants (one to five)*; Mechanic Helpers; Mechanical Heaters (one to five)*; Oilers; Power Form Graders; Power Sub-Graders; Robotic Controlled Equipment in this Classification; Scissors Hoist; Tractors without power attachments regardless of size or type; Truck Crane Oiler and Driver (1 man); Vibratory Hammer (power source); Water Pumps (one to five)*; Welding Machines (1/300 Amp. or over)*; Welding machines (one to five)*

CLASS 4. Lattice Boom Crawler Cranes; Lattice Boom Truck Cranes; Telescopic Truck-Mounted Cranes; Tower Cranes.

* Combinations of one to eight of any Air Compressors, Conveyors, Welding Machines, Water Pumps, Light Plants, or Generators shall be in batteries or within 400 feet and shall be paid as per the Classification Schedule contained in this Article.

OPERATING ENGINEERS - HIGHWAY

CLASS 1. Asphalt Screed Man; Asphco Concrete Spreaders; Asphalt Pavers; Asphalt Plant Engineer; Asphalt Rollers on Bituminous Concrete; Athey Loaders; Backhoes; Barber Green Loaders; Bulldozers; Cableways; Carry Deck Pickers; Cherry Pickers (Rough Terrain); C.M.I.

& similar type-autograde formless paver, autograde placer & finisher; Concrete Breakers; Concrete Plant Operators; Concrete Pumps; Derricks; Derrick Boats; Dewatering Systems; Earth Auger or Boring Machines; Elevating Graders; Engineers on Dredges; Gravel Processing Machines; Grout Pump; Head Equipment Greaser; High Lifts or Fork Lifts; Hoists with two or more drums or two or more load lines; Hydro Jet or Hydro Laser; Locomotives, All; Mechanics; Motor Graders or Auto Patrols; Multi-Point Power Lifting Equipment; Operators or Leverman on Dredges; Operators, Power Boat; Operators, Pug Mill (Asphalt Plants); Overhead Cranes; Paving Mixers; Piledrivers; Pipe Wrapping and Painting Machines; Push-dozers, or Push Cats; Robotic Controlled Equipment in this Classification; Rock Crushers; Ross Carrier or Similar Machines; Roto-Mill; Scoops, Skimmer, two cu. yd. capacity and under; Sheep-Foot Roller (Self Pro-pelled); Shovels; Skid Steer; Skimmer Scoops; Test Hole Drilling Machines; Tower Machines; Tower Mixers; Track Type End Loaders; Track Type Fork Lifts or High Lifts; Track Jacks and Tampers; Tractors, Side-boom; Trenching or Ditching Machine; Tunnelluggers; Vermeer-Type Saws; Wheel Type End Loaders; Winch Cat; Scoops, All or Tournapull.

CLASS 2. Air Compressors (six to eight)*; Articulated Dumps; Asphalt Boosters and Heaters; Asphalt Distributors; Asphalt Plant Fireman; Boom or Winch Trucks; Building Elevators; Bull Floats or Flexplanes; Concrete Finishing Machine; Concrete Saws, Self-Propelled; Concrete Spreading Machines; Conveyors (six to eight)*; Generators (six to eight)*; Gravel or Stone Spreader, Power Operated; Hoist, Automatic; Hoist with One Drum and One Load Line; Light Plants (six to eight)*; Mechanical Heaters (six to eight)*; Mud Jacks; Off Road Water Wagons; Oiler on Two Paving Mixers When Used in Tandem; Post Hole Digger, Mechanical; Robotic Controlled Equipment in This Classification; Road or Street Sweeper, Self-Propelled; Rollers (except bituminous concrete); Scissor Hoist; Sea-man Tiller; Straw Machine; Vibratory Compactor; Water Pumps (six to eight)*; Well Drill Machines.

CLASS 3. Air Compressors (one to five)*; Air Compressors, Track or Self-Propelled; Bulk Cement Batching Plants; Conveyors (one to five)*; Concrete Mixers (Except Plant, Paver, or Tower); Firemen; Generators (one to five)*; Greasers; Helper on Single Paving Mixer; Light Plants (one to five)*; Mechanic Helpers; Mechanical Heaters (one to five)*; Oilers; Power Form Graders; Power Sub-Graders; Pug Mills when used for other than Asphalt operation; Robotic Controlled Equipment in This Classification; Tractors without power attachments, regardless of size or type; Truck Crane Oiler and Driver (1 man); Vibratory Hammer (power source); Water Pumps (one to five)*; Welding Machines (one 300 Amp. or over)*; Welding Machines (one to five)*.

CLASS 4. Lattice Boom Crawler Crane; Lattice Boom Truck Crane; Telescopic Truck-Mounted Crane; Tower Crane.

*Combinations of one to eight of any Air Compressors, Conveyors, Welding Machines, Water Pumps, Light Plants or Generators shall be in batteries or within 400 feet and shall be paid as per the Classification Schedule contained in this Article.

Other Classifications of Work:

For definitions of classifications not otherwise set out, the Department generally has on file such definitions which are available. If a task to be performed is not subject to one of the classifications of pay set out, the Department will upon being contacted state which neighboring county has such a classification and provide such rate, such rate being deemed to exist by reference in this document. If no neighboring county rate applies to the task, the Department shall undertake a special determination, such special

determination being then deemed to have existed under this determination. If a project requires these, or any classification not listed, please contact IDOL at 217-782-1710 for wage rates or clarifications.

LANDSCAPING

Landscaping work falls under the existing classifications for laborer, operating engineer and truck driver. The work performed by landscape plantsman and landscape laborer is covered by the existing classification of laborer. The work performed by landscape operators (regardless of equipment used or its size) is covered by the classifications of operating engineer. The work performed by landscape truck drivers (regardless of size of truck driven) is covered by the classifications of truck driver.

Alexander County Prevailing Wage for May 2013

(See explanation of column headings at bottom of wages)

Trade Name	RG	TYP	C	Base	FRMAN	M-F>8	OSA	OSH	H/W	Pensn	Vac	Trng
=====	==	===	=	=====	=====	=====	===	===	=====	=====	=====	=====
ASBESTOS ABT-GEN		ALL		25.300	25.750	1.5	1.5	2.0	5.750	10.35	0.000	0.900
ASBESTOS ABT-MEC		BLD		29.860	30.860	1.5	1.5	2.0	6.950	3.000	0.000	0.000
BOILERMAKER		BLD		31.500	34.000	1.5	1.5	2.0	7.070	18.73	1.000	0.350
BRICK MASON		BLD		28.620	30.120	1.5	1.5	2.0	8.200	7.030	0.000	0.430
CARPENTER		BLD		31.890	33.390	1.5	1.5	2.0	6.550	6.750	0.000	0.400
CARPENTER		HWY		31.840	33.340	1.5	1.5	2.0	6.550	6.750	0.000	0.400
CEMENT MASON		BLD		28.200	29.700	1.5	1.5	2.0	6.600	5.400	0.000	0.500
CEMENT MASON		HWY		27.290	28.290	1.5	1.5	2.0	6.600	5.160	0.000	0.400
CERAMIC TILE FNSHER		BLD		27.120	0.000	1.5	1.5	2.0	8.200	7.030	0.000	0.430
ELECTRIC PWR EQMT OP		ALL	1	35.570	0.000	1.5	1.5	2.0	5.000	9.960	0.000	0.360
ELECTRIC PWR EQMT OP		ALL	2	31.740	0.000	1.5	1.5	2.0	5.000	8.880	0.000	0.320
ELECTRIC PWR GRNDMAN		ALL		26.100	0.000	1.5	1.5	2.0	5.000	7.310	0.000	0.260
ELECTRIC PWR LINEMAN		ALL		44.630	47.650	1.5	1.5	2.0	5.000	12.50	0.000	0.450
ELECTRICIAN		ALL		39.350	41.600	1.5	1.5	2.0	6.140	9.440	0.000	0.790
ELECTRONIC SYS TECH		BLD		32.570	34.320	1.5	1.5	2.0	6.000	4.240	0.000	0.400
FLOOR LAYER		BLD		29.330	30.080	1.5	1.5	2.0	6.550	6.750	0.000	0.400
GLAZIER		BLD		26.780	28.030	1.5	1.5	2.0	6.120	5.200	0.000	0.300
HT/FROST INSULATOR		BLD		37.260	38.260	1.5	1.5	2.0	7.850	11.16	0.000	0.500
IRON WORKER		ALL		27.730	29.730	1.5	1.5	2.0	7.010	11.41	0.000	0.500
LABORER		BLD		25.300	25.750	1.5	1.5	2.0	5.750	10.35	0.000	0.800
LABORER		HWY		25.300	25.750	1.5	1.5	2.0	5.750	10.35	0.000	0.800
LABORER		O&C		17.740	18.190	1.5	1.5	2.0	5.450	8.450	0.000	0.800
MACHINIST		BLD		43.550	46.050	1.5	1.5	2.0	6.130	8.950	1.850	0.000
MARBLE FINISHERS		BLD		27.120	0.000	1.5	1.5	2.0	8.200	7.030	0.000	0.430
MARBLE MASON		BLD		28.620	30.120	1.5	1.5	2.0	8.200	7.030	0.000	0.430
MILLWRIGHT		BLD		31.890	33.390	1.5	1.5	2.0	6.550	6.750	0.000	0.400
MILLWRIGHT		HWY		31.840	33.340	1.5	1.5	2.0	6.550	6.750	0.000	0.400
OE RIVER 1		RIV	1	33.550	34.550	1.5	1.5	2.0	7.000	8.800	0.000	1.450
OE RIVER 2		RIV	2	30.100	34.550	1.5	1.5	2.0	7.000	8.800	0.000	1.450
OPERATING ENGINEER		ALL	1	33.450	34.450	1.5	1.5	2.0	7.000	8.800	0.000	1.450
OPERATING ENGINEER		ALL	2	31.550	34.450	1.5	1.5	2.0	7.000	8.800	0.000	1.450
OPERATING ENGINEER		ALL	3	24.150	34.450	1.5	1.5	2.0	7.000	8.800	0.000	1.450

OPERATING ENGINEER	ALL	4	21.400	27.800	1.5	1.5	2.0	5.650	6.100	0.000	1.100
OPERATING ENGINEER	O&C	1	25.090	26.090	1.5	1.5	2.0	7.000	8.800	0.000	1.450
OPERATING ENGINEER	O&C	2	23.660	26.090	1.5	1.5	2.0	7.000	8.800	0.000	1.450
OPERATING ENGINEER	O&C	3	18.120	26.090	1.5	1.5	2.0	7.000	8.800	0.000	1.450
OPERATING ENGINEER	O&C	4	16.050	21.100	1.5	1.5	2.0	5.700	6.100	0.000	1.100
PAINTER	BLD		26.260	27.760	1.5	1.5	2.0	6.630	7.070	0.000	0.500
PAINTER	HWY		30.560	32.060	1.5	1.5	2.0	6.630	7.070	0.000	0.500
PAINTER OVER 30FT	BLD		27.260	28.760	1.5	1.5	2.0	6.630	7.070	0.000	0.500
PAINTER PWR EQMT	BLD		27.260	28.760	1.5	1.5	2.0	6.630	7.070	0.000	0.500
PAINTER PWR EQMT	HWY		31.560	33.060	1.5	1.5	2.0	6.630	7.070	0.000	0.500
PILEDRIVER	BLD		31.890	33.390	1.5	1.5	2.0	6.550	6.750	0.000	0.400
PILEDRIVER	HWY		31.840	33.340	1.5	1.5	2.0	6.550	6.750	0.000	0.400
PIPEFITTER	BLD		41.470	45.620	1.5	2.0	2.0	8.450	5.780	0.000	1.250
PLASTERER	BLD		28.200	29.700	1.5	1.5	2.0	6.600	5.400	0.000	0.500
PLUMBER	BLD		41.470	45.620	1.5	2.0	2.0	8.450	5.780	0.000	1.250
ROOFER	BLD		23.900	24.900	1.5	1.5	2.0	8.650	3.800	0.000	0.000
SHEETMETAL WORKER	ALL		31.690	33.190	1.5	1.5	2.0	7.130	6.730	1.910	0.360
SPRINKLER FITTER	BLD		36.390	39.140	1.5	1.5	2.0	8.420	8.500	0.000	0.450
STONE MASON	BLD		28.620	30.120	1.5	1.5	2.0	8.200	7.030	0.000	0.430
TERRAZZO FINISHER	BLD		27.120	0.000	1.5	1.5	2.0	8.200	7.030	0.000	0.430
TERRAZZO MASON	BLD		28.620	30.120	1.5	1.5	2.0	8.200	7.030	0.000	0.430
TRUCK DRIVER	ALL	1	30.070	0.000	1.5	1.5	2.0	10.30	6.100	0.000	0.250
TRUCK DRIVER	ALL	2	30.520	0.000	1.5	1.5	2.0	10.30	6.100	0.000	0.250
TRUCK DRIVER	ALL	3	30.740	0.000	1.5	1.5	2.0	10.30	6.100	0.000	0.250
TRUCK DRIVER	ALL	4	31.030	0.000	1.5	1.5	2.0	10.30	6.100	0.000	0.250
TRUCK DRIVER	ALL	5	31.850	0.000	1.5	1.5	2.0	10.30	6.100	0.000	0.250
TRUCK DRIVER	O&C	1	22.750	0.000	1.5	1.5	2.0	2.920	6.700	0.000	0.250
TRUCK DRIVER	O&C	2	19.150	0.000	1.5	1.5	2.0	2.920	6.700	0.000	0.250
TRUCK DRIVER	O&C	3	19.650	0.000	1.5	1.5	2.0	2.920	6.700	0.000	0.250
TUCKPOINTER	BLD		28.620	30.120	1.5	1.5	2.0	8.200	7.030	0.000	0.430

Legend :

RG (Region)

TYP (Trade Type - All,Highway,Building,Floating,Oil & Chip,Rivers)

C (Class)

Base (Base Wage Rate)

FRMAN (Foreman Rate)

M-F>8 (OT required for any hour greater than 8 worked each day, Mon through Fri.

OSA (Overtime (OT) is required for every hour worked on Saturday)

OSH (Overtime is required for every hour worked on Sunday and Holidays)

H/W (Health & Welfare Insurance)

Pensn (Pension)

Vac (Vacation)

Trng (Training)

Explanations

The following list is considered as those days for which holiday rates of wages for work performed apply: New Years Day, Memorial Day, Fourth of July, Labor Day, Thanksgiving Day, Christmas Day and Veterans Day in some classifications/counties. Generally, any of these holidays which fall on a Sunday is celebrated on the following Monday. This then makes work performed on that Monday payable at the appropriate overtime rate for holiday pay. Common practice in a given local may alter certain days of celebration. If in doubt, please check with IDOL.

Oil and chip resealing (O&C) means the application of road oils and liquid asphalt to coat an existing road surface, followed by application of aggregate chips or gravel to coated surface, and subsequent rolling of material to seal the surface.

EXPLANATION OF CLASSES

ASBESTOS - GENERAL - removal of asbestos material/mold and hazardous materials from any place in a building, including mechanical systems where those mechanical systems are to be removed. This includes the removal of asbestos materials/mold and hazardous materials from ductwork or pipes in a building when the building is to be demolished at the time or at some close future date.

ASBESTOS - MECHANICAL - removal of asbestos material from mechanical systems, such as pipes, ducts, and boilers, where the mechanical systems are to remain.

LABORER - OIL AND CHIP RESEALING ONLY

Hook and unhook chip box from aggregate truck; distribute material within chip box; perform flagging work related to oil and chip resealing; hand spray oil fluids; handle traffic control, including setting-up and maintaining barricades, drums, cones, delineators, signs and other such items, as well as laying-out and applying or removing temporary roadway markings used to control traffic in job site related to oil and chip resealing; and perform clean-up related to oil and chip resealing.

CERAMIC TILE FINISHER, MARBLE FINISHER, TERRAZZO FINISHER

Assisting, helping or supporting the tile, marble and terrazzo mechanic by performing their historic and traditional work assignments required to complete the proper installation of the work covered by said crafts. The term "Ceramic" is used for naming the classification only, and is in no a limitation of the product handled. Ceramic takes into consideration most hard tiles.

ELECTRIC POWER LINEMAN

Construction, maintenance and dismantling of overhead and underground electric power lines, including high voltage pipe type cable work, and associated structures and equipment.

ELECTRIC POWER EQUIPMENT OPERATOR - CLASS 1

Operation of all crawler type equipment D-4 and larger from the ground to assist the Electric Power Linemen in performing their duties.

ELECTRIC POWER EQUIPMENT OPERATORS - CLASS 2

Operation of all other equipment from the ground to assist the Electric Power Linemen in performing their duties.

ELECTRIC POWER GROUNDMAN

Applies to workers who assist the Electric Power Lineman from the ground.

ELECTRONIC SYSTEMS TECHNICIAN

Installation, service and maintenance of low-voltage systems which utilizes the transmission and/or transference of voice, sound, vision, or digital for commercial, education, security and entertainment purposes for the following: TV monitoring and surveillance, background/foreground music, intercom and telephone interconnect, field programming, inventory control systems, microwave transmission, multi-media, multiplex, radio page, school, intercom and sound burglar alarms and low voltage master clock systems.

Excluded from this classification are energy management systems, life safety systems, supervisory controls and data acquisition systems not intrinsic with the above listed systems, fire alarm systems, nurse call systems and raceways exceeding fifteen feet in length.

TRUCK DRIVER - BUILDING, HEAVY AND HIGHWAY CONSTRUCTION

Class 1. Drivers on 2 axle trucks hauling less than 9 ton. Air compressor and welding machines and brooms, including those pulled by separate units, truck driver helpers, warehouse employees, mechanic helpers, greasers and tiremen, pickup trucks when hauling materials, tools, or workers to and from and on-the-job site, and fork lifts up to 6,000 lb. capacity.

Class 2. Two or three axle trucks hauling more than 9 ton but hauling less than 16 ton. A-frame winch trucks, hydrolift trucks, vactor trucks or similar equipment when used for transportation purposes. Fork lifts over 6,000 lb. capacity, winch trucks, four axle combination units, and ticket writers.

Class 3. Two, three or four axle trucks hauling 16 ton or more. Drivers on water pulls, articulated dump trucks, mechanics and working forepersons, and dispatchers. Five axle or more combination units.

Class 4. Low Boy and Oil Distributors.

Class 5. Drivers who require special protective clothing while employed on hazardous waste work.

TRUCK DRIVER - O & C - (Oil and Chip Resealing ONLY)

It involves driving of contractor or subcontractor owned, leased, or hired pickup, dump, service, or oil distributor trucks. Includes transporting materials and equipment (including, but not limited to oils, aggregate supplies, parts, machinery and tools) to or from the job site; distributing oil or liquid asphalt and aggregate; stock piling material; and maintaining trucks at job site related to oil and chip resealing.

Class 1. Distributors, liquid asphalt hauling and hauling of asphalt rubber-tired rollers.

Class 2. Stockpiling.

Class 3. Tandem hauling to job site.

OPERATING ENGINEERS - BUILDING, HEAVY AND HIGHWAY CONSTRUCTION

Class 1. APSCO or Equal Spreading Machine, Backhoe, Backfiller, Boom

or Winch Cat, Bituminous Mixplane Machine, Blacksmith, Bituminous Surfacing Machine, Bull-Dozer, Crane, Shovel, Dragline, Truck Crane, Pile Driver, Concrete Breaker, Concrete or Pumpcrete Pumps, Dinky or Standard Locomotives, Well or Caisson Drills, Elevating Grader, Fork Lifts, Flexplane, Gradeall, Hi-Lift Hoists, Guy-Derricks, Hysters, Mechanic Motor Patrol, Mixers-21 cu. ft. or over, Push Cats, Pulls and Scrapers, Two Well Point Pumps, Pulverizer or Tiller, PugMill, Rubber-Tired Farm Type Tractor with Bulldozer/Blade/Auger or hi-lift over 1/2 yd., Jersey Spreader, Tract-Air used with Drill or Hi-Lift, Trenching or Ditching Machines, Wood Chipper w/Tractor, Self-Propelled Roller w/Blade, Equipment Greaser, Self-Propelled Bump Grinder on Concrete pavement, Boat Operator, Skid-Loaders, Tuggers, Lazer Screed, and Self-Propelled Chip Spreader (when others run conveyors).

Class 2. Any type tractor pulling any type roller or disc, Two Air Compressors (220 cu. ft. capacity or over), Two AirTract Drills, Air-Track Drill w/Compressor, Automatic Bins or Scales w/Compressor or Generator, Pipeline Boring Machine, Bulk Cement Plant w/Separate Compressor, Power Operated Bull Float, Hydra-Lift w/Single Motor, Straw Mulcher Blower w/Spout, Self-Propelled Roller/Compactor, Back-End man on Bituminous Surfacing Machine, oiler on milling machine.

Class 3. Air Compressor w/Valve driving piling, Boom or Winch Type Truck, Two Conveyors, Self-Propelled Concrete Saw, Form Grader, Truck Crane Oiler, Self-Propelled Vibrator, Rubber Tired Farm Type Tractor w/Blade/Bulldozer/Auger/hi-lift - 1/2 yd. or less, Elevator Operator, Man Lift (scissor lift) when lifting materials.

Class 4. Air-Track Drill (one), Belt Drag Machine, Power Broom, Mechanical Plasterer Applicator, Trac-Air, Air Compressor (220 cu. ft. or over) One, Air Compressor (under 220 cu. ft) four, Automatic Bin, Bulk Cement Plant w/Built-in Compressor running off same motor or electric motor, Fireman or Switchman, Self-Propelled Form Tamper, Light Plants (4), Welding Machines (4), Pumps (4), or Combination of four (4) Pumps, Light Plants, Welding Machines, Air-Compressors (under 220 cu. ft.), Mudjacks or Wood Chipper, Mixers - less than 21 cu. ft. Mortar Mixer w/Skip or Pump, Pipeline Tract Jack. One Operating Engineer may operate and maintain any combination of the following pieces of equipment, not to exceed four (4) which shall be within a reasonable distance, such combination may include any equipment in this classification: (Compressors, Light Plants, Generators, Welding Machines, Pumps or Conveyors), One Well- Point Pump, Two Motor Driven Heaters, One Air Compressor (under 220 cu. ft.), One Engine-Driven Conveyor, One Motor Driven Heater, One Light Plant, One Pump, One Welding Machine, One Ulmac or Equal Spreader, Oilers, and one Generator 10 kw or greater.

OPERATING ENGINEER - O & C (Oil and Chip Resealing ONLY). Includes the operation of all motorized heavy equipment used in oil and chip rsealing, including but not limited to operating self-propelled chip spreaders, and all types of rollers (both hard and rubber tired); and other duties pertaining to the operation or maintenance of heavy equipment related to oil and chip resealing.

Class 1. See Class 1 above for types of equipment operated.

Class 2. See Class 2 above for types of equipment operated.

Class 3. See Class 3 above for types of equipment operated.

Class 4. See Class 4 above for types of equipment operated.

OPERATING ENGINEER RIVER WORK 1 - operate the following machines when working on River Work and Levee Work on the Mississippi and Ohio

Rivers, Lakes and Tributaries: Crane, Shovel, Drageline, Scrapers, Dredge, Derrick, Pile-Driver, Push Boat, all power boat operators, Mechanic, Engineman on Dredge, Leverman on Dredge, All Bituminous Spreader machines, Backhoe, Backfiller, Boom, or Winch Cat, Bituminous Mixplane Machine, Blacksmith, Bituminous Surfacing Machine, Bulldozer, Truck Cranes, Hydraulic Truck Mounted Boom/Crane, Concrete Finishing Machine, or Spreader Machine, Concrete Breaker, Concrete or Pumpcrete Machines, Concrete Plant Operator, All Off Road Material Hauling Equipment, Dinky or Standard Locomotives, Well Drill, Elevating Grader, Fork-Lifts, Flexplane, Gradeall, Hi-Lift, Power Handblade Tugger type Hoist, Hoist Two Drum (or over one), Guyderrick, Hyster, Motor Patrol, Mixers - 21 Cu. Ft. or over, Push Cat, Pulls, & Scrapers, Pumps-Two Well Points, Equipment Greaser, P & H Pulverizer or Pulverizer equal to Pugmill, Pugmill, Rubber-Tired farm type tractor w/Bulldozer/Blade/Auger or Hi-Lift over ½ yard, Skimmer Scoops, Seaman Tiller, Jersey Spreader, Tract-Air used with Drill or Hi-Lift, Trenching or Ditching Machine, Wood Chipper w/Tractor, self-propelled roller w/Blade, Concrete Pumps and Small Equipment Operators.

OPERATING ENGINEER RIVER 2 - when working on River Work and Levee Work on the Mississippi and Ohio Rivers, Lakes and Tributaries shall be employed as the Oiler or Fireman on Crane, Dragline, Shovel, Dredge, Truck Crane, Pile Driver, Gradeall, Dinky or Standard Locomotive, Guy Derrick, Trenching Machine or Ditching Machine 80 H.P. and over, All Terrain (cherry-picker) with over 40 ton Lifting Capacity, Deck Oiler and Deckhands.

Other Classifications of Work:

For definitions of classifications not otherwise set out, the Department generally has on file such definitions which are available. If a task to be performed is not subject to one of the classifications of pay set out, the Department will upon being contacted state which neighboring county has such a classification and provide such rate, such rate being deemed to exist by reference in this document. If no neighboring county rate applies to the task, the Department shall undertake a special determination, such special determination being then deemed to have existed under this determination. If a project requires these, or any classification not listed, please contact IDOL at 217-782-1710 for wage rates or clarifications.

LANDSCAPING

Landscaping work falls under the existing classifications for laborer, operating engineer and truck driver. The work performed by landscape plantsman and landscape laborer is covered by the existing classification of laborer. The work performed by landscape operators (regardless of equipment used or its size) is covered by the classifications of operating engineer. The work performed by landscape truck drivers (regardless of size of truck driven) is covered by the classifications of truck driver.

Bond County Prevailing Wage for May 2013

(See explanation of column headings at bottom of wages)

Trade Name	RG	TYP	C	Base	FRMAN	M-F>8	OSA	OSH	H/W	Pensn	Vac	Trng
ASBESTOS ABT-GEN		ALL		26.360	26.860	1.5	1.5	2.0	5.750	14.34	0.000	0.800
ASBESTOS ABT-MEC		BLD		29.860	30.860	1.5	1.5	2.0	6.950	3.000	0.000	0.000

BOILERMAKER	BLD		31.500	34.000	1.5	1.5	2.0	7.070	18.73	1.000	0.350
BRICK MASON	BLD		29.280	33.160	1.5	1.5	2.0	7.750	9.430	2.000	0.400
CARPENTER	ALL		34.630	36.130	1.5	1.5	2.0	6.550	6.750	0.000	0.400
CEMENT MASON	ALL		31.000	32.000	1.5	1.5	2.0	9.250	11.75	0.000	0.200
CERAMIC TILE FNSHER	BLD		25.890	0.000	1.5	1.5	2.0	6.000	5.200	0.000	0.530
ELECTRIC PWR EQMT OP E	ALL	1	35.570	0.000	1.5	1.5	2.0	5.000	9.960	0.000	0.360
ELECTRIC PWR EQMT OP E	ALL	2	31.740	0.000	1.5	1.5	2.0	5.000	8.880	0.000	0.320
ELECTRIC PWR EQMT OP W	ALL		36.870	0.000	1.5	1.5	2.0	6.790	10.32	0.000	0.270
ELECTRIC PWR GRNDMAN E	ALL		26.100	0.000	1.5	1.5	2.0	5.000	7.310	0.000	0.260
ELECTRIC PWR GRNDMAN W	ALL		27.530	0.000	1.5	1.5	2.0	5.070	7.710	0.000	0.210
ELECTRIC PWR LINEMAN E	ALL		44.630	47.650	1.5	1.5	2.0	5.000	12.50	0.000	0.450
ELECTRIC PWR LINEMAN W	ALL		42.400	44.450	1.5	1.5	2.0	7.810	11.87	0.000	0.320
ELECTRIC PWR TRK DRV W	ALL		30.100	0.000	1.5	1.5	2.0	5.540	8.430	0.000	0.230
ELECTRICIAN	E	ALL	39.350	41.600	1.5	1.5	2.0	6.140	9.440	0.000	0.790
ELECTRICIAN	W	ALL	36.510	38.700	1.5	1.5	2.0	7.810	7.490	0.000	0.640
ELECTRONIC SYS TECH	E	BLD	32.570	34.320	1.5	1.5	2.0	6.000	4.240	0.000	0.400
ELECTRONIC SYS TECH	W	BLD	30.720	32.470	1.5	1.5	2.0	3.650	7.920	0.000	0.400
ELEVATOR CONSTRUCTOR	BLD		43.715	49.180	2.0	2.0	2.0	11.88	12.71	3.500	0.600
FLOOR LAYER	BLD		29.330	30.080	1.5	1.5	2.0	6.550	6.750	0.000	0.400
GLAZIER	BLD		32.780	0.000	2.0	2.0	2.0	9.020	10.80	2.630	0.310
HT/FROST INSULATOR	BLD		37.260	38.260	1.5	1.5	2.0	7.850	11.16	0.000	0.500
IRON WORKER	ALL		31.500	33.500	1.5	1.5	2.0	7.610	13.33	0.000	0.420
LABORER	ALL		25.860	26.360	1.5	1.5	2.0	5.750	14.34	0.000	0.800
MACHINIST	BLD		43.550	46.050	1.5	1.5	2.0	6.130	8.950	1.850	0.000
MARBLE FINISHERS	BLD		25.890	0.000	1.5	1.5	2.0	6.000	5.200	0.000	0.530
MARBLE MASON	BLD		29.280	33.160	1.5	1.5	2.0	7.750	9.430	2.000	0.400
MILLWRIGHT	ALL		34.630	36.130	1.5	1.5	2.0	6.550	6.750	0.000	0.400
OPERATING ENGINEER	BLD	1	34.200	37.200	1.5	1.5	2.0	9.000	17.00	0.000	1.000
OPERATING ENGINEER	BLD	2	33.070	37.200	1.5	1.5	2.0	9.000	17.00	0.000	1.000
OPERATING ENGINEER	BLD	3	28.590	37.200	1.5	1.5	2.0	9.000	17.00	0.000	1.000
OPERATING ENGINEER	BLD	4	28.650	37.200	1.5	1.5	2.0	9.000	17.00	0.000	1.000
OPERATING ENGINEER	BLD	5	28.320	37.200	1.5	1.5	2.0	9.000	17.00	0.000	1.000
OPERATING ENGINEER	BLD	6	35.750	37.200	1.5	1.5	2.0	9.000	17.00	0.000	1.000
OPERATING ENGINEER	BLD	7	36.050	37.200	1.5	1.5	2.0	9.000	17.00	0.000	1.000
OPERATING ENGINEER	BLD	8	36.330	37.200	1.5	1.5	2.0	9.000	17.00	0.000	1.000
OPERATING ENGINEER	BLD	9	35.650	37.200	1.5	1.5	2.0	9.000	17.00	0.000	1.000
OPERATING ENGINEER	HWY	1	32.700	35.700	1.5	1.5	2.0	9.000	17.00	0.000	1.000
OPERATING ENGINEER	HWY	2	31.570	35.700	1.5	1.5	2.0	9.000	17.00	0.000	1.000
OPERATING ENGINEER	HWY	3	27.090	35.700	1.5	1.5	2.0	9.000	17.00	0.000	1.000
OPERATING ENGINEER	HWY	4	27.150	35.700	1.5	1.5	2.0	9.000	17.00	0.000	1.000
OPERATING ENGINEER	HWY	5	26.820	35.700	1.5	1.5	2.0	9.000	17.00	0.000	1.000
OPERATING ENGINEER	HWY	6	34.250	35.700	1.5	1.5	2.0	9.000	17.00	0.000	1.000
OPERATING ENGINEER	HWY	7	34.550	35.700	1.5	1.5	2.0	9.000	17.00	0.000	1.000
OPERATING ENGINEER	HWY	8	34.830	35.700	1.5	1.5	2.0	9.000	17.00	0.000	1.000
OPERATING ENGINEER	HWY	9	34.150	35.700	1.5	1.5	2.0	9.000	17.00	0.000	1.000
PAINTER	BLD		29.250	30.750	1.5	1.5	2.0	5.000	7.920	0.000	0.600
PAINTER	HWY		30.450	31.950	1.5	1.5	2.0	5.000	7.920	0.000	0.600
PAINTER OVER 30FT	BLD		30.250	31.750	1.5	1.5	2.0	5.000	7.920	0.000	0.600
PAINTER PWR EQMT	BLD		30.250	31.750	1.5	1.5	2.0	5.000	7.920	0.000	0.600
PAINTER PWR EQMT	HWY		31.450	32.950	1.5	1.5	2.0	5.000	7.920	0.000	0.600
PILEDRIVER	ALL		34.630	36.130	1.5	1.5	2.0	6.550	6.750	0.000	0.400
PIPEFITTER	BLD		37.800	39.690	2.0	2.0	2.0	4.500	8.360	0.000	0.300
PLASTERER	BLD		30.250	31.250	1.5	1.5	2.0	9.250	8.600	0.000	0.050
PLUMBER	BLD		37.800	39.690	2.0	2.0	2.0	4.500	8.360	0.000	0.300
ROOFER	BLD		29.500	31.500	1.5	1.5	2.0	8.600	6.850	0.000	0.200
SHEETMETAL WORKER	ALL		31.690	33.190	1.5	1.5	2.0	7.130	6.730	1.910	0.360
SPRINKLER FITTER	BLD		36.390	39.140	1.5	1.5	2.0	8.420	8.500	0.000	0.450
TERRAZZO FINISHER	BLD		31.240	0.000	1.5	1.5	2.0	6.000	3.230	0.000	0.200
TERRAZZO MASON	BLD		32.530	32.830	1.5	1.5	2.0	6.000	5.230	0.000	0.210
TRUCK DRIVER	ALL	1	31.340	0.000	1.5	1.5	2.0	10.30	5.010	0.000	0.250
TRUCK DRIVER	ALL	2	31.780	0.000	1.5	1.5	2.0	10.30	5.010	0.000	0.250
TRUCK DRIVER	ALL	3	32.020	0.000	1.5	1.5	2.0	10.30	5.010	0.000	0.250
TRUCK DRIVER	ALL	4	32.280	0.000	1.5	1.5	2.0	10.30	5.010	0.000	0.250
TRUCK DRIVER	ALL	5	33.130	0.000	1.5	1.5	2.0	10.30	5.010	0.000	0.250
TRUCK DRIVER	O&C	1	25.070	0.000	1.5	1.5	2.0	10.30	5.010	0.000	0.250

TRUCK DRIVER	O&C 2	25.420	0.000	1.5	1.5	2.0	10.30	5.010	0.000	0.250
TRUCK DRIVER	O&C 3	25.620	0.000	1.5	1.5	2.0	10.30	5.010	0.000	0.250
TRUCK DRIVER	O&C 4	25.820	0.000	1.5	1.5	2.0	10.30	5.010	0.000	0.250
TRUCK DRIVER	O&C 5	26.500	0.000	1.5	1.5	2.0	10.30	5.010	0.000	0.250

Legend :

RG (Region)

TYP (Trade Type - All,Highway,Building,Floating,Oil & Chip,Rivers)

C (Class)

Base (Base Wage Rate)

FRMAN (Foreman Rate)

M-F>8 (OT required for any hour greater than 8 worked each day, Mon through Fri.)

OSA (Overtime (OT) is required for every hour worked on Saturday)

OSH (Overtime is required for every hour worked on Sunday and Holidays)

H/W (Health & Welfare Insurance)

Pensn (Pension)

Vac (Vacation)

Trng (Training)

Explanations

BOND COUNTY

ELECTRICIANS AND ELECTRONIC SYSTEMS TECHNICIAN (EAST) - Townships of Mulberry Grove, Pleasant Mount & Tamalco.

ELECTRICIANS AND ELECTRONIC SYSTEMS TECHNICIAN (WEST) - Townships of Shoal Creek, LaGrange, Old Ripley, Central, Burgess & Mills

The following list is considered as those days for which holiday rates of wages for work performed apply: New Years Day, Memorial Day, Fourth of July, Labor Day, Thanksgiving Day, Christmas Day and Veterans Day in some classifications/counties. Generally, any of these holidays which fall on a Sunday is celebrated on the following Monday. This then makes work performed on that Monday payable at the appropriate overtime rate for holiday pay. Common practice in a given local may alter certain days of celebration. If in doubt, please check with IDOL.

Oil and chip resealing (O&C) means the application of road oils and liquid asphalt to coat an existing road surface, followed by application of aggregate chips or gravel to coated surface, and subsequent rolling of material to seal the surface.

EXPLANATION OF CLASSES

ASBESTOS - GENERAL - removal of asbestos material/mold and hazardous materials from any place in a building, including mechanical systems where those mechanical systems are to be removed. This includes the

removal of asbestos materials/mold and hazardous materials from ductwork or pipes in a building when the building is to be demolished at the time or at some close future date.

ASBESTOS - MECHANICAL - removal of asbestos material from mechanical systems, such as pipes, ducts, and boilers, where the mechanical systems are to remain.

CERAMIC TILE FINISHER AND MARBLE FINISHER

The handling, at the building site, of all sand, cement, tile, marble or stone and all other materials that may be used and installed by [a] tile layer or marble mason. In addition, the grouting, cleaning, sealing, and mixing on the job site, and all other work as required in assisting the setter. The term "Ceramic" is used for naming the classification only and is in no way a limitation of the product handled. Ceramic takes into consideration most hard tiles.

ELECTRONIC SYSTEMS TECHNICIAN

Installation, service and maintenance of low-voltage systems which utilizes the transmission and/or transference of voice, sound, vision, or digital for commercial, education, security and entertainment purposes for the following: TV monitoring and surveillance, background/foreground music, intercom and telephone interconnect, field programming, inventory control systems, microwave transmission, multi-media, multiplex, radio page, school, intercom and sound burglar alarms and low voltage master clock systems.

Excluded from this classification are energy management systems, life safety systems, supervisory controls and data acquisition systems not intrinsic with the above listed systems, fire alarm systems, nurse call systems and raceways exceeding fifteen feet in length.

OPERATING ENGINEER - BUILDING

GROUP I. Cranes, Dragline, Shovels, Skimmer Scoops, Clamshells or Derrick Boats, Pile Drivers, Crane-Type Backhoes, Asphalt Plant Operators, Concrete Plant Operators, Dredges, Asphalt Spreading Machines, All Locomotives, Cable Ways or Tower Machines, Hoists, Hydraulic Backhoes, Ditching Machines or Backfiller, Cherrypickers, Overhead Cranes, Roller - Steam or Gas, Concrete Pavers, Excavators, Concrete Breakers, Concrete Pumps, Bulk Cement Plants, Cement Pumps, Derrick-Type Drills, Boat Operators, Motor Graders or Pushcats, Scoops or Tournapulls, Bulldozers, Endloaders or Fork Lifts, Power Blade or Elevating Graders, Winch Cats, Boom or Winch Trucks or Boom Tractors, Pipe Wrapping or Painting Machines, Asphalt Plant Engineer, Journeyman Lubricating Engineer, Drills (other than Derrick Type), Mud Jacks, or Well Drilling Machines, Boring Machines or Track Jacks, Mixers, Conveyors (Two), Air Compressors (Two), Water Pumps regardless of size (Two), Welding Machines (Two), Siphons or Jets (Two), Winch Heads or Apparatuses (Two), Light Plants (Two), All Tractors regardless of size (straight tractor only), Fireman on Stationary Boilers, Automatic Elevators, Form Grading Machines, Finishing Machines, Power Sub-Grader or Ribbon Machines, Longitudinal Floats, Distributor Operators on Trucks, Winch Heads or Apparatuses (One), Mobil Track air and heaters (two to five), Heavy Equipment Greaser, Relief Operator, Assistant Master Mechanic and Heavy Duty Mechanic, self-propelled concrete saws of all types and sizes with their attachments, gob-hoppers, excavators all sizes, the repair and greasing of all diesel hammers, the operation and set-up of bidwells, water blasters of all sizes and their clutches, hydraulic jacks where used for hoisting, operation of log skidders, iceolators used on and off of pipeline, condor cranes, bow boats, survey boats, bobcats and all their attachments, skid steer loaders and all their attachments, creter cranes, batch plants,

operator (all sizes), self propelled roto mills, operation of conveyor systems of any size and any configuration, operation, repair and service of all vibratory hammers, all power pacs and their controls regardless of location, curtains or brush burning machines, stump cutter machines, Nail launchers when mounted on a machine or self-propelled, operation of con-cover machines, and all Operators except those listed below).

GROUP II. Assistant Operators.

GROUP III. Air Compressors (One), Water Pumps, regardless of Size (One), Waterblasters (one), Welding Machine (One), Mixers (One Bag), Conveyor (One), Siphon or Jet (One), Light Plant (One), Heater (One), Immobile Track Air (One), and Self Propelled Walk-Behind Rollers.

GROUP IV. Asphalt Spreader Oilers, Fireman on Whirlies and Heavy Equipment Oilers, Truck Cranes, Dredges, Monigans, Large Cranes - (Over 65-ton rated capacity) Concrete Plant Oiler, Blacktop Plant Oiler, and Creter Crane Oiler (when required).

GROUP V. Oiler.

GROUP VI. Operators on equipment with Booms, including jibs, 100 feet and over, and less than 150 feet long.

GROUP VII. Operators on equipment with Booms, including jibs, 150 feet and over, and less than 200 feet long.

GROUP VIII. Operators on Equipment with Booms, including jibs, 200 feet and over; Tower Cranes; and Whirlie Cranes.

GROUP IX. Master Mechanic

OPERATING ENGINEERS - Highway

GROUP I. Cranes, Dragline, Shovels, Skimmer Scoops, Clamshells or Derrick Boats, Pile Drivers, Crane-Type Backhoes, Asphalt Plant Operators, Concrete Plant Operators, Dredges, Asphalt Spreading Machines, All Locomotives, Cable Ways or Tower Machines, Hoists, Hydraulic Backhoes, Ditching Machines or Backfiller, Cherrypickers, Overhead Cranes, Roller - Steam or Gas, Concrete Pavers, Excavators, Concrete Breakers, Concrete Pumps, Bulk Cement Plants, Cement Pumps, Derrick-Type Drills, Boat Operators, Motor Graders or Pushcats, Scoops or Tournapulls, Bulldozers, Endloaders or Fork Lifts, Power Blade or Elevating Graders, Winch Cats, Boom or Winch Trucks or Boom Tractors, Pipe Wrapping or Painting Machines, Asphalt Plant Engineer, Journeyman Lubricating Engineer, Drills (other than Derrick Type), Mud Jacks, Well Drilling Machines, Boring Machines, Track Jacks, Mixers, Conveyors (Two), Air Compressors (Two), Water Pumps regardless of size (Two), Welding Machines (Two), Siphons or Jets (Two), Winch Heads or Apparatuses (Two), Light Plants (Two), All Tractors regardless of size (straight tractor only), Fireman on Stationary Boilers, Automatic Elevators, Form Grading Machines, Finishing Machines, Power Sub-Grader or Ribbon Machines, Longitudinal Floats, Distributor Operators on Trucks, Winch Heads or Apparatuses (One), Mobil Track air and heaters (two to five), Heavy Equipment Greaser, Relief Operator, Assistant Master Mechanic and Heavy Duty Mechanic, self-propelled concrete saws of all types and sizes with their attachments, gob-hoppers, excavators all sizes, the repair and greasing of all diesel hammers, the operation and set-up of bidwells, water blasters of all sizes and their clutches, hydraulic jacks where used for hoisting, operation of log skidders, iceolators used on and off of pipeline, condor cranes, bow boats, survey boats, bobcats and all their attachments, skid steer loaders and all their attachments, creter cranes, batch plants, operator (all sizes), self propelled roto mills, operation of conveyor

systems of any size and any configuration, operation, repair and service of all vibratory hammers, all power pacs and their controls regardless of location, curtains or brush burning machines, stump cutter machines, Nail launchers when mounted on a machine or self-propelled, operation of con-cover machines, and all Operators (except those listed below).

GROUP II. Assistant Operators.

GROUP III. Air Compressors (One), Water Pumps, regardless of Size (One), Waterblasters (one), Welding Machine (One), Mixers (One Bag), Conveyor (One), Siphon or Jet (One), Light Plant (One), Heater (One), Immobile Track Air (One), and Self Propelled Walk-Behind Rollers.

GROUP IV. Asphalt Spreader Oilers, Fireman on Whirlies and Heavy Equipment Oilers, Truck Cranes, Dredges, Monigans, Large Cranes - (Over 65-ton rated capacity) Concrete Plant Oiler, Blacktop Plant Oiler, and Creter Crane Oiler (when required).

GROUP V. Oiler.

GROUP VI. Operators on equipment with Booms, including jibs, 100 feet and over, and less than 150 feet long.

GROUP VII. Operators on equipment with Booms, including jibs, 150 feet and over, and less than 200 feet long.

GROUP VIII. Operators on Equipment with Booms, including jibs, 200 feet and over; Tower Cranes; and Whirlie Cranes.

GROUP IX. Mechanic

TRUCK DRIVER - BUILDING, HEAVY AND HIGHWAY CONSTRUCTION

Class 1. Drivers on 2 axle trucks hauling less than 9 ton. Air compressor and welding machines and brooms, including those pulled by separate units, truck driver helpers, warehouse employees, mechanic helpers, greasers and tiremen, pickup trucks when hauling materials, tools, or workers to and from and on-the-job site, and fork lifts up to 6,000 lb. capacity.

Class 2. Two or three axle trucks hauling more than 9 ton but hauling less than 16 ton. A-frame winch trucks, hydrolift trucks, vactor trucks or similar equipment when used for transportation purposes. Fork lifts over 6,000 lb. capacity, winch trucks, four axle combination units, and ticket writers.

Class 3. Two, three or four axle trucks hauling 16 ton or more. Drivers on water pulls, articulated dump trucks, mechanics and working forepersons, and dispatchers. Five axle or more combination units.

Class 4. Low Boy and Oil Distributors.

Class 5. Drivers who require special protective clothing while employed on hazardous waste work.

TRUCK DRIVER - OIL AND CHIP RESEALING ONLY.

This shall encompass laborers, workers and mechanics who drive contractor or subcontractor owned, leased, or hired pickup, dump, service, or oil distributor trucks. The work includes transporting materials and equipment (including but not limited to, oils, aggregate supplies, parts, machinery and tools) to or from the job site;

distributing oil or liquid asphalt and aggregate; stock piling material when in connection with the actual oil and chip contract. The Truck Driver (Oil & Chip Resealing) wage classification does not include supplier delivered materials.

TERRAZZO FINISHER

The handling of all materials used for Mosaic and Terrazzo work including preparing, mixing by hand, by mixing machine or transporting of pre-mixed materials and distributing with shovel, rake, hoe, or pail, all kinds of concrete foundations necessary for Mosaic and Terrazzo work, all cement terrazzo, magnesite terrazzo, Do-O-Tex terrazzo, epoxy matrix ter-razzo, exposed aggregate, rustic or rough washed for exterior or interior of buildings placed either by machine or by hand, and any other kind of mixture of plastics composed of chips or granules when mixed with cement, rubber, neoprene, vinyl, magnesium chloride or any other resinous or chemical substances used for seamless flooring systems, and all other building materials, all similar materials and all precast terrazzo work on jobs, all scratch coat used for Mosaic and Terrazzo work and sub-bed, tar paper and wire mesh (2x2 etc.) or lath. The rubbing, grinding, cleaning and finishing of same either by hand or by machine or by terrazzo resurfacing equipment on new or existing floors. When necessary finishers shall be allowed to assist the mechanics to spread sand bed, lay tarpaper and wire mesh (2x2 etc.) or lath. The finishing of cement floors where additional aggregate of stone is added by spreading or sprinkling on top of the finished base, and troweled or rolled into the finish and then the surface is ground by grinding machines.

Other Classifications of Work:

For definitions of classifications not otherwise set out, the Department generally has on file such definitions which are available. If a task to be performed is not subject to one of the classifications of pay set out, the Department will upon being contacted state which neighboring county has such a classification and provide such rate, such rate being deemed to exist by reference in this document. If no neighboring county rate applies to the task, the Department shall undertake a special determination, such special determination being then deemed to have existed under this determination. If a project requires these, or any classification not listed, please contact IDOL at 217-782-1710 for wage rates or clarifications.

LANDSCAPING

Landscaping work falls under the existing classifications for laborer, operating engineer and truck driver. The work performed by landscape plantsman and landscape laborer is covered by the existing classification of laborer. The work performed by landscape operators (regardless of equipment used or its size) is covered by the classifications of operating engineer. The work performed by landscape truck drivers (regardless of size of truck driven) is covered by the classifications of truck driver.

Boone County Prevailing Wage for May 2013

(See explanation of column headings at bottom of wages)

Trade Name	RG	TYP	C	Base	FRMAN	M-F>8	OSA	OSH	H/W	Pensn	Vac	Trng
=====	==	==	=	=====	=====	=====	==	==	=====	=====	=====	=====
ASBESTOS ABT-GEN		ALL		36.200	36.700	1.5	1.5	2.0	12.78	9.020	0.000	0.500

ASBESTOS ABT-MEC	BLD	22.750	24.250	1.5	1.5	2.0	3.390	5.170	0.000	0.000
BOILERMAKER	BLD	43.450	47.360	2.0	2.0	2.0	6.970	14.66	0.000	0.350
BRICK MASON	BLD	37.380	40.130	1.5	1.5	2.0	7.950	11.73	0.000	0.600
CARPENTER	BLD	36.320	40.320	1.5	1.5	2.0	7.700	11.25	0.000	0.600
CARPENTER	HWY	39.830	41.580	1.5	1.5	2.0	7.700	9.000	0.000	0.490
CEMENT MASON	ALL	34.820	37.570	1.5	1.5	2.0	8.150	11.45	0.000	0.500
CERAMIC TILE FNSHER	BLD	32.410	0.000	1.5	1.5	2.0	7.700	4.840	0.000	0.530
COMMUNICATION TECH	BLD	36.000	39.600	1.5	1.5	2.0	10.14	11.20	0.000	0.720
ELECTRIC PWR EQMT OP	ALL	36.610	49.750	1.5	1.5	2.0	5.000	11.35	0.000	0.270
ELECTRIC PWR GRNDMAN	ALL	28.310	49.750	1.5	1.5	2.0	5.000	8.780	0.000	0.210
ELECTRIC PWR LINEMAN	ALL	43.830	49.750	1.5	1.5	2.0	5.000	13.58	0.000	0.330
ELECTRIC PWR TRK DRV	ALL	29.310	49.750	1.5	1.5	2.0	5.000	9.090	0.000	0.220
ELECTRICIAN	BLD	40.000	44.000	1.5	1.5	2.0	10.14	16.93	0.000	0.800
ELEVATOR CONSTRUCTOR	BLD	45.350	51.020	2.0	2.0	2.0	11.88	12.71	3.630	0.600
GLAZIER	BLD	34.730	35.730	1.5	1.5	2.0	9.700	8.200	0.000	1.250
HT/FROST INSULATOR	BLD	36.760	37.760	1.5	1.5	2.0	7.550	10.76	0.000	0.500
IRON WORKER	ALL	35.090	36.840	2.0	2.0	2.0	8.250	20.59	0.000	0.700
LABORER	ALL	36.200	36.950	1.5	1.5	2.0	12.52	9.280	0.000	0.500
LATHER	BLD	36.320	40.320	1.5	1.5	2.0	7.700	11.25	0.000	0.600
MACHINIST	BLD	43.550	46.050	1.5	1.5	2.0	6.130	8.950	1.850	0.000
MARBLE FINISHERS	BLD	32.410	0.000	1.5	1.5	2.0	7.700	4.840	0.000	0.530
MARBLE MASON	BLD	35.090	35.340	1.5	1.5	2.0	7.700	7.150	0.000	0.560
MATERIAL TESTER I	ALL	26.200	0.000	1.5	1.5	2.0	12.52	9.280	0.000	0.500
MATERIALS TESTER II	ALL	31.200	0.000	1.5	1.5	2.0	12.52	9.280	0.000	0.500
MILLWRIGHT	BLD	35.000	38.500	1.5	1.5	2.0	7.700	13.87	0.000	0.500
OPERATING ENGINEER	BLD 1	40.800	44.850	2.0	2.0	2.0	15.85	9.800	2.350	1.300
OPERATING ENGINEER	BLD 2	40.100	44.850	2.0	2.0	2.0	15.85	9.800	2.350	1.300
OPERATING ENGINEER	BLD 3	37.650	44.850	2.0	2.0	2.0	15.85	9.800	2.350	1.300
OPERATING ENGINEER	BLD 4	35.650	44.850	2.0	2.0	2.0	15.85	9.800	2.350	1.300
OPERATING ENGINEER	BLD 5	44.600	44.850	2.0	2.0	2.0	15.85	9.800	2.350	1.300
OPERATING ENGINEER	BLD 6	43.350	44.850	2.0	2.0	2.0	15.85	9.800	2.350	1.300
OPERATING ENGINEER	BLD 7	40.350	44.850	2.0	2.0	2.0	15.85	9.800	2.350	1.300
OPERATING ENGINEER	HWY 1	40.650	44.700	1.5	1.5	2.0	15.85	9.800	2.350	1.300
OPERATING ENGINEER	HWY 2	40.100	44.700	1.5	1.5	2.0	15.85	9.800	2.350	1.300
OPERATING ENGINEER	HWY 3	38.800	44.700	1.5	1.5	2.0	15.85	9.800	2.350	1.300
OPERATING ENGINEER	HWY 4	37.350	44.700	1.5	1.5	2.0	15.85	9.800	2.350	1.300
OPERATING ENGINEER	HWY 5	35.900	44.700	1.5	1.5	2.0	15.85	9.800	2.350	1.300
OPERATING ENGINEER	HWY 6	43.700	44.700	1.5	1.5	2.0	15.85	9.800	2.350	1.300
OPERATING ENGINEER	HWY 7	41.700	44.700	1.5	1.5	2.0	15.85	9.800	2.350	1.300
PAINTER	ALL	35.700	37.700	1.5	1.5	1.5	9.650	8.460	0.000	1.250
PAINTER SIGNS	BLD	33.920	38.090	1.5	1.5	1.5	2.600	2.710	0.000	0.000
PILEDRIVER	BLD	37.320	41.430	1.5	1.5	2.0	7.700	11.25	0.000	0.600
PILEDRIVER	HWY	39.830	41.580	1.5	1.5	2.0	7.700	9.000	0.000	0.490
PIPEFITTER	BLD	40.600	43.440	1.5	1.5	2.0	7.980	10.79	0.000	1.000
PLASTERER	BLD	33.360	36.700	1.5	1.5	2.0	8.150	11.05	0.000	0.500
PLUMBER	BLD	40.600	43.440	1.5	1.5	2.0	7.980	10.79	0.000	1.000
ROOFER	BLD	38.350	41.350	1.5	1.5	2.0	8.280	8.770	0.000	0.430
SHEETMETAL WORKER	BLD	35.780	37.710	1.5	1.5	2.0	5.450	15.44	0.520	0.290
SPRINKLER FITTER	BLD	36.390	39.140	1.5	1.5	2.0	8.420	8.500	0.000	0.450
STONE MASON	BLD	37.380	40.130	1.5	1.5	2.0	7.950	11.73	0.000	0.600
TERRAZZO FINISHER	BLD	32.410	0.000	1.5	1.5	2.0	7.700	4.840	0.000	0.530
TERRAZZO MASON	BLD	35.090	35.340	1.5	1.5	2.0	7.700	7.150	0.000	0.560
TILE LAYER	BLD	36.320	40.320	1.5	1.5	2.0	7.700	11.25	0.000	0.600
TILE MASON	BLD	35.090	35.340	1.5	1.5	2.0	7.700	7.150	0.000	0.560
TRUCK DRIVER	ALL 1	32.960	33.420	1.5	1.5	2.0	6.900	8.220	0.000	0.000
TRUCK DRIVER	ALL 2	33.110	33.420	1.5	1.5	2.0	6.900	8.220	0.000	0.000
TRUCK DRIVER	ALL 3	33.310	33.420	1.5	1.5	2.0	6.900	8.220	0.000	0.000
TRUCK DRIVER	ALL 4	33.420	33.420	1.5	1.5	2.0	6.900	8.220	0.000	0.000
TUCKPOINTER	BLD	37.380	40.130	1.5	1.5	2.0	7.950	11.73	0.000	0.600

Legend:

RG (Region)

TYP (Trade Type - All,Highway,Building,Floating,Oil & Chip,Rivers)

C (Class)

Base (Base Wage Rate)

FRMAN (Foreman Rate)

M-F>8 (OT required for any hour greater than 8 worked each day, Mon through Fri.)

OSA (Overtime (OT) is required for every hour worked on Saturday)

OSH (Overtime is required for every hour worked on Sunday and Holidays)

H/W (Health & Welfare Insurance)

Pensn (Pension)

Vac (Vacation)

Trng (Training)

Explanations

BOONE COUNTY

The following list is considered as those days for which holiday rates of wages for work performed apply: New Years Day, Memorial Day, Fourth of July, Labor Day, Thanksgiving Day, Christmas Day and Veterans Day in some classifications/counties. Generally, any of these holidays which fall on a Sunday is celebrated on the following Monday. This then makes work performed on that Monday payable at the appropriate overtime rate for holiday pay. Common practice in a given local may alter certain days of celebration. If in doubt, please check with IDOL.

EXPLANATION OF CLASSES

ASBESTOS - GENERAL - removal of asbestos material/mold and hazardous materials from any place in a building, including mechanical systems where those mechanical systems are to be removed. This includes the removal of asbestos materials/mold and hazardous materials from ductwork or pipes in a building when the building is to be demolished at the time or at some close future date.

ASBESTOS - MECHANICAL - removal of asbestos material from mechanical systems, such as pipes, ducts, and boilers, where the mechanical systems are to remain.

CERAMIC TILE FINISHER, MARBLE FINISHER, TERRAZZO FINISHER

Assisting, helping or supporting the tile, marble and terrazzo mechanic by performing their historic and traditional work assignments required to complete the proper installation of the work covered by said crafts. The term "Ceramic" is used for naming the classification only and is in no way a limitation of the product handled. Ceramic takes into consideration most hard tiles.

COMMUNICATION TECHNICIAN

Installing, manufacturing, assembling and maintaining sound and

intercom, protection alarm (security), fire alarm, master antenna television, closed circuit television, low voltage control for computers and/or door monitoring, school communications systems, telephones and servicing of nurse and emergency calls, and the installation and maintenance of transmit and receive antennas, transmitters, receivers, and associated apparatus which operates in conjunction with above systems. All work associated with these system installations will be included EXCEPT the installation of protective metallic conduit in new construction projects (excluding less than ten-foot runs strictly for protection of cable) and 120 volt AC (or higher) power wiring and associated hardware.

MATERIAL TESTER I: Hand coring and drilling for testing of materials; field inspection of uncured concrete and asphalt.

MATERIAL TESTER II: Field inspection of welds, structural steel, fireproofing, masonry, soil, facade, reinforcing steel, formwork, cured concrete, and concrete and asphalt batch plants; adjusting proportions of bituminous mixtures.

OPERATING ENGINEERS - BUILDING

Class 1. Asphalt Plant; Asphalt Spreader; Autograde; Backhoes with Caisson Attachment; Batch Plant; Benoto (requires Two Engineers); Boiler and Throttle Valve; Caisson Rigs; Central Redi-Mix Plant; Combination Back Hoe Front End-loader Machine; Compressor and Throttle Valve; Concrete Breaker (Truck Mounted); Concrete Conveyor; Concrete Paver (over 27E cu. ft.): Concrete Paver (27 cu. ft. and under); Concrete Placer; Concrete Pump (Truck Mounted); Concrete Conveyor (Truck Mounted); Concrete Tower; Cranes, All; GCI and similar types (required two operators only); Cranes, Hammerhead; Creter Crane; Crusher, Stone, etc.; Derricks, All; Derricks, Traveling; Formless Curb and Gutter Machine; Grader, Elevating; Grouting Machines; Highlift Shovels or Front Endloader 2-1/4 yd. and over; Hoists, Elevators, outside type rack and pinion and similar machines; Hoists, one, two and three Drum; Hoists, Two Tugger One Floor; Hydraulic Backhoes; Hydraulic Boom Trucks; Hydro Vac (and similar equipment - excluding hose work and any sewer work); Locomotives, All; Lubrication Technician; Manipulators; Motor Patrol; Pile Drivers and Skid Rig; Post Hole Digger; Pre-Stress Machine; Pump Cretes Dual Ram; Pump Cretes: Squeeze Cretes - Screw Type Pumps, Gypsum Bulker and Pump; Raised and Blind Hole Drill; Rock Drill (self-propelled); Rock Drill - Truck Mounted; Roto Mill Grinder; Scoops - Tractor Drawn; Slipform Paver; Scrapers Prime Movers; Straddle Buggies; Tie Back Machine; Tractor with Boom and Side Boom; Trenching Machines.

Class 2. Bobcat (over 3/4 cu. yd.); Boilers; Brick Forklift; Broom, All Power Propelled; Bulldozers; Concrete Mixer (Two Bag and Over); Conveyor, Portable; Forklift Trucks; Highlift Shovels or Front Endloaders under 2-1/4 yd.; Hoists, Automatic; Hoists, Sewer Dragging Machine; Hoists, Tugger Single Drum; Laser Screed; Rollers, All; Steam Generators; Tractors, All; Tractor Drawn Vibratory Roller; Winch Trucks with "A" Frame.

Class 3. Air Compressor; Asphalt Spreader; Combination - Small Equipment Operator; Generators; Heaters, Mechanical; Hoists, Inside Elevators - (Rheostat Manual Controlled); Hydraulic Power Units (Pile Driving, Extracting, or Drilling - with a seat); Lowboys; Pumps, Over 3" (1 to 3 not to exceed total of 300 ft.); Pumps, Well Points; Welding Machines (2 through 5); Winches, 4 Small Electric Drill Winches; Bobcat (up to and including 3/4 cu. yd.).

Class 4. Elevator push button with automatic doors; Hoists, Inside; Oilers; Brick Forklift.

Class 5. Assistant Craft Foreman

Class 6. Mechanics; Welders.

Class 7. Gradall

OPERATING ENGINEERS - HIGHWAY CONSTRUCTION

Class 1. Asphalt Plant; Asphalt Heater and Planer Combination; Asphalt Heater Scarfire; Asphalt Silo Tender; Asphalt Spreader; Autograder; ABG Paver; Backhoes with Caisson Attachment; Ballast Regulator; Belt Loader; Caisson Rigs; Car Dumper; Central Redi-Mix Plant; Backhoe w/shear attachments; Combination Backhoe Front Endloader Machine, (1 cu. yd. Backhoe Bucket or over or with attachments); Concrete Breaker (Truck Mounted); Concrete Conveyor; Concrete Paver over 27E cu. ft.; Concrete Placer; Concrete Tube Float; Cranes, all attachments; Cranes, Tower of all types; Creter Crane; Crusher, Stone, etc.; Derricks, All; Derrick Boats; Derricks, Traveling; Directional Boring Machine over 12"; Dredges; Formless Curb and Gutter Machine; Grader, Elevating; Grader, Motor Grader, Motor Patrol, Auto Patrol, Form Grader, Pull Grader, Subgrader; Guard Rail Post Driver Mounted; Hoists, One, Two and Three Drum; Hydraulic Backhoes; Hydro Vac, Self Propelled, Truck Mounted (excluding hose work and any sewer work); Lubrication Technician; Manipulators; Pile Drivers and Skid Rig; Pre-Stress Machine; Pump Cretes Dual Ram; Rock Drill - Crawler or Skid Rig; Rock Drill - Truck Mounted; Rock/Track Tamper; Roto Mill Grinder; Slip-Form Paver; Snow Melters; Soil Test Drill Rig (Truck Mounted); Straddle Buggies; GCI Crane; Hydraulic Telescoping Form (Tunnel); Tie Back Machine; Tractor Drawn Belt Loader; Tractor Drawn Belt Loader with attached pusher; Tractor with Boom; Tractaire with Attachments; Traffic Barrier Conveyor Machine; Raised or Blind Hole Drills; Trenching Machine (over 12"); Truck Mounted Concrete Pump with Boom; Truck Mounted Concrete Conveyor; Work Boat (no license required - 90 h.p. or above); Underground Boring and/or Mining Machines; Wheel Excavator; Widener (APSCO).

Class 2. Batch Plant; Bituminous Mixer; Boiler and Throttle Valve; Bulldozers; Car Loader Trailing Conveyors; Combination Backhoe Front Endloader Machine (less than 1 cu. yd. Backhoe Bucket or over or with attachments); Compressor and Throttle Valve; Compressor, Common Receiver (3); Concrete Breaker or Hydro Hammer; Concrete Grinding Machine; Concrete Mixer or Paver 7S Series to and including 27 cu. ft.; Concrete Spreader; Concrete Curing Machine, Burlap Machine, Belting Machine and Sealing Machine; Concrete Wheel Saw (large self-propelled - excluding walk-behinds and hand-held); Conveyor Muck Cars (Haglund or Similar Type); Drills, all; Finishing Machine - Concrete; Highlift Shovels or Front Endloader; Hoist - Sewer Dragging Machine; Hydraulic Boom Trucks (All Attachments); Hydro Blaster; All Locomotives, Dinky; Off-Road Hauling Units; Non-Self Loading Dump; Ejection Dump; Pump Cretes: Squeeze Cretes - Screw Type Pumps, Gypsum Bulker and Pump; Roller, Asphalt; Rotary Snow Plows; Rototiller, Seaman, etc., self-propelled; Scoops - Tractor Drawn; Self-Propelled Compactor; Spreader - Chip - Stone, etc.; Scraper; Scraper - Prime Mover in Tandem (Regardless of Size); Tank Car Heater; Tractors, Push, Pulling Sheeps Foot, Disc, Compactor, etc.; Tug Boats.

Class 3. Boilers; Brooms, All Power Propelled; Cement Supply Tender; Compressor, Common Receiver (2); Concrete Mixer (Two Bag and Over); Conveyor, Portable; Farm-Type Tractors Used for Mowing, Seeding, etc.; Fireman on Boilers; Forklift Trucks; Grouting Machine; Hoists, Automatic; Hoists, All Elevators; Hoists, Tugger Single Drum; Jeep Diggers; Low Boys; Pipe Jacking Machines; Post-Hole Digger; Power Saw, Concrete Power Driven; Pug Mills; Rollers, other than asphalt; Seed and Straw Blower; Steam Generators; Stump Machine; Winch Trucks with

"A" Frame; Work Boats; Tamper - Form - Motor Driven.

Class 4. Air Compressor - Small and Large; Asphalt Spreader, Backend Man; Bobcat (Skid Steer) all; Brick Forklift; Combination - Small Equipment Operator; Directional Boring Machine up to 12"; Generators; Heaters, Mechanical; Hydraulic Power Unit (Pile Driving, Extracting, or Drilling); Hydro-Blaster; Light Plants, All (1 through 5); Pumps, over 3" (1 to 3 not to exceed a total of 300 ft.); Pumps, Well Points; Tractaire; Trencher 12" and under; Welding Machines (2 through 5); Winches, 4 Small Electric Drill Winches.

Class 5. Oilers and Directional Boring Machine Locator.

Class 6. Field Mechanics and Field Welders

Class 7. Gradall and machines of like nature.

TRUCK DRIVER - BUILDING, HEAVY AND HIGHWAY CONSTRUCTION

Class 1. Two or three Axle Trucks. A-frame Truck when used for transportation purposes; Air Compressors and Welding Machines, including those pulled by cars, pick-up trucks and tractors; Ambulances; Batch Gate Lockers; Batch Hopperman; Car and Truck Washers; Carry-alls; Fork Lifts and Hoisters; Helpers; Mechanics Helpers and Greasers; Oil Distributors 2-man operation; Pavement Breakers; Pole Trailer, up to 40 feet; Power Mower Tractors; Self-propelled Chip Spreader; Skipman; Slurry Trucks, 2-man operation; Slurry Truck Conveyor Operation, 2 or 3 man; Teamters; Unskilled dumpman; and Truck Drivers hauling warning lights, barricades, and portable toilets on the job site.

Class 2. Four axle trucks; Dump Crets and Adgetors under 7 yards; Dumpsters, Track Trucks, Euclids, Hug Bottom Dump Turnapulls or Turnatrailers when pulling other than self-loading equipment or similar equipment under 16 cubic yards; Mixer Trucks under 7 yards; Ready-mix Plant Hopper Operator, and Winch Trucks, 2 Axles.

Class 3. Five axle trucks; Dump Crets and Adgetors 7 yards and over; Dumpsters, Track Trucks, Euclids, Hug Bottom Dump Turnatrailers or turnapulls when pulling other than self-loading equipment or similar equipment over 16 cubic yards; Explosives and/or Fission Material Trucks; Mixer Trucks 7 yards or over; Mobile Cranes while in transit; Oil Distributors, 1-man operation; Pole Trailer, over 40 feet; Pole and Expandable Trailers hauling material over 50 feet long; Slurry trucks, 1-man operation; Winch trucks, 3 axles or more; Mechanic--Truck Welder and Truck Painter.

Class 4. Six axle trucks; Dual-purpose vehicles, such as mounted crane trucks with hoist and accessories; Foreman; Master Mechanic; Self-loading equipment like P.B. and trucks with scoops on the front.

Other Classifications of Work:

For definitions of classifications not otherwise set out, the Department generally has on file such definitions which are available. If a task to be performed is not subject to one of the classifications of pay set out, the Department will upon being contacted state which neighboring county has such a classification and provide such rate, such rate being deemed to exist by reference in this document. If no neighboring county rate applies to the task, the Department shall undertake a special determination, such special determination being then deemed to have existed under this determination. If a project requires these, or any classification not listed, please contact IDOL at 217-782-1710 for wage rates or clarifications.

LANDSCAPING

Landscaping work falls under the existing classifications for laborer, operating engineer and truck driver. The work performed by landscape plantsman and landscape laborer is covered by the existing classification of laborer. The work performed by landscape operators (regardless of equipment used or its size) is covered by the classifications of operating engineer. The work performed by landscape truck drivers (regardless of size of truck driven) is covered by the classifications of truck driver.

Brown County Prevailing Wage for May 2013

(See explanation of column headings at bottom of wages)

Trade Name	RG	TYP	C	Base	FRMAN	M-F>8	OSA	OSH	H/W	Pensn	Vac	Trng
=====	==	===	=	=====	=====	=====	===	===	=====	=====	=====	=====
ASBESTOS ABT-GEN		BLD		25.250	26.250	1.5	1.5	2.0	7.550	10.08	0.000	0.800
ASBESTOS ABT-MEC		BLD		29.860	30.860	1.5	1.5	2.0	6.950	3.000	0.000	0.000
BOILERMAKER		BLD		31.500	34.000	1.5	1.5	2.0	7.070	18.73	1.000	0.350
BRICK MASON		BLD		29.250	30.250	1.5	1.5	2.0	8.200	8.330	0.000	0.580
CARPENTER		BLD		27.670	29.920	1.5	1.5	2.0	7.450	14.58	0.000	0.520
CARPENTER		HWY		28.870	30.620	1.5	1.5	2.0	7.450	13.73	0.000	0.520
CEMENT MASON		BLD		25.200	26.700	1.5	1.5	2.0	6.600	12.10	0.000	0.500
CEMENT MASON		HWY		24.850	25.850	1.5	1.5	2.0	6.600	11.85	0.000	0.500
CERAMIC TILE FNSHER		BLD		25.600	0.000	1.5	1.5	2.0	8.200	7.230	0.000	0.000
ELECTRIC PWR EQMT OP		ALL		35.440	0.000	1.5	1.5	2.0	5.000	10.98	0.000	0.270
ELECTRIC PWR GRNDMAN		ALL		24.320	0.000	1.5	1.5	2.0	5.000	7.540	0.000	0.180
ELECTRIC PWR LINEMAN		ALL		39.370	41.910	1.5	1.5	2.0	5.000	12.20	0.000	0.300
ELECTRIC PWR TRK DRV		ALL		25.510	0.000	1.5	1.5	2.0	5.000	7.920	0.000	0.190
ELECTRICIAN		BLD		28.360	30.860	1.5	1.5	2.0	5.350	8.550	0.000	0.400
ELECTRONIC SYS TECH		BLD		27.430	29.180	1.5	1.5	2.0	5.350	9.320	0.000	0.400
ELEVATOR CONSTRUCTOR		BLD		40.520	45.585	2.0	2.0	2.0	11.88	12.71	3.240	0.600
GLAZIER		BLD		30.780	32.780	1.5	2.0	2.0	6.630	8.150	0.000	0.380
HT/FROST INSULATOR		BLD		37.260	38.260	1.5	1.5	2.0	7.850	11.16	0.000	0.500
IRON WORKER		BLD		29.460	31.460	1.5	1.5	2.0	7.740	11.38	0.000	0.660
IRON WORKER		HWY		30.600	32.100	1.5	1.5	2.0	7.740	11.69	0.000	0.660
LABORER		BLD		23.750	24.750	1.5	1.5	2.0	7.550	10.08	0.000	0.800
LABORER		HWY		24.910	25.910	1.5	1.5	2.0	7.550	10.63	0.000	0.800
LATHER		BLD		27.670	29.920	1.5	1.5	2.0	7.450	14.58	0.000	0.520
MACHINIST		BLD		43.550	46.050	1.5	1.5	2.0	6.130	8.950	1.850	0.000
MARBLE FINISHERS		BLD		25.600	0.000	1.5	1.5	2.0	8.200	7.230	0.000	0.000
MARBLE MASON		BLD		27.100	27.850	1.5	1.5	2.0	8.200	7.230	0.000	0.000
MILLWRIGHT		BLD		29.620	31.870	1.5	1.5	2.0	7.450	13.09	0.000	0.520
MILLWRIGHT		HWY		31.690	33.440	1.5	1.5	2.0	7.450	13.54	0.000	0.520
OPERATING ENGINEER		BLD 1		33.900	35.400	1.5	1.5	2.0	10.05	7.600	0.000	1.300
OPERATING ENGINEER		BLD 2		31.550	35.400	1.5	1.5	2.0	10.05	7.600	0.000	1.300
OPERATING ENGINEER		BLD 3		27.950	35.400	1.5	1.5	2.0	10.05	7.600	0.000	1.300
OPERATING ENGINEER		BLD 4		35.400	35.400	1.5	1.5	2.0	10.05	7.600	0.000	1.300
OPERATING ENGINEER		HWY 1		37.600	39.100	1.5	1.5	2.0	10.05	8.100	0.000	1.300
OPERATING ENGINEER		HWY 2		33.660	39.100	1.5	1.5	2.0	10.05	8.100	0.000	1.300
OPERATING ENGINEER		HWY 3		27.630	39.100	1.5	1.5	2.0	10.05	8.100	0.000	1.300
OPERATING ENGINEER		HWY 4		39.100	39.100	1.5	1.5	2.0	10.05	8.100	0.000	1.300
PAINTER		ALL		28.580	30.080	1.5	1.5	2.0	5.000	8.580	0.000	0.550
PAINTER OVER 30FT		ALL		29.580	31.080	1.5	1.5	2.0	5.000	8.580	0.000	0.550
PAINTER PWR EQMT		ALL		29.580	31.080	1.5	1.5	2.0	5.000	8.580	0.000	0.550
PILEDRIVER		BLD		28.170	30.420	1.5	1.5	2.0	7.450	14.58	0.000	0.520
PILEDRIVER		HWY		29.870	31.620	1.5	1.5	2.0	7.450	13.73	0.000	0.520
PIPEFITTER		ALL		36.550	40.210	1.5	1.5	2.0	5.650	12.15	0.000	1.000
PLUMBER		ALL		36.550	40.210	1.5	1.5	2.0	5.650	12.15	0.000	1.000
ROOFER		BLD		28.580	30.010	1.5	1.5	2.0	8.450	7.220	0.000	0.250
SHEETMETAL WORKER		BLD		31.680	33.930	1.5	1.5	2.0	8.300	12.35	0.000	0.500
SPRINKLER FITTER		BLD		36.390	39.140	1.5	1.5	2.0	8.420	8.500	0.000	0.450

STONE MASON	BLD	29.250	30.250	1.5	1.5	2.0	8.200	8.330	0.000	0.580
TERRAZZO FINISHER	BLD	25.600	0.000	1.5	1.5	2.0	8.200	7.230	0.000	0.000
TERRAZZO MASON	BLD	27.100	27.850	1.5	1.5	2.0	8.200	7.230	0.000	0.000
TILE MASON	BLD	27.100	27.850	1.5	1.5	2.0	8.200	7.230	0.000	0.000
TRUCK DRIVER	ALL 1	31.340	0.000	1.5	1.5	2.0	10.30	5.010	0.000	0.250
TRUCK DRIVER	ALL 2	31.780	0.000	1.5	1.5	2.0	10.30	5.010	0.000	0.250
TRUCK DRIVER	ALL 3	32.020	0.000	1.5	1.5	2.0	10.30	5.010	0.000	0.250
TRUCK DRIVER	ALL 4	32.280	0.000	1.5	1.5	2.0	10.30	5.010	0.000	0.250
TRUCK DRIVER	ALL 5	33.130	0.000	1.5	1.5	2.0	10.30	5.010	0.000	0.250
TRUCK DRIVER	O&C 1	25.070	0.000	1.5	1.5	2.0	10.30	5.010	0.000	0.250
TRUCK DRIVER	O&C 2	25.420	0.000	1.5	1.5	2.0	10.30	5.010	0.000	0.250
TRUCK DRIVER	O&C 3	25.620	0.000	1.5	1.5	2.0	10.30	5.010	0.000	0.250
TRUCK DRIVER	O&C 4	25.820	0.000	1.5	1.5	2.0	10.30	5.010	0.000	0.250
TRUCK DRIVER	O&C 5	26.500	0.000	1.5	1.5	2.0	10.30	5.010	0.000	0.250
TUCKPOINTER	BLD	29.250	30.250	1.5	1.5	2.0	8.200	8.330	0.000	0.580

Legend :

RG (Region)

TYP (Trade Type - All,Highway,Building,Floating,Oil & Chip,Rivers)

C (Class)

Base (Base Wage Rate)

FRMAN (Foreman Rate)

M-F>8 (OT required for any hour greater than 8 worked each day, Mon through Fri.

OSA (Overtime (OT) is required for every hour worked on Saturday)

OSH (Overtime is required for every hour worked on Sunday and Holidays)

H/W (Health & Welfare Insurance)

Pensn (Pension)

Vac (Vacation)

Trng (Training)

Explanations

BROWN COUNTY

The following list is considered as those days for which holiday rates of wages for work performed apply: New Years Day, Memorial Day, Fourth of July, Labor Day, Thanksgiving Day, Christmas Day and Veterans Day in some classifications/counties. Generally, any of these holidays which fall on a Sunday is celebrated on the following Monday. This then makes work performed on that Monday payable at the appropriate overtime rate for holiday pay. Common practice in a given local may alter certain days of celebration. If in doubt, please check with IDOL.

Oil and chip resealing (O&C) means the application of road oils and liquid asphalt to coat an existing road surface, followed by application of aggregate chips or gravel to coated surface, and subsequent rolling of material to seal the surface.

EXPLANATION OF CLASSES

ASBESTOS - GENERAL - removal of asbestos material/mold and hazardous materials from any place in a building, including mechanical systems where those mechanical systems are to be removed. This includes the removal of asbestos materials/mold and hazardous materials from ductwork or pipes in a building when the building is to be demolished at the time or at some close future date.

ASBESTOS - MECHANICAL - removal of asbestos material from mechanical systems, such as pipes, ducts, and boilers, where the mechanical systems are to remain.

CERAMIC TILE FINISHER, MARBLE FINISHER, TERRAZZO FINISHER

Assisting, helping or supporting the tile, marble and terrazzo mechanic by performing their historic and traditional work assignments required to complete the proper installation of the work covered by said crafts. The term "Ceramic" is used for naming the classification only and is in no way a limitation of the product handled. Ceramic takes into consideration most hard tiles.

ELECTRONIC SYSTEMS TECHNICIAN

Installation, service and maintenance of low-voltage systems which utilizes the transmission and/or transference of voice, sound, vision, or digital for commercial, education, security and entertainment purposes for the following: TV monitoring and surveillance, background/foreground music, intercom and telephone interconnect, field programming, inventory control systems, microwave transmission, multi-media, multiplex, radio page, school, intercom and sound burglar alarms and low voltage master clock systems.

Excluded from this classification are energy management systems, life safety systems, supervisory controls and data acquisition systems not intrinsic with the above listed systems, fire alarm systems, nurse call systems and raceways exceeding fifteen feet in length.

TRUCK DRIVER - BUILDING, HEAVY AND HIGHWAY CONSTRUCTION

Class 1. Drivers on 2 axle trucks hauling less than 9 ton. Air compressor and welding machines and brooms, including those pulled by separate units, truck driver helpers, warehouse employees, mechanic helpers, greasers and tiremen, pickup trucks when hauling materials, tools, or workers to and from and on-the-job site, and fork lifts up to 6,000 lb. capacity.

Class 2. Two or three axle trucks hauling more than 9 ton but hauling less than 16 ton. A-frame winch trucks, hydrolift trucks, vector trucks or similar equipment when used for transportation purposes. Fork lifts over 6,000 lb. capacity, winch trucks, four axle combination units, and ticket writers.

Class 3. Two, three or four axle trucks hauling 16 ton or more. Drivers on water pulls, articulated dump trucks, mechanics and working forepersons, and dispatchers. Five axle or more combination units.

Class 4. Low Boy and Oil Distributors.

Class 5. Drivers who require special protective clothing while employed on hazardous waste work.

TRUCK DRIVER - OIL AND CHIP RESEALING ONLY.

This shall encompass laborers, workers and mechanics who drive contractor or subcontractor owned, leased, or hired pickup, dump, service, or oil distributor trucks. The work includes transporting materials and equipment (including but not limited to, oils, aggregate supplies, parts, machinery and tools) to or from the job site; distributing oil or liquid asphalt and aggregate; stock piling material when in connection with the actual oil and chip contract. The Truck Driver (Oil & Chip Resealing) wage classification does not include supplier delivered materials.

OPERATING ENGINEERS - BUILDING

CLASS 1. Asphalt Screed Man; Aspco Concrete Spreaders; Asphalt Pavers; Asphalt Plant Engineer; Asphalt Rollers on Bituminous Concrete; Athey Loaders; Backfillers, Crane Type; Backhoes; Barber Green Loaders; Bulldozers; Cableways; Cherry Pickers; Clam Shells; C.M.I. & similar type autograde formless paver, autograde placer & finisher; Concrete Breakers; Concrete Pumps; Derricks; Derrick Boats; Draglines; Earth Auger or Boring Machines; Elevating Graders; Engineers on Dredges; Gravel Processing Machines; Head Equipment Greaser; High Lifts or Fork Lifts; Hoists with two or more drums or two or more load lines; Locomotives, All; Mechanics; Motor Graders or Auto Patrols; Operators or Leverman on Dredges; Operators, Power Boat; Operators, Pug Mill (Asphalt Plants); Orange Peels; Overhead Cranes; Paving Mixers; Piledrivers; Pipe Wrapping and Painting Machines; Pushdozers, or Push Cats; Robotic Controlled Equipment in this Classification; Rock Crushers; Ross Carrier or Similar Machines; Rotomill; Scoops, Skimmer, two cu. yd. capacity and under; Scoops, All or Tournapull; Sheep-Foot Roller (Self Propelled); Shovels; Skid Steer; Skimmer Scoops; Temporary Concrete Plant Operators; Test Hole Drilling Machines; Tower Machines; Tower Mixers; Track Type End Loaders; Track Type Fork Lifts or High Lifts; Track Jacks and Tampers; Tractors, Sideboom; Trenching or Ditching Machine; Tunnelluggers; Vermeer Type Saws; Water Blaster Cutting Head; Wheel Type End Loaders; Winch Cat.

CLASS 2. Air Compressors (six to eight)*; Asphalt Boosters and Heaters; Asphalt Distributors; Asphalt Plant Fireman; Oiler on Two Paving Mixers When Used in Tandem; Boom or Winch Trucks; Bull Floats or Flexplanes; Concrete Finishing Machine; Concrete Saws, Self-Propelled; Concrete Spreading Machines; Conveyors (six to eight)*; Generators (six to eight)*; Gravel or Stone Spreader, Power Operated; Hoist (with One Drum and One Load Line); Light Plants (six to eight)*; Mechanical Heaters (six to eight)*; Mud Jacks; Post Hole Digger, Mechanical; Pug Mills when used for other than Asphalt operation; Robotic Controlled Equipment in this Classification; Road or Street Sweeper, Self Propelled; Rollers (except bituminous concrete); Seaman Tiller; Straw Machine; Vibratory Compactor; Water Blaster, Power Unit; Welding Machines (six to eight)*; Well Drill Machines.

CLASS 3. Air Compressors(one to five)*; Air Compressors, Track or Self-Propelled; Automatic Hoist; Building Elevators; Bulk Cement Batching Plants; Conveyors (one to five)*; Concrete Mixers (Except Plant, Paver, or Tower); Firemen; Generators (one to five)*; Greasers; Helper on Single Paving Mixer; Hoist, Automatic; Light Plants (one to five)*; Mechanic Helpers; Mechanical Heaters (one to five)*; Oilers; Power Form Graders; Power Sub-Graders; Robotic Controlled Equipment in this Classification; Scissors Hoist; Tractors without power attachments regardless of size or type; Truck Crane Oiler and Driver (1 man); Vibratory Hammer (power source); Water Pumps (one to five)*;

Welding Machines (1/300 Amp. or over)*; Welding machines (one to five)*

CLASS 4. Lattice Boom Crawler Cranes; Lattice Boom Truck Cranes; Telescopic Truck-Mounted Cranes; Tower Cranes.

* Combinations of one to eight of any Air Compressors, Conveyors, Welding Machines, Water Pumps, Light Plants, or Generators shall be in batteries or within 400 feet and shall be paid as per the Classification Schedule contained in this Article.

OPERATING ENGINEERS - HIGHWAY

CLASS 1. Asphalt Screed Man; Asphco Concrete Spreaders; Asphalt Pavers; Asphalt Plant Engineer; Asphalt Rollers on Bituminous Concrete; Athey Loaders; Backhoes; Barber Green Loaders; Bulldozers; Cableways; Carry Deck Pickers; Cherry Pickers (Rough Terrain); C.M.I. & similar type-autograde formless paver, autograde placer & finisher; Concrete Breakers; Concrete Plant Operators; Concrete Pumps; Derricks; Derrick Boats; Dewatering Systems; Earth Auger or Boring Machines; Elevating Graders; Engineers on Dredges; Gravel Processing Machines; Grout Pump; Head Equipment Greaser; High Lifts or Fork Lifts; Hoists with two or more drums or two or more load lines; Hydro Jet or Hydro Laser; Locomotives, All; Mechanics; Motor Graders or Auto Patrols; Multi-Point Power Lifting Equipment; Operators or Leverman on Dredges; Operators, Power Boat; Operators, Pug Mill (Asphalt Plants); Overhead Cranes; Paving Mixers; Piledrivers; Pipe Wrapping and Painting Machines; Push-dozers, or Push Cats; Robotic Controlled Equipment in this Classification; Rock Crushers; Ross Carrier or Similar Machines; Roto-Mill; Scoops, Skimmer, two cu. yd. capacity and under; Sheep-Foot Roller (Self Pro-pelled); Shovels; Skid Steer; Skimmer Scoops; Test Hole Drilling Machines; Tower Machines; Tower Mixers; Track Type End Loaders; Track Type Fork Lifts or High Lifts; Track Jacks and Tampers; Tractors, Side-boom; Trenching or Ditching Machine; Tunnelluggers; Vermeer-Type Saws; Wheel Type End Loaders; Winch Cat; Scoops, All or Tournapull.

CLASS 2. Air Compressors (six to eight)*; Articulated Dumps; Asphalt Boosters and Heaters; Asphalt Distributors; Asphalt Plant Fireman; Boom or Winch Trucks; Building Elevators; Bull Floats or Flexplanes; Concrete Finishing Machine; Concrete Saws, Self-Propelled; Concrete Spreading Machines; Conveyors (six to eight)*; Generators (six to eight)*; Gravel or Stone Spreader, Power Operated; Hoist, Automatic; Hoist with One Drum and One Load Line; Light Plants (six to eight)*; Mechanical Heaters (six to eight)*; Mud Jacks; Off Road Water Wagons; Oiler on Two Paving Mixers When Used in Tandem; Post Hole Digger, Mechanical; Robotic Controlled Equipment in This Classification; Road or Street Sweeper, Self-Propelled; Rollers (except bituminous concrete); Scissor Hoist; Sea-man Tiller; Straw Machine; Vibratory Compactor; Water Pumps (six to eight)*; Well Drill Machines.

CLASS 3. Air Compressors (one to five)*; Air Compressors, Track or Self-Propelled; Bulk Cement Batching Plants; Conveyors (one to five)*; Concrete Mixers (Except Plant, Paver, or Tower); Firemen; Generators (one to five)*; Greasers; Helper on Single Paving Mixer; Light Plants (one to five)*; Mechanic Helpers; Mechanical Heaters (one to five)*; Oilers; Power Form Graders; Power Sub-Graders; Pug Mills when used for other than Asphalt operation; Robotic Controlled Equipment in This Classification; Tractors without power attachments, regardless of size or type; Truck Crane Oiler and Driver (1 man); Vibratory Hammer (power source); Water Pumps (one to five)*; Welding Machines (one 300 Amp. or over)*; Welding Machines (one to five)*.

CLASS 4. Lattice Boom Crawler Crane; Lattice Boom Truck Crane; Telescopic Truck-Mounted Crane; Tower Crane.

*Combinations of one to eight of any Air Compressors, Conveyors, Welding Machines, Water Pumps, Light Plants or Generators shall be in batteries or within 400 feet and shall be paid as per the Classification Schedule contained in this Article.

Other Classifications of Work:

For definitions of classifications not otherwise set out, the Department generally has on file such definitions which are available. If a task to be performed is not subject to one of the classifications of pay set out, the Department will upon being contacted state which neighboring county has such a classification and provide such rate, such rate being deemed to exist by reference in this document. If no neighboring county rate applies to the task, the Department shall undertake a special determination, such special determination being then deemed to have existed under this determination. If a project requires these, or any classification not listed, please contact IDOL at 217-782-1710 for wage rates or clarifications.

LANDSCAPING

Landscaping work falls under the existing classifications for laborer, operating engineer and truck driver. The work performed by landscape plantsman and landscape laborer is covered by the existing classification of laborer. The work performed by landscape operators (regardless of equipment used or its size) is covered by the classifications of operating engineer. The work performed by landscape truck drivers (regardless of size of truck driven) is covered by the classifications of truck driver.

Bureau County Prevailing Wage for May 2013

(See explanation of column headings at bottom of wages)

Trade Name	RG	TYP	C	Base	FRMAN	M-F>8	OSA	OSH	H/W	Pensn	Vac	Trng
ASBESTOS ABT-GEN	==	===	=	=====	=====	=====	===	===	=====	=====	=====	=====
ASBESTOS ABT-GEN		ALL		29.530	30.780	1.5	1.5	2.0	8.240	8.630	0.000	0.800
ASBESTOS ABT-MEC		BLD		34.160	36.660	1.5	1.5	2.0	10.82	10.66	0.000	0.720
BOILERMAKER		BLD		35.010	38.010	2.0	2.0	2.0	7.070	13.83	0.000	0.300
BRICK MASON		BLD		36.720	37.720	1.5	1.5	2.0	8.720	7.950	0.000	0.580
CARPENTER		BLD		30.250	32.370	1.5	1.5	2.0	8.900	13.68	0.000	0.570
CARPENTER		HWY		30.250	32.000	1.5	1.5	2.0	8.830	13.34	0.000	0.500
CEMENT MASON		ALL		35.000	36.250	2.0	2.0	2.0	7.700	11.67	0.000	0.500
CERAMIC TILE FNSHER		BLD		32.410	0.000	1.5	1.5	2.0	7.700	4.840	0.000	0.530
COMMUNICATION TECH		BLD		31.200	32.700	1.5	1.5	2.0	12.32	10.77	0.000	0.320
ELECTRIC PWR EQMT OP		ALL		35.440	0.000	1.5	1.5	2.0	5.000	10.98	0.000	0.270
ELECTRIC PWR GRNDMAN		ALL		24.320	0.000	1.5	1.5	2.0	5.000	7.540	0.000	0.180
ELECTRIC PWR LINEMAN		ALL		39.370	41.910	1.5	1.5	2.0	5.000	12.20	0.000	0.300
ELECTRIC PWR TRK DRV		ALL		25.510	0.000	1.5	1.5	2.0	5.000	7.920	0.000	0.190
ELECTRICIAN		BLD		37.950	41.370	1.5	1.5	2.0	13.17	15.06	0.000	1.200
ELEVATOR CONSTRUCTOR		BLD		39.380	44.300	2.0	2.0	2.0	11.88	12.71	3.150	0.600
GLAZIER		BLD		30.770	32.770	1.5	1.5	2.0	9.700	7.700	0.000	1.250
HT/FROST INSULATOR		BLD		45.550	48.050	1.5	1.5	2.0	10.82	11.86	0.000	0.720

IRON WORKER		ALL		38.500	39.500	2.0	2.0	2.0	9.390	18.84	0.000	0.700
LABORER		ALL		28.530	29.780	1.5	1.5	2.0	8.240	8.630	0.000	0.800
LABORER, SKILLED		ALL		28.930	30.180	1.5	1.5	2.0	8.240	8.630	0.000	0.800
LATHER		BLD		30.250	32.370	1.5	1.5	2.0	8.900	13.68	0.000	0.570
MACHINIST		BLD		43.550	46.050	1.5	1.5	2.0	6.130	8.950	1.850	0.000
MARBLE FINISHERS		BLD		32.410	0.000	1.5	1.5	2.0	7.700	4.840	0.000	0.530
MARBLE MASON		BLD		35.090	35.340	1.5	1.5	2.0	7.700	7.150	0.000	0.560
MILLWRIGHT		BLD		34.400	37.840	1.5	1.5	2.0	8.770	13.85	0.000	0.500
OPERATING ENGINEER	E	BLD	1	43.300	47.300	2.0	2.0	2.0	15.70	10.55	1.900	1.250
OPERATING ENGINEER	E	BLD	2	42.000	47.300	2.0	2.0	2.0	15.70	10.55	1.900	1.250
OPERATING ENGINEER	E	BLD	3	39.450	47.300	2.0	2.0	2.0	15.70	10.55	1.900	1.250
OPERATING ENGINEER	E	BLD	4	37.700	47.300	2.0	2.0	2.0	15.70	10.55	1.900	1.250
OPERATING ENGINEER	E	BLD	5	46.300	47.300	2.0	2.0	2.0	15.70	10.55	1.900	1.250
OPERATING ENGINEER	E	BLD	6	46.300	47.300	2.0	2.0	2.0	15.70	10.55	1.900	1.250
OPERATING ENGINEER	E	BLD	7	44.300	47.300	2.0	2.0	2.0	15.70	10.55	1.900	1.250
OPERATING ENGINEER	E	HWY	1	43.300	47.300	1.5	1.5	2.0	15.70	10.55	1.900	1.250
OPERATING ENGINEER	E	HWY	2	42.750	47.300	1.5	1.5	2.0	15.70	10.55	1.900	1.250
OPERATING ENGINEER	E	HWY	3	40.700	47.300	1.5	1.5	2.0	15.70	10.55	1.900	1.250
OPERATING ENGINEER	E	HWY	4	39.300	47.300	1.5	1.5	2.0	15.70	10.55	1.900	1.250
OPERATING ENGINEER	E	HWY	5	38.100	47.300	1.5	1.5	2.0	15.70	10.55	1.900	1.250
OPERATING ENGINEER	E	HWY	6	46.300	47.300	1.5	1.5	2.0	15.70	10.55	1.900	1.250
OPERATING ENGINEER	E	HWY	7	44.300	47.300	1.5	1.5	2.0	15.70	10.55	1.900	1.250
OPERATING ENGINEER	W	BLD	1	36.000	39.000	1.5	1.5	2.0	9.750	13.60	0.000	3.000
OPERATING ENGINEER	W	BLD	2	33.490	39.000	1.5	1.5	2.0	9.750	13.60	0.000	3.000
OPERATING ENGINEER	W	BLD	3	29.340	39.000	1.5	1.5	2.0	9.750	13.60	0.000	3.000
OPERATING ENGINEER	W	HWY	1	36.000	39.500	1.5	1.5	2.0	9.750	13.60	0.000	3.000
OPERATING ENGINEER	W	HWY	2	33.490	39.500	1.5	1.5	2.0	9.750	13.60	0.000	3.000
OPERATING ENGINEER	W	HWY	3	29.340	39.500	1.5	1.5	2.0	9.750	13.60	0.000	3.000
PAINTER		ALL		32.900	34.900	1.5	1.5	1.5	9.650	8.200	0.000	1.250
PAINTER SIGNS		BLD		33.920	38.090	1.5	1.5	1.5	2.600	2.710	0.000	0.000
PILEDRIVER		BLD		30.500	33.550	1.5	1.5	2.0	8.900	13.68	0.000	0.570
PILEDRIVER		HWY		30.250	32.000	1.5	1.5	2.0	8.830	13.34	0.000	0.500
PIPEFITTER		BLD		45.050	48.050	1.5	1.5	2.0	8.460	14.85	0.000	1.780
PLASTERER		BLD		35.000	36.250	2.0	2.0	2.0	7.700	11.67	0.000	0.500
PLUMBER		BLD		45.000	47.000	1.5	1.5	2.0	12.53	10.06	0.000	0.880
ROOFER		BLD		30.210	32.210	1.5	1.5	2.0	8.280	8.770	0.000	0.430
SHEETMETAL WORKER		BLD		35.360	37.010	1.5	1.5	2.0	8.020	12.70	0.000	0.650
SPRINKLER FITTER		BLD		36.390	39.140	1.5	1.5	2.0	8.420	8.500	0.000	0.450
STONE MASON		BLD		36.720	37.720	1.5	1.5	2.0	8.720	7.950	0.000	0.580
TERRAZZO FINISHER		BLD		32.410	0.000	1.5	1.5	2.0	7.700	4.840	0.000	0.530
TILE LAYER		BLD		30.250	32.370	1.5	1.5	2.0	8.900	13.68	0.000	0.570
TILE MASON		BLD		35.090	35.340	1.5	1.5	2.0	7.700	7.150	0.000	0.560
TRUCK DRIVER		ALL	1	31.230	0.000	1.5	1.5	2.0	10.30	4.840	0.000	0.250
TRUCK DRIVER		ALL	2	31.680	0.000	1.5	1.5	2.0	10.30	4.840	0.000	0.250
TRUCK DRIVER		ALL	3	31.890	0.000	1.5	1.5	2.0	10.30	4.840	0.000	0.250
TRUCK DRIVER		ALL	4	32.180	0.000	1.5	1.5	2.0	10.30	4.840	0.000	0.250
TRUCK DRIVER		ALL	5	33.020	0.000	1.5	1.5	2.0	10.30	4.840	0.000	0.250
TRUCK DRIVER		O&C	1	24.980	0.000	1.5	1.5	2.0	10.30	4.840	0.000	0.250
TRUCK DRIVER		O&C	2	25.340	0.000	1.5	1.5	2.0	10.30	4.840	0.000	0.250
TRUCK DRIVER		O&C	3	25.510	0.000	1.5	1.5	2.0	10.30	4.840	0.000	0.250
TRUCK DRIVER		O&C	4	25.740	0.000	1.5	1.5	2.0	10.30	4.840	0.000	0.250
TRUCK DRIVER		O&C	5	26.420	0.000	1.5	1.5	2.0	10.30	4.840	0.000	0.250
TUCKPOINTER		BLD		36.720	37.720	1.5	1.5	2.0	8.720	7.950	0.000	0.580

Legend :

RG (Region)

TYP (Trade Type - All,Highway,Building,Floating,Oil & Chip,Rivers)

C (Class)

Base (Base Wage Rate)

FRMAN (Foreman Rate)

M-F>8 (OT required for any hour greater than 8 worked each day, Mon through Fri.)

OSA (Overtime (OT) is required for every hour worked on Saturday)

OSH (Overtime is required for every hour worked on Sunday and Holidays)

H/W (Health & Welfare Insurance)

Pensn (Pension)

Vac (Vacation)

Trng (Training)

Explanations

BUREAU COUNTY

OPERATING ENGINEERS (EAST) - That part of the county East of Route 26.

The following list is considered as those days for which holiday rates of wages for work performed apply: New Years Day, Memorial Day, Fourth of July, Labor Day, Thanksgiving Day, Christmas Day and Veterans Day in some classifications/counties. Generally, any of these holidays which fall on a Sunday is celebrated on the following Monday. This then makes work performed on that Monday payable at the appropriate overtime rate for holiday pay. Common practice in a given local may alter certain days of celebration. If in doubt, please check with IDOL.

Oil and chip resealing (O&C) means the application of road oils and liquid asphalt to coat an existing road surface, followed by application of aggregate chips or gravel to coated surface, and subsequent rolling of material to seal the surface.

EXPLANATION OF CLASSES

ASBESTOS - GENERAL - removal of asbestos material/mold and hazardous materials from any place in a building, including mechanical systems where those mechanical systems are to be removed. This includes the removal of asbestos materials/mold and hazardous materials from ductwork or pipes in a building when the building is to be demolished at the time or at some close future date.

ASBESTOS - MECHANICAL - removal of asbestos material from mechanical systems, such as pipes, ducts, and boilers, where the mechanical systems are to remain.

CERAMIC TILE FINISHER, MARBLE FINISHER, TERRAZO FINISHER

Assisting, helping or supporting the tile, marble and terrazzo mechanic by performing their historic and traditional work assignments required to complete the proper installation of the work covered by said crafts. The term "Ceramic" is used for naming the classification only and is in no way a limitation of the product handled. Ceramic takes into consideration most hard tiles.

COMMUNICATION TECHNICIAN

Installation, operation, inspection, maintenance, repair and service

of radio, television, recording, voice, sound and vision production and reproduction, telephone and telephone interconnect, facsimile, equipment and appliances used for domestic, commercial, educational and entertainment purposes, pulling of wire through conduit but not the installation of conduit.

LABORER, SKILLED - BUILDING AND HIGHWAY

The skilled laborer building (BLD) and heavy & highway (HWY) classification shall encompass the following types of work, irrespective of the site of the work: flagging, caisson worker plus depth, gunnite nozzle men, lead man on sewer work, welders, cutter burners and torchmen, chain saw operator, paving breaker, jackhammer and drill operators, layout man and/or drainage tile layer, steel form setter - street and highway, air tamping hammerman, signal man on crane, concrete saw operator, concrete saw operator walk behind, screenman on asphalt pavers, front end man on chip spreader, laborers tending masons with hot material or where foreign materials are used, multiple concrete duct - leadman, luteman, asphalt raker, curb asphalt machine operator, ready mix scalemen (permanent, portable or temporary plant), laborers handling masterplate or similar materials, laser beam operator, coring machine operator, plaster tenders, underpinning and shoring of buildings, material selector when working with fire-brick or castable material, fire watch, signaling of all power equipment, tree topper or trimmer when in connection with construction, and diver tender.

OPERATING ENGINEERS - BUILDING (East)

Class 1. Mechanic; Asphalt Plant; Asphalt Spreader; Autograde; Backhoes w/Caisson attachment; Batch Plant; Benoto (require 2 engineers); Boiler and Throttle Valve; Caisson Rigs; Central Redi-Mix Plant; Combination Back Hoe Front End-Loader Machine; Compressor and Throttle Valve; Concrete Breaker (Truck Mounted); Concrete Conveyor; Concrete Paver over 27E cu. ft.; Concrete Paver 27E cu.ft. and under; Concrete Placer; Concrete Pump (Truck Mounted); Concrete Tower; Cranes, All; Cranes Hammerhead; Creter Crane; Spider Crane; Crusher, Stone, etc.; Derricks, All; Derricks, Traveling; Formless Curb and Gutter Machine; Grader, Elevating; Grouting Machines; Heavy Duty Self-Propelled Transporter or Prime Mover; Highlift Shovels or Front Endloader 2-1/4 yd. and over; Hoists, Elevators, outside type rack and pinion and similar machines; Hoists, One, Two and Three Drum; Hoists, Two Tugger One Floor; Hydraulic Backhoes; Hydraulic Boom Trucks; Hydro Vac (and similar equipment); Locomotives, All; Lubrication Technician; Manipulators; Motor Patrol; Pile Drivers and Skid Rig; Post Hole Digger; Pre-Stress Machine; Pump Cretes Dual Ram; Squeeze Cretes - Screw Type Pumps; Gypsum Bulker and Pump; Roto Mill Grinder; Scoops - Tractor Drawn; Slip-Form Paver; Straddle Buggies; Operation or Tieback Machine; Tournapull; Tractor with Boom and Side Boom; Trenching Machines.

Class 2. Boilers; Brick Forklift servicing seven (7) or more Brick Masons; Broom, All Power Propelled; Bulldozers; Concrete Mixer (Two Bag and Over); Conveyor, Portable; Forklift Trucks; Highlift Shovels or Front Endloaders under 2-1/4 yd; Hoists, Automatic; Hoists, inside Freight Elevators; Hoists, Sewer Dragging Machine; Hoists, Tugger Single Drum; Hydro Excavating (excluding hose work); Laser Screed; Rock Drill (self-propelled); Non Self-Loading Ejection Dump; Rock Drill (Truck Mounted); Rollers, All; Steam Generators; Tractors, All; Tractor Drawn Vibratory Roller; Winch Trucks with "A" Frame.

Class 3. Air Compressors; Combination - Small Equipment Operator; Generators; Heaters, Mechanical; Hoists, Inside Elevators - (Rheostat Manual Controlled); Hoists, Inside Elevators; Hydraulic Power Units

(Pile Driving and Extracting); Lowboys; Pumps, over 3" (1 to 3 not to exceed a total of 300 ft.); Pumps, Well Points; Welding Machines (2 through 5); Winches, 4 Small Electric Drill Winches.

Class 4. Brick Forklift; Boom Trucks (Residential); Hoists, Inside Elevators push button with automatic doors; Oilers; Skidsteer Loaders; Vacuum Trucks (excluding hose work).

Class 5. Assistant Craft Foreman

Class 6. Mechanics and Welders

Class 7. Gradall

OPERATING ENGINEERS - HIGHWAY CONSTRUCTION (East)

Class 1. Asphalt Plant; Asphalt Heater and Planer Combination; Asphalt Heater Scarfire; Asphalt Spreader; Autograder/Gomaco or other similar type machines: ABG Paver; Backhoes with Caisson Attachment; Belt Loader; Caisson Rigs; Car Dumper; Central Redi-Mix Plant; Combination Backhoe Front Endloader Machine; Concrete Breaker (Truck Mounted); Concrete Conveyor; Concrete Paver over 27E cu. ft.; Concrete Placer; Concrete Tube Float; Cranes, all attachments; Cranes, Tower of all types; Creter Crane; Spider Crane; Crusher, Stone, etc.; Derricks, All; Derrick Boats; Derricks, Traveling; Dredges; Elevators, Outside Type Rack & Pinion and Similar Machines; Formless Curb and Gutter Machine; Grader, Elevating; Grader, Motor Grader, Motor Patrol, Auto Patrol, Form Grader, Pull Grader, Subgrader; Guard Rail Post Driver Truck Mounted; Heavy Duty Self-Propelled Transporter or Prime Mover; Hoists, One, Two and Three Drum; Hydraulic Backhoes; Locomotives, All; Backhoes with Shear Attachments; Lubrication Technician; Manipulators; Mucking Machine; Pile Drivers and Skid Rig; Pre-Stress Machine; Pump Cretes Dual Ram; Rock Drill-Crawler or Skid Rig; Rock Drill - Truck Mounted; Roto Mill Grinder; Slip-Form Paver; Snow Melters; Soil Test Drill Rig (Truck Mounted); Straddle Buggies; Hydraulic Telescoping Form (Tunnel); Operation of Tieback Machine; Tractor Drawn Belt Loader; Tractor Drawn Belt Loader with attached pusher; Tractor with Boom; Tractaire with Attachments; Transfer Barrier Transfer Machine; Trenching Machine; Truck Mounted Concrete Pump with Boom; Raised or Blind Hole Drills (Tunnel Shaft); Underground Boring and/or Mining Machine; Wheel Excavator; Widener (APSCO).

Class 2. Batch Plant; Bituminous Mixer; Boiler and Throttle Valve; Bulldozers; Car Loader Trailing Conveyors; Combination Backhoe Front Endloader Machine (less than 1 cu. yd. Backhoe Bucket or over or with attachments); Compressor and Throttle Valve; Compressor, Common Receiver (3); Concrete Breaker or Hydro Hammer; Concrete Grinding Machine; Concrete Mixer or Paver 7S Series to and including 27 cu. ft.; Concrete Spreader; Concrete Curing Machine, Burlap Machine, Belting Machine and Sealing Machine; Concrete Wheel Saw; Conveyor Muck Cars (Haglund or Similar Type); Drills, All; Finishing Machine - Concrete; Forklifts; Highlift Shovels or Front Endloader; Hoist - Sewer Dragging Machine; Hydraulic Boom Trucks (All Attachments); Hydro-Blaster (requires 2 operators; one being Class 4); Hydro Excavating (excluding hose work); Laser Screed; Locomotives, Dinky; Oil Distributor; Off-Road Hauling Units (Including Articulating); Non Self-Loading Ejection Dump; Pump Cretes; Squeeze Cretes - Screw Type Pumps, Gypsum Bulker and Pump; Roller, Asphalt; Rotary Snow Plows; Rototiller, Seaman, etc., Self-Propelled; Self-Propelled Compactor; Spreader - Chip - Stone, etc.; Scraper; Scraper - Prime Mover in Tandem; Tractors, Push, Pulling Sheeps Foot, Disc, Compactor, etc.; Tug Boats; Mechanic Welders working in permanent shop.

Class 3. Boilers; Brooms, All Power Propelled; Cement Supply Tender; Compressor, Common Receiver (2); Concrete Mixer (Two Bag and Over); Conveyor, Portable; Farm-Type Tractors Used for Mowing, Seeding, etc.; Grouting Machine; Hoists, Automatic; Hoists, All Elevators; Hoists, Tugger Single Drum; Jeep Diggers; Low Boys; Pipe Jacking Machine; Post-Hole Digger; Power Saw, Concrete Power Driven; Pug Mills; Rollers, other than asphalt; Seed and Straw Blower; Steam Generators; Stump Machine Heaters, Mechanical; Winch Trucks with "A" Frame; Work Boats; Tamper - Form - Motor Driven.

Class 4. Air Compressor; Brick Forklifts (Servicing Seven (7) or more Brick Masons; Combination - Small Equipment Operator; Directional Boring Machine; Generators; Heaters, Mechanical; Hydraulic Power Unit (Pile Driving, Extracting, or Drilling); Hydro-Blaster (requires 2 operators - one being class 2); Light Plants, All (1 through 5); Pumps, over 3" (1 to 3 not to exceed a total of 300 ft.); Pumps, Well Points; Tractaire; Vacuum Trucks (excluding hose work); Welding Machines (2 through 5); Winches, 4 Small Electric Drill Winches.

Class 5. Brick Forklifts; Oilers; Skidsteer Loaders (All).

Class 6. Field Mechanics and Field Welders.

Class 7. Dowell Machine with Air Compressor; Gradall and machines of like nature.

OPERATING ENGINEERS - BUILDING - (West)

Class 1. Cranes; Overhead Cranes; Gradall; All Cherry Pickers; Mechanics; Central Concrete Mixing Plant Operator; Road Pavers (27E - Dual Drum - Tri Batchers); Blacktop Plant Operators and Plant Engineers; 3 Drum Hoist; Derricks; Hydro Cranes; Shovels; Skimmer Scoops; Koehring Scooper; Drag Lines; Backhoe; Derrick Boats; Pile Drivers and Skid Rigs; Clamshells; Locomotive Cranes; Dredge (all types) Motor Patrol; Power Blades - Dumore - Elevating and similar types; Tower Cranes (Crawler-Mobile) and Stationary; Crane-type Backfiller; Drott Yumbo and similar types considered as Cranes; Caisson Rigs; Dozer; Tournadozer; Work Boats; Ross Carrier; Helicopter; Tournapulls - all and similar types; Scoops (all sizes); Pushcats; Endloaders (all types); Asphalt Surfacing Machine; Slip Form Paver; Rock Crusher; Heavy Equipment Greaser; CMI, CMI Belt Placer, Auto Grade & 3 Track and similar types; Side Booms; Multiple Unit Earth Movers; Creter Crane; Trench Machine; Pump-crete-Belt Crete-Squeeze Cretes-Screw-type Pumps and Gypsum; Bulker & Pump - Operator will clean; Formless Finishing Machine; Flaherty Spreader or similar types; Screed Man on Laydown Machine; Wheel Tractors (industrial or Farm-type w/Dozer-Hoe-Endloader or other attachments); F.W.D. & Similar Types; Vermeer Concrete Saw.

Class 2. Dinkeys; Power Launches; PH One-pass Soil Cement Machine (and similar types); Pugmill with Pump; Backfillers; Euclid Loader; Forklifts; Jeeps w/Ditching Machine or other attachments; Tuneluger; Automatic Cement and Gravel Batching Plants; Mobile Drills (Soil Testing) and similar types; Gurries and Similar Types; (1) and (2) Drum Hoists (Buck Hoist and Similar Types); Chicago Boom; Boring Machine & Pipe Jacking Machine; Hydro Boom; Dewatering System; Straw Blower; Hydro Seeder; Assistant Heavy Equipment Greaser on Spread; Tractors (Track type) without Power Unit pulling Rollers; Rollers on Asphalt -- Brick Macadem; Concrete Breakers; Concrete Spreaders; Mule Pulling Rollers; Center Stripper; Cement Finishing Machines & CMI Texture & Reel Curing Machines; Cement Finishing Machine; Barber Green or similar loaders; Vibro Tamper (All similar types) Self-propelled; Winch or Boom Truck; Mechanical Bull Floats; Mixers over 3 Bag to 27E; Tractor pulling Power Blade or Elevating Grader; Porter Rex Rail;

Clary Screed; Truck Type Hoptoe Oilers; Fireman; Spray Machine on Paving; Curb Machines; Truck Crane Oilers; Oil Distributor; Truck-Mounted Saws; Directional boring machine.

Class 3. Air Compressor; Power Subgrader; Straight Tractor; Trac Air without attachments; Herman Nelson Heater, Dravo, Warner, Silent Glo, and similar types; Roller: Five (5) Ton and under on Earth or Gravel; Form Grader; Crawler Crane & Skid Rig Oilers; Freight Elevators - permanently installed; Pump; Light Plant; Generator; Conveyor (1) or (2) - Operator will clean; Welding Machine; Mixer (3) Bag and Under (Standard Capacity with skip); Bulk Cement Plant; Oiler on Central Concrete Mixing Plant; Straight framed articulating end dump vehicle; Truck mounted vac unit (separately powered).

OPERATING ENGINEERS - HEAVY AND HIGHWAY CONSTRUCTION - (West)

CLASS 1. Cranes; Hydro Cranes; Shovels; Crane Type Backfiller; Tower, Mobile, Crawler, & Stationary Cranes; Derricks; Hoists (3 Drum); Draglines; Drott Yumbo & Similar Types considered as Cranes; 360 Degree Swing Excavator (Shears, Grapples, Movacs, etc.); Back Hoe; Derrick Boats; Pile Driver and Skid Rigs; Clam Shell; Locomotive - Cranes; Road Pavers - Single Drum - Dual Drum - Tri Batcher; Motor Patrols & Power Blades - Dumore - Elevating & Similar Types; Mechanics; Central Concrete Mixing Plant Operator; Asphalt Batch Plant Operators and Plant Engineers; Gradall; Caisson Rigs; Skimmer Scoop - Koering Scooper; Dredges (all types); Hoptoe; All Cherry Pickers; Work Boat; Ross Carrier; Helicopter; Dozer; Tournadozer; Tournapulls - all and similar types; Operation of Concrete and all Recycle Machines; Multiple Unit Earth Movers; Scoops (all sizes); Pushcats; Endloaders (all types); Asphalt Surfacing Machine; Slip Form Paver; Rock Crusher; Operation of Material Crusher, Screening Plants, and Tunnel Boring Machine; Heavy Equipment Greaser (top greaser on spread); CMI, Auto Grade, CMI Belt Placer & 3 Track and Similar Types; Side Booms; Asphalt Heater & Planer Combination (used to plane streets); Wheel Tractors (with Dozer, Hoe or Endloader Attachments); CAT Earthwork Compactors and Similar Types; Blaw Knox Spreader and Similar Types; Trench Machines; Pump Crete - Belt Crete - Squeeze Crete - Screw Type Pumps and Gypsum (operator will clean); Creter Crane; Operation of Concrete Pump Truck; Formless Finishing Machines; Flaherty Spreader or Similar Types; Screed Man on Laydown Machine; Vermeer Concrete Saw; Operation of Laser Screed; Span Saw; Dredge Leverman; Dredge Engineer; Lull or Similar Type; Hydro-Boom Truck; Operation of Guard Rail Machine; and Starting Engineer on Pipeline or Construction (11 or more pieces) including: Air Compressor (Trailer Mounted), All Forced Air Heaters (regardless of Size), Water Pumps (Greater than 4-1/2" or Total Discharge Over 4-1/2"), Light Plants, Generators (Trailer Mounted - Excluding Decontamination Trailer), Welding Machines (Any Size or Mode of Power), Conveyor, Mixer (any size), Stud Welder, Power Pac, etc, and Ground Heater (Trailer Mounted).

CLASS 2. Bulker & Pump; Power Launches; Boring Machine & Pipe Jacking Machine; Dinkeys; Operation of Carts, Powered Haul Unit for a Boring Machine; P & H One Pass Soil Cement Machines and Similar Types; Wheel Tractors (Industry or Farm Type - Other); Back Fillers; Euclid Loader; Fork Lifts; Jeep w/Ditching Machine or Other Attachments; Tunneluger; Automatic Cement & Gravel Batching Plants; Mobile Drills - Soil Testing and Similar Types; Pugmill with Pump; All (1) and (2) Drum Hoists; Dewatering System; Straw Blower; Hydro-Seeder; Bump Grinders (self-propelled); Assistant Heavy Equipment Greaser; Apsco Spreader; Tractors (Track-Type) without Power Units Pulling Rollers; Rollers on Asphalt - Brick or Macadam; Concrete Breakers; Concrete Spreaders; Cement Strippers; Cement Finishing Machines & CMI Texture & Reel Curing Machines; Vibro-Tampers (All Similar Types Self-Propelled); Mechanical Bull Floats; Self-Propelled Concrete Saws; Truck Mounted

Power Saws; Operation of Curb Cutters; Mixers - Over Three (3) Bags; Winch and Boom Trucks; Tractor Pulling Power Blade or Elevating Grader; Porter Rex Rail; Clary Screed; Mule Pulling Rollers; Pugmill without Pump; Barber Greene or Similar Loaders; Track Type Tractor w/Power Unit attached (minimum); Fireman; Spray Machine on Paving; Curb Machines; Paved Ditch Machine; Power Broom; Self-Propelled Sweepers; Self-Propelled Conveyors; Power Subgrader; Oil Distributor; Straight Tractor; Truck Crane Oiler; Truck Type Oilers; Directional Boring Machine; Horizontal Directional Drill; Articulating End Dump Vehicles; Starting Engineer on Pipeline or Construction (6 -10 pieces) including: Air Compressor (Trailer Mounted), All Forced Air Heaters (regardless of Size), Water Pumps (Greater than 4-1/2" or Total Discharge Over 4-1/2"), Light Plants, Generators (Trailer Mounted - Excluding Decontamination Trailer), Welding Machines (Any Size or Mode of Power), Conveyor, Mixer (any size), Stud Welder, Power Pac, etc., and Ground Heater (Trailer Mounted).

CLASS 3. Straight Framed Truck Mounted Vac Unit (separately powered); Trac Air Machine (without attachments); Rollers - Five Ton and Under on Earth and Gravel; Form Graders; Bulk Cement Plant; Oilers; and Starting Engineer on Pipeline or Construction (3 - 5 pieces) including: Air Compressor (Trailer Mounted), All Forced Air Heaters (regardless of Size), Water Pumps (Greater than 4-1/2" or Total Discharge Over 4-1/2"), Light Plants, Generators (Trailer Mounted - Excluding Decontamination Trailer), Welding Machines (Any Size or Mode of Power), Conveyor, Mixer (any size), Stud Welder, Power Pac, etc., and Ground Heater (Trailer Mounted).

TRUCK DRIVER - BUILDING, HEAVY AND HIGHWAY CONSTRUCTION

Class 1. Drivers on 2 axle trucks hauling less than 9 ton. Air compressor and welding machines and brooms, including those pulled by separate units, truck driver helpers, warehouse employees, mechanic helpers, greasers and tiremen, pickup trucks when hauling materials, tools, or workers to and from and on-the-job site, and fork lifts up to 6,000 lb. capacity.

Class 2. Two or three axle trucks hauling more than 9 ton but hauling less than 16 ton. A-frame winch trucks, hydrolift trucks, vector trucks or similar equipment when used for transportation purposes. Fork lifts over 6,000 lb. capacity, winch trucks, four axle combination units, and ticket writers.

Class 3. Two, three or four axle trucks hauling 16 ton or more. Drivers on water pulls, articulated dump trucks, mechanics and working forepersons, and dispatchers. Five axle or more combination units.

Class 4. Low Boy and Oil Distributors.

Class 5. Drivers who require special protective clothing while employed on hazardous waste work.

TRUCK DRIVER - OIL AND CHIP RESEALING ONLY.

This shall encompass laborers, workers and mechanics who drive contractor or subcontractor owned, leased, or hired pickup, dump, service, or oil distributor trucks. The work includes transporting materials and equipment (including but not limited to, oils, aggregate supplies, parts, machinery and tools) to or from the job site; distributing oil or liquid asphalt and aggregate; stock piling material when in connection with the actual oil and chip contract. The Truck Driver (Oil & Chip Resealing) wage classification does not include supplier delivered materials.

Other Classifications of Work:

For definitions of classifications not otherwise set out, the Department generally has on file such definitions which are available. If a task to be performed is not subject to one of the classifications of pay set out, the Department will upon being contacted state which neighboring county has such a classification and provide such rate, such rate being deemed to exist by reference in this document. If no neighboring county rate applies to the task, the Department shall undertake a special determination, such special determination being then deemed to have existed under this determination. If a project requires these, or any classification not listed, please contact IDOL at 217-782-1710 for wage rates or clarifications.

LANDSCAPING

Landscaping work falls under the existing classifications for laborer, operating engineer and truck driver. The work performed by landscape plantsman and landscape laborer is covered by the existing classification of laborer. The work performed by landscape operators (regardless of equipment used or its size) is covered by the classifications of operating engineer. The work performed by landscape truck drivers (regardless of size of truck driven) is covered by the classifications of truck driver.

Calhoun County Prevailing Wage for May 2013

(See explanation of column headings at bottom of wages)

Trade Name	RG	TYP	C	Base	FRMAN	M-F>8	OSA	OSH	H/W	Pensn	Vac	Trng
=====	==	===	=	=====	=====	=====	===	===	=====	=====	=====	=====
ASBESTOS ABT-GEN		ALL		30.860	31.360	1.5	1.5	2.0	5.750	9.840	0.000	0.800
ASBESTOS ABT-MEC		BLD		29.860	30.860	1.5	1.5	2.0	6.950	3.000	0.000	0.000
BOILERMAKER		BLD		31.500	34.000	1.5	1.5	2.0	7.070	18.73	1.000	0.350
BRICK MASON		BLD		29.280	33.160	1.5	1.5	2.0	7.750	9.430	2.000	0.400
CARPENTER		ALL		34.630	36.130	1.5	1.5	2.0	6.550	6.750	0.000	0.400
CEMENT MASON		ALL		31.000	32.000	1.5	1.5	2.0	9.250	11.75	0.000	0.200
CERAMIC TILE FNSHER		BLD		25.890	0.000	1.5	1.5	2.0	6.000	5.200	0.000	0.530
ELECTRIC PWR EQMT OP		ALL		36.690	44.520	1.5	2.0	2.0	5.000	9.170	0.000	0.280
ELECTRIC PWR GRNDMAN		ALL		24.940	44.520	1.5	2.0	2.0	5.000	6.240	0.000	0.190
ELECTRIC PWR LINEMAN		ALL		42.210	44.520	1.5	2.0	2.0	5.000	10.56	0.000	0.320
ELECTRIC PWR TRK DRV		ALL		25.560	44.520	1.5	2.0	2.0	5.000	6.390	0.000	0.190
ELECTRICIAN		ALL		36.400	38.650	1.5	1.5	2.0	7.500	9.090	0.000	0.550
ELECTRONIC SYS TECH		BLD		28.740	30.490	1.5	1.5	2.0	7.500	5.860	0.000	0.400
FLOOR LAYER		BLD		29.330	30.080	1.5	1.5	2.0	6.550	6.750	0.000	0.400
GLAZIER		BLD		32.780	0.000	2.0	2.0	2.0	9.020	10.80	2.630	0.310
HT/FROST INSULATOR		BLD		37.260	38.260	1.5	1.5	2.0	7.850	11.16	0.000	0.500
IRON WORKER		ALL		31.500	33.500	1.5	1.5	2.0	7.610	13.33	0.000	0.420
LABORER		ALL		30.360	30.860	1.5	1.5	2.0	5.750	9.840	0.000	0.800
MACHINIST		BLD		43.550	46.050	1.5	1.5	2.0	6.130	8.950	1.850	0.000
MARBLE FINISHERS		BLD		25.890	0.000	1.5	1.5	2.0	6.000	5.200	0.000	0.530
MILLWRIGHT		ALL		34.630	36.130	1.5	1.5	2.0	6.550	6.750	0.000	0.400
OPERATING ENGINEER		BLD	1	34.200	37.200	1.5	1.5	2.0	9.000	17.00	0.000	1.000
OPERATING ENGINEER		BLD	2	33.070	37.200	1.5	1.5	2.0	9.000	17.00	0.000	1.000
OPERATING ENGINEER		BLD	3	28.590	37.200	1.5	1.5	2.0	9.000	17.00	0.000	1.000
OPERATING ENGINEER		BLD	4	28.650	37.200	1.5	1.5	2.0	9.000	17.00	0.000	1.000
OPERATING ENGINEER		BLD	5	28.320	37.200	1.5	1.5	2.0	9.000	17.00	0.000	1.000
OPERATING ENGINEER		BLD	6	35.750	37.200	1.5	1.5	2.0	9.000	17.00	0.000	1.000
OPERATING ENGINEER		BLD	7	36.050	37.200	1.5	1.5	2.0	9.000	17.00	0.000	1.000
OPERATING ENGINEER		BLD	8	36.330	37.200	1.5	1.5	2.0	9.000	17.00	0.000	1.000
OPERATING ENGINEER		BLD	9	35.650	37.200	1.5	1.5	2.0	9.000	17.00	0.000	1.000
OPERATING ENGINEER		HWY	1	32.700	35.700	1.5	1.5	2.0	9.000	17.00	0.000	1.000
OPERATING ENGINEER		HWY	2	31.570	35.700	1.5	1.5	2.0	9.000	17.00	0.000	1.000

OPERATING ENGINEER	HWY	3	27.090	35.700	1.5	1.5	2.0	9.000	17.00	0.000	1.000
OPERATING ENGINEER	HWY	4	27.150	35.700	1.5	1.5	2.0	9.000	17.00	0.000	1.000
OPERATING ENGINEER	HWY	5	26.820	35.700	1.5	1.5	2.0	9.000	17.00	0.000	1.000
OPERATING ENGINEER	HWY	6	34.250	35.700	1.5	1.5	2.0	9.000	17.00	0.000	1.000
OPERATING ENGINEER	HWY	7	34.550	35.700	1.5	1.5	2.0	9.000	17.00	0.000	1.000
OPERATING ENGINEER	HWY	8	34.830	35.700	1.5	1.5	2.0	9.000	17.00	0.000	1.000
OPERATING ENGINEER	HWY	9	34.150	35.700	1.5	1.5	2.0	9.000	17.00	0.000	1.000
PAINTER	BLD		29.250	30.750	1.5	1.5	2.0	5.000	7.920	0.000	0.600
PAINTER	HWY		30.450	31.950	1.5	1.5	2.0	5.000	7.920	0.000	0.600
PAINTER OVER 30FT	BLD		30.250	31.750	1.5	1.5	2.0	5.000	7.920	0.000	0.600
PAINTER PWR EQMT	BLD		30.250	31.750	1.5	1.5	2.0	5.000	7.920	0.000	0.600
PAINTER PWR EQMT	HWY		31.450	32.950	1.5	1.5	2.0	5.000	7.920	0.000	0.600
PILEDRIVER	ALL		34.630	36.130	1.5	1.5	2.0	6.550	6.750	0.000	0.400
PIPEFITTER	BLD		37.800	39.690	2.0	2.0	2.0	4.500	8.360	0.000	0.300
PLASTERER	BLD		30.250	31.250	1.5	1.5	2.0	9.250	8.600	0.000	0.050
PLUMBER	BLD		37.800	39.690	2.0	2.0	2.0	4.500	8.360	0.000	0.300
ROOFER	BLD		29.500	31.500	1.5	1.5	2.0	8.600	6.850	0.000	0.200
SHEETMETAL WORKER	BLD		26.150	27.950	1.5	1.5	2.0	7.140	9.340	0.000	0.540
SPRINKLER FITTER	BLD		38.780	41.780	2.0	2.0	2.0	8.370	11.18	0.000	1.000
TERRAZZO FINISHER	BLD		31.240	0.000	1.5	1.5	2.0	6.000	3.230	0.000	0.200
TERRAZZO MASON	BLD		32.530	32.830	1.5	1.5	2.0	6.000	5.230	0.000	0.210
TRUCK DRIVER	ALL	1	31.340	0.000	1.5	1.5	2.0	10.30	5.010	0.000	0.250
TRUCK DRIVER	ALL	2	31.780	0.000	1.5	1.5	2.0	10.30	5.010	0.000	0.250
TRUCK DRIVER	ALL	3	32.020	0.000	1.5	1.5	2.0	10.30	5.010	0.000	0.250
TRUCK DRIVER	ALL	4	32.280	0.000	1.5	1.5	2.0	10.30	5.010	0.000	0.250
TRUCK DRIVER	ALL	5	33.130	0.000	1.5	1.5	2.0	10.30	5.010	0.000	0.250
TRUCK DRIVER	O&C	1	25.070	0.000	1.5	1.5	2.0	10.30	5.010	0.000	0.250
TRUCK DRIVER	O&C	2	25.420	0.000	1.5	1.5	2.0	10.30	5.010	0.000	0.250
TRUCK DRIVER	O&C	3	25.620	0.000	1.5	1.5	2.0	10.30	5.010	0.000	0.250
TRUCK DRIVER	O&C	4	25.820	0.000	1.5	1.5	2.0	10.30	5.010	0.000	0.250
TRUCK DRIVER	O&C	5	26.500	0.000	1.5	1.5	2.0	10.30	5.010	0.000	0.250

Legend :

RG (Region)

TYP (Trade Type - All,Highway,Building,Floating,Oil & Chip,Rivers)

C (Class)

Base (Base Wage Rate)

FRMAN (Foreman Rate)

M-F>8 (OT required for any hour greater than 8 worked each day, Mon through Fri.

OSA (Overtime (OT) is required for every hour worked on Saturday)

OSH (Overtime is required for every hour worked on Sunday and Holidays)

H/W (Health & Welfare Insurance)

Pensn (Pension)

Vac (Vacation)

Trng (Training)

Explanations

The following list is considered as those days for which holiday rates of wages for work performed apply: New Years Day, Memorial Day, Fourth of July, Labor Day, Thanksgiving Day, Christmas Day and Veterans Day in some classifications/counties. Generally, any of these holidays which fall on a Sunday is celebrated on the following Monday. This then makes work performed on that Monday payable at the appropriate overtime rate for holiday pay. Common practice in a given local may alter certain days of celebration. If in doubt, please check with IDOL.

Oil and chip resealing (O&C) means the application of road oils and liquid asphalt to coat an existing road surface, followed by application of aggregate chips or gravel to coated surface, and subsequent rolling of material to seal the surface.

EXPLANATION OF CLASSES

ASBESTOS - GENERAL - removal of asbestos material/mold and hazardous materials from any place in a building, including mechanical systems where those mechanical systems are to be removed. This includes the removal of asbestos materials/mold and hazardous materials from ductwork or pipes in a building when the building is to be demolished at the time or at some close future date.

ASBESTOS - MECHANICAL - removal of asbestos material from mechanical systems, such as pipes, ducts, and boilers, where the mechanical systems are to remain.

CERAMIC TILE FINISHER AND MARBLE FINISHER

The handling, at the building site, of all sand, cement, tile, marble or stone and all other materials that may be used and installed by [a] tile layer or marble mason. In addition, the grouting, cleaning, sealing, and mixing on the job site, and all other work as required in assisting the setter. The term "Ceramic" is used for naming the classification only and is in no way a limitation of the product handled. Ceramic takes into consideration most hard tiles.

ELECTRONIC SYSTEMS TECHNICIAN

Installation, service and maintenance of low-voltage systems which utilizes the transmission and/or transference of voice, sound, vision, or digital for commercial, education, security and entertainment purposes for the following: TV monitoring and surveillance, background/foreground music, intercom and telephone interconnect, field programming, inventory control systems, microwave transmission, multi-media, multiplex, radio page, school, intercom and sound burglar alarms and low voltage master clock systems.

Excluded from this classification are energy management systems, life safety systems, supervisory controls and data acquisition systems not intrinsic with the above listed systems, fire alarm systems, nurse call systems and raceways exceeding fifteen feet in length.

OPERATING ENGINEER - BUILDING

GROUP I. Cranes, Dragline, Shovels, Skimmer Scoops, Clamshells or Derrick Boats, Pile Drivers, Crane-Type Backhoes, Asphalt Plant Operators, Concrete Plant Operators, Dredges, Asphalt Spreading Machines, All Locomotives, Cable Ways or Tower Machines, Hoists, Hydraulic Backhoes, Ditching Machines or Backfiller, Cherrypickers, Overhead Cranes, Roller - Steam or Gas, Concrete Pavers, Excavators, Concrete Breakers, Concrete Pumps, Bulk Cement Plants, Cement Pumps, Derrick-Type Drills, Boat Operators, Motor Graders or Pushcats, Scoops

or Tournapulls, Bulldozers, Endloaders or Fork Lifts, Power Blade or Elevating Graders, Winch Cats, Boom or Winch Trucks or Boom Tractors, Pipe Wrapping or Painting Machines, Asphalt Plant Engineer, Journeyman Lubricating Engineer, Drills (other than Derrick Type), Mud Jacks, or Well Drilling Machines, Boring Machines or Track Jacks, Mixers, Conveyors (Two), Air Compressors (Two), Water Pumps regardless of size (Two), Welding Machines (Two), Siphons or Jets (Two), Winch Heads or Apparatuses (Two), Light Plants (Two), All Tractors regardless of size (straight tractor only), Fireman on Stationary Boilers, Automatic Elevators, Form Grading Machines, Finishing Machines, Power Sub-Grader or Ribbon Machines, Longitudinal Floats, Distributor Operators on Trucks, Winch Heads or Apparatuses (One), Mobil Track air and heaters (two to five), Heavy Equipment Greaser, Relief Operator, Assistant Master Mechanic and Heavy Duty Mechanic, self-propelled concrete saws of all types and sizes with their attachments, gob-hoppers, excavators all sizes, the repair and greasing of all diesel hammers, the operation and set-up of bidwells, water blasters of all sizes and their clutches, hydraulic jacks where used for hoisting, operation of log skidders, iceolators used on and off of pipeline, condor cranes, bow boats, survey boats, bobcats and all their attachments, skid steer loaders and all their attachments, creter cranes, batch plants, operator (all sizes), self propelled roto mills, operation of conveyor systems of any size and any configuration, operation, repair and service of all vibratory hammers, all power pacs and their controls regardless of location, curtains or brush burning machines, stump cutter machines, Nail launchers when mounted on a machine or self-propelled, operation of con-cover machines, and all Operators except those listed below).

GROUP II. Assistant Operators.

GROUP III. Air Compressors (One), Water Pumps, regardless of Size (One), Waterblasters (one), Welding Machine (One), Mixers (One Bag), Conveyor (One), Siphon or Jet (One), Light Plant (One), Heater (One), Immobile Track Air (One), and Self Propelled Walk-Behind Rollers.

GROUP IV. Asphalt Spreader Oilers, Fireman on Whirlies and Heavy Equipment Oilers, Truck Cranes, Dredges, Monigans, Large Cranes - (Over 65-ton rated capacity) Concrete Plant Oiler, Blacktop Plant Oiler, and Creter Crane Oiler (when required).

GROUP V. Oiler.

GROUP VI. Operators on equipment with Booms, including jibs, 100 feet and over, and less than 150 feet long.

GROUP VII. Operators on equipment with Booms, including jibs, 150 feet and over, and less than 200 feet long.

GROUP VIII. Operators on Equipment with Booms, including jibs, 200 feet and over; Tower Cranes; and Whirlie Cranes.

GROUP IX. Master Mechanic

OPERATING ENGINEERS - Highway

GROUP I. Cranes, Dragline, Shovels, Skimmer Scoops, Clamshells or Derrick Boats, Pile Drivers, Crane-Type Backhoes, Asphalt Plant Operators, Concrete Plant Operators, Dredges, Asphalt Spreading Machines, All Locomotives, Cable Ways or Tower Machines, Hoists, Hydraulic Backhoes, Ditching Machines or Backfiller, Cherrypickers, Overhead Cranes, Roller - Steam or Gas, Concrete Pavers, Excavators, Concrete Breakers, Concrete Pumps, Bulk Cement Plants, Cement Pumps, Derrick-Type Drills, Boat Operators, Motor Graders or Pushcats, Scoops or Tournapulls, Bulldozers, Endloaders or Fork Lifts, Power Blade or

Elevating Graders, Winch Cats, Boom or Winch Trucks or Boom Tractors, Pipe Wrapping or Painting Machines, Asphalt Plant Engineer, Journeyman Lubricating Engineer, Drills (other than Derrick Type), Mud Jacks, Well Drilling Machines, Boring Machines, Track Jacks, Mixers, Conveyors (Two), Air Compressors (Two), Water Pumps regardless of size (Two), Welding Machines (Two), Siphons or Jets (Two), Winch Heads or Apparatuses (Two), Light Plants (Two), All Tractors regardless of size (straight tractor only), Fireman on Stationary Boilers, Automatic Elevators, Form Grading Machines, Finishing Machines, Power Sub-Grader or Ribbon Machines, Longitudinal Floats, Distributor Operators on Trucks, Winch Heads or Apparatuses (One), Mobil Track air and heaters (two to five), Heavy Equipment Greaser, Relief Operator, Assistant Master Mechanic and Heavy Duty Mechanic, self-propelled concrete saws of all types and sizes with their attachments, gob-hoppers, excavators all sizes, the repair and greasing of all diesel hammers, the operation and set-up of bidwells, water blasters of all sizes and their clutches, hydraulic jacks where used for hoisting, operation of log skidders, iceolators used on and off of pipeline, condor cranes, bow boats, survey boats, bobcats and all their attachments, skid steer loaders and all their attachments, creter cranes, batch plants, operator (all sizes), self propelled roto mills, operation of conveyor systems of any size and any configuration, operation, repair and service of all vibratory hammers, all power pacs and their controls regardless of location, curtains or brush burning machines, stump cutter machines, Nail launchers when mounted on a machine or self-propelled, operation of con-cover machines, and all Operators (except those listed below).

GROUP II. Assistant Operators.

GROUP III. Air Compressors (One), Water Pumps, regardless of Size (One), Waterblasters (one), Welding Machine (One), Mixers (One Bag), Conveyor (One), Siphon or Jet (One), Light Plant (One), Heater (One), Immobile Track Air (One), and Self Propelled Walk-Behind Rollers.

GROUP IV. Asphalt Spreader Oilers, Fireman on Whirlies and Heavy Equipment Oilers, Truck Cranes, Dredges, Monigans, Large Cranes - (Over 65-ton rated capacity) Concrete Plant Oiler, Blacktop Plant Oiler, and Creter Crane Oiler (when required).

GROUP V. Oiler.

GROUP VI. Operators on equipment with Booms, including jibs, 100 feet and over, and less than 150 feet long.

GROUP VII. Operators on equipment with Booms, including jibs, 150 feet and over, and less than 200 feet long.

GROUP VIII. Operators on Equipment with Booms, including jibs, 200 feet and over; Tower Cranes; and Whirlie Cranes.

GROUP IX. Mechanic

TRUCK DRIVER - BUILDING, HEAVY AND HIGHWAY CONSTRUCTION

Class 1. Drivers on 2 axle trucks hauling less than 9 ton. Air compressor and welding machines and brooms, including those pulled by separate units, truck driver helpers, warehouse employees, mechanic helpers, greasers and tiremen, pickup trucks when hauling materials, tools, or workers to and from and on-the-job site, and fork lifts up to 6,000 lb. capacity.

Class 2. Two or three axle trucks hauling more than 9 ton but hauling less than 16 ton. A-frame winch trucks, hydrolift trucks, vactor trucks or similar equipment when used for transportation purposes.

Fork lifts over 6,000 lb. capacity, winch trucks, four axle combination units, and ticket writers.

Class 3. Two, three or four axle trucks hauling 16 ton or more. Drivers on water pulls, articulated dump trucks, mechanics and working forepersons, and dispatchers. Five axle or more combination units.

Class 4. Low Boy and Oil Distributors.

Class 5. Drivers who require special protective clothing while employed on hazardous waste work.

TRUCK DRIVER - OIL AND CHIP RESEALING ONLY.

This shall encompass laborers, workers and mechanics who drive contractor or subcontractor owned, leased, or hired pickup, dump, service, or oil distributor trucks. The work includes transporting materials and equipment (including but not limited to, oils, aggregate supplies, parts, machinery and tools) to or from the job site; distributing oil or liquid asphalt and aggregate; stock piling material when in connectin with the actual oil and chip contract. The Truck Driver (Oil & Chip Resealing) wage classification does not include supplier delivered materials.

TERRAZZO FINISHER

The handling of all materials used for Mosaic and Terrazzo work including preparing, mixing by hand, by mixing machine or transporting of pre-mixed materials and distributing with shovel, rake, hoe, or pail, all kinds of concrete foundations necessary for Mosaic and Terrazzo work, all cement terrazzo, magnesite terrazzo, Do-O-Tex terrazzo, epoxy matrix ter-razzo, exposed aggregate, rustic or rough washed for exterior or interior of buildings placed either by machine or by hand, and any other kind of mixture of plastics composed of chips or granules when mixed with cement, rubber, neoprene, vinyl, magnesium chloride or any other resinous or chemical substances used for seamless flooring systems, and all other building materials, all similar materials and all precast terrazzo work on jobs, all scratch coat used for Mosaic and Terrazzo work and sub-bed, tar paper and wire mesh (2x2 etc.) or lath. The rubbing, grinding, cleaning and finishing of same either by hand or by machine or by terrazzo resurfacing equipment on new or existing floors. When necessary finishers shall be allowed to assist the mechanics to spread sand bed, lay tarpaper and wire mesh (2x2 etc.) or lath. The finishing of cement floors where additional aggregate of stone is added by spreading or sprinkling on top of the finished base, and troweled or rolled into the finish and then the surface is ground by grinding machines.

Other Classifications of Work:

For definitions of classifications not otherwise set out, the Department generally has on file such definitions which are available. If a task to be performed is not subject to one of the classifications of pay set out, the Department will upon being contacted state which neighboring county has such a classification and provide such rate, such rate being deemed to exist by reference in this document. If no neighboring county rate applies to the task, the Department shall undertake a special determination, such special determination being then deemed to have existed under this determination. If a project requires these, or any classification not listed, please contact IDOL at 217-782-1710 for wage rates or clarifications.

LANDSCAPING

Landscaping work falls under the existing classifications for laborer, operating engineer and truck driver. The work performed by landscape plantsman and landscape laborer is covered by the existing classification of laborer. The work performed by landscape operators (regardless of equipment used or its size) is covered by the classifications of operating engineer. The work performed by landscape truck drivers (regardless of size of truck driven) is covered by the classifications of truck driver.

Carroll County Prevailing Wage for May 2013

(See explanation of column headings at bottom of wages)

Trade Name	RG	TYP	C	Base	FRMAN	M-F>8	OSA	OSH	H/W	Pensn	Vac	Trng
=====	==	===	=	=====	=====	=====	===	===	=====	=====	=====	=====
ASBESTOS ABT-GEN		BLD		29.550	30.550	1.5	1.5	2.0	8.240	12.42	0.000	0.800
ASBESTOS ABT-MEC		BLD		20.500	21.500	1.5	1.5	2.0	6.250	3.500	0.000	0.000
BOILERMAKER		BLD		35.010	38.010	2.0	2.0	2.0	7.070	13.83	0.000	0.300
BRICK MASON		BLD		35.880	38.630	1.5	1.5	2.0	7.950	11.73	0.000	0.600
CARPENTER		BLD		32.040	35.560	1.5	1.5	2.0	8.630	13.87	0.000	0.600
CARPENTER		HWY		33.790	35.540	1.5	1.5	2.0	9.750	12.99	0.000	0.490
CEMENT MASON		ALL		32.520	35.270	1.5	1.5	2.0	7.700	13.98	0.000	0.500
CERAMIC TILE FNSHER		BLD		32.410	0.000	1.5	1.5	2.0	7.700	4.840	0.000	0.530
COMMUNICATION TECH	E	BLD		36.000	39.600	1.5	1.5	2.0	10.14	11.20	0.000	0.720
ELECTRIC PWR EQMT OP		ALL		36.610	49.750	1.5	1.5	2.0	5.000	11.35	0.000	0.270
ELECTRIC PWR GRNDMAN		ALL		28.310	49.750	1.5	1.5	2.0	5.000	8.780	0.000	0.210
ELECTRIC PWR LINEMAN		ALL		43.830	49.750	1.5	1.5	2.0	5.000	13.58	0.000	0.330
ELECTRIC PWR TRK DRV		ALL		29.310	49.750	1.5	1.5	2.0	5.000	9.090	0.000	0.220
ELECTRICIAN	E	BLD		40.000	44.000	1.5	1.5	2.0	10.14	16.93	0.000	0.800
ELECTRICIAN	W	BLD		31.520	33.520	1.5	1.5	2.0	7.320	10.82	0.000	0.310
ELECTRONIC SYS TECH	W	BLD		23.750	25.500	1.5	1.5	2.0	7.120	5.260	0.000	0.310
ELEVATOR CONSTRUCTOR		BLD		45.350	51.020	2.0	2.0	2.0	11.88	12.71	3.630	0.600
GLAZIER		BLD		22.020	23.520	1.5	1.5	2.0	6.940	6.520	0.000	0.350
HT/FROST INSULATOR		BLD		29.190	30.390	1.5	1.5	2.0	5.420	12.05	0.000	0.900
IRON WORKER	E	ALL		35.090	36.840	2.0	2.0	2.0	8.250	20.59	0.000	0.700
IRON WORKER	W	ALL		28.000	30.240	1.5	1.5	2.0	9.390	10.68	0.000	0.620
LABORER		BLD		29.550	30.550	1.5	1.5	2.0	8.240	12.42	0.000	0.800
LABORER		HWY		32.100	32.850	1.5	1.5	2.0	8.240	12.42	0.000	0.800
LABORER, SKILLED		HWY		34.400	35.150	1.5	1.5	2.0	8.240	12.42	0.000	0.800
LATHER		BLD		32.040	35.560	1.5	1.5	2.0	8.630	13.87	0.000	0.600
MACHINIST		BLD		43.550	46.050	1.5	1.5	2.0	6.130	8.950	1.850	0.000
MARBLE FINISHERS		BLD		32.410	0.000	1.5	1.5	2.0	7.700	4.840	0.000	0.530
MARBLE MASON		BLD		35.090	35.340	1.5	1.5	2.0	7.700	7.150	0.000	0.560
MATERIAL TESTER I		ALL		21.550	0.000	1.5	1.5	2.0	7.460	4.840	0.000	0.170
MATERIALS TESTER II		ALL		26.550	0.000	1.5	1.5	2.0	7.460	4.840	0.000	0.170
MILLWRIGHT		BLD		29.820	32.800	1.5	1.5	2.0	6.400	9.640	0.000	0.500
OPERATING ENGINEER		BLD	1	40.800	44.850	2.0	2.0	2.0	15.85	9.800	2.350	1.300
OPERATING ENGINEER		BLD	2	40.100	44.850	2.0	2.0	2.0	15.85	9.800	2.350	1.300
OPERATING ENGINEER		BLD	3	37.650	44.850	2.0	2.0	2.0	15.85	9.800	2.350	1.300
OPERATING ENGINEER		BLD	4	35.650	44.850	2.0	2.0	2.0	15.85	9.800	2.350	1.300
OPERATING ENGINEER		BLD	5	44.600	44.850	2.0	2.0	2.0	15.85	9.800	2.350	1.300
OPERATING ENGINEER		BLD	6	43.350	44.850	2.0	2.0	2.0	15.85	9.800	2.350	1.300
OPERATING ENGINEER		BLD	7	40.350	44.850	2.0	2.0	2.0	15.85	9.800	2.350	1.300
OPERATING ENGINEER		HWY	1	40.650	44.700	1.5	1.5	2.0	15.85	9.800	2.350	1.300
OPERATING ENGINEER		HWY	2	40.100	44.700	1.5	1.5	2.0	15.85	9.800	2.350	1.300
OPERATING ENGINEER		HWY	3	38.800	44.700	1.5	1.5	2.0	15.85	9.800	2.350	1.300
OPERATING ENGINEER		HWY	4	37.350	44.700	1.5	1.5	2.0	15.85	9.800	2.350	1.300
OPERATING ENGINEER		HWY	5	35.900	44.700	1.5	1.5	2.0	15.85	9.800	2.350	1.300
OPERATING ENGINEER		HWY	6	43.700	44.700	1.5	1.5	2.0	15.85	9.800	2.350	1.300
OPERATING ENGINEER		HWY	7	41.700	44.700	1.5	1.5	2.0	15.85	9.800	2.350	1.300

PAINTER		ALL	27.320	28.320	1.5	1.5	1.5	5.000	6.100	0.000	0.600
PAINTER OVER 30FT		ALL	28.570	29.570	1.5	1.5	1.5	5.000	6.100	0.000	0.600
PAINTER PWR EQMT		ALL	27.820	28.820	1.5	1.5	1.5	5.000	6.100	0.000	0.600
PILEDRIVER		BLD	33.040	36.670	1.5	1.5	2.0	8.630	13.87	0.000	0.600
PILEDRIVER		HWY	33.790	35.540	1.5	1.5	2.0	9.750	12.99	0.000	0.490
PIPEFITTER	E	BLD	40.600	43.440	1.5	1.5	2.0	7.980	10.79	0.000	1.000
PIPEFITTER	W	ALL	36.550	40.210	1.5	1.5	2.0	5.650	12.15	0.000	1.000
PLASTERER		BLD	33.360	36.700	2.0	2.0	2.0	8.150	11.05	0.000	0.500
PLUMBER	E	BLD	40.600	43.440	1.5	1.5	2.0	7.980	10.79	0.000	1.000
PLUMBER	W	ALL	36.550	40.210	1.5	1.5	2.0	5.650	12.15	0.000	1.000
ROOFER		BLD	38.350	41.350	1.5	1.5	2.0	8.280	8.770	0.000	0.430
SHEETMETAL WORKER		BLD	35.780	37.710	1.5	1.5	2.0	5.450	15.44	0.520	0.290
SPRINKLER FITTER		BLD	36.390	39.140	1.5	1.5	2.0	8.420	8.500	0.000	0.450
STONE MASON		BLD	35.880	38.630	1.5	1.5	2.0	7.950	11.73	0.000	0.600
TERRAZZO FINISHER		BLD	32.410	0.000	1.5	1.5	2.0	7.700	4.840	0.000	0.530
TERRAZZO MASON		BLD	35.090	35.340	1.5	1.5	2.0	7.700	7.150	0.000	0.560
TILE LAYER		BLD	32.040	35.560	1.5	1.5	2.0	8.630	13.87	0.000	0.600
TILE MASON		BLD	35.090	35.340	1.5	1.5	2.0	7.700	7.150	0.000	0.560
TRUCK DRIVER		ALL 1	31.230	0.000	1.5	1.5	2.0	10.30	4.840	0.000	0.250
TRUCK DRIVER		ALL 2	31.680	0.000	1.5	1.5	2.0	10.30	4.840	0.000	0.250
TRUCK DRIVER		ALL 3	31.890	0.000	1.5	1.5	2.0	10.30	4.840	0.000	0.250
TRUCK DRIVER		ALL 4	32.180	0.000	1.5	1.5	2.0	10.30	4.840	0.000	0.250
TRUCK DRIVER		ALL 5	33.020	0.000	1.5	1.5	2.0	10.30	4.840	0.000	0.250
TRUCK DRIVER		O&C 1	24.980	0.000	1.5	1.5	2.0	10.30	4.840	0.000	0.250
TRUCK DRIVER		O&C 2	25.340	0.000	1.5	1.5	2.0	10.30	4.840	0.000	0.250
TRUCK DRIVER		O&C 3	25.510	0.000	1.5	1.5	2.0	10.30	4.840	0.000	0.250
TRUCK DRIVER		O&C 4	25.740	0.000	1.5	1.5	2.0	10.30	4.840	0.000	0.250
TRUCK DRIVER		O&C 5	26.420	0.000	1.5	1.5	2.0	10.30	4.840	0.000	0.250
TUCKPINTER		BLD	35.880	38.630	1.5	1.5	2.0	7.950	11.73	0.000	0.600

Legend :

RG (Region)

TYP (Trade Type - All,Highway,Building,Floating,Oil & Chip,Rivers)

C (Class)

Base (Base Wage Rate)

FRMAN (Foreman Rate)

M-F>8 (OT required for any hour greater than 8 worked each day, Mon through Fri.

OSA (Overtime (OT) is required for every hour worked on Saturday)

OSH (Overtime is required for every hour worked on Sunday and Holidays)

H/W (Health & Welfare Insurance)

Pensn (Pension)

Vac (Vacation)

Trng (Training)

Explanations

CARROLL COUNTY

COMMUNICATIONS TECHNICIAN (EAST) - Townships of Cherry Grove, Rock

Creek, Shannon, Wysox, Lima, and Elkhorn Grove.

ELECTRICIANS (EAST) - Townships of Cherry Grove, Shannon, Rock Creek, Lima, Wysox, and Elkhorn Grove.

IRONWORKERS (EAST) - That part of the county East of a line between Fair Haven and Derinda Center (JoDavie County).

PLUMBERS & PIPEFITTERS (EAST) - That part of the county East of Rt. 78 and including Mt. Carroll.

ELECTRONIC SYSTEMS TECHNICIAN -(WEST) - Portion west of Cherry Grove, Rock Creek and Wysox Townships.

The following list is considered as those days for which holiday rates of wages for work performed apply: New Years Day, Memorial Day, Fourth of July, Labor Day, Thanksgiving Day, Christmas Day and Veterans Day in some classifications/counties. Generally, any of these holidays which fall on a Sunday is celebrated on the following Monday. This then makes work performed on that Monday payable at the appropriate overtime rate for holiday pay. Common practice in a given local may alter certain days of celebration. If in doubt, please check with IDOL.

Oil and chip resealing (O&C) means the application of road oils and liquid asphalt to coat an existing road surface, followed by application of aggregate chips or gravel to coated surface, and subsequent rolling of material to seal the surface.

EXPLANATION OF CLASSES

ASBESTOS - GENERAL - removal of asbestos material/mold and hazardous materials from any place in a building, including mechanical systems where those mechanical systems are to be removed. This includes the removal of asbestos materials/mold and hazardous materials from ductwork or pipes in a building when the building is to be demolished at the time or at some close future date.

ASBESTOS - MECHANICAL - removal of asbestos material from mechanical systems, such as pipes, ducts, and boilers, where the mechanical systems are to remain.

CERAMIC TILE FINISHER, MARBLE FINISHER, TERRAZZO FINISHER

Assisting, helping or supporting the tile, marble and terrazzo mechanic by performing their historic and traditional work assignments required to complete the proper installation of the work covered by said crafts. The term "Ceramic" is used for naming the classification only and is in no way a limitation of the product handled. Ceramic takes into consideration most hard tiles.

COMMUNICATIONS TECHNICIAN - East

Installing, manufacturing, assembling and maintaining sound and intercom, protection alarm (security), fire alarm, master antenna television, closed circuit television, low voltage control for computers and/or door monitoring, school communications systems, telephones and servicing of nurse and emergency calls, and the installation and maintenance of transmit and receive antennas, transmitters, receivers, and associated apparatus which operates in conjunction with above systems. All work associated with these system installations will be included EXCEPT the installation of protective metallic conduit in new construction projects (excluding less than ten-foot runs strictly for protection of cable) and 120 volt AC (or higher) power wiring and associated hardware.

ELECTRONIC SYSTEMS TECHNICIAN - West

Installing, assembling and maintaining sound and intercom, protection alarm (security), master antenna television, closed circuit television, computer hardware and software programming and installation to the network's outlet and input (EXCLUDING all cabling, power and cable termination work historically performed by wiremen), door monitoring and control, nurse and emergency call programming and installation to the system's outlet and input (EXCLUDING all cabling, power and cable termination work historically performed by wiremen), clock and timing; and the installation and maintenance of transmit and receive antennas, transmitters, receivers, and associated apparatus which operates in conjunction with the above systems. All work associated with these system installations will be included EXCEPT (1) installation of protective metallic conduit, excluding less than ten-foot runs strictly for protection of cable, and (2) 120 volt AC (or higher) power wiring and associated hardware.

LABORER, SKILLED - HIGHWAY

Individuals engaged in the following types of work, irrespective of the site of the work: asbestos abatement worker, handling of any materials with any foreign matter harmful to skin or clothing, track laborer, cement handlers, chloride handlers, the unloading and loading with steel workers and re-bars, concrete workers wet, tunnel helpers in free air, batch dumpers, mason tenders, kettle and tar men, tank cleaners, plastic installers, scaffold workers, motorized buggies or motorized unit used for wet concrete or handling of building materials, laborers with de-watering systems, sewer workers plus depth, rod and chainmen with technical engineers, rod and chainmen with land surveyors, rod and chainmen with surveyors, vibrator operators, cement silica, clay, fly ash, lime and plasters, handlers (bulk or bag), cofferdam workers plus depth, on concrete paving, placing, cutting and tying of reinforcing, deck hand, dredge hand, and shore laborers, bankmen on floating plant, grade checker, power tools, front end man on chip spreaders, cession workers plus depth, gunnite nozzle men, lead man on sewer work, welders, cutters, burners and torchmen, chainsaw operators, jackhammer and drill operators, layout man and/or drainage tile layer, steel form setter - street and highway, air tamping hammermen, signal man on crane, concrete saw operator, screedman on asphalt pavers, laborers tending masons with hot material or where foreign materials are used, mortar mixer operators, multiple concrete duct - leadsman, lumen, asphalt raker, curb asphalt machine operator, ready mix scalemen (permanent, portable or temporary plant), laborers handling masterplate or similar materials, laser beam operator, concrete burning machine operator, coring machine operator, plaster tender, underpinning and shoring of buildings, pump men, manhole and catch basin, dirt and stone tamper, hose men on concrete pumps, hazardous waste worker, lead base paint abatement worker, lining of pipe, refusing machine, assisting on direct boring machine, the work of laying watermain, fire hydrants, all mechanical joints to watermain work, sewer worker, and tapping water service and forced lift station mechanical worker.

MATERIAL TESTER I: Hand coring and drilling for testing of materials; field inspection of uncured concrete and asphalt.

MATERIAL TESTER II: Field inspection of welds, structural steel, fireproofing, masonry, soil, facade, reinforcing steel, formwork, cured concrete, and concrete and asphalt batch plants; adjusting proportions of bituminous mixtures.

OPERATING ENGINEERS - BUILDING

Class 1. Asphalt Plant; Asphalt Spreader; Autograde; Backhoes with Caisson Attachment; Batch Plant; Benoto (requires Two Engineers); Boiler and Throttle Valve; Caisson Rigs; Central Redi-Mix Plant; Combination Back Hoe Front End-loader Machine; Compressor and Throttle Valve; Concrete Breaker (Truck Mounted); Concrete Conveyor; Concrete Paver (over 27E cu. ft.): Concrete Paver (27 cu. ft. and under); Concrete Placer; Concrete Pump (Truck Mounted); Concrete Conveyor (Truck Mounted); Concrete Tower; Cranes, All; GCI and similar types (required two operators only); Cranes, Hammerhead; Creter Crane; Crusher, Stone, etc.; Derricks, All; Derricks, Traveling; Formless Curb and Gutter Machine; Grader, Elevating; Grouting Machines; Highlift Shovels or Front Endloader 2-1/4 yd. and over; Hoists, Elevators, outside type rack and pinion and similar machines; Hoists, one, two and three Drum; Hoists, Two Tugger One Floor; Hydraulic Backhoes; Hydraulic Boom Trucks; Hydro Vac (and similar equipment - excluding hose work and any sewer work); Locomotives, All; Lubrication Technician; Manipulators; Motor Patrol; Pile Drivers and Skid Rig; Post Hole Digger; Pre-Stress Machine; Pump Cretes Dual Ram; Pump Cretes: Squeeze Cretes - Screw Type Pumps, Gypsum Bulker and Pump; Raised and Blind Hole Drill; Rock Drill (self-propelled); Rock Drill - Truck Mounted; Roto Mill Grinder; Scoops - Tractor Drawn; Slipform Paver; Scrapers Prime Movers; Straddle Buggies; Tie Back Machine; Tractor with Boom and Side Boom; Trenching Machines.

Class 2. Bobcat (over 3/4 cu. yd.); Boilers; Brick Forklift; Broom, All Power Propelled; Bulldozers; Concrete Mixer (Two Bag and Over); Conveyor, Portable; Forklift Trucks; Highlift Shovels or Front Endloaders under 2-1/4 yd.; Hoists, Automatic; Hoists, Sewer Dragging Machine; Hoists, Tugger Single Drum; Laser Screed; Rollers, All; Steam Generators; Tractors, All; Tractor Drawn Vibratory Roller; Winch Trucks with "A" Frame.

Class 3. Air Compressor; Asphalt Spreader; Combination - Small Equipment Operator; Generators; Heaters, Mechanical; Hoists, Inside Elevators - (Rheostat Manual Controlled); Hydraulic Power Units (Pile Driving, Extracting, or Drilling - with a seat); Lowboys; Pumps, Over 3" (1 to 3 not to exceed total of 300 ft.); Pumps, Well Points; Welding Machines (2 through 5); Winches, 4 Small Electric Drill Winches; Bobcat (up to and including 3/4 cu. yd.).

Class 4. Elevator push button with automatic doors; Hoists, Inside; Oilers; Brick Forklift.

Class 5. Assistant Craft Foreman

Class 6. Mechanics; Welders.

Class 7. Gradall

OPERATING ENGINEERS - HIGHWAY CONSTRUCTION

Class 1. Asphalt Plant; Asphalt Heater and Planer Combination; Asphalt Heater Scarfire; Asphalt Silo Tender; Asphalt Spreader; Autograder; ABG Paver; Backhoes with Caisson Attachment; Ballast Regulator; Belt Loader; Caisson Rigs; Car Dumper; Central Redi-Mix Plant; Backhoe w/shear attachments; Combination Backhoe Front Endloader Machine, (1 cu. yd. Backhoe Bucket or over or with attachments); Concrete Breaker (Truck Mounted); Concrete Conveyor; Concrete Paver over 27E cu. ft.; Concrete Placer; Concrete Tube Float; Cranes, all attachments; Cranes, Tower of all types; Creter Crane; Crusher, Stone, etc.; Derricks, All; Derrick Boats; Derricks, Traveling; Directional Boring Machine over 12"; Dredges; Formless Curb and Gutter Machine; Grader, Elevating; Grader, Motor Grader, Motor Patrol, Auto Patrol, Form Grader, Pull Grader, Subgrader; Guard Rail Post Driver Mounted;

Hoists, One, Two and Three Drum; Hydraulic Backhoes; Hydro Vac, Self Propelled, Truck Mounted (excluding hose work and any sewer work); Lubrication Technician; Manipulators; Pile Drivers and Skid Rig; Pre-Stress Machine; Pump Cretes Dual Ram; Rock Drill - Crawler or Skid Rig; Rock Drill - Truck Mounted; Rock/Track Tamper; Roto Mill Grinder; Slip-Form Paver; Snow Melters; Soil Test Drill Rig (Truck Mounted); Straddle Buggies; GCI Crane; Hydraulic Telescoping Form (Tunnel); Tie Back Machine; Tractor Drawn Belt Loader; Tractor Drawn Belt Loader with attached pusher; Tractor with Boom; Tractaire with Attachments; Traffic Barrier Conveyor Machine; Raised or Blind Hole Drills; Trenching Machine (over 12"); Truck Mounted Concrete Pump with Boom; Truck Mounted Concrete Conveyor; Work Boat (no license required - 90 h.p. or above); Underground Boring and/or Mining Machines; Wheel Excavator; Widener (APSCO).

Class 2. Batch Plant; Bituminous Mixer; Boiler and Throttle Valve; Bulldozers; Car Loader Trailing Conveyors; Combination Backhoe Front Endloader Machine (less than 1 cu. yd. Backhoe Bucket or over or with attachments); Compressor and Throttle Valve; Compressor, Common Receiver (3); Concrete Breaker or Hydro Hammer; Concrete Grinding Machine; Concrete Mixer or Paver 7S Series to and including 27 cu. ft.; Concrete Spreader; Concrete Curing Machine, Burlap Machine, Belting Machine and Sealing Machine; Concrete Wheel Saw (large self-propelled - excluding walk-behinds and hand-held); Conveyor Muck Cars (Haglund or Similar Type); Drills, all; Finishing Machine - Concrete; Highlift Shovels or Front Endloader; Hoist - Sewer Dragging Machine; Hydraulic Boom Trucks (All Attachments); Hydro Blaster; All Locomotives, Dinky; Off-Road Hauling Units; Non-Self Loading Dump; Ejection Dump; Pump Cretes: Squeeze Cretes - Screw Type Pumps, Gypsum Bulker and Pump; Roller, Asphalt; Rotary Snow Plows; Rototiller, Seaman, etc., self-propelled; Scoops - Tractor Drawn; Self-Propelled Compactor; Spreader - Chip - Stone, etc.; Scraper; Scraper - Prime Mover in Tandem (Regardless of Size); Tank Car Heater; Tractors, Push, Pulling Sheeps Foot, Disc, Compactor, etc.; Tug Boats.

Class 3. Boilers; Brooms, All Power Propelled; Cement Supply Tender; Compressor, Common Receiver (2); Concrete Mixer (Two Bag and Over); Conveyor, Portable; Farm-Type Tractors Used for Mowing, Seeding, etc.; Fireman on Boilers; Forklift Trucks; Grouting Machine; Hoists, Automatic; Hoists, All Elevators; Hoists, Tugger Single Drum; Jeep Diggers; Low Boys; Pipe Jacking Machines; Post-Hole Digger; Power Saw, Concrete Power Driven; Pug Mills; Rollers, other than asphalt; Seed and Straw Blower; Steam Generators; Stump Machine; Winch Trucks with "A" Frame; Work Boats; Tamper - Form - Motor Driven.

Class 4. Air Compressor - Small and Large; Asphalt Spreader, Backend Man; Bobcat (Skid Steer) all; Brick Forklift; Combination - Small Equipment Operator; Directional Boring Machine up to 12"; Generators; Heaters, Mechanical; Hydraulic Power Unit (Pile Driving, Extracting, or Drilling); Hydro-Blaster; Light Plants, All (1 through 5); Pumps, over 3" (1 to 3 not to exceed a total of 300 ft.); Pumps, Well Points; Tractaire; Trencher 12" and under; Welding Machines (2 through 5); Winches, 4 Small Electric Drill Winches.

Class 5. Oilers and Directional Boring Machine Locator.

Class 6. Field Mechanics and Field Welders

Class 7. Gradall and machines of like nature.

TRUCK DRIVER - BUILDING, HEAVY AND HIGHWAY CONSTRUCTION

Class 1. Drivers on 2 axle trucks hauling less than 9 ton. Air compressor and welding machines and brooms, including those pulled by separate units, truck driver helpers, warehouse employees, mechanic

helpers, greasers and tiremen, pickup trucks when hauling materials, tools, or workers to and from and on-the-job site, and fork lifts up to 6,000 lb. capacity.

Class 2. Two or three axle trucks hauling more than 9 ton but hauling less than 16 ton. A-frame winch trucks, hydrolift trucks, vector trucks or similar equipment when used for transportation purposes. Fork lifts over 6,000 lb. capacity, winch trucks, four axle combination units, and ticket writers.

Class 3. Two, three or four axle trucks hauling 16 ton or more. Drivers on water pulls, articulated dump trucks, mechanics and working forepersons, and dispatchers. Five axle or more combination units.

Class 4. Low Boy and Oil Distributors.

Class 5. Drivers who require special protective clothing while employed on hazardous waste work.

TRUCK DRIVER - OIL AND CHIP RESEALING ONLY.

This shall encompass laborers, workers and mechanics who drive contractor or subcontractor owned, leased, or hired pickup, dump, service, or oil distributor trucks. The work includes transporting materials and equipment (including but not limited to, oils, aggregate supplies, parts, machinery and tools) to or from the job site; distributing oil or liquid asphalt and aggregate; stock piling material when in connection with the actual oil and chip contract. The Truck Driver (Oil & Chip Resealing) wage classification does not include supplier delivered materials.

Other Classifications of Work:

For definitions of classifications not otherwise set out, the Department generally has on file such definitions which are available. If a task to be performed is not subject to one of the classifications of pay set out, the Department will upon being contacted state which neighboring county has such a classification and provide such rate, such rate being deemed to exist by reference in this document. If no neighboring county rate applies to the task, the Department shall undertake a special determination, such special determination being then deemed to have existed under this determination. If a project requires these, or any classification not listed, please contact IDOL at 217-782-1710 for wage rates or clarifications.

LANDSCAPING

Landscaping work falls under the existing classifications for laborer, operating engineer and truck driver. The work performed by landscape plantsman and landscape laborer is covered by the existing classification of laborer. The work performed by landscape operators (regardless of equipment used or its size) is covered by the classifications of operating engineer. The work performed by landscape truck drivers (regardless of size of truck driven) is covered by the classifications of truck driver.

Cass County Prevailing Wage for May 2013

(See explanation of column headings at bottom of wages)

Trade Name	RG	TYP	C	Base	FRMAN	M-F>8	OSA	OSH	H/W	Pensn	Vac	Trng
=====	==	===	=	=====	=====	=====	===	===	=====	=====	=====	=====
ASBESTOS ABT-GEN		BLD		28.200	29.450	1.5	1.5	2.0	5.750	10.22	0.000	0.900
ASBESTOS ABT-MEC		BLD		29.860	30.860	1.5	1.5	2.0	6.950	3.000	0.000	0.000
BOILERMAKER		BLD		31.500	34.000	1.5	1.5	2.0	7.070	18.73	1.000	0.350
BRICK MASON		BLD		29.250	30.250	1.5	1.5	2.0	8.200	8.330	0.000	0.580
CARPENTER		BLD		27.670	29.920	1.5	1.5	2.0	7.450	14.58	0.000	0.520
CARPENTER		HWY		28.870	30.620	1.5	1.5	2.0	7.450	13.73	0.000	0.520
CEMENT MASON		BLD		25.200	26.700	1.5	1.5	2.0	6.600	12.10	0.000	0.500
CEMENT MASON		HWY		24.850	25.850	1.5	1.5	2.0	6.600	11.85	0.000	0.500
CERAMIC TILE FNSHER		BLD		25.600	0.000	1.5	1.5	2.0	8.200	7.230	0.000	0.000
ELECTRIC PWR EQMT OP		ALL		35.440	0.000	1.5	1.5	2.0	5.000	10.98	0.000	0.270
ELECTRIC PWR GRNDMAN		ALL		24.320	0.000	1.5	1.5	2.0	5.000	7.540	0.000	0.180
ELECTRIC PWR LINEMAN		ALL		39.370	41.910	1.5	1.5	2.0	5.000	12.20	0.000	0.300
ELECTRIC PWR TRK DRV		ALL		25.510	0.000	1.5	1.5	2.0	5.000	7.920	0.000	0.190
ELECTRICIAN		BLD		34.220	36.220	1.5	1.5	2.0	5.860	8.120	0.000	0.400
ELECTRONIC SYS TECH		BLD		30.390	32.140	1.5	1.5	2.0	5.350	7.160	0.000	0.400
ELEVATOR CONSTRUCTOR		BLD		40.520	45.585	2.0	2.0	2.0	11.88	12.71	3.240	0.600
GLAZIER		BLD		30.780	32.780	1.5	2.0	2.0	6.630	8.150	0.000	0.380
HT/FROST INSULATOR		BLD		37.260	38.260	1.5	1.5	2.0	7.850	11.16	0.000	0.500
IRON WORKER		BLD		29.460	31.460	1.5	1.5	2.0	7.740	11.38	0.000	0.660
IRON WORKER		HWY		30.600	32.100	1.5	1.5	2.0	7.740	11.69	0.000	0.660
LABORER		BLD		26.200	27.450	1.5	1.5	2.0	5.750	10.22	0.000	0.800
LABORER		HWY		28.210	28.960	1.5	1.5	2.0	5.750	10.32	0.000	0.800
LATHER		BLD		27.670	29.920	1.5	1.5	2.0	7.450	14.58	0.000	0.520
MACHINIST		BLD		43.550	46.050	1.5	1.5	2.0	6.130	8.950	1.850	0.000
MARBLE FINISHERS		BLD		25.600	0.000	1.5	1.5	2.0	8.200	7.230	0.000	0.000
MARBLE MASON		BLD		27.100	27.850	1.5	1.5	2.0	8.200	7.230	0.000	0.000
MILLWRIGHT		BLD		29.620	31.870	1.5	1.5	2.0	7.450	13.09	0.000	0.520
MILLWRIGHT		HWY		31.690	33.440	1.5	1.5	2.0	7.450	13.54	0.000	0.520
OPERATING ENGINEER		BLD	1	33.900	35.400	1.5	1.5	2.0	10.05	7.600	0.000	1.300
OPERATING ENGINEER		BLD	2	31.550	35.400	1.5	1.5	2.0	10.05	7.600	0.000	1.300
OPERATING ENGINEER		BLD	3	27.950	35.400	1.5	1.5	2.0	10.05	7.600	0.000	1.300
OPERATING ENGINEER		BLD	4	35.400	35.400	1.5	1.5	2.0	10.05	7.600	0.000	1.300
OPERATING ENGINEER		HWY	1	37.600	39.100	1.5	1.5	2.0	10.05	8.100	0.000	1.300
OPERATING ENGINEER		HWY	2	33.660	39.100	1.5	1.5	2.0	10.05	8.100	0.000	1.300
OPERATING ENGINEER		HWY	3	27.630	39.100	1.5	1.5	2.0	10.05	8.100	0.000	1.300
OPERATING ENGINEER		HWY	4	39.100	39.100	1.5	1.5	2.0	10.05	8.100	0.000	1.300
PAINTER		ALL		28.580	30.080	1.5	1.5	2.0	5.000	8.580	0.000	0.550
PAINTER OVER 30FT		ALL		29.580	31.080	1.5	1.5	2.0	5.000	8.580	0.000	0.550
PAINTER PWR EQMT		ALL		29.580	31.080	1.5	1.5	2.0	5.000	8.580	0.000	0.550
PILEDRIVER		BLD		28.170	30.420	1.5	1.5	2.0	7.450	14.58	0.000	0.520
PILEDRIVER		HWY		29.870	31.620	1.5	1.5	2.0	7.450	13.73	0.000	0.520
PIPEFITTER		BLD		40.020	44.020	1.5	1.5	2.0	7.000	7.750	0.000	0.900
PLASTERER		BLD		28.500	30.250	1.5	1.5	2.0	7.330	11.29	0.000	0.500
PLUMBER		BLD		40.020	44.020	1.5	1.5	2.0	7.000	7.750	0.000	0.900
ROOFER		BLD		27.900	30.400	1.5	1.5	2.0	8.600	6.750	0.000	0.500
SHEETMETAL WORKER		BLD		31.680	33.930	1.5	1.5	2.0	8.300	12.35	0.000	0.500
SPRINKLER FITTER		BLD		36.390	39.140	1.5	1.5	2.0	8.420	8.500	0.000	0.450
STONE MASON		BLD		29.250	30.250	1.5	1.5	2.0	8.200	8.330	0.000	0.580
TERRAZZO FINISHER		BLD		25.600	0.000	1.5	1.5	2.0	8.200	7.230	0.000	0.000
TERRAZZO MASON		BLD		27.100	27.850	1.5	1.5	2.0	8.200	7.230	0.000	0.000
TILE MASON		BLD		27.100	27.850	1.5	1.5	2.0	8.200	7.230	0.000	0.000
TRUCK DRIVER		ALL	1	31.340	0.000	1.5	1.5	2.0	10.30	5.010	0.000	0.250
TRUCK DRIVER		ALL	2	31.780	0.000	1.5	1.5	2.0	10.30	5.010	0.000	0.250
TRUCK DRIVER		ALL	3	32.020	0.000	1.5	1.5	2.0	10.30	5.010	0.000	0.250
TRUCK DRIVER		ALL	4	32.280	0.000	1.5	1.5	2.0	10.30	5.010	0.000	0.250
TRUCK DRIVER		ALL	5	33.130	0.000	1.5	1.5	2.0	10.30	5.010	0.000	0.250
TRUCK DRIVER		O&C	1	25.070	0.000	1.5	1.5	2.0	10.30	5.010	0.000	0.250
TRUCK DRIVER		O&C	2	25.420	0.000	1.5	1.5	2.0	10.30	5.010	0.000	0.250
TRUCK DRIVER		O&C	3	25.620	0.000	1.5	1.5	2.0	10.30	5.010	0.000	0.250
TRUCK DRIVER		O&C	4	25.820	0.000	1.5	1.5	2.0	10.30	5.010	0.000	0.250
TRUCK DRIVER		O&C	5	26.500	0.000	1.5	1.5	2.0	10.30	5.010	0.000	0.250
TUCKPOINTER		BLD		29.250	30.250	1.5	1.5	2.0	8.200	8.330	0.000	0.580

Legend :

RG (Region)

TYP (Trade Type - All,Highway,Building,Floating,Oil & Chip,Rivers)

C (Class)

Base (Base Wage Rate)

FRMAN (Foreman Rate)

M-F>8 (OT required for any hour greater than 8 worked each day, Mon through Fri.

OSA (Overtime (OT) is required for every hour worked on Saturday)

OSH (Overtime is required for every hour worked on Sunday and Holidays)

H/W (Health & Welfare Insurance)

Pensn (Pension)

Vac (Vacation)

Trng (Training)

Explanations

CASS COUNTY

The following list is considered as those days for which holiday rates of wages for work performed apply: New Years Day, Memorial Day, Fourth of July, Labor Day, Thanksgiving Day, Christmas Day and Veterans Day in some classifications/counties. Generally, any of these holidays which fall on a Sunday is celebrated on the following Monday. This then makes work performed on that Monday payable at the appropriate overtime rate for holiday pay. Common practice in a given local may alter certain days of celebration. If in doubt, please check with IDOL.

Oil and chip resealing (O&C) means the application of road oils and liquid asphalt to coat an existing road surface, followed by application of aggregate chips or gravel to coated surface, and subsequent rolling of material to seal the surface.

EXPLANATION OF CLASSES

ASBESTOS - GENERAL - removal of asbestos material/mold and hazardous materials from any place in a building, including mechanical systems where those mechanical systems are to be removed. This includes the removal of asbestos materials/mold and hazardous materials from ductwork or pipes in a building when the building is to be demolished at the time or at some close future date.

ASBESTOS - MECHANICAL - removal of asbestos material from mechanical systems, such as pipes, ducts, and boilers, where the mechanical systems are to remain.

CERAMIC TILE FINISHER, MARBLE FINISHER, TERRAZZO FINISHER

Assisting, helping or supporting the tile, marble and terrazzo mechanic by performing their historic and traditional work assignments required to complete the proper installation of the work covered by said crafts. The term "Ceramic" is used for naming the classification only and is in no way a limitation of the product handled. Ceramic takes into consideration most hard tiles.

ELECTRONIC SYSTEMS TECHNICIAN

Installation, service and maintenance of low-voltage systems which utilizes the transmission and/or transference of voice, sound, vision, or digital for commercial, education, security and entertainment purposes for the following: TV monitoring and surveillance, background/foreground music, intercom and telephone interconnect, field programming, inventory control systems, microwave transmission, multi-media, multiplex, radio page, school, intercom and sound burglar alarms and low voltage master clock systems.

Excluded from this classification are energy management systems, life safety systems, supervisory controls and data acquisition systems not intrinsic with the above listed systems, fire alarm systems, nurse call systems and raceways exceeding fifteen feet in length.

TRUCK DRIVER - BUILDING, HEAVY AND HIGHWAY CONSTRUCTION

Class 1. Drivers on 2 axle trucks hauling less than 9 ton. Air compressor and welding machines and brooms, including those pulled by separate units, truck driver helpers, warehouse employees, mechanic helpers, greasers and tiremen, pickup trucks when hauling materials, tools, or workers to and from and on-the-job site, and fork lifts up to 6,000 lb. capacity.

Class 2. Two or three axle trucks hauling more than 9 ton but hauling less than 16 ton. A-frame winch trucks, hydrolift trucks, vector trucks or similar equipment when used for transportation purposes. Fork lifts over 6,000 lb. capacity, winch trucks, four axle combination units, and ticket writers.

Class 3. Two, three or four axle trucks hauling 16 ton or more. Drivers on water pulls, articulated dump trucks, mechanics and working forepersons, and dispatchers. Five axle or more combination units.

Class 4. Low Boy and Oil Distributors.

Class 5. Drivers who require special protective clothing while employed on hazardous waste work.

TRUCK DRIVER - OIL AND CHIP RESEALING ONLY.

This shall encompass laborers, workers and mechanics who drive contractor or subcontractor owned, leased, or hired pickup, dump, service, or oil distributor trucks. The work includes transporting materials and equipment (including but not limited to, oils, aggregate supplies, parts, machinery and tools) to or from the job site; distributing oil or liquid asphalt and aggregate; stock piling material when in connection with the actual oil and chip contract. The Truck Driver (Oil & Chip Resealing) wage classification does not include supplier delivered materials.

OPERATING ENGINEERS - BUILDING

CLASS 1. Asphalt Screed Man; Aspco Concrete Spreaders; Asphalt Pavers; Asphalt Plant Engineer; Asphalt Rollers on Bituminous Concrete; Athey Loaders; Backfillers, Crane Type; Backhoes; Barber Green Loaders; Bulldozers; Cableways; Cherry Pickers; Clam Shells;

C.M.I. & similar type autograde formless paver, autograde placer & finisher; Concrete Breakers; Concrete Pumps; Derricks; Derrick Boats; Draglines; Earth Auger or Boring Machines; Elevating Graders; Engineers on Dredges; Gravel Processing Machines; Head Equipment Greaser; High Lifts or Fork Lifts; Hoists with two or more drums or two or more load lines; Locomotives, All; Mechanics; Motor Graders or Auto Patrols; Operators or Leverman on Dredges; Operators, Power Boat; Operators, Pug Mill (Asphalt Plants); Orange Peels; Overhead Cranes; Paving Mixers; Piledrivers; Pipe Wrapping and Painting Machines; Pushdozers, or Push Cats; Robotic Controlled Equipment in this Classification; Rock Crushers; Ross Carrier or Similar Machines; Rotomill; Scoops, Skimmer, two cu. yd. capacity and under; Scoops, All or Tournapull; Sheep-Foot Roller (Self Propelled); Shovels; Skid Steer; Skimmer Scoops; Temporary Concrete Plant Operators; Test Hole Drilling Machines; Tower Machines; Tower Mixers; Track Type End Loaders; Track Type Fork Lifts or High Lifts; Track Jacks and Tampers; Tractors, Sideboom; Trenching or Ditching Machine; Tunnelluggers; Vermeer Type Saws; Water Blaster Cutting Head; Wheel Type End Loaders; Winch Cat.

CLASS 2. Air Compressors (six to eight)*; Asphalt Boosters and Heaters; Asphalt Distributors; Asphalt Plant Fireman; Oiler on Two Paving Mixers When Used in Tandem; Boom or Winch Trucks; Bull Floats or Flexplanes; Concrete Finishing Machine; Concrete Saws, Self-Propelled; Concrete Spreading Machines; Conveyors (six to eight)*; Generators (six to eight)*; Gravel or Stone Spreader, Power Operated; Hoist (with One Drum and One Load Line); Light Plants (six to eight)*; Mechanical Heaters (six to eight)*; Mud Jacks; Post Hole Digger, Mechanical; Pug Mills when used for other than Asphalt operation; Robotic Controlled Equipment in this Classification; Road or Street Sweeper, Self Propelled; Rollers (except bituminous concrete); Seaman Tiller; Straw Machine; Vibratory Compactor; Water Blaster, Power Unit; Welding Machines (six to eight)*; Well Drill Machines.

CLASS 3. Air Compressors(one to five)*; Air Compressors, Track or Self-Propelled; Automatic Hoist; Building Elevators; Bulk Cement Batching Plants; Conveyors (one to five)*; Concrete Mixers (Except Plant, Paver, or Tower); Firemen; Generators (one to five)*; Greasers; Helper on Single Paving Mixer; Hoist, Automatic; Light Plants (one to five)*; Mechanic Helpers; Mechanical Heaters (one to five)*; Oilers; Power Form Graders; Power Sub-Graders; Robotic Controlled Equipment in this Classification; Scissors Hoist; Tractors without power attachments regardless of size or type; Truck Crane Oiler and Driver (1 man); Vibratory Hammer (power source); Water Pumps (one to five)*; Welding Machines (1/300 Amp. or over)*; Welding machines (one to five)*

CLASS 4. Lattice Boom Crawler Cranes; Lattice Boom Truck Cranes; Telescopic Truck-Mounted Cranes; Tower Cranes.

* Combinations of one to eight of any Air Compressors, Conveyors, Welding Machines, Water Pumps, Light Plants, or Generators shall be in batteries or within 400 feet and shall be paid as per the Classification Schedule contained in this Article.

OPERATING ENGINEERS - HIGHWAY

CLASS 1. Asphalt Screed Man; Asphco Concrete Spreaders; Asphalt Pavers; Asphalt Plant Engineer; Asphalt Rollers on Bituminous Concrete; Athey Loaders; Backhoes; Barber Green Loaders; Bulldozers; Cableways; Carry Deck Pickers; Cherry Pickers (Rough Terrain); C.M.I. & similar type-autograde formless paver, autograde placer & finisher; Concrete Breakers; Concrete Plant Operators; Concrete Pumps; Derricks;

Derrick Boats; Dewatering Systems; Earth Auger or Boring Machines; Elevating Graders; Engineers on Dredges; Gravel Processing Machines; Grout Pump; Head Equipment Greaser; High Lifts or Fork Lifts; Hoists with two or more drums or two or more load lines; Hydro Jet or Hydro Laser; Locomotives, All; Mechanics; Motor Graders or Auto Patrols; Multi-Point Power Lifting Equipment; Operators or Leverman on Dredges; Operators, Power Boat; Operators, Pug Mill (Asphalt Plants); Overhead Cranes; Paving Mixers; Piledrivers; Pipe Wrapping and Painting Machines; Push-dozers, or Push Cats; Robotic Controlled Equipment in this Classification; Rock Crushers; Ross Carrier or Similar Machines; Roto-Mill; Scoops, Skimmer, two cu. yd. capacity and under; Sheep-Foot Roller (Self Pro-pelled); Shovels; Skid Steer; Skimmer Scoops; Test Hole Drilling Machines; Tower Machines; Tower Mixers; Track Type End Loaders; Track Type Fork Lifts or High Lifts; Track Jacks and Tampers; Tractors, Side-boom; Trenching or Ditching Machine; Tunnelluggers; Vermeer-Type Saws; Wheel Type End Loaders; Winch Cat; Scoops, All or Tournapull.

CLASS 2. Air Compressors (six to eight)*; Articulated Dumps; Asphalt Boosters and Heaters; Asphalt Distributors; Asphalt Plant Fireman; Boom or Winch Trucks; Building Elevators; Bull Floats or Flexplanes; Concrete Finishing Machine; Concrete Saws, Self-Propelled; Concrete Spreading Machines; Conveyors (six to eight)*; Generators (six to eight)*; Gravel or Stone Spreader, Power Operated; Hoist, Automatic; Hoist with One Drum and One Load Line; Light Plants (six to eight)*; Mechanical Heaters (six to eight)*; Mud Jacks; Off Road Water Wagons; Oiler on Two Paving Mixers When Used in Tandem; Post Hole Digger, Mechanical; Robotic Controlled Equipment in This Classification; Road or Street Sweeper, Self-Propelled; Rollers (except bituminous concrete); Scissor Hoist; Sea-man Tiller; Straw Machine; Vibratory Compactor; Water Pumps (six to eight)*; Well Drill Machines.

CLASS 3. Air Compressors (one to five)*; Air Compressors, Track or Self-Propelled; Bulk Cement Batching Plants; Conveyors (one to five)*; Concrete Mixers (Except Plant, Paver, or Tower); Firemen; Generators (one to five)*; Greasers; Helper on Single Paving Mixer; Light Plants (one to five)*; Mechanic Helpers; Mechanical Heaters (one to five)*; Oilers; Power Form Graders; Power Sub-Graders; Pug Mills when used for other than Asphalt operation; Robotic Controlled Equipment in This Classification; Tractors without power attachments, regardless of size or type; Truck Crane Oiler and Driver (1 man); Vibratory Hammer (power source); Water Pumps (one to five)*; Welding Machines (one 300 Amp. or over)*; Welding Machines (one to five)*.

CLASS 4. Lattice Boom Crawler Crane; Lattice Boom Truck Crane; Telescopic Truck-Mounted Crane; Tower Crane.

*Combinations of one to eight of any Air Compressors, Conveyors, Welding Machines, Water Pumps, Light Plants or Generators shall be in batteries or within 400 feet and shall be paid as per the Classification Schedule contained in this Article.

Other Classifications of Work:

For definitions of classifications not otherwise set out, the Department generally has on file such definitions which are available. If a task to be performed is not subject to one of the classifications of pay set out, the Department will upon being contacted state which neighboring county has such a classification and provide such rate, such rate being deemed to exist by reference in this document. If no neighboring county rate applies to the task, the Department shall undertake a special determination, such special determination being then deemed to have existed under this determination. If a project requires these, or any classification not

listed, please contact IDOL at 217-782-1710 for wage rates or clarifications.

LANDSCAPING

Landscaping work falls under the existing classifications for laborer, operating engineer and truck driver. The work performed by landscape plantsman and landscape laborer is covered by the existing classification of laborer. The work performed by landscape operators (regardless of equipment used or its size) is covered by the classifications of operating engineer. The work performed by landscape truck drivers (regardless of size of truck driven) is covered by the classifications of truck driver.

Champaign County Prevailing Wage for May 2013

(See explanation of column headings at bottom of wages)

Trade Name	RG	TYP	C	Base	FRMAN	M-F>8	OSA	OSH	H/W	Pensn	Vac	Trng
=====	==	===	=	=====	=====	=====	===	===	=====	=====	=====	=====
ASBESTOS ABT-GEN		BLD		30.630	31.880	1.5	1.5	2.0	5.750	9.790	0.000	0.900
ASBESTOS ABT-MEC		BLD		20.450	21.450	1.5	1.5	2.0	6.250	5.000	0.000	0.000
BOILERMAKER		BLD		35.010	38.010	2.0	2.0	2.0	7.070	13.83	0.000	0.300
BRICK MASON		BLD		30.670	32.170	1.5	1.5	2.0	6.600	10.03	0.000	0.630
CARPENTER		BLD		33.000	35.250	1.5	1.5	2.0	7.450	9.250	0.000	0.520
CARPENTER		HWY		33.350	35.100	1.5	1.5	2.0	7.450	9.250	0.000	0.520
CEMENT MASON		BLD		29.800	31.300	1.5	1.5	2.0	6.600	8.360	0.000	0.500
CEMENT MASON		HWY		30.390	31.890	1.5	1.5	2.0	6.600	8.560	0.000	0.500
CERAMIC TILE FNSHER		BLD		28.400	0.000	1.5	1.5	2.0	6.600	7.930	0.000	0.000
ELECTRIC PWR EQMT OP		ALL		35.440	0.000	1.5	1.5	2.0	5.000	10.98	0.000	0.270
ELECTRIC PWR GRNDMAN		ALL		24.320	0.000	1.5	1.5	2.0	5.000	7.540	0.000	0.180
ELECTRIC PWR LINEMAN		ALL		39.370	41.910	1.5	1.5	2.0	5.000	12.20	0.000	0.300
ELECTRIC PWR TRK DRV		ALL		25.510	0.000	1.5	1.5	2.0	5.000	7.920	0.000	0.190
ELECTRICIAN		BLD		37.090	39.090	1.5	1.5	2.0	5.350	7.760	0.000	0.560
ELECTRONIC SYS TECH		BLD		30.830	32.580	1.5	1.5	2.0	5.350	6.720	0.000	0.400
ELEVATOR CONSTRUCTOR		BLD		40.520	45.585	2.0	2.0	2.0	11.88	12.71	3.240	0.600
FENCE ERECTOR		ALL		30.610	32.510	1.5	1.5	2.0	8.840	8.420	0.000	0.900
GLAZIER		BLD		30.780	32.780	1.5	2.0	2.0	6.630	8.150	0.000	0.380
HT/FROST INSULATOR		BLD		31.230	32.230	1.5	1.5	2.0	5.790	8.960	2.000	0.250
IRON WORKER		ALL		30.610	32.510	1.5	1.5	2.0	8.840	8.420	0.000	0.900
LABORER		BLD		28.630	29.880	1.5	1.5	2.0	5.750	9.790	0.000	0.800
LABORER		HWY		29.650	30.650	1.5	1.5	2.0	5.750	9.790	0.000	0.800
LATHER		BLD		33.000	35.250	1.5	1.5	2.0	7.450	9.250	0.000	0.520
MACHINIST		BLD		43.550	46.050	1.5	1.5	2.0	6.130	8.950	1.850	0.000
MARBLE FINISHERS		BLD		28.400	0.000	1.5	1.5	2.0	6.600	7.930	0.000	0.000
MARBLE MASON		BLD		29.900	0.000	1.5	1.5	2.0	6.600	7.930	0.000	0.000
MILLWRIGHT		BLD		29.620	31.870	1.5	1.5	2.0	7.450	13.09	0.000	0.520
MILLWRIGHT		HWY		31.400	33.150	1.5	1.5	2.0	7.450	13.54	0.000	0.520
OPERATING ENGINEER		ALL	1	36.950	0.000	1.5	1.5	2.0	7.250	8.700	0.000	0.800
OPERATING ENGINEER		ALL	2	23.900	0.000	1.5	1.5	2.0	7.250	8.700	0.000	0.800
PAINTER		ALL		33.560	35.060	1.5	1.5	2.0	6.600	4.420	0.000	0.570
PAINTER SIGNS		ALL		33.560	35.060	1.5	1.5	2.0	6.600	4.420	0.000	0.570
PILEDRIVER		BLD		33.500	35.750	1.5	1.5	2.0	7.450	9.250	0.000	0.520
PILEDRIVER		HWY		34.350	36.100	1.5	1.5	2.0	7.450	9.250	0.000	0.520
PIPEFITTER		BLD		37.680	40.180	1.5	1.5	2.0	7.000	10.61	0.000	0.980
PLASTERER		BLD		30.000	32.000	1.5	1.5	2.0	6.600	10.17	0.000	0.500
PLUMBER		BLD		37.680	40.180	1.5	1.5	2.0	7.000	10.61	0.000	0.980
ROOFER		BLD		28.750	30.250	1.5	1.5	2.0	9.150	8.400	0.000	0.200
SHEETMETAL WORKER		BLD		33.640	35.640	1.5	1.5	2.0	8.300	12.00	0.000	0.520
SPRINKLER FITTER		BLD		36.390	39.140	1.5	1.5	2.0	8.420	8.500	0.000	0.450
STONE MASON		BLD		30.670	32.170	1.5	1.5	2.0	6.600	10.03	0.000	0.630
TERRAZZO FINISHER		BLD		28.400	0.000	1.5	1.5	2.0	6.600	7.930	0.000	0.000
TERRAZZO MASON		BLD		29.900	0.000	1.5	1.5	2.0	6.600	7.930	0.000	0.000

TILE MASON	BLD	29.900	0.000	1.5	1.5	2.0	6.600	7.930	0.000	0.000
TRUCK DRIVER	ALL 1	31.230	0.000	1.5	1.5	2.0	10.30	4.840	0.000	0.250
TRUCK DRIVER	ALL 2	31.680	0.000	1.5	1.5	2.0	10.30	4.840	0.000	0.250
TRUCK DRIVER	ALL 3	31.890	0.000	1.5	1.5	2.0	10.30	4.840	0.000	0.250
TRUCK DRIVER	ALL 4	32.180	0.000	1.5	1.5	2.0	10.30	4.840	0.000	0.250
TRUCK DRIVER	ALL 5	33.020	0.000	1.5	1.5	2.0	10.30	4.840	0.000	0.250
TRUCK DRIVER	O&C 1	24.980	0.000	1.5	1.5	2.0	10.30	4.840	0.000	0.250
TRUCK DRIVER	O&C 2	25.340	0.000	1.5	1.5	2.0	10.30	4.840	0.000	0.250
TRUCK DRIVER	O&C 3	25.510	0.000	1.5	1.5	2.0	10.30	4.840	0.000	0.250
TRUCK DRIVER	O&C 4	25.740	0.000	1.5	1.5	2.0	10.30	4.840	0.000	0.250
TRUCK DRIVER	O&C 5	26.420	0.000	1.5	1.5	2.0	10.30	4.840	0.000	0.250
TUCKPOINTER	BLD	30.670	32.170	1.5	1.5	2.0	6.600	10.03	0.000	0.630

Legend :

RG (Region)

TYP (Trade Type - All,Highway,Building,Floating,Oil & Chip,Rivers)

C (Class)

Base (Base Wage Rate)

FRMAN (Foreman Rate)

M-F>8 (OT required for any hour greater than 8 worked each day, Mon through Fri.

OSA (Overtime (OT) is required for every hour worked on Saturday)

OSH (Overtime is required for every hour worked on Sunday and Holidays)

H/W (Health & Welfare Insurance)

Pensn (Pension)

Vac (Vacation)

Trng (Training)

Explanations

CHAMPAIGN COUNTY

The following list is considered as those days for which holiday rates of wages for work performed apply: New Years Day, Memorial Day, Fourth of July, Labor Day, Thanksgiving Day, Christmas Day and Veterans Day in some classifications/counties. Generally, any of these holidays which fall on a Sunday is celebrated on the following Monday. This then makes work performed on that Monday payable at the appropriate overtime rate for holiday pay. Common practice in a given local may alter certain days of celebration. If in doubt, please check with IDOL.

Oil and chip resealing (O&C) means the application of road oils and liquid asphalt to coat an existing road surface, followed by application of aggregate chips or gravel to coated surface, and subsequent rolling of material to seal the surface.

EXPLANATION OF CLASSES

ASBESTOS - GENERAL - removal of asbestos material/mold and hazardous

materials from any place in a building, including mechanical systems where those mechanical systems are to be removed. This includes the removal of asbestos materials/mold and hazardous materials from ductwork or pipes in a building when the building is to be demolished at the time or at some close future date.

ASBESTOS - MECHANICAL - removal of asbestos material from mechanical systems, such as pipes, ducts, and boilers, where the mechanical systems are to remain.

CERAMIC TILE FINISHER, MARBLE FINISHER, TERRAZZO FINISHER

Assisting, helping or supporting the tile, marble and terrazzo mechanic by performing their historic and traditional work assignments required to complete the proper installation of the work covered by said crafts. The term "Ceramic" is used for naming the classification only and is in no way a limitation of the product handled. Ceramic takes into consideration most hard tiles.

ELECTRONIC SYSTEMS TECHNICIAN

Installation, service and maintenance of low-voltage systems which utilizes the transmission and/or transference of voice, sound, vision, or digital for commercial, education, security and entertainment purposes for the following: TV monitoring and surveillance, background/foreground music, intercom and telephone interconnect, field programming, inventory control systems, microwave transmission, multi-media, multiplex, radio page, school, intercom and sound burglar alarms and low voltage master clock systems.

Excluded from this classification are energy management systems, life safety systems, supervisory controls and data acquisition systems not intrinsic with the above listed systems, fire alarm systems, nurse call systems and raceways exceeding fifteen feet in length.

TRUCK DRIVER - BUILDING, HEAVY AND HIGHWAY CONSTRUCTION

Class 1. Drivers on 2 axle trucks hauling less than 9 ton. Air compressor and welding machines and brooms, including those pulled by separate units, truck driver helpers, warehouse employees, mechanic helpers, greasers and tiremen, pickup trucks when hauling materials, tools, or workers to and from and on-the-job site, and fork lifts up to 6,000 lb. capacity.

Class 2. Two or three axle trucks hauling more than 9 ton but hauling less than 16 ton. A-frame winch trucks, hydrolift trucks, vector trucks or similar equipment when used for transportation purposes. Fork lifts over 6,000 lb. capacity, winch trucks, four axle combination units, and ticket writers.

Class 3. Two, three or four axle trucks hauling 16 ton or more. Drivers on water pulls, articulated dump trucks, mechanics and working forepersons, and dispatchers. Five axle or more combination units.

Class 4. Low Boy and Oil Distributors.

Class 5. Drivers who require special protective clothing while employed on hazardous waste work.

TRUCK DRIVER - OIL AND CHIP RESEALING ONLY.

This shall encompass laborers, workers and mechanics who drive contractor or subcontractor owned, leased, or hired pickup, dump, service, or oil distributor trucks. The work includes transporting materials and equipment (including but not limited to, oils, aggregate

supplies, parts, machinery and tools) to or from the job site; distributing oil or liquid asphalt and aggregate; stock piling material when in connection with the actual oil and chip contract. The Truck Driver (Oil & Chip Resealing) wage classification does not include supplier delivered materials.

OPERATING ENGINEERS - BUILDING, HEAVY AND HIGHWAY CONSTRUCTION

Class 1. Power Cranes, Draglines, Derricks, Shovels, Gradalls, Mechanics, Tractor Highlift, Tournadozer, Concrete Mixers with Skip, Tournamixer, Two Drum Machine, One Drum Hoist with Tower or Boom, Cableways, Tower Machines, Motor Patrol, Boom Tractor, Boom or Winch Truck, Winch or Hydraulic Boom Truck, Truck Crane, Tournapull, Tractor Operating Scoops, Bulldozer, Push Tractor, Asphalt Planer, Finishing Machine on Asphalt, Large Rollers on Earth, Rollers on Asphalt Mix, Ross Carrier or similar Machine, Gravel Processing Machine, Asphalt Plant Engineer, Paver Operator, Dredging Equipment, or Dredge Engineer, or Dredge Operator, Central Mix Plant Engineer, CMI or similar type machine, Concrete Pump, Truck or Skid Mounted, Tower Crane, Engineer or Rock Crusher Plant, Concrete Plant Engineer, Ditching Machine with dual attachment, Tractor Mounted Loaders, Cherry Picker, Hydro Crane, Standard or Dinkey Locomotives, Scoopmobiles, Euclid Loader, Soil Cement Machine, Back Filler, Elevating Machine, Power Blade, Drilling Machine, including Well Testing, Caissons, Shaft or any similar type drilling machines, Motor Driven Paint Machine, Pipe Cleaning Machine, Pipe Wrapping Machine, Pipe Bending Machine, Apsco Paver, Boring Machine, (Head Equipment Greaser), Barber-Greene Loaders, Formless Paver, (Well Point System), Concrete Spreader, Hydra Ax, Span Saw, Marine Scoops, Brush Mulcher, Brush Burner, Mesh Placer, Tree Mover, Helicopter Crew (3), Piledriver-Skid or Crawler, Stump Remover, Root Rake, Tug Boat Operator, Refrigerating Machine, Freezing Operator, Chair Cart-Self-Propelled, Hydra Seeder, Straw Blower, Power Sub Grader, Bull Float, Finishing Machine, Self-Propelled Pavement Breaker, Lull (or similar type Machine), Two Air Compressors, Compressors hooked in Manifold, Overhead Crane, Chip Spreader, Mud Cat, Sull-Air, Fork Lifts (except when used for landscaping work), Soil Stabilizer (Seaman Tiller, Bo Mag, Rago Gator, and similar types of equipment), Tube Float, Spray Machine, Curing Machine, Concrete or Asphalt Milling Machine, Snooper Truck-Operator, Backhoe, Farm Tractors (with attachments), 4 Point Lift System (Power Lift or similar type), Skid-Steer (Bob Cat or similar type), Wrecking Shears, Water Blaster.

Class 2. Concrete Mixers without Skips, Rock Crusher, Ditching Machine under 6', Curbing Machine, One Drum Machines without Tower or Boom, Air Tugger, Self-Propelled Concrete Saw, Machine Mounted Post Hole Digger, two to four Generators, Water Pumps or Welding Machines, within 400 feet, Air Compressor 600 cu. ft. and under, Rollers on Aggregate and Seal Coat Surfaces, Fork Lift (when used for landscaping work), Concrete and Blacktop Curb Machine, One Water Pump, Oilers, Air Valves or Steam Valves, One Welding Machine, Truck Jack, Mud Jack, Gunnite Machine, House Elevators when used for hoisting material, Engine Tenders, Fireman, Wagon Drill, Flex Plane, Conveyor, Siphons and Pulsometer, Switchman, Fireman on Paint Pots, Fireman on Asphalt Plants, Distributor Operator on Trucks, Tampers, Self-Propelled Power Broom, Striping Machine (motor driven), Form Tamper, Bulk Cement Plant, Equipment Greaser, Deck Hands, Truck Crane Oiler-Driver, Cement Blimps, Form Grader, Temporary Heat, Throttle Valve, Super Sucker (and similar type of equipment).

Other Classifications of Work:

For definitions of classifications not otherwise set out, the Department generally has on file such definitions which are available. If a task to be performed is not subject to one of the

classifications of pay set out, the Department will upon being contacted state which neighboring county has such a classification and provide such rate, such rate being deemed to exist by reference in this document. If no neighboring county rate applies to the task, the Department shall undertake a special determination, such special determination being then deemed to have existed under this determination. If a project requires these, or any classification not listed, please contact IDOL at 217-782-1710 for wage rates or clarifications.

LANDSCAPING

Landscaping work falls under the existing classifications for laborer, operating engineer and truck driver. The work performed by landscape plantsman and landscape laborer is covered by the existing classification of laborer. The work performed by landscape operators (regardless of equipment used or its size) is covered by the classifications of operating engineer. The work performed by landscape truck drivers (regardless of size of truck driven) is covered by the classifications of truck driver.

Christian County Prevailing Wage for May 2013

(See explanation of column headings at bottom of wages)

Trade Name	RG	TYP	C	Base	FRMAN	M-F>8	OSA	OSH	H/W	Pensn	Vac	Trng
ASBESTOS ABT-GEN		BLD		29.710	30.960	1.5	1.5	2.0	5.750	10.22	0.000	0.900
ASBESTOS ABT-MEC		BLD		29.860	30.860	1.5	1.5	2.0	6.950	3.000	0.000	0.000
BOILERMAKER		BLD		31.500	34.000	1.5	1.5	2.0	7.070	18.73	1.000	0.350
BRICK MASON		BLD		29.130	29.880	2.0	2.0	2.0	8.200	10.03	0.000	0.580
CARPENTER		BLD		29.810	32.060	1.5	1.5	2.0	7.450	12.44	0.000	0.520
CARPENTER		HWY		29.810	31.560	1.5	1.5	2.0	7.450	12.99	0.000	0.520
CEMENT MASON		BLD		25.200	26.700	1.5	1.5	2.0	6.600	12.10	0.000	0.500
CEMENT MASON		HWY		24.850	25.850	1.5	1.5	2.0	6.600	11.85	0.000	0.500
CERAMIC TILE FNSHER		BLD		25.480	0.000	1.5	1.5	2.0	8.200	8.930	0.000	0.000
ELECTRIC PWR EQMT OP		ALL		35.440	0.000	1.5	1.5	2.0	5.000	10.98	0.000	0.270
ELECTRIC PWR GRNDMAN		ALL		24.320	0.000	1.5	1.5	2.0	5.000	7.540	0.000	0.180
ELECTRIC PWR LINEMAN		ALL		39.370	41.910	1.5	1.5	2.0	5.000	12.20	0.000	0.300
ELECTRIC PWR TRK DRV		ALL		25.510	0.000	1.5	1.5	2.0	5.000	7.920	0.000	0.190
ELECTRICIAN		BLD		34.200	37.620	1.5	1.5	2.0	5.350	7.610	0.000	0.510
ELECTRONIC SYS TECH		BLD		31.130	32.880	1.5	1.5	2.0	5.350	6.110	0.000	0.400
ELEVATOR CONSTRUCTOR		BLD		40.520	45.585	2.0	2.0	2.0	11.88	12.71	3.240	0.600
GLAZIER		BLD		30.780	32.780	1.5	2.0	2.0	6.630	8.150	0.000	0.380
HT/FROST INSULATOR		BLD		37.260	38.260	1.5	1.5	2.0	7.850	11.16	0.000	0.500
IRON WORKER		BLD		29.460	31.460	1.5	1.5	2.0	7.740	11.38	0.000	0.660
IRON WORKER		HWY		30.600	32.100	1.5	1.5	2.0	7.740	11.69	0.000	0.660
LABORER		BLD		27.710	28.960	1.5	1.5	2.0	5.750	10.22	0.000	0.800
LABORER		HWY		28.210	28.960	1.5	1.5	2.0	5.750	10.32	0.000	0.800
LATHER		BLD		29.810	32.060	1.5	1.5	2.0	7.450	12.44	0.000	0.520
MACHINIST		BLD		43.550	46.050	1.5	1.5	2.0	6.130	8.950	1.850	0.000
MARBLE FINISHERS		BLD		25.480	0.000	1.5	1.5	2.0	8.200	8.930	0.000	0.000
MARBLE MASON		BLD		26.980	27.730	1.5	1.5	2.0	8.200	8.930	0.000	0.000
MILLWRIGHT		BLD		29.620	31.870	1.5	1.5	2.0	7.450	13.09	0.000	0.520
MILLWRIGHT		HWY		31.690	33.440	1.5	1.5	2.0	7.450	13.54	0.000	0.520
OPERATING ENGINEER		BLD	1	33.900	35.400	1.5	1.5	2.0	10.05	7.600	0.000	1.300
OPERATING ENGINEER		BLD	2	31.550	35.400	1.5	1.5	2.0	10.05	7.600	0.000	1.300
OPERATING ENGINEER		BLD	3	27.950	35.400	1.5	1.5	2.0	10.05	7.600	0.000	1.300
OPERATING ENGINEER		BLD	4	35.400	35.400	1.5	1.5	2.0	10.05	7.600	0.000	1.300
OPERATING ENGINEER		HWY	1	37.600	39.100	1.5	1.5	2.0	10.05	8.100	0.000	1.300
OPERATING ENGINEER		HWY	2	33.660	39.100	1.5	1.5	2.0	10.05	8.100	0.000	1.300
OPERATING ENGINEER		HWY	3	27.630	39.100	1.5	1.5	2.0	10.05	8.100	0.000	1.300
OPERATING ENGINEER		HWY	4	39.100	39.100	1.5	1.5	2.0	10.05	8.100	0.000	1.300

PAINTER		ALL	28.580	30.080	1.5	1.5	2.0	5.000	8.580	0.000	0.550
PAINTER OVER 30FT		ALL	29.580	31.080	1.5	1.5	2.0	5.000	8.580	0.000	0.550
PAINTER PWR EQMT		ALL	29.580	31.080	1.5	1.5	2.0	5.000	8.580	0.000	0.550
PILEDRIVER		BLD	30.310	32.560	1.5	1.5	2.0	7.450	12.44	0.000	0.520
PILEDRIVER		HWY	30.810	32.560	1.5	1.5	2.0	7.450	12.99	0.000	0.520
PIPEFITTER	E	BLD	36.050	39.050	1.5	1.5	2.0	7.000	7.650	0.000	1.220
PIPEFITTER	W	BLD	40.020	44.020	1.5	1.5	2.0	7.000	7.750	0.000	0.900
PLASTERER		BLD	28.500	30.250	1.5	1.5	2.0	7.330	11.29	0.000	0.500
PLUMBER	E	BLD	36.050	39.050	1.5	1.5	2.0	7.000	7.650	0.000	1.220
PLUMBER	W	BLD	40.020	44.020	1.5	1.5	2.0	7.000	7.750	0.000	0.900
ROOFER		BLD	27.900	30.400	1.5	1.5	2.0	8.600	6.750	0.000	0.500
SHEETMETAL WORKER		BLD	31.560	33.810	1.5	1.5	2.0	8.300	12.59	0.000	0.550
SPRINKLER FITTER		BLD	36.390	39.140	1.5	1.5	2.0	8.420	8.500	0.000	0.450
STONE MASON		BLD	29.130	29.880	2.0	2.0	2.0	8.200	10.03	0.000	0.580
TERRAZZO FINISHER		BLD	25.480	0.000	1.5	1.5	2.0	8.200	8.930	0.000	0.000
TERRAZZO MASON		BLD	26.980	27.730	1.5	1.5	2.0	8.200	8.930	0.000	0.000
TILE MASON		BLD	26.980	27.730	1.5	1.5	2.0	8.200	8.930	0.000	0.000
TRUCK DRIVER		ALL 1	31.340	0.000	1.5	1.5	2.0	10.30	5.010	0.000	0.250
TRUCK DRIVER		ALL 2	31.780	0.000	1.5	1.5	2.0	10.30	5.010	0.000	0.250
TRUCK DRIVER		ALL 3	32.020	0.000	1.5	1.5	2.0	10.30	5.010	0.000	0.250
TRUCK DRIVER		ALL 4	32.280	0.000	1.5	1.5	2.0	10.30	5.010	0.000	0.250
TRUCK DRIVER		ALL 5	33.130	0.000	1.5	1.5	2.0	10.30	5.010	0.000	0.250
TRUCK DRIVER		O&C 1	25.070	0.000	1.5	1.5	2.0	10.30	5.010	0.000	0.250
TRUCK DRIVER		O&C 2	25.420	0.000	1.5	1.5	2.0	10.30	5.010	0.000	0.250
TRUCK DRIVER		O&C 3	25.620	0.000	1.5	1.5	2.0	10.30	5.010	0.000	0.250
TRUCK DRIVER		O&C 4	25.820	0.000	1.5	1.5	2.0	10.30	5.010	0.000	0.250
TRUCK DRIVER		O&C 5	26.500	0.000	1.5	1.5	2.0	10.30	5.010	0.000	0.250
TUCKPOINTER		BLD	29.130	29.880	2.0	2.0	2.0	8.200	10.03	0.000	0.580

Legend :

RG (Region)

TYP (Trade Type - All,Highway,Building,Floating,Oil & Chip,Rivers)

C (Class)

Base (Base Wage Rate)

FRMAN (Foreman Rate)

M-F>8 (OT required for any hour greater than 8 worked each day, Mon through Fri.

OSA (Overtime (OT) is required for every hour worked on Saturday)

OSH (Overtime is required for every hour worked on Sunday and Holidays)

H/W (Health & Welfare Insurance)

Pensn (Pension)

Vac (Vacation)

Trng (Training)

Explanations

CHRISTIAN COUNTY

PLUMBERS & PIPEFITTERS (WEST) - That area lying west of a north/south

line running from the western edge of Macon County to the town of Ohlman (Montgomery County).

The following list is considered as those days for which holiday rates of wages for work performed apply: New Years Day, Memorial Day, Fourth of July, Labor Day, Thanksgiving Day, Christmas Day and Veterans Day in some classifications/counties. Generally, any of these holidays which fall on a Sunday is celebrated on the following Monday. This then makes work performed on that Monday payable at the appropriate overtime rate for holiday pay. Common practice in a given local may alter certain days of celebration. If in doubt, please check with IDOL.

Oil and chip resealing (O&C) means the application of road oils and liquid asphalt to coat an existing road surface, followed by application of aggregate chips or gravel to coated surface, and subsequent rolling of material to seal the surface.

EXPLANATION OF CLASSES

ASBESTOS - GENERAL - removal of asbestos material/mold and hazardous materials from any place in a building, including mechanical systems where those mechanical systems are to be removed. This includes the removal of asbestos materials/mold and hazardous materials from ductwork or pipes in a building when the building is to be demolished at the time or at some close future date.

ASBESTOS - MECHANICAL - removal of asbestos material from mechanical systems, such as pipes, ducts, and boilers, where the mechanical systems are to remain.

CERAMIC TILE FINISHER, MARBLE FINISHER, TERRAZZO FINISHER

Assisting, helping or supporting the tile, marble and terrazzo mechanic by performing their historic and traditional work assignments required to complete the proper installation of the work covered by said crafts. The term "Ceramic" is used for naming the classification only and is in no way a limitation of the product handled. Ceramic takes into consideration most hard tiles.

ELECTRONIC SYSTEMS TECHNICIAN

Installation, service and maintenance of low-voltage systems which utilizes the transmission and/or transference of voice, sound, vision, or digital for commercial, education, security and entertainment purposes for the following: TV monitoring and surveillance, background/foreground music, intercom and telephone interconnect, field programming, inventory control systems, microwave transmission, multi-media, multiplex, radio page, school, intercom and sound burglar alarms and low voltage master clock systems.

Excluded from this classification are energy management systems, life safety systems, supervisory controls and data acquisition systems not intrinsic with the above listed systems, fire alarm systems, nurse call systems and raceways exceeding fifteen feet in length.

TRUCK DRIVER - BUILDING, HEAVY AND HIGHWAY CONSTRUCTION

Class 1. Drivers on 2 axle trucks hauling less than 9 ton. Air compressor and welding machines and brooms, including those pulled by separate units, truck driver helpers, warehouse employees, mechanic helpers, greasers and tiremen, pickup trucks when hauling materials, tools, or workers to and from and on-the-job site, and fork lifts up to 6,000 lb. capacity.

Class 2. Two or three axle trucks hauling more than 9 ton but hauling less than 16 ton. A-frame winch trucks, hydrolift trucks, vector trucks or similar equipment when used for transportation purposes. Fork lifts over 6,000 lb. capacity, winch trucks, four axle combination units, and ticket writers.

Class 3. Two, three or four axle trucks hauling 16 ton or more. Drivers on water pulls, articulated dump trucks, mechanics and working forepersons, and dispatchers. Five axle or more combination units.

Class 4. Low Boy and Oil Distributors.

Class 5. Drivers who require special protective clothing while employed on hazardous waste work.

TRUCK DRIVER - OIL AND CHIP RESEALING ONLY.

This shall encompass laborers, workers and mechanics who drive contractor or subcontractor owned, leased, or hired pickup, dump, service, or oil distributor trucks. The work includes transporting materials and equipment (including but not limited to, oils, aggregate supplies, parts, machinery and tools) to or from the job site; distributing oil or liquid asphalt and aggregate; stock piling material when in connection with the actual oil and chip contract. The Truck Driver (Oil & Chip Resealing) wage classification does not include supplier delivered materials.

OPERATING ENGINEERS - BUILDING

CLASS 1. Asphalt Screed Man; Aspco Concrete Spreaders; Asphalt Pavers; Asphalt Plant Engineer; Asphalt Rollers on Bituminous Concrete; Athey Loaders; Backfillers, Crane Type; Backhoes; Barber Green Loaders; Bulldozers; Cableways; Cherry Pickers; Clam Shells; C.M.I. & similar type autograde formless paver, autograde placer & finisher; Concrete Breakers; Concrete Pumps; Derricks; Derrick Boats; Draglines; Earth Auger or Boring Machines; Elevating Graders; Engineers on Dredges; Gravel Processing Machines; Head Equipment Greaser; High Lifts or Fork Lifts; Hoists with two or more drums or two or more load lines; Locomotives, All; Mechanics; Motor Graders or Auto Patrols; Operators or Leverman on Dredges; Operators, Power Boat; Operators, Pug Mill (Asphalt Plants); Orange Peels; Overhead Cranes; Paving Mixers; Piledrivers; Pipe Wrapping and Painting Machines; Pushdozers, or Push Cats; Robotic Controlled Equipment in this Classification; Rock Crushers; Ross Carrier or Similar Machines; Rotomill; Scoops, Skimmer, two cu. yd. capacity and under; Scoops, All or Tournapull; Sheep-Foot Roller (SelfPropelled); Shovels; Skid Steer; Skimmer Scoops; Temporary Concrete Plant Operators; Test Hole Drilling Machines; Tower Machines; Tower Mixers; Track Type End Loaders; Track Type Fork Lifts or High Lifts; Track Jacks and Tampers; Tractors, Sideboom; Trenching or Ditching Machine; Tunnelluggers; Vermeer Type Saws; Water Blaster Cutting Head; Wheel Type End Loaders; Winch Cat.

CLASS 2. Air Compressors (six to eight)*; Asphalt Boosters and Heaters; Asphalt Distributors; Asphalt Plant Fireman; Oiler on Two Paving Mixers When Used in Tandem; Boom or Winch Trucks; Bull Floats or Flexplanes; Concrete Finishing Machine; Concrete Saws, Self-Propelled; Concrete Spreading Machines; Conveyors (six to eight)*; Generators (six to eight)*; Gravel or Stone Spreader, Power Operated; Hoist (with One Drum and One Load Line); Light Plants (six to eight)*; Mechanical Heaters (six to eight)*; Mud Jacks; Post Hole Digger, Mechanical; Pug Mills when used for other than Asphalt operation; Robotic Controlled Equipment in this Classification; Road or Street Sweeper, Self Propelled; Rollers (except bituminous concrete); Seaman Tiller; Straw Machine; Vibratory Compactor; Water

Blaster, Power Unit; Welding Machines (six to eight)*; Well Drill Machines.

CLASS 3. Air Compressors(one to five)*; Air Compressors, Track or Self-Propelled; Automatic Hoist; Building Elevators; Bulk Cement Batching Plants; Conveyors (one to five)*; Concrete Mixers (Except Plant, Paver, or Tower); Firemen; Generators (one to five)*; Greasers; Helper on Single Paving Mixer; Hoist, Automatic; Light Plants (one to five)*; Mechanic Helpers; Mechanical Heaters (one to five)*; Oilers; Power Form Graders; Power Sub-Graders; Robotic Controlled Equipment in this Classification; Scissors Hoist; Tractors without power attachments regardless of size or type; Truck Crane Oiler and Driver (1 man); Vibratory Hammer (power source); Water Pumps (one to five)*; Welding Machines (1/300 Amp. or over)*; Welding machines (one to five)*

CLASS 4. Lattice Boom Crawler Cranes; Lattice Boom Truck Cranes; Telescopic Truck-Mounted Cranes; Tower Cranes.

* Combinations of one to eight of any Air Compressors, Conveyors, Welding Machines, Water Pumps, Light Plants, or Generators shall be in batteries or within 400 feet and shall be paid as per the Classification Schedule contained in this Article.

OPERATING ENGINEERS - HIGHWAY

CLASS 1. Asphalt Screed Man; Asphco Concrete Spreaders; Asphalt Pavers; Asphalt Plant Engineer; Asphalt Rollers on Bituminous Concrete; Athey Loaders; Backhoes; Barber Green Loaders; Bulldozers; Cableways; Carry Deck Pickers; Cherry Pickers (Rough Terrain); C.M.I. & similar type-autograde formless paver, autograde placer & finisher; Concrete Breakers; Concrete Plant Operators; Concrete Pumps; Derricks; Derrick Boats; Dewatering Systems; Earth Auger or Boring Machines; Elevating Graders; Engineers on Dredges; Gravel Processing Machines; Grout Pump; Head Equipment Greaser; High Lifts or Fork Lifts; Hoists with two or more drums or two or more load lines; Hydro Jet or Hydro Laser; Locomotives, All; Mechanics; Motor Graders or Auto Patrols; Multi-Point Power Lifting Equipment; Operators or Leverman on Dredges; Operators, Power Boat; Operators, Pug Mill (Asphalt Plants); Overhead Cranes; Paving Mixers; Piledrivers; Pipe Wrapping and Painting Machines; Push-dozers, or Push Cats; Robotic Controlled Equipment in this Classification; Rock Crushers; Ross Carrier or Similar Machines; Roto-Mill; Scoops, Skimmer, two cu. yd. capacity and under; Sheep-Foot Roller (Self Pro-pelled); Shovels; Skid Steer; Skimmer Scoops; Test Hole Drilling Machines; Tower Machines; Tower Mixers; Track Type End Loaders; Track Type Fork Lifts or High Lifts; Track Jacks and Tampers; Tractors, Side-boom; Trenching or Ditching Machine; Tunnelluggers; Vermeer-Type Saws; Wheel Type End Loaders; Winch Cat; Scoops, All or Tournapull.

CLASS 2. Air Compressors (six to eight)*; Articulated Dumps; Asphalt Boosters and Heaters; Asphalt Distributors; Asphalt Plant Fireman; Boom or Winch Trucks; Building Elevators; Bull Floats or Flexplanes; Concrete Finishing Machine; Concrete Saws, Self-Propelled; Concrete Spreading Machines; Conveyors (six to eight)*; Generators (six to eight)*; Gravel or Stone Spreader, Power Operated; Hoist, Automatic; Hoist with One Drum and One Load Line; Light Plants (six to eight)*; Mechanical Heaters (six to eight)*; Mud Jacks; Off Road Water Wagons; Oiler on Two Paving Mixers When Used in Tandem; Post Hole Digger, Mechanical; Robotic Controlled Equipment in This Classification; Road or Street Sweeper, Self-Propelled; Rollers (except bituminous concrete); Scissor Hoist; Sea-man Tiller; Straw Machine; Vibratory Compactor; Water Pumps (six to eight)*; Well Drill Machines.

CLASS 3. Air Compressors (one to five)*; Air Compressors, Track or Self-Propelled; Bulk Cement Batching Plants; Conveyors (one to five)*; Concrete Mixers (Except Plant, Paver, or Tower); Firemen; Generators (one to five)*; Greasers; Helper on Single Paving Mixer; Light Plants (one to five)*; Mechanic Helpers; Mechanical Heaters (one to five)*; Oilers; Power Form Graders; Power Sub-Graders; Pug Mills when used for other than Asphalt operation; Robotic Controlled Equipment in This Classification; Tractors without power attachments, regardless of size or type; Truck Crane Oiler and Driver (1 man); Vibratory Hammer (power source); Water Pumps (one to five)*; Welding Machines (one 300 Amp. or over)*; Welding Machines (one to five)*.

CLASS 4. Lattice Boom Crawler Crane; Lattice Boom Truck Crane; Telescopic Truck-Mounted Crane; Tower Crane.

*Combinations of one to eight of any Air Compressors, Conveyors, Welding Machines, Water Pumps, Light Plants or Generators shall be in batteries or within 400 feet and shall be paid as per the Classification Schedule contained in this Article.

Other Classifications of Work:

For definitions of classifications not otherwise set out, the Department generally has on file such definitions which are available. If a task to be performed is not subject to one of the classifications of pay set out, the Department will upon being contacted state which neighboring county has such a classification and provide such rate, such rate being deemed to exist by reference in this document. If no neighboring county rate applies to the task, the Department shall undertake a special determination, such special determination being then deemed to have existed under this determination. If a project requires these, or any classification not listed, please contact IDOL at 217-782-1710 for wage rates or clarifications.

LANDSCAPING

Landscaping work falls under the existing classifications for laborer, operating engineer and truck driver. The work performed by landscape plantsman and landscape laborer is covered by the existing classification of laborer. The work performed by landscape operators (regardless of equipment used or its size) is covered by the classifications of operating engineer. The work performed by landscape truck drivers (regardless of size of truck driven) is covered by the classifications of truck driver.

Clark County Prevailing Wage for May 2013

(See explanation of column headings at bottom of wages)

Trade Name	RG	TYP	C	Base	FRMAN	M-F>8	OSA	OSH	H/W	Pensn	Vac	Trng
=====	==	===	=	=====	=====	=====	===	===	=====	=====	=====	=====
ASBESTOS ABT-GEN		BLD		29.710	30.960	1.5	1.5	2.0	5.750	9.920	0.000	0.900
ASBESTOS ABT-MEC		BLD		20.450	21.450	1.5	1.5	2.0	6.250	5.000	0.000	0.000
BOILERMAKER		BLD		31.500	34.000	1.5	1.5	2.0	7.070	18.73	1.000	0.350
BRICK MASON		BLD		29.000	30.500	2.0	2.0	2.0	6.600	9.730	0.000	0.630
CARPENTER		BLD		29.600	31.850	1.5	1.5	2.0	7.450	12.65	0.000	0.520
CARPENTER		HWY		29.950	31.700	1.5	1.5	2.0	7.450	12.65	0.000	0.520
CEMENT MASON		BLD		29.800	31.300	1.5	1.5	2.0	6.600	8.360	0.000	0.500
CEMENT MASON		HWY		30.390	31.890	1.5	1.5	2.0	6.600	8.560	0.000	0.500
CERAMIC TILE FNSHER		BLD		28.400	0.000	1.5	1.5	2.0	6.600	7.930	0.000	0.000
COMM SYSTEMS TECH		BLD		26.110	28.700	1.5	1.5	2.0	5.350	5.680	0.000	0.290

ELECTRIC PWR EQMT OP	ALL	1	35.570	0.000	1.5	1.5	2.0	5.000	9.960	0.000	0.360
ELECTRIC PWR EQMT OP	ALL	2	31.740	0.000	1.5	1.5	2.0	5.000	8.880	0.000	0.320
ELECTRIC PWR GRNDMAN	ALL		26.100	0.000	1.5	1.5	2.0	5.000	7.310	0.000	0.260
ELECTRIC PWR LINEMAN	ALL		44.630	47.650	1.5	1.5	2.0	5.000	12.50	0.000	0.450
ELECTRICIAN	BLD		34.920	37.360	1.5	1.5	2.0	5.350	9.030	0.000	0.290
ELEVATOR CONSTRUCTOR	BLD		40.520	45.585	2.0	2.0	2.0	11.88	12.71	3.240	0.600
GLAZIER	BLD		26.580	28.080	1.5	1.5	2.0	6.160	5.310	0.000	0.400
HT/FROST INSULATOR	BLD		31.230	32.230	1.5	1.5	2.0	5.790	8.960	2.000	0.250
IRON WORKER	ALL		28.600	31.460	1.5	1.5	2.0	6.450	11.30	0.000	0.300
LABORER	BLD		27.710	28.960	1.5	1.5	2.0	5.750	9.920	0.000	0.800
LABORER	HWY		29.120	30.120	1.5	1.5	2.0	5.750	9.920	0.000	0.800
LATHER	BLD		29.600	31.850	1.5	1.5	2.0	7.450	12.65	0.000	0.520
MACHINIST	BLD		43.550	46.050	1.5	1.5	2.0	6.130	8.950	1.850	0.000
MARBLE FINISHERS	BLD		28.400	0.000	1.5	1.5	2.0	6.600	7.930	0.000	0.000
MARBLE MASON	BLD		29.900	0.000	1.5	1.5	2.0	6.600	7.930	0.000	0.000
MILLWRIGHT	BLD		29.620	31.870	1.5	1.5	2.0	7.450	13.09	0.000	0.520
MILLWRIGHT	HWY		31.400	33.150	1.5	1.5	2.0	7.450	13.54	0.000	0.520
OPERATING ENGINEER	ALL	1	36.950	0.000	1.5	1.5	2.0	7.250	8.700	0.000	0.800
OPERATING ENGINEER	ALL	2	23.900	0.000	1.5	1.5	2.0	7.250	8.700	0.000	0.800
PAINTER	ALL		26.000	27.500	1.5	1.5	2.0	7.700	8.230	0.000	0.450
PILEDRIVER	BLD		30.100	32.350	1.5	1.5	2.0	7.450	12.65	0.000	0.520
PILEDRIVER	HWY		30.950	32.700	1.5	1.5	2.0	7.450	12.65	0.000	0.520
PIPEFITTER	ALL		35.820	38.510	1.5	1.5	2.0	6.100	6.630	0.000	0.610
PLASTERER	BLD		30.000	32.000	1.5	1.5	2.0	6.600	10.17	0.000	0.500
PLUMBER	ALL		35.820	38.510	1.5	1.5	2.0	6.100	6.630	0.000	0.610
ROOFER	BLD		28.750	30.250	1.5	1.5	2.0	9.150	8.400	0.000	0.200
SHEETMETAL WORKER	BLD		31.390	32.960	1.5	1.5	2.0	7.350	7.690	0.000	1.090
SPRINKLER FITTER	BLD		36.390	39.140	1.5	1.5	2.0	8.420	8.500	0.000	0.450
STONE MASON	BLD		29.000	30.500	2.0	2.0	2.0	6.600	9.730	0.000	0.630
TERRAZZO FINISHER	BLD		28.400	0.000	1.5	1.5	2.0	6.600	7.930	0.000	0.000
TERRAZZO MASON	BLD		29.900	0.000	1.5	1.5	2.0	6.600	7.930	0.000	0.000
TILE LAYER	BLD		29.600	31.850	1.5	1.5	2.0	7.450	12.65	0.000	0.520
TILE MASON	BLD		29.900	0.000	1.5	1.5	2.0	6.600	7.930	0.000	0.000
TRUCK DRIVER	ALL	1	28.955	0.000	1.5	1.5	2.0	9.300	2.900	0.000	0.250
TRUCK DRIVER	ALL	2	29.355	0.000	1.5	1.5	2.0	9.300	2.900	0.000	0.250
TRUCK DRIVER	ALL	3	29.555	0.000	1.5	1.5	2.0	9.300	2.900	0.000	0.250
TRUCK DRIVER	ALL	4	29.805	0.000	1.5	1.5	2.0	9.300	2.900	0.000	0.250
TRUCK DRIVER	ALL	5	30.555	0.000	1.5	1.5	2.0	9.300	2.900	0.000	0.250
TRUCK DRIVER	O&C	1	23.160	0.000	1.5	1.5	2.0	9.300	2.900	0.000	0.250
TRUCK DRIVER	O&C	2	23.480	0.000	1.5	1.5	2.0	9.300	2.900	0.000	0.250
TRUCK DRIVER	O&C	3	23.640	0.000	1.5	1.5	2.0	9.300	2.900	0.000	0.250
TRUCK DRIVER	O&C	4	23.840	0.000	1.5	1.5	2.0	9.300	2.900	0.000	0.250
TRUCK DRIVER	O&C	5	24.440	0.000	1.5	1.5	2.0	9.300	2.900	0.000	0.250
TUCKPOINTER	BLD		29.000	30.500	2.0	2.0	2.0	6.600	9.730	0.000	0.630

Legend :

RG (Region)

TYP (Trade Type - All,Highway,Building,Floating,Oil & Chip,Rivers)

C (Class)

Base (Base Wage Rate)

FRMAN (Foreman Rate)

M-F>8 (OT required for any hour greater than 8 worked each day, Mon through Fri.)

OSA (Overtime (OT) is required for every hour worked on Saturday)

OSH (Overtime is required for every hour worked on Sunday and Holidays)

H/W (Health & Welfare Insurance)

Pensn (Pension)

Vac (Vacation)

Trng (Training)

Explanations

CLARK COUNTY

The following list is considered as those days for which holiday rates of wages for work performed apply: New Years Day, Memorial Day, Fourth of July, Labor Day, Thanksgiving Day, Christmas Day and Veterans Day in some classifications/counties. Generally, any of these holidays which fall on a Sunday is celebrated on the following Monday. This then makes work performed on that Monday payable at the appropriate overtime rate for holiday pay. Common practice in a given local may alter certain days of celebration. If in doubt, please check with IDOL.

Oil and chip resealing (O&C) means the application of road oils and liquid asphalt to coat an existing road surface, followed by application of aggregate chips or gravel to coated surface, and subsequent rolling of material to seal the surface.

EXPLANATION OF CLASSES

ASBESTOS - GENERAL - removal of asbestos material/mold and hazardous materials from any place in a building, including mechanical systems where those mechanical systems are to be removed. This includes the removal of asbestos materials/mold and hazardous materials from ductwork or pipes in a building when the building is to be demolished at the time or at some close future date.

ASBESTOS - MECHANICAL - removal of asbestos material from mechanical systems, such as pipes, ducts, and boilers, where the mechanical systems are to remain.

CERAMIC TILE FINISHER, MARBLE FINISHER, TERRAZZO FINISHER

Assisting, helping or supporting the tile, marble and terrazzo mechanic by performing their historic and traditional work assignments required to complete the proper installation of the work covered by said crafts. The term "Ceramic" is used for naming the classification only and is in no way a limitation of the product handled. Ceramic takes into consideration most hard tiles.

COMMUNICATION SYSTEMS TECHNICIAN

Installation, operation, inspection, maintenance, repair, and service of radio, television, recording, voice sound and vision production and reproduction apparatus, equipment and appliances used for domestic, commercial, education, entertainment and private telephone systems.

ELECTRIC POWER LINEMAN

Construction, maintenance and dismantling of overhead and underground electric power lines, including high voltage pipe type cable work, and associated structures and equipment.

ELECTRIC POWER EQUIPMENT OPERATOR - CLASS 1

Operation of all crawler type equipment D-4 and larger from the ground to assist the Electric Power Linemen in performing their duties.

ELECTRIC POWER EQUIPMENT OPERATORS - CLASS 2

Operation of all other equipment from the ground to assist the Electric Power Linemen in performing their duties.

ELECTRIC POWER GROUNDMAN

Applies to workers who assist the Electric Power Lineman from the ground.

TRUCK DRIVER - BUILDING, HEAVY AND HIGHWAY CONSTRUCTION

Class 1. Drivers on 2 axle trucks hauling less than 9 ton. Air compressor and welding machines and brooms, including those pulled by separate units, truck driver helpers, warehouse employees, mechanic helpers, greasers and tiremen, pickup trucks when hauling materials, tools, or workers to and from and on-the-job site, and fork lifts up to 6,000 lb. capacity.

Class 2. Two or three axle trucks hauling more than 9 ton but hauling less than 16 ton. A-frame winch trucks, hydrolift trucks, vactor trucks or similar equipment when used for transportation purposes. Fork lifts over 6,000 lb. capacity, winch trucks, four axle combination units, and ticket writers.

Class 3. Two, three or four axle trucks hauling 16 ton or more. Drivers on water pulls, articulated dump trucks, mechanics and working forepersons, and dispatchers. Five axle or more combination units.

Class 4. Low Boy and Oil Distributors.

Class 5. Drivers who require special protective clothing while employed on hazardous waste work.

TRUCK DRIVER - OIL AND CHIP RESEALING ONLY.

This shall encompass laborers, workers and mechanics who drive contractor or subcontractor owned, leased, or hired pickup, dump, service, or oil distributor trucks. The work includes transporting materials and equipment (including but not limited to, oils, aggregate supplies, parts, machinery and tools) to or from the job site; distributing oil or liquid asphalt and aggregate; stock piling material when in connection with the actual oil and chip contract. The Truck Driver (Oil & Chip Resealing) wage classification does not include supplier delivered materials.

OPERATING ENGINEERS - BUILDING, HEAVY AND HIGHWAY CONSTRUCTION

Class 1. Power Cranes, Draglines, Derricks, Shovels, Gradalls, Mechanics, Tractor Highlift, Tournadozer, Concrete Mixers with Skip, Tournamixer, Two Drum Machine, One Drum Hoist with Tower or Boom, Cableways, Tower Machines, Motor Patrol, Boom Tractor, Boom or Winch Truck, Winch or Hydraulic Boom Truck, Truck Crane, Tournapull, Tractor Operating Scoops, Bulldozer, Push Tractor, Asphalt Planer, Finishing Machine on Asphalt, Large Rollers on Earth, Rollers on Asphalt Mix, Ross Carrier or similar Machine, Gravel Processing Machine, Asphalt Plant Engineer, Paver Operator, Dredging Equipment, or Dredge Engineer, or Dredge Operator, Central Mix Plant Engineer, CMI or similar type machine, Concrete Pump, Truck or Skid Mounted, Tower Crane, Engineer or Rock Crusher Plant, Concrete Plant Engineer, Ditching Machine with dual attachment, Tractor Mounted Loaders, Cherry Picker, Hydro Crane, Standard or Dinkey Locomotives,

Scoopmobiles, Euclid Loader, Soil Cement Machine, Back Filler, Elevating Machine, Power Blade, Drilling Machine, including Well Testing, Caissons, Shaft or any similar type drilling machines, Motor Driven Paint Machine, Pipe Cleaning Machine, Pipe Wrapping Machine, Pipe Bending Machine, Apsco Paver, Boring Machine, (Head Equipment Greaser), Barber-Greene Loaders, Formless Paver, (Well Point System), Concrete Spreader, Hydra Ax, Span Saw, Marine Scoops, Brush Mulcher, Brush Burner, Mesh Placer, Tree Mover, Helicopter Crew (3), Piledriver-Skid or Crawler, Stump Remover, Root Rake, Tug Boat Operator, Refrigerating Machine, Freezing Operator, Chair Cart-Self-Propelled, Hydra Seeder, Straw Blower, Power Sub Grader, Bull Float, Finishing Machine, Self-Propelled Pavement Breaker, Lull (or similar type Machine), Two Air Compressors, Compressors hooked in Manifold, Overhead Crane, Chip Spreader, Mud Cat, Sull-Air, Fork Lifts (except when used for landscaping work), Soil Stabilizer (Seaman Tiller, Bo Mag, Rago Gator, and similar types of equipment), Tube Float, Spray Machine, Curing Machine, Concrete or Asphalt Milling Machine, Snooper Truck-Operator, Backhoe, Farm Tractors (with attachments), 4 Point Lift System (Power Lift or similar type), Skid-Steer (Bob Cat or similar type), Wrecking Shears, Water Blaster.

Class 2. Concrete Mixers without Skips, Rock Crusher, Ditching Machine under 6', Curbing Machine, One Drum Machines without Tower or Boom, Air Tugger, Self-Propelled Concrete Saw, Machine Mounted Post Hole Digger, two to four Generators, Water Pumps or Welding Machines, within 400 feet, Air Compressor 600 cu. ft. and under, Rollers on Aggregate and Seal Coat Surfaces, Fork Lift (when used for landscaping work), Concrete and Blacktop Curb Machine, One Water Pump, Oilers, Air Valves or Steam Valves, One Welding Machine, Truck Jack, Mud Jack, Gunnite Machine, House Elevators when used for hoisting material, Engine Tenders, Fireman, Wagon Drill, Flex Plane, Conveyor, Siphons and Pulsometer, Switchman, Fireman on Paint Pots, Fireman on Asphalt Plants, Distributor Operator on Trucks, Tampers, Self-Propelled Power Broom, Striping Machine (motor driven), Form Tamper, Bulk Cement Plant, Equipment Greaser, Deck Hands, Truck Crane Oiler-Driver, Cement Blimps, Form Grader, Temporary Heat, Throttle Valve, Super Sucker (and similar type of equipment).

Other Classifications of Work:

For definitions of classifications not otherwise set out, the Department generally has on file such definitions which are available. If a task to be performed is not subject to one of the classifications of pay set out, the Department will upon being contacted state which neighboring county has such a classification and provide such rate, such rate being deemed to exist by reference in this document. If no neighboring county rate applies to the task, the Department shall undertake a special determination, such special determination being then deemed to have existed under this determination. If a project requires these, or any classification not listed, please contact IDOL at 217-782-1710 for wage rates or clarifications.

LANDSCAPING

Landscaping work falls under the existing classifications for laborer, operating engineer and truck driver. The work performed by landscape plantsman and landscape laborer is covered by the existing classification of laborer. The work performed by landscape operators (regardless of equipment used or its size) is covered by the classifications of operating engineer. The work performed by landscape truck drivers (regardless of size of truck driven) is covered by the classifications of truck driver.

Clay County Prevailing Wage for May 2013

(See explanation of column headings at bottom of wages)

Trade Name	RG	TYP	C	Base	FRMAN	M-F>8	OSA	OSH	H/W	Pensn	Vac	Trng
=====	==	===	=	=====	=====	=====	===	===	=====	=====	=====	=====
ASBESTOS ABT-GEN		ALL		25.300	25.750	1.5	1.5	2.0	5.750	10.35	0.000	0.900
ASBESTOS ABT-MEC		BLD		21.150	22.150	1.5	1.5	2.0	6.400	5.150	0.000	0.650
BOILERMAKER		BLD		31.500	34.000	1.5	1.5	2.0	7.070	18.73	1.000	0.350
BRICK MASON		BLD		28.620	30.120	1.5	1.5	2.0	8.200	7.030	0.000	0.430
CARPENTER		BLD		31.890	33.390	1.5	1.5	2.0	6.550	6.750	0.000	0.400
CARPENTER		HWY		31.890	33.640	1.5	1.5	2.0	6.550	6.750	0.000	0.400
CEMENT MASON		BLD		28.200	29.700	1.5	1.5	2.0	6.600	5.400	0.000	0.500
CEMENT MASON		HWY		27.080	28.580	1.5	1.5	2.0	6.600	5.800	0.000	0.300
CERAMIC TILE FNSHER		BLD		27.120	0.000	1.5	1.5	2.0	8.200	7.030	0.000	0.430
ELECTRIC PWR EQMT OP		ALL	1	35.570	0.000	1.5	1.5	2.0	5.000	9.960	0.000	0.360
ELECTRIC PWR EQMT OP		ALL	2	31.740	0.000	1.5	1.5	2.0	5.000	8.880	0.000	0.320
ELECTRIC PWR GRNDMAN		ALL		26.100	0.000	1.5	1.5	2.0	5.000	7.310	0.000	0.260
ELECTRIC PWR LINEMAN		ALL		44.630	47.650	1.5	1.5	2.0	5.000	12.50	0.000	0.450
ELECTRICIAN		ALL		39.350	41.600	1.5	1.5	2.0	6.140	9.440	0.000	0.790
ELECTRONIC SYS TECH		BLD		32.570	34.320	1.5	1.5	2.0	6.000	4.240	0.000	0.400
FLOOR LAYER		BLD		29.330	30.080	1.5	1.5	2.0	6.550	6.750	0.000	0.400
GLAZIER		BLD		26.780	28.030	1.5	1.5	2.0	6.120	5.200	0.000	0.300
HT/FROST INSULATOR		BLD		29.450	30.450	1.5	1.5	2.0	5.050	9.730	0.000	0.280
IRON WORKER		ALL		27.020	28.270	1.5	1.5	2.0	7.010	9.200	0.000	0.345
LABORER		BLD		25.300	25.750	1.5	1.5	2.0	5.750	10.35	0.000	0.800
LABORER		HWY		25.300	25.750	1.5	1.5	2.0	5.750	10.35	0.000	0.800
MACHINIST		BLD		43.550	46.050	1.5	1.5	2.0	6.130	8.950	1.850	0.000
MARBLE FINISHERS		BLD		27.120	0.000	1.5	1.5	2.0	8.200	7.030	0.000	0.430
MARBLE MASON		BLD		28.620	30.120	1.5	1.5	2.0	8.200	7.030	0.000	0.430
MILLWRIGHT		BLD		31.890	33.390	1.5	1.5	2.0	6.550	6.750	0.000	0.400
MILLWRIGHT		HWY		32.390	34.140	1.5	1.5	2.0	6.550	6.750	0.000	0.400
OPERATING ENGINEER		ALL	1	36.950	0.000	1.5	1.5	2.0	7.250	8.700	0.000	0.800
OPERATING ENGINEER		ALL	2	23.900	0.000	1.5	1.5	2.0	7.250	8.700	0.000	0.800
PAINTER		ALL		23.190	23.690	1.5	1.5	2.0	5.000	6.840	0.000	0.480
PAINTER OVER 30FT		ALL		26.290	26.790	1.5	1.5	2.0	5.000	6.840	0.000	0.480
PAINTER PWR EQMT		ALL		26.290	26.790	1.5	1.5	2.0	5.000	6.840	0.000	0.480
PILEDRIVER		BLD		31.890	33.390	1.5	1.5	2.0	6.550	6.750	0.000	0.400
PILEDRIVER		HWY		32.390	34.140	1.5	1.5	2.0	6.550	6.750	0.000	0.400
PIPEFITTER		BLD		34.450	37.900	1.5	1.5	2.0	6.050	6.550	0.000	0.800
PLASTERER		BLD		28.200	29.700	1.5	1.5	2.0	6.600	5.400	0.000	0.500
PLUMBER		BLD		34.450	37.900	1.5	1.5	2.0	6.050	6.550	0.000	0.800
ROOFER		BLD		26.100	28.600	1.5	1.5	2.0	9.600	6.280	0.000	0.550
SHEETMETAL WORKER		ALL		31.690	33.190	1.5	1.5	2.0	7.130	6.730	1.910	0.360
SPRINKLER FITTER		BLD		36.390	39.140	1.5	1.5	2.0	8.420	8.500	0.000	0.450
STONE MASON		BLD		28.620	30.120	1.5	1.5	2.0	8.200	7.030	0.000	0.430
TERRAZZO FINISHER		BLD		27.120	0.000	1.5	1.5	2.0	8.200	7.030	0.000	0.430
TERRAZZO MASON		BLD		28.620	30.120	1.5	1.5	2.0	8.200	7.030	0.000	0.430
TILE MASON		BLD		28.620	30.120	1.5	1.5	2.0	8.200	7.030	0.000	0.430
TRUCK DRIVER		ALL	1	31.340	0.000	1.5	1.5	2.0	10.30	5.010	0.000	0.250
TRUCK DRIVER		ALL	2	31.780	0.000	1.5	1.5	2.0	10.30	5.010	0.000	0.250
TRUCK DRIVER		ALL	3	32.020	0.000	1.5	1.5	2.0	10.30	5.010	0.000	0.250
TRUCK DRIVER		ALL	4	32.280	0.000	1.5	1.5	2.0	10.30	5.010	0.000	0.250
TRUCK DRIVER		ALL	5	33.130	0.000	1.5	1.5	2.0	10.30	5.010	0.000	0.250
TUCKPONTER		BLD		28.620	30.120	1.5	1.5	2.0	8.200	7.030	0.000	0.430

Legend:

RG (Region)

TYP (Trade Type - All,Highway,Building,Floating,Oil & Chip,Rivers)

C (Class)

Base (Base Wage Rate)

FRMAN (Foreman Rate)

M-F>8 (OT required for any hour greater than 8 worked each day, Mon through Fri.)

OSA (Overtime (OT) is required for every hour worked on Saturday)

OSH (Overtime is required for every hour worked on Sunday and Holidays)

H/W (Health & Welfare Insurance)

Pensn (Pension)

Vac (Vacation)

Trng (Training)

Explanations

CLAY COUNTY

The following list is considered as those days for which holiday rates of wages for work performed apply: New Years Day, Memorial Day, Fourth of July, Labor Day, Thanksgiving Day, Christmas Day and Veterans Day in some classifications/counties. Generally, any of these holidays which fall on a Sunday is celebrated on the following Monday. This then makes work performed on that Monday payable at the appropriate overtime rate for holiday pay. Common practice in a given local may alter certain days of celebration. If in doubt, please check with IDOL.

EXPLANATION OF CLASSES

ASBESTOS - GENERAL - removal of asbestos material/mold and hazardous materials from any place in a building, including mechanical systems where those mechanical systems are to be removed. This includes the removal of asbestos materials/mold and hazardous materials from ductwork or pipes in a building when the building is to be demolished at the time or at some close future date.

ASBESTOS - MECHANICAL - removal of asbestos material from mechanical systems, such as pipes, ducts, and boilers, where the mechanical systems are to remain.

CERAMIC TILE FINISHER, MARBLE FINISHER, TERRAZZO FINISHER

Assisting, helping or supporting the tile, marble and terrazzo mechanic by performing their historic and traditional work assignments required to complete the proper installation of the work covered by said crafts. The term "Ceramic" is used for naming the classification only, and is in no a limitation of the product handled. Ceramic takes into consideration most hard tiles.

ELECTRIC POWER LINEMAN

Construction, maintenance and dismantling of overhead and underground electric power lines, including high voltage pipe type cable work, and associated structures and equipment.

ELECTRIC POWER EQUIPMENT OPERATOR - CLASS 1

Operation of all crawler type equipment D-4 and larger from the ground to assist the Electric Power Linemen in performing their duties.

ELECTRIC POWER EQUIPMENT OPERATORS - CLASS 2

Operation of all other equipment from the ground to assist the Electric Power Linemen in performing their duties.

ELECTRIC POWER GROUNDMAN

Applies to workers who assist the Electric Power Lineman from the ground.

ELECTRONIC SYSTEMS TECHNICIAN

Installation, service and maintenance of low-voltage systems which utilizes the transmission and/or transference of voice, sound, vision, or digital for commercial, education, security and entertainment purposes for the following: TV monitoring and surveillance, background/foreground music, intercom and telephone interconnect, field programming, inventory control systems, microwave transmission, multi-media, multiplex, radio page, school, intercom and sound burglar alarms and low voltage master clock systems.

Excluded from this classification are energy management systems, life safety systems, supervisory controls and data acquisition systems not intrinsic with the above listed systems, fire alarm systems, nurse call systems and raceways exceeding fifteen feet in length.

TRUCK DRIVER - BUILDING, HEAVY AND HIGHWAY CONSTRUCTION

Class 1. Drivers on 2 axle trucks hauling less than 9 ton. Air compressor and welding machines and brooms, including those pulled by separate units, truck driver helpers, warehouse employees, mechanic helpers, greasers and tiremen, pickup trucks when hauling materials, tools, or workers to and from and on-the-job site, and fork lifts up to 6,000 lb. capacity.

Class 2. Two or three axle trucks hauling more than 9 ton but hauling less than 16 ton. A-frame winch trucks, hydrolift trucks, vactor trucks or similar equipment when used for transportation purposes. Fork lifts over 6,000 lb. capacity, winch trucks, four axle combination units, and ticket writers.

Class 3. Two, three or four axle trucks hauling 16 ton or more. Drivers on water pulls, articulated dump trucks, mechanics and working forepersons, and dispatchers. Five axle or more combination units.

Class 4. Low Boy and Oil Distributors.

Class 5. Drivers who require special protective clothing while employed on hazardous waste work.

OPERATING ENGINEERS - BUILDING, HEAVY AND HIGHWAY CONSTRUCTION

Class 1. Power Cranes, Draglines, Derricks, Shovels, Gradalls, Mechanics, Tractor Highlift, Tournadozer, Concrete Mixers with Skip, Tournamixer, Two Drum Machine, One Drum Hoist with Tower or Boom, Cableways, Tower Machines, Motor Patrol, Boom Tractor, Boom or Winch Truck, Winch or Hydraulic Boom Truck, Truck Crane, Tournapull, Tractor Operating Scoops, Bulldozer, Push Tractor, Asphalt Planer, Finishing Machine on Asphalt, Large Rollers on Earth, Rollers on Asphalt Mix, Ross Carrier or similar Machine, Gravel Processing Machine, Asphalt Plant Engineer, Paver Operator, Dredging Equipment, or Dredge Engineer, or Dredge Operator, Central Mix Plant Engineer,

CMI or similar type machine, Concrete Pump, Truck or Skid Mounted, Tower Crane, Engineer or Rock Crusher Plant, Concrete Plant Engineer, Ditching Machine with dual attachment, Tractor Mounted Loaders, Cherry Picker, Hydro Crane, Standard or Dinkey Locomotives, Scoopmobiles, Euclid Loader, Soil Cement Machine, Back Filler, Elevating Machine, Power Blade, Drilling Machine, including Well Testing, Caissons, Shaft or any similar type drilling machines, Motor Driven Paint Machine, Pipe Cleaning Machine, Pipe Wrapping Machine, Pipe Bending Machine, Apsco Paver, Boring Machine, (Head Equipment Greaser), Barber-Greene Loaders, Formless Paver, (Well Point System), Concrete Spreader, Hydra Ax, Span Saw, Marine Scoops, Brush Mulcher, Brush Burner, Mesh Placer, Tree Mover, Helicopter Crew (3), Piledriver-Skid or Crawler, Stump Remover, Root Rake, Tug Boat Operator, Refrigerating Machine, Freezing Operator, Chair Cart-Self-Propelled, Hydra Seeder, Straw Blower, Power Sub Grader, Bull Float, Finishing Machine, Self-Propelled Pavement Breaker, Lull (or similar type Machine), Two Air Compressors, Compressors hooked in Manifold, Overhead Crane, Chip Spreader, Mud Cat, Sull-Air, Fork Lifts (except when used for landscaping work), Soil Stabilizer (Seaman Tiller, Bo Mag, Rago Gator, and similar types of equipment), Tube Float, Spray Machine, Curing Machine, Concrete or Asphalt Milling Machine, Snooper Truck-Operator, Backhoe, Farm Tractors (with attachments), 4 Point Lift System (Power Lift or similar type), Skid-Steer (Bob Cat or similar type), Wrecking Shears, Water Blaster.

Class 2. Concrete Mixers without Skips, Rock Crusher, Ditching Machine under 6', Curbing Machine, One Drum Machines without Tower or Boom, Air Tugger, Self-Propelled Concrete Saw, Machine Mounted Post Hole Digger, two to four Generators, Water Pumps or Welding Machines, within 400 feet, Air Compressor 600 cu. ft. and under, Rollers on Aggregate and Seal Coat Surfaces, Fork Lift (when used for landscaping work), Concrete and Blacktop Curb Machine, One Water Pump, Oilers, Air Valves or Steam Valves, One Welding Machine, Truck Jack, Mud Jack, Gunnite Machine, House Elevators when used for hoisting material, Engine Tenders, Fireman, Wagon Drill, Flex Plane, Conveyor, Siphons and Pulsometer, Switchman, Fireman on Paint Pots, Fireman on Asphalt Plants, Distributor Operator on Trucks, Tampers, Self-Propelled Power Broom, Striping Machine (motor driven), Form Tamper, Bulk Cement Plant, Equipment Greaser, Deck Hands, Truck Crane Oiler-Driver, Cement Blimps, Form Grader, Temporary Heat, Throttle Valve, Super Sucker (and similar type of equipment).

Other Classifications of Work:

For definitions of classifications not otherwise set out, the Department generally has on file such definitions which are available. If a task to be performed is not subject to one of the classifications of pay set out, the Department will upon being contacted state which neighboring county has such a classification and provide such rate, such rate being deemed to exist by reference in this document. If no neighboring county rate applies to the task, the Department shall undertake a special determination, such special determination being then deemed to have existed under this determination. If a project requires these, or any classification not listed, please contact IDOL at 217-782-1710 for wage rates or clarifications.

LANDSCAPING

Landscaping work falls under the existing classifications for laborer, operating engineer and truck driver. The work performed by landscape plantsman and landscape laborer is covered by the existing classification of laborer. The work performed by landscape operators (regardless of equipment used or its size) is covered by the classifications of operating engineer. The work performed by

landscape truck drivers (regardless of size of truck driven) is covered by the classifications of truck driver.

Clinton County Prevailing Wage for May 2013

(See explanation of column headings at bottom of wages)

Trade Name	RG	TYP	C	Base	FRMAN	M-F>8	OSA	OSH	H/W	Pensn	Vac	Trng
=====	==	==	=	=====	=====	=====	==	==	=====	=====	=====	=====
ASBESTOS ABT-GEN		ALL		25.700	26.200	1.5	1.5	2.0	5.750	15.00	0.000	0.800
ASBESTOS ABT-MEC		BLD		29.860	30.860	1.5	1.5	2.0	6.950	3.000	0.000	0.000
BOILERMAKER		BLD		31.500	34.000	1.5	1.5	2.0	7.070	18.73	1.000	0.350
BRICK MASON		BLD		29.280	33.160	1.5	1.5	2.0	7.750	9.430	2.000	0.400
CARPENTER		ALL		34.630	36.130	1.5	1.5	2.0	6.550	6.750	0.000	0.400
CEMENT MASON		ALL		31.000	32.000	1.5	1.5	2.0	9.250	11.75	0.000	0.200
CERAMIC TILE FNSHER		BLD		25.890	0.000	1.5	1.5	2.0	6.000	5.200	0.000	0.530
ELECTRIC PWR EQMT OP E	E	ALL	1	35.570	0.000	1.5	1.5	2.0	5.000	9.960	0.000	0.360
ELECTRIC PWR EQMT OP E	E	ALL	2	31.740	0.000	1.5	1.5	2.0	5.000	8.880	0.000	0.320
ELECTRIC PWR EQMT OP W	W	ALL		36.870	0.000	1.5	1.5	2.0	6.790	10.32	0.000	0.270
ELECTRIC PWR GRNDMAN E	E	ALL		26.100	0.000	1.5	1.5	2.0	5.000	7.310	0.000	0.260
ELECTRIC PWR GRNDMAN W	W	ALL		27.530	0.000	1.5	1.5	2.0	5.070	7.710	0.000	0.210
ELECTRIC PWR LINEMAN E	E	ALL		44.630	47.650	1.5	1.5	2.0	5.000	12.50	0.000	0.450
ELECTRIC PWR LINEMAN W	W	ALL		42.400	44.450	1.5	1.5	2.0	7.810	11.87	0.000	0.320
ELECTRIC PWR TRK DRV W	W	ALL		30.100	0.000	1.5	1.5	2.0	5.540	8.430	0.000	0.230
ELECTRICIAN	E	ALL		39.350	41.600	1.5	1.5	2.0	6.140	9.440	0.000	0.790
ELECTRICIAN	W	ALL		36.510	38.700	1.5	1.5	2.0	7.810	7.490	0.000	0.640
ELECTRONIC SYS TECH E	E	BLD		32.570	34.320	1.5	1.5	2.0	6.000	4.240	0.000	0.400
ELECTRONIC SYS TECH W	W	BLD		30.720	32.470	1.5	1.5	2.0	3.650	7.920	0.000	0.400
ELEVATOR CONSTRUCTOR		BLD		43.715	49.180	2.0	2.0	2.0	11.88	12.71	3.500	0.600
FLOOR LAYER		BLD		29.330	30.080	1.5	1.5	2.0	6.550	6.750	0.000	0.400
GLAZIER		BLD		32.780	0.000	2.0	2.0	2.0	9.020	10.80	2.630	0.310
HT/FROST INSULATOR		BLD		37.260	38.260	1.5	1.5	2.0	7.850	11.16	0.000	0.500
IRON WORKER		ALL		31.500	33.500	1.5	1.5	2.0	7.610	13.33	0.000	0.420
LABORER		ALL		25.200	25.700	1.5	1.5	2.0	5.750	15.00	0.000	0.800
MACHINIST		BLD		43.550	46.050	1.5	1.5	2.0	6.130	8.950	1.850	0.000
MARBLE FINISHERS		BLD		25.890	0.000	1.5	1.5	2.0	6.000	5.200	0.000	0.530
MILLWRIGHT		ALL		34.630	36.130	1.5	1.5	2.0	6.550	6.750	0.000	0.400
OPERATING ENGINEER		BLD	1	34.200	37.200	1.5	1.5	2.0	9.000	17.00	0.000	1.000
OPERATING ENGINEER		BLD	2	33.070	37.200	1.5	1.5	2.0	9.000	17.00	0.000	1.000
OPERATING ENGINEER		BLD	3	28.590	37.200	1.5	1.5	2.0	9.000	17.00	0.000	1.000
OPERATING ENGINEER		BLD	4	28.650	37.200	1.5	1.5	2.0	9.000	17.00	0.000	1.000
OPERATING ENGINEER		BLD	5	28.320	37.200	1.5	1.5	2.0	9.000	17.00	0.000	1.000
OPERATING ENGINEER		BLD	6	35.750	37.200	1.5	1.5	2.0	9.000	17.00	0.000	1.000
OPERATING ENGINEER		BLD	7	36.050	37.200	1.5	1.5	2.0	9.000	17.00	0.000	1.000
OPERATING ENGINEER		BLD	8	36.330	37.200	1.5	1.5	2.0	9.000	17.00	0.000	1.000
OPERATING ENGINEER		BLD	9	35.650	37.200	1.5	1.5	2.0	9.000	17.00	0.000	1.000
OPERATING ENGINEER		HWY	1	32.700	35.700	1.5	1.5	2.0	9.000	17.00	0.000	1.000
OPERATING ENGINEER		HWY	2	31.570	35.700	1.5	1.5	2.0	9.000	17.00	0.000	1.000
OPERATING ENGINEER		HWY	3	27.090	35.700	1.5	1.5	2.0	9.000	17.00	0.000	1.000
OPERATING ENGINEER		HWY	4	27.150	35.700	1.5	1.5	2.0	9.000	17.00	0.000	1.000
OPERATING ENGINEER		HWY	5	26.820	35.700	1.5	1.5	2.0	9.000	17.00	0.000	1.000
OPERATING ENGINEER		HWY	6	34.250	35.700	1.5	1.5	2.0	9.000	17.00	0.000	1.000
OPERATING ENGINEER		HWY	7	34.550	35.700	1.5	1.5	2.0	9.000	17.00	0.000	1.000
OPERATING ENGINEER		HWY	8	34.830	35.700	1.5	1.5	2.0	9.000	17.00	0.000	1.000
OPERATING ENGINEER		HWY	9	34.150	35.700	1.5	1.5	2.0	9.000	17.00	0.000	1.000
PAINTER		BLD		29.250	30.750	1.5	1.5	2.0	5.000	7.920	0.000	0.600
PAINTER		HWY		30.450	31.950	1.5	1.5	2.0	5.000	7.920	0.000	0.600
PAINTER OVER 30FT		BLD		30.250	31.750	1.5	1.5	2.0	5.000	7.920	0.000	0.600
PAINTER PWR EQMT		BLD		30.250	31.750	1.5	1.5	2.0	5.000	7.920	0.000	0.600
PAINTER PWR EQMT		HWY		31.450	32.950	1.5	1.5	2.0	5.000	7.920	0.000	0.600
PILEDRIIVER		ALL		34.630	36.130	1.5	1.5	2.0	6.550	6.750	0.000	0.400
PIPEFITTER	E	BLD		34.450	37.900	1.5	1.5	2.0	6.050	6.550	0.000	0.800
PIPEFITTER	NW	BLD		37.250	39.250	1.5	1.5	2.0	6.740	8.000	0.000	0.750
PIPEFITTER	SW	BLD		36.000	38.500	1.5	1.5	2.0	7.750	5.500	0.000	0.575

PLASTERER		BLD	30.250	31.250	1.5	1.5	2.0	9.250	8.600	0.000	0.050
PLUMBER	E	BLD	34.450	37.900	1.5	1.5	2.0	6.050	6.550	0.000	0.800
PLUMBER	NW	BLD	36.300	38.800	1.5	1.5	2.0	6.250	6.850	0.000	0.500
PLUMBER	SW	BLD	36.000	38.500	1.5	1.5	2.0	7.750	5.500	0.000	0.575
ROOFER		BLD	29.500	31.500	1.5	1.5	2.0	8.600	6.850	0.000	0.200
SHEETMETAL WORKER		ALL	31.690	33.190	1.5	1.5	2.0	7.130	6.730	1.910	0.360
SPRINKLER FITTER		BLD	38.780	41.780	2.0	2.0	2.0	8.370	11.18	0.000	1.000
TERRAZZO FINISHER		BLD	31.240	0.000	1.5	1.5	2.0	6.000	3.230	0.000	0.200
TERRAZZO MASON		BLD	32.530	32.830	1.5	1.5	2.0	6.000	5.230	0.000	0.210
TRUCK DRIVER	ALL	1	31.340	0.000	1.5	1.5	2.0	10.30	5.010	0.000	0.250
TRUCK DRIVER	ALL	2	31.780	0.000	1.5	1.5	2.0	10.30	5.010	0.000	0.250
TRUCK DRIVER	ALL	3	32.020	0.000	1.5	1.5	2.0	10.30	5.010	0.000	0.250
TRUCK DRIVER	ALL	4	32.280	0.000	1.5	1.5	2.0	10.30	5.010	0.000	0.250
TRUCK DRIVER	ALL	5	33.130	0.000	1.5	1.5	2.0	10.30	5.010	0.000	0.250
TRUCK DRIVER	O&C	1	25.070	0.000	1.5	1.5	2.0	10.30	5.010	0.000	0.250
TRUCK DRIVER	O&C	2	25.420	0.000	1.5	1.5	2.0	10.30	5.010	0.000	0.250
TRUCK DRIVER	O&C	3	25.620	0.000	1.5	1.5	2.0	10.30	5.010	0.000	0.250
TRUCK DRIVER	O&C	4	25.820	0.000	1.5	1.5	2.0	10.30	5.010	0.000	0.250
TRUCK DRIVER	O&C	5	26.500	0.000	1.5	1.5	2.0	10.30	5.010	0.000	0.250

Legend :

RG (Region)

TYP (Trade Type - All,Highway,Building,Floating,Oil & Chip,Rivers)

C (Class)

Base (Base Wage Rate)

FRMAN (Foreman Rate)

M-F>8 (OT required for any hour greater than 8 worked each day, Mon through Fri.

OSA (Overtime (OT) is required for every hour worked on Saturday)

OSH (Overtime is required for every hour worked on Sunday and Holidays)

H/W (Health & Welfare Insurance)

Pensn (Pension)

Vac (Vacation)

Trng (Training)

Explanations

CLINTON COUNTY

ELECTRICIANS & ELECTRONIC SYSTEMS TECHNICIAN (WEST) - Townships of St. Rose, Wheatfield, Sugar Creek, Breese, Wade, Carlyle, Looking Glass, and Germantown.

ELECTRICIANS & ELECTRONIC SYSTEMS TECHNICIAN (EAST) - Townships not included in WEST.

PLUMBERS & PIPEFITTERS (EAST) - That part of the county East of a North-South line 2.5 miles East of Rt. 127.

PLUMBERS & PIPEFITTERS (SOUTHWEST) - That part of the county South of

New Route 50 and West of Route 127 inclusive.

The following list is considered as those days for which holiday rates of wages for work performed apply: New Years Day, Memorial Day, Fourth of July, Labor Day, Thanksgiving Day, Christmas Day and Veterans Day in some classifications/counties. Generally, any of these holidays which fall on a Sunday is celebrated on the following Monday. This then makes work performed on that Monday payable at the appropriate overtime rate for holiday pay. Common practice in a given local may alter certain days of celebration. If in doubt, please check with IDOL.

Oil and chip resealing (O&C) means the application of road oils and liquid asphalt to coat an existing road surface, followed by application of aggregate chips or gravel to coated surface, and subsequent rolling of material to seal the surface.

EXPLANATION OF CLASSES

ASBESTOS - GENERAL - removal of asbestos material/mold and hazardous materials from any place in a building, including mechanical systems where those mechanical systems are to be removed. This includes the removal of asbestos materials/mold and hazardous materials from ductwork or pipes in a building when the building is to be demolished at the time or at some close future date.

ASBESTOS - MECHANICAL - removal of asbestos material from mechanical systems, such as pipes, ducts, and boilers, where the mechanical systems are to remain.

CERAMIC TILE FINISHER AND MARBLE FINISHER

The handling, at the building site, of all sand, cement, tile, marble or stone and all other materials that may be used and installed by [a] tile layer or marble mason. In addition, the grouting, cleaning, sealing, and mixing on the job site, and all other work as required in assisting the setter. The term "Ceramic" is used for naming the classification only and is in no way a limitation of the product handled. Ceramic takes into consideration most hard tiles.

ELECTRONIC SYSTEMS TECHNICIAN

Installation, service and maintenance of low-voltage systems which utilizes the transmission and/or transference of voice, sound, vision, or digital for commercial, education, security and entertainment purposes for the following: TV monitoring and surveillance, background/foreground music, intercom and telephone interconnect, field programming, inventory control systems, microwave transmission, multi-media, multiplex, radio page, school, intercom and sound burglar alarms and low voltage master clock systems.

Excluded from this classification are energy management systems, life safety systems, supervisory controls and data acquisition systems not intrinsic with the above listed systems, fire alarm systems, nurse call systems and raceways exceeding fifteen feet in length.

OPERATING ENGINEER - BUILDING

GROUP I. Cranes, Dragline, Shovels, Skimmer Scoops, Clamshells or Derrick Boats, Pile Drivers, Crane-Type Backhoes, Asphalt Plant Operators, Concrete Plant Operators, Dredges, Asphalt Spreading Machines, All Locomotives, Cable Ways or Tower Machines, Hoists, Hydraulic Backhoes, Ditching Machines or Backfiller, Cherrypickers, Overhead Cranes, Roller - Steam or Gas, Concrete Pavers, Excavators, Concrete Breakers, Concrete Pumps, Bulk Cement Plants, Cement Pumps, Derrick-Type Drills, Boat Operators, Motor Graders or Pushcats, Scoops

or Tournapulls, Bulldozers, Endloaders or Fork Lifts, Power Blade or Elevating Graders, Winch Cats, Boom or Winch Trucks or Boom Tractors, Pipe Wrapping or Painting Machines, Asphalt Plant Engineer, Journeyman Lubricating Engineer, Drills (other than Derrick Type), Mud Jacks, or Well Drilling Machines, Boring Machines or Track Jacks, Mixers, Conveyors (Two), Air Compressors (Two), Water Pumps regardless of size (Two), Welding Machines (Two), Siphons or Jets (Two), Winch Heads or Apparatuses (Two), Light Plants (Two), All Tractors regardless of size (straight tractor only), Fireman on Stationary Boilers, Automatic Elevators, Form Grading Machines, Finishing Machines, Power Sub-Grader or Ribbon Machines, Longitudinal Floats, Distributor Operators on Trucks, Winch Heads or Apparatuses (One), Mobil Track air and heaters (two to five), Heavy Equipment Greaser, Relief Operator, Assistant Master Mechanic and Heavy Duty Mechanic, self-propelled concrete saws of all types and sizes with their attachments, gob-hoppers, excavators all sizes, the repair and greasing of all diesel hammers, the operation and set-up of bidwells, water blasters of all sizes and their clutches, hydraulic jacks where used for hoisting, operation of log skidders, iceolators used on and off of pipeline, condor cranes, bow boats, survey boats, bobcats and all their attachments, skid steer loaders and all their attachments, creter cranes, batch plants, operator (all sizes), self propelled roto mills, operation of conveyor systems of any size and any configuration, operation, repair and service of all vibratory hammers, all power pacs and their controls regardless of location, curtains or brush burning machines, stump cutter machines, Nail launchers when mounted on a machine or self-propelled, operation of con-cover machines, and all Operators except those listed below).

GROUP II. Assistant Operators.

GROUP III. Air Compressors (One), Water Pumps, regardless of Size (One), Waterblasters (one), Welding Machine (One), Mixers (One Bag), Conveyor (One), Siphon or Jet (One), Light Plant (One), Heater (One), Immobile Track Air (One), and Self Propelled Walk-Behind Rollers.

GROUP IV. Asphalt Spreader Oilers, Fireman on Whirlies and Heavy Equipment Oilers, Truck Cranes, Dredges, Monigans, Large Cranes - (Over 65-ton rated capacity) Concrete Plant Oiler, Blacktop Plant Oiler, and Creter Crane Oiler (when required).

GROUP V. Oiler.

GROUP VI. Operators on equipment with Booms, including jibs, 100 feet and over, and less than 150 feet long.

GROUP VII. Operators on equipment with Booms, including jibs, 150 feet and over, and less than 200 feet long.

GROUP VIII. Operators on Equipment with Booms, including jibs, 200 feet and over; Tower Cranes; and Whirlie Cranes.

GROUP IX. Master Mechanic

OPERATING ENGINEERS - Highway

GROUP I. Cranes, Dragline, Shovels, Skimmer Scoops, Clamshells or Derrick Boats, Pile Drivers, Crane-Type Backhoes, Asphalt Plant Operators, Concrete Plant Operators, Dredges, Asphalt Spreading Machines, All Locomotives, Cable Ways or Tower Machines, Hoists, Hydraulic Backhoes, Ditching Machines or Backfiller, Cherrypickers, Overhead Cranes, Roller - Steam or Gas, Concrete Pavers, Excavators, Concrete Breakers, Concrete Pumps, Bulk Cement Plants, Cement Pumps, Derrick-Type Drills, Boat Operators, Motor Graders or Pushcats, Scoops or Tournapulls, Bulldozers, Endloaders or Fork Lifts, Power Blade or

Elevating Graders, Winch Cats, Boom or Winch Trucks or Boom Tractors, Pipe Wrapping or Painting Machines, Asphalt Plant Engineer, Journeyman Lubricating Engineer, Drills (other than Derrick Type), Mud Jacks, Well Drilling Machines, Boring Machines, Track Jacks, Mixers, Conveyors (Two), Air Compressors (Two), Water Pumps regardless of size (Two), Welding Machines (Two), Siphons or Jets (Two), Winch Heads or Apparatuses (Two), Light Plants (Two), All Tractors regardless of size (straight tractor only), Fireman on Stationary Boilers, Automatic Elevators, Form Grading Machines, Finishing Machines, Power Sub-Grader or Ribbon Machines, Longitudinal Floats, Distributor Operators on Trucks, Winch Heads or Apparatuses (One), Mobil Track air and heaters (two to five), Heavy Equipment Greaser, Relief Operator, Assistant Master Mechanic and Heavy Duty Mechanic, self-propelled concrete saws of all types and sizes with their attachments, gob-hoppers, excavators all sizes, the repair and greasing of all diesel hammers, the operation and set-up of bidwells, water blasters of all sizes and their clutches, hydraulic jacks where used for hoisting, operation of log skidders, iceolators used on and off of pipeline, condor cranes, bow boats, survey boats, bobcats and all their attachments, skid steer loaders and all their attachments, creter cranes, batch plants, operator (all sizes), self propelled roto mills, operation of conveyor systems of any size and any configuration, operation, repair and service of all vibratory hammers, all power pacs and their controls regardless of location, curtains or brush burning machines, stump cutter machines, Nail launchers when mounted on a machine or self-propelled, operation of con-cover machines, and all Operators (except those listed below).

GROUP II. Assistant Operators.

GROUP III. Air Compressors (One), Water Pumps, regardless of Size (One), Waterblasters (one), Welding Machine (One), Mixers (One Bag), Conveyor (One), Siphon or Jet (One), Light Plant (One), Heater (One), Immobile Track Air (One), and Self Propelled Walk-Behind Rollers.

GROUP IV. Asphalt Spreader Oilers, Fireman on Whirlies and Heavy Equipment Oilers, Truck Cranes, Dredges, Monigans, Large Cranes - (Over 65-ton rated capacity) Concrete Plant Oiler, Blacktop Plant Oiler, and Creter Crane Oiler (when required).

GROUP V. Oiler.

GROUP VI. Operators on equipment with Booms, including jibs, 100 feet and over, and less than 150 feet long.

GROUP VII. Operators on equipment with Booms, including jibs, 150 feet and over, and less than 200 feet long.

GROUP VIII. Operators on Equipment with Booms, including jibs, 200 feet and over; Tower Cranes; and Whirlie Cranes.

GROUP IX. Mechanic

TRUCK DRIVER - BUILDING, HEAVY AND HIGHWAY CONSTRUCTION

Class 1. Drivers on 2 axle trucks hauling less than 9 ton. Air compressor and welding machines and brooms, including those pulled by separate units, truck driver helpers, warehouse employees, mechanic helpers, greasers and tiremen, pickup trucks when hauling materials, tools, or workers to and from and on-the-job site, and fork lifts up to 6,000 lb. capacity.

Class 2. Two or three axle trucks hauling more than 9 ton but hauling less than 16 ton. A-frame winch trucks, hydrolift trucks, vactor

trucks or similar equipment when used for transportation purposes. Fork lifts over 6,000 lb. capacity, winch trucks, four axle combination units, and ticket writers.

Class 3. Two, three or four axle trucks hauling 16 ton or more. Drivers on water pulls, articulated dump trucks, mechanics and working forepersons, and dispatchers. Five axle or more combination units.

Class 4. Low Boy and Oil Distributors.

Class 5. Drivers who require special protective clothing while employed on hazardous waste work.

TRUCK DRIVER - OIL AND CHIP RESEALING ONLY.

This shall encompass laborers, workers and mechanics who drive contractor or subcontractor owned, leased, or hired pickup, dump, service, or oil distributor trucks. The work includes transporting materials and equipment (including but not limited to, oils, aggregate supplies, parts, machinery and tools) to or from the job site; distributing oil or liquid asphalt and aggregate; stock piling material when in connection with the actual oil and chip contract. The Truck Driver (Oil & Chip Resealing) wage classification does not include supplier delivered materials.

TERRAZZO FINISHER

The handling of all materials used for Mosaic and Terrazzo work including preparing, mixing by hand, by mixing machine or transporting of pre-mixed materials and distributing with shovel, rake, hoe, or pail, all kinds of concrete foundations necessary for Mosaic and Terrazzo work, all cement terrazzo, magnesite terrazzo, Do-O-Tex terrazzo, epoxy matrix ter-razzo, exposed aggregate, rustic or rough washed for exterior or interior of buildings placed either by machine or by hand, and any other kind of mixture of plastics composed of chips or granules when mixed with cement, rubber, neoprene, vinyl, magnesium chloride or any other resinous or chemical substances used for seamless flooring systems, and all other building materials, all similar materials and all precast terrazzo work on jobs, all scratch coat used for Mosaic and Terrazzo work and sub-bed, tar paper and wire mesh (2x2 etc.) or lath. The rubbing, grinding, cleaning and finishing of same either by hand or by machine or by terrazzo resurfacing equipment on new or existing floors. When necessary finishers shall be allowed to assist the mechanics to spread sand bed, lay tarpaper and wire mesh (2x2 etc.) or lath. The finishing of cement floors where additional aggregate of stone is added by spreading or sprinkling on top of the finished base, and troweled or rolled into the finish and then the surface is ground by grinding machines.

Other Classifications of Work:

For definitions of classifications not otherwise set out, the Department generally has on file such definitions which are available. If a task to be performed is not subject to one of the classifications of pay set out, the Department will upon being contacted state which neighboring county has such a classification and provide such rate, such rate being deemed to exist by reference in this document. If no neighboring county rate applies to the task, the Department shall undertake a special determination, such special determination being then deemed to have existed under this determination. If a project requires these, or any classification not listed, please contact IDOL at 217-782-1710 for wage rates or clarifications.

LANDSCAPING

Landscaping work falls under the existing classifications for laborer, operating engineer and truck driver. The work performed by landscape plantsman and landscape laborer is covered by the existing classification of laborer. The work performed by landscape operators (regardless of equipment used or its size) is covered by the classifications of operating engineer. The work performed by landscape truck drivers (regardless of size of truck driven) is covered by the classifications of truck driver.

Coles County Prevailing Wage for May 2013

(See explanation of column headings at bottom of wages)

Trade Name	RG	TYP	C	Base	FRMAN	M-F>8	OSA	OSH	H/W	Pensn	Vac	Trng
=====	==	===	=	=====	=====	=====	===	===	=====	=====	=====	=====
ASBESTOS ABT-GEN		BLD		29.710	30.960	1.5	1.5	2.0	5.750	9.920	0.000	0.900
ASBESTOS ABT-MEC		BLD		21.150	22.150	1.5	1.5	2.0	6.400	5.150	0.000	0.650
BOILERMAKER		BLD		31.500	34.000	1.5	1.5	2.0	7.070	18.73	1.000	0.350
BRICK MASON		BLD		30.670	32.170	1.5	1.5	2.0	6.600	10.03	0.000	0.630
CARPENTER		BLD		29.600	31.850	1.5	1.5	2.0	7.450	12.65	0.000	0.520
CARPENTER		HWY		29.950	31.700	1.5	1.5	2.0	7.450	12.65	0.000	0.520
CEMENT MASON		BLD		29.800	31.300	1.5	1.5	2.0	6.600	8.360	0.000	0.500
CEMENT MASON		HWY		30.390	31.890	1.5	1.5	2.0	6.600	8.560	0.000	0.500
CERAMIC TILE FNSHER		BLD		28.400	0.000	1.5	1.5	2.0	6.600	7.930	0.000	0.000
ELECTRIC PWR EQMT OP		ALL	1	35.570	0.000	1.5	1.5	2.0	5.000	9.996	0.000	0.360
ELECTRIC PWR EQMT OP		ALL	2	31.740	0.000	1.5	1.5	2.0	5.000	8.880	0.000	0.320
ELECTRIC PWR GRNDMAN		ALL		26.100	0.000	1.5	1.5	2.0	5.000	7.310	0.000	0.260
ELECTRIC PWR LINEMAN		ALL		44.630	47.650	1.5	1.5	2.0	5.000	12.50	0.000	0.450
ELECTRICIAN		BLD		34.200	37.620	1.5	1.5	2.0	5.350	7.610	0.000	0.510
ELECTRONIC SYS TECH		BLD		31.130	32.880	1.5	1.5	2.0	5.350	6.110	0.000	0.400
ELEVATOR CONSTRUCTOR		BLD		40.520	45.585	2.0	2.0	2.0	11.88	12.71	3.240	0.600
FENCE ERECTOR		ALL		28.600	31.460	1.5	1.5	2.0	6.450	11.30	0.000	0.300
GLAZIER		BLD		30.780	32.780	1.5	2.0	2.0	6.630	8.150	0.000	0.380
HT/FROST INSULATOR		BLD		29.450	30.450	1.5	1.5	2.0	5.050	9.730	0.000	0.280
IRON WORKER		ALL		28.600	31.460	1.5	1.5	2.0	6.450	11.30	0.000	0.300
LABORER		BLD		27.710	28.960	1.5	1.5	2.0	5.750	9.920	0.000	0.800
LABORER		HWY		29.120	30.120	1.5	1.5	2.0	5.750	9.920	0.000	0.800
LATHER		BLD		29.600	31.850	1.5	1.5	2.0	7.450	12.65	0.000	0.520
MACHINIST		BLD		43.550	46.050	1.5	1.5	2.0	6.130	8.950	1.850	0.000
MARBLE FINISHERS		BLD		28.400	0.000	1.5	1.5	2.0	6.600	7.930	0.000	0.000
MARBLE MASON		BLD		29.900	0.000	1.5	1.5	2.0	6.600	7.930	0.000	0.000
MILLWRIGHT		BLD		29.620	31.870	1.5	1.5	2.0	7.450	13.09	0.000	0.520
MILLWRIGHT		HWY		31.400	33.150	1.5	1.5	2.0	7.450	13.54	0.000	0.520
OPERATING ENGINEER		ALL	1	36.950	0.000	1.5	1.5	2.0	7.250	8.700	0.000	0.800
OPERATING ENGINEER		ALL	2	23.900	0.000	1.5	1.5	2.0	7.250	8.700	0.000	0.800
PAINTER		ALL		33.560	35.060	1.5	1.5	2.0	6.600	4.420	0.000	0.570
PAINTER SIGNS		ALL		33.560	35.060	1.5	1.5	2.0	6.600	4.420	0.000	0.570
PILEDRIVER		BLD		30.100	32.350	1.5	1.5	2.0	7.450	12.65	0.000	0.520
PILEDRIVER		HWY		30.950	32.700	1.5	1.5	2.0	7.450	12.65	0.000	0.520
PIPEFITTER		BLD		37.680	40.180	1.5	1.5	2.0	7.000	10.61	0.000	0.980
PLASTERER		BLD		30.000	32.000	1.5	1.5	2.0	6.600	10.17	0.000	0.500
PLUMBER		BLD		37.680	40.180	1.5	1.5	2.0	7.000	10.61	0.000	0.980
ROOFER		BLD		28.750	30.250	1.5	1.5	2.0	9.150	8.400	0.000	0.200
SHEETMETAL WORKER		BLD		33.640	35.640	1.5	1.5	2.0	8.300	12.00	0.000	0.520
SPRINKLER FITTER		BLD		36.390	39.140	1.5	1.5	2.0	8.420	8.500	0.000	0.450
STONE MASON		BLD		30.670	32.170	1.5	1.5	2.0	6.600	10.03	0.000	0.630
TERRAZZO FINISHER		BLD		28.400	0.000	1.5	1.5	2.0	6.600	7.930	0.000	0.000
TERRAZZO MASON		BLD		29.900	0.000	1.5	1.5	2.0	6.600	7.930	0.000	0.000
TILE LAYER		BLD		29.600	31.850	1.5	1.5	2.0	7.450	12.65	0.000	0.520
TILE MASON		BLD		29.900	0.000	1.5	1.5	2.0	6.600	7.930	0.000	0.000
TRUCK DRIVER		ALL	1	31.230	0.000	1.5	1.5	2.0	10.30	4.840	0.000	0.250

TRUCK DRIVER	ALL	2	31.680	0.000	1.5	1.5	2.0	10.30	4.840	0.000	0.250
TRUCK DRIVER	ALL	3	31.890	0.000	1.5	1.5	2.0	10.30	4.840	0.000	0.250
TRUCK DRIVER	ALL	4	32.180	0.000	1.5	1.5	2.0	10.30	4.840	0.000	0.250
TRUCK DRIVER	ALL	5	33.020	0.000	1.5	1.5	2.0	10.30	4.840	0.000	0.250
TRUCK DRIVER	O&C	1	24.980	0.000	1.5	1.5	2.0	10.30	4.840	0.000	0.250
TRUCK DRIVER	O&C	2	25.340	0.000	1.5	1.5	2.0	10.30	4.840	0.000	0.250
TRUCK DRIVER	O&C	3	25.510	0.000	1.5	1.5	2.0	10.30	4.840	0.000	0.250
TRUCK DRIVER	O&C	4	25.740	0.000	1.5	1.5	2.0	10.30	4.840	0.000	0.250
TRUCK DRIVER	O&C	5	26.420	0.000	1.5	1.5	2.0	10.30	4.840	0.000	0.250
TUCKPOINTER	BLD		30.670	32.170	1.5	1.5	2.0	6.600	10.03	0.000	0.630

Legend:

RG (Region)

TYP (Trade Type - All,Highway,Building,Floating,Oil & Chip,Rivers)

C (Class)

Base (Base Wage Rate)

FRMAN (Foreman Rate)

M-F>8 (OT required for any hour greater than 8 worked each day, Mon through Fri.)

OSA (Overtime (OT) is required for every hour worked on Saturday)

OSH (Overtime is required for every hour worked on Sunday and Holidays)

H/W (Health & Welfare Insurance)

Pensn (Pension)

Vac (Vacation)

Trng (Training)

Explanations

COLES COUNTY

The following list is considered as those days for which holiday rates of wages for work performed apply: New Years Day, Memorial Day, Fourth of July, Labor Day, Thanksgiving Day, Christmas Day and Veterans Day in some classifications/counties. Generally, any of these holidays which fall on a Sunday is celebrated on the following Monday. This then makes work performed on that Monday payable at the appropriate overtime rate for holiday pay. Common practice in a given local may alter certain days of celebration. If in doubt, please check with IDOL.

Oil and chip resealing (O&C) means the application of road oils and liquid asphalt to coat an existing road surface, followed by application of aggregate chips or gravel to coated surface, and subsequent rolling of material to seal the surface.

EXPLANATION OF CLASSES

ASBESTOS - GENERAL - removal of asbestos material/mold and hazardous materials from any place in a building, including mechanical systems where those mechanical systems are to be removed. This includes the

removal of asbestos materials/mold and hazardous materials from ductwork or pipes in a building when the building is to be demolished at the time or at some close future date.

ASBESTOS - MECHANICAL - removal of asbestos material from mechanical systems, such as pipes, ducts, and boilers, where the mechanical systems are to remain.

CERAMIC TILE FINISHER, MARBLE FINISHER, TERRAZZO FINISHER

Assisting, helping or supporting the tile, marble and terrazzo mechanic by performing their historic and traditional work assignments required to complete the proper installation of the work covered by said crafts. The term "Ceramic" is used for naming the classification only and is in no way a limitation of the product handled. Ceramic takes into consideration most hard tiles.

ELECTRONIC SYSTEMS TECHNICIAN

Installation, service and maintenance of low-voltage systems which utilizes the transmission and/or transference of voice, sound, vision, or digital for commercial, education, security and entertainment purposes for the following: TV monitoring and surveillance, background/foreground music, intercom and telephone interconnect, field programming, inventory control systems, microwave transmission, multi-media, multiplex, radio page, school, intercom and sound burglar alarms and low voltage master clock systems.

Excluded from this classification are energy management systems, life safety systems, supervisory controls and data acquisition systems not intrinsic with the above listed systems, fire alarm systems, nurse call systems and raceways exceeding fifteen feet in length.

TRUCK DRIVER - BUILDING, HEAVY AND HIGHWAY CONSTRUCTION

Class 1. Drivers on 2 axle trucks hauling less than 9 ton. Air compressor and welding machines and brooms, including those pulled by separate units, truck driver helpers, warehouse employees, mechanic helpers, greasers and tiremen, pickup trucks when hauling materials, tools, or workers to and from and on-the-job site, and fork lifts up to 6,000 lb. capacity.

Class 2. Two or three axle trucks hauling more than 9 ton but hauling less than 16 ton. A-frame winch trucks, hydrolift trucks, vactor trucks or similar equipment when used for transportation purposes. Fork lifts over 6,000 lb. capacity, winch trucks, four axle combination units, and ticket writers.

Class 3. Two, three or four axle trucks hauling 16 ton or more. Drivers on water pulls, articulated dump trucks, mechanics and working forepersons, and dispatchers. Five axle or more combination units.

Class 4. Low Boy and Oil Distributors.

Class 5. Drivers who require special protective clothing while employed on hazardous waste work.

TRUCK DRIVER - OIL AND CHIP RESEALING ONLY.

This shall encompass laborers, workers and mechanics who drive contractor or subcontractor owned, leased, or hired pickup, dump, service, or oil distributor trucks. The work includes transporting materials and equipment (including but not limited to, oils, aggregate supplies, parts, machinery and tools) to or from the job site; distributing oil or liquid asphalt and aggregate; stock piling

material when in connection with the actual oil and chip contract. The Truck Driver (Oil & Chip Resealing) wage classification does not include supplier delivered materials.

OPERATING ENGINEERS - BUILDING, HEAVY AND HIGHWAY CONSTRUCTION

Class 1. Power Cranes, Draglines, Derricks, Shovels, Gradalls, Mechanics, Tractor Highlift, Tournadozer, Concrete Mixers with Skip, Tournamixer, Two Drum Machine, One Drum Hoist with Tower or Boom, Cableways, Tower Machines, Motor Patrol, Boom Tractor, Boom or Winch Truck, Winch or Hydraulic Boom Truck, Truck Crane, Tournapull, Tractor Operating Scoops, Bulldozer, Push Tractor, Asphalt Planer, Finishing Machine on Asphalt, Large Rollers on Earth, Rollers on Asphalt Mix, Ross Carrier or similar Machine, Gravel Processing Machine, Asphalt Plant Engineer, Paver Operator, Dredging Equipment, or Dredge Engineer, or Dredge Operator, Central Mix Plant Engineer, CMI or similar type machine, Concrete Pump, Truck or Skid Mounted, Tower Crane, Engineer or Rock Crusher Plant, Concrete Plant Engineer, Ditching Machine with dual attachment, Tractor Mounted Loaders, Cherry Picker, Hydro Crane, Standard or Dinkey Locomotives, Scoopmobiles, Euclid Loader, Soil Cement Machine, Back Filler, Elevating Machine, Power Blade, Drilling Machine, including Well Testing, Caissons, Shaft or any similar type drilling machines, Motor Driven Paint Machine, Pipe Cleaning Machine, Pipe Wrapping Machine, Pipe Bending Machine, Apsco Paver, Boring Machine, (Head Equipment Greaser), Barber-Greene Loaders, Formless Paver, (Well Point System), Concrete Spreader, Hydra Ax, Span Saw, Marine Scoops, Brush Mulcher, Brush Burner, Mesh Placer, Tree Mover, Helicopter Crew (3), Piledriver-Skid or Crawler, Stump Remover, Root Rake, Tug Boat Operator, Refrigerating Machine, Freezing Operator, Chair Cart-Self-Propelled, Hydra Seeder, Straw Blower, Power Sub Grader, Bull Float, Finishing Machine, Self-Propelled Pavement Breaker, Lull (or similar type Machine), Two Air Compressors, Compressors hooked in Manifold, Overhead Crane, Chip Spreader, Mud Cat, Sull-Air, Fork Lifts (except when used for landscaping work), Soil Stabilizer (Seaman Tiller, Bo Mag, Rago Gator, and similar types of equipment), Tube Float, Spray Machine, Curing Machine, Concrete or Asphalt Milling Machine, Snooper Truck-Operator, Backhoe, Farm Tractors (with attachments), 4 Point Lift System (Power Lift or similar type), Skid-Steer (Bob Cat or similar type), Wrecking Shears, Water Blaster.

Class 2. Concrete Mixers without Skips, Rock Crusher, Ditching Machine under 6', Curbing Machine, One Drum Machines without Tower or Boom, Air Tugger, Self-Propelled Concrete Saw, Machine Mounted Post Hole Digger, two to four Generators, Water Pumps or Welding Machines, within 400 feet, Air Compressor 600 cu. ft. and under, Rollers on Aggregate and Seal Coat Surfaces, Fork Lift (when used for landscaping work), Concrete and Blacktop Curb Machine, One Water Pump, Oilers, Air Valves or Steam Valves, One Welding Machine, Truck Jack, Mud Jack, Gunnite Machine, House Elevators when used for hoisting material, Engine Tenders, Fireman, Wagon Drill, Flex Plane, Conveyor, Siphons and Pulsometer, Switchman, Fireman on Paint Pots, Fireman on Asphalt Plants, Distributor Operator on Trucks, Tampers, Self-Propelled Power Broom, Striping Machine (motor driven), Form Tamper, Bulk Cement Plant, Equipment Greaser, Deck Hands, Truck Crane Oiler-Driver, Cement Blimps, Form Grader, Temporary Heat, Throttle Valve, Super Sucker (and similar type of equipment).

Other Classifications of Work:

For definitions of classifications not otherwise set out, the Department generally has on file such definitions which are available. If a task to be performed is not subject to one of the classifications of pay set out, the Department will upon being contacted state which neighboring county has such a classification and

provide such rate, such rate being deemed to exist by reference in this document. If no neighboring county rate applies to the task, the Department shall undertake a special determination, such special determination being then deemed to have existed under this determination. If a project requires these, or any classification not listed, please contact IDOL at 217-782-1710 for wage rates or clarifications.

LANDSCAPING

Landscaping work falls under the existing classifications for laborer, operating engineer and truck driver. The work performed by landscape plantsman and landscape laborer is covered by the existing classification of laborer. The work performed by landscape operators (regardless of equipment used or its size) is covered by the classifications of operating engineer. The work performed by landscape truck drivers (regardless of size of truck driven) is covered by the classifications of truck driver.

Cook County Prevailing Wage for May 2013

(See explanation of column headings at bottom of wages)

Trade Name	RG	TYP	C	Base	FRMAN	M-F>8	OSA	OSH	H/W	Pensn	Vac	Trng
=====	==	===	=	=====	=====	=====	===	===	=====	=====	=====	=====
ASBESTOS ABT-GEN		ALL		36.200	36.700	1.5	1.5	2.0	12.78	9.020	0.000	0.500
ASBESTOS ABT-MEC		BLD		34.160	36.660	1.5	1.5	2.0	10.82	10.66	0.000	0.720
BOILERMAKER		BLD		43.450	47.360	2.0	2.0	2.0	6.970	14.66	0.000	0.350
BRICK MASON		BLD		40.680	44.750	1.5	1.5	2.0	9.550	12.00	0.000	0.970
CARPENTER		ALL		41.520	43.520	1.5	1.5	2.0	13.19	11.75	0.000	0.530
CEMENT MASON		ALL		42.350	44.350	2.0	1.5	2.0	11.21	11.40	0.000	0.320
CERAMIC TILE FNSHER		BLD		34.440	0.000	2.0	1.5	2.0	9.700	6.930	0.000	0.610
COMM. ELECT.		BLD		37.500	40.150	1.5	1.5	2.0	8.420	9.980	1.100	0.700
ELECTRIC PWR EQMT OP		ALL		43.350	48.350	1.5	1.5	2.0	10.38	13.50	0.000	0.430
ELECTRIC PWR GRNDMAN		ALL		33.810	48.350	1.5	1.5	2.0	8.090	10.53	0.000	0.330
ELECTRIC PWR LINEMAN		ALL		43.350	48.350	1.5	1.5	2.0	10.38	13.50	0.000	0.430
ELECTRICIAN		ALL		42.000	44.800	1.5	1.5	2.0	12.83	13.07	0.000	0.750
ELEVATOR CONSTRUCTOR		BLD		49.080	55.215	2.0	2.0	2.0	11.88	12.71	3.930	0.600
FENCE ERECTOR		ALL		33.740	35.740	1.5	1.5	2.0	12.61	10.18	0.000	0.250
GLAZIER		BLD		39.500	41.000	1.5	2.0	2.0	11.99	14.30	0.000	0.840
HT/FROST INSULATOR		BLD		45.550	48.050	1.5	1.5	2.0	10.82	11.86	0.000	0.720
IRON WORKER		ALL		40.750	42.750	2.0	2.0	2.0	13.20	19.09	0.000	0.350
LABORER		ALL		36.200	36.950	1.5	1.5	2.0	12.78	9.020	0.000	0.500
LATHER		ALL		41.520	43.520	1.5	1.5	2.0	13.19	11.75	0.000	0.530
MACHINIST		BLD		43.550	46.050	1.5	1.5	2.0	6.130	8.950	1.850	0.000
MARBLE FINISHERS		ALL		29.700	0.000	1.5	1.5	2.0	9.550	11.75	0.000	0.620
MARBLE MASON		BLD		39.880	43.870	1.5	1.5	2.0	9.550	11.75	0.000	0.730
MATERIAL TESTER I		ALL		26.200	0.000	1.5	1.5	2.0	12.78	9.020	0.000	0.500
MATERIALS TESTER II		ALL		31.200	0.000	1.5	1.5	2.0	12.78	9.020	0.000	0.500
MILLWRIGHT		ALL		41.520	43.520	1.5	1.5	2.0	13.19	11.75	0.000	0.530
OPERATING ENGINEER		BLD 1		45.100	49.100	2.0	2.0	2.0	15.70	10.55	1.900	1.250
OPERATING ENGINEER		BLD 2		43.800	49.100	2.0	2.0	2.0	15.70	10.55	1.900	1.250
OPERATING ENGINEER		BLD 3		41.250	49.100	2.0	2.0	2.0	15.70	10.55	1.900	1.250
OPERATING ENGINEER		BLD 4		39.500	49.100	2.0	2.0	2.0	15.70	10.55	1.900	1.250
OPERATING ENGINEER		BLD 5		48.850	49.100	2.0	2.0	2.0	15.70	10.55	1.900	1.250
OPERATING ENGINEER		BLD 6		46.100	49.100	2.0	2.0	2.0	15.70	10.55	1.900	1.250
OPERATING ENGINEER		BLD 7		48.100	49.100	2.0	2.0	2.0	15.70	10.55	1.900	1.250
OPERATING ENGINEER		FLT 1		51.300	51.300	1.5	1.5	2.0	14.40	9.550	1.900	1.250
OPERATING ENGINEER		FLT 2		49.800	51.300	1.5	1.5	2.0	14.40	9.550	1.900	1.250
OPERATING ENGINEER		FLT 3		44.350	51.300	1.5	1.5	2.0	14.40	9.550	1.900	1.250
OPERATING ENGINEER		FLT 4		36.850	51.300	1.5	1.5	2.0	14.40	9.550	1.900	1.250
OPERATING ENGINEER		FLT 5		52.800	51.300	1.5	1.5	2.0	14.40	9.550	1.900	1.250
OPERATING ENGINEER		HWY 1		43.300	47.300	1.5	1.5	2.0	15.70	10.55	1.900	1.250
OPERATING ENGINEER		HWY 2		42.750	47.300	1.5	1.5	2.0	15.70	10.55	1.900	1.250

OPERATING ENGINEER	HWY	3	40.700	47.300	1.5	1.5	2.0	15.70	10.55	1.900	1.250
OPERATING ENGINEER	HWY	4	39.300	47.300	1.5	1.5	2.0	15.70	10.55	1.900	1.250
OPERATING ENGINEER	HWY	5	38.100	47.300	1.5	1.5	2.0	15.70	10.55	1.900	1.250
OPERATING ENGINEER	HWY	6	46.300	47.300	1.5	1.5	2.0	15.70	10.55	1.900	1.250
OPERATING ENGINEER	HWY	7	44.300	47.300	1.5	1.5	2.0	15.70	10.55	1.900	1.250
ORNAMNTL IRON WORKER	ALL		41.800	44.300	2.0	2.0	2.0	12.86	15.81	0.000	0.550
PAINTER	ALL		40.000	44.750	1.5	1.5	1.5	9.750	11.10	0.000	0.770
PAINTER SIGNS	BLD		33.920	38.090	1.5	1.5	1.5	2.600	2.710	0.000	0.000
PILEDRIIVER	ALL		41.520	43.520	1.5	1.5	2.0	13.19	11.75	0.000	0.530
PIPEFITTER	BLD		45.050	48.050	1.5	1.5	2.0	8.460	14.85	0.000	1.780
PLASTERER	BLD		40.250	42.670	1.5	1.5	2.0	10.85	10.94	0.000	0.550
PLUMBER	BLD		45.000	47.000	1.5	1.5	2.0	12.53	10.06	0.000	0.880
ROOFER	BLD		38.350	41.350	1.5	1.5	2.0	8.280	8.770	0.000	0.430
SHEETMETAL WORKER	BLD		40.810	44.070	1.5	1.5	2.0	10.13	17.79	0.000	0.630
SIGN HANGER	BLD		30.210	30.710	1.5	1.5	2.0	4.850	3.030	0.000	0.000
SPRINKLER FITTER	BLD		49.200	51.200	1.5	1.5	2.0	10.25	8.350	0.000	0.450
STEEL ERECTOR	ALL		40.750	42.750	2.0	2.0	2.0	13.20	19.09	0.000	0.350
STONE MASON	BLD		40.680	44.750	1.5	1.5	2.0	9.550	12.00	0.000	0.970
TERRAZZO FINISHER	BLD		35.510	0.000	1.5	1.5	2.0	9.700	9.320	0.000	0.400
TERRAZZO MASON	BLD		39.370	42.370	1.5	1.5	2.0	9.700	10.66	0.000	0.550
TILE MASON	BLD		41.430	45.430	2.0	1.5	2.0	9.700	8.640	0.000	0.710
TRAFFIC SAFETY WRKR	HWY		28.250	29.850	1.5	1.5	2.0	4.896	4.175	0.000	0.000
TRUCK DRIVER	E ALL	1	33.850	34.500	1.5	1.5	2.0	8.150	8.500	0.000	0.150
TRUCK DRIVER	E ALL	2	34.100	34.500	1.5	1.5	2.0	8.150	8.500	0.000	0.150
TRUCK DRIVER	E ALL	3	34.300	34.500	1.5	1.5	2.0	8.150	8.500	0.000	0.150
TRUCK DRIVER	E ALL	4	34.500	34.500	1.5	1.5	2.0	8.150	8.500	0.000	0.150
TRUCK DRIVER	W ALL	1	32.550	33.100	1.5	1.5	2.0	6.500	4.350	0.000	0.000
TRUCK DRIVER	W ALL	2	32.700	33.100	1.5	1.5	2.0	6.500	4.350	0.000	0.000
TRUCK DRIVER	W ALL	3	32.900	33.100	1.5	1.5	2.0	6.500	4.350	0.000	0.000
TRUCK DRIVER	W ALL	4	33.100	33.100	1.5	1.5	2.0	6.500	4.350	0.000	0.000
TUCKPOINTER	BLD		40.950	41.950	1.5	1.5	2.0	8.180	10.82	0.000	0.940

Legend :

RG (Region)

TYP (Trade Type - All,Highway,Building,Floating,Oil & Chip,Rivers)

C (Class)

Base (Base Wage Rate)

FRMAN (Foreman Rate)

M-F>8 (OT required for any hour greater than 8 worked each day, Mon through Fri.

OSA (Overtime (OT) is required for every hour worked on Saturday)

OSH (Overtime is required for every hour worked on Sunday and Holidays)

H/W (Health & Welfare Insurance)

Pensn (Pension)

Vac (Vacation)

Trng (Training)

Explanations

The following list is considered as those days for which holiday rates of wages for work performed apply: New Years Day, Memorial Day, Fourth of July, Labor Day, Thanksgiving Day, Christmas Day and Veterans Day in some classifications/counties. Generally, any of these holidays which fall on a Sunday is celebrated on the following Monday. This then makes work performed on that Monday payable at the appropriate overtime rate for holiday pay. Common practice in a given local may alter certain days of celebration. If in doubt, please check with IDOL.

TRUCK DRIVERS (WEST) - That part of the county West of Barrington Road.

EXPLANATION OF CLASSES

ASBESTOS - GENERAL - removal of asbestos material/mold and hazardous materials from any place in a building, including mechanical systems where those mechanical systems are to be removed. This includes the removal of asbestos materials/mold and hazardous materials from ductwork or pipes in a building when the building is to be demolished at the time or at some close future date.

ASBESTOS - MECHANICAL - removal of asbestos material from mechanical systems, such as pipes, ducts, and boilers, where the mechanical systems are to remain.

CERAMIC TILE FINISHER

The grouting, cleaning, and polishing of all classes of tile, whether for interior or exterior purposes, all burned, glazed or unglazed products; all composition materials, granite tiles, warning detectable tiles, cement tiles, epoxy composite materials, pavers, glass, mosaics, fiberglass, and all substitute materials, for tile made in tile-like units; all mixtures in tile like form of cement, metals, and other materials that are for and intended for use as a finished floor surface, stair treads, promenade roofs, walks, walls, ceilings, swimming pools, and all other places where tile is to form a finished interior or exterior. The mixing of all setting mortars including but not limited to thin-set mortars, epoxies, wall mud, and any other sand and cement mixtures or adhesives when used in the preparation, installation, repair, or maintenance of tile and/or similar materials. The handling and unloading of all sand, cement, lime, tile, fixtures, equipment, adhesives, or any other materials to be used in the preparation, installation, repair, or maintenance of tile and/or similar materials. Ceramic Tile Finishers shall fill all joints and voids regardless of method on all tile work, particularly and especially after installation of said tile work. Application of any and all protective coverings to all types of tile installations including, but not be limited to, all soap compounds, paper products, tapes, and all polyethylene coverings, plywood, masonite, cardboard, and any new type of products that may be used to protect tile installations, Blastrac equipment, and all floor scarifying equipment used in preparing floors to receive tile. The clean up and removal of all waste and materials. All demolition of existing tile floors and walls to be re-tiled.

COMMUNICATIONS ELECTRICIAN

Installation, operation, inspection, maintenance, repair and service of radio, television, recording, voice sound vision production and reproduction, telephone and telephone interconnect, facsimile, data apparatus, coaxial, fibre optic and wireless equipment, appliances and systems used for the transmission and reception of signals of any nature, business, domestic, commercial, education, entertainment, and residential purposes, including but not limited to, communication and

telephone, electronic and sound equipment, fibre optic and data communication systems, and the performance of any task directly related to such installation or service whether at new or existing sites, such tasks to include the placing of wire and cable and electrical power conduit or other raceway work within the equipment room and pulling wire and/or cable through conduit and the installation of any incidental conduit, such that the employees covered hereby can complete any job in full.

MARBLE FINISHER

Loading and unloading trucks, distribution of all materials (all stone, sand, etc.), stocking of floors with material, performing all rigging for heavy work, the handling of all material that may be needed for the installation of such materials, building of scaffolding, polishing if needed, patching, waxing of material if damaged, pointing up, caulking, grouting and cleaning of marble, holding water on diamond or Carborundum blade or saw for setters cutting, use of tub saw or any other saw needed for preparation of material, drilling of holes for wires that anchor material set by setters, mixing up of molding plaster for installation of material, mixing up thin set for the installation of material, mixing up of sand to cement for the installation of material and such other work as may be required in helping a Marble Setter in the handling of all material in the erection or installation of interior marble, slate, travertine, art marble, serpentine, alberene stone, blue stone, granite and other stones (meaning as to stone any foreign or domestic materials as are specified and used in building interiors and exteriors and customarily known as stone in the trade), carrara, sanionyx, vitrolite and similar opaque glass and the laying of all marble tile, terrazzo tile, slate tile and precast tile, steps, risers treads, base, or any other materials that may be used as substitutes for any of the aforementioned materials and which are used on interior and exterior which are installed in a similar manner.

MATERIAL TESTER I: Hand coring and drilling for testing of materials; field inspection of uncured concrete and asphalt.

MATERIAL TESTER II: Field inspection of welds, structural steel, fireproofing, masonry, soil, facade, reinforcing steel, formwork, cured concrete, and concrete and asphalt batch plants; adjusting proportions of bituminous mixtures.

OPERATING ENGINEER - BUILDING

Class 1. Asphalt Plant; Asphalt Spreader; Autograde; Backhoes with Caisson Attachment; Batch Plant; Benoto (requires Two Engineers); Boiler and Throttle Valve; Caisson Rigs; Central Redi-Mix Plant; Combination Back Hoe Front End-loader Machine; Compressor and Throttle Valve; Concrete Breaker (Truck Mounted); Concrete Conveyor; Concrete Conveyor (Truck Mounted); Concrete Paver Over 27E cu. ft; Concrete Paver 27E cu. ft. and Under; Concrete Placer; Concrete Placing Boom; Concrete Pump (Truck Mounted); Concrete Tower; Cranes, All; Cranes, Hammerhead; Cranes, (GCI and similar Type); Creter Crane; Spider Crane; Crusher, Stone, etc.; Derricks, All; Derricks, Traveling; Formless Curb and Gutter Machine; Grader, Elevating; Grouting Machines; Heavy Duty Self-Propelled Transporter or Prime Mover; Highlift Shovels or Front Endloader 2-1/4 yd. and over; Hoists, Elevators, outside type rack and pinion and similar machines; Hoists, One, Two and Three Drum; Hoists, Two Tugger One Floor; Hydraulic Backhoes; Hydraulic Boom Trucks; Hydro Vac (and similar equipment); Locomotives, All; Motor Patrol; Lubrication Technician; Manipulators; Pile Drivers and Skid Rig; Post Hole Digger; Pre-Stress Machine; Pump Cretes Dual Ram; Pump Cretes: Squeeze Cretes-Screw Type Pumps; Gypsum

Bulker and Pump; Raised and Blind Hole Drill; Roto Mill Grinder; Scoops - Tractor Drawn; Slip-Form Paver; Straddle Buggies; Operation of Tie Back Machine; Tournapull; Tractor with Boom and Side Boom; Trenching Machines.

Class 2. Boilers; Broom, All Power Propelled; Bulldozers; Concrete Mixer (Two Bag and Over); Conveyor, Portable; Forklift Trucks; Highlift Shovels or Front Endloaders under 2-1/4 yd.; Hoists, Automatic; Hoists, Inside Elevators; Hoists, Sewer Dragging Machine; Hoists, Tugger Single Drum; Laser Screed; Rock Drill (Self-Propelled); Rock Drill (Truck Mounted); Rollers, All; Steam Generators; Tractors, All; Tractor Drawn Vibratory Roller; Winch Trucks with "A" Frame.

Class 3. Air Compressor; Combination Small Equipment Operator; Generators; Heaters, Mechanical; Hoists, Inside Elevators (remodeling or renovation work); Hydraulic Power Units (Pile Driving, Extracting, and Drilling); Pumps, over 3" (1 to 3 not to exceed a total of 300 ft.); Low Boys; Pumps, Well Points; Welding Machines (2 through 5); Winches, 4 Small Electric Drill Winches.

Class 4. Bobcats and/or other Skid Steer Loaders; Oilers; and Brick Forklift.

Class 5. Assistant Craft Foreman.

Class 6. Gradall.

Class 7. Mechanics; Welders.

OPERATING ENGINEERS - HIGHWAY CONSTRUCTION

Class 1. Asphalt Plant; Asphalt Heater and Planer Combination; Asphalt Heater Scarfire; Asphalt Spreader; Autograder/GOMACO or other similar type machines: ABG Paver; Backhoes with Caisson Attachment; Ballast Regulator; Belt Loader; Caisson Rigs; Car Dumper; Central Redi-Mix Plant; Combination Backhoe Front Endloader Machine, (1 cu. yd. Backhoe Bucket or over or with attachments); Concrete Breaker (Truck Mounted); Concrete Conveyor; Concrete Paver over 27E cu. ft.; Concrete Placer; Concrete Tube Float; Cranes, all attachments; Cranes, Tower Cranes of all types: Creter Crane; Spider Crane; Crusher, Stone, etc.; Derricks, All; Derrick Boats; Derricks, Traveling; Dredges; Elevators, Outside type Rack & Pinion and Similar Machines; Formless Curb and Gutter Machine; Grader, Elevating; Grader, Motor Grader, Motor Patrol, Auto Patrol, Form Grader, Pull Grader, Subgrader; Guard Rail Post Driver Truck Mounted; Hoists, One, Two and Three Drum; Heavy Duty Self-Propelled Transporter or Prime Mover; Hydraulic Backhoes; Backhoes with shear attachments up to 40' of boom reach; Lubrication Technician; Manipulators; Mucking Machine; Pile Drivers and Skid Rig; Pre-Stress Machine; Pump Cretes Dual Ram; Rock Drill - Crawler or Skid Rig; Rock Drill - Truck Mounted; Rock/Track Tamper; Roto Mill Grinder; Slip-Form Paver; Snow Melters; Soil Test Drill Rig (Truck Mounted); Straddle Buggies; Hydraulic Telescoping Form (Tunnel); Operation of Tieback Machine; Tractor Drawn Belt Loader; Tractor Drawn Belt Loader (with attached pusher - two engineers); Tractor with Boom; Tractaire with Attachments; Traffic Barrier Transfer Machine; Trenching; Truck Mounted Concrete Pump with Boom; Raised or Blind Hole Drills (Tunnel Shaft); Underground Boring and/or Mining Machines 5 ft. in diameter and over tunnel, etc; Underground Boring and/or Mining Machines under 5 ft. in diameter; Wheel Excavator; Widener (APSCO).

Class 2. Batch Plant; Bituminous Mixer; Boiler and Throttle Valve; Bulldozers; Car Loader Trailing Conveyors; Combination Backhoe Front Endloader Machine (Less than 1 cu. yd. Backhoe Bucket or over or with attachments); Compressor and Throttle Valve; Compressor, Common

Receiver (3); Concrete Breaker or Hydro Hammer; Concrete Grinding Machine; Concrete Mixer or Paver 7S Series to and including 27 cu. ft.; Concrete Spreader; Concrete Curing Machine, Burlap Machine, Belting Machine and Sealing Machine; Concrete Wheel Saw; Conveyor Muck Cars (Haglund or Similar Type); Drills, All; Finishing Machine - Concrete; Highlift Shovels or Front Endloader; Hoist - Sewer Dragging Machine; Hydraulic Boom Trucks (All Attachments); Hydro-Blaster; Hydro Excavating (excluding hose work); Laser Screed; All Locomotives, Dinky; Off-Road Hauling Units (including articulating) Non Self-Loading Ejection Dump; Pump Cretes: Squeeze Cretes - Screw Type Pumps, Gypsum Bulker and Pump; Roller, Asphalt; Rotary Snow Plows; Rototiller, Seaman, etc., self-propelled; Self-Propelled Compactor; Spreader - Chip - Stone, etc.; Scraper - Single/Twin Engine/Push and Pull; Scraper - Prime Mover in Tandem (Regardless of Size); Tractors pulling attachments, Sheeps Foot, Disc, Compactor, etc.; Tug Boats.

Class 3. Boilers; Brooms, All Power Propelled; Cement Supply Tender; Compressor, Common Receiver (2); Concrete Mixer (Two Bag and Over); Conveyor, Portable; Farm-Type Tractors Used for Mowing, Seeding, etc.; Forklift Trucks; Grouting Machine; Hoists, Automatic; Hoists, All Elevators; Hoists, Tugger Single Drum; Jeep Diggers; Low Boys; Pipe Jacking Machines; Post-Hole Digger; Power Saw, Concrete Power Driven; Pug Mills; Rollers, other than Asphalt; Seed and Straw Blower; Steam Generators; Stump Machine; Winch Trucks with "A" Frame; Work Boats; Tamper-Form-Motor Driven.

Class 4. Air Compressor; Combination - Small Equipment Operator; Directional Boring Machine; Generators; Heaters, Mechanical; Hydraulic Power Unit (Pile Driving, Extracting, or Drilling); Light Plants, All (1 through 5); Pumps, over 3" (1 to 3 not to exceed a total of 300 ft.); Pumps, Well Points; Vacuum Trucks (excluding hose work); Welding Machines (2 through 5); Winches, 4 Small Electric Drill Winches.

Class 5. SkidSteer Loader (all); Brick Forklifts; Oilers.

Class 6. Field Mechanics and Field Welders

Class 7. Dowell Machine with Air Compressor; Gradall and machines of like nature.

OPERATING ENGINEER - FLOATING

Class 1. Craft Foreman; Master Mechanic; Diver/Wet Tender; Engineer; Engineer (Hydraulic Dredge).

Class 2. Crane/Backhoe Operator; Boat Operator with towing endorsement; Mechanic/Welder; Assistant Engineer (Hydraulic Dredge); Leverman (Hydraulic Dredge); Diver Tender.

Class 3. Deck Equipment Operator, Machineryman, Maintenance of Crane (over 50 ton capacity) or Backhoe (115,000 lbs. or more); Tug/Launch Operator; Loader/Dozer and like equipment on Barge, Breakwater Wall, Slip/Dock, or Scow, Deck Machinery, etc.

Class 4. Deck Equipment Operator, Machineryman/Fireman (4 Equipment Units or More); Off Road Trucks; Deck Hand, Tug Engineer, Crane Maintenance (50 Ton Capacity and Under) or Backhoe Weighing (115,000 pounds or less); Assistant Tug Operator.

Class 5. Friction or Lattice Boom Cranes.

TERRAZZO FINISHER

The handling of sand, cement, marble chips, and all other materials

that may be used by the Mosaic Terrazzo Mechanic, and the mixing, grinding, grouting, cleaning and sealing of all Marble, Mosaic, and Terrazzo work, floors, base, stairs, and wainscoting by hand or machine, and in addition, assisting and aiding Marble, Masonic, and Terrazzo Mechanics.

TRAFFIC SAFETY

Work associated with barricades, horses and drums used to reduce lane usage on highway work, the installation and removal of temporary lane markings, and the installation and removal of temporary road signs.

TRUCK DRIVER - BUILDING, HEAVY AND HIGHWAY CONSTRUCTION - EAST & WEST

Class 1. Two or three Axle Trucks. A-frame Truck when used for transportation purposes; Air Compressors and Welding Machines, including those pulled by cars, pick-up trucks and tractors; Ambulances; Batch Gate Lockers; Batch Hopperman; Car and Truck Washers; Carry-alls; Fork Lifts and Hoisters; Helpers; Mechanics Helpers and Greasers; Oil Distributors 2-man operation; Pavement Breakers; Pole Trailer, up to 40 feet; Power Mower Tractors; Self-propelled Chip Spreader; Skipman; Slurry Trucks, 2-man operation; Slurry Truck Conveyor Operation, 2 or 3 man; Teamsters; Unskilled Dumpman; and Truck Drivers hauling warning lights, barricades, and portable toilets on the job site.

Class 2. Four axle trucks; Dump Crets and Adgetors under 7 yards; Dumpsters, Track Trucks, Euclids, Hug Bottom Dump Turnapulls or Turnatrailers when pulling other than self-loading equipment or similar equipment under 16 cubic yards; Mixer Trucks under 7 yards; Ready-mix Plant Hopper Operator, and Winch Trucks, 2 Axles.

Class 3. Five axle trucks; Dump Crets and Adgetors 7 yards and over; Dumpsters, Track Trucks, Euclids, Hug Bottom Dump Turnatrailers or turnapulls when pulling other than self-loading equipment or similar equipment over 16 cubic yards; Explosives and/or Fission Material Trucks; Mixer Trucks 7 yards or over; Mobile Cranes while in transit; Oil Distributors, 1-man operation; Pole Trailer, over 40 feet; Pole and Expandable Trailers hauling material over 50 feet long; Slurry trucks, 1-man operation; Winch trucks, 3 axles or more; Mechanic--Truck Welder and Truck Painter.

Class 4. Six axle trucks; Dual-purpose vehicles, such as mounted crane trucks with hoist and accessories; Foreman; Master Mechanic; Self-loading equipment like P.B. and trucks with scoops on the front.

Other Classifications of Work:

For definitions of classifications not otherwise set out, the Department generally has on file such definitions which are available. If a task to be performed is not subject to one of the classifications of pay set out, the Department will upon being contacted state which neighboring county has such a classification and provide such rate, such rate being deemed to exist by reference in this document. If no neighboring county rate applies to the task, the Department shall undertake a special determination, such special determination being then deemed to have existed under this determination. If a project requires these, or any classification not listed, please contact IDOL at 217-782-1710 for wage rates or clarifications.

LANDSCAPING

Landscaping work falls under the existing classifications for laborer, operating engineer and truck driver. The work performed by

landscape plantsman and landscape laborer is covered by the existing classification of laborer. The work performed by landscape operators (regardless of equipment used or its size) is covered by the classifications of operating engineer. The work performed by landscape truck drivers (regardless of size of truck driven) is covered by the classifications of truck driver.

Crawford County Prevailing Wage for May 2013

(See explanation of column headings at bottom of wages)

Trade Name	RG	TYP	C	Base	FRMAN	M-F>8	OSA	OSH	H/W	Pensn	Vac	Trng
=====	==	===	=	=====	=====	=====	===	===	=====	=====	=====	=====
ASBESTOS ABT-GEN		ALL		25.300	25.750	1.5	1.5	2.0	5.750	10.35	0.000	0.900
ASBESTOS ABT-MEC		BLD		21.150	22.150	1.5	1.5	2.0	6.400	5.150	0.000	0.650
BOILERMAKER		BLD		31.500	34.000	1.5	1.5	2.0	7.070	18.73	1.000	0.350
BRICK MASON		BLD		29.000	30.500	2.0	2.0	2.0	6.600	9.730	0.000	0.630
CARPENTER		BLD		29.600	31.850	1.5	1.5	2.0	7.450	12.65	0.000	0.520
CARPENTER		HWY		28.290	30.040	1.5	1.5	2.0	7.450	12.65	0.000	0.520
CEMENT MASON		BLD		29.800	31.300	1.5	1.5	2.0	6.600	8.360	0.000	0.500
CEMENT MASON		HWY		27.080	28.580	1.5	1.5	2.0	6.600	5.800	0.000	0.300
CERAMIC TILE FNSHER		BLD		28.400	0.000	1.5	1.5	2.0	6.600	7.930	0.000	0.000
COMM SYSTEMS TECH		BLD		26.110	28.700	1.5	1.5	2.0	5.350	5.680	0.000	0.290
ELECTRIC PWR EQMT OP		ALL	1	35.570	0.000	1.5	1.5	2.0	5.000	9.960	0.000	0.360
ELECTRIC PWR EQMT OP		ALL	2	31.740	0.000	1.5	1.5	2.0	5.000	8.880	0.000	0.320
ELECTRIC PWR GRNDMAN		ALL		26.100	0.000	1.5	1.5	2.0	5.000	7.310	0.000	0.260
ELECTRIC PWR LINEMAN		ALL		44.630	47.650	1.5	1.5	2.0	5.000	12.50	0.000	0.450
ELECTRICIAN		BLD		34.920	37.360	1.5	1.5	2.0	5.350	9.030	0.000	0.290
ELEVATOR CONSTRUCTOR		BLD		40.520	45.585	2.0	2.0	2.0	11.88	12.71	3.240	0.600
GLAZIER		BLD		26.780	28.030	1.5	1.5	2.0	6.120	5.200	0.000	0.300
HT/FROST INSULATOR		BLD		29.450	30.450	1.5	1.5	2.0	5.050	9.730	0.000	0.280
IRON WORKER		ALL		28.600	31.460	1.5	1.5	2.0	6.450	11.30	0.000	0.300
LABORER		BLD		25.300	25.750	1.5	1.5	2.0	5.750	10.35	0.000	0.800
LABORER		HWY		25.300	25.750	1.5	1.5	2.0	5.750	10.35	0.000	0.800
LATHER		BLD		29.600	31.850	1.5	1.5	2.0	7.450	12.65	0.000	0.520
MACHINIST		BLD		43.550	46.050	1.5	1.5	2.0	6.130	8.950	1.850	0.000
MARBLE FINISHERS		BLD		28.400	0.000	1.5	1.5	2.0	6.600	7.930	0.000	0.000
MARBLE MASON		BLD		29.900	0.000	1.5	1.5	2.0	6.600	7.930	0.000	0.000
MILLWRIGHT		BLD		29.620	31.870	1.5	1.5	2.0	7.450	13.09	0.000	0.520
MILLWRIGHT		HWY		31.980	33.730	1.5	1.5	2.0	7.450	13.40	0.000	0.520
OPERATING ENGINEER		ALL	1	36.950	0.000	1.5	1.5	2.0	7.250	8.700	0.000	0.800
OPERATING ENGINEER		ALL	2	23.900	0.000	1.5	1.5	2.0	7.250	8.700	0.000	0.800
PAINTER		ALL		26.000	27.500	1.5	1.5	2.0	7.700	8.230	0.000	0.450
PILEDRIVER		BLD		30.100	32.350	1.5	1.5	2.0	7.450	12.65	0.000	0.520
PILEDRIVER		HWY		29.290	31.040	1.5	1.5	2.0	7.450	12.65	0.000	0.520
PIPEFITTER		ALL		35.820	38.510	1.5	1.5	2.0	6.100	6.630	0.000	0.610
PLASTERER		BLD		30.000	32.000	1.5	1.5	2.0	6.600	10.17	0.000	0.500
PLUMBER		ALL		35.820	38.510	1.5	1.5	2.0	6.100	6.630	0.000	0.610
ROOFER		BLD		26.500	29.500	1.5	1.5	2.0	4.600	5.100	0.000	0.350
SHEETMETAL WORKER		BLD		31.390	32.960	1.5	1.5	2.0	7.350	7.690	0.000	1.090
SPRINKLER FITTER		BLD		36.390	39.140	1.5	1.5	2.0	8.420	8.500	0.000	0.450
STONE MASON		BLD		29.000	30.500	2.0	2.0	2.0	6.600	9.730	0.000	0.630
TERRAZZO FINISHER		BLD		28.400	0.000	1.5	1.5	2.0	6.600	7.930	0.000	0.000
TERRAZZO MASON		BLD		29.900	0.000	1.5	1.5	2.0	6.600	7.930	0.000	0.000
TILE LAYER		BLD		29.600	31.850	1.5	1.5	2.0	7.450	12.65	0.000	0.520
TILE MASON		BLD		29.900	0.000	1.5	1.5	2.0	6.600	7.930	0.000	0.000
TRUCK DRIVER		ALL	1	28.955	0.000	1.5	1.5	2.0	9.300	2.900	0.000	0.250
TRUCK DRIVER		ALL	2	29.355	0.000	1.5	1.5	2.0	9.300	2.900	0.000	0.250
TRUCK DRIVER		ALL	3	29.555	0.000	1.5	1.5	2.0	9.300	2.900	0.000	0.250
TRUCK DRIVER		ALL	4	29.805	0.000	1.5	1.5	2.0	9.300	2.900	0.000	0.250
TRUCK DRIVER		ALL	5	30.555	0.000	1.5	1.5	2.0	9.300	2.900	0.000	0.250
TRUCK DRIVER		O&C	1	23.160	0.000	1.5	1.5	2.0	9.300	2.900	0.000	0.250
TRUCK DRIVER		O&C	2	23.480	0.000	1.5	1.5	2.0	9.300	2.900	0.000	0.250
TRUCK DRIVER		O&C	3	23.640	0.000	1.5	1.5	2.0	9.300	2.900	0.000	0.250

TRUCK DRIVER	O&C 4	23.840	0.000	1.5	1.5	2.0	9.300	2.900	0.000	0.250
TRUCK DRIVER	O&C 5	24.440	0.000	1.5	1.5	2.0	9.300	2.900	0.000	0.250
TUCKPINTER	BLD	29.000	30.500	2.0	2.0	2.0	6.600	9.730	0.000	0.630

Legend :

RG (Region)

TYP (Trade Type - All,Highway,Building,Floating,Oil & Chip,Rivers)

C (Class)

Base (Base Wage Rate)

FRMAN (Foreman Rate)

M-F>8 (OT required for any hour greater than 8 worked each day, Mon through Fri.

OSA (Overtime (OT) is required for every hour worked on Saturday)

OSH (Overtime is required for every hour worked on Sunday and Holidays)

H/W (Health & Welfare Insurance)

Pensn (Pension)

Vac (Vacation)

Trng (Training)

Explanations

CRAWFORD COUNTY

The following list is considered as those days for which holiday rates of wages for work performed apply: New Years Day, Memorial Day, Fourth of July, Labor Day, Thanksgiving Day, Christmas Day and Veterans Day in some classifications/counties. Generally, any of these holidays which fall on a Sunday is celebrated on the following Monday. This then makes work performed on that Monday payable at the appropriate overtime rate for holiday pay. Common practice in a given local may alter certain days of celebration. If in doubt, please check with IDOL.

Oil and chip resealing (O&C) means the application of road oils and liquid asphalt to coat an existing road surface, followed by application of aggregate chips or gravel to coated surface, and subsequent rolling of material to seal the surface.

EXPLANATION OF CLASSES

ASBESTOS - GENERAL - removal of asbestos material/mold and hazardous materials from any place in a building, including mechanical systems where those mechanical systems are to be removed. This includes the removal of asbestos materials/mold and hazardous materials from ductwork or pipes in a building when the building is to be demolished at the time or at some close future date.

ASBESTOS - MECHANICAL - removal of asbestos material from mechanical systems, such as pipes, ducts, and boilers, where the mechanical systems are to remain.

CERAMIC TILE FINISHER, MARBLE FINISHER, TERRAZZO FINISHER

Assisting, helping or supporting the tile, marble and terrazzo mechanic by performing their historic and traditional work assignments required to complete the proper installation of the work covered by said crafts. The term "Ceramic" is used for naming the classification only and is in no way a limitation of the product handled. Ceramic takes into consideration most hard tiles.

COMMUNICATION SYSTEMS TECHNICIAN

Installation, operation, inspection, maintenance, repair, and service of radio, television, recording, voice sound and vision production and reproduction apparatus, equipment and appliances used for domestic, commercial, education, entertainment and private telephone systems.

ELECTRIC POWER LINEMAN

Construction, maintenance and dismantling of overhead and underground electric power lines, including high voltage pipe type cable work, and associated structures and equipment.

ELECTRIC POWER EQUIPMENT OPERATOR - CLASS 1

Operation of all crawler type equipment D-4 and larger from the ground to assist the Electric Power Linemen in performing their duties.

ELECTRIC POWER EQUIPMENT OPERATORS - CLASS 2

Operation of all other equipment from the ground to assist the Electric Power Linemen in performing their duties.

ELECTRIC POWER GROUNDMAN

Applies to workers who assist the Electric Power Lineman from the ground.

TRUCK DRIVER - BUILDING, HEAVY AND HIGHWAY CONSTRUCTION

Class 1. Drivers on 2 axle trucks hauling less than 9 ton. Air compressor and welding machines and brooms, including those pulled by separate units, truck driver helpers, warehouse employees, mechanic helpers, greasers and tiremen, pickup trucks when hauling materials, tools, or workers to and from and on-the-job site, and fork lifts up to 6,000 lb. capacity.

Class 2. Two or three axle trucks hauling more than 9 ton but hauling less than 16 ton. A-frame winch trucks, hydrolift trucks, vector trucks or similar equipment when used for transportation purposes. Fork lifts over 6,000 lb. capacity, winch trucks, four axle combination units, and ticket writers.

Class 3. Two, three or four axle trucks hauling 16 ton or more. Drivers on water pulls, articulated dump trucks, mechanics and working forepersons, and dispatchers. Five axle or more combination units.

Class 4. Low Boy and Oil Distributors.

Class 5. Drivers who require special protective clothing while employed on hazardous waste work.

TRUCK DRIVER - OIL AND CHIP RESEALING ONLY.

This shall encompass laborers, workers and mechanics who drive contractor or subcontractor owned, leased, or hired pickup, dump,

service, or oil distributor trucks. The work includes transporting materials and equipment (including but not limited to, oils, aggregate supplies, parts, machinery and tools) to or from the job site; distributing oil or liquid asphalt and aggregate; stock piling material when in connection with the actual oil and chip contract. The Truck Driver (Oil & Chip Resealing) wage classification does not include supplier delivered materials.

OPERATING ENGINEERS - BUILDING, HEAVY AND HIGHWAY CONSTRUCTION

Class 1. Power Cranes, Draglines, Derricks, Shovels, Gradalls, Mechanics, Tractor Highlift, Tournadozer, Concrete Mixers with Skip, Tournamixer, Two Drum Machine, One Drum Hoist with Tower or Boom, Cableways, Tower Machines, Motor Patrol, Boom Tractor, Boom or Winch Truck, Winch or Hydraulic Boom Truck, Truck Crane, Tournapull, Tractor Operating Scoops, Bulldozer, Push Tractor, Asphalt Planer, Finishing Machine on Asphalt, Large Rollers on Earth, Rollers on Asphalt Mix, Ross Carrier or similar Machine, Gravel Processing Machine, Asphalt Plant Engineer, Paver Operator, Dredging Equipment, or Dredge Engineer, or Dredge Operator, Central Mix Plant Engineer, CMI or similar type machine, Concrete Pump, Truck or Skid Mounted, Tower Crane, Engineer or Rock Crusher Plant, Concrete Plant Engineer, Ditching Machine with dual attachment, Tractor Mounted Loaders, Cherry Picker, Hydro Crane, Standard or Dinkey Locomotives, Scoopmobiles, Euclid Loader, Soil Cement Machine, Back Filler, Elevating Machine, Power Blade, Drilling Machine, including Well Testing, Caissons, Shaft or any similar type drilling machines, Motor Driven Paint Machine, Pipe Cleaning Machine, Pipe Wrapping Machine, Pipe Bending Machine, Apsco Paver, Boring Machine, (Head Equipment Greaser), Barber-Greene Loaders, Formless Paver, (Well Point System), Concrete Spreader, Hydra Ax, Span Saw, Marine Scoops, Brush Mulcher, Brush Burner, Mesh Placer, Tree Mover, Helicopter Crew (3), Piledriver-Skid or Crawler, Stump Remover, Root Rake, Tug Boat Operator, Refrigerating Machine, Freezing Operator, Chair Cart-Self-Propelled, Hydra Seeder, Straw Blower, Power Sub Grader, Bull Float, Finishing Machine, Self-Propelled Pavement Breaker, Lull (or similar type Machine), Two Air Compressors, Compressors hooked in Manifold, Overhead Crane, Chip Spreader, Mud Cat, Sull-Air, Fork Lifts (except when used for landscaping work), Soil Stabilizer (Seaman Tiller, Bo Mag, Rago Gator, and similar types of equipment), Tube Float, Spray Machine, Curing Machine, Concrete or Asphalt Milling Machine, Snooper Truck-Operator, Backhoe, Farm Tractors (with attachments), 4 Point Lift System (Power Lift or similar type), Skid-Steer (Bob Cat or similar type), Wrecking Shears, Water Blaster.

Class 2. Concrete Mixers without Skips, Rock Crusher, Ditching Machine under 6', Curbing Machine, One Drum Machines without Tower or Boom, Air Tugger, Self-Propelled Concrete Saw, Machine Mounted Post Hole Digger, two to four Generators, Water Pumps or Welding Machines, within 400 feet, Air Compressor 600 cu. ft. and under, Rollers on Aggregate and Seal Coat Surfaces, Fork Lift (when used for landscaping work), Concrete and Blacktop Curb Machine, One Water Pump, Oilers, Air Valves or Steam Valves, One Welding Machine, Truck Jack, Mud Jack, Gunnite Machine, House Elevators when used for hoisting material, Engine Tenders, Fireman, Wagon Drill, Flex Plane, Conveyor, Siphons and Pulsometer, Switchman, Fireman on Paint Pots, Fireman on Asphalt Plants, Distributor Operator on Trucks, Tampers, Self-Propelled Power Broom, Striping Machine (motor driven), Form Tamper, Bulk Cement Plant, Equipment Greaser, Deck Hands, Truck Crane Oiler-Driver, Cement Blimps, Form Grader, Temporary Heat, Throttle Valve, Super Sucker (and similar type of equipment).

Other Classifications of Work:

For definitions of classifications not otherwise set out, the

Department generally has on file such definitions which are available. If a task to be performed is not subject to one of the classifications of pay set out, the Department will upon being contacted state which neighboring county has such a classification and provide such rate, such rate being deemed to exist by reference in this document. If no neighboring county rate applies to the task, the Department shall undertake a special determination, such special determination being then deemed to have existed under this determination. If a project requires these, or any classification not listed, please contact IDOL at 217-782-1710 for wage rates or clarifications.

LANDSCAPING

Landscaping work falls under the existing classifications for laborer, operating engineer and truck driver. The work performed by landscape plantsman and landscape laborer is covered by the existing classification of laborer. The work performed by landscape operators (regardless of equipment used or its size) is covered by the classifications of operating engineer. The work performed by landscape truck drivers (regardless of size of truck driven) is covered by the classifications of truck driver.

Cumberland County Prevailing Wage for May 2013

(See explanation of column headings at bottom of wages)

Trade Name	RG	TYP	C	Base	FRMAN	M-F>8	OSA	OSH	H/W	Pensn	Vac	Trng
=====	==	===	=	=====	=====	=====	===	===	=====	=====	=====	=====
ASBESTOS ABT-GEN		BLD		29.710	30.960	1.5	1.5	2.0	5.750	9.920	0.000	0.900
ASBESTOS ABT-MEC		BLD		21.150	22.150	1.5	1.5	2.0	6.400	5.150	0.000	0.650
BOILERMAKER		BLD		31.500	34.000	1.5	1.5	2.0	7.070	18.73	1.000	0.350
BRICK MASON		BLD		29.000	30.500	2.0	2.0	2.0	6.600	9.730	0.000	0.630
CARPENTER		BLD		29.600	31.850	1.5	1.5	2.0	7.450	12.65	0.000	0.520
CARPENTER		HWY		29.950	31.700	1.5	1.5	2.0	7.450	12.65	0.000	0.520
CEMENT MASON		BLD		29.800	31.300	1.5	1.5	2.0	6.600	8.360	0.000	0.500
CEMENT MASON		HWY		30.390	31.890	1.5	1.5	2.0	6.600	8.560	0.000	0.500
CERAMIC TILE FNSHER		BLD		28.400	0.000	1.5	1.5	2.0	6.600	7.930	0.000	0.000
ELECTRIC PWR EQMT OP		ALL	1	35.570	0.000	1.5	1.5	2.0	5.000	9.960	0.000	0.360
ELECTRIC PWR EQMT OP		ALL	2	31.740	0.000	1.5	1.5	2.0	5.000	8.880	0.000	0.320
ELECTRIC PWR GRNDMAN		ALL		26.100	0.000	1.5	1.5	2.0	5.000	7.310	0.000	0.260
ELECTRIC PWR LINEMAN		ALL		44.630	47.650	1.5	1.5	2.0	5.000	12.50	0.000	0.450
ELECTRICIAN		BLD		34.200	37.620	1.5	1.5	2.0	5.350	7.610	0.000	0.510
ELECTRONIC SYS TECH		BLD		31.130	32.880	1.5	1.5	2.0	5.350	6.110	0.000	0.400
ELEVATOR CONSTRUCTOR		BLD		40.520	45.585	2.0	2.0	2.0	11.88	12.71	3.240	0.600
GLAZIER		BLD		30.780	32.780	1.5	2.0	2.0	6.630	8.150	0.000	0.380
HT/FROST INSULATOR		BLD		29.450	30.450	1.5	1.5	2.0	5.050	9.730	0.000	0.280
IRON WORKER		ALL		28.600	31.460	1.5	1.5	2.0	6.450	11.30	0.000	0.300
LABORER		BLD		27.710	28.960	1.5	1.5	2.0	5.750	9.920	0.000	0.800
LABORER		HWY		29.120	30.120	1.5	1.5	2.0	5.750	9.920	0.000	0.800
LATHER		BLD		29.600	31.850	1.5	1.5	2.0	7.450	12.65	0.000	0.520
MACHINIST		BLD		43.550	46.050	1.5	1.5	2.0	6.130	8.950	1.850	0.000
MARBLE FINISHERS		BLD		28.400	0.000	1.5	1.5	2.0	6.600	7.930	0.000	0.000
MARBLE MASON		BLD		29.900	0.000	1.5	1.5	2.0	6.600	7.930	0.000	0.000
MILLWRIGHT		BLD		29.620	31.870	1.5	1.5	2.0	7.450	13.09	0.000	0.520
MILLWRIGHT		HWY		31.400	33.150	1.5	1.5	2.0	7.450	13.54	0.000	0.520
OPERATING ENGINEER		ALL	1	36.950	0.000	1.5	1.5	2.0	7.250	8.700	0.000	0.800
OPERATING ENGINEER		ALL	2	23.900	0.000	1.5	1.5	2.0	7.250	8.700	0.000	0.800
PAINTER		ALL		33.560	35.060	1.5	1.5	2.0	6.600	4.420	0.000	0.570
PAINTER SIGNS		ALL		33.560	35.060	1.5	1.5	2.0	6.600	4.420	0.000	0.570
PILEDRIIVER		BLD		30.100	32.350	1.5	1.5	2.0	7.450	12.65	0.000	0.520
PILEDRIIVER		HWY		30.950	32.700	1.5	1.5	2.0	7.450	12.65	0.000	0.520
PIPEFITTER		BLD		37.680	40.180	1.5	1.5	2.0	7.000	10.61	0.000	0.980
PLASTERER		BLD		30.000	32.000	1.5	1.5	2.0	6.600	10.17	0.000	0.500
PLUMBER		BLD		37.680	40.180	1.5	1.5	2.0	7.000	10.61	0.000	0.980

ROOFER	BLD	28.750	30.250	1.5	1.5	2.0	9.150	8.400	0.000	0.200
SHEETMETAL WORKER	BLD	33.640	35.640	1.5	1.5	2.0	8.300	12.00	0.000	0.520
SPRINKLER FITTER	BLD	36.390	39.140	1.5	1.5	2.0	8.420	8.500	0.000	0.450
STONE MASON	BLD	29.000	30.500	2.0	2.0	2.0	6.600	9.730	0.000	0.630
TERRAZZO FINISHER	BLD	28.400	0.000	1.5	1.5	2.0	6.600	7.930	0.000	0.000
TERRAZZO MASON	BLD	29.900	0.000	1.5	1.5	2.0	6.600	7.930	0.000	0.000
TILE LAYER	BLD	29.600	31.850	1.5	1.5	2.0	7.450	12.65	0.000	0.520
TILE MASON	BLD	29.900	0.000	1.5	1.5	2.0	6.600	7.930	0.000	0.000
TRUCK DRIVER	ALL 1	31.230	0.000	1.5	1.5	2.0	10.30	4.840	0.000	0.250
TRUCK DRIVER	ALL 2	31.680	0.000	1.5	1.5	2.0	10.30	4.840	0.000	0.250
TRUCK DRIVER	ALL 3	31.890	0.000	1.5	1.5	2.0	10.30	4.840	0.000	0.250
TRUCK DRIVER	ALL 4	32.180	0.000	1.5	1.5	2.0	10.30	4.840	0.000	0.250
TRUCK DRIVER	ALL 5	33.020	0.000	1.5	1.5	2.0	10.30	4.840	0.000	0.250
TRUCK DRIVER	O&C 1	24.980	0.000	1.5	1.5	2.0	10.30	4.840	0.000	0.250
TRUCK DRIVER	O&C 2	25.340	0.000	1.5	1.5	2.0	10.30	4.840	0.000	0.250
TRUCK DRIVER	O&C 3	25.510	0.000	1.5	1.5	2.0	10.30	4.840	0.000	0.250
TRUCK DRIVER	O&C 4	25.740	0.000	1.5	1.5	2.0	10.30	4.840	0.000	0.250
TRUCK DRIVER	O&C 5	26.420	0.000	1.5	1.5	2.0	10.30	4.840	0.000	0.250
TUCKPOINTER	BLD	29.000	30.500	2.0	2.0	2.0	6.600	9.730	0.000	0.630

Legend :

RG (Region)

TYP (Trade Type - All,Highway,Building,Floating,Oil & Chip,Rivers)

C (Class)

Base (Base Wage Rate)

FRMAN (Foreman Rate)

M-F>8 (OT required for any hour greater than 8 worked each day, Mon through Fri.

OSA (Overtime (OT) is required for every hour worked on Saturday)

OSH (Overtime is required for every hour worked on Sunday and Holidays)

H/W (Health & Welfare Insurance)

Pensn (Pension)

Vac (Vacation)

Trng (Training)

Explanations

CUMBERLAND COUNTY

The following list is considered as those days for which holiday rates of wages for work performed apply: New Years Day, Memorial Day, Fourth of July, Labor Day, Thanksgiving Day, Christmas Day and Veterans Day in some classifications/counties. Generally, any of these holidays which fall on a Sunday is celebrated on the following Monday. This then makes work performed on that Monday payable at the appropriate overtime rate for holiday pay. Common practice in a given local may alter certain days of celebration. If in doubt, please check with IDOL.

Oil and chip resealing (O&C) means the application of road oils and

liquid asphalt to coat an existing road surface, followed by application of aggregate chips or gravel to coated surface, and subsequent rolling of material to seal the surface.

EXPLANATION OF CLASSES

ASBESTOS - GENERAL - removal of asbestos material/mold and hazardous materials from any place in a building, including mechanical systems where those mechanical systems are to be removed. This includes the removal of asbestos materials/mold and hazardous materials from ductwork or pipes in a building when the building is to be demolished at the time or at some close future date.

ASBESTOS - MECHANICAL - removal of asbestos material from mechanical systems, such as pipes, ducts, and boilers, where the mechanical systems are to remain.

CERAMIC TILE FINISHER, MARBLE FINISHER, TERRAZZO FINISHER

Assisting, helping or supporting the tile, marble and terrazzo mechanic by performing their historic and traditional work assignments required to complete the proper installation of the work covered by said crafts. The term "Ceramic" is used for naming the classification only and is in no way a limitation of the product handled. Ceramic takes into consideration most hard tiles.

ELECTRIC POWER LINEMAN

Construction, maintenance and dismantling of overhead and underground electric power lines, including high voltage pipe type cable work, and associated structures and equipment.

ELECTRIC POWER EQUIPMENT OPERATOR - CLASS 1

Operation of all crawler type equipment D-4 and larger from the ground to assist the Electric Power Linemen in performing their duties.

ELECTRIC POWER EQUIPMENT OPERATORS - CLASS 2

Operation of all other equipment from the ground to assist the Electric Power Linemen in performing their duties.

ELECTRIC POWER GROUNDMAN

Applies to workers who assist the Electric Power Lineman from the ground.

ELECTRONIC SYSTEMS TECHNICIAN

Installation, service and maintenance of low-voltage systems which utilizes the transmission and/or transference of voice, sound, vision, or digital for commercial, education, security and entertainment purposes for the following: TV monitoring and surveillance, background/foreground music, intercom and telephone interconnect, field programming, inventory control systems, microwave transmission, multi-media, multiplex, radio page, school, intercom and sound burglar alarms and low voltage master clock systems.

Excluded from this classification are energy management systems, life safety systems, supervisory controls and data acquisition systems not intrinsic with the above listed systems, fire alarm systems, nurse call systems and raceways exceeding fifteen feet in length.

TRUCK DRIVER - BUILDING, HEAVY AND HIGHWAY CONSTRUCTION

Class 1. Drivers on 2 axle trucks hauling less than 9 ton. Air compressor and welding machines and brooms, including those pulled by separate units, truck driver helpers, warehouse employees, mechanic helpers, greasers and tiremen, pickup trucks when hauling materials, tools, or workers to and from and on-the-job site, and fork lifts up to 6,000 lb. capacity.

Class 2. Two or three axle trucks hauling more than 9 ton but hauling less than 16 ton. A-frame winch trucks, hydrolift trucks, vactor trucks or similar equipment when used for transportation purposes. Fork lifts over 6,000 lb. capacity, winch trucks, four axle combination units, and ticket writers.

Class 3. Two, three or four axle trucks hauling 16 ton or more. Drivers on water pulls, articulated dump trucks, mechanics and working forepersons, and dispatchers. Five axle or more combination units.

Class 4. Low Boy and Oil Distributors.

Class 5. Drivers who require special protective clothing while employed on hazardous waste work.

TRUCK DRIVER - OIL AND CHIP RESEALING ONLY.

This shall encompass laborers, workers and mechanics who drive contractor or subcontractor owned, leased, or hired pickup, dump, service, or oil distributor trucks. The work includes transporting materials and equipment (including but not limited to, oils, aggregate supplies, parts, machinery and tools) to or from the job site; distributing oil or liquid asphalt and aggregate; stock piling material when in connection with the actual oil and chip contract. The Truck Driver (Oil & Chip Resealing) wage classification does not include supplier delivered materials.

OPERATING ENGINEERS - BUILDING, HEAVY AND HIGHWAY CONSTRUCTION

Class 1. Power Cranes, Draglines, Derricks, Shovels, Gradalls, Mechanics, Tractor Highlift, Tournadozer, Concrete Mixers with Skip, Tournamixer, Two Drum Machine, One Drum Hoist with Tower or Boom, Cableways, Tower Machines, Motor Patrol, Boom Tractor, Boom or Winch Truck, Winch or Hydraulic Boom Truck, Truck Crane, Tournapull, Tractor Operating Scoops, Bulldozer, Push Tractor, Asphalt Planer, Finishing Machine on Asphalt, Large Rollers on Earth, Rollers on Asphalt Mix, Ross Carrier or similar Machine, Gravel Processing Machine, Asphalt Plant Engineer, Paver Operator, Dredging Equipment, or Dredge Engineer, or Dredge Operator, Central Mix Plant Engineer, CMI or similar type machine, Concrete Pump, Truck or Skid Mounted, Tower Crane, Engineer or Rock Crusher Plant, Concrete Plant Engineer, Ditching Machine with dual attachment, Tractor Mounted Loaders, Cherry Picker, Hydro Crane, Standard or Dinkey Locomotives, Scoopmobiles, Euclid Loader, Soil Cement Machine, Back Filler, Elevating Machine, Power Blade, Drilling Machine, including Well Testing, Caissons, Shaft or any similar type drilling machines, Motor Driven Paint Machine, Pipe Cleaning Machine, Pipe Wrapping Machine, Pipe Bending Machine, Apsco Paver, Boring Machine, (Head Equipment Greaser), Barber-Greene Loaders, Formless Paver, (Well Point System), Concrete Spreader, Hydra Ax, Span Saw, Marine Scoops, Brush Mulcher, Brush Burner, Mesh Placer, Tree Mover, Helicopter Crew (3), Piledriver-Skid or Crawler, Stump Remover, Root Rake, Tug Boat Operator, Refrigerating Machine, Freezing Operator, Chair Cart-Self-Propelled, Hydra Seeder, Straw Blower, Power Sub Grader, Bull Float, Finishing Machine, Self-Propelled Pavement Breaker, Lull (or similar type Machine), Two Air Compressors, Compressors hooked in Manifold, Overhead Crane, Chip Spreader, Mud Cat, Sull-Air, Fork Lifts (except when used for landscaping work), Soil Stabilizer (Seaman

Tiller, Bo Mag, Rago Gator, and similar types of equipment), Tube Float, Spray Machine, Curing Machine, Concrete or Asphalt Milling Machine, Snooper Truck-Operator, Backhoe, Farm Tractors (with attachments), 4 Point Lift System (Power Lift or similar type), Skid-Steer (Bob Cat or similar type), Wrecking Shears, Water Blaster.

Class 2. Concrete Mixers without Skips, Rock Crusher, Ditching Machine under 6', Curbing Machine, One Drum Machines without Tower or Boom, Air Tugger, Self-Propelled Concrete Saw, Machine Mounted Post Hole Digger, two to four Generators, Water Pumps or Welding Machines, within 400 feet, Air Compressor 600 cu. ft. and under, Rollers on Aggregate and Seal Coat Surfaces, Fork Lift (when used for landscaping work), Concrete and Blacktop Curb Machine, One Water Pump, Oilers, Air Valves or Steam Valves, One Welding Machine, Truck Jack, Mud Jack, Gunnite Machine, House Elevators when used for hoisting material, Engine Tenders, Fireman, Wagon Drill, Flex Plane, Conveyor, Siphons and Pulsometer, Switchman, Fireman on Paint Pots, Fireman on Asphalt Plants, Distributor Operator on Trucks, Tampers, Self-Propelled Power Broom, Striping Machine (motor driven), Form Tamper, Bulk Cement Plant, Equipment Greaser, Deck Hands, Truck Crane Oiler-Driver, Cement Blimps, Form Grader, Temporary Heat, Throttle Valve, Super Sucker (and similar type of equipment).

Other Classifications of Work:

For definitions of classifications not otherwise set out, the Department generally has on file such definitions which are available. If a task to be performed is not subject to one of the classifications of pay set out, the Department will upon being contacted state which neighboring county has such a classification and provide such rate, such rate being deemed to exist by reference in this document. If no neighboring county rate applies to the task, the Department shall undertake a special determination, such special determination being then deemed to have existed under this determination. If a project requires these, or any classification not listed, please contact IDOL at 217-782-1710 for wage rates or clarifications.

LANDSCAPING

Landscaping work falls under the existing classifications for laborer, operating engineer and truck driver. The work performed by landscape plantsman and landscape laborer is covered by the existing classification of laborer. The work performed by landscape operators (regardless of equipment used or its size) is covered by the classifications of operating engineer. The work performed by landscape truck drivers (regardless of size of truck driven) is covered by the classifications of truck driver.

De Kalb County Prevailing Wage for May 2013

(See explanation of column headings at bottom of wages)

Trade Name	RG	TYP	C	Base	FRMAN	M-F>8	OSA	OSH	H/W	Pensn	Vac	Trng
=====	==	===	=	=====	=====	=====	===	===	=====	=====	=====	=====
ASBESTOS ABT-GEN		BLD		29.580	30.580	1.5	1.5	2.0	8.240	12.32	0.000	0.800
ASBESTOS ABT-MEC		BLD		34.160	36.660	1.5	1.5	2.0	10.82	10.66	0.000	0.720
BOILERMAKER		BLD		43.450	47.360	2.0	2.0	2.0	6.970	14.66	0.000	0.350
BRICK MASON		BLD		40.680	44.750	1.5	1.5	2.0	9.550	12.00	0.000	0.970
CARPENTER		BLD		36.320	40.320	1.5	1.5	2.0	9.440	13.50	0.000	0.600
CARPENTER		HWY		33.790	35.540	1.5	1.5	2.0	9.750	12.99	0.000	0.490
CEMENT MASON		ALL		41.550	43.550	2.0	1.5	2.0	9.500	13.76	0.000	0.500
CERAMIC TILE FNSHER		BLD		34.440	0.000	2.0	1.5	2.0	9.700	6.930	0.000	0.610
COMMUNICATION TECH		BLD		36.000	39.600	1.5	1.5	2.0	10.14	11.20	0.000	0.720

ELECTRIC PWR EQMT OP	ALL	36.610	49.750	1.5	1.5	2.0	5.000	11.35	0.000	0.270
ELECTRIC PWR GRNDMAN	ALL	28.310	49.750	1.5	1.5	2.0	5.000	8.780	0.000	0.210
ELECTRIC PWR LINEMAN	ALL	43.830	49.750	1.5	1.5	2.0	5.000	13.58	0.000	0.330
ELECTRIC PWR TRK DRV	ALL	29.310	49.750	1.5	1.5	2.0	5.000	9.090	0.000	0.220
ELECTRICIAN	BLD	40.000	44.000	1.5	1.5	2.0	10.14	16.93	0.000	0.800
ELEVATOR CONSTRUCTOR	BLD	45.350	51.020	2.0	2.0	2.0	11.88	12.71	3.630	0.600
FENCE ERECTOR	SE ALL	44.950	47.200	2.0	2.0	2.0	8.890	17.69	0.000	0.400
GLAZIER	BLD	34.730	35.730	1.5	1.5	2.0	9.700	8.200	0.000	1.250
HT/FROST INSULATOR	BLD	45.550	48.050	1.5	1.5	2.0	10.82	11.86	0.000	0.720
IRON WORKER	NW ALL	35.090	36.840	2.0	2.0	2.0	8.250	20.59	0.000	0.700
IRON WORKER	SE ALL	44.950	47.200	2.0	2.0	2.0	8.890	17.69	0.000	0.400
LABORER	BLD	29.580	30.580	1.5	1.5	2.0	8.240	12.32	0.000	0.800
LABORER	HWY	31.950	32.700	1.5	1.5	2.0	8.240	12.50	0.000	0.800
LABORER, SKILLED	HWY	34.250	35.000	1.5	1.5	2.0	8.240	12.50	0.000	0.800
LATHER	BLD	36.320	40.320	1.5	1.5	2.0	9.440	13.50	0.000	0.600
MACHINIST	BLD	43.550	46.050	1.5	1.5	2.0	6.130	8.950	1.850	0.000
MARBLE MASON	BLD	39.880	43.870	1.5	1.5	2.0	9.550	11.75	0.000	0.730
MATERIAL TESTER I	ALL	21.550	0.000	1.5	1.5	2.0	7.460	4.840	0.000	0.170
MATERIALS TESTER II	ALL	26.550	0.000	1.5	1.5	2.0	7.460	4.840	0.000	0.170
MILLWRIGHT	BLD	34.400	37.840	1.5	1.5	2.0	8.770	13.85	0.000	0.500
OPERATING ENGINEER	BLD 1	40.800	44.850	2.0	2.0	2.0	15.85	9.800	2.350	1.300
OPERATING ENGINEER	BLD 2	40.100	44.850	2.0	2.0	2.0	15.85	9.800	2.350	1.300
OPERATING ENGINEER	BLD 3	37.650	44.850	2.0	2.0	2.0	15.85	9.800	2.350	1.300
OPERATING ENGINEER	BLD 4	35.650	44.850	2.0	2.0	2.0	15.85	9.800	2.350	1.300
OPERATING ENGINEER	BLD 5	44.600	44.850	2.0	2.0	2.0	15.85	9.800	2.350	1.300
OPERATING ENGINEER	BLD 6	43.350	44.850	2.0	2.0	2.0	15.85	9.800	2.350	1.300
OPERATING ENGINEER	BLD 7	40.350	44.850	2.0	2.0	2.0	15.85	9.800	2.350	1.300
OPERATING ENGINEER	HWY 1	40.650	44.700	1.5	1.5	2.0	15.85	9.800	2.350	1.300
OPERATING ENGINEER	HWY 2	40.100	44.700	1.5	1.5	2.0	15.85	9.800	2.350	1.300
OPERATING ENGINEER	HWY 3	38.800	44.700	1.5	1.5	2.0	15.85	9.800	2.350	1.300
OPERATING ENGINEER	HWY 4	37.350	44.700	1.5	1.5	2.0	15.85	9.800	2.350	1.300
OPERATING ENGINEER	HWY 5	35.900	44.700	1.5	1.5	2.0	15.85	9.800	2.350	1.300
OPERATING ENGINEER	HWY 6	43.700	44.700	1.5	1.5	2.0	15.85	9.800	2.350	1.300
OPERATING ENGINEER	HWY 7	41.700	44.700	1.5	1.5	2.0	15.85	9.800	2.350	1.300
ORNAMNTL IRON WORKER	SE ALL	44.950	47.200	2.0	2.0	2.0	8.890	17.69	0.000	0.400
PAINTER	ALL	40.880	42.880	1.5	1.5	1.5	9.650	8.200	0.000	1.250
PAINTER SIGNS	BLD	33.920	38.090	1.5	1.5	1.5	2.600	2.710	0.000	0.000
PILEDRIVER	BLD	36.820	40.870	1.5	1.5	2.0	9.440	13.50	0.000	0.600
PILEDRIVER	HWY	33.790	35.540	1.5	1.5	2.0	9.750	12.99	0.000	0.490
PIPEFITTER	BLD	41.200	43.200	1.5	1.5	2.0	9.750	16.34	0.000	1.710
PLASTERER	BLD	40.250	42.670	1.5	1.5	2.0	10.85	10.94	0.000	0.550
PLUMBER	BLD	41.200	43.200	1.5	1.5	2.0	9.750	16.34	0.000	1.710
ROOFER	BLD	38.350	41.350	1.5	1.5	2.0	8.280	8.770	0.000	0.430
SHEETMETAL WORKER	BLD	35.780	37.710	1.5	1.5	2.0	5.450	15.44	0.520	0.290
SPRINKLER FITTER	BLD	36.390	39.140	1.5	1.5	2.0	8.420	8.500	0.000	0.450
STEEL ERECTOR	SE ALL	44.950	47.200	2.0	2.0	2.0	8.890	17.69	0.000	0.400
STONE MASON	BLD	40.680	44.750	1.5	1.5	2.0	9.550	12.00	0.000	0.970
TERRAZZO FINISHER	BLD	35.510	0.000	1.5	1.5	2.0	9.700	9.320	0.000	0.400
TERRAZZO MASON	BLD	39.370	42.370	1.5	1.5	2.0	9.700	10.66	0.000	0.550
TILE LAYER	BLD	36.320	40.320	1.5	1.5	2.0	9.440	13.50	0.000	0.600
TILE MASON	BLD	41.430	45.430	2.0	1.5	2.0	9.700	8.640	0.000	0.710
TRUCK DRIVER	ALL 1	32.550	33.100	1.5	1.5	2.0	6.500	4.350	0.000	0.000
TRUCK DRIVER	ALL 2	32.700	33.100	1.5	1.5	2.0	6.500	4.350	0.000	0.000
TRUCK DRIVER	ALL 3	32.900	33.100	1.5	1.5	2.0	6.500	4.350	0.000	0.000
TRUCK DRIVER	ALL 4	33.100	33.100	1.5	1.5	2.0	6.500	4.350	0.000	0.000
TUCKPOINTER	BLD	40.950	41.950	1.5	1.5	2.0	8.180	10.82	0.000	0.940

Legend:

RG (Region)

TYP (Trade Type - All,Highway,Building,Floating,Oil & Chip,Rivers)

C (Class)

Base (Base Wage Rate)

FRMAN (Foreman Rate)

M-F>8 (OT required for any hour greater than 8 worked each day, Mon through Fri.)

OSA (Overtime (OT) is required for every hour worked on Saturday)

OSH (Overtime is required for every hour worked on Sunday and Holidays)

H/W (Health & Welfare Insurance)

Pensn (Pension)

Vac (Vacation)

Trng (Training)

Explanations

DEKALB COUNTY

IRONWORKERS (NORTHWEST) - That portion of the county from a point where the western county line intersects with Rt. 30, continuing eastward to Shabbona, north between Shabbona and Clare, and northeast between Clare and New Lebanon.

The following list is considered as those days for which holiday rates of wages for work performed apply: New Years Day, Memorial Day, Fourth of July, Labor Day, Thanksgiving Day, Christmas Day and Veterans Day in some classifications/counties. Generally, any of these holidays which fall on a Sunday is celebrated on the following Monday. This then makes work performed on that Monday payable at the appropriate overtime rate for holiday pay. Common practice in a given local may alter certain days of celebration. If in doubt, please check with IDOL.

EXPLANATION OF CLASSES

ASBESTOS - GENERAL - removal of asbestos material/mold and hazardous materials from any place in a building, including mechanical systems where those mechanical systems are to be removed. This includes the removal of asbestos materials/mold and hazardous materials from ductwork or pipes in a building when the building is to be demolished at the time or at some close future date.

ASBESTOS - MECHANICAL - removal of asbestos material from mechanical systems, such as pipes, ducts, and boilers, where the mechanical systems are to remain.

CERAMIC TILE FINISHER

The grouting, cleaning, and polishing of all classes of tile, whether for interior or exterior purposes, all burned, glazed or unglazed products; all composition materials, granite tiles, warning detectable tiles, cement tiles, epoxy composite materials, pavers, glass, mosaics, fiberglass, and all substitute materials, for tile made in tile-like units; all mixtures in tile like form of cement, metals, and other materials that are for and intended for use as a finished floor surface, stair treads, promenade roofs, walks, walls, ceilings,

swimming pools, and all other places where tile is to form a finished interior or exterior. The mixing of all setting mortars including but not limited to thin-set mortars, epoxies, wall mud, and any other sand and cement mixtures or adhesives when used in the preparation, installation, repair, or maintenance of tile and/or similar materials. The handling and unloading of all sand, cement, lime, tile, fixtures, equipment, adhesives, or any other materials to be used in the preparation, installation, repair, or maintenance of tile and/or similar materials. Ceramic Tile Finishers shall fill all joints and voids regardless of method on all tile work, particularly and especially after installation of said tile work. Application of any and all protective coverings to all types of tile installations including, but not be limited to, all soap compounds, paper products, tapes, and all polyethylene coverings, plywood, masonite, cardboard, and any new type of products that may be used to protect tile installations, Blastrac equipment, and all floor scarifying equipment used in preparing floors to receive tile. The clean up and removal of all waste and materials. All demolition of existing tile floors and walls to be re-tiled.

COMMUNICATIONS TECHNICIAN

Installing, manufacturing, assembling and maintaining sound and intercom, protection alarm (security), fire alarm, master antenna television, closed circuit television, low voltage control for computers and/or door monitoring, school communications systems, telephones and servicing of nurse and emergency calls, and the installation and maintenance of transmit and receive antennas, transmitters, receivers, and associated apparatus which operates in conjunction with above systems. All work associated with these system installations will be included EXCEPT the installation of protective metallic conduit in new construction projects (excluding less than ten-foot, runs strictly for protection of cable) and 120 volt AC (or higher) power wiring and associated hardware.

LABORER, SKILLED - HIGHWAY

Individuals engaged in the following types of work, irrespective of the site of the work: asbestos abatement worker, handling of any materials with any foreign matter harmful to skin or clothing, track laborer, cement handlers, chloride handlers, the unloading and loading with steel workers and re-bars, concrete workers wet, tunnel helpers in free air, batch dumpers, mason tenders, kettle and tar men, tank cleaners, plastic installers, scaffold workers, motorized buggies or motorized unit used for wet concrete or handling of building materials, laborers with de-watering systems, sewer workers plus depth, rod and chainmen with technical engineers, rod and chainmen with land surveyors, rod and chainmen with surveyors, vibrator operators, cement silica, clay, fly ash, lime and plasters, handlers (bulk or bag), cofferdam workers plus depth, on concrete paving, placing, cutting and tying of reinforcing, deck hand, dredge hand, and shore laborers, bankmen on floating plant, grade checker, power tools, front end man on chip spreaders, cession workers plus depth, gunnite nozzle men, lead man on sewer work, welders, cutters, burners and torchmen, chainsaw operators, jackhammer and drill operators, layout man and/or drainage tile layer, steel form setter - street and highway, air tamping hammermen, signal man on crane, concrete saw operator, screedman on asphalt pavers, laborers tending masons with hot material or where foreign materials are used, mortar mixer operators, multiple concrete duct - leadsman, lumen, asphalt raker, curb asphalt machine operator, ready mix scalemen (permanent, portable or temporary plant), laborers handling masterplate or similar materials, laser beam operator, concrete burning machine operator, coring machine operator, plaster tender, underpinning and shoring of buildings, pump men, manhole and catch basin, dirt and stone tamper,

hose men on concrete pumps, hazardous waste worker, lead base paint abatement worker, lining of pipe, refusing machine, assisting on direct boring machine, the work of laying watermain, fire hydrants, all mechanical joints to watermain work, sewer worker, and tapping water service and forced lift station mechanical worker.

MATERIAL TESTER I: Hand coring and drilling for testing of materials; field inspection of uncured concrete and asphalt.

MATERIAL TESTER II: Field inspection of welds, structural steel, fireproofing, masonry, soil, facade, reinforcing steel, formwork, cured concrete, and concrete and asphalt batch plants; adjusting proportions of bituminous mixtures.

OPERATING ENGINEERS - BUILDING

Class 1. Asphalt Plant; Asphalt Spreader; Autograde; Backhoes with Caisson Attachment; Batch Plant; Benoto (requires Two Engineers); Boiler and Throttle Valve; Caisson Rigs; Central Redi-Mix Plant; Combination Back Hoe Front End-loader Machine; Compressor and Throttle Valve; Concrete Breaker (Truck Mounted); Concrete Conveyor; Concrete Paver (over 27E cu. ft.): Concrete Paver (27 cu. ft. and under); Concrete Placer; Concrete Pump (Truck Mounted); Concrete Conveyor (Truck Mounted); Concrete Tower; Cranes, All; GCI and similar types (required two operators only); Cranes, Hammerhead; Creter Crane; Crusher, Stone, etc.; Derricks, All; Derricks, Traveling; Formless Curb and Gutter Machine; Grader, Elevating; Grouting Machines; Highlift Shovels or Front Endloader 2-1/4 yd. and over; Hoists, Elevators, outside type rack and pinion and similar machines; Hoists, one, two and three Drum; Hoists, Two Tugger One Floor; Hydraulic Backhoes; Hydraulic Boom Trucks; Hydro Vac (and similar equipment - excluding hose work and any sewer work); Locomotives, All; Lubrication Technician; Manipulators; Motor Patrol; Pile Drivers and Skid Rig; Post Hole Digger; Pre-Stress Machine; Pump Cretes Dual Ram; Pump Cretes: Squeeze Cretes - Screw Type Pumps, Gypsum Bulker and Pump; Raised and Blind Hole Drill; Rock Drill (self-propelled); Rock Drill - Truck Mounted; Roto Mill Grinder; Scoops - Tractor Drawn; Slipform Paver; Scrapers Prime Movers; Straddle Buggies; Tie Back Machine; Tractor with Boom and Side Boom; Trenching Machines.

Class 2. Bobcat (over 3/4 cu. yd.); Boilers; Brick Forklift; Broom, All Power Propelled; Bulldozers; Concrete Mixer (Two Bag and Over); Conveyor, Portable; Forklift Trucks; Highlift Shovels or Front Endloaders under 2-1/4 yd.; Hoists, Automatic; Hoists, Sewer Dragging Machine; Hoists, Tugger Single Drum; Laser Screed; Rollers, All; Steam Generators; Tractors, All; Tractor Drawn Vibratory Roller; Winch Trucks with "A" Frame.

Class 3. Air Compressor; Asphalt Spreader; Combination - Small Equipment Operator; Generators; Heaters, Mechanical; Hoists, Inside Elevators - (Rheostat Manual Controlled); Hydraulic Power Units (Pile Driving, Extracting, or Drilling - with a seat); Lowboys; Pumps, Over 3" (1 to 3 not to exceed total of 300 ft.); Pumps, Well Points; Welding Machines (2 through 5); Winches, 4 Small Electric Drill Winches; Bobcat (up to and including 3/4 cu. yd.).

Class 4. Elevator push button with automatic doors; Hoists, Inside; Oilers; Brick Forklift.

Class 5. Assistant Craft Foreman

Class 6. Mechanics; Welders.

Class 7. Gradall

OPERATING ENGINEERS - HIGHWAY CONSTRUCTION

Class 1. Asphalt Plant; Asphalt Heater and Planer Combination; Asphalt Heater Scarfire; Asphalt Silo Tender; Asphalt Spreader; Autograder; ABG Paver; Backhoes with Caisson Attachment; Ballast Regulator; Belt Loader; Caisson Rigs; Car Dumper; Central Redi-Mix Plant; Backhoe w/shear attachments; Combination Backhoe Front Endloader Machine, (1 cu. yd. Backhoe Bucket or over or with attachments); Concrete Breaker (Truck Mounted); Concrete Conveyor; Concrete Paver over 27E cu. ft.; Concrete Placer; Concrete Tube Float; Cranes, all attachments; Cranes, Tower of all types; Creter Crane; Crusher, Stone, etc.; Derricks, All; Derrick Boats; Derricks, Traveling; Directional Boring Machine over 12"; Dredges; Formless Curb and Gutter Machine; Grader, Elevating; Grader, Motor Grader, Motor Patrol, Auto Patrol, Form Grader, Pull Grader, Subgrader; Guard Rail Post Driver Mounted; Hoists, One, Two and Three Drum; Hydraulic Backhoes; Hydro Vac, Self Propelled, Truck Mounted (excluding hose work and any sewer work); Lubrication Technician; Manipulators; Pile Drivers and Skid Rig; Pre-Stress Machine; Pump Cretes Dual Ram; Rock Drill - Crawler or Skid Rig; Rock Drill - Truck Mounted; Rock/Track Tamper; Roto Mill Grinder; Slip-Form Paver; Snow Melters; Soil Test Drill Rig (Truck Mounted); Straddle Buggies; GCI Crane; Hydraulic Telescoping Form (Tunnel); Tie Back Machine; Tractor Drawn Belt Loader; Tractor Drawn Belt Loader with attached pusher; Tractor with Boom; Tractaire with Attachments; Traffic Barrier Conveyor Machine; Raised or Blind Hole Drills; Trenching Machine (over 12"); Truck Mounted Concrete Pump with Boom; Truck Mounted Concrete Conveyor; Work Boat (no license required - 90 h.p. or above); Underground Boring and/or Mining Machines; Wheel Excavator; Widener (APSCO).

Class 2. Batch Plant; Bituminous Mixer; Boiler and Throttle Valve; Bulldozers; Car Loader Trailing Conveyors; Combination Backhoe Front Endloader Machine (less than 1 cu. yd. Backhoe Bucket or over or with attachments); Compressor and Throttle Valve; Compressor, Common Receiver (3); Concrete Breaker or Hydro Hammer; Concrete Grinding Machine; Concrete Mixer or Paver 7S Series to and including 27 cu. ft.; Concrete Spreader; Concrete Curing Machine, Burlap Machine, Belting Machine and Sealing Machine; Concrete Wheel Saw (large self-propelled - excluding walk-behinds and hand-held); Conveyor Muck Cars (Haglund or Similar Type); Drills, all; Finishing Machine - Concrete; Highlift Shovels or Front Endloader; Hoist - Sewer Dragging Machine; Hydraulic Boom Trucks (All Attachments); Hydro Blaster; All Locomotives, Dinky; Off-Road Hauling Units; Non-Self Loading Dump; Ejection Dump; Pump Cretes: Squeeze Cretes - Screw Type Pumps, Gypsum Bulker and Pump; Roller, Asphalt; Rotary Snow Plows; Rototiller, Seaman, etc., self-propelled; Scoops - Tractor Drawn; Self-Propelled Compactor; Spreader - Chip - Stone, etc.; Scraper; Scraper - Prime Mover in Tandem (Regardless of Size); Tank Car Heater; Tractors, Push, Pulling Sheeps Foot, Disc, Compactor, etc.; Tug Boats.

Class 3. Boilers; Brooms, All Power Propelled; Cement Supply Tender; Compressor, Common Receiver (2); Concrete Mixer (Two Bag and Over); Conveyor, Portable; Farm-Type Tractors Used for Mowing, Seeding, etc.; Fireman on Boilers; Forklift Trucks; Grouting Machine; Hoists, Automatic; Hoists, All Elevators; Hoists, Tugger Single Drum; Jeep Diggers; Low Boys; Pipe Jacking Machines; Post-Hole Digger; Power Saw, Concrete Power Driven; Pug Mills; Rollers, other than asphalt; Seed and Straw Blower; Steam Generators; Stump Machine; Winch Trucks with "A" Frame; Work Boats; Tamper - Form - Motor Driven.

Class 4. Air Compressor - Small and Large; Asphalt Spreader, Backend Man; Bobcat (Skid Steer) all; Brick Forklift; Combination - Small Equipment Operator; Directional Boring Machine up to 12"; Generators; Heaters, Mechanical; Hydraulic Power Unit (Pile Driving, Extracting,

or Drilling); Hydro-Blaster; Light Plants, All (1 through 5); Pumps, over 3" (1 to 3 not to exceed a total of 300 ft.); Pumps, Well Points; Tractaire; Trencher 12" and under; Welding Machines (2 through 5); Winches, 4 Small Electric Drill Winches.

Class 5. Oilers and Directional Boring Machine Locator.

Class 6. Field Mechanics and Field Welders

Class 7. Gradall and machines of like nature.

TERRAZZO FINISHER

The handling of sand, cement, marble chips, and all other materials that may be used by the Mosaic Terrazzo Mechanic, and the mixing, grinding, grouting, cleaning and sealing of all Marble, Mosaic, and Terrazzo work, floors, base, stairs, and wainscoting by hand or machine, and in addition, assisting and aiding Marble, Masonic, and Terrazzo Mechanics.

TRUCK DRIVER - BUILDING, HEAVY AND HIGHWAY CONSTRUCTION

Class 1. Two or three Axle Trucks. A-frame Truck when used for transportation purposes; Air Compressors and Welding Machines, including those pulled by cars, pick-up trucks and tractors; Ambulances; Batch Gate Lockers; Batch Hopperman; Car and Truck Washers; Carry-alls; Fork Lifts and Hoisters; Helpers; Mechanics Helpers and Greasers; Oil Distributors 2-man operation; Pavement Breakers; Pole Trailer, up to 40 feet; Power Mower Tractors; Self-propelled Chip Spreader; Skipman; Slurry Trucks, 2-man operation; Slurry Truck Conveyor Operation, 2 or 3 man; Teamsters Unskilled dumpman; and Truck Drivers hauling warning lights, barricades, and portable toilets on the job site.

Class 2. Four axle trucks; Dump Crets and Adgetors under 7 yards; Dumpsters, Track Trucks, Euclids, Hug Bottom Dump Turnapulls or Turnatrailers when pulling other than self-loading equipment or similar equipment under 16 cubic yards; Mixer Trucks under 7 yards; Ready-mix Plant Hopper Operator, and Winch Trucks, 2 Axles.

Class 3. Five axle trucks; Dump Crets and Adgetors 7 yards and over; Dumpsters, Track Trucks, Euclids, Hug Bottom Dump Turnatrailers or turnapulls when pulling other than self-loading equipment or similar equipment over 16 cubic yards; Explosives and/or Fission Material Trucks; Mixer Trucks 7 yards or over; Mobile Cranes while in transit; Oil Distributors, 1-man operation; Pole Trailer, over 40 feet; Pole and Expandable Trailers hauling material over 50 feet long; Slurry trucks, 1-man operation; Winch trucks, 3 axles or more; Mechanic--Truck Welder and Truck Painter.

Class 4. Six axle trucks; Dual-purpose vehicles, such as mounted crane trucks with hoist and accessories; Foreman; Master Mechanic; Self-loading equipment like P.B. and trucks with scoops on the front.

Other Classifications of Work:

For definitions of classifications not otherwise set out, the Department generally has on file such definitions which are available. If a task to be performed is not subject to one of the classifications of pay set out, the Department will upon being contacted state which neighboring county has such a classification and provide such rate, such rate being deemed to exist by reference in this document. If no neighboring county rate applies to the task, the Department shall undertake a special determination, such special

determination being then deemed to have existed under this determination. If a project requires these, or any classification not listed, please contact IDOL at 217-782-1710 for wage rates or clarifications.

LANDSCAPING

Landscaping work falls under the existing classifications for laborer, operating engineer and truck driver. The work performed by landscape plantsman and landscape laborer is covered by the existing classification of laborer. The work performed by landscape operators (regardless of equipment used or its size) is covered by the classifications of operating engineer. The work performed by landscape truck drivers (regardless of size of truck driven) is covered by the classifications of truck driver.

Dewitt County Prevailing Wage for May 2013

(See explanation of column headings at bottom of wages)

Trade Name	RG	TYP	C	Base	FRMAN	M-F>8	OSA	OSH	H/W	Pensn	Vac	Trng
=====	==	===	=	=====	=====	=====	===	===	=====	=====	=====	=====
ASBESTOS ABT-GEN		BLD		30.630	31.880	1.5	1.5	2.0	5.750	9.790	0.000	0.900
ASBESTOS ABT-MEC		BLD		29.860	30.860	1.5	1.5	2.0	6.950	3.000	0.000	0.000
BOILERMAKER		BLD		35.010	38.010	2.0	2.0	2.0	7.070	13.83	0.000	0.300
BRICK MASON		BLD		29.820	31.320	1.5	1.5	2.0	7.700	11.23	0.000	0.560
CARPENTER		BLD		30.050	32.300	1.5	1.5	2.0	7.450	12.91	0.000	0.520
CARPENTER		HWY		31.000	33.250	1.5	1.5	2.0	7.450	13.76	0.000	0.520
CEMENT MASON	N	ALL		30.590	31.590	1.5	1.5	2.0	5.750	11.23	0.000	0.500
CEMENT MASON	S	BLD		28.960	29.960	1.5	1.5	2.0	7.450	10.73	0.000	0.500
CEMENT MASON	S	HWY		27.370	28.870	1.5	1.5	2.0	7.450	10.73	0.000	0.500
CERAMIC TILE FNSHER		BLD		29.750	0.000	1.5	1.5	2.0	7.700	9.130	0.000	0.550
ELECTRIC PWR EQMT OP		ALL		35.440	0.000	1.5	1.5	2.0	5.000	10.98	0.000	0.270
ELECTRIC PWR GRNDMAN		ALL		24.320	0.000	1.5	1.5	2.0	5.000	7.540	0.000	0.180
ELECTRIC PWR LINEMAN		ALL		39.370	41.910	1.5	1.5	2.0	5.000	12.20	0.000	0.300
ELECTRIC PWR TRK DRV		ALL		25.510	0.000	1.5	1.5	2.0	5.000	7.920	0.000	0.190
ELECTRICIAN		BLD		34.200	37.620	1.5	1.5	2.0	5.350	7.610	0.000	0.510
ELECTRONIC SYS TECH		BLD		29.420	31.170	1.5	1.5	2.0	5.350	7.330	0.000	0.400
ELEVATOR CONSTRUCTOR		BLD		40.520	45.585	2.0	2.0	2.0	11.88	12.71	3.240	0.600
FENCE ERECTOR		ALL		30.610	32.510	1.5	1.5	2.0	8.840	8.420	0.000	0.900
GLAZIER		BLD		30.780	32.780	1.5	2.0	2.0	6.630	8.150	0.000	0.380
HT/FROST INSULATOR		BLD		37.260	38.260	1.5	1.5	2.0	7.850	11.16	0.000	0.500
IRON WORKER	E	ALL		30.610	32.510	1.5	1.5	2.0	8.840	8.420	0.000	0.900
IRON WORKER	W	BLD		29.460	31.460	1.5	1.5	2.0	7.740	11.38	0.000	0.660
IRON WORKER	W	HWY		30.600	32.100	1.5	1.5	2.0	7.740	11.69	0.000	0.660
LABORER		BLD		28.630	29.880	1.5	1.5	2.0	5.750	9.790	0.000	0.800
LABORER		HWY		29.650	30.650	1.5	1.5	2.0	5.750	9.790	0.000	0.800
LATHER		BLD		30.050	32.300	1.5	1.5	2.0	7.450	12.91	0.000	0.520
MACHINIST		BLD		43.550	46.050	1.5	1.5	2.0	6.130	8.950	1.850	0.000
MARBLE FINISHERS		BLD		29.750	0.000	1.5	1.5	2.0	7.700	9.130	0.000	0.550
MARBLE MASON		BLD		31.510	32.760	1.5	1.5	2.0	7.700	9.130	0.000	0.550
MILLWRIGHT		BLD		30.300	32.550	1.5	1.5	2.0	7.450	13.09	0.000	0.520
MILLWRIGHT		HWY		31.820	34.070	1.5	1.5	2.0	7.450	13.44	0.000	0.520
OPERATING ENGINEER		BLD	1	33.900	35.400	1.5	1.5	2.0	10.05	7.600	0.000	1.300
OPERATING ENGINEER		BLD	2	31.550	35.400	1.5	1.5	2.0	10.05	7.600	0.000	1.300
OPERATING ENGINEER		BLD	3	27.950	35.400	1.5	1.5	2.0	10.05	7.600	0.000	1.300
OPERATING ENGINEER		BLD	4	35.400	35.400	1.5	1.5	2.0	10.05	7.600	0.000	1.300
OPERATING ENGINEER		HWY	1	37.600	39.100	1.5	1.5	2.0	10.05	8.100	0.000	1.300
OPERATING ENGINEER		HWY	2	33.660	39.100	1.5	1.5	2.0	10.05	8.100	0.000	1.300
OPERATING ENGINEER		HWY	3	27.630	39.100	1.5	1.5	2.0	10.05	8.100	0.000	1.300
OPERATING ENGINEER		HWY	4	39.100	39.100	1.5	1.5	2.0	10.05	8.100	0.000	1.300
OPERATING ENGINEER		O&C		30.080	0.000	1.5	1.5	2.0	10.05	7.600	0.000	1.300
PAINTER		ALL		28.250	29.750	1.5	1.5	2.0	5.750	9.420	0.000	0.650
PAINTER OVER 30FT		ALL		28.500	30.000	1.5	1.5	2.0	5.750	9.420	0.000	0.650

PAINTER PWR EQMT	ALL	29.250	30.750	1.5	1.5	2.0	5.750	9.420	0.000	0.650
PILEDRIVER	BLD	30.550	32.800	1.5	1.5	2.0	7.450	12.91	0.000	0.520
PILEDRIVER	HWY	32.000	34.250	1.5	1.5	2.0	7.450	13.76	0.000	0.520
PIPEFITTER	BLD	36.050	39.050	1.5	1.5	2.0	7.000	7.650	0.000	1.220
PLASTERER	BLD	29.500	31.500	1.5	1.5	2.0	6.300	13.83	0.000	0.500
PLUMBER	BLD	36.050	39.050	1.5	1.5	2.0	7.000	7.650	0.000	1.220
ROOFER	BLD	28.580	30.010	1.5	1.5	2.0	8.450	7.220	0.000	0.250
SHEETMETAL WORKER	BLD	31.560	33.810	1.5	1.5	2.0	8.300	12.59	0.000	0.550
SPRINKLER FITTER	BLD	36.390	39.140	1.5	1.5	2.0	8.420	8.500	0.000	0.450
TERRAZZO FINISHER	BLD	29.750	0.000	1.5	1.5	2.0	7.700	9.130	0.000	0.550
TERRAZZO MASON	BLD	31.510	32.760	1.5	1.5	2.0	7.700	9.130	0.000	0.550
TILE MASON	BLD	31.510	32.760	1.5	1.5	2.0	7.700	9.130	0.000	0.550
TRUCK DRIVER	O&C 1	24.980	0.000	1.5	1.5	2.0	10.30	4.840	0.000	0.250
TRUCK DRIVER	O&C 2	25.340	0.000	1.5	1.5	2.0	10.30	4.840	0.000	0.250
TRUCK DRIVER	O&C 3	25.510	0.000	1.5	1.5	2.0	10.30	4.840	0.000	0.250
TRUCK DRIVER	O&C 4	25.740	0.000	1.5	1.5	2.0	10.30	4.840	0.000	0.250
TRUCK DRIVER	O&C 5	26.420	0.000	1.5	1.5	2.0	10.30	4.840	0.000	0.250
TRUCK DRIVER	N ALL 1	31.230	0.000	1.5	1.5	2.0	10.30	4.840	0.000	0.250
TRUCK DRIVER	N ALL 2	31.680	0.000	1.5	1.5	2.0	10.30	4.840	0.000	0.250
TRUCK DRIVER	N ALL 3	31.890	0.000	1.5	1.5	2.0	10.30	4.840	0.000	0.250
TRUCK DRIVER	N ALL 4	32.180	0.000	1.5	1.5	2.0	10.30	4.840	0.000	0.250
TRUCK DRIVER	N ALL 5	33.020	0.000	1.5	1.5	2.0	10.30	4.840	0.000	0.250
TRUCK DRIVER	S ALL 1	31.340	0.000	1.5	1.5	2.0	10.30	5.010	0.000	0.250
TRUCK DRIVER	S ALL 2	31.780	0.000	1.5	1.5	2.0	10.30	5.010	0.000	0.250
TRUCK DRIVER	S ALL 3	32.020	0.000	1.5	1.5	2.0	10.30	5.010	0.000	0.250
TRUCK DRIVER	S ALL 4	32.280	0.000	1.5	1.5	2.0	10.30	5.010	0.000	0.250
TRUCK DRIVER	S ALL 5	33.130	0.000	1.5	1.5	2.0	10.30	5.010	0.000	0.250

Legend :

RG (Region)

TYP (Trade Type - All,Highway,Building,Floating,Oil & Chip,Rivers)

C (Class)

Base (Base Wage Rate)

FRMAN (Foreman Rate)

M-F>8 (OT required for any hour greater than 8 worked each day, Mon through Fri.

OSA (Overtime (OT) is required for every hour worked on Saturday)

OSH (Overtime is required for every hour worked on Sunday and Holidays)

H/W (Health & Welfare Insurance)

Pensn (Pension)

Vac (Vacation)

Trng (Training)

Explanations

DEWITT COUNTY

IRONWORKERS (EAST) - That part of the county East including Clinton.

CEMENT MASON & PLASTERERS (SOUTH) - That part of the county South

including Clinton.

TRUCK DRIVERS (NORTH) - That part of the county north of Route 10.

The following list is considered as those days for which holiday rates of wages for work performed apply: New Years Day, Memorial Day, Fourth of July, Labor Day, Thanksgiving Day, Christmas Day and Veterans Day in some classifications/counties. Generally, any of these holidays which fall on a Sunday is celebrated on the following Monday. This then makes work performed on that Monday payable at the appropriate overtime rate for holiday pay. Common practice in a given local may alter certain days of celebration. If in doubt, please check with IDOL.

Oil and chip resealing (O&C) means the application of road oils and liquid asphalt to coat an existing road surface, followed by application of aggregate chips or gravel to coated surface, and subsequent rolling of material to seal the surface.

EXPLANATION OF CLASSES

ASBESTOS - GENERAL - removal of asbestos material/mold and hazardous materials from any place in a building, including mechanical systems where those mechanical systems are to be removed. This includes the removal of asbestos materials/mold and hazardous materials from ductwork or pipes in a building when the building is to be demolished at the time or at some close future date.

ASBESTOS - MECHANICAL - removal of asbestos material from mechanical systems, such as pipes, ducts, and boilers, where the mechanical systems are to remain.

CERAMIC TILE FINISHER, MARBLE FINISHER, TERRAZZO FINISHER

Assisting, helping or supporting the tile, marble and terrazzo mechanic by performing their historic and traditional work assignments required to complete the proper installation of the work covered by said crafts. The term "Ceramic" is used for naming the classification only and is in no way a limitation of the product handled. Ceramic takes into consideration most hard tiles.

ELECTRONIC SYSTEMS TECHNICIAN

Installation, service and maintenance of low-voltage systems which utilizes the transmission and/or transference of voice, sound, vision, or digital for commercial, education, security and entertainment purposes for the following: TV monitoring and surveillance, background/foreground music, intercom and telephone interconnect, field programming, inventory control systems, microwave transmission, multi-media, multiplex, radio page, school, intercom and sound burglar alarms and low voltage master clock systems.

Excluded from this classification are energy management systems, life safety systems, supervisory controls and data acquisition systems not intrinsic with the above listed systems, fire alarm systems, nurse call systems and raceways exceeding fifteen feet in length.

TRUCK DRIVER - BUILDING, HEAVY AND HIGHWAY CONSTRUCTION

Class 1. Drivers on 2 axle trucks hauling less than 9 ton. Air compressor and welding machines and brooms, including those pulled by separate units, truck driver helpers, warehouse employees, mechanic helpers, greasers and tiremen, pickup trucks when hauling materials, tools, or workers to and from and on-the-job site, and fork lifts up to 6,000 lb. capacity.

Class 2. Two or three axle trucks hauling more than 9 ton but hauling less than 16 ton. A-frame winch trucks, hydrolift trucks, vactor trucks or similar equipment when used for transportation purposes. Fork lifts over 6,000 lb. capacity, winch trucks, four axle combination units, and ticket writers.

Class 3. Two, three or four axle trucks hauling 16 ton or more. Drivers on water pulls, articulated dump trucks, mechanics and working forepersons, and dispatchers. Five axle or more combination units.

Class 4. Low Boy and Oil Distributors.

Class 5. Drivers who require special protective clothing while employed on hazardous waste work.

TRUCK DRIVER - OIL AND CHIP RESEALING ONLY.

This shall encompass laborers, workers and mechanics who drive contractor or subcontractor owned, leased, or hired pickup, dump, service, or oil distributor trucks. The work includes transporting materials and equipment (including but not limited to, oils, aggregate supplies, parts, machinery and tools) to or from the job site; distributing oil or liquid asphalt and aggregate; stock piling material when in connection with the actual oil and chip contract. The Truck Driver (Oil & Chip Resealing) wage classification does not include supplier delivered materials.

OPERATING ENGINEERS - BUILDING

CLASS 1. Asphalt Screed Man; Aspco Concrete Spreaders; Asphalt Pavers; Asphalt Plant Engineer; Asphalt Rollers on Bituminous Concrete; Athey Loaders; Backfillers, Crane Type; Backhoes; Barber Green Loaders; Bulldozers; Cableways; Cherry Pickers; Clam Shells; C.M.I. & similar type autograde formless paver, autograde placer & finisher; Concrete Breakers; Concrete Pumps; Derricks; Derrick Boats; Draglines; Earth Auger or Boring Machines; Elevating Graders; Engineers on Dredges; Gravel Processing Machines; Head Equipment Greaser; High Lifts or Fork Lifts; Hoists with two or more drums or two or more load lines; Locomotives, All; Mechanics; Motor Graders or Auto Patrols; Operators or Leverman on Dredges; Operators, Power Boat; Operators, Pug Mill (Asphalt Plants); Orange Peels; Overhead Cranes; Paving Mixers; Piledrivers; Pipe Wrapping and Painting Machines; Pushdozers, or Push Cats; Robotic Controlled Equipment in this Classification; Rock Crushers; Ross Carrier or Similar Machines; Rotomill; Scoops, Skimmer, two cu. yd. capacity and under; Scoops, All or Tournapull; Sheep-Foot Roller (SelfPropelled); Shovels; Skid Steer; Skimmer Scoops; Temporary Concrete Plant Operators; Test Hole Drilling Machines; Tower Machines; Tower Mixers; Track Type End Loaders; Track Type Fork Lifts or High Lifts; Track Jacks and Tampers; Tractors, Sideboom; Trenching or Ditching Machine; Tunnelluggers; Vermeer Type Saws; Water Blaster Cutting Head; Wheel Type End Loaders; Winch Cat.

CLASS 2. Air Compressors (six to eight)*; Asphalt Boosters and Heaters; Asphalt Distributors; Asphalt Plant Fireman; Oiler on Two Paving Mixers When Used in Tandem; Boom or Winch Trucks; Bull Floats or Flexplanes; Concrete Finishing Machine; Concrete Saws, Self-Propelled; Concrete Spreading Machines; Conveyors (six to eight)*; Generators (six to eight)*; Gravel or Stone Spreader, Power Operated; Hoist (with One Drum and One Load Line); Light Plants (six to eight)*; Mechanical Heaters (six to eight)*; Mud Jacks; Post Hole Digger, Mechanical; Pug Mills when used for other than Asphalt operation; Robotic Controlled Equipment in this Classification; Road or Street Sweeper, Self Propelled; Rollers (except bituminous concrete); Seaman Tiller; Straw Machine; Vibratory Compactor; Water

Blaster, Power Unit; Welding Machines (six to eight)*; Well Drill Machines.

CLASS 3. Air Compressors(one to five)*; Air Compressors, Track or Self-Propelled; Automatic Hoist; Building Elevators; Bulk Cement Batching Plants; Conveyors (one to five)*; Concrete Mixers (Except Plant, Paver, or Tower); Firemen; Generators (one to five)*; Greasers; Helper on Single Paving Mixer; Hoist, Automatic; Light Plants (one to five)*; Mechanic Helpers; Mechanical Heaters (one to five)*; Oilers; Power Form Graders; Power Sub-Graders; Robotic Controlled Equipment in this Classification; Scissors Hoist; Tractors without power attachments regardless of size or type; Truck Crane Oiler and Driver (1 man); Vibratory Hammer (power source); Water Pumps (one to five)*; Welding Machines (1/300 Amp. or over)*; Welding machines (one to five)*

CLASS 4. Lattice Boom Crawler Cranes; Lattice Boom Truck Cranes; Telescopic Truck-Mounted Cranes; Tower Cranes.

* Combinations of one to eight of any Air Compressors, Conveyors, Welding Machines, Water Pumps, Light Plants, or Generators shall be in batteries or within 400 feet and shall be paid as per the Classification Schedule contained in this Article.

OPERATING ENGINEERS - HIGHWAY

CLASS 1. Asphalt Screed Man; Asphco Concrete Spreaders; Asphalt Pavers; Asphalt Plant Engineer; Asphalt Rollers on Bituminous Concrete; Athey Loaders; Backhoes; Barber Green Loaders; Bulldozers; Cableways; Carry Deck Pickers; Cherry Pickers (Rough Terrain); C.M.I. & similar type-autograde formless paver, autograde placer & finisher; Concrete Breakers; Concrete Plant Operators; Concrete Pumps; Derricks; Derrick Boats; Dewatering Systems; Earth Auger or Boring Machines; Elevating Graders; Engineers on Dredges; Gravel Processing Machines; Grout Pump; Head Equipment Greaser; High Lifts or Fork Lifts; Hoists with two or more drums or two or more load lines; Hydro Jet or Hydro Laser; Locomotives, All; Mechanics; Motor Graders or Auto Patrols; Multi-Point Power Lifting Equipment; Operators or Leverman on Dredges; Operators, Power Boat; Operators, Pug Mill (Asphalt Plants); Overhead Cranes; Paving Mixers; Piledrivers; Pipe Wrapping and Painting Machines; Push-dozers, or Push Cats; Robotic Controlled Equipment in this Classification; Rock Crushers; Ross Carrier or Similar Machines; Roto-Mill; Scoops, Skimmer, two cu. yd. capacity and under; Sheep-Foot Roller (Self Pro-pelled); Shovels; Skid Steer; Skimmer Scoops; Test Hole Drilling Machines; Tower Machines; Tower Mixers; Track Type End Loaders; Track Type Fork Lifts or High Lifts; Track Jacks and Tampers; Tractors, Side-boom; Trenching or Ditching Machine; Tunnelluggers; Vermeer-Type Saws; Wheel Type End Loaders; Winch Cat; Scoops, All or Tournapull.

CLASS 2. Air Compressors (six to eight)*; Articulated Dumps; Asphalt Boosters and Heaters; Asphalt Distributors; Asphalt Plant Fireman; Boom or Winch Trucks; Building Elevators; Bull Floats or Flexplanes; Concrete Finishing Machine; Concrete Saws, Self-Propelled; Concrete Spreading Machines; Conveyors (six to eight)*; Generators (six to eight)*; Gravel or Stone Spreader, Power Operated; Hoist, Automatic; Hoist with One Drum and One Load Line; Light Plants (six to eight)*; Mechanical Heaters (six to eight)*; Mud Jacks; Off Road Water Wagons; Oiler on Two Paving Mixers When Used in Tandem; Post Hole Digger, Mechanical; Robotic Controlled Equipment in This Classification; Road or Street Sweeper, Self-Propelled; Rollers (except bituminous concrete); Scissor Hoist; Sea-man Tiller; Straw Machine; Vibratory Compactor; Water Pumps (six to eight)*; Well Drill Machines.

CLASS 3. Air Compressors (one to five)*; Air Compressors, Track or

Self-Propelled; Bulk Cement Batching Plants; Conveyors (one to five)*; Concrete Mixers (Except Plant, Paver, or Tower); Firemen; Generators (one to five)*; Greasers; Helper on Single Paving Mixer; Light Plants (one to five)*; Mechanic Helpers; Mechanical Heaters (one to five)*; Oilers; Power Form Graders; Power Sub-Graders; Pug Mills when used for other than Asphalt operation; Robotic Controlled Equipment in This Classification; Tractors without power attachments, regardless of size or type; Truck Crane Oiler and Driver (1 man); Vibratory Hammer (power source); Water Pumps (one to five)*; Welding Machines (one 300 Amp. or over)*; Welding Machines (one to five)*.

CLASS 4. Lattice Boom Crawler Crane; Lattice Boom Truck Crane; Telescopic Truck-Mounted Crane; Tower Crane.

*Combinations of one to eight of any Air Compressors, Conveyors, Welding Machines, Water Pumps, Light Plants or Generators shall be in batteries or within 400 feet and shall be paid as per the Classification Schedule contained in this Article.

OPERATING ENGINEER - OIL AND CHIP RESEALING ONLY.

This shall encompass the operation of all motorized heavy equipment used in oil and chip resealing, including but not limited to operating self-propelled chip spreaders, and all types of rollers (both hard and rubber tired); and other duties pertaining to the operation or maintenance of heavy equipment related to oil & chip resealing.

Other Classifications of Work:

For definitions of classifications not otherwise set out, the Department generally has on file such definitions which are available. If a task to be performed is not subject to one of the classifications of pay set out, the Department will upon being contacted state which neighboring county has such a classification and provide such rate, such rate being deemed to exist by reference in this document. If no neighboring county rate applies to the task, the Department shall undertake a special determination, such special determination being then deemed to have existed under this determination. If a project requires these, or any classification not listed, please contact IDOL at 217-782-1710 for wage rates or clarifications.

LANDSCAPING

Landscaping work falls under the existing classifications for laborer, operating engineer and truck driver. The work performed by landscape plantsman and landscape laborer is covered by the existing classification of laborer. The work performed by landscape operators (regardless of equipment used or its size) is covered by the classifications of operating engineer. The work performed by landscape truck drivers (regardless of size of truck driven) is covered by the classifications of truck driver.

Douglas County Prevailing Wage for May 2013

(See explanation of column headings at bottom of wages)

Trade Name	RG	TYP	C	Base	FRMAN	M-F>8	OSA	OSH	H/W	Pensn	Vac	Trng
ASBESTOS ABT-GEN		BLD		29.710	30.960	1.5	1.5	2.0	5.750	9.920	0.000	0.900
ASBESTOS ABT-MEC		BLD		20.450	21.450	1.5	1.5	2.0	6.250	5.000	0.000	0.000

BOILERMAKER		BLD	31.500	34.000	1.5	1.5	2.0	7.070	18.73	1.000	0.350
BRICK MASON		BLD	30.670	32.170	1.5	1.5	2.0	6.600	10.03	0.000	0.630
CARPENTER		BLD	29.600	31.850	1.5	1.5	2.0	7.450	12.65	0.000	0.520
CARPENTER		HWY	29.950	31.700	1.5	1.5	2.0	7.450	12.65	0.000	0.520
CEMENT MASON		BLD	29.800	31.300	1.5	1.5	2.0	6.600	8.360	0.000	0.500
CEMENT MASON		HWY	30.390	31.890	1.5	1.5	2.0	6.600	8.560	0.000	0.500
CERAMIC TILE FNSHER		BLD	28.400	0.000	1.5	1.5	2.0	6.600	7.930	0.000	0.000
ELECTRIC PWR EQMT OP		ALL	35.440	0.000	1.5	1.5	2.0	5.000	10.98	0.000	0.270
ELECTRIC PWR GRNDMAN		ALL	24.320	0.000	1.5	1.5	2.0	5.000	7.540	0.000	0.180
ELECTRIC PWR LINEMAN		ALL	39.370	41.910	1.5	1.5	2.0	5.000	12.20	0.000	0.300
ELECTRIC PWR TRK DRV		ALL	25.510	0.000	1.5	1.5	2.0	5.000	7.920	0.000	0.190
ELECTRICIAN	N	BLD	37.090	39.090	1.5	1.5	2.0	5.350	7.760	0.000	0.560
ELECTRICIAN	S	BLD	34.200	37.620	1.5	1.5	2.0	5.350	7.610	0.000	0.510
ELECTRONIC SYS TECH		BLD	31.130	32.880	1.5	1.5	2.0	5.350	6.110	0.000	0.400
ELEVATOR CONSTRUCTOR		BLD	40.520	45.585	2.0	2.0	2.0	11.88	12.71	3.240	0.600
FENCE ERECTOR		ALL	30.610	32.510	1.5	1.5	2.0	8.840	8.420	0.000	0.900
GLAZIER		BLD	30.780	32.780	1.5	2.0	2.0	6.630	8.150	0.000	0.380
HT/FROST INSULATOR		BLD	31.230	32.230	1.5	1.5	2.0	5.790	8.960	2.000	0.250
IRON WORKER		ALL	30.610	32.510	1.5	1.5	2.0	8.840	8.420	0.000	0.900
LABORER		BLD	27.710	28.960	1.5	1.5	2.0	5.750	9.920	0.000	0.800
LABORER		HWY	29.120	30.120	1.5	1.5	2.0	5.750	9.920	0.000	0.800
LATHER		BLD	29.600	31.850	1.5	1.5	2.0	7.450	12.65	0.000	0.520
LATHER	N	BLD	27.790	29.790	1.5	1.5	2.0	6.750	6.160	0.000	0.320
LATHER	S	BLD	27.150	29.150	1.5	1.5	2.0	6.750	6.800	0.000	0.320
MACHINIST		BLD	43.550	46.050	1.5	1.5	2.0	6.130	8.950	1.850	0.000
MARBLE FINISHERS		BLD	28.400	0.000	1.5	1.5	2.0	6.600	7.930	0.000	0.000
MARBLE MASON		BLD	29.900	0.000	1.5	1.5	2.0	6.600	7.930	0.000	0.000
MILLWRIGHT		BLD	29.620	31.870	1.5	1.5	2.0	7.450	13.09	0.000	0.520
MILLWRIGHT		HWY	31.400	33.150	1.5	1.5	2.0	7.450	13.54	0.000	0.520
OPERATING ENGINEER	1	ALL	36.950	0.000	1.5	1.5	2.0	7.250	8.700	0.000	0.800
OPERATING ENGINEER	2	ALL	23.900	0.000	1.5	1.5	2.0	7.250	8.700	0.000	0.800
PAINTER		ALL	33.560	35.060	1.5	1.5	2.0	6.600	4.420	0.000	0.570
PAINTER SIGNS		ALL	33.560	35.060	1.5	1.5	2.0	6.600	4.420	0.000	0.570
PILEDRIVER		BLD	30.100	32.350	1.5	1.5	2.0	7.450	12.65	0.000	0.520
PILEDRIVER		HWY	30.950	32.700	1.5	1.5	2.0	7.450	12.65	0.000	0.520
PILEDRIVER	N	BLD	28.290	30.290	1.5	1.5	2.0	6.750	6.160	0.000	0.320
PILEDRIVER	S	BLD	27.650	29.650	1.5	1.5	2.0	6.750	6.800	0.000	0.320
PIPEFITTER		ALL	35.820	38.510	1.5	1.5	2.0	6.100	6.630	0.000	0.610
PLASTERER		BLD	30.000	32.000	1.5	1.5	2.0	6.600	10.17	0.000	0.500
PLUMBER		ALL	35.820	38.510	1.5	1.5	2.0	6.100	6.630	0.000	0.610
ROOFER		BLD	28.750	30.250	1.5	1.5	2.0	9.150	8.400	0.000	0.200
SHEETMETAL WORKER		BLD	33.640	35.640	1.5	1.5	2.0	8.300	12.00	0.000	0.520
SPRINKLER FITTER		BLD	36.390	39.140	1.5	1.5	2.0	8.420	8.500	0.000	0.450
STONE MASON		BLD	30.670	32.170	1.5	1.5	2.0	6.600	10.03	0.000	0.630
TERRAZZO FINISHER		BLD	28.400	0.000	1.5	1.5	2.0	6.600	7.930	0.000	0.000
TERRAZZO MASON		BLD	29.900	0.000	1.5	1.5	2.0	6.600	7.930	0.000	0.000
TILE LAYER		BLD	29.600	31.850	1.5	1.5	2.0	7.450	12.65	0.000	0.520
TILE MASON		BLD	29.900	0.000	1.5	1.5	2.0	6.600	7.930	0.000	0.000
TRUCK DRIVER	1	ALL	31.230	0.000	1.5	1.5	2.0	10.30	4.840	0.000	0.250
TRUCK DRIVER	2	ALL	31.680	0.000	1.5	1.5	2.0	10.30	4.840	0.000	0.250
TRUCK DRIVER	3	ALL	31.890	0.000	1.5	1.5	2.0	10.30	4.840	0.000	0.250
TRUCK DRIVER	4	ALL	32.180	0.000	1.5	1.5	2.0	10.30	4.840	0.000	0.250
TRUCK DRIVER	5	ALL	33.020	0.000	1.5	1.5	2.0	10.30	4.840	0.000	0.250
TRUCK DRIVER	O&C 1	ALL	24.980	0.000	1.5	1.5	2.0	10.30	4.840	0.000	0.250
TRUCK DRIVER	O&C 2	ALL	25.340	0.000	1.5	1.5	2.0	10.30	4.840	0.000	0.250
TRUCK DRIVER	O&C 3	ALL	25.510	0.000	1.5	1.5	2.0	10.30	4.840	0.000	0.250
TRUCK DRIVER	O&C 4	ALL	25.740	0.000	1.5	1.5	2.0	10.30	4.840	0.000	0.250
TRUCK DRIVER	O&C 5	ALL	26.420	0.000	1.5	1.5	2.0	10.30	4.840	0.000	0.250
TUCKPOINTER		BLD	30.670	32.170	1.5	1.5	2.0	6.600	10.03	0.000	0.630

Legend :

RG (Region)

TYP (Trade Type - All,Highway,Building,Floating,Oil & Chip,Rivers)

C (Class)

Base (Base Wage Rate)

FRMAN (Foreman Rate)

M-F>8 (OT required for any hour greater than 8 worked each day, Mon through Fri.)

OSA (Overtime (OT) is required for every hour worked on Saturday)

OSH (Overtime is required for every hour worked on Sunday and Holidays)

H/W (Health & Welfare Insurance)

Pensn (Pension)

Vac (Vacation)

Trng (Training)

Explanations

DOUGLAS COUNTY

CARPENTERS (SOUTH) - That part of the county South of Rt. 36 (Includes LATHERS & PILEDRIEVERS).

ELECTRICIAN (NORTH) - Townships of Newman, Murdock, Camargo, and East of the central tracks including all of the Town of Tuscola.

The following list is considered as those days for which holiday rates of wages for work performed apply: New Years Day, Memorial Day, Fourth of July, Labor Day, Thanksgiving Day, Christmas Day and Veterans Day in some classifications/counties. Generally, any of these holidays which fall on a Sunday is celebrated on the following Monday. This then makes work performed on that Monday payable at the appropriate overtime rate for holiday pay. Common practice in a given local may alter certain days of celebration. If in doubt, please check with IDOL.

Oil and chip resealing (O&C) means the application of road oils and liquid asphalt to coat an existing road surface, followed by application of aggregate chips or gravel to coated surface, and subsequent rolling of material to seal the surface.

EXPLANATION OF CLASSES

ASBESTOS - GENERAL - removal of asbestos material/mold and hazardous materials from any place in a building, including mechanical systems where those mechanical systems are to be removed. This includes the removal of asbestos materials/mold and hazardous materials from ductwork or pipes in a building when the building is to be demolished at the time or at some close future date.

ASBESTOS - MECHANICAL - removal of asbestos material from mechanical systems, such as pipes, ducts, and boilers, where the mechanical systems are to remain.

CERAMIC TILE FINISHER, MARBLE FINISHER, TERRAZZO FINISHER

Assisting, helping or supporting the tile, marble and terrazzo mechanic by performing their historic and traditional work assignments required to complete the proper installation of the work covered by said crafts. The term "Ceramic" is used for naming the classification only and is in no way a limitation of the product handled. Ceramic takes into consideration most hard tiles.

ELECTRONIC SYSTEMS TECHNICIAN

Installation, service and maintenance of low-voltage systems which utilizes the transmission and/or transference of voice, sound, vision, or digital for commercial, education, security and entertainment purposes for the following: TV monitoring and surveillance, background/foreground music, intercom and telephone interconnect, field programming, inventory control systems, microwave transmission, multi-media, multiplex, radio page, school, intercom and sound burglar alarms and low voltage master clock systems.

Excluded from this classification are energy management systems, life safety systems, supervisory controls and data acquisition systems not intrinsic with the above listed systems, fire alarm systems, nurse call systems and raceways exceeding fifteen feet in length.

TRUCK DRIVER - BUILDING, HEAVY AND HIGHWAY CONSTRUCTION

Class 1. Drivers on 2 axle trucks hauling less than 9 ton. Air compressor and welding machines and brooms, including those pulled by separate units, truck driver helpers, warehouse employees, mechanic helpers, greasers and tiremen, pickup trucks when hauling materials, tools, or workers to and from and on-the-job site, and fork lifts up to 6,000 lb. capacity.

Class 2. Two or three axle trucks hauling more than 9 ton but hauling less than 16 ton. A-frame winch trucks, hydrolift trucks, vactor trucks or similar equipment when used for transportation purposes. Fork lifts over 6,000 lb. capacity, winch trucks, four axle combination units, and ticket writers.

Class 3. Two, three or four axle trucks hauling 16 ton or more. Drivers on water pulls, articulated dump trucks, mechanics and working forepersons, and dispatchers. Five axle or more combination units.

Class 4. Low Boy and Oil Distributors.

Class 5. Drivers who require special protective clothing while employed on hazardous waste work.

TRUCK DRIVER - OIL AND CHIP RESEALING ONLY.

This shall encompass laborers, workers and mechanics who drive contractor or subcontractor owned, leased, or hired pickup, dump, service, or oil distributor trucks. The work includes transporting materials and equipment (including but not limited to, oils, aggregate supplies, parts, machinery and tools) to or from the job site; distributing oil or liquid asphalt and aggregate; stock piling material when in connection with the actual oil and chip contract. The Truck Driver (Oil & Chip Resealing) wage classification does not include supplier delivered materials.

OPERATING ENGINEERS - BUILDING, HEAVY AND HIGHWAY CONSTRUCTION

Class 1. Power Cranes, Draglines, Derricks, Shovels, Gradalls, Mechanics, Tractor Highlift, Tournadozer, Concrete Mixers with Skip, Tournamixer, Two Drum Machine, One Drum Hoist with Tower or Boom,

Cableways, Tower Machines, Motor Patrol, Boom Tractor, Boom or Winch Truck, Winch or Hydraulic Boom Truck, Truck Crane, Tournapull, Tractor Operating Scoops, Bulldozer, Push Tractor, Asphalt Planer, Finishing Machine on Asphalt, Large Rollers on Earth, Rollers on Asphalt Mix, Ross Carrier or similar Machine, Gravel Processing Machine, Asphalt Plant Engineer, Paver Operator, Dredging Equipment, or Dredge Engineer, or Dredge Operator, Central Mix Plant Engineer, CMI or similar type machine, Concrete Pump, Truck or Skid Mounted, Tower Crane, Engineer or Rock Crusher Plant, Concrete Plant Engineer, Ditching Machine with dual attachment, Tractor Mounted Loaders, Cherry Picker, Hydro Crane, Standard or Dinkey Locomotives, Scoopmobiles, Euclid Loader, Soil Cement Machine, Back Filler, Elevating Machine, Power Blade, Drilling Machine, including Well Testing, Caissons, Shaft or any similar type drilling machines, Motor Driven Paint Machine, Pipe Cleaning Machine, Pipe Wrapping Machine, Pipe Bending Machine, Apsco Paver, Boring Machine, (Head Equipment Greaser), Barber-Greene Loaders, Formless Paver, (Well Point System), Concrete Spreader, Hydra Ax, Span Saw, Marine Scoops, Brush Mulcher, Brush Burner, Mesh Placer, Tree Mover, Helicopter Crew (3), Piledriver-Skid or Crawler, Stump Remover, Root Rake, Tug Boat Operator, Refrigerating Machine, Freezing Operator, Chair Cart-Self-Propelled, Hydra Seeder, Straw Blower, Power Sub Grader, Bull Float, Finishing Machine, Self-Propelled Pavement Breaker, Lull (or similar type Machine), Two Air Compressors, Compressors hooked in Manifold, Overhead Crane, Chip Spreader, Mud Cat, Sull-Air, Fork Lifts (except when used for landscaping work), Soil Stabilizer (Seaman Tiller, Bo Mag, Rago Gator, and similar types of equipment), Tube Float, Spray Machine, Curing Machine, Concrete or Asphalt Milling Machine, Snooper Truck-Operator, Backhoe, Farm Tractors (with attachments), 4 Point Lift System (Power Lift or similar type), Skid-Steer (Bob Cat or similar type), Wrecking Shears, Water Blaster.

Class 2. Concrete Mixers without Skips, Rock Crusher, Ditching Machine under 6', Curbing Machine, One Drum Machines without Tower or Boom, Air Tugger, Self-Propelled Concrete Saw, Machine Mounted Post Hole Digger, two to four Generators, Water Pumps or Welding Machines, within 400 feet, Air Compressor 600 cu. ft. and under, Rollers on Aggregate and Seal Coat Surfaces, Fork Lift (when used for landscaping work), Concrete and Blacktop Curb Machine, One Water Pump, Oilers, Air Valves or Steam Valves, One Welding Machine, Truck Jack, Mud Jack, Gunnite Machine, House Elevators when used for hoisting material, Engine Tenders, Fireman, Wagon Drill, Flex Plane, Conveyor, Siphons and Pulsometer, Switchman, Fireman on Paint Pots, Fireman on Asphalt Plants, Distributor Operator on Trucks, Tampers, Self-Propelled Power Broom, Striping Machine (motor driven), Form Tamper, Bulk Cement Plant, Equipment Greaser, Deck Hands, Truck Crane Oiler-Driver, Cement Blimps, Form Grader, Temporary Heat, Throttle Valve, Super Sucker (and similar type of equipment).

Other Classifications of Work:

For definitions of classifications not otherwise set out, the Department generally has on file such definitions which are available. If a task to be performed is not subject to one of the classifications of pay set out, the Department will upon being contacted state which neighboring county has such a classification and provide such rate, such rate being deemed to exist by reference in this document. If no neighboring county rate applies to the task, the Department shall undertake a special determination, such special determination being then deemed to have existed under this determination. If a project requires these, or any classification not listed, please contact IDOL at 217-782-1710 for wage rates or clarifications.

LANDSCAPING

Landscaping work falls under the existing classifications for laborer, operating engineer and truck driver. The work performed by landscape plantsman and landscape laborer is covered by the existing classification of laborer. The work performed by landscape operators (regardless of equipment used or its size) is covered by the classifications of operating engineer. The work performed by landscape truck drivers (regardless of size of truck driven) is covered by the classifications of truck driver.

Du Page County Prevailing Wage for May 2013

(See explanation of column headings at bottom of wages)

Trade Name	RG	TYP	C	Base	FRMAN	M-F>8	OSA	OSH	H/W	Pensn	Vac	Trng
=====	==	===	=	=====	=====	=====	===	===	=====	=====	=====	=====
ASBESTOS ABT-GEN		ALL		36.200	36.700	1.5	1.5	2.0	12.78	9.020	0.000	0.500
ASBESTOS ABT-MEC		BLD		34.160	36.660	1.5	1.5	2.0	10.82	10.66	0.000	0.720
BOILERMAKER		BLD		43.450	47.360	2.0	2.0	2.0	6.970	14.66	0.000	0.350
BRICK MASON		BLD		40.680	44.750	1.5	1.5	2.0	9.550	12.00	0.000	0.970
CARPENTER		ALL		41.520	43.520	1.5	1.5	2.0	13.19	11.75	0.000	0.530
CEMENT MASON		ALL		38.000	40.000	2.0	1.5	2.0	8.950	16.35	0.000	0.380
CERAMIC TILE FNSHER		BLD		34.440	0.000	2.0	1.5	2.0	9.700	6.930	0.000	0.610
COMMUNICATION TECH		BLD		32.650	34.750	1.5	1.5	2.0	9.250	14.46	0.400	0.610
ELECTRIC PWR EQMT OP		ALL		36.610	49.750	1.5	1.5	2.0	5.000	11.35	0.000	0.270
ELECTRIC PWR GRNDMAN		ALL		28.310	49.750	1.5	1.5	2.0	5.000	8.780	0.000	0.210
ELECTRIC PWR LINEMAN		ALL		43.830	49.750	1.5	1.5	2.0	5.000	13.58	0.000	0.330
ELECTRIC PWR TRK DRV		ALL		29.310	49.750	1.5	1.5	2.0	5.000	9.090	0.000	0.220
ELECTRICIAN		BLD		36.200	39.820	1.5	1.5	2.0	9.250	16.27	4.380	0.680
ELEVATOR CONSTRUCTOR		BLD		49.080	55.215	2.0	2.0	2.0	11.88	12.71	3.930	0.600
FENCE ERECTOR	NE	ALL		33.740	35.740	1.5	1.5	2.0	12.61	10.18	0.000	0.250
FENCE ERECTOR	W	ALL		44.950	47.200	2.0	2.0	2.0	8.890	17.69	0.000	0.400
GLAZIER		BLD		39.500	41.000	1.5	2.0	2.0	11.99	14.30	0.000	0.840
HT/FROST INSULATOR		BLD		45.550	48.050	1.5	1.5	2.0	10.82	11.86	0.000	0.720
IRON WORKER	E	ALL		40.750	42.750	2.0	2.0	2.0	13.20	19.09	0.000	0.350
IRON WORKER	W	ALL		44.950	47.200	2.0	2.0	2.0	8.890	17.69	0.000	0.400
LABORER		ALL		36.200	36.950	1.5	1.5	2.0	12.78	9.020	0.000	0.500
LATHER		ALL		41.520	43.520	1.5	1.5	2.0	13.19	11.75	0.000	0.530
MACHINIST		BLD		43.550	46.050	1.5	1.5	2.0	6.130	8.950	1.850	0.000
MARBLE FINISHERS		ALL		29.700	0.000	1.5	1.5	2.0	9.550	11.75	0.000	0.620
MARBLE MASON		BLD		39.880	43.870	1.5	1.5	2.0	9.550	11.75	0.000	0.730
MATERIAL TESTER I		ALL		26.200	0.000	1.5	1.5	2.0	12.78	9.020	0.000	0.500
MATERIALS TESTER II		ALL		31.200	0.000	1.5	1.5	2.0	12.78	9.020	0.000	0.500
MILLWRIGHT		ALL		41.520	43.520	1.5	1.5	2.0	13.19	11.75	0.000	0.530
OPERATING ENGINEER		BLD	1	45.100	49.100	2.0	2.0	2.0	15.70	10.55	1.900	1.250
OPERATING ENGINEER		BLD	2	43.800	49.100	2.0	2.0	2.0	15.70	10.55	1.900	1.250
OPERATING ENGINEER		BLD	3	41.250	49.100	2.0	2.0	2.0	15.70	10.55	1.900	1.250
OPERATING ENGINEER		BLD	4	39.500	49.100	2.0	2.0	2.0	15.70	10.55	1.900	1.250
OPERATING ENGINEER		BLD	5	48.850	49.100	2.0	2.0	2.0	15.70	10.55	1.900	1.250
OPERATING ENGINEER		BLD	6	46.100	49.100	2.0	2.0	2.0	15.70	10.55	1.900	1.250
OPERATING ENGINEER		BLD	7	48.100	49.100	2.0	2.0	2.0	15.70	10.55	1.900	1.250
OPERATING ENGINEER		HWY	1	43.300	47.300	1.5	1.5	2.0	15.70	10.55	1.900	1.250
OPERATING ENGINEER		HWY	2	42.750	47.300	1.5	1.5	2.0	15.70	10.55	1.900	1.250
OPERATING ENGINEER		HWY	3	40.700	47.300	1.5	1.5	2.0	15.70	10.55	1.900	1.250
OPERATING ENGINEER		HWY	4	39.300	47.300	1.5	1.5	2.0	15.70	10.55	1.900	1.250
OPERATING ENGINEER		HWY	5	38.100	47.300	1.5	1.5	2.0	15.70	10.55	1.900	1.250
OPERATING ENGINEER		HWY	6	46.300	47.300	1.5	1.5	2.0	15.70	10.55	1.900	1.250
OPERATING ENGINEER		HWY	7	44.300	47.300	1.5	1.5	2.0	15.70	10.55	1.900	1.250
ORNAMNTL IRON WORKER E		ALL		41.800	44.300	2.0	2.0	2.0	12.86	15.81	0.000	0.550
ORNAMNTL IRON WORKER W		ALL		44.950	47.200	2.0	2.0	2.0	8.890	17.69	0.000	0.400
PAINTER		ALL		40.880	42.880	1.5	1.5	1.5	9.650	8.200	0.000	1.250
PAINTER SIGNS		BLD		33.920	38.090	1.5	1.5	1.5	2.600	2.710	0.000	0.000
PILEDRIIVER		ALL		41.520	43.520	1.5	1.5	2.0	13.19	11.75	0.000	0.530
PIPEFITTER		BLD		41.200	43.200	1.5	1.5	2.0	9.750	16.34	0.000	1.710

PLASTERER		BLD	40.080	42.480	1.5	1.5	2.0	9.550	12.30	0.000	0.990
PLUMBER		BLD	41.200	43.200	1.5	1.5	2.0	9.750	16.34	0.000	1.710
ROOFER		BLD	38.350	41.350	1.5	1.5	2.0	8.280	8.770	0.000	0.430
SHEETMETAL WORKER		BLD	42.510	44.510	1.5	1.5	2.0	10.04	12.01	0.000	0.780
SPRINKLER FITTER		BLD	49.200	51.200	1.5	1.5	2.0	10.25	8.350	0.000	0.450
STEEL ERECTOR	E	ALL	40.750	42.750	2.0	2.0	2.0	13.20	19.09	0.000	0.350
STEEL ERECTOR	W	ALL	44.950	47.200	2.0	2.0	2.0	8.890	17.69	0.000	0.400
STONE MASON		BLD	40.680	44.750	1.5	1.5	2.0	9.550	12.00	0.000	0.970
TERRAZZO FINISHER		BLD	35.510	0.000	1.5	1.5	2.0	9.700	9.320	0.000	0.400
TERRAZZO MASON		BLD	39.370	42.370	1.5	1.5	2.0	9.700	10.66	0.000	0.550
TILE MASON		BLD	41.430	45.430	2.0	1.5	2.0	9.700	8.640	0.000	0.710
TRAFFIC SAFETY WRKR		HWY	28.250	29.850	1.5	1.5	2.0	4.896	4.175	0.000	0.000
TRUCK DRIVER		ALL 1	32.550	33.100	1.5	1.5	2.0	6.500	4.350	0.000	0.150
TRUCK DRIVER		ALL 2	32.700	33.100	1.5	1.5	2.0	6.500	4.350	0.000	0.150
TRUCK DRIVER		ALL 3	32.900	33.100	1.5	1.5	2.0	6.500	4.350	0.000	0.150
TRUCK DRIVER		ALL 4	33.100	33.100	1.5	1.5	2.0	6.500	4.350	0.000	0.150
TUCKPOINTER		BLD	40.950	41.950	1.5	1.5	2.0	8.180	10.82	0.000	0.940

Legend:

RG (Region)

TYP (Trade Type - All,Highway,Building,Floating,Oil & Chip,Rivers)

C (Class)

Base (Base Wage Rate)

FRMAN (Foreman Rate)

M-F>8 (OT required for any hour greater than 8 worked each day, Mon through Fri.

OSA (Overtime (OT) is required for every hour worked on Saturday)

OSH (Overtime is required for every hour worked on Sunday and Holidays)

H/W (Health & Welfare Insurance)

Pensn (Pension)

Vac (Vacation)

Trng (Training)

Explanations

DUPAGE COUNTY

IRON WORKERS AND FENCE ERECTOR (WEST) - West of Route 53.

The following list is considered as those days for which holiday rates of wages for work performed apply: New Years Day, Memorial Day, Fourth of July, Labor Day, Thanksgiving Day, Christmas Day and Veterans Day in some classifications/counties. Generally, any of these holidays which fall on a Sunday is celebrated on the following Monday. This then makes work performed on that Monday payable at the appropriate overtime rate for holiday pay. Common practice in a given local may alter certain days of celebration. If in doubt, please check with IDOL.

EXPLANATION OF CLASSES

ASBESTOS - GENERAL - removal of asbestos material/mold and hazardous materials from any place in a building, including mechanical systems where those mechanical systems are to be removed. This includes the removal of asbestos materials/mold and hazardous materials from ductwork or pipes in a building when the building is to be demolished at the time or at some close future date.

ASBESTOS - MECHANICAL - removal of asbestos material from mechanical systems, such as pipes, ducts, and boilers, where the mechanical systems are to remain.

TRAFFIC SAFETY - work associated with barricades, horses and drums used to reduce lane usage on highway work, the installation and removal of temporary lane markings, and the installation and removal of temporary road signs.

CERAMIC TILE FINISHER

The grouting, cleaning, and polishing of all classes of tile, whether for interior or exterior purposes, all burned, glazed or unglazed products; all composition materials, granite tiles, warning detectable tiles, cement tiles, epoxy composite materials, pavers, glass, mosaics, fiberglass, and all substitute materials, for tile made in tile-like units; all mixtures in tile like form of cement, metals, and other materials that are for and intended for use as a finished floor surface, stair treads, promenade roofs, walks, walls, ceilings, swimming pools, and all other places where tile is to form a finished interior or exterior. The mixing of all setting mortars including but not limited to thin-set mortars, epoxies, wall mud, and any other sand and cement mixtures or adhesives when used in the preparation, installation, repair, or maintenance of tile and/or similar materials. The handling and unloading of all sand, cement, lime, tile, fixtures, equipment, adhesives, or any other materials to be used in the preparation, installation, repair, or maintenance of tile and/or similar materials. Ceramic Tile Finishers shall fill all joints and voids regardless of method on all tile work, particularly and especially after installation of said tile work. Application of any and all protective coverings to all types of tile installations including, but not be limited to, all soap compounds, paper products, tapes, and all polyethylene coverings, plywood, masonite, cardboard, and any new type of products that may be used to protect tile installations, Blastrac equipment, and all floor scarifying equipment used in preparing floors to receive tile. The clean up and removal of all waste and materials. All demolition of existing tile floors and walls to be re-tiled.

COMMUNICATIONS TECHNICIAN

Low voltage installation, maintenance and removal of telecommunication facilities (voice, sound, data and video) including telephone and data inside wire, interconnect, terminal equipment, central offices, PABX, fiber optic cable and equipment, micro waves, V-SAT, bypass, CATV, WAN (wide area networks), LAN (local area networks), and ISDN (integrated system digital network), pulling of wire in raceways, but not the installation of raceways.

MARBLE FINISHER

Loading and unloading trucks, distribution of all materials (all stone, sand, etc.), stocking of floors with material, performing all rigging for heavy work, the handling of all material that may be needed for the installation of such materials, building of scaffolding, polishing if needed, patching, waxing of material if damaged, pointing up, caulking, grouting and cleaning of marble,

holding water on diamond or Carborundum blade or saw for setters cutting, use of tub saw or any other saw needed for preparation of material, drilling of holes for wires that anchor material set by setters, mixing up of molding plaster for installation of material, mixing up thin set for the installation of material, mixing up of sand to cement for the installation of material and such other work as may be required in helping a Marble Setter in the handling of all material in the erection or installation of interior marble, slate, travertine, art marble, serpentine, alberene stone, blue stone, granite and other stones (meaning as to stone any foreign or domestic materials as are specified and used in building interiors and exteriors and customarily known as stone in the trade), carrara, sanionyx, vitrolite and similar opaque glass and the laying of all marble tile, terrazzo tile, slate tile and precast tile, steps, risers treads, base, or any other materials that may be used as substitutes for any of the aforementioned materials and which are used on interior and exterior which are installed in a similar manner.

MATERIAL TESTER I: Hand coring and drilling for testing of materials; field inspection of uncured concrete and asphalt.

MATERIAL TESTER II: Field inspection of welds, structural steel, fireproofing, masonry, soil, facade, reinforcing steel, formwork, cured concrete, and concrete and asphalt batch plants; adjusting proportions of bituminous mixtures.

OPERATING ENGINEER - BUILDING

Class 1. Asphalt Plant; Asphalt Spreader; Autograde; Backhoes with Caisson Attachment; Batch Plant; Benoto (requires Two Engineers); Boiler and Throttle Valve; Caisson Rigs; Central Redi-Mix Plant; Combination Back Hoe Front End-loader Machine; Compressor and Throttle Valve; Concrete Breaker (Truck Mounted); Concrete Conveyor; Concrete Conveyor (Truck Mounted); Concrete Paver Over 27E cu. ft; Concrete Paver 27E cu. ft. and Under; Concrete Placer; Concrete Placing Boom; Concrete Pump (Truck Mounted); Concrete Tower; Cranes, All; Cranes, Hammerhead; Cranes, (GCI and similar Type); Creter Crane; Spider Crane; Crusher, Stone, etc.; Derricks, All; Derricks, Traveling; Formless Curb and Gutter Machine; Grader, Elevating; Grouting Machines; Heavy Duty Self-Propelled Transporter or Prime Mover; Highlift Shovels or Front Endloader 2-1/4 yd. and over; Hoists, Elevators, outside type rack and pinion and similar machines; Hoists, One, Two and Three Drum; Hoists, Two Tugger One Floor; Hydraulic Backhoes; Hydraulic Boom Trucks; Hydro Vac (and similar equipment); Locomotives, All; Motor Patrol; Lubrication Technician; Manipulators; Pile Drivers and Skid Rig; Post Hole Digger; Pre-Stress Machine; Pump Cretes Dual Ram; Pump Cretes; Squeeze Cretes-Screw Type Pumps; Gypsum Bulker and Pump; Raised and Blind Hole Drill; Roto Mill Grinder; Scoops - Tractor Drawn; Slip-Form Paver; Straddle Buggies; Operation of Tie Back Machine; Tournapull; Tractor with Boom and Side Boom; Trenching Machines.

Class 2. Boilers; Broom, All Power Propelled; Bulldozers; Concrete Mixer (Two Bag and Over); Conveyor, Portable; Forklift Trucks; Highlift Shovels or Front Endloaders under 2-1/4 yd.; Hoists, Automatic; Hoists, Inside Elevators; Hoists, Sewer Dragging Machine; Hoists, Tugger Single Drum; Laser Screed; Rock Drill (Self-Propelled); Rock Drill (Truck Mounted); Rollers, All; Steam Generators; Tractors, All; Tractor Drawn Vibratory Roller; Winch Trucks with "A" Frame.

Class 3. Air Compressor; Combination Small Equipment Operator; Generators; Heaters, Mechanical; Hoists, Inside Elevators (remodeling or renovation work); Hydraulic Power Units (Pile Driving, Extracting, and Drilling); Pumps, over 3" (1 to 3 not to exceed a total of 300 ft.); Low Boys; Pumps, Well Points; Welding Machines (2 through 5);

Winches, 4 Small Electric Drill Winches.

Class 4. Bobcats and/or other Skid Steer Loaders; Oilers; and Brick Forklift.

Class 5. Assistant Craft Foreman.

Class 6. Gradall.

Class 7. Mechanics; Welders.

OPERATING ENGINEERS - HIGHWAY CONSTRUCTION

Class 1. Asphalt Plant; Asphalt Heater and Planer Combination; Asphalt Heater Scarfire; Asphalt Spreader; Autograder/GOMACO or other similar type machines: ABG Paver; Backhoes with Caisson Attachment; Ballast Regulator; Belt Loader; Caisson Rigs; Car Dumper; Central Redi-Mix Plant; Combination Backhoe Front Endloader Machine, (1 cu. yd. Backhoe Bucket or over or with attachments); Concrete Breaker (Truck Mounted); Concrete Conveyor; Concrete Paver over 27E cu. ft.; Concrete Placer; Concrete Tube Float; Cranes, all attachments; Cranes, Tower Cranes of all types: Creter Crane; Spider Crane; Crusher, Stone, etc.; Derricks, All; Derrick Boats; Derricks, Traveling; Dredges; Elevators, Outside type Rack & Pinion and Similar Machines; Formless Curb and Gutter Machine; Grader, Elevating; Grader, Motor Grader, Motor Patrol, Auto Patrol, Form Grader, Pull Grader, Subgrader; Guard Rail Post Driver Truck Mounted; Hoists, One, Two and Three Drum; Heavy Duty Self-Propelled Transporter or Prime Mover; Hydraulic Backhoes; Backhoes with shear attachments up to 40' of boom reach; Lubrication Technician; Manipulators; Mucking Machine; Pile Drivers and Skid Rig; Pre-Stress Machine; Pump Cretes Dual Ram; Rock Drill - Crawler or Skid Rig; Rock Drill - Truck Mounted; Rock/Track Tamper; Roto Mill Grinder; Slip-Form Paver; Snow Melters; Soil Test Drill Rig (Truck Mounted); Straddle Buggies; Hydraulic Telescoping Form (Tunnel); Operation of Tieback Machine; Tractor Drawn Belt Loader; Tractor Drawn Belt Loader (with attached pusher - two engineers); Tractor with Boom; Tractaire with Attachments; Traffic Barrier Transfer Machine; Trenching; Truck Mounted Concrete Pump with Boom; Raised or Blind Hole Drills (Tunnel Shaft); Underground Boring and/or Mining Machines 5 ft. in diameter and over tunnel, etc; Underground Boring and/or Mining Machines under 5 ft. in diameter; Wheel Excavator; Widener (APSCO).

Class 2. Batch Plant; Bituminous Mixer; Boiler and Throttle Valve; Bulldozers; Car Loader Trailing Conveyors; Combination Backhoe Front Endloader Machine (Less than 1 cu. yd. Backhoe Bucket or over or with attachments); Compressor and Throttle Valve; Compressor, Common Receiver (3); Concrete Breaker or Hydro Hammer; Concrete Grinding Machine; Concrete Mixer or Paver 7S Series to and including 27 cu. ft.; Concrete Spreader; Concrete Curing Machine, Burlap Machine, Belting Machine and Sealing Machine; Concrete Wheel Saw; Conveyor Muck Cars (Haglund or Similar Type); Drills, All; Finishing Machine - Concrete; Highlift Shovels or Front Endloader; Hoist - Sewer Dragging Machine; Hydraulic Boom Trucks (All Attachments); Hydro-Blaster; Hydro Excavating (excluding hose work); Laser Screed; All Locomotives, Dinky; Off-Road Hauling Units (including articulating) Non Self-Loading Ejection Dump; Pump Cretes: Squeeze Cretes - Screw Type Pumps, Gypsum Bulker and Pump; Roller, Asphalt; Rotary Snow Plows; Rototiller, Seaman, etc., self-propelled; Self-Propelled Compactor; Spreader - Chip - Stone, etc.; Scraper - Single/Twin Engine/Push and Pull; Scraper - Prime Mover in Tandem (Regardless of Size); Tractors pulling attachments, Sheeps Foot, Disc, Compactor, etc.; Tug Boats.

Class 3. Boilers; Brooms, All Power Propelled; Cement Supply Tender; Compressor, Common Receiver (2); Concrete Mixer (Two Bag and Over);

Conveyor, Portable; Farm-Type Tractors Used for Mowing, Seeding, etc.; Forklift Trucks; Grouting Machine; Hoists, Automatic; Hoists, All Elevators; Hoists, Tugger Single Drum; Jeep Diggers; Low Boys; Pipe Jacking Machines; Post-Hole Digger; Power Saw, Concrete Power Driven; Pug Mills; Rollers, other than Asphalt; Seed and Straw Blower; Steam Generators; Stump Machine; Winch Trucks with "A" Frame; Work Boats; Tamper-Form-Motor Driven.

Class 4. Air Compressor; Combination - Small Equipment Operator; Directional Boring Machine; Generators; Heaters, Mechanical; Hydraulic Power Unit (Pile Driving, Extracting, or Drilling); Light Plants, All (1 through 5); Pumps, over 3" (1 to 3 not to exceed a total of 300 ft.); Pumps, Well Points; Vacuum Trucks (excluding hose work); Welding Machines (2 through 5); Winches, 4 Small Electric Drill Winches.

Class 5. SkidSteer Loader (all); Brick Forklifts; Oilers.

Class 6. Field Mechanics and Field Welders

Class 7. Dowell Machine with Air Compressor; Gradall and machines of like nature.

TRUCK DRIVER - BUILDING, HEAVY AND HIGHWAY CONSTRUCTION

Class 1. Two or three Axle Trucks. A-frame Truck when used for transportation purposes; Air Compressors and Welding Machines, including those pulled by cars, pick-up trucks and tractors; Ambulances; Batch Gate Lockers; Batch Hopperman; Car and Truck Washers; Carry-alls; Fork Lifts and Hoisters; Helpers; Mechanics Helpers and Greasers; Oil Distributors 2-man operation; Pavement Breakers; Pole Trailer, up to 40 feet; Power Mower Tractors; Self-propelled Chip Spreader; Skipman; Slurry Trucks, 2-man operation; Slurry Truck Conveyor Operation, 2 or 3 man; Teamsters; Unskilled Dumpman; and Truck Drivers hauling warning lights, barricades, and portable toilets on the job site.

Class 2. Four axle trucks; Dump Crets and Adgetors under 7 yards; Dumpsters, Track Trucks, Euclids, Hug Bottom Dump Turnapulls or Turnatrailers when pulling other than self-loading equipment or similar equipment under 16 cubic yards; Mixer Trucks under 7 yards; Ready-mix Plant Hopper Operator, and Winch Trucks, 2 Axles.

Class 3. Five axle trucks; Dump Crets and Adgetors 7 yards and over; Dumpsters, Track Trucks, Euclids, Hug Bottom Dump Turnatrailers or turnapulls when pulling other than self-loading equipment or similar equipment over 16 cubic yards; Explosives and/or Fission Material Trucks; Mixer Trucks 7 yards or over; Mobile Cranes while in transit; Oil Distributors, 1-man operation; Pole Trailer, over 40 feet; Pole and Expandable Trailers hauling material over 50 feet long; Slurry trucks, 1-man operation; Winch trucks, 3 axles or more; Mechanic--Truck Welder and Truck Painter.

Class 4. Six axle trucks; Dual-purpose vehicles, such as mounted crane trucks with hoist and accessories; Foreman; Master Mechanic; Self-loading equipment like P.B. and trucks with scoops on the front.

TERRAZZO FINISHER

The handling of sand, cement, marble chips, and all other materials that may be used by the Mosaic Terrazzo Mechanic, and the mixing, grinding, grouting, cleaning and sealing of all Marble, Mosaic, and

Terrazzo work, floors, base, stairs, and wainscoting by hand or machine, and in addition, assisting and aiding Marble, Masonic, and Terrazzo Mechanics.

Other Classifications of Work:

For definitions of classifications not otherwise set out, the Department generally has on file such definitions which are available. If a task to be performed is not subject to one of the classifications of pay set out, the Department will upon being contacted state which neighboring county has such a classification and provide such rate, such rate being deemed to exist by reference in this document. If no neighboring county rate applies to the task, the Department shall undertake a special determination, such special determination being then deemed to have existed under this determination. If a project requires these, or any classification not listed, please contact IDOL at 217-782-1710 for wage rates or clarifications.

LANDSCAPING

Landscaping work falls under the existing classifications for laborer, operating engineer and truck driver. The work performed by landscape plantsman and landscape laborer is covered by the existing classification of laborer. The work performed by landscape operators (regardless of equipment used or its size) is covered by the classifications of operating engineer. The work performed by landscape truck drivers (regardless of size of truck driven) is covered by the classifications of truck driver.

Edgar County Prevailing Wage for May 2013

(See explanation of column headings at bottom of wages)

Trade Name	RG	TYP	C	Base	FRMAN	M-F>8	OSA	OSH	H/W	Pensn	Vac	Trng
=====	==	===	=	=====	=====	=====	===	===	=====	=====	=====	=====
ASBESTOS ABT-GEN		BLD		29.710	30.960	1.5	1.5	2.0	5.750	9.920	0.000	0.900
ASBESTOS ABT-MEC		BLD		20.450	21.450	1.5	1.5	2.0	6.250	5.000	0.000	0.000
BOILERMAKER		BLD		31.500	34.000	1.5	1.5	2.0	7.070	18.73	1.000	0.350
BRICK MASON		BLD		30.670	32.170	1.5	1.5	2.0	6.600	10.03	0.000	0.630
CARPENTER		BLD		33.000	35.250	1.5	1.5	2.0	7.450	9.250	0.000	0.520
CARPENTER		HWY		33.350	35.100	1.5	1.5	2.0	7.450	9.250	0.000	0.520
CEMENT MASON		BLD		29.800	31.300	1.5	1.5	2.0	6.600	8.360	0.000	0.500
CEMENT MASON		HWY		30.390	31.890	1.5	1.5	2.0	6.600	8.560	0.000	0.500
CERAMIC TILE FNSHER		BLD		28.400	0.000	1.5	1.5	2.0	6.600	7.930	0.000	0.000
COMM SYSTEMS TECH		BLD		26.110	28.700	1.5	1.5	2.0	5.350	5.680	0.000	0.290
ELECTRIC PWR EQMT OP	1	ALL		35.570	0.000	1.5	1.5	2.0	5.000	9.960	0.000	0.360
ELECTRIC PWR EQMT OP	2	ALL		31.740	0.000	1.5	1.5	2.0	5.000	8.880	0.000	0.320
ELECTRIC PWR GRNDMAN		ALL		26.100	0.000	1.5	1.5	2.0	5.000	7.310	0.000	0.260
ELECTRIC PWR LINEMAN		ALL		44.630	47.650	1.5	1.5	2.0	5.000	12.50	0.000	0.450
ELECTRICIAN		BLD		34.920	37.360	1.5	1.5	2.0	5.350	9.030	0.000	0.290
FENCE ERECTOR		ALL		28.600	31.460	1.5	1.5	2.0	6.450	11.30	0.000	0.300
GLAZIER		BLD		26.580	28.080	1.5	1.5	2.0	6.160	5.310	0.000	0.400
HT/FROST INSULATOR		BLD		31.230	32.230	1.5	1.5	2.0	5.790	8.960	2.000	0.250
IRON WORKER		ALL		28.600	31.460	1.5	1.5	2.0	6.450	11.30	0.000	0.300
LABORER		BLD		27.710	28.960	1.5	1.5	2.0	5.750	9.920	0.000	0.800
LABORER		HWY		29.120	30.120	1.5	1.5	2.0	5.750	9.920	0.000	0.800
LATHER		BLD		33.000	35.250	1.5	1.5	2.0	7.450	9.250	0.000	0.520
MACHINIST		BLD		43.550	46.050	1.5	1.5	2.0	6.130	8.950	1.850	0.000
MARBLE FINISHERS		BLD		28.400	0.000	1.5	1.5	2.0	6.600	7.930	0.000	0.000
MARBLE MASON		BLD		29.900	0.000	1.5	1.5	2.0	6.600	7.930	0.000	0.000
MILLWRIGHT		BLD		29.620	31.870	1.5	1.5	2.0	7.450	13.09	0.000	0.520
MILLWRIGHT		HWY		31.400	33.150	1.5	1.5	2.0	7.450	13.54	0.000	0.520
OPERATING ENGINEER	1	ALL		36.950	0.000	1.5	1.5	2.0	7.250	8.700	0.000	0.800

OPERATING ENGINEER	ALL	2	23.900	0.000	1.5	1.5	2.0	7.250	8.700	0.000	0.800
PAINTER	ALL		26.000	27.500	1.5	1.5	2.0	7.700	8.230	0.000	0.450
PILEDRIVER	BLD		33.500	35.750	1.5	1.5	2.0	7.450	9.250	0.000	0.520
PILEDRIVER	HWY		34.350	36.100	1.5	1.5	2.0	7.450	9.250	0.000	0.520
PIPEFITTER	ALL		35.820	38.510	1.5	1.5	2.0	6.100	6.630	0.000	0.610
PLASTERER	BLD		30.000	32.000	1.5	1.5	2.0	6.600	10.17	0.000	0.500
PLUMBER	ALL		35.820	38.510	1.5	1.5	2.0	6.100	6.630	0.000	0.610
ROOFER	BLD		28.750	30.250	1.5	1.5	2.0	9.150	8.400	0.000	0.200
SHEETMETAL WORKER	BLD		31.390	32.960	1.5	1.5	2.0	7.350	7.690	0.000	1.090
SPRINKLER FITTER	BLD		36.390	39.140	1.5	1.5	2.0	8.420	8.500	0.000	0.450
STONE MASON	BLD		30.670	32.170	1.5	1.5	2.0	6.600	10.03	0.000	0.630
TERRAZZO FINISHER	BLD		28.400	0.000	1.5	1.5	2.0	6.600	7.930	0.000	0.000
TERRAZZO MASON	BLD		29.900	0.000	1.5	1.5	2.0	6.600	7.930	0.000	0.000
TILE LAYER	BLD		33.000	35.250	1.5	1.5	2.0	7.450	9.250	0.000	0.520
TILE MASON	BLD		29.900	0.000	1.5	1.5	2.0	6.600	7.930	0.000	0.000
TRUCK DRIVER	ALL	1	28.955	0.000	1.5	1.5	2.0	9.300	2.900	0.000	0.250
TRUCK DRIVER	ALL	2	29.355	0.000	1.5	1.5	2.0	9.300	2.900	0.000	0.250
TRUCK DRIVER	ALL	3	29.555	0.000	1.5	1.5	2.0	9.300	2.900	0.000	0.250
TRUCK DRIVER	ALL	4	29.805	0.000	1.5	1.5	2.0	9.300	2.900	0.000	0.250
TRUCK DRIVER	ALL	5	30.555	0.000	1.5	1.5	2.0	9.300	2.900	0.000	0.250
TRUCK DRIVER	O&C	1	23.160	0.000	1.5	1.5	2.0	9.300	2.900	0.000	0.250
TRUCK DRIVER	O&C	2	23.480	0.000	1.5	1.5	2.0	9.300	2.900	0.000	0.250
TRUCK DRIVER	O&C	3	23.640	0.000	1.5	1.5	2.0	9.300	2.900	0.000	0.250
TRUCK DRIVER	O&C	4	23.840	0.000	1.5	1.5	2.0	9.300	2.900	0.000	0.250
TRUCK DRIVER	O&C	5	24.440	0.000	1.5	1.5	2.0	9.300	2.900	0.000	0.250
TUCKPONTER	BLD		30.670	32.170	1.5	1.5	2.0	6.600	10.03	0.000	0.630

Legend :

RG (Region)

TYP (Trade Type - All,Highway,Building,Floating,Oil & Chip,Rivers)

C (Class)

Base (Base Wage Rate)

FRMAN (Foreman Rate)

M-F>8 (OT required for any hour greater than 8 worked each day, Mon through Fri.

OSA (Overtime (OT) is required for every hour worked on Saturday)

OSH (Overtime is required for every hour worked on Sunday and Holidays)

H/W (Health & Welfare Insurance)

Pensn (Pension)

Vac (Vacation)

Trng (Training)

Explanations

EDGAR COUNTY

The following list is considered as those days for which holiday rates of wages for work performed apply: New Years Day, Memorial Day, Fourth of July, Labor Day, Thanksgiving Day, Christmas Day and Veterans Day in some classifications/counties. Generally, any of

these holidays which fall on a Sunday is celebrated on the following Monday. This then makes work performed on that Monday payable at the appropriate overtime rate for holiday pay. Common practice in a given local may alter certain days of celebration. If in doubt, please check with IDOL.

Oil and chip resealing (O&C) means the application of road oils and liquid asphalt to coat an existing road surface, followed by application of aggregate chips or gravel to coated surface, and subsequent rolling of material to seal the surface.

EXPLANATION OF CLASSES

ASBESTOS - GENERAL - removal of asbestos material/mold and hazardous materials from any place in a building, including mechanical systems where those mechanical systems are to be removed. This includes the removal of asbestos materials/mold and hazardous materials from ductwork or pipes in a building when the building is to be demolished at the time or at some close future date.

ASBESTOS - MECHANICAL - removal of asbestos material from mechanical systems, such as pipes, ducts, and boilers, where the mechanical systems are to remain.

CERAMIC TILE FINISHER, MARBLE FINISHER, TERRAZZO FINISHER

Assisting, helping or supporting the tile, marble and terrazzo mechanic by performing their historic and traditional work assignments required to complete the proper installation of the work covered by said crafts. The term "Ceramic" is used for naming the classification only and is in no way a limitation of the product handled. Ceramic takes into consideration most hard tiles.

COMMUNICATIONS SYSTEM TECHNICIAN

Installation, operation, inspection, maintenance, repair, and service of radio, television, recording, voice sound and vision production and reproduction apparatus, equipment and appliances used for domestic, commercial, education, entertainment and private telephone systems.

TRUCK DRIVER - BUILDING, HEAVY AND HIGHWAY CONSTRUCTION

Class 1. Drivers on 2 axle trucks hauling less than 9 ton. Air compressor and welding machines and brooms, including those pulled by separate units, truck driver helpers, warehouse employees, mechanic helpers, greasers and tiremen, pickup trucks when hauling materials, tools, or workers to and from and on-the-job site, and fork lifts up to 6,000 lb. capacity.

Class 2. Two or three axle trucks hauling more than 9 ton but hauling less than 16 ton. A-frame winch trucks, hydrolift trucks, vactor trucks or similar equipment when used for transportation purposes. Fork lifts over 6,000 lb. capacity, winch trucks, four axle combination units, and ticket writers.

Class 3. Two, three or four axle trucks hauling 16 ton or more. Drivers on water pulls, articulated dump trucks, mechanics and working forepersons, and dispatchers. Five axle or more combination units.

Class 4. Low Boy and Oil Distributors.

Class 5. Drivers who require special protective clothing while employed on hazardous waste work.

TRUCK DRIVER - OIL AND CHIP RESEALING ONLY.

This shall encompass laborers, workers and mechanics who drive contractor or subcontractor owned, leased, or hired pickup, dump, service, or oil distributor trucks. The work includes transporting materials and equipment (including but not limited to, oils, aggregate supplies, parts, machinery and tools) to or from the job site; distributing oil or liquid asphalt and aggregate; stock piling material when in connection with the actual oil and chip contract. The Truck Driver (Oil & Chip Resealing) wage classification does not include supplier delivered materials.

OPERATING ENGINEERS - BUILDING, HEAVY AND HIGHWAY CONSTRUCTION

Class 1. Power Cranes, Draglines, Derricks, Shovels, Gradalls, Mechanics, Tractor Highlift, Tournadozer, Concrete Mixers with Skip, Tournamixer, Two Drum Machine, One Drum Hoist with Tower or Boom, Cableways, Tower Machines, Motor Patrol, Boom Tractor, Boom or Winch Truck, Winch or Hydraulic Boom Truck, Truck Crane, Tournapull, Tractor Operating Scoops, Bulldozer, Push Tractor, Asphalt Planer, Finishing Machine on Asphalt, Large Rollers on Earth, Rollers on Asphalt Mix, Ross Carrier or similar Machine, Gravel Processing Machine, Asphalt Plant Engineer, Paver Operator, Dredging Equipment, or Dredge Engineer, or Dredge Operator, Central Mix Plant Engineer, CMI or similar type machine, Concrete Pump, Truck or Skid Mounted, Tower Crane, Engineer or Rock Crusher Plant, Concrete Plant Engineer, Ditching Machine with dual attachment, Tractor Mounted Loaders, Cherry Picker, Hydro Crane, Standard or Dinkey Locomotives, Scoopmobiles, Euclid Loader, Soil Cement Machine, Back Filler, Elevating Machine, Power Blade, Drilling Machine, including Well Testing, Caissons, Shaft or any similar type drilling machines, Motor Driven Paint Machine, Pipe Cleaning Machine, Pipe Wrapping Machine, Pipe Bending Machine, Apsco Paver, Boring Machine, (Head Equipment Greaser), Barber-Greene Loaders, Formless Paver, (Well Point System), Concrete Spreader, Hydra Ax, Span Saw, Marine Scoops, Brush Mulcher, Brush Burner, Mesh Placer, Tree Mover, Helicopter Crew (3), Piledriver-Skid or Crawler, Stump Remover, Root Rake, Tug Boat Operator, Refrigerating Machine, Freezing Operator, Chair Cart-Self-Propelled, Hydra Seeder, Straw Blower, Power Sub Grader, Bull Float, Finishing Machine, Self-Propelled Pavement Breaker, Lull (or similar type Machine), Two Air Compressors, Compressors hooked in Manifold, Overhead Crane, Chip Spreader, Mud Cat, Sull-Air, Fork Lifts (except when used for landscaping work), Soil Stabilizer (Seaman Tiller, Bo Mag, Rago Gator, and similar types of equipment), Tube Float, Spray Machine, Curing Machine, Concrete or Asphalt Milling Machine, Snooper Truck-Operator, Backhoe, Farm Tractors (with attachments), 4 Point Lift System (Power Lift or similar type), Skid-Steer (Bob Cat or similar type), Wrecking Shears, Water Blaster.

Class 2. Concrete Mixers without Skips, Rock Crusher, Ditching Machine under 6', Curbing Machine, One Drum Machines without Tower or Boom, Air Tugger, Self-Propelled Concrete Saw, Machine Mounted Post Hole Digger, two to four Generators, Water Pumps or Welding Machines, within 400 feet, Air Compressor 600 cu. ft. and under, Rollers on Aggregate and Seal Coat Surfaces, Fork Lift (when used for landscaping work), Concrete and Blacktop Curb Machine, One Water Pump, Oilers, Air Valves or Steam Valves, One Welding Machine, Truck Jack, Mud Jack, Gunnite Machine, House Elevators when used for hoisting material, Engine Tenders, Fireman, Wagon Drill, Flex Plane, Conveyor, Siphons and Pulsometer, Switchman, Fireman on Paint Pots, Fireman on Asphalt Plants, Distributor Operator on Trucks, Tampers, Self-Propelled Power Broom, Striping Machine (motor driven), Form Tamper, Bulk Cement Plant, Equipment Greaser, Deck Hands, Truck Crane Oiler-Driver, Cement Blimps, Form Grader, Temporary Heat, Throttle Valve, Super Sucker (and similar type of equipment).

Other Classifications of Work:

For definitions of classifications not otherwise set out, the Department generally has on file such definitions which are available. If a task to be performed is not subject to one of the classifications of pay set out, the Department will upon being contacted state which neighboring county has such a classification and provide such rate, such rate being deemed to exist by reference in this document. If no neighboring county rate applies to the task, the Department shall undertake a special determination, such special determination being then deemed to have existed under this determination. If a project requires these, or any classification not listed, please contact IDOL at 217-782-1710 for wage rates or clarifications.

LANDSCAPING

Landscaping work falls under the existing classifications for laborer, operating engineer and truck driver. The work performed by landscape plantsman and landscape laborer is covered by the existing classification of laborer. The work performed by landscape operators (regardless of equipment used or its size) is covered by the classifications of operating engineer. The work performed by landscape truck drivers (regardless of size of truck driven) is covered by the classifications of truck driver.

Edwards County Prevailing Wage for May 2013

(See explanation of column headings at bottom of wages)

Trade Name	RG	TYP	C	Base	FRMAN	M-F>8	OSA	OSH	H/W	Pensn	Vac	Trng
=====	==	===	=	=====	=====	=====	===	===	=====	=====	=====	=====
ASBESTOS ABT-GEN		ALL		25.300	25.750	1.5	1.5	2.0	5.750	10.35	0.000	0.900
ASBESTOS ABT-MEC		BLD		21.150	22.150	1.5	1.5	2.0	6.400	5.150	0.000	0.650
BOILERMAKER		BLD		31.500	34.000	1.5	1.5	2.0	7.070	18.73	1.000	0.350
BRICK MASON		BLD		28.620	30.120	1.5	1.5	2.0	8.200	7.030	0.000	0.430
CARPENTER		BLD		31.890	33.390	1.5	1.5	2.0	6.550	6.750	0.000	0.400
CARPENTER		HWY		31.890	33.640	1.5	1.5	2.0	6.550	6.750	0.000	0.400
CEMENT MASON		BLD		28.200	29.700	1.5	1.5	2.0	6.600	5.400	0.000	0.500
CEMENT MASON		HWY		27.080	28.580	1.5	1.5	2.0	6.600	5.800	0.000	0.300
CERAMIC TILE FNSHER		BLD		27.120	0.000	1.5	1.5	2.0	8.200	7.030	0.000	0.430
ELECTRIC PWR EQMT OP		ALL	1	35.570	0.000	1.5	1.5	2.0	5.000	9.960	0.000	0.360
ELECTRIC PWR EQMT OP		ALL	2	31.740	0.000	1.5	1.5	2.0	5.000	8.880	0.000	0.320
ELECTRIC PWR GRNDMAN		ALL		26.100	0.000	1.5	1.5	2.0	5.000	7.310	0.000	0.260
ELECTRIC PWR LINEMAN		ALL		44.630	47.650	1.5	1.5	2.0	5.000	12.50	0.000	0.450
ELECTRICIAN		ALL		39.350	41.600	1.5	1.5	2.0	6.140	9.440	0.000	0.790
ELECTRONIC SYS TECH		BLD		32.570	34.320	1.5	1.5	2.0	6.000	4.240	0.000	0.400
FLOOR LAYER		BLD		29.330	30.080	1.5	1.5	2.0	6.550	6.750	0.000	0.400
GLAZIER		BLD		26.780	28.030	1.5	1.5	2.0	6.120	5.200	0.000	0.300
HT/FROST INSULATOR		BLD		29.450	30.450	1.5	1.5	2.0	5.050	9.730	0.000	0.280
IRON WORKER		ALL		27.020	28.270	1.5	1.5	2.0	7.010	9.200	0.000	0.345
LABORER		BLD		25.300	25.750	1.5	1.5	2.0	5.750	10.35	0.000	0.800
LABORER		HWY		25.300	25.750	1.5	1.5	2.0	5.750	10.35	0.000	0.800
MACHINIST		BLD		43.550	46.050	1.5	1.5	2.0	6.130	8.950	1.850	0.000
MARBLE FINISHERS		BLD		27.120	0.000	1.5	1.5	2.0	8.200	7.030	0.000	0.430
MARBLE MASON		BLD		28.620	30.120	1.5	1.5	2.0	8.200	7.030	0.000	0.430
MILLWRIGHT		BLD		31.890	33.390	1.5	1.5	2.0	6.550	6.750	0.000	0.400
MILLWRIGHT		HWY		32.390	34.140	1.5	1.5	2.0	6.550	6.750	0.000	0.400
OPERATING ENGINEER		ALL	1	36.950	0.000	1.5	1.5	2.0	7.250	8.700	0.000	0.800
OPERATING ENGINEER		ALL	2	23.900	0.000	1.5	1.5	2.0	7.250	8.700	0.000	0.800
PAINTER		BLD		24.450	25.450	1.5	1.5	2.0	6.250	5.550	0.000	0.300
PAINTER		HWY		25.600	26.600	1.5	1.5	2.0	6.250	5.550	0.000	0.300
PAINTER OVER 30FT		BLD		25.200	26.200	1.5	1.5	2.0	6.250	5.550	0.000	0.300
PAINTER PWR EQMT		BLD		25.450	26.450	1.5	1.5	2.0	6.250	5.550	0.000	0.300
PAINTER PWR EQMT		HWY		26.600	27.600	1.5	1.5	2.0	6.250	5.550	0.000	0.300

PILEDRIVER	BLD	31.890	33.390	1.5	1.5	2.0	6.550	6.750	0.000	0.400
PILEDRIVER	HWY	32.390	34.140	1.5	1.5	2.0	6.550	6.750	0.000	0.400
PIPEFITTER	BLD	33.640	35.660	1.5	1.5	2.0	6.100	8.310	0.000	0.800
PLASTERER	BLD	28.200	29.700	1.5	1.5	2.0	6.600	5.400	0.000	0.500
PLUMBER	BLD	33.640	35.660	1.5	1.5	2.0	6.100	8.310	0.000	0.800
ROOFER	BLD	27.240	29.240	1.5	1.5	2.0	7.200	5.250	0.000	0.540
SHEETMETAL WORKER	ALL	31.690	33.190	1.5	1.5	2.0	7.130	6.730	1.910	0.360
SPRINKLER FITTER	BLD	36.390	39.140	1.5	1.5	2.0	8.420	8.500	0.000	0.450
STONE MASON	BLD	28.620	30.120	1.5	1.5	2.0	8.200	7.030	0.000	0.430
TERRAZZO FINISHER	BLD	27.120	0.000	1.5	1.5	2.0	8.200	7.030	0.000	0.430
TILE MASON	BLD	28.620	30.120	1.5	1.5	2.0	8.200	7.030	0.000	0.430
TRUCK DRIVER	ALL 1	28.955	0.000	1.5	1.5	2.0	9.300	2.900	0.000	0.250
TRUCK DRIVER	ALL 2	29.355	0.000	1.5	1.5	2.0	9.300	2.900	0.000	0.250
TRUCK DRIVER	ALL 3	29.555	0.000	1.5	1.5	2.0	9.300	2.900	0.000	0.250
TRUCK DRIVER	ALL 4	29.805	0.000	1.5	1.5	2.0	9.300	2.900	0.000	0.250
TRUCK DRIVER	ALL 5	30.555	0.000	1.5	1.5	2.0	9.300	2.900	0.000	0.250
TUCKPOINTER	BLD	28.620	30.120	1.5	1.5	2.0	8.200	7.030	0.000	0.430

Legend:

RG (Region)

TYP (Trade Type - All,Highway,Building,Floating,Oil & Chip,Rivers)

C (Class)

Base (Base Wage Rate)

FRMAN (Foreman Rate)

M-F>8 (OT required for any hour greater than 8 worked each day, Mon through Fri.

OSA (Overtime (OT) is required for every hour worked on Saturday)

OSH (Overtime is required for every hour worked on Sunday and Holidays)

H/W (Health & Welfare Insurance)

Pensn (Pension)

Vac (Vacation)

Trng (Training)

Explanations

EDWARDS COUNTY

The following list is considered as those days for which holiday rates of wages for work performed apply: New Years Day, Memorial Day, Fourth of July, Labor Day, Thanksgiving Day, Christmas Day and Veterans Day in some classifications/counties. Generally, any of these holidays which fall on a Sunday is celebrated on the following Monday. This then makes work performed on that Monday payable at the appropriate overtime rate for holiday pay. Common practice in a given local may alter certain days of celebration. If in doubt, please check with IDOL.

EXPLANATION OF CLASSES

ASBESTOS - GENERAL - removal of asbestos material/mold and hazardous

materials from any place in a building, including mechanical systems where those mechanical systems are to be removed. This includes the removal of asbestos materials/mold and hazardous materials from ductwork or pipes in a building when the building is to be demolished at the time or at some close future date.

ASBESTOS - MECHANICAL - removal of asbestos material from mechanical systems, such as pipes, ducts, and boilers, where the mechanical systems are to remain.

CERAMIC TILE FINISHER, MARBLE FINISHER, TERRAZZO FINISHER

Assisting, helping or supporting the tile, marble and terrazzo mechanic by performing their historic and traditional work assignments required to complete the proper installation of the work covered by said crafts. The term "Ceramic" is used for naming the classification only, and is in no a limitation of the product handled. Ceramic takes into consideration most hard tiles.

ELECTRIC POWER LINEMAN

Construction, maintenance and dismantling of overhead and underground electric power lines, including high voltage pipe type cable work, and associated structures and equipment.

ELECTRIC POWER EQUIPMENT OPERATOR - CLASS 1

Operation of all crawler type equipment D-4 and larger from the ground to assist the Electric Power Linemen in performing their duties.

ELECTRIC POWER EQUIPMENT OPERATORS - CLASS 2

Operation of all other equipment from the ground to assist the Electric Power Linemen in performing their duties.

ELECTRIC POWER GROUNDMAN

Applies to workers who assist the Electric Power Lineman from the ground.

ELECTRONIC SYSTEMS TECHNICIAN

Installation, service and maintenance of low-voltage systems which utilizes the transmission and/or transference of voice, sound, vision, or digital for commercial, education, security and entertainment purposes for the following: TV monitoring and surveillance, background/foreground music, intercom and telephone interconnect, field programming, inventory control systems, microwave transmission, multi-media, multiplex, radio page, school, intercom and sound burglar alarms and low voltage master clock systems.

Excluded from this classification are energy management systems, life safety systems, supervisory controls and data acquisition systems not intrinsic with the above listed systems, fire alarm systems, nurse call systems and raceways exceeding fifteen feet in length.

TRUCK DRIVER - BUILDING, HEAVY AND HIGHWAY CONSTRUCTION

Class 1. Drivers on 2 axle trucks hauling less than 9 ton. Air compressor and welding machines and brooms, including those pulled by separate units, truck driver helpers, warehouse employees, mechanic helpers, greasers and tiremen, pickup trucks when hauling materials, tools, or workers to and from and on-the-job site, and fork lifts up to 6,000 lb. capacity.

Class 2. Two or three axle trucks hauling more than 9 ton but hauling

less than 16 ton. A-frame winch trucks, hydrolift trucks, vactor trucks or similar equipment when used for transportation purposes. Fork lifts over 6,000 lb. capacity, winch trucks, four axle combination units, and ticket writers.

Class 3. Two, three or four axle trucks hauling 16 ton or more. Drivers on water pulls, articulated dump trucks, mechanics and working forepersons, and dispatchers. Five axle or more combination units.

Class 4. Low Boy and Oil Distributors.

Class 5. Drivers who require special protective clothing while employed on hazardous waste work.

OPERATING ENGINEERS - BUILDING, HEAVY AND HIGHWAY CONSTRUCTION

Class 1. Power Cranes, Draglines, Derricks, Shovels, Gradalls, Mechanics, Tractor Highlift, Tournadozer, Concrete Mixers with Skip, Tournamixer, Two Drum Machine, One Drum Hoist with Tower or Boom, Cableways, Tower Machines, Motor Patrol, Boom Tractor, Boom or Winch Truck, Winch or Hydraulic Boom Truck, Truck Crane, Tournapull, Tractor Operating Scoops, Bulldozer, Push Tractor, Asphalt Planer, Finishing Machine on Asphalt, Large Rollers on Earth, Rollers on Asphalt Mix, Ross Carrier or similar Machine, Gravel Processing Machine, Asphalt Plant Engineer, Paver Operator, Dredging Equipment, or Dredge Engineer, or Dredge Operator, Central Mix Plant Engineer, CMI or similar type machine, Concrete Pump, Truck or Skid Mounted, Tower Crane, Engineer or Rock Crusher Plant, Concrete Plant Engineer, Ditching Machine with dual attachment, Tractor Mounted Loaders, Cherry Picker, Hydro Crane, Standard or Dinkey Locomotives, Scoopmobiles, Euclid Loader, Soil Cement Machine, Back Filler, Elevating Machine, Power Blade, Drilling Machine, including Well Testing, Caissons, Shaft or any similar type drilling machines, Motor Driven Paint Machine, Pipe Cleaning Machine, Pipe Wrapping Machine, Pipe Bending Machine, Apsco Paver, Boring Machine, (Head Equipment Greaser), Barber-Greene Loaders, Formless Paver, (Well Point System), Concrete Spreader, Hydra Ax, Span Saw, Marine Scoops, Brush Mulcher, Brush Burner, Mesh Placer, Tree Mover, Helicopter Crew (3), Piledriver-Skid or Crawler, Stump Remover, Root Rake, Tug Boat Operator, Refrigerating Machine, Freezing Operator, Chair Cart-Self-Propelled, Hydra Seeder, Straw Blower, Power Sub Grader, Bull Float, Finishing Machine, Self-Propelled Pavement Breaker, Lull (or similar type Machine), Two Air Compressors, Compressors hooked in Manifold, Overhead Crane, Chip Spreader, Mud Cat, Sull-Air, Fork Lifts (except when used for landscaping work), Soil Stabilizer (Seaman Tiller, Bo Mag, Rago Gator, and similar types of equipment), Tube Float, Spray Machine, Curing Machine, Concrete or Asphalt Milling Machine, Snooper Truck-Operator, Backhoe, Farm Tractors (with attachments), 4 Point Lift System (Power Lift or similar type), Skid-Steer (Bob Cat or similar type), Wrecking Shears, Water Blaster.

Class 2. Concrete Mixers without Skips, Rock Crusher, Ditching Machine under 6', Curbing Machine, One Drum Machines without Tower or Boom, Air Tugger, Self-Propelled Concrete Saw, Machine Mounted Post Hole Digger, two to four Generators, Water Pumps or Welding Machines, within 400 feet, Air Compressor 600 cu. ft. and under, Rollers on Aggregate and Seal Coat Surfaces, Fork Lift (when used for landscaping work), Concrete and Blacktop Curb Machine, One Water Pump, Oilers, Air Valves or Steam Valves, One Welding Machine, Truck Jack, Mud Jack, Gunnite Machine, House Elevators when used for hoisting material, Engine Tenders, Fireman, Wagon Drill, Flex Plane, Conveyor, Siphons and Pulsometer, Switchman, Fireman on Paint Pots, Fireman on Asphalt Plants, Distributor Operator on Trucks, Tampers, Self-Propelled Power Broom, Striping Machine (motor driven), Form Tamper, Bulk Cement Plant, Equipment Greaser, Deck Hands, Truck Crane Oiler-Driver,

Cement Blimps, Form Grader, Temporary Heat, Throttle Valve, Super Sucker (and similar type of equipment).

Other Classifications of Work:

For definitions of classifications not otherwise set out, the Department generally has on file such definitions which are available. If a task to be performed is not subject to one of the classifications of pay set out, the Department will upon being contacted state which neighboring county has such a classification and provide such rate, such rate being deemed to exist by reference in this document. If no neighboring county rate applies to the task, the Department shall undertake a special determination, such special determination being then deemed to have existed under this determination. If a project requires these, or any classification not listed, please contact IDOL at 217-782-1710 for wage rates or clarifications.

LANDSCAPING

Landscaping work falls under the existing classifications for laborer, operating engineer and truck driver. The work performed by landscape plantsman and landscape laborer is covered by the existing classification of laborer. The work performed by landscape operators (regardless of equipment used or its size) is covered by the classifications of operating engineer. The work performed by landscape truck drivers (regardless of size of truck driven) is covered by the classifications of truck driver.

Effingham County Prevailing Wage for May 2013

(See explanation of column headings at bottom of wages)

Trade Name	RG	TYP	C	Base	FRMAN	M-F>8	OSA	OSH	H/W	Pensn	Vac	Trng
=====	==	===	=	=====	=====	=====	===	===	=====	=====	=====	=====
ASBESTOS ABT-GEN		ALL		25.300	25.750	1.5	1.5	2.0	5.750	10.35	0.000	0.900
ASBESTOS ABT-MEC		BLD		21.150	22.150	1.5	1.5	2.0	6.400	5.150	0.000	0.650
BOILERMAKER		BLD		31.500	34.000	1.5	1.5	2.0	7.070	18.73	1.000	0.350
BRICK MASON		BLD		29.000	30.500	2.0	2.0	2.0	6.600	9.730	0.000	0.630
CARPENTER		BLD		29.600	31.850	1.5	1.5	2.0	7.450	12.65	0.000	0.520
CARPENTER		HWY		28.290	30.040	1.5	1.5	2.0	7.450	12.65	0.000	0.520
CEMENT MASON		BLD		29.800	31.300	1.5	1.5	2.0	6.600	8.360	0.000	0.500
CEMENT MASON		HWY		27.080	28.580	1.5	1.5	2.0	6.600	5.800	0.000	0.300
CERAMIC TILE FNSHER		BLD		28.400	0.000	1.5	1.5	2.0	6.600	7.930	0.000	0.000
ELECTRIC PWR EQMT OP		ALL	1	35.570	0.000	1.5	1.5	2.0	5.000	9.960	0.000	0.360
ELECTRIC PWR EQMT OP		ALL	2	31.740	0.000	1.5	1.5	2.0	5.000	8.880	0.000	0.320
ELECTRIC PWR GRNDMAN		ALL		26.100	0.000	1.5	1.5	2.0	5.000	7.310	0.000	0.260
ELECTRIC PWR LINEMAN		ALL		44.630	47.650	1.5	1.5	2.0	5.000	12.50	0.000	0.450
ELECTRICIAN	N	BLD		34.200	37.620	1.5	1.5	2.0	5.350	7.610	0.000	0.510
ELECTRICIAN	S	ALL		39.350	41.600	1.5	1.5	2.0	6.140	9.440	0.000	0.790
ELECTRONIC SYS TECH	N	BLD		31.130	32.880	1.5	1.5	2.0	5.350	6.110	0.000	0.400
ELECTRONIC SYS TECH	S	BLD		32.570	34.320	1.5	1.5	2.0	6.000	4.240	0.000	0.400
ELEVATOR CONSTRUCTOR		BLD		40.520	45.585	2.0	2.0	2.0	11.88	12.71	3.240	0.600
GLAZIER		BLD		30.780	32.780	1.5	2.0	2.0	6.630	8.150	0.000	0.380
HT/FROST INSULATOR		BLD		29.450	30.450	1.5	1.5	2.0	5.050	9.730	0.000	0.280
IRON WORKER		ALL		28.600	31.460	1.5	1.5	2.0	6.450	11.30	0.000	0.300
LABORER		BLD		25.300	25.750	1.5	1.5	2.0	5.750	10.35	0.000	0.800
LABORER		HWY		25.300	25.750	1.5	1.5	2.0	5.750	10.35	0.000	0.800
LATHER		BLD		29.600	31.850	1.5	1.5	2.0	7.450	12.65	0.000	0.520
MACHINIST		BLD		43.550	46.050	1.5	1.5	2.0	6.130	8.950	1.850	0.000
MARBLE FINISHERS		BLD		28.400	0.000	1.5	1.5	2.0	6.600	7.930	0.000	0.000
MARBLE MASON		BLD		29.900	0.000	1.5	1.5	2.0	6.600	7.930	0.000	0.000
MILLWRIGHT		BLD		29.620	31.870	1.5	1.5	2.0	7.450	13.09	0.000	0.520
MILLWRIGHT		HWY		31.980	33.730	1.5	1.5	2.0	7.450	13.40	0.000	0.520

OPERATING ENGINEER	ALL	1	36.950	0.000	1.5	1.5	2.0	7.250	8.700	0.000	0.800
OPERATING ENGINEER	ALL	2	23.900	0.000	1.5	1.5	2.0	7.250	8.700	0.000	0.800
PAINTER	ALL		26.000	27.500	1.5	1.5	2.0	7.700	8.230	0.000	0.450
PILEDRIVER	BLD		30.100	32.350	1.5	1.5	2.0	7.450	12.65	0.000	0.520
PILEDRIVER	HWY		29.290	31.040	1.5	1.5	2.0	7.450	12.65	0.000	0.520
PIPEFITTER	BLD		37.680	40.180	1.5	1.5	2.0	7.000	10.61	0.000	0.980
PLASTERER	BLD		30.000	32.000	1.5	1.5	2.0	6.600	10.17	0.000	0.500
PLUMBER	BLD		37.680	40.180	1.5	1.5	2.0	7.000	10.61	0.000	0.980
ROOFER	BLD		26.100	28.600	1.5	1.5	2.0	9.600	6.280	0.000	0.550
SHEETMETAL WORKER	ALL		31.690	33.190	1.5	1.5	2.0	7.130	6.730	1.910	0.360
SPRINKLER FITTER	BLD		36.390	39.140	1.5	1.5	2.0	8.420	8.500	0.000	0.450
STONE MASON	BLD		29.000	30.500	2.0	2.0	2.0	6.600	9.730	0.000	0.630
TERRAZZO FINISHER	BLD		28.400	0.000	1.5	1.5	2.0	6.600	7.930	0.000	0.000
TERRAZZO MASON	BLD		29.900	0.000	1.5	1.5	2.0	6.600	7.930	0.000	0.000
TILE LAYER	BLD		29.600	31.850	1.5	1.5	2.0	7.450	12.65	0.000	0.520
TILE MASON	BLD		29.900	0.000	1.5	1.5	2.0	6.600	7.930	0.000	0.000
TRUCK DRIVER	ALL	1	31.230	0.000	1.5	1.5	2.0	10.30	4.840	0.000	0.250
TRUCK DRIVER	ALL	2	31.680	0.000	1.5	1.5	2.0	10.30	4.840	0.000	0.250
TRUCK DRIVER	ALL	3	31.890	0.000	1.5	1.5	2.0	10.30	4.840	0.000	0.250
TRUCK DRIVER	ALL	4	32.180	0.000	1.5	1.5	2.0	10.30	4.840	0.000	0.250
TRUCK DRIVER	ALL	5	33.020	0.000	1.5	1.5	2.0	10.30	4.840	0.000	0.250
TUCKPONTER	BLD		29.000	30.500	2.0	2.0	2.0	6.600	9.730	0.000	0.630

Legend :

RG (Region)

TYP (Trade Type - All,Highway,Building,Floating,Oil & Chip,Rivers)

C (Class)

Base (Base Wage Rate)

FRMAN (Foreman Rate)

M-F>8 (OT required for any hour greater than 8 worked each day, Mon through Fri.

OSA (Overtime (OT) is required for every hour worked on Saturday)

OSH (Overtime is required for every hour worked on Sunday and Holidays)

H/W (Health & Welfare Insurance)

Pensn (Pension)

Vac (Vacation)

Trng (Training)

Explanations

EFFINGHAM COUNTY

ELECTRICIANS AND ELECTRONIC SYSTEMS TECHNICIAN (NORTH) - Townships of Banner, Bishop, Douglas, Liberty, Lucas, Moccasin, St. Francis, Summit and Teutopolis.

ELECTRICIANS AND ELECTRONIC SYSTEMS TECHNICIAN (SOUTH) - Those townships not included in NORTH.

The following list is considered as those days for which holiday rates

of wages for work performed apply: New Years Day, Memorial Day, Fourth of July, Labor Day, Thanksgiving Day, Christmas Day and Veterans Day in some classifications/counties. Generally, any of these holidays which fall on a Sunday is celebrated on the following Monday. This then makes work performed on that Monday payable at the appropriate overtime rate for holiday pay. Common practice in a given local may alter certain days of celebration. If in doubt, please check with IDOL.

EXPLANATION OF CLASSES

ASBESTOS - GENERAL - removal of asbestos material/mold and hazardous materials from any place in a building, including mechanical systems where those mechanical systems are to be removed. This includes the removal of asbestos materials/mold and hazardous materials from ductwork or pipes in a building when the building is to be demolished at the time or at some close future date.

ASBESTOS - MECHANICAL - removal of asbestos material from mechanical systems, such as pipes, ducts, and boilers, where the mechanical systems are to remain.

CERAMIC TILE FINISHER, MARBLE FINISHER, TERRAZZO FINISHER

Assisting, helping or supporting the tile, marble and terrazzo mechanic by performing their historic and traditional work assignments required to complete the proper installation of the work covered by said crafts. The term "Ceramic" is used for naming the classification only and is in no way a limitation of the product handled. Ceramic takes into consideration most hard tiles.

ELECTRIC POWER LINEMAN

Construction, maintenance and dismantling of overhead and underground electric power lines, including high voltage pipe type cable work, and associated structures and equipment.

ELECTRIC POWER EQUIPMENT OPERATOR - CLASS 1

Operation of all crawler type equipment D-4 and larger from the ground to assist the Electric Power Linemen in performing their duties.

ELECTRIC POWER EQUIPMENT OPERATORS - CLASS 2

Operation of all other equipment from the ground to assist the Electric Power Linemen in performing their duties.

ELECTRIC POWER GROUNDMAN

Applies to workers who assist the Electric Power Lineman from the ground.

ELECTRONIC SYSTEMS TECHNICIAN

Installation, service and maintenance of low-voltage systems which utilizes the transmission and/or transference of voice, sound, vision, or digital for commercial, education, security and entertainment purposes for the following: TV monitoring and surveillance, background/foreground music, intercom and telephone interconnect, field programming, inventory control systems, microwave transmission, multi-media, multiplex, radio page, school, intercom and sound burglar alarms and low voltage master clock systems.

Excluded from this classification are energy management systems, life safety systems, supervisory controls and data acquisition systems not

intrinsic with the above listed systems, fire alarm systems, nurse call systems and raceways exceeding fifteen feet in length.

TRUCK DRIVER - BUILDING, HEAVY AND HIGHWAY CONSTRUCTION

Class 1. Drivers on 2 axle trucks hauling less than 9 ton. Air compressor and welding machines and brooms, including those pulled by separate units, truck driver helpers, warehouse employees, mechanic helpers, greasers and tiremen, pickup trucks when hauling materials, tools, or workers to and from and on-the-job site, and fork lifts up to 6,000 lb. capacity.

Class 2. Two or three axle trucks hauling more than 9 ton but hauling less than 16 ton. A-frame winch trucks, hydrolift trucks, vactor trucks or similar equipment when used for transportation purposes. Fork lifts over 6,000 lb. capacity, winch trucks, four axle combination units, and ticket writers.

Class 3. Two, three or four axle trucks hauling 16 ton or more. Drivers on water pulls, articulated dump trucks, mechanics and working forepersons, and dispatchers. Five axle or more combination units.

Class 4. Low Boy and Oil Distributors.

Class 5. Drivers who require special protective clothing while employed on hazardous waste work.

OPERATING ENGINEERS - BUILDING, HEAVY AND HIGHWAY CONSTRUCTION

Class 1. Power Cranes, Draglines, Derricks, Shovels, Gradalls, Mechanics, Tractor Highlift, Tournadozer, Concrete Mixers with Skip, Tournamixer, Two Drum Machine, One Drum Hoist with Tower or Boom, Cableways, Tower Machines, Motor Patrol, Boom Tractor, Boom or Winch Truck, Winch or Hydraulic Boom Truck, Truck Crane, Tournapull, Tractor Operating Scoops, Bulldozer, Push Tractor, Asphalt Planer, Finishing Machine on Asphalt, Large Rollers on Earth, Rollers on Asphalt Mix, Ross Carrier or similar Machine, Gravel Processing Machine, Asphalt Plant Engineer, Paver Operator, Dredging Equipment, or Dredge Engineer, or Dredge Operator, Central Mix Plant Engineer, CMI or similar type machine, Concrete Pump, Truck or Skid Mounted, Tower Crane, Engineer or Rock Crusher Plant, Concrete Plant Engineer, Ditching Machine with dual attachment, Tractor Mounted Loaders, Cherry Picker, Hydro Crane, Standard or Dinkey Locomotives, Scoopmobiles, Euclid Loader, Soil Cement Machine, Back Filler, Elevating Machine, Power Blade, Drilling Machine, including Well Testing, Caissons, Shaft or any similar type drilling machines, Motor Driven Paint Machine, Pipe Cleaning Machine, Pipe Wrapping Machine, Pipe Bending Machine, Apsco Paver, Boring Machine, (Head Equipment Greaser), Barber-Greene Loaders, Formless Paver, (Well Point System), Concrete Spreader, Hydra Ax, Span Saw, Marine Scoops, Brush Mulcher, Brush Burner, Mesh Placer, Tree Mover, Helicopter Crew (3), Piledriver-Skid or Crawler, Stump Remover, Root Rake, Tug Boat Operator, Refrigerating Machine, Freezing Operator, Chair Cart-Self-Propelled, Hydra Seeder, Straw Blower, Power Sub Grader, Bull Float, Finishing Machine, Self-Propelled Pavement Breaker, Lull (or similar type Machine), Two Air Compressors, Compressors hooked in Manifold, Overhead Crane, Chip Spreader, Mud Cat, Sull-Air, Fork Lifts (except when used for landscaping work), Soil Stabilizer (Seaman Tiller, Bo Mag, Rago Gator, and similar types of equipment), Tube Float, Spray Machine, Curing Machine, Concrete or Asphalt Milling Machine, Snooper Truck-Operator, Backhoe, Farm Tractors (with attachments), 4 Point Lift System (Power Lift or similar type), Skid-Steer (Bob Cat or similar type), Wrecking Shears, Water Blaster.

Class 2. Concrete Mixers without Skips, Rock Crusher, Ditching Machine under 6', Curbing Machine, One Drum Machines without Tower or

Boom, Air Tugger, Self-Propelled Concrete Saw, Machine Mounted Post Hole Digger, two to four Generators, Water Pumps or Welding Machines, within 400 feet, Air Compressor 600 cu. ft. and under, Rollers on Aggregate and Seal Coat Surfaces, Fork Lift (when used for landscaping work), Concrete and Blacktop Curb Machine, One Water Pump, Oilers, Air Valves or Steam Valves, One Welding Machine, Truck Jack, Mud Jack, Gunnite Machine, House Elevators when used for hoisting material, Engine Tenders, Fireman, Wagon Drill, Flex Plane, Conveyor, Siphons and Pulsometer, Switchman, Fireman on Paint Pots, Fireman on Asphalt Plants, Distributor Operator on Trucks, Tampers, Self-Propelled Power Broom, Striping Machine (motor driven), Form Tamper, Bulk Cement Plant, Equipment Greaser, Deck Hands, Truck Crane Oiler-Driver, Cement Blimps, Form Grader, Temporary Heat, Throttle Valve, Super Sucker (and similar type of equipment).

Other Classifications of Work:

For definitions of classifications not otherwise set out, the Department generally has on file such definitions which are available. If a task to be performed is not subject to one of the classifications of pay set out, the Department will upon being contacted state which neighboring county has such a classification and provide such rate, such rate being deemed to exist by reference in this document. If no neighboring county rate applies to the task, the Department shall undertake a special determination, such special determination being then deemed to have existed under this determination. If a project requires these, or any classification not listed, please contact IDOL at 217-782-1710 for wage rates or clarifications.

LANDSCAPING

Landscaping work falls under the existing classifications for laborer, operating engineer and truck driver. The work performed by landscape plantsman and landscape laborer is covered by the existing classification of laborer. The work performed by landscape operators (regardless of equipment used or its size) is covered by the classifications of operating engineer. The work performed by landscape truck drivers (regardless of size of truck driven) is covered by the classifications of truck driver.

Fayette County Prevailing Wage for May 2013

(See explanation of column headings at bottom of wages)

Trade Name	RG	TYP	C	Base	FRMAN	M-F>8	OSA	OSH	H/W	Pensn	Vac	Trng
ASBESTOS ABT-GEN		ALL		25.300	25.750	1.5	1.5	2.0	5.750	10.35	0.000	0.900
ASBESTOS ABT-MEC		BLD		29.860	30.860	1.5	1.5	2.0	6.950	3.000	0.000	0.000
BOILERMAKER		BLD		31.500	34.000	1.5	1.5	2.0	7.070	18.73	1.000	0.350
BRICK MASON		BLD		29.280	33.160	1.5	1.5	2.0	7.750	9.430	2.000	0.400
CARPENTER		BLD		31.890	33.390	1.5	1.5	2.0	6.550	6.750	0.000	0.400
CARPENTER		HWY		31.890	33.640	1.5	1.5	2.0	6.550	6.750	0.000	0.400
CEMENT MASON		BLD		28.200	29.700	1.5	1.5	2.0	6.600	5.400	0.000	0.500
CEMENT MASON		HWY		27.080	28.580	1.5	1.5	2.0	6.600	5.800	0.000	0.300
CERAMIC TILE FNSHER		BLD		25.890	0.000	1.5	1.5	2.0	6.000	5.200	0.000	0.530
ELECTRIC PWR EQMT OP		ALL	1	35.570	0.000	1.5	1.5	2.0	5.000	9.960	0.000	0.360
ELECTRIC PWR EQMT OP		ALL	2	31.740	0.000	1.5	1.5	2.0	5.000	8.880	0.000	0.320
ELECTRIC PWR GRNDMAN		ALL		26.100	0.000	1.5	1.5	2.0	5.000	7.310	0.000	0.260
ELECTRIC PWR LINEMAN		ALL		44.630	47.650	1.5	1.5	2.0	5.000	12.50	0.000	0.450
ELECTRICIAN	N	BLD		34.200	37.620	1.5	1.5	2.0	5.350	7.610	0.000	0.510
ELECTRICIAN	S	ALL		39.350	41.600	1.5	1.5	2.0	6.140	9.440	0.000	0.790
ELECTRONIC SYS TECH		BLD		32.570	34.320	1.5	1.5	2.0	6.000	4.240	0.000	0.400

ELEVATOR CONSTRUCTOR	BLD	40.520	45.585	2.0	2.0	2.0	11.88	12.71	3.240	0.600
FLOOR LAYER	BLD	29.330	30.080	1.5	1.5	2.0	6.550	6.750	0.000	0.400
GLAZIER	BLD	30.780	32.780	1.5	2.0	2.0	6.630	8.150	0.000	0.380
HT/FROST INSULATOR	BLD	37.260	38.260	1.5	1.5	2.0	7.850	11.16	0.000	0.500
IRON WORKER	ALL	31.500	33.500	1.5	1.5	2.0	7.610	13.33	0.000	0.420
LABORER	BLD	25.300	25.750	1.5	1.5	2.0	5.750	10.35	0.000	0.800
LABORER	HWY	25.300	25.750	1.5	1.5	2.0	5.750	10.35	0.000	0.800
MACHINIST	BLD	43.550	46.050	1.5	1.5	2.0	6.130	8.950	1.850	0.000
MARBLE FINISHERS	BLD	25.890	0.000	1.5	1.5	2.0	6.000	5.200	0.000	0.530
MARBLE MASON	BLD	29.280	33.160	1.5	1.5	2.0	7.750	9.430	2.000	0.400
MILLWRIGHT	BLD	31.890	33.390	1.5	1.5	2.0	6.550	6.750	0.000	0.400
MILLWRIGHT	HWY	32.390	34.140	1.5	1.5	2.0	6.550	6.750	0.000	0.400
OPERATING ENGINEER	BLD 1	34.200	37.200	1.5	1.5	2.0	9.000	17.00	0.000	1.000
OPERATING ENGINEER	BLD 2	33.070	37.200	1.5	1.5	2.0	9.000	17.00	0.000	1.000
OPERATING ENGINEER	BLD 3	28.590	37.200	1.5	1.5	2.0	9.000	17.00	0.000	1.000
OPERATING ENGINEER	BLD 4	28.650	37.200	1.5	1.5	2.0	9.000	17.00	0.000	1.000
OPERATING ENGINEER	BLD 5	28.320	37.200	1.5	1.5	2.0	9.000	17.00	0.000	1.000
OPERATING ENGINEER	BLD 6	35.750	37.200	1.5	1.5	2.0	9.000	17.00	0.000	1.000
OPERATING ENGINEER	BLD 7	36.050	37.200	1.5	1.5	2.0	9.000	17.00	0.000	1.000
OPERATING ENGINEER	BLD 8	36.330	37.200	1.5	1.5	2.0	9.000	17.00	0.000	1.000
OPERATING ENGINEER	BLD 9	35.650	37.200	1.5	1.5	2.0	9.000	17.00	0.000	1.000
OPERATING ENGINEER	HWY 1	32.700	35.700	1.5	1.5	2.0	9.000	17.00	0.000	1.000
OPERATING ENGINEER	HWY 2	31.570	35.700	1.5	1.5	2.0	9.000	17.00	0.000	1.000
OPERATING ENGINEER	HWY 3	27.090	35.700	1.5	1.5	2.0	9.000	17.00	0.000	1.000
OPERATING ENGINEER	HWY 4	27.150	35.700	1.5	1.5	2.0	9.000	17.00	0.000	1.000
OPERATING ENGINEER	HWY 5	26.820	35.700	1.5	1.5	2.0	9.000	17.00	0.000	1.000
OPERATING ENGINEER	HWY 6	34.250	35.700	1.5	1.5	2.0	9.000	17.00	0.000	1.000
OPERATING ENGINEER	HWY 7	34.550	35.700	1.5	1.5	2.0	9.000	17.00	0.000	1.000
OPERATING ENGINEER	HWY 8	34.830	35.700	1.5	1.5	2.0	9.000	17.00	0.000	1.000
OPERATING ENGINEER	HWY 9	34.150	35.700	1.5	1.5	2.0	9.000	17.00	0.000	1.000
PAINTER	BLD	29.250	30.750	1.5	1.5	2.0	5.000	7.920	0.000	0.600
PAINTER	HWY	30.450	31.950	1.5	1.5	2.0	5.000	7.920	0.000	0.600
PAINTER OVER 30FT	BLD	30.250	31.750	1.5	1.5	2.0	5.000	7.920	0.000	0.600
PAINTER PWR EQMT	BLD	30.250	31.750	1.5	1.5	2.0	5.000	7.920	0.000	0.600
PAINTER PWR EQMT	HWY	31.450	32.950	1.5	1.5	2.0	5.000	7.920	0.000	0.600
PILEDRIVER	BLD	31.890	33.390	1.5	1.5	2.0	6.550	6.750	0.000	0.400
PILEDRIVER	HWY	32.390	34.140	1.5	1.5	2.0	6.550	6.750	0.000	0.400
PIPEFITTER	BLD	34.450	37.900	1.5	1.5	2.0	6.050	6.550	0.000	0.800
PLASTERER	BLD	28.200	29.700	1.5	1.5	2.0	6.600	5.400	0.000	0.500
PLUMBER	BLD	34.450	37.900	1.5	1.5	2.0	6.050	6.550	0.000	0.800
ROOFER	BLD	26.100	28.600	1.5	1.5	2.0	9.600	6.280	0.000	0.550
SHEETMETAL WORKER	ALL	31.690	33.190	1.5	1.5	2.0	7.130	6.730	1.910	0.360
SPRINKLER FITTER	BLD	36.390	39.140	1.5	1.5	2.0	8.420	8.500	0.000	0.450
TERRAZZO FINISHER	BLD	31.240	0.000	1.5	1.5	2.0	6.000	3.230	0.000	0.200
TERRAZZO MASON	BLD	32.530	32.830	1.5	1.5	2.0	6.000	5.230	0.000	0.210
TRUCK DRIVER	ALL 1	31.340	0.000	1.5	1.5	2.0	10.30	5.010	0.000	0.250
TRUCK DRIVER	ALL 2	31.780	0.000	1.5	1.5	2.0	10.30	5.010	0.000	0.250
TRUCK DRIVER	ALL 3	32.020	0.000	1.5	1.5	2.0	10.30	5.010	0.000	0.250
TRUCK DRIVER	ALL 4	32.280	0.000	1.5	1.5	2.0	10.30	5.010	0.000	0.250
TRUCK DRIVER	ALL 5	33.130	0.000	1.5	1.5	2.0	10.30	5.010	0.000	0.250
TRUCK DRIVER	O&C 1	25.070	0.000	1.5	1.5	2.0	10.30	5.010	0.000	0.250
TRUCK DRIVER	O&C 2	25.420	0.000	1.5	1.5	2.0	10.30	5.010	0.000	0.250
TRUCK DRIVER	O&C 3	25.620	0.000	1.5	1.5	2.0	10.30	5.010	0.000	0.250
TRUCK DRIVER	O&C 4	25.820	0.000	1.5	1.5	2.0	10.30	5.010	0.000	0.250
TRUCK DRIVER	O&C 5	26.500	0.000	1.5	1.5	2.0	10.30	5.010	0.000	0.250

Legend :

RG (Region)

TYP (Trade Type - All,Highway,Building,Floating,Oil & Chip,Rivers)

C (Class)

Base (Base Wage Rate)

FRMAN (Foreman Rate)

M-F>8 (OT required for any hour greater than 8 worked each day, Mon through Fri.)

OSA (Overtime (OT) is required for every hour worked on Saturday)

OSH (Overtime is required for every hour worked on Sunday and Holidays)

H/W (Health & Welfare Insurance)

Pensn (Pension)

Vac (Vacation)

Trng (Training)

Explanations

FAYETTE COUNTY

ELECTRICIANS (NORTH) - Townships of Bowling Green, Carson, Hurrican, Loudon, Ramsey, and South Hurricane.

GLAZIERS (SOUTHWEST) - That part of the county South and West of diagonal line running between the Bond, Montgomery, Fayette junction and North of Farina.

The following list is considered as those days for which holiday rates of wages for work performed apply: New Years Day, Memorial Day, Fourth of July, Labor Day, Thanksgiving Day, Christmas Day and Veterans Day in some classifications/counties. Generally, any of these holidays which fall on a Sunday is celebrated on the following Monday. This then makes work performed on that Monday payable at the appropriate overtime rate for holiday pay. Common practice in a given local may alter certain days of celebration. If in doubt, please check with IDOL.

Oil and chip resealing (O&C) means the application of road oils and liquid asphalt to coat an existing road surface, followed by application of aggregate chips or gravel to coated surface, and subsequent rolling of material to seal the surface.

EXPLANATION OF CLASSES

ASBESTOS - GENERAL - removal of asbestos material/mold and hazardous materials from any place in a building, including mechanical systems where those mechanical systems are to be removed. This includes the removal of asbestos materials/mold and hazardous materials from ductwork or pipes in a building when the building is to be demolished at the time or at some close future date.

ASBESTOS - MECHANICAL - removal of asbestos material from mechanical systems, such as pipes, ducts, and boilers, where the mechanical systems are to remain.

CERAMIC TILE FINISHER AND MARBLE FINISHER

The handling, at the building site, of all sand, cement, tile, marble or stone and all other materials that may be used and installed by [a] tile layer or marble mason. In addition, the grouting, cleaning,

sealing, and mixing on the job site, and all other work as required in assisting the setter. The term "Ceramic" is used for naming the classification only and is in no way a limitation of the product handled. Ceramic takes into consideration most hard tiles.

ELECTRONIC SYSTEMS TECHNICIAN

Installation, service and maintenance of low-voltage systems which utilizes the transmission and/or transference of voice, sound, vision, or digital for commercial, education, security and entertainment purposes for the following: TV monitoring and surveillance, background/foreground music, intercom and telephone interconnect, field programming, inventory control systems, microwave transmission, multi-media, multiplex, radio page, school, intercom and sound burglar alarms and low voltage master clock systems.

Excluded from this classification are energy management systems, life safety systems, supervisory controls and data acquisition systems not intrinsic with the above listed systems, fire alarm systems, nurse call systems and raceways exceeding fifteen feet in length.

OPERATING ENGINEER - BUILDING

GROUP I. Cranes, Dragline, Shovels, Skimmer Scoops, Clamshells or Derrick Boats, Pile Drivers, Crane-Type Backhoes, Asphalt Plant Operators, Concrete Plant Operators, Dredges, Asphalt Spreading Machines, All Locomotives, Cable Ways or Tower Machines, Hoists, Hydraulic Backhoes, Ditching Machines or Backfiller, Cherrypickers, Overhead Cranes, Roller - Steam or Gas, Concrete Pavers, Excavators, Concrete Breakers, Concrete Pumps, Bulk Cement Plants, Cement Pumps, Derrick-Type Drills, Boat Operators, Motor Graders or Pushcats, Scoops or Tournapulls, Bulldozers, Endloaders or Fork Lifts, Power Blade or Elevating Graders, Winch Cats, Boom or Winch Trucks or Boom Tractors, Pipe Wrapping or Painting Machines, Asphalt Plant Engineer, Journeyman Lubricating Engineer, Drills (other than Derrick Type), Mud Jacks, or Well Drilling Machines, Boring Machines or Track Jacks, Mixers, Conveyors (Two), Air Compressors (Two), Water Pumps regardless of size (Two), Welding Machines (Two), Siphons or Jets (Two), Winch Heads or Apparatuses (Two), Light Plants (Two), All Tractors regardless of size (straight tractor only), Fireman on Stationary Boilers, Automatic Elevators, Form Grading Machines, Finishing Machines, Power Sub-Grader or Ribbon Machines, Longitudinal Floats, Distributor Operators on Trucks, Winch Heads or Apparatuses (One), Mobil Track air and heaters (two to five), Heavy Equipment Greaser, Relief Operator, Assistant Master Mechanic and Heavy Duty Mechanic, self-propelled concrete saws of all types and sizes with their attachments, gob-hoppers, excavators all sizes, the repair and greasing of all diesel hammers, the operation and set-up of bidwells, water blasters of all sizes and their clutches, hydraulic jacks where used for hoisting, operation of log skidders, iceolators used on and off of pipeline, condor cranes, bow boats, survey boats, bobcats and all their attachments, skid steer loaders and all their attachments, creter cranes, batch plants, operator (all sizes), self propelled roto mills, operation of conveyor systems of any size and any configuration, operation, repair and service of all vibratory hammers, all power pacs and their controls regardless of location, curtains or brush burning machines, stump cutter machines, Nail launchers when mounted on a machine or self-propelled, operation of con-cover machines, and all Operators except those listed below).

GROUP II. Assistant Operators.

GROUP III. Air Compressors (One), Water Pumps, regardless of Size (One), Waterblasters (one), Welding Machine (One), Mixers (One Bag), Conveyor (One), Siphon or Jet (One), Light Plant (One), Heater (One),

Immobile Track Air (One), and Self Propelled Walk-Behind Rollers.

GROUP IV. Asphalt Spreader Oilers, Fireman on Whirlies and Heavy Equipment Oilers, Truck Cranes, Dredges, Monigans, Large Cranes - (Over 65-ton rated capacity) Concrete Plant Oiler, Blacktop Plant Oiler, and Creter Crane Oiler (when required).

GROUP V. Oiler.

GROUP VI. Operators on equipment with Booms, including jibs, 100 feet and over, and less than 150 feet long.

GROUP VII. Operators on equipment with Booms, including jibs, 150 feet and over, and less than 200 feet long.

GROUP VIII. Operators on Equipment with Booms, including jibs, 200 feet and over; Tower Cranes; and Whirlie Cranes.

GROUP IX. Master Mechanic

OPERATING ENGINEERS - Highway

GROUP I. Cranes, Dragline, Shovels, Skimmer Scoops, Clamshells or Derrick Boats, Pile Drivers, Crane-Type Backhoes, Asphalt Plant Operators, Concrete Plant Operators, Dredges, Asphalt Spreading Machines, All Locomotives, Cable Ways or Tower Machines, Hoists, Hydraulic Backhoes, Ditching Machines or Backfiller, Cherrypickers, Overhead Cranes, Roller - Steam or Gas, Concrete Pavers, Excavators, Concrete Breakers, Concrete Pumps, Bulk Cement Plants, Cement Pumps, Derrick-Type Drills, Boat Operators, Motor Graders or Pushcats, Scoops or Tournapulls, Bulldozers, Endloaders or Fork Lifts, Power Blade or Elevating Graders, Winch Cats, Boom or Winch Trucks or Boom Tractors, Pipe Wrapping or Painting Machines, Asphalt Plant Engineer, Journeyman Lubricating Engineer, Drills (other than Derrick Type), Mud Jacks, Well Drilling Machines, Boring Machines, Track Jacks, Mixers, Conveyors (Two), Air Compressors (Two), Water Pumps regardless of size (Two), Welding Machines (Two), Siphons or Jets (Two), Winch Heads or Apparatuses (Two), Light Plants (Two), All Tractors regardless of size (straight tractor only), Fireman on Stationary Boilers, Automatic Elevators, Form Grading Machines, Finishing Machines, Power Sub-Grader or Ribbon Machines, Longitudinal Floats, Distributor Operators on Trucks, Winch Heads or Apparatuses (One), Mobil Track air and heaters (two to five), Heavy Equipment Greaser, Relief Operator, Assistant Master Mechanic and Heavy Duty Mechanic, self-propelled concrete saws of all types and sizes with their attachments, gob-hoppers, excavators all sizes, the repair and greasing of all diesel hammers, the operation and set-up of bidwells, water blasters of all sizes and their clutches, hydraulic jacks where used for hoisting, operation of log skidders, iceolators used on and off of pipeline, condor cranes, bow boats, survey boats, bobcats and all their attachments, skid steer loaders and all their attachments, creter cranes, batch plants, operator (all sizes), self propelled roto mills, operation of conveyor systems of any size and any configuration, operation, repair and service of all vibratory hammers, all power pacs and their controls regardless of location, curtains or brush burning machines, stump cutter machines, Nail launchers when mounted on a machine or self-propelled, operation of con-cover machines, and all Operators (except those listed below).

GROUP II. Assistant Operators.

GROUP III. Air Compressors (One), Water Pumps, regardless of Size (One), Waterblasters (one), Welding Machine (One), Mixers (One Bag), Conveyor (One), Siphon or Jet (One), Light Plant (One), Heater (One), Immobile Track Air (One), and Self Propelled Walk-Behind Rollers.

GROUP IV. Asphalt Spreader Oilers, Fireman on Whirlies and Heavy Equipment Oilers, Truck Cranes, Dredges, Monigans, Large Cranes - (Over 65-ton rated capacity) Concrete Plant Oiler, Blacktop Plant Oiler, and Creter Crane Oiler (when required).

GROUP V. Oiler.

GROUP VI. Operators on equipment with Booms, including jibs, 100 feet and over, and less than 150 feet long.

GROUP VII. Operators on equipment with Booms, including jibs, 150 feet and over, and less than 200 feet long.

GROUP VIII. Operators on Equipment with Booms, including jibs, 200 feet and over; Tower Cranes; and Whirlie Cranes.

GROUP IX. Mechanic

TRUCK DRIVER - BUILDING, HEAVY AND HIGHWAY CONSTRUCTION

Class 1. Drivers on 2 axle trucks hauling less than 9 ton. Air compressor and welding machines and brooms, including those pulled by separate units, truck driver helpers, warehouse employees, mechanic helpers, greasers and tiremen, pickup trucks when hauling materials, tools, or workers to and from and on-the-job site, and fork lifts up to 6,000 lb. capacity.

Class 2. Two or three axle trucks hauling more than 9 ton but hauling less than 16 ton. A-frame winch trucks, hydrolift trucks, vactor trucks or similar equipment when used for transportation purposes. Fork lifts over 6,000 lb. capacity, winch trucks, four axle combination units, and ticket writers.

Class 3. Two, three or four axle trucks hauling 16 ton or more. Drivers on water pulls, articulated dump trucks, mechanics and working forepersons, and dispatchers. Five axle or more combination units.

Class 4. Low Boy and Oil Distributors.

Class 5. Drivers who require special protective clothing while employed on hazardous waste work.

TRUCK DRIVER - OIL AND CHIP RESEALING ONLY.

This shall encompass laborers, workers and mechanics who drive contractor or subcontractor owned, leased, or hired pickup, dump, service, or oil distributor trucks. The work includes transporting materials and equipment (including but not limited to, oils, aggregate supplies, parts, machinery and tools) to or from the job site; distributing oil or liquid asphalt and aggregate; stock piling material when in connection with the actual oil and chip contract. The Truck Driver (Oil & Chip Resealing) wage classification does not include supplier delivered materials.

TERRAZZO FINISHER

The handling of all materials used for Mosaic and Terrazzo work including preparing, mixing by hand, by mixing machine or transporting of pre-mixed materials and distributing with shovel, rake, hoe, or pail, all kinds of concrete foundations necessary for Mosaic and Terrazzo work, all cement terrazzo, magnesite terrazzo, Do-O-Tex terrazzo, epoxy matrix ter-razzo, exposed aggregate, rustic or rough washed for exterior or interior of buildings placed either by machine

or by hand, and any other kind of mixture of plastics composed of chips or granules when mixed with cement, rubber, neoprene, vinyl, magnesium chloride or any other resinous or chemical substances used for seamless flooring systems, and all other building materials, all similar materials and all precast terrazzo work on jobs, all scratch coat used for Mosaic and Terrazzo work and sub-bed, tar paper and wire mesh (2x2 etc.) or lath. The rubbing, grinding, cleaning and finishing of same either by hand or by machine or by terrazzo resurfacing equipment on new or existing floors. When necessary finishers shall be allowed to assist the mechanics to spread sand bed, lay tarpaper and wire mesh (2x2 etc.) or lath. The finishing of cement floors where additional aggregate of stone is added by spreading or sprinkling on top of the finished base, and troweled or rolled into the finish and then the surface is ground by grinding machines.

Other Classifications of Work:

For definitions of classifications not otherwise set out, the Department generally has on file such definitions which are available. If a task to be performed is not subject to one of the classifications of pay set out, the Department will upon being contacted state which neighboring county has such a classification and provide such rate, such rate being deemed to exist by reference in this document. If no neighboring county rate applies to the task, the Department shall undertake a special determination, such special determination being then deemed to have existed under this determination. If a project requires these, or any classification not listed, please contact IDOL at 217-782-1710 for wage rates or clarifications.

LANDSCAPING

Landscaping work falls under the existing classifications for laborer, operating engineer and truck driver. The work performed by landscape plantsman and landscape laborer is covered by the existing classification of laborer. The work performed by landscape operators (regardless of equipment used or its size) is covered by the classifications of operating engineer. The work performed by landscape truck drivers (regardless of size of truck driven) is covered by the classifications of truck driver.

Ford County Prevailing Wage for May 2013

(See explanation of column headings at bottom of wages)

Trade Name	RG	TYP	C	Base	FRMAN	M-F>8	OSA	OSH	H/W	Pensn	Vac	Trng
=====	==	===	=	=====	=====	=====	===	===	=====	=====	=====	=====
ASBESTOS ABT-GEN		BLD		32.910	33.910	1.5	1.5	2.0	8.240	12.26	0.000	0.800
ASBESTOS ABT-GEN		HWY		34.160	35.160	1.5	1.5	2.0	8.240	11.62	0.000	0.800
ASBESTOS ABT-MEC		BLD		34.160	36.660	1.5	1.5	2.0	10.82	10.66	0.000	0.720
BOILERMAKER		BLD		35.010	38.010	2.0	2.0	2.0	7.070	13.83	0.000	0.300
BRICK MASON	N	BLD		40.000	42.000	1.5	1.5	2.0	7.700	10.42	0.000	0.610
BRICK MASON	S	BLD		30.670	32.170	1.5	1.5	2.0	6.600	10.03	0.000	0.630
CARPENTER		HWY		31.000	33.250	1.5	1.5	2.0	7.450	13.76	0.000	0.520
CARPENTER	N	BLD		30.050	32.300	1.5	1.5	2.0	7.450	12.91	0.000	0.520
CARPENTER	S	BLD		30.050	32.300	1.5	1.5	2.0	7.450	12.20	0.000	0.520
CEMENT MASON		BLD		29.800	31.300	1.5	1.5	2.0	6.600	8.360	0.000	0.500
CEMENT MASON		HWY		30.390	31.890	1.5	1.5	2.0	6.600	8.560	0.000	0.500
CERAMIC TILE FNSHER		BLD		28.400	0.000	1.5	1.5	2.0	6.600	7.930	0.000	0.000
COMMUNICATION TECH	N	BLD		31.200	32.700	1.5	1.5	2.0	12.32	10.77	0.000	0.320
ELECTRIC PWR EQMT OP		ALL		35.440	0.000	1.5	1.5	2.0	5.000	10.98	0.000	0.270

ELECTRIC PWR GRNDMAN		ALL	24.320	0.000	1.5	1.5	2.0	5.000	7.540	0.000	0.180
ELECTRIC PWR LINEMAN		ALL	39.370	41.910	1.5	1.5	2.0	5.000	12.20	0.000	0.300
ELECTRIC PWR TRK DRV		ALL	25.510	0.000	1.5	1.5	2.0	5.000	7.920	0.000	0.190
ELECTRICIAN	N	BLD	37.950	41.370	1.5	1.5	2.0	13.17	15.06	0.000	1.200
ELECTRICIAN	S	BLD	37.090	39.090	1.5	1.5	2.0	5.350	7.760	0.000	0.560
ELECTRONIC SYS TECH	S	BLD	30.830	32.580	1.5	1.5	2.0	5.350	6.720	0.000	0.400
ELEVATOR CONSTRUCTOR		BLD	40.520	45.585	2.0	2.0	2.0	11.88	12.71	3.240	0.600
FENCE ERECTOR		ALL	30.610	32.510	1.5	1.5	2.0	8.840	8.420	0.000	0.900
GLAZIER		BLD	30.770	32.770	1.5	1.5	2.0	9.700	7.700	0.000	1.250
HT/FROST INSULATOR		BLD	45.550	48.050	1.5	1.5	2.0	10.82	11.86	0.000	0.720
IRON WORKER	N	ALL	39.500	43.450	2.0	2.0	2.0	9.390	18.98	0.000	0.700
IRON WORKER	S	ALL	30.610	32.510	1.5	1.5	2.0	8.840	8.420	0.000	0.900
LABORER		BLD	31.910	32.910	1.5	1.5	2.0	8.240	12.26	0.000	0.800
LABORER		HWY	33.160	34.160	1.5	1.5	2.0	8.240	11.62	0.000	0.800
LABORER, SKILLED		BLD	31.910	32.910	1.5	1.5	2.0	8.240	12.26	0.000	0.800
LABORER, SKILLED		HWY	33.160	34.160	1.5	1.5	2.0	8.240	11.62	0.000	0.800
LATHER		BLD	30.050	32.300	1.5	1.5	2.0	7.450	12.20	0.000	0.520
MACHINIST		BLD	43.550	46.050	1.5	1.5	2.0	6.130	8.950	1.850	0.000
MARBLE FINISHERS		BLD	28.400	0.000	1.5	1.5	2.0	6.600	7.930	0.000	0.000
MARBLE MASON	N	BLD	40.000	42.000	1.5	1.5	2.0	7.700	10.42	0.000	0.610
MARBLE MASON	S	BLD	29.900	0.000	1.5	1.5	2.0	6.600	7.930	0.000	0.000
MILLWRIGHT		BLD	30.300	32.550	1.5	1.5	2.0	7.450	13.09	0.000	0.520
MILLWRIGHT		HWY	31.820	34.070	1.5	1.5	2.0	7.450	13.44	0.000	0.520
OPERATING ENGINEER		ALL 1	36.950	0.000	1.5	1.5	2.0	7.250	8.700	0.000	0.800
OPERATING ENGINEER		ALL 2	23.900	0.000	1.5	1.5	2.0	7.250	8.700	0.000	0.800
PAINTER		ALL	32.900	34.900	1.5	1.5	1.5	9.650	8.200	0.000	1.250
PAINTER SIGNS		BLD	33.920	38.090	1.5	1.5	1.5	2.600	2.710	0.000	0.000
PILEDRIIVER		HWY	32.000	34.250	1.5	1.5	2.0	7.450	13.76	0.000	0.520
PILEDRIIVER	N	BLD	30.550	32.800	1.5	1.5	2.0	7.450	12.91	0.000	0.520
PILEDRIIVER	S	BLD	30.550	32.800	1.5	1.5	2.0	7.450	12.20	0.000	0.520
PIPEFITTER		BLD	37.680	40.180	1.5	1.5	2.0	7.000	10.61	0.000	0.980
PLASTERER		BLD	30.000	32.000	1.5	1.5	2.0	6.600	10.17	0.000	0.500
PLUMBER		BLD	37.680	40.180	1.5	1.5	2.0	7.000	10.61	0.000	0.980
ROOFER		BLD	38.350	41.350	1.5	1.5	2.0	8.280	8.770	0.000	0.430
SHEETMETAL WORKER		BLD	33.640	35.640	1.5	1.5	2.0	8.300	12.00	0.000	0.520
SPRINKLER FITTER		BLD	36.390	39.140	1.5	1.5	2.0	8.420	8.500	0.000	0.450
STONE MASON	S	BLD	30.670	32.170	1.5	1.5	2.0	6.600	10.03	0.000	0.630
TERRAZZO FINISHER		BLD	28.400	0.000	1.5	1.5	2.0	6.600	7.930	0.000	0.000
TERRAZZO MASON	S	BLD	29.900	0.000	1.5	1.5	2.0	6.600	7.930	0.000	0.000
TILE MASON	N	BLD	40.000	42.000	1.5	1.5	2.0	7.700	10.42	0.000	0.610
TILE MASON	S	BLD	29.900	0.000	1.5	1.5	2.0	6.600	7.930	0.000	0.000
TRUCK DRIVER		O&C 1	24.980	0.000	1.5	1.5	2.0	10.30	4.840	0.000	0.250
TRUCK DRIVER		O&C 2	25.340	0.000	1.5	1.5	2.0	10.30	4.840	0.000	0.250
TRUCK DRIVER		O&C 3	25.510	0.000	1.5	1.5	2.0	10.30	4.840	0.000	0.250
TRUCK DRIVER		O&C 4	25.740	0.000	1.5	1.5	2.0	10.30	4.840	0.000	0.250
TRUCK DRIVER		O&C 5	26.420	0.000	1.5	1.5	2.0	10.30	4.840	0.000	0.250
TRUCK DRIVER	N	ALL 1	35.650	36.200	1.5	1.5	2.0	7.250	6.319	0.000	0.250
TRUCK DRIVER	N	ALL 2	35.800	36.200	1.5	1.5	2.0	7.250	6.319	0.000	0.250
TRUCK DRIVER	N	ALL 3	36.000	36.200	1.5	1.5	2.0	7.250	6.319	0.000	0.250
TRUCK DRIVER	N	ALL 4	36.200	36.200	1.5	1.5	2.0	7.250	6.319	0.000	0.250
TRUCK DRIVER	S	ALL 1	31.230	0.000	1.5	1.5	2.0	10.30	4.840	0.000	0.250
TRUCK DRIVER	S	ALL 2	31.680	0.000	1.5	1.5	2.0	10.30	4.840	0.000	0.250
TRUCK DRIVER	S	ALL 3	31.890	0.000	1.5	1.5	2.0	10.30	4.840	0.000	0.250
TRUCK DRIVER	S	ALL 4	32.180	0.000	1.5	1.5	2.0	10.30	4.840	0.000	0.250
TRUCK DRIVER	S	ALL 5	33.020	0.000	1.5	1.5	2.0	10.30	4.840	0.000	0.250
TUCKPOINTER	N	BLD	39.000	41.000	1.5	1.5	2.0	7.400	9.760	0.000	0.580
TUCKPOINTER	S	BLD	30.670	32.170	1.5	1.5	2.0	6.600	10.03	0.000	0.630

Legend :

RG (Region)

TYP (Trade Type - All,Highway,Building,Floating,Oil & Chip,Rivers)

C (Class)

Base (Base Wage Rate)

FRMAN (Foreman Rate)

M-F>8 (OT required for any hour greater than 8 worked each day, Mon through Fri.)

OSA (Overtime (OT) is required for every hour worked on Saturday)

OSH (Overtime is required for every hour worked on Sunday and Holidays)

H/W (Health & Welfare Insurance)

Pensn (Pension)

Vac (Vacation)

Trng (Training)

Explanations

FORD COUNTY

BRICKMASON, MARBLE, TERRAZZO, AND TILE MASON (SOUTH) - That part of the county South of Roberts.

CARPENTERS & PILEDRIVERS (SOUTH) - That part of the county South of an East-West line between the Southwest corner of Iroquois County to Rt. 54 North of Gibson City.

COMMUNICATIONS TECHNICIAN (NORTH) - Rogers, Mona, Pella, and Brenton Townships.

ELECTRICIAN (SOUTH) - Sullivant, Peach Orchard, Lyman, Wall, Dix, Drummer, Patton, and Button.

ELECTRONIC SYSTEMS TECHNICIAN (SOUTH) - All townships EXCEPT Rogers, Mona, Pella, and Brenton Townships.

IRONWORKERS (NORTH) - That part of the county North of an East-West line including Melvin and Sibley.

TRUCK DRIVERS (NORTH) - That part of the county in the "neck" area North of Roberts.

The following list is considered as those days for which holiday rates of wages for work performed apply: New Years Day, Memorial Day, Fourth of July, Labor Day, Thanksgiving Day, Christmas Day and Veterans Day in some classifications/counties. Generally, any of these holidays which fall on a Sunday is celebrated on the following Monday. This then makes work performed on that Monday payable at the appropriate overtime rate for holiday pay. Common practice in a given local may alter certain days of celebration. If in doubt, please check with IDOL.

Oil and chip resealing (O&C) means the application of road oils and liquid asphalt to coat an existing road surface, followed by application of aggregate chips or gravel to coated surface, and subsequent rolling of material to seal the surface.

EXPLANATION OF CLASSES

ASBESTOS - GENERAL - removal of asbestos material/mold and hazardous materials from any place in a building, including mechanical systems where those mechanical systems are to be removed. This includes the removal of asbestos materials/mold and hazardous materials from ductwork or pipes in a building when the building is to be demolished at the time or at some close future date.

ASBESTOS - MECHANICAL - removal of asbestos material from mechanical systems, such as pipes, ducts, and boilers, where the mechanical systems are to remain.

COMMUNICATIONS TECHNICIAN - North

Installation, operation, inspection, maintenance, repair and service of radio, television, recording, voice, sound and vision production and reproduction, telephone and telephone interconnect, facsimile, equipment and appliances used for domestic, commercial, educational and entertainment purposes, pulling of wire through conduit but not the installation of conduit.

CERAMIC TILE FINISHER, MARBLE FINISHER, TERRAZZO FINISHER

Assisting, helping or supporting the tile, marble and terrazzo mechanic by performing their historic and traditional work assignments required to complete the proper installation of the work covered by said crafts. The term "Ceramic" is used for naming the classification only and is in no way a limitation of the product handled. Ceramic takes into consideration most hard tiles.

ELECTRONIC SYSTEMS TECHNICIAN - South

Installation, service and maintenance of low-voltage systems which utilizes the transmission and/or transference of voice, sound, vision, or digital for commercial, education, security and entertainment purposes for the following: TV monitoring and surveillance, background/foreground music, intercom and telephone interconnect, field programming, inventory control systems, microwave transmission, multi-media, multiplex, radio page, school, intercom and sound burglar alarms and low voltage master clock systems.

Excluded from this classification are energy management systems, life safety systems, supervisory controls and data acquisition systems not intrinsic with the above listed systems, fire alarm systems, nurse call systems and raceways exceeding fifteen feet in length.

LABORER, SKILLED - BUILDING

The skilled laborer building (BLD) classification shall encompass the following types of work, irrespective of the site of the work: caisson workers plus depth, gunnite nozzle men, lead man on sewer work, welders, cutters, burners and torchmen, chain saw operators, paving breaker, jackhammer and drill operators, layout man and/or drainage tile layer, steel form setters - street and highway, air tamping hammerman, signal man on crane, concrete saw operator, screenman on asphalt pavers, front end man on chip spreader, laborers tending masons with hot materials or where foreign materials are used, multiple concrete duct-leadman, luteman, asphalt raker, curb asphalt machine operator, ready mix scalemen (permanent, portable or temporary plant), laborers handling masterplate or similar materials, laser beam operator, concrete burning machine operator, coring machine operator, plaster tenders, underpinning and shoring of buildings, material selector when working with fire-brick or castable material, fire watch, signaling of all power equipment, and tree topper or trimmer when in connection with construction.

LABORER, SKILLED - HIGHWAY

The skilled laborer heavy and highway (HWY) classification shall encompass the following types of work, irrespective of the site of the work: handling of materials treated with oil, creosote, asphalt and/or any foreign materials harmful to skin or clothing, track laborers, chloride handlers, the unloading and loading with steel workers and re-bars, concrete workers (wet), tunnel helpers in free air, batch dumpers, mason tenders, kettle and tar men, plastic installers, scaffold workers, motorized buggies or motorized unit used for wet concrete or handling of building materials, laborers with de-watering systems, sewer workers plus depth, rod and chainmen, vibrator operators, mortar mixer operators, cement silica, clay, fly ash, lime and plasters, handlers (bulk or bag), cofferdam workers plus depth, on concrete paving, placing, cutting and tying or reinforcing, deck hand, dredge hand shore laborers, bankmen on floating plant, asphalt workers with machine, and layers, grade checker, power tools, stripping of all concrete forms excluding paving forms, dumpmen and spotters, when necessary, caisson workers plus depth, gunnite nozzle men, welders, cutters, burners and torchmen, chain saw operators, paving breaker, jackhammer and drill operators, layout man and/or drainage tile layer, steel form setters - street and highway, air tamping hammerman, signal man on crane, concrete saw operator, screedman on asphalt pavers, front end man on chip spreader, multiple concrete duct, luteman, asphalt raker, curb asphalt machine operator, ready mix scalemen (portable or temporary plant), laser beam operator, concrete burning machine operator, and coring machine operator.

TRUCK DRIVER - BUILDING, HEAVY AND HIGHWAY CONSTRUCTION - SOUTH

Class 1. Drivers on 2 axle trucks hauling less than 9 ton. Air compressor and welding machines and brooms, including those pulled by separate units, truck driver helpers, warehouse employees, mechanic helpers, greasers and tiremen, pickup trucks when hauling materials, tools, or workers to and from and on-the-job site, and fork lifts up to 6,000 lb. capacity.

Class 2. Two or three axle trucks hauling more than 9 ton but hauling less than 16 ton. A-frame winch trucks, hydrolift trucks, vector trucks or similar equipment when used for transportation purposes. Fork lifts over 6,000 lb. capacity, winch trucks, four axle combination units, and ticket writers.

Class 3. Two, three or four axle trucks hauling 16 ton or more. Drivers on water pulls, articulated dump trucks, mechanics and working forepersons, and dispatchers. Five axle or more combination units.

Class 4. Low Boy and Oil Distributors.

Class 5. Drivers who require special protective clothing while employed on hazardous waste work.

TRUCK DRIVER - BUILDING, HEAVY AND HIGHWAY CONSTRUCTION - NORTH

Class 1. Two or three Axle Trucks. A-frame Truck when used for transportation purposes; Air Compressors and Welding Machines, including those pulled by cars, pick-up trucks and tractors; Ambulances; Batch Gate Lockers; Batch Hopperman; Car and Truck Washers; Carry-alls; Fork Lifts and Hoisters; Helpers; Mechanics Helpers and Greasers; Oil Distributors 2-man operation; Pavement Breakers; Pole Trailer, up to 40 feet; Power Mower Tractors; Self-propelled Chip Spreader; Skipman; Slurry Trucks, 2-man operation; Slurry Truck Conveyor Operation, 2 or 3 man; Teamsters Unskilled

dumpman; and Truck Drivers hauling warning lights, barricades, and portable toilets on the job site.

Class 2. Four axle trucks; Dump Crets and Adgetors under 7 yards; Dumpsters, Track Trucks, Euclids, Hug Bottom Dump Turnapulls or Turnatrailers when pulling other than self-loading equipment or similar equipment under 16 cubic yards; Mixer Trucks under 7 yards; Ready-mix Plant Hopper Operator, and Winch Trucks, 2 Axles.

Class 3. Five axle trucks; Dump Crets and Adgetors 7 yards and over; Dumpsters, Track Trucks, Euclids, Hug Bottom Dump Turnatrailers or turnapulls when pulling other than self-loading equipment or similar equipment over 16 cubic yards; Explosives and/or Fission Material Trucks; Mixer Trucks 7 yards or over; Mobile Cranes while in transit; Oil Distributors, 1-man operation; Pole Trailer, over 40 feet; Pole and Expandable Trailers hauling material over 50 feet long; Slurry trucks, 1-man operation; Winch trucks, 3 axles or more; Mechanic--Truck Welder and Truck Painter.

Class 4. Six axle trucks; Dual-purpose vehicles, such as mounted crane trucks with hoist and accessories; Foreman; Master Mechanic; Self-loading equipment like P.B. and trucks with scoops on the front.

TRUCK DRIVER - OIL AND CHIP RESEALING ONLY.

This shall encompass laborers, workers and mechanics who drive contractor or subcontractor owned, leased, or hired pickup, dump, service, or oil distributor trucks. The work includes transporting materials and equipment (including but not limited to, oils, aggregate supplies, parts, machinery and tools) to or from the job site; distributing oil or liquid asphalt and aggregate; stock piling material when in connection with the actual oil and chip contract. The Truck Driver (Oil & Chip Resealing) wage classification does not include supplier delivered materials.

OPERATING ENGINEERS - BUILDING, HEAVY AND HIGHWAY CONSTRUCTION

Class 1. Power Cranes, Draglines, Derricks, Shovels, Gradalls, Mechanics, Tractor Highlift, Tournadozer, Concrete Mixers with Skip, Tournamixer, Two Drum Machine, One Drum Hoist with Tower or Boom, Cableways, Tower Machines, Motor Patrol, Boom Tractor, Boom or Winch Truck, Winch or Hydraulic Boom Truck, Truck Crane, Tournapull, Tractor Operating Scoops, Bulldozer, Push Tractor, Asphalt Planer, Finishing Machine on Asphalt, Large Rollers on Earth, Rollers on Asphalt Mix, Ross Carrier or similar Machine, Gravel Processing Machine, Asphalt Plant Engineer, Paver Operator, Dredging Equipment, or Dredge Engineer, or Dredge Operator, Central Mix Plant Engineer, CMI or similar type machine, Concrete Pump, Truck or Skid Mounted, Tower Crane, Engineer or Rock Crusher Plant, Concrete Plant Engineer, Ditching Machine with dual attachment, Tractor Mounted Loaders, Cherry Picker, Hydro Crane, Standard or Dinkey Locomotives, Scoopmobiles, Euclid Loader, Soil Cement Machine, Back Filler, Elevating Machine, Power Blade, Drilling Machine, including Well Testing, Caissons, Shaft or any similar type drilling machines, Motor Driven Paint Machine, Pipe Cleaning Machine, Pipe Wrapping Machine, Pipe Bending Machine, Apsco Paver, Boring Machine, (Head Equipment Greaser), Barber-Greene Loaders, Formless Paver, (Well Point System), Concrete Spreader, Hydra Ax, Span Saw, Marine Scoops, Brush Mulcher, Brush Burner, Mesh Placer, Tree Mover, Helicopter Crew (3), Piledriver-Skid or Crawler, Stump Remover, Root Rake, Tug Boat Operator, Refrigerating Machine, Freezing Operator, Chair Cart-Self-Propelled, Hydra Seeder, Straw Blower, Power Sub Grader, Bull Float, Finishing Machine, Self-Propelled Pavement Breaker, Lull (or similar type Machine), Two Air Compressors, Compressors hooked in

Manifold, Overhead Crane, Chip Spreader, Mud Cat, Sull-Air, Fork Lifts (except when used for landscaping work), Soil Stabilizer (Seaman Tiller, Bo Mag, Rago Gator, and similar types of equipment), Tube Float, Spray Machine, Curing Machine, Concrete or Asphalt Milling Machine, Snooper Truck-Operator, Backhoe, Farm Tractors (with attachments), 4 Point Lift System (Power Lift or similar type), Skid-Steer (Bob Cat or similar type), Wrecking Shears, Water Blaster.

Class 2. Concrete Mixers without Skips, Rock Crusher, Ditching Machine under 6', Curbing Machine, One Drum Machines without Tower or Boom, Air Tugger, Self-Propelled Concrete Saw, Machine Mounted Post Hole Digger, two to four Generators, Water Pumps or Welding Machines, within 400 feet, Air Compressor 600 cu. ft. and under, Rollers on Aggregate and Seal Coat Surfaces, Fork Lift (when used for landscaping work), Concrete and Blacktop Curb Machine, One Water Pump, Oilers, Air Valves or Steam Valves, One Welding Machine, Truck Jack, Mud Jack, Gunnite Machine, House Elevators when used for hoisting material, Engine Tenders, Fireman, Wagon Drill, Flex Plane, Conveyor, Siphons and Pulsometer, Switchman, Fireman on Paint Pots, Fireman on Asphalt Plants, Distributor Operator on Trucks, Tampers, Self-Propelled Power Broom, Striping Machine (motor driven), Form Tamper, Bulk Cement Plant, Equipment Greaser, Deck Hands, Truck Crane Oiler-Driver, Cement Blimps, Form Grader, Temporary Heat, Throttle Valve, Super Sucker (and similar type of equipment).

Other Classifications of Work:

For definitions of classifications not otherwise set out, the Department generally has on file such definitions which are available. If a task to be performed is not subject to one of the classifications of pay set out, the Department will upon being contacted state which neighboring county has such a classification and provide such rate, such rate being deemed to exist by reference in this document. If no neighboring county rate applies to the task, the Department shall undertake a special determination, such special determination being then deemed to have existed under this determination. If a project requires these, or any classification not listed, please contact IDOL at 217-782-1710 for wage rates or clarifications.

LANDSCAPING

Landscaping work falls under the existing classifications for laborer, operating engineer and truck driver. The work performed by landscape plantsman and landscape laborer is covered by the existing classification of laborer. The work performed by landscape operators (regardless of equipment used or its size) is covered by the classifications of operating engineer. The work performed by landscape truck drivers (regardless of size of truck driven) is covered by the classifications of truck driver.

Franklin County Prevailing Wage for May 2013

(See explanation of column headings at bottom of wages)

Trade Name	RG	TYP	C	Base	FRMAN	M-F>8	OSA	OSH	H/W	Pensn	Vac	Trng
=====	==	===	=	=====	=====	=====	===	===	=====	=====	=====	=====
ASBESTOS ABT-GEN		ALL		25.300	25.750	1.5	1.5	2.0	5.750	10.35	0.000	0.900
ASBESTOS ABT-MEC		BLD		21.150	22.150	1.5	1.5	2.0	6.400	5.150	0.000	0.650
BOILERMAKER		BLD		31.500	34.000	1.5	1.5	2.0	7.070	18.73	1.000	0.350
BRICK MASON		BLD		28.620	30.120	1.5	1.5	2.0	8.200	7.030	0.000	0.430
CARPENTER		BLD		31.890	33.390	1.5	1.5	2.0	6.550	6.750	0.000	0.400
CARPENTER		HWY		31.840	33.340	1.5	1.5	2.0	6.550	6.750	0.000	0.400

CEMENT MASON	BLD	28.200	29.700	1.5	1.5	2.0	6.600	5.400	0.000	0.500
CEMENT MASON	HWY	27.290	28.290	1.5	1.5	2.0	6.600	5.160	0.000	0.400
CERAMIC TILE FNSHER	BLD	27.120	0.000	1.5	1.5	2.0	8.200	7.030	0.000	0.430
ELECTRIC PWR EQMT OP	ALL 1	35.570	0.000	1.5	1.5	2.0	5.000	9.960	0.000	0.360
ELECTRIC PWR EQMT OP	ALL 2	31.740	0.000	1.5	1.5	2.0	5.000	8.880	0.000	0.320
ELECTRIC PWR GRNDMAN	ALL	26.100	0.000	1.5	1.5	2.0	5.000	7.310	0.000	0.260
ELECTRIC PWR LINEMAN	ALL	44.630	47.650	1.5	1.5	2.0	5.000	12.50	0.000	0.450
ELECTRICIAN	ALL	39.350	41.600	1.5	1.5	2.0	6.140	9.440	0.000	0.790
ELECTRONIC SYS TECH	BLD	32.570	34.320	1.5	1.5	2.0	6.000	4.240	0.000	0.400
FLOOR LAYER	BLD	29.330	30.080	1.5	1.5	2.0	6.550	6.750	0.000	0.400
GLAZIER	BLD	26.780	28.030	1.5	1.5	2.0	6.120	5.200	0.000	0.300
HT/FROST INSULATOR	BLD	29.450	30.450	1.5	1.5	2.0	5.050	9.730	0.000	0.280
IRON WORKER	ALL	27.020	28.270	1.5	1.5	2.0	7.010	9.200	0.000	0.345
LABORER	BLD	25.300	25.750	1.5	1.5	2.0	5.750	10.35	0.000	0.800
LABORER	HWY	25.300	25.750	1.5	1.5	2.0	5.750	10.35	0.000	0.800
LABORER	O&C	17.740	18.190	1.5	1.5	2.0	5.450	8.450	0.000	0.800
MACHINIST	BLD	43.550	46.050	1.5	1.5	2.0	6.130	8.950	1.850	0.000
MARBLE FINISHERS	BLD	27.120	0.000	1.5	1.5	2.0	8.200	7.030	0.000	0.430
MARBLE MASON	BLD	28.620	30.120	1.5	1.5	2.0	8.200	7.030	0.000	0.430
MILLWRIGHT	BLD	31.890	33.390	1.5	1.5	2.0	6.550	6.750	0.000	0.400
MILLWRIGHT	HWY	31.840	33.340	1.5	1.5	2.0	6.550	6.750	0.000	0.400
OE RIVER 1	RIV 1	33.550	34.550	1.5	1.5	2.0	7.000	8.800	0.000	1.450
OE RIVER 2	RIV 2	30.100	34.550	1.5	1.5	2.0	7.000	8.800	0.000	1.450
OPERATING ENGINEER	ALL 1	33.450	34.450	1.5	1.5	2.0	7.000	8.800	0.000	1.450
OPERATING ENGINEER	ALL 2	31.550	34.450	1.5	1.5	2.0	7.000	8.800	0.000	1.450
OPERATING ENGINEER	ALL 3	24.150	34.450	1.5	1.5	2.0	7.000	8.800	0.000	1.450
OPERATING ENGINEER	ALL 4	21.400	27.800	1.5	1.5	2.0	5.650	6.100	0.000	1.100
OPERATING ENGINEER	O&C 1	25.090	26.090	1.5	1.5	2.0	7.000	8.800	0.000	1.450
OPERATING ENGINEER	O&C 2	23.660	26.090	1.5	1.5	2.0	7.000	8.800	0.000	1.450
OPERATING ENGINEER	O&C 3	18.120	26.090	1.5	1.5	2.0	7.000	8.800	0.000	1.450
OPERATING ENGINEER	O&C 4	16.050	21.100	1.5	1.5	2.0	5.650	6.100	0.000	1.100
PAINTER	BLD	26.260	27.760	1.5	1.5	2.0	6.630	7.070	0.000	0.500
PAINTER	HWY	30.560	32.060	1.5	1.5	2.0	6.630	7.070	0.000	0.500
PAINTER OVER 30FT	BLD	27.260	28.760	1.5	1.5	2.0	6.630	7.070	0.000	0.500
PAINTER PWR EQMT	BLD	27.260	28.760	1.5	1.5	2.0	6.630	7.070	0.000	0.500
PAINTER PWR EQMT	HWY	31.560	33.060	1.5	1.5	2.0	6.630	7.070	0.000	0.500
PILEDRIVER	BLD	31.890	33.390	1.5	1.5	2.0	6.550	6.750	0.000	0.400
PILEDRIVER	HWY	31.840	33.340	1.5	1.5	2.0	6.550	6.750	0.000	0.400
PIPEFITTER	BLD	37.000	40.700	1.5	1.5	2.0	8.500	9.300	0.000	1.350
PLASTERER	BLD	28.200	29.700	1.5	1.5	2.0	6.600	5.400	0.000	0.500
PLUMBER	BLD	37.000	40.700	1.5	1.5	2.0	8.500	9.300	0.000	1.350
ROOFER	BLD	23.900	24.900	1.5	1.5	2.0	8.650	3.800	0.000	0.000
SHEETMETAL WORKER	ALL	31.690	33.190	1.5	1.5	2.0	7.130	6.730	1.910	0.360
SPRINKLER FITTER	BLD	36.390	39.140	1.5	1.5	2.0	8.420	8.500	0.000	0.450
STONE MASON	BLD	28.620	30.120	1.5	1.5	2.0	8.200	7.030	0.000	0.430
TERRAZZO FINISHER	BLD	27.120	0.000	1.5	1.5	2.0	8.200	7.030	0.000	0.430
TERRAZZO MASON	BLD	28.620	30.120	1.5	1.5	2.0	8.200	7.030	0.000	0.430
TRUCK DRIVER	ALL 1	30.070	0.000	1.5	1.5	2.0	10.30	6.100	0.000	0.250
TRUCK DRIVER	ALL 2	30.520	0.000	1.5	1.5	2.0	10.30	6.100	0.000	0.250
TRUCK DRIVER	ALL 3	30.740	0.000	1.5	1.5	2.0	10.30	6.100	0.000	0.250
TRUCK DRIVER	ALL 4	31.030	0.000	1.5	1.5	2.0	10.30	6.100	0.000	0.250
TRUCK DRIVER	ALL 5	31.850	0.000	1.5	1.5	2.0	10.30	6.100	0.000	0.250
TRUCK DRIVER	O&C 1	22.750	0.000	1.5	1.5	2.0	2.920	6.700	0.000	0.250
TRUCK DRIVER	O&C 2	19.150	0.000	1.5	1.5	2.0	2.920	6.700	0.000	0.250
TRUCK DRIVER	O&C 3	19.650	0.000	1.5	1.5	2.0	2.920	6.700	0.000	0.250
TUCKPOINTER	BLD	28.620	30.120	1.5	1.5	2.0	8.200	7.030	0.000	0.430

Legend:

RG (Region)

TYP (Trade Type - All,Highway,Building,Floating,Oil & Chip,Rivers)

C (Class)

Base (Base Wage Rate)

FRMAN (Foreman Rate)

M-F>8 (OT required for any hour greater than 8 worked each day, Mon through Fri.)

OSA (Overtime (OT) is required for every hour worked on Saturday)

OSH (Overtime is required for every hour worked on Sunday and Holidays)

H/W (Health & Welfare Insurance)

Pensn (Pension)

Vac (Vacation)

Trng (Training)

Explanations

FRANKLIN COUNTY

The following list is considered as those days for which holiday rates of wages for work performed apply: New Years Day, Memorial Day, Fourth of July, Labor Day, Thanksgiving Day, Christmas Day and Veterans Day in some classifications/counties. Generally, any of these holidays which fall on a Sunday is celebrated on the following Monday. This then makes work performed on that Monday payable at the appropriate overtime rate for holiday pay. Common practice in a given local may alter certain days of celebration. If in doubt, please check with IDOL.

Oil and Chip Resealing (O&C) means the application of road oils and liquid asphalt to coat an existing road surface, followed by application of aggregate chips or gravel to coated surface, and subsequent rolling of material to seal the surface.

EXPLANATION OF CLASSES

ASBESTOS - GENERAL - removal of asbestos material/mold and hazardous materials from any place in a building, including mechanical systems where those mechanical systems are to be removed. This includes the removal of asbestos materials/mold and hazardous materials from ductwork or pipes in a building when the building is to be demolished at the time or at some close future date.

ASBESTOS - MECHANICAL - removal of asbestos material from mechanical systems, such as pipes, ducts, and boilers, where the mechanical systems are to remain.

CERAMIC TILE FINISHER, MARBLE FINISHER, TERRAZZO FINISHER

Assisting, helping or supporting the tile, marble and terrazzo mechanic by performing their historic and traditional work assignments required to complete the proper installation of the work covered by said crafts. The term "Ceramic" is used for naming the classification only, and is in no a limitation of the product handled. Ceramic takes into consideration most hard tiles.

LABORER - OIL AND CHIP RESEALING ONLY

Hook and unhook chip box from aggregate truck; distribute material within chip box; perform flagging work related to oil and chip resealing; hand spray oil fluids; handle traffic control, including setting-up and maintaining barricades, drums, cones, delineators, signs and other such items, as well as laying-out and applying or removing temporary roadway markings used to control traffic in job site related to oil and chip resealing; and perform clean-up related to oil and chip resealing.

ELECTRIC POWER LINEMAN

Construction, maintenance and dismantling of overhead and underground electric power lines, including high voltage pipe type cable work, and associated structures and equipment.

ELECTRIC POWER EQUIPMENT OPERATOR - CLASS 1

Operation of all crawler type equipment D-4 and larger from the ground to assist the Electric Power Linemen in performing their duties.

ELECTRIC POWER EQUIPMENT OPERATORS - CLASS 2

Operation of all other equipment from the ground to assist the Electric Power Linemen in performing their duties.

ELECTRIC POWER GROUNDMAN

Applies to workers who assist the Electric Power Lineman from the ground.

ELECTRONIC SYSTEMS TECHNICIAN

Installation, service and maintenance of low-voltage systems which utilizes the transmission and/or transference of voice, sound, vision, or digital for commercial, education, security and entertainment purposes for the following: TV monitoring and surveillance, background/foreground music, intercom and telephone interconnect, field programming, inventory control systems, microwave transmission, multi-media, multiplex, radio page, school, intercom and sound burglar alarms and low voltage master clock systems.

Excluded from this classification are energy management systems, life safety systems, supervisory controls and data acquisition systems not intrinsic with the above listed systems, fire alarm systems, nurse call systems and raceways exceeding fifteen feet in length.

TRUCK DRIVER - BUILDING, HEAVY AND HIGHWAY CONSTRUCTION

Class 1. Drivers on 2 axle trucks hauling less than 9 ton. Air compressor and welding machines and brooms, including those pulled by separate units, truck driver helpers, warehouse employees, mechanic helpers, greasers and tiremen, pickup trucks when hauling materials, tools, or workers to and from and on-the-job site, and fork lifts up to 6,000 lb. capacity.

Class 2. Two or three axle trucks hauling more than 9 ton but hauling less than 16 ton. A-frame winch trucks, hydrolift trucks, vector trucks or similar equipment when used for transportation purposes. Fork lifts over 6,000 lb. capacity, winch trucks, four axle combination units, and ticket writers.

Class 3. Two, three or four axle trucks hauling 16 ton or more. Drivers on water pulls, articulated dump trucks, mechanics and working forepersons, and dispatchers. Five axle or more combination units.

Class 4. Low Boy and Oil Distributors.

Class 5. Drivers who require special protective clothing while employed on hazardous waste work.

TRUCK DRIVER - O & C - (Oil and Chip Resealing)

It involves driving of contractor or subcontractor owned, leased, or hired pickup, dump, service, or oil distributor trucks. Includes transporting materials and equipment (including, but not limited to oils, aggregate supplies, parts, machinery and tools) to or from the job site; distributing oil or liquid asphalt and aggregate; stock piling material; and maintaining trucks at job site related to oil and chip resealing.

Class 1. Distributors, liquid asphalt hauling and hauling of asphalt rubber-tired rollers.

Class 2. Stockpiling.

Class 3. Tandem hauling to job site.

OPERATING ENGINEERS - BUILDING, HEAVY AND HIGHWAY CONSTRUCTION

Class 1. APSCO or Equal Spreading Machine, Backhoe, Backfiller, Boom or Winch Cat, Bituminous Mixplane Machine, Blacksmith, Bituminous Surfacing Machine, Bull-Dozer, Crane, Shovel, Dragline, Truck Crane, Pile Driver, Concrete Breaker, Concrete or Pumpcrete Pumps, Dinky or Standard Locomotives, Well or Caisson Drills, Elevating Grader, Fork Lifts, Flexplane, Gradeall, Hi-Lift Hoists, Guy-Derricks, Hysters, Mechanic Motor Patrol, Mixers-21 cu. ft. or over, Push Cats, Pulls and Scrapers, Two Well Point Pumps, Pulverizer or Tiller, PugMill, Rubber-Tired Farm Type Tractor with Bulldozer/Blade/Auger or hi-lift over 1/2 yd., Jersey Spreader, Tract-Air used with Drill or Hi-Lift, Trenching or Ditching Machines, Wood Chipper w/Tractor, Self-Propelled Roller w/Blade, Equipment Greaser, Self-Propelled Bump Grinder on Concrete pavement, Boat Operator, Skid-Loaders, Tuggers, Lazer Screed, and Self-Propelled Chip Spreader (when others run conveyors).

Class 2. Any type tractor pulling any type roller or disc, Two Air Compressors (220 cu. ft. capacity or over), Two AirTract Drills, Air-Track Drill w/Compressor, Automatic Bins or Scales w/Compressor or Generator, Pipeline Boring Machine, Bulk Cement Plant w/Separate Compressor, Power Operated Bull Float, Hydra-Lift w/Single Motor, Straw Mulcher Blower w/Spout, Self-Propelled Roller/Compactor, Back-End man on Bituminous Surfacing Machine, oiler on milling machine.

Class 3. Air Compressor w/Valve driving piling, Boom or Winch Type Truck, Two Conveyors, Self-Propelled Concrete Saw, Form Grader, Truck Crane Oiler, Self-Propelled Vibrator, Rubber Tired Farm Type Tractor w/Blade/Bulldozer/Auger/hi-lift - 1/2 yd. or less, Elevator Operator, Man Lift (scissor lift) when lifting materials.

Class 4. Air-Track Drill (one), Belt Drag Machine, Power Broom, Mechanical Plasterer Applicator, Trac-Air, Air Compressor (220 cu. ft. or over) One, Air Compressor (under 220 cu. ft) four, Automatic Bin, Bulk Cement Plant w/Built-in Compressor running off same motor or electric motor, Fireman or Switchman, Self-Propelled Form Tamper, Light Plants (4), Welding Machines (4), Pumps (4), or Combination of four (4) Pumps, Light Plants, Welding Machines, Air-Compressors (under 220 cu. ft.), Mudjacks or Wood Chipper, Mixers - less than 21 cu. ft. Mortar Mixer w/Skip or Pump, Pipeline Tract Jack. One Operating Engineer may operate and maintain any combination of the following pieces of equipment, not to exceed four (4) which shall be within a reasonable distance, such combination may include any

equipment in this classification: (Compressors, Light Plants, Generators, Welding Machines, Pumps or Conveyors), One Well- Point Pump, Two Motor Driven Heaters, One Air Compressor (under 220 cu. ft.), One Engine-Driven Conveyor, One Motor Driven Heater, One Light Plant, One Pump, One Welding Machine, One Ulmac or Equal Spreader, Oilers, and one Generator 10 kw or greater.

OPERATING ENGINEER - O & C (Oil and Chip Resealing ONLY.)

Includes the operation of all motorized heavy equipment used in oil and chip resealing, including but not limited to operating self-propelled chip spreaders, and all types of rollers (both hard and rubber tired); and other duties pertaining to the operation or maintenance of heavy equipment related to oil and chip resealing.

Class 1. See Class 1 above for types of equipment operated.

Class 2. See Class 2 above for types of equipment operated.

Class 3. See Class 3 above for types of equipment operated.

Class 4. See Class 4 above for types of equipment operated.

OPERATING ENGINEER RIVER WORK 1 - operate the following machines when working on River Work and Levee Work on the Mississippi and Ohio Rivers, Lakes and Tributaries: Crane, Shovel, Drageline, Scrapers, Dredge, Derrick, Pile-Driver, Push Boat, all power boat operators, Mechanic, Engineman on Dredge, Leverman on Dredge, All Bituminous Spreader machines, Backhoe, Backfiller, Boom, or Winch Cat, Bituminous Mixplane Machine, Blacksmith, Bituminous Surfacing Machine, Bulldozer, Truck Cranes, Hydraulic Truck Mounted Boom/Crane, Concrete Finishing Machine, or Spreader Machine, Concrete Breaker, Concrete or Pumpcrete Machines, Concrete Plant Operator, All Off Road Material Hauling Equipment, Dinky or Standard Locomotives, Well Drill, Elevating Grader, Fork-Lifts, Flexplane, Gradeall, Hi-Lift, Power Handblade Tugger type Hoist, Hoist Two Drum (or over one), Gyderrick, Hyster, Motor Patrol, Mixers - 21 Cu. Ft. or over, Push Cat, Pulls, & Scrapers, Pumps-Two Well Points, Equipment Greaser, P & H Pulverizer or Pulverizer equal to Pugmill, Pugmill, Rubber-Tired farm type tractor w/Bulldozer/Blade/Auger or Hi-Lift over ½ yard, Skimmer Scoops, Seaman Tiller, Jersey Spreader, Tract-Air used with Drill or Hi-Lift, Trenching or Ditching Machine, Wood Chipper w/Tractor, self-propelled roller w/Blade, Concrete Pumps and Small Equipment Operators.

OPERATING ENGINEER RIVER 2 - when working on River Work and Levee Work on the Mississippi and Ohio Rivers, Lakes and Tributaries shall be employed as the Oiler or Fireman on Crane, Dragline, Shovel, Dredge, Truck Crane, Pile Driver, Gradeall, Dinky or Standard Locomotive, Guy Derrick, Trenching Machine or Ditching Machine 80 H.P. and over, All Terrain (cherry-picker) with over 40 ton Lifting Capacity, Deck Oiler and Deckhands.

Other Classifications of Work:

For definitions of classifications not otherwise set out, the Department generally has on file such definitions which are available. If a task to be performed is not subject to one of the classifications of pay set out, the Department will upon being contacted state which neighboring county has such a classification and provide such rate, such rate being deemed to exist by reference in this document. If no neighboring county rate applies to the task, the Department shall undertake a special determination, such special determination being then deemed to have existed under this

determination. If a project requires these, or any classification not listed, please contact IDOL at 217-782-1710 for wage rates or clarifications.

LANDSCAPING

Landscaping work falls under the existing classifications for laborer, operating engineer and truck driver. The work performed by landscape plantsman and landscape laborer is covered by the existing classification of laborer. The work performed by landscape operators (regardless of equipment used or its size) is covered by the classifications of operating engineer. The work performed by landscape truck drivers (regardless of size of truck driven) is covered by the classifications of truck driver.

Fulton County Prevailing Wage for May 2013

(See explanation of column headings at bottom of wages)

Trade Name	RG	TYP	C	Base	FRMAN	M-F>8	OSA	OSH	H/W	Pensn	Vac	Trng
=====	==	===	=	=====	=====	=====	===	===	=====	=====	=====	=====
ASBESTOS ABT-GEN		BLD		25.820	26.570	1.5	1.5	2.0	7.550	11.50	0.000	0.800
ASBESTOS ABT-MEC		BLD		29.860	30.860	1.5	1.5	2.0	6.950	3.000	0.000	0.000
BOILERMAKER		BLD		35.010	38.010	2.0	2.0	2.0	7.070	13.83	0.000	0.300
BRICK MASON		BLD		32.060	33.560	1.5	1.5	2.0	7.700	9.130	0.000	0.560
CARPENTER		BLD		29.330	31.580	1.5	1.5	2.0	7.450	13.66	0.000	0.520
CARPENTER		HWY		30.820	33.070	1.5	1.5	2.0	7.450	13.94	0.000	0.520
CEMENT MASON	NW	ALL		25.030	26.530	1.5	1.5	2.0	5.750	11.50	0.000	0.500
CEMENT MASON	SE	BLD		27.090	28.840	1.5	1.5	2.0	8.140	13.55	0.000	0.500
CEMENT MASON	SE	HWY		28.280	29.780	1.5	1.5	2.0	8.140	13.93	0.000	0.500
CERAMIC TILE FNSHER		BLD		29.750	0.000	1.5	1.5	2.0	7.700	9.130	0.000	0.550
ELECTRIC PWR EQMT OP		ALL		35.440	0.000	1.5	1.5	2.0	5.000	10.98	0.000	0.270
ELECTRIC PWR GRNDMAN		ALL		24.320	0.000	1.5	1.5	2.0	5.000	7.540	0.000	0.180
ELECTRIC PWR LINEMAN		ALL		39.370	41.910	1.5	1.5	2.0	5.000	12.20	0.000	0.300
ELECTRIC PWR TRK DRV		ALL		25.510	0.000	1.5	1.5	2.0	5.000	7.920	0.000	0.190
ELECTRICIAN		BLD		34.820	37.320	1.5	1.5	2.0	5.350	10.08	0.000	0.400
ELECTRONIC SYS TECH		BLD		27.430	29.180	1.5	1.5	2.0	5.350	9.320	0.000	0.400
ELEVATOR CONSTRUCTOR		BLD		40.520	45.585	2.0	2.0	2.0	11.88	12.71	3.240	0.600
GLAZIER		BLD		30.770	32.770	1.5	1.5	2.0	9.700	7.700	0.000	1.250
HT/FROST INSULATOR		BLD		37.260	38.260	1.5	1.5	2.0	7.850	11.16	0.000	0.500
IRON WORKER		BLD		30.330	32.230	1.5	1.5	2.0	9.390	11.56	0.000	0.440
IRON WORKER		HWY		34.020	36.020	1.5	1.5	2.0	9.390	11.56	0.000	0.390
LABORER		BLD		25.820	26.570	1.5	1.5	2.0	7.550	11.50	0.000	0.800
LABORER		HWY		29.010	30.010	1.5	1.5	2.0	7.550	13.04	0.000	0.800
LATHER		BLD		29.330	31.580	1.5	1.5	2.0	7.450	13.66	0.000	0.520
MACHINERY MOVER		HWY		34.020	36.020	1.5	1.5	2.0	9.390	11.56	0.000	0.390
MACHINIST		BLD		43.550	46.050	1.5	1.5	2.0	6.130	8.950	1.850	0.000
MARBLE FINISHERS		BLD		29.750	0.000	1.5	1.5	2.0	7.700	9.130	0.000	0.550
MARBLE MASON		BLD		31.510	32.760	1.5	1.5	2.0	7.700	9.130	0.000	0.550
MILLWRIGHT		BLD		30.240	32.490	1.5	1.5	2.0	7.450	13.09	0.000	0.520
MILLWRIGHT		HWY		31.820	34.070	1.5	1.5	2.0	7.450	13.44	0.000	0.520
OPERATING ENGINEER		BLD	1	36.000	39.000	1.5	1.5	2.0	9.750	13.60	0.000	3.000
OPERATING ENGINEER		BLD	2	33.490	39.000	1.5	1.5	2.0	9.750	13.60	0.000	3.000
OPERATING ENGINEER		BLD	3	29.340	39.000	1.5	1.5	2.0	9.750	13.60	0.000	3.000
OPERATING ENGINEER		HWY	1	36.000	39.500	1.5	1.5	2.0	9.750	13.60	0.000	3.000
OPERATING ENGINEER		HWY	2	33.490	39.500	1.5	1.5	2.0	9.750	13.60	0.000	3.000
OPERATING ENGINEER		HWY	3	29.340	39.500	1.5	1.5	2.0	9.750	13.60	0.000	3.000
PAINTER		ALL		32.900	34.900	1.5	1.5	1.5	9.650	8.200	0.000	1.250
PILEDRIVER		BLD		29.830	32.080	1.5	1.5	2.0	7.450	13.66	0.000	0.520
PILEDRIVER		HWY		31.820	34.070	1.5	1.5	2.0	7.450	13.94	0.000	0.520
PIPEFITTER		BLD		37.400	41.510	1.5	1.5	2.0	7.000	11.63	0.000	1.060
PLASTERER		BLD		27.770	28.770	1.5	1.5	2.0	8.140	12.76	0.000	0.600
PLUMBER		BLD		33.570	36.590	1.5	1.5	2.0	7.000	13.31	0.000	0.900
ROOFER		BLD		28.580	30.010	1.5	1.5	2.0	8.450	7.220	0.000	0.250

SHEETMETAL WORKER	BLD	31.920	33.520	1.5	1.5	2.0	7.270	13.08	0.000	0.660
SIGN HANGER	HWY	34.020	36.020	1.5	1.5	2.0	9.390	11.56	0.000	0.390
SPRINKLER FITTER	BLD	36.390	39.140	1.5	1.5	2.0	8.420	8.500	0.000	0.450
STEEL ERECTOR	HWY	34.020	36.020	1.5	1.5	2.0	9.390	11.56	0.000	0.390
STONE MASON	BLD	32.060	33.560	1.5	1.5	2.0	7.700	9.130	0.000	0.560
TERRAZZO FINISHER	BLD	29.750	0.000	1.5	1.5	2.0	7.700	9.130	0.000	0.550
TERRAZZO MASON	BLD	31.510	32.760	1.5	1.5	2.0	7.700	9.130	0.000	0.550
TILE MASON	BLD	31.510	32.760	1.5	1.5	2.0	7.700	9.130	0.000	0.550
TRUCK DRIVER	ALL 1	31.230	0.000	1.5	1.5	2.0	10.30	4.840	0.000	0.250
TRUCK DRIVER	ALL 2	31.680	0.000	1.5	1.5	2.0	10.30	4.840	0.000	0.250
TRUCK DRIVER	ALL 3	31.890	0.000	1.5	1.5	2.0	10.30	4.840	0.000	0.250
TRUCK DRIVER	ALL 4	32.180	0.000	1.5	1.5	2.0	10.30	4.840	0.000	0.250
TRUCK DRIVER	ALL 5	33.020	0.000	1.5	1.5	2.0	10.30	4.840	0.000	0.250
TRUCK DRIVER	O&C 1	24.980	0.000	1.5	1.5	2.0	10.30	4.840	0.000	0.250
TRUCK DRIVER	O&C 2	25.340	0.000	1.5	1.5	2.0	10.30	4.840	0.000	0.250
TRUCK DRIVER	O&C 3	25.510	0.000	1.5	1.5	2.0	10.30	4.840	0.000	0.250
TRUCK DRIVER	O&C 4	25.740	0.000	1.5	1.5	2.0	10.30	4.840	0.000	0.250
TRUCK DRIVER	O&C 5	26.420	0.000	1.5	1.5	2.0	10.30	4.840	0.000	0.250
TUCKPOINTER	BLD	32.060	33.560	1.5	1.5	2.0	7.700	9.130	0.000	0.560

Legend :

RG (Region)

TYP (Trade Type - All,Highway,Building,Floating,Oil & Chip,Rivers)

C (Class)

Base (Base Wage Rate)

FRMAN (Foreman Rate)

M-F>8 (OT required for any hour greater than 8 worked each day, Mon through Fri.

OSA (Overtime (OT) is required for every hour worked on Saturday)

OSH (Overtime is required for every hour worked on Sunday and Holidays)

H/W (Health & Welfare Insurance)

Pensn (Pension)

Vac (Vacation)

Trng (Training)

Explanations

FULTON COUNTY

CEMENT MASONS (NORTHWEST) - That part of the county West of a North-South line West of Farmington and Canton and North of an East-West line North of Cuba.

The following list is considered as those days for which holiday rates of wages for work performed apply: New Years Day, Memorial Day, Fourth of July, Labor Day, Thanksgiving Day, Christmas Day and Veterans Day in some classifications/counties. Generally, any of these holidays which fall on a Sunday is celebrated on the following Monday. This then makes work performed on that Monday payable at the

appropriate overtime rate for holiday pay. Common practice in a given local may alter certain days of celebration. If in doubt, please check with IDOL.

Oil and chip resealing (O&C) means the application of road oils and liquid asphalt to coat an existing road surface, followed by application of aggregate chips or gravel to coated surface, and subsequent rolling of material to seal the surface.

EXPLANATION OF CLASSES

ASBESTOS - GENERAL - removal of asbestos material/mold and hazardous materials from any place in a building, including mechanical systems where those mechanical systems are to be removed. This includes the removal of asbestos materials/mold and hazardous materials from ductwork or pipes in a building when the building is to be demolished at the time or at some close future date.

ASBESTOS - MECHANICAL - removal of asbestos material from mechanical systems, such as pipes, ducts, and boilers, where the mechanical systems are to remain.

CERAMIC TILE FINISHER, MARBLE FINISHER, TERRAZZO FINISHER

Assisting, helping or supporting the tile, marble and terrazzo mechanic by performing their historic and traditional work assignments required to complete the proper installation of the work covered by said crafts. The term "Ceramic" is used for naming the classification only and is in no way a limitation of the product handled. Ceramic takes into consideration most hard tiles.

ELECTRONIC SYSTEMS TECHNICIAN

Installation, service and maintenance of low-voltage systems which utilizes the transmission and/or transference of voice, sound, vision, or digital for commercial, education, security and entertainment purposes for the following: TV monitoring and surveillance, background/foreground music, intercom and telephone interconnect, field programming, inventory control systems, microwave transmission, multi-media, multiplex, radio page, school, intercom and sound burglar alarms and low voltage master clock systems.

Excluded from this classification are energy management systems, life safety systems, supervisory controls and data acquisition systems not intrinsic with the above listed systems, fire alarm systems, nurse call systems and raceways exceeding fifteen feet in length.

OPERATING ENGINEERS - BUILDING

Class 1. Cranes; Overhead Cranes; Gradall; All Cherry Pickers; Mechanics; Central Concrete Mixing Plant Operator; Road Pavers (27E - Dual Drum - Tri Batchers); Blacktop Plant Operators and Plant Engineers; 3 Drum Hoist; Derricks; Hydro Cranes; Shovels; Skimmer Scoops; Koehring Scooper; Drag Lines; Backhoe; Derrick Boats; Pile Drivers and Skid Rigs; Clamshells; Locomotive Cranes; Dredge (all types) Motor Patrol; Power Blades - Dumore - Elevating and similar types; Tower Cranes (Crawler-Mobile) and Stationary; Crane-type Backfiller; Drott Yumbo and similar types considered as Cranes; Caisson Rigs; Dozer; Tournadozer; Work Boats; Ross Carrier; Helicopter; Tournapulls - all and similar types; Scoops (all sizes); Pushcats; Endloaders (all types); Asphalt Surfacing Machine; Slip Form Paver; Rock Crusher; Heavy Equipment Greaser; CMI, CMI Belt Placer, Auto Grade & 3 Track and similar types; Side Booms; Multiple Unit Earth Movers; Creter Crane; Trench Machine; Pump-crete-Belt Crete-Squeeze Cretes-Screw-type Pumps and Gypsum; Bulker & Pump - Operator will clean; Formless Finishing Machine; Flaherty Spreader or

similar types; Screed Man on Laydown Machine; Wheel Tractors (industrial or Farm-type w/Dozer-Hoe-Endloader or other attachments); F.W.D. & Similar Types; Vermeer Concrete Saw.

Class 2. Dinkeys; Power Launches; PH One-pass Soil Cement Machine (and similar types); Pugmill with Pump; Backfillers; Euclid Loader; Forklifts; Jeeps w/Ditching Machine or other attachments; Tunneler; Automatic Cement and Gravel Batching Plants; Mobile Drills (Soil Testing) and similar types; Gurries and Similar Types; (1) and (2) Drum Hoists (Buck Hoist and Similar Types); Chicago Boom; Boring Machine & Pipe Jacking Machine; Hydro Boom; Dewatering System; Straw Blower; Hydro Seeder; Assistant Heavy Equipment Greaser on Spread; Tractors (Track type) without Power Unit pulling Rollers; Rollers on Asphalt -- Brick Macadem; Concrete Breakers; Concrete Spreaders; Mule Pulling Rollers; Center Stripper; Cement Finishing Machines & CMI Texture & Reel Curing Machines; Cement Finishing Machine; Barber Green or similar loaders; Vibro Tamper (All similar types) Self-propelled; Winch or Boom Truck; Mechanical Bull Floats; Mixers over 3 Bag to 27E; Tractor pulling Power Blade or Elevating Grader; Porter Rex Rail; Clary Screed; Truck Type Hoptoe Oilers; Fireman; Spray Machine on Paving; Curb Machines; Truck Crane Oilers; Oil Distributor; Truck-Mounted Saws.

Class 3. Air Compressor; Power Subgrader; Straight Tractor; Trac Air without attachments; Herman Nelson Heater, Dravo, Warner, Silent Glo, and similar types; Roller: Five (5) Ton and under on Earth or Gravel; Form Grader; Crawler Crane & Skid Rig Oilers; Freight Elevators - permanently installed; Pump; Light Plant; Generator; Conveyor (1) or (2) - Operator will clean; Welding Machine; Mixer (3) Bag and Under (Standard Capacity with skip); Bulk Cement Plant; Oiler on Central Concrete Mixing Plant.

OPERATING ENGINEERS - HEAVY AND HIGHWAY CONSTRUCTION

CLASS 1. Cranes; Hydro Cranes; Shovels; Crane Type Backfiller; Tower, Mobile, Crawler, & Stationary Cranes; Derricks; Hoists (3 Drum); Draglines; Drott Yumbo & Similar Types considered as Cranes; 360 Degree Swing Excavator (Shears, Grapples, Movacs, etc.); Back Hoe; Derrick Boats; Pile Driver and Skid Rigs; Clam Shell; Locomotive - Cranes; Road Pavers - Single Drum - Dual Drum - Tri Batcher; Motor Patrols & Power Blades - Dumore - Elevating & Similar Types; Mechanics; Central Concrete Mixing Plant Operator; Asphalt Batch Plant Operators and Plant Engineers; Gradall; Caisson Rigs; Skimmer Scoop - Koering Scooper; Dredges (all types); Hoptoe; All Cherry Pickers; Work Boat; Ross Carrier; Helicopter; Dozer; Tornadoer; Tournapulls - all and similar types; Operation of Concrete and all Recycle Machines; Multiple Unit Earth Movers; Scoops (all sizes); Pushcats; Endloaders (all types); Asphalt Surfacing Machine; Slip Form Paver; Rock Crusher; Operation of Material Crusher, Screening Plants, and Tunnel Boring Machine; Heavy Equipment Greaser (top greaser on spread); CMI, Auto Grade, CMI Belt Placer & 3 Track and Similar Types; Side Booms; Asphalt Heater & Planer Combination (used to plane streets); Wheel Tractors (with Dozer, Hoe or Endloader Attachments); CAT Earthwork Compactors and Similar Types; Blaw Knox Spreader and Similar Types; Trench Machines; Pump Crete - Belt Crete - Squeeze Crete - Screw Type Pumps and Gypsum (operator will clean); Creter Crane; Operation of Concrete Pump Truck; Formless Finishing Machines; Flaherty Spreader or Similar Types; Screed Man on Laydown Machine; Vermeer Concrete Saw; Operation of Laser Screed; Span Saw; Dredge Leverman; Dredge Engineer; Lull or Similar Type; Hydro-Boom Truck; Operation of Guard Rail Machine; and Starting Engineer on Pipeline or Construction (11 or more pieces) including: Air Compressor (Trailer Mounted), All Forced Air Heaters (regardless of Size), Water Pumps (Greater than 4-1/2" or Total Discharge Over 4-1/2"), Light Plants,

Generators (Trailer Mounted - Excluding Decontamination Trailer), Welding Machines (Any Size or Mode of Power), Conveyor, Mixer (any size), Stud Welder, Power Pac, etc, and Ground Heater (Trailer Mounted).

CLASS 2. Bulker & Pump; Power Launches; Boring Machine & Pipe Jacking Machine; Dinkeys; Operation of Carts, Powered Haul Unit for a Boring Machine; P & H One Pass Soil Cement Machines and Similar Types; Wheel Tractors (Industry or Farm Type - Other); Back Fillers; Euclid Loader; Fork Lifts; Jeep w/Ditching Machine or Other Attachments; Tunneluger; Automatic Cement & Gravel Batching Plants; Mobile Drills - Soil Testing and Similar Types; Pugmill with Pump; All (1) and (2) Drum Hoists; Dewatering System; Straw Blower; Hydro-Seeder; Bump Grinders (self-propelled); Assistant Heavy Equipment Greaser; Apsco Spreader; Tractors (Track-Type) without Power Units Pulling Rollers; Rollers on Asphalt - Brick or Macadam; Concrete Breakers; Concrete Spreaders; Cement Strippers; Cement Finishing Machines & CMI Texture & Reel Curing Machines; Vibro-Tampers (All Similar Types Self-Propelled); Mechanical Bull Floats; Self-Propelled Concrete Saws; Truck Mounted Power Saws; Operation of Curb Cutters; Mixers - Over Three (3) Bags; Winch and Boom Trucks; Tractor Pulling Power Blade or Elevating Grader; Porter Rex Rail; Clary Screed; Mule Pulling Rollers; Pugmill without Pump; Barber Greene or Similar Loaders; Track Type Tractor w/Power Unit attached (minimum); Fireman; Spray Machine on Paving; Curb Machines; Paved Ditch Machine; Power Broom; Self-Propelled Sweepers; Self-Propelled Conveyors; Power Subgrader; Oil Distributor; Straight Tractor; Truck Crane Oiler; Truck Type Oilers; Directional Boring Machine; Horizontal Directional Drill; Articulating End Dump Vehicles; Starting Engineer on Pipeline or Construction (6 -10 pieces) including: Air Compressor (Trailer Mounted), All Forced Air Heaters (regardless of Size), Water Pumps (Greater than 4-1/2" or Total Discharge Over 4-1/2"), Light Plants, Generators (Trailer Mounted - Excluding Decontamination Trailer), Welding Machines (Any Size or Mode of Power), Conveyor, Mixer (any size), Stud Welder, Power Pac, etc., and Ground Heater (Trailer Mounted).

CLASS 3. Straight Framed Truck Mounted Vac Unit (separately powered); Trac Air Machine (without attachments); Rollers - Five Ton and Under on Earth and Gravel; Form Graders; Bulk Cement Plant; Oilers; and Starting Engineer on Pipeline or Construction (3 - 5 pieces) including: Air Compressor (Trailer Mounted), All Forced Air Heaters (regardless of Size), Water Pumps (Greater than 4-1/2" or Total Discharge Over 4-1/2"), Light Plants, Generators (Trailer Mounted - Excluding Decontamination Trailer), Welding Machines (Any Size or Mode of Power), Conveyor, Mixer (any size), Stud Welder, Power Pac, etc., and Ground Heater (Trailer Mounted).

TRUCK DRIVER - BUILDING, HEAVY AND HIGHWAY CONSTRUCTION

Class 1. Drivers on 2 axle trucks hauling less than 9 ton. Air compressor and welding machines and brooms, including those pulled by separate units, truck driver helpers, warehouse employees, mechanic helpers, greasers and tiremen, pickup trucks when hauling materials, tools, or workers to and from and on-the-job site, and fork lifts up to 6,000 lb. capacity.

Class 2. Two or three axle trucks hauling more than 9 ton but hauling less than 16 ton. A-frame winch trucks, hydrolift trucks, vector trucks or similar equipment when used for transportation purposes. Fork lifts over 6,000 lb. capacity, winch trucks, four axle combination units, and ticket writers.

Class 3. Two, three or four axle trucks hauling 16 ton or more. Drivers on water pulls, articulated dump trucks, mechanics and working forepersons, and dispatchers. Five axle or more combination units.

Class 4. Low Boy and Oil Distributors.

Class 5. Drivers who require special protective clothing while employed on hazardous waste work.

TRUCK DRIVER - OIL AND CHIP RESEALING ONLY.

This shall encompass laborers, workers and mechanics who drive contractor or subcontractor owned, leased, or hired pickup, dump, service, or oil distributor trucks. The work includes transporting materials and equipment (including but not limited to, oils, aggregate supplies, parts, machinery and tools) to or from the job site; distributing oil or liquid asphalt and aggregate; stock piling material when in connection with the actual oil and chip contract. The Truck Driver (Oil & Chip Resealing) wage classification does not include supplier delivered materials.

Other Classifications of Work:

For definitions of classifications not otherwise set out, the Department generally has on file such definitions which are available. If a task to be performed is not subject to one of the classifications of pay set out, the Department will upon being contacted state which neighboring county has such a classification and provide such rate, such rate being deemed to exist by reference in this document. If no neighboring county rate applies to the task, the Department shall undertake a special determination, such special determination being then deemed to have existed under this determination. If a project requires these, or any classification not listed, please contact IDOL at 217-782-1710 for wage rates or clarifications.

LANDSCAPING

Landscaping work falls under the existing classifications for laborer, operating engineer and truck driver. The work performed by landscape plantsman and landscape laborer is covered by the existing classification of laborer. The work performed by landscape operators (regardless of equipment used or its size) is covered by the classifications of operating engineer. The work performed by landscape truck drivers (regardless of size of truck driven) is covered by the classifications of truck driver.

Gallatin County Prevailing Wage for May 2013

(See explanation of column headings at bottom of wages)

Trade Name	RG	TYP	C	Base	FRMAN	M-F>8	OSA	OSH	H/W	Pensn	Vac	Trng
=====	==	===	=	=====	=====	=====	===	===	=====	=====	=====	=====
ASBESTOS ABT-GEN		ALL		25.300	25.750	1.5	1.5	2.0	5.750	10.35	0.000	0.900
ASBESTOS ABT-MEC		BLD		21.150	22.150	1.5	1.5	2.0	6.400	5.150	0.000	0.650
BOILERMAKER		BLD		31.500	34.000	1.5	1.5	2.0	7.070	18.73	1.000	0.350
BRICK MASON		BLD		28.620	30.120	1.5	1.5	2.0	8.200	7.030	0.000	0.430
CARPENTER		BLD		31.890	33.390	1.5	1.5	2.0	6.550	6.750	0.000	0.400
CARPENTER		HWY		31.840	33.340	1.5	1.5	2.0	6.550	6.750	0.000	0.400
CEMENT MASON		BLD		28.200	29.700	1.5	1.5	2.0	6.600	5.400	0.000	0.500
CEMENT MASON		HWY		27.290	28.290	1.5	1.5	2.0	6.600	5.160	0.000	0.400
CERAMIC TILE FNSHER		BLD		27.120	0.000	1.5	1.5	2.0	8.200	7.030	0.000	0.430
ELECTRIC PWR EQMT OP		ALL	1	35.570	0.000	1.5	1.5	2.0	5.000	9.960	0.000	0.360
ELECTRIC PWR EQMT OP		ALL	2	31.740	0.000	1.5	1.5	2.0	5.000	8.880	0.000	0.320
ELECTRIC PWR GRNDMAN		ALL		26.100	0.000	1.5	1.5	2.0	5.000	7.310	0.000	0.260
ELECTRIC PWR LINEMAN		ALL		44.630	47.650	1.5	1.5	2.0	5.000	12.50	0.000	0.450
ELECTRICIAN		ALL		39.350	41.600	1.5	1.5	2.0	6.140	9.440	0.000	0.790
ELECTRONIC SYS TECH		BLD		32.570	34.320	1.5	1.5	2.0	6.000	4.240	0.000	0.400

FLOOR LAYER	BLD	29.330	30.080	1.5	1.5	2.0	6.550	6.750	0.000	0.400
GLAZIER	BLD	26.780	28.030	1.5	1.5	2.0	6.120	5.200	0.000	0.300
HT/FROST INSULATOR	BLD	29.450	30.450	1.5	1.5	2.0	5.050	9.730	0.000	0.280
IRON WORKER	ALL	27.020	28.270	1.5	1.5	2.0	7.010	9.200	0.000	0.345
LABORER	BLD	25.300	25.750	1.5	1.5	2.0	5.750	10.35	0.000	0.800
LABORER	HWY	25.300	25.750	1.5	1.5	2.0	5.750	10.35	0.000	0.800
LABORER	O&C	17.740	18.190	1.5	1.5	2.0	5.450	8.450	0.000	0.800
MACHINIST	BLD	43.550	46.050	1.5	1.5	2.0	6.130	8.950	1.850	0.000
MARBLE FINISHERS	BLD	27.120	0.000	1.5	1.5	2.0	8.200	7.030	0.000	0.430
MARBLE MASON	BLD	28.620	30.120	1.5	1.5	2.0	8.200	7.030	0.000	0.430
MILLWRIGHT	BLD	31.890	33.390	1.5	1.5	2.0	6.550	6.750	0.000	0.400
MILLWRIGHT	HWY	31.840	33.340	1.5	1.5	2.0	6.550	6.750	0.000	0.400
OE RIVER 1	RIV 1	33.550	34.550	1.5	1.5	2.0	7.000	8.800	0.000	1.450
OE RIVER 2	RIV 2	30.100	34.550	1.5	1.5	2.0	7.000	8.800	0.000	1.450
OPERATING ENGINEER	ALL 1	33.450	34.450	1.5	1.5	2.0	7.000	8.800	0.000	1.450
OPERATING ENGINEER	ALL 2	31.550	34.450	1.5	1.5	2.0	7.000	8.800	0.000	1.450
OPERATING ENGINEER	ALL 3	24.150	34.450	1.5	1.5	2.0	7.000	8.800	0.000	1.450
OPERATING ENGINEER	ALL 4	21.400	27.800	1.5	1.5	2.0	5.650	6.100	0.000	1.100
OPERATING ENGINEER	O&C 1	25.090	26.090	1.5	1.5	2.0	7.000	8.800	0.000	1.450
OPERATING ENGINEER	O&C 2	23.660	26.090	1.5	1.5	2.0	7.000	8.800	0.000	1.450
OPERATING ENGINEER	O&C 3	18.120	26.090	1.5	1.5	2.0	7.000	8.800	0.000	1.450
OPERATING ENGINEER	O&C 4	16.050	21.100	1.5	1.5	2.0	5.650	6.100	0.000	1.100
PAINTER	BLD	26.260	27.760	1.5	1.5	2.0	6.630	7.070	0.000	0.500
PAINTER	HWY	30.560	32.060	1.5	1.5	2.0	6.630	7.070	0.000	0.500
PAINTER OVER 30FT	BLD	27.260	28.760	1.5	1.5	2.0	6.630	7.070	0.000	0.500
PAINTER PWR EQMT	BLD	27.260	28.760	1.5	1.5	2.0	6.630	7.070	0.000	0.500
PAINTER PWR EQMT	HWY	31.560	33.060	1.5	1.5	2.0	6.630	7.070	0.000	0.500
PILEDRIIVER	BLD	31.890	33.390	1.5	1.5	2.0	6.550	6.750	0.000	0.400
PILEDRIIVER	HWY	31.840	33.340	1.5	1.5	2.0	6.550	6.750	0.000	0.400
PIPEFITTER	BLD	37.000	40.700	1.5	1.5	2.0	8.500	9.300	0.000	1.350
PLASTERER	BLD	28.200	29.700	1.5	1.5	2.0	6.600	5.400	0.000	0.500
PLUMBER	BLD	37.000	40.700	1.5	1.5	2.0	8.500	9.300	0.000	1.350
ROOFER	BLD	27.240	29.240	1.5	1.5	2.0	7.200	5.250	0.000	0.540
SHEETMETAL WORKER	ALL	31.690	33.190	1.5	1.5	2.0	7.130	6.730	1.910	0.360
SPRINKLER FITTER	BLD	36.390	39.140	1.5	1.5	2.0	8.420	8.500	0.000	0.450
STONE MASON	BLD	28.620	30.120	1.5	1.5	2.0	8.200	7.030	0.000	0.430
TERRAZZO FINISHER	BLD	27.120	0.000	1.5	1.5	2.0	8.200	7.030	0.000	0.430
TRUCK DRIVER	ALL 1	30.070	0.000	1.5	1.5	2.0	10.30	6.100	0.000	0.250
TRUCK DRIVER	ALL 2	30.520	0.000	1.5	1.5	2.0	10.30	6.100	0.000	0.250
TRUCK DRIVER	ALL 3	30.740	0.000	1.5	1.5	2.0	10.30	6.100	0.000	0.250
TRUCK DRIVER	ALL 4	31.030	0.000	1.5	1.5	2.0	10.30	6.100	0.000	0.250
TRUCK DRIVER	ALL 5	31.850	0.000	1.5	1.5	2.0	10.30	6.100	0.000	0.250
TRUCK DRIVER	O&C 1	22.750	0.000	1.5	1.5	2.0	2.920	6.700	0.000	0.250
TRUCK DRIVER	O&C 2	19.150	0.000	1.5	1.5	2.0	2.920	6.700	0.000	0.250
TRUCK DRIVER	O&C 3	19.650	0.000	1.5	1.5	2.0	2.920	6.700	0.000	0.250
TUCKPOINTER	BLD	28.620	30.120	1.5	1.5	2.0	8.200	7.030	0.000	0.430

Legend :

RG (Region)

TYP (Trade Type - All,Highway,Building,Floating,Oil & Chip,Rivers)

C (Class)

Base (Base Wage Rate)

FRMAN (Foreman Rate)

M-F>8 (OT required for any hour greater than 8 worked each day, Mon through Fri.)

OSA (Overtime (OT) is required for every hour worked on Saturday)

OSH (Overtime is required for every hour worked on Sunday and Holidays)

H/W (Health & Welfare Insurance)

Pensn (Pension)

Vac (Vacation)

Trng (Training)

Explanations

GALLATIN COUNTY

The following list is considered as those days for which holiday rates of wages for work performed apply: New Years Day, Memorial Day, Fourth of July, Labor Day, Thanksgiving Day, Christmas Day and Veterans Day in some classifications/counties. Generally, any of these holidays which fall on a Sunday is celebrated on the following Monday. This then makes work performed on that Monday payable at the appropriate overtime rate for holiday pay. Common practice in a given local may alter certain days of celebration. If in doubt, please check with IDOL.

Oil and chip resealing (O&C) means the application of road oils and liquid asphalt to coat an existing road surface, followed by application of aggregate chips or gravel to coated surface, and subsequent rolling of material to seal the surface.

EXPLANATION OF CLASSES

ASBESTOS - GENERAL - removal of asbestos material/mold and hazardous materials from any place in a building, including mechanical systems where those mechanical systems are to be removed. This includes the removal of asbestos materials/mold and hazardous materials from ductwork or pipes in a building when the building is to be demolished at the time or at some close future date.

ASBESTOS - MECHANICAL - removal of asbestos material from mechanical systems, such as pipes, ducts, and boilers, where the mechanical systems are to remain.

LABORER - OIL AND CHIP RESEALING ONLY

Hook and unhook chip box from aggregate truck; distribute material within chip box; perform flagging work related to oil and chip resealing; hand spray oil fluids; handle traffic control, including setting-up and maintaining barricades, drums, cones, delineators, signs and other such items, as well as laying-out and applying or removing temporary roadway markings used to control traffic in job site related to oil and chip resealing; and perform clean-up related to oil and chip resealing.

CERAMIC TILE FINISHER, MARBLE FINISHER, TERRAZZO FINISHER

Assisting, helping or supporting the tile, marble and terrazzo mechanic by performing their historic and traditional work assignments required to complete the proper installation of the work covered by said crafts. The term "Ceramic" is used for naming the classification only, and is in no a limitation of the product handled. Ceramic takes into consideration most hard tiles.

ELECTRIC POWER LINEMAN

Construction, maintenance and dismantling of overhead and underground electric power lines, including high voltage pipe type cable work, and associated structures and equipment.

ELECTRIC POWER EQUIPMENT OPERATOR - CLASS 1

Operation of all crawler type equipment D-4 and larger from the ground to assist the Electric Power Linemen in performing their duties.

ELECTRIC POWER EQUIPMENT OPERATORS - CLASS 2

Operation of all other equipment from the ground to assist the Electric Power Linemen in performing their duties.

ELECTRIC POWER GROUNDMAN

Applies to workers who assist the Electric Power Lineman from the ground.

ELECTRONIC SYSTEMS TECHNICIAN

Installation, service and maintenance of low-voltage systems which utilizes the transmission and/or transference of voice, sound, vision, or digital for commercial, education, security and entertainment purposes for the following: TV monitoring and surveillance, background/foreground music, intercom and telephone interconnect, field programming, inventory control systems, microwave transmission, multi-media, multiplex, radio page, school, intercom and sound burglar alarms and low voltage master clock systems.

Excluded from this classification are energy management systems, life safety systems, supervisory controls and data acquisition systems not intrinsic with the above listed systems, fire alarm systems, nurse call systems and raceways exceeding fifteen feet in length.

TRUCK DRIVER - BUILDING, HEAVY AND HIGHWAY CONSTRUCTION

Class 1. Drivers on 2 axle trucks hauling less than 9 ton. Air compressor and welding machines and brooms, including those pulled by separate units, truck driver helpers, warehouse employees, mechanic helpers, greasers and tiremen, pickup trucks when hauling materials, tools, or workers to and from and on-the-job site, and fork lifts up to 6,000 lb. capacity.

Class 2. Two or three axle trucks hauling more than 9 ton but hauling less than 16 ton. A-frame winch trucks, hydrolift trucks, vector trucks or similar equipment when used for transportation purposes. Fork lifts over 6,000 lb. capacity, winch trucks, four axle combination units, and ticket writers.

Class 3. Two, three or four axle trucks hauling 16 ton or more. Drivers on water pulls, articulated dump trucks, mechanics and working forepersons, and dispatchers. Five axle or more combination units.

Class 4. Low Boy and Oil Distributors.

Class 5. Drivers who require special protective clothing while employed on hazardous waste work.

TRUCK DRIVER - O & C (Oil and Chip Resealing ONLY)

It involves driving of contractor or subcontractor owned, leased, or hired pickup, dump, service, or oil distributor trucks. Includes transporting materials and equipment (including, but not limited to

oils, aggregate supplies, parts, machinery and tools) to or from the job site; distributing oil or liquid asphalt and aggregate; stock piling material; and maintaining trucks at job site related to oil and chip resealing.

Class 1. Distributors, liquid asphalt hauling and hauling of asphalt rubber-tired rollers.

Class 2. Stockpiling.

Class 3. Tandem hauling to job site.

OPERATING ENGINEERS - BUILDING, HEAVY AND HIGHWAY CONSTRUCTION

Class 1. APSCO or Equal Spreading Machine, Backhoe, Backfiller, Boom or Winch Cat, Bituminous Mixplane Machine, Blacksmith, Bituminous Surfacing Machine, Bull-Dozer, Crane, Shovel, Dragline, Truck Crane, Pile Driver, Concrete Breaker, Concrete or Pumpcrete Pumps, Dinky or Standard Locomotives, Well or Caisson Drills, Elevating Grader, Fork Lifts, Flexplane, Gradeall, Hi-Lift Hoists, Guy-Derricks, Hysters, Mechanic Motor Patrol, Mixers-21 cu. ft. or over, Push Cats, Pulls and Scrapers, Two Well Point Pumps, Pulverizer or Tiller, PugMill, Rubber-Tired Farm Type Tractor with Bulldozer/Blade/Auger or hi-lift over 1/2 yd., Jersey Spreader, Tract-Air used with Drill or Hi-Lift, Trenching or Ditching Machines, Wood Chipper w/Tractor, Self-Propelled Roller w/Blade, Equipment Greaser, Self-Propelled Bump Grinder on Concrete pavement, Boat Operator, Skid-Loaders, Tuggers, Lazer Screed, and Self-Propelled Chip Spreader (when others run conveyors).

Class 2. Any type tractor pulling any type roller or disc, Two Air Compressors (220 cu. ft. capacity or over), Two AirTract Drills, Air-Track Drill w/Compressor, Automatic Bins or Scales w/Compressor or Generator, Pipeline Boring Machine, Bulk Cement Plant w/Separate Compressor, Power Operated Bull Float, Hydra-Lift w/Single Motor, Straw Mulcher Blower w/Spout, Self-Propelled Roller/Compactor, Back-End man on Bituminous Surfacing Machine, oiler on milling machine.

Class 3. Air Compressor w/Valve driving piling, Boom or Winch Type Truck, Two Conveyors, Self-Propelled Concrete Saw, Form Grader, Truck Crane Oiler, Self-Propelled Vibrator, Rubber Tired Farm Type Tractor w/Blade/Bulldozer/Auger/hi-lift - 1/2 yd. or less, Elevator Operator, Man Lift (scissor lift) when lifting materials.

Class 4. Air-Track Drill (one), Belt Drag Machine, Power Broom, Mechanical Plasterer Applicator, Trac-Air, Air Compressor (220 cu. ft. or over) One, Air Compressor (under 220 cu. ft) four, Automatic Bin, Bulk Cement Plant w/Built-in Compressor running off same motor or electric motor, Fireman or Switchman, Self-Propelled Form Tamper, Light Plants (4), Welding Machines (4), Pumps (4), or Combination of four (4) Pumps, Light Plants, Welding Machines, Air-Compressors (under 220 cu. ft.), Mudjacks or Wood Chipper, Mixers - less than 21 cu. ft. Mortar Mixer w/Skip or Pump, Pipeline Tract Jack. One Operating Engineer may operate and maintain any combination of the following pieces of equipment, not to exceed four (4) which shall be within a reasonable distance, such combination may include any equipment in this classification: (Compressors, Light Plants, Generators, Welding Machines, Pumps or Conveyors), One Well- Point Pump, Two Motor Driven Heaters, One Air Compressor (under 220 cu. ft.), One Engine-Driven Conveyor, One Motor Driven Heater, One Light Plant, One Pump, One Welding Machine, One Ulmac or Equal Spreader, Oilers, and one Generator 10 kw or greater.

OPERATING ENGINEER - O & C (Oil and Chip Resealing ONLY). Includes the operation of all motorized heavy equipment used in oil and chip

rsealing, including but not limited to operating self-propelled chip spreaders, and all types of rollers (both hard and rubber tired); and other duties pertaining to the operation or maintenance of heavy equipment relatd to oil and chip resealing.

Class 1. See Class 1 above for types of equipment operated.

Class 2. See Class 2 above for types of equipment operated.

Class 3. See Class 3 above for types of equipment operated.

Class 4. See Class 4 above for types of equipment operated.

OPERATING ENGINEER RIVER WORK 1 - operate the following machines when working on River Work and Levee Work on the Mississippi and Ohio Rivers, Lakes and Tributaries: Crane, Shovel, Drageline, Scrapers, Dredge, Derrick, Pile-Driver, Push Boat, all power boat operators, Mechanic, Engineman on Dredge, Leverman on Dredge, All Bituminous Spreader machines, Backhoe, Backfiller, Boom, or Winch Cat, Bituminous Mixplane Machine, Blacksmith, Bituminous Surfacing Machine, Bulldozer, Truck Cranes, Hydraulic Truck Mounted Boom/Crane, Concrete Finishing Machine, or Spreader Machine, Concrete Breaker, Concrete or Pumpcrete Machines, Concrete Plant Operator, All Off Road Material Hauling Equipment, Dinky or Standard Locomotives, Well Drill, Elevating Grader, Fork-Lifts, Flexplane, Gradeall, Hi-Lift, Power Handblade Tugger type Hoist, Hoist Two Drum (or over one), Gyderrick, Hyster, Motor Patrol, Mixers - 21 Cu. Ft. or over, Push Cat, Pulls, & Scrapers, Pumps-Two Well Points, Equipment Greaser, P & H Pulverizer or Pulverizer equal to Pugmill, Pugmill, Rubber-Tired farm type tractor w/Bulldozer/Blade/Auger or Hi-Lift over ½ yard, Skimmer Scoops, Seaman Tiller, Jersey Spreader, Tract-Air used with Drill or Hi-Lift, Trenching or Ditching Machine, Wood Chipper w/Tractor, self-propelled roller w/Blade, Concrete Pumps and Small Equipment Operators.

OPERATING ENGINEER RIVER 2 - when working on River Work and Levee Work on the Mississippi and Ohio Rivers, Lakes and Tributaries shall be employed as the Oiler or Fireman on Crane, Dragline, Shovel, Dredge, Truck Crane, Pile Driver, Gradeall, Dinky or Standard Locomotive, Guy Derrick, Trenching Machine or Ditching Machine 80 H.P. and over, All Terrain (cherry-picker) with over 40 ton Lifting Capacity, Deck Oiler and Deckhands.

Other Classifications of Work:

For definitions of classifications not otherwise set out, the Department generally has on file such definitions which are available. If a task to be performed is not subject to one of the classifications of pay set out, the Department will upon being contacted state which neighboring county has such a classification and provide such rate, such rate being deemed to exist by reference in this document. If no neighboring county rate applies to the task, the Department shall undertake a special determination, such special determination being then deemed to have existed under this determination. If a project requires these, or any classification not listed, please contact IDOL at 217-782-1710 for wage rates or clarifications.

LANDSCAPING

Landscaping work falls under the existing classifications for laborer, operating engineer and truck driver. The work performed by landscape plantsman and landscape laborer is covered by the existing

classification of laborer. The work performed by landscape operators (regardless of equipment used or its size) is covered by the classifications of operating engineer. The work performed by landscape truck drivers (regardless of size of truck driven) is covered by the classifications of truck driver.

Greene County Prevailing Wage for May 2013

(See explanation of column headings at bottom of wages)

Trade Name	RG	TYP	C	Base	FRMAN	M-F>8	OSA	OSH	H/W	Pensn	Vac	Trng
=====	==	===	=	=====	=====	=====	===	===	=====	=====	=====	=====
ASBESTOS ABT-GEN		ALL		30.860	31.360	1.5	1.5	2.0	5.750	9.840	0.000	0.800
ASBESTOS ABT-MEC		BLD		29.860	30.860	1.5	1.5	2.0	6.950	3.000	0.000	0.000
BOILERMAKER		BLD		31.500	34.000	1.5	1.5	2.0	7.070	18.73	1.000	0.350
BRICK MASON		BLD		29.250	30.250	1.5	1.5	2.0	8.200	8.330	0.000	0.580
CARPENTER		BLD		27.670	29.920	1.5	1.5	2.0	7.450	14.58	0.000	0.520
CARPENTER		HWY		28.870	30.620	1.5	1.5	2.0	7.450	13.73	0.000	0.520
CEMENT MASON		ALL		31.000	32.000	1.5	1.5	2.0	9.250	11.75	0.000	0.200
CERAMIC TILE FNSHER		BLD		25.600	0.000	1.5	1.5	2.0	8.200	7.230	0.000	0.000
ELECTRIC PWR EQMT OP		ALL		36.690	44.520	1.5	2.0	2.0	5.000	9.170	0.000	0.280
ELECTRIC PWR GRNDMAN		ALL		24.940	44.520	1.5	2.0	2.0	5.000	6.240	0.000	0.190
ELECTRIC PWR LINEMAN		ALL		42.210	44.520	1.5	2.0	2.0	5.000	10.56	0.000	0.320
ELECTRIC PWR TRK DRV		ALL		25.560	44.520	1.5	2.0	2.0	5.000	6.390	0.000	0.190
ELECTRICIAN		ALL		36.400	38.650	1.5	1.5	2.0	7.500	9.090	0.000	0.550
ELECTRONIC SYS TECH		BLD		28.740	30.490	1.5	1.5	2.0	7.500	5.860	0.000	0.400
ELEVATOR CONSTRUCTOR		BLD		43.715	49.180	2.0	2.0	2.0	11.88	12.71	3.500	0.600
GLAZIER		BLD		32.780	0.000	2.0	2.0	2.0	9.020	10.80	2.630	0.310
HT/FROST INSULATOR		BLD		37.260	38.260	1.5	1.5	2.0	7.850	11.16	0.000	0.500
IRON WORKER		BLD		29.460	31.460	1.5	1.5	2.0	7.740	11.38	0.000	0.660
IRON WORKER		HWY		30.600	32.100	1.5	1.5	2.0	7.740	11.69	0.000	0.660
LABORER		ALL		30.360	30.860	1.5	1.5	2.0	5.750	9.840	0.000	0.800
LATHER		BLD		27.670	29.920	1.5	1.5	2.0	7.450	14.58	0.000	0.520
MACHINIST		BLD		43.550	46.050	1.5	1.5	2.0	6.130	8.950	1.850	0.000
MARBLE FINISHERS		BLD		25.600	0.000	1.5	1.5	2.0	8.200	7.230	0.000	0.000
MARBLE MASON		BLD		27.100	27.850	1.5	1.5	2.0	8.200	7.230	0.000	0.000
MILLWRIGHT		BLD		29.620	31.870	1.5	1.5	2.0	7.450	13.09	0.000	0.520
MILLWRIGHT		HWY		31.690	33.440	1.5	1.5	2.0	7.450	13.54	0.000	0.520
OPERATING ENGINEER		BLD	1	34.200	37.200	1.5	1.5	2.0	9.000	17.00	0.000	1.000
OPERATING ENGINEER		BLD	2	33.070	37.200	1.5	1.5	2.0	9.000	17.00	0.000	1.000
OPERATING ENGINEER		BLD	3	28.590	37.200	1.5	1.5	2.0	9.000	17.00	0.000	1.000
OPERATING ENGINEER		BLD	4	28.650	37.200	1.5	1.5	2.0	9.000	17.00	0.000	1.000
OPERATING ENGINEER		BLD	5	28.320	37.200	1.5	1.5	2.0	9.000	17.00	0.000	1.000
OPERATING ENGINEER		BLD	6	35.750	37.200	1.5	1.5	2.0	9.000	17.00	0.000	1.000
OPERATING ENGINEER		BLD	7	36.050	37.200	1.5	1.5	2.0	9.000	17.00	0.000	1.000
OPERATING ENGINEER		BLD	8	36.330	37.200	1.5	1.5	2.0	9.000	17.00	0.000	1.000
OPERATING ENGINEER		BLD	9	35.650	37.200	1.5	1.5	2.0	9.000	17.00	0.000	1.000
OPERATING ENGINEER		HWY	1	32.700	35.700	1.5	1.5	2.0	9.000	17.00	0.000	1.000
OPERATING ENGINEER		HWY	2	31.570	35.700	1.5	1.5	2.0	9.000	17.00	0.000	1.000
OPERATING ENGINEER		HWY	3	27.090	35.700	1.5	1.5	2.0	9.000	17.00	0.000	1.000
OPERATING ENGINEER		HWY	4	27.150	35.700	1.5	1.5	2.0	9.000	17.00	0.000	1.000
OPERATING ENGINEER		HWY	5	26.820	35.700	1.5	1.5	2.0	9.000	17.00	0.000	1.000
OPERATING ENGINEER		HWY	6	34.250	35.700	1.5	1.5	2.0	9.000	17.00	0.000	1.000
OPERATING ENGINEER		HWY	7	34.550	35.700	1.5	1.5	2.0	9.000	17.00	0.000	1.000
OPERATING ENGINEER		HWY	8	34.830	35.700	1.5	1.5	2.0	9.000	17.00	0.000	1.000
OPERATING ENGINEER		HWY	9	34.150	35.700	1.5	1.5	2.0	9.000	17.00	0.000	1.000
PAINTER		BLD		29.250	30.750	1.5	1.5	2.0	5.000	7.920	0.000	0.600
PAINTER		HWY		30.450	31.950	1.5	1.5	2.0	5.000	7.920	0.000	0.600
PAINTER OVER 30FT		BLD		30.250	31.750	1.5	1.5	2.0	5.000	7.920	0.000	0.600
PAINTER PWR EQMT		BLD		30.250	31.750	1.5	1.5	2.0	5.000	7.920	0.000	0.600
PAINTER PWR EQMT		HWY		31.450	32.950	1.5	1.5	2.0	5.000	7.920	0.000	0.600
PILEDRIIVER		BLD		28.170	30.420	1.5	1.5	2.0	7.450	14.58	0.000	0.520
PILEDRIIVER		HWY		29.870	31.620	1.5	1.5	2.0	7.450	13.73	0.000	0.520
PIPEFITTER		BLD		37.800	39.690	2.0	2.0	2.0	4.500	8.360	0.000	0.300

PLASTERER	BLD	30.250	31.250	1.5	1.5	2.0	9.250	8.600	0.000	0.050
PLUMBER	BLD	37.800	39.690	2.0	2.0	2.0	4.500	8.360	0.000	0.300
ROOFER	BLD	29.500	31.500	1.5	1.5	2.0	8.600	6.850	0.000	0.200
SHEETMETAL WORKER	ALL	31.690	33.190	1.5	1.5	2.0	7.130	6.730	1.910	0.360
SPRINKLER FITTER	BLD	38.780	41.780	2.0	2.0	2.0	8.370	11.18	0.000	1.000
STONE MASON	BLD	29.250	30.250	1.5	1.5	2.0	8.200	8.330	0.000	0.580
TERRAZZO FINISHER	BLD	25.600	0.000	1.5	1.5	2.0	8.200	7.230	0.000	0.000
TERRAZZO MASON	BLD	27.100	27.850	1.5	1.5	2.0	8.200	7.230	0.000	0.000
TILE MASON	BLD	27.100	27.850	1.5	1.5	2.0	8.200	7.230	0.000	0.000
TRUCK DRIVER	ALL 1	31.340	0.000	1.5	1.5	2.0	10.30	5.010	0.000	0.250
TRUCK DRIVER	ALL 2	31.780	0.000	1.5	1.5	2.0	10.30	5.010	0.000	0.250
TRUCK DRIVER	ALL 3	32.020	0.000	1.5	1.5	2.0	10.30	5.010	0.000	0.250
TRUCK DRIVER	ALL 4	32.280	0.000	1.5	1.5	2.0	10.30	5.010	0.000	0.250
TRUCK DRIVER	ALL 5	33.130	0.000	1.5	1.5	2.0	10.30	5.010	0.000	0.250
TRUCK DRIVER	O&C 1	25.070	0.000	1.5	1.5	2.0	10.30	5.010	0.000	0.250
TRUCK DRIVER	O&C 2	25.420	0.000	1.5	1.5	2.0	10.30	5.010	0.000	0.250
TRUCK DRIVER	O&C 3	25.620	0.000	1.5	1.5	2.0	10.30	5.010	0.000	0.250
TRUCK DRIVER	O&C 4	25.820	0.000	1.5	1.5	2.0	10.30	5.010	0.000	0.250
TRUCK DRIVER	O&C 5	26.500	0.000	1.5	1.5	2.0	10.30	5.010	0.000	0.250
TUCKPOINTER	BLD	29.250	30.250	1.5	1.5	2.0	8.200	8.330	0.000	0.580

Legend:

RG (Region)

TYP (Trade Type - All,Highway,Building,Floating,Oil & Chip,Rivers)

C (Class)

Base (Base Wage Rate)

FRMAN (Foreman Rate)

M-F>8 (OT required for any hour greater than 8 worked each day, Mon through Fri.

OSA (Overtime (OT) is required for every hour worked on Saturday)

OSH (Overtime is required for every hour worked on Sunday and Holidays)

H/W (Health & Welfare Insurance)

Pensn (Pension)

Vac (Vacation)

Trng (Training)

Explanations

GREENE COUNTY

The following list is considered as those days for which holiday rates of wages for work performed apply: New Years Day, Memorial Day, Fourth of July, Labor Day, Thanksgiving Day, Christmas Day and Veterans Day in some classifications/counties. Generally, any of these holidays which fall on a Sunday is celebrated on the following Monday. This then makes work performed on that Monday payable at the appropriate overtime rate for holiday pay. Common practice in a given local may alter certain days of celebration. If in doubt, please check with IDOL.

Oil and chip resealing (O&C) means the application of road oils and liquid asphalt to coat an existing road surface, followed by application of aggregate chips or gravel to coated surface, and subsequent rolling of material to seal the surface.

EXPLANATION OF CLASSES

ASBESTOS - GENERAL - removal of asbestos material/mold and hazardous materials from any place in a building, including mechanical systems where those mechanical systems are to be removed. This includes the removal of asbestos materials/mold and hazardous materials from ductwork or pipes in a building when the building is to be demolished at the time or at some close future date.

ASBESTOS - MECHANICAL - removal of asbestos material from mechanical systems, such as pipes, ducts, and boilers, where the mechanical systems are to remain.

CERAMIC TILE FINISHER, MARBLE FINISHER, TERRAZZO FINISHER

Assisting, helping or supporting the tile, marble and terrazzo mechanic by performing their historic and traditional work assignments required to complete the proper installation of the work covered by said crafts. The term "Ceramic" is used for naming the classification only and is in no way a limitation of the product handled. Ceramic takes into consideration most hard tiles.

ELECTRONIC SYSTEMS TECHNICIAN

Installation, service and maintenance of low-voltage systems which utilizes the transmission and/or transference of voice, sound, vision, or digital for commercial, education, security and entertainment purposes for the following: TV monitoring and surveillance, background/foreground music, intercom and telephone interconnect, field programming, inventory control systems, microwave transmission, multi-media, multiplex, radio page, school, intercom and sound burglar alarms and low voltage master clock systems.

Excluded from this classification are energy management systems, life safety systems, supervisory controls and data acquisition systems not intrinsic with the above listed systems, fire alarm systems, nurse call systems and raceways exceeding fifteen feet in length.

OPERATING ENGINEER - BUILDING

GROUP I. Cranes, Dragline, Shovels, Skimmer Scoops, Clamshells or Derrick Boats, Pile Drivers, Crane-Type Backhoes, Asphalt Plant Operators, Concrete Plant Operators, Dredges, Asphalt Spreading Machines, All Locomotives, Cable Ways or Tower Machines, Hoists, Hydraulic Backhoes, Ditching Machines or Backfiller, Cherrypickers, Overhead Cranes, Roller - Steam or Gas, Concrete Pavers, Excavators, Concrete Breakers, Concrete Pumps, Bulk Cement Plants, Cement Pumps, Derrick-Type Drills, Boat Operators, Motor Graders or Pushcats, Scoops or Tournapulls, Bulldozers, Endloaders or Fork Lifts, Power Blade or Elevating Graders, Winch Cats, Boom or Winch Trucks or Boom Tractors, Pipe Wrapping or Painting Machines, Asphalt Plant Engineer, Journeyman Lubricating Engineer, Drills (other than Derrick Type), Mud Jacks, or Well Drilling Machines, Boring Machines or Track Jacks, Mixers, Conveyors (Two), Air Compressors (Two), Water Pumps regardless of size (Two), Welding Machines (Two), Siphons or Jets (Two), Winch Heads or Apparatuses (Two), Light Plants (Two), All Tractors regardless of size (straight tractor only), Fireman on Stationary Boilers, Automatic Elevators, Form Grading Machines, Finishing Machines, Power Sub-Grader or Ribbon Machines, Longitudinal Floats, Distributor Operators on

Trucks, Winch Heads or Apparatuses (One), Mobil Track air and heaters (two to five), Heavy Equipment Greaser, Relief Operator, Assistant Master Mechanic and Heavy Duty Mechanic, self-propelled concrete saws of all types and sizes with their attachments, gob-hoppers, excavators all sizes, the repair and greasing of all diesel hammers, the operation and set-up of bidwells, water blasters of all sizes and their clutches, hydraulic jacks where used for hoisting, operation of log skidders, iceolators used on and off of pipeline, condor cranes, bow boats, survey boats, bobcats and all their attachments, skid steer loaders and all their attachments, creter cranes, batch plants, operator (all sizes), self propelled roto mills, operation of conveyor systems of any size and any configuration, operation, repair and service of all vibratory hammers, all power pacs and their controls regardless of location, curtains or brush burning machines, stump cutter machines, Nail launchers when mounted on a machine or self-propelled, operation of con-cover machines, and all Operators except those listed below).

GROUP II. Assistant Operators.

GROUP III. Air Compressors (One), Water Pumps, regardless of Size (One), Waterblasters (one), Welding Machine (One), Mixers (One Bag), Conveyor (One), Siphon or Jet (One), Light Plant (One), Heater (One), Immobile Track Air (One), and Self Propelled Walk-Behind Rollers.

GROUP IV. Asphalt Spreader Oilers, Fireman on Whirlies and Heavy Equipment Oilers, Truck Cranes, Dredges, Monigans, Large Cranes - (Over 65-ton rated capacity) Concrete Plant Oiler, Blacktop Plant Oiler, and Creter Crane Oiler (when required).

GROUP V. Oiler.

GROUP VI. Operators on equipment with Booms, including jibs, 100 feet and over, and less than 150 feet long.

GROUP VII. Operators on equipment with Booms, including jibs, 150 feet and over, and less than 200 feet long.

GROUP VIII. Operators on Equipment with Booms, including jibs, 200 feet and over; Tower Cranes; and Whirlie Cranes.

GROUP IX. Master Mechanic

OPERATING ENGINEERS - Highway

GROUP I. Cranes, Dragline, Shovels, Skimmer Scoops, Clamshells or Derrick Boats, Pile Drivers, Crane-Type Backhoes, Asphalt Plant Operators, Concrete Plant Operators, Dredges, Asphalt Spreading Machines, All Locomotives, Cable Ways or Tower Machines, Hoists, Hydraulic Backhoes, Ditching Machines or Backfiller, Cherrypickers, Overhead Cranes, Roller - Steam or Gas, Concrete Pavers, Excavators, Concrete Breakers, Concrete Pumps, Bulk Cement Plants, Cement Pumps, Derrick-Type Drills, Boat Operators, Motor Graders or Pushcats, Scoops or Tournapulls, Bulldozers, Endloaders or Fork Lifts, Power Blade or Elevating Graders, Winch Cats, Boom or Winch Trucks or Boom Tractors, Pipe Wrapping or Painting Machines, Asphalt Plant Engineer, Journeyman Lubricating Engineer, Drills (other than Derrick Type), Mud Jacks, Well Drilling Machines, Boring Machines, Track Jacks, Mixers, Conveyors (Two), Air Compressors (Two), Water Pumps regardless of size (Two), Welding Machines (Two), Siphons or Jets (Two), Winch Heads or Apparatuses (Two), Light Plants (Two), All Tractors regardless of size (straight tractor only), Fireman on Stationary Boilers, Automatic Elevators, Form Grading Machines, Finishing Machines, Power Sub-Grader or Ribbon Machines, Longitudinal Floats, Distributor Operators on Trucks, Winch Heads or Apparatuses (One), Mobil Track air and heaters

(two to five), Heavy Equipment Greaser, Relief Operator, Assistant Master Mechanic and Heavy Duty Mechanic, self-propelled concrete saws of all types and sizes with their attachments, gob-hoppers, excavators all sizes, the repair and greasing of all diesel hammers, the operation and set-up of bidwells, water blasters of all sizes and their clutches, hydraulic jacks where used for hoisting, operation of log skidders, iceolators used on and off of pipeline, condor cranes, bow boats, survey boats, bobcats and all their attachments, skid steer loaders and all their attachments, creter cranes, batch plants, operator (all sizes), self propelled roto mills, operation of conveyor systems of any size and any configuration, operation, repair and service of all vibratory hammers, all power pacs and their controls regardless of location, curtains or brush burning machines, stump cutter machines, Nail launchers when mounted on a machine or self-propelled, operation of con-cover machines, and all Operators (except those listed below).

GROUP II. Assistant Operators.

GROUP III. Air Compressors (One), Water Pumps, regardless of Size (One), Waterblasters (one), Welding Machine (One), Mixers (One Bag), Conveyor (One), Siphon or Jet (One), Light Plant (One), Heater (One), Immobile Track Air (One), and Self Propelled Walk-Behind Rollers.

GROUP IV. Asphalt Spreader Oilers, Fireman on Whirlies and Heavy Equipment Oilers, Truck Cranes, Dredges, Monigans, Large Cranes - (Over 65-ton rated capacity) Concrete Plant Oiler, Blacktop Plant Oiler, and Creter Crane Oiler (when required).

GROUP V. Oiler.

GROUP VI. Operators on equipment with Booms, including jibs, 100 feet and over, and less than 150 feet long.

GROUP VII. Operators on equipment with Booms, including jibs, 150 feet and over, and less than 200 feet long.

GROUP VIII. Operators on Equipment with Booms, including jibs, 200 feet and over; Tower Cranes; and Whirlie Cranes.

GROUP IX. Mechanic

TRUCK DRIVER - BUILDING, HEAVY AND HIGHWAY CONSTRUCTION

Class 1. Drivers on 2 axle trucks hauling less than 9 ton. Air compressor and welding machines and brooms, including those pulled by separate units, truck driver helpers, warehouse employees, mechanic helpers, greasers and tiremen, pickup trucks when hauling materials, tools, or workers to and from and on-the-job site, and fork lifts up to 6,000 lb. capacity.

Class 2. Two or three axle trucks hauling more than 9 ton but hauling less than 16 ton. A-frame winch trucks, hydrolift trucks, vactor trucks or similar equipment when used for transportation purposes. Fork lifts over 6,000 lb. capacity, winch trucks, four axle combination units, and ticket writers.

Class 3. Two, three or four axle trucks hauling 16 ton or more. Drivers on water pulls, articulated dump trucks, mechanics and working forepersons, and dispatchers. Five axle or more combination units.

Class 4. Low Boy and Oil Distributors.

Class 5. Drivers who require special protective clothing while

employed on hazardous waste work.
 TRUCK DRIVER - OIL AND CHIP RESEALING ONLY.

This shall encompass laborers, workers and mechanics who drive contractor or subcontractor owned, leased, or hired pickup, dump, service, or oil distributor trucks. The work includes transporting materials and equipment (including but not limited to, oils, aggregate supplies, parts, machinery and tools) to or from the job site; distributing oil or liquid asphalt and aggregate; stock piling material when in connection with the actual oil and chip contract. The Truck Driver (Oil & Chip Resealing) wage classification does not include supplier delivered materials.

Other Classifications of Work:

For definitions of classifications not otherwise set out, the Department generally has on file such definitions which are available. If a task to be performed is not subject to one of the classifications of pay set out, the Department will upon being contacted state which neighboring county has such a classification and provide such rate, such rate being deemed to exist by reference in this document. If no neighboring county rate applies to the task, the Department shall undertake a special determination, such special determination being then deemed to have existed under this determination. If a project requires these, or any classification not listed, please contact IDOL at 217-782-1710 for wage rates or clarifications.

LANDSCAPING

Landscaping work falls under the existing classifications for laborer, operating engineer and truck driver. The work performed by landscape plantsman and landscape laborer is covered by the existing classification of laborer. The work performed by landscape operators (regardless of equipment used or its size) is covered by the classifications of operating engineer. The work performed by landscape truck drivers (regardless of size of truck driven) is covered by the classifications of truck driver.

Grundy County Prevailing Wage for May 2013

(See explanation of column headings at bottom of wages)

Trade Name	RG	TYP	C	Base	FRMAN	M-F>8	OSA	OSH	H/W	Pensn	Vac	Trng
=====	==	==	=	=====	=====	=====	==	==	=====	=====	=====	=====
ASBESTOS ABT-GEN		ALL		36.200	36.700	1.5	1.5	2.0	12.78	9.020	0.000	0.500
ASBESTOS ABT-MEC		BLD		34.160	36.660	1.5	1.5	2.0	10.82	10.66	0.000	0.720
BOILERMAKER		BLD		43.450	47.360	2.0	2.0	2.0	6.970	14.66	0.000	0.350
BRICK MASON		BLD		40.680	44.750	1.5	1.5	2.0	9.550	12.00	0.000	0.970
CARPENTER		ALL		41.520	45.670	1.5	1.5	2.0	13.19	11.76	0.000	0.530
CEMENT MASON		ALL		41.000	43.000	2.0	2.0	2.0	9.500	14.43	0.000	0.500
CERAMIC TILE FNSHER		BLD		34.440	0.000	2.0	1.5	2.0	9.700	6.930	0.000	0.610
COMMUNICATION TECH		BLD		32.200	33.700	1.5	1.5	2.0	12.32	10.80	0.000	0.320
ELECTRIC PWR EQMT OP		ALL		43.350	48.350	1.5	1.5	2.0	10.38	13.50	0.000	0.430
ELECTRIC PWR GRNDMAN		ALL		33.810	48.350	1.5	1.5	2.0	8.090	10.53	0.000	0.330
ELECTRIC PWR LINEMAN		ALL		43.350	48.350	1.5	1.5	2.0	10.38	13.50	0.000	0.430
ELECTRICIAN		BLD		39.500	43.060	1.5	1.5	2.0	13.17	15.11	0.000	1.200
ELEVATOR CONSTRUCTOR		BLD		40.520	45.585	2.0	2.0	2.0	11.88	12.71	3.240	0.600
GLAZIER		BLD		39.500	41.000	1.5	2.0	2.0	11.99	14.30	0.000	0.840
HT/FROST INSULATOR		BLD		45.550	48.050	1.5	1.5	2.0	10.82	11.86	0.000	0.720
IRON WORKER		ALL		40.250	41.250	2.0	2.0	2.0	9.390	20.41	0.000	0.700
LABORER		ALL		36.200	36.950	1.5	1.5	2.0	12.78	9.020	0.000	0.500
LATHER		ALL		41.520	45.670	1.5	1.5	2.0	13.19	11.76	0.000	0.530

MACHINIST	BLD	43.550	46.050	1.5	1.5	2.0	6.130	8.950	1.850	0.000
MARBLE FINISHERS	ALL	29.700	0.000	1.5	1.5	2.0	9.550	11.75	0.000	0.620
MARBLE MASON	BLD	39.880	43.870	1.5	1.5	2.0	9.550	11.75	0.000	0.730
MATERIAL TESTER I	ALL	26.200	0.000	1.5	1.5	2.0	12.78	9.020	0.000	0.500
MATERIALS TESTER II	ALL	31.200	0.000	1.5	1.5	2.0	12.78	9.020	0.000	0.500
MILLWRIGHT	ALL	41.520	45.670	1.5	1.5	2.0	13.19	11.76	0.000	0.530
OPERATING ENGINEER	BLD 1	45.100	49.100	2.0	2.0	2.0	15.70	10.55	1.900	1.250
OPERATING ENGINEER	BLD 2	43.800	49.100	2.0	2.0	2.0	15.70	10.55	1.900	1.250
OPERATING ENGINEER	BLD 3	41.250	49.100	2.0	2.0	2.0	15.70	10.55	1.900	1.250
OPERATING ENGINEER	BLD 4	39.500	49.100	2.0	2.0	2.0	15.70	10.55	1.900	1.250
OPERATING ENGINEER	BLD 5	48.850	49.100	2.0	2.0	2.0	15.70	10.55	1.900	1.250
OPERATING ENGINEER	BLD 6	46.100	49.100	2.0	2.0	2.0	15.70	10.55	1.900	1.250
OPERATING ENGINEER	BLD 7	48.100	49.100	2.0	2.0	2.0	15.70	10.55	1.900	1.250
OPERATING ENGINEER	HWY 1	43.300	47.300	1.5	1.5	2.0	15.70	10.55	1.900	1.250
OPERATING ENGINEER	HWY 2	42.750	47.300	1.5	1.5	2.0	15.70	10.55	1.900	1.250
OPERATING ENGINEER	HWY 3	40.700	47.300	1.5	1.5	2.0	15.70	10.55	1.900	1.250
OPERATING ENGINEER	HWY 4	39.300	47.300	1.5	1.5	2.0	15.70	10.55	1.900	1.250
OPERATING ENGINEER	HWY 5	38.100	47.300	1.5	1.5	2.0	15.70	10.55	1.900	1.250
OPERATING ENGINEER	HWY 6	46.300	47.300	1.5	1.5	2.0	15.70	10.55	1.900	1.250
OPERATING ENGINEER	HWY 7	44.300	47.300	1.5	1.5	2.0	15.70	10.55	1.900	1.250
PAINTER	ALL	40.000	44.750	1.5	1.5	1.5	9.750	11.10	0.000	0.770
PAINTER SIGNS	BLD	33.920	38.090	1.5	1.5	1.5	2.600	2.710	0.000	0.000
PILEDRIVER	ALL	41.520	45.670	1.5	1.5	2.0	13.19	11.76	0.000	0.530
PIPEFITTER	BLD	45.050	48.050	1.5	1.5	2.0	8.460	14.85	0.000	1.780
PLASTERER	BLD	40.250	42.670	1.5	1.5	2.0	10.85	10.94	0.000	0.550
PLUMBER	BLD	45.000	47.000	1.5	1.5	2.0	12.53	10.06	0.000	0.880
ROOFER	BLD	30.210	32.210	1.5	1.5	2.0	8.280	8.770	0.000	0.430
SHEETMETAL WORKER	BLD	42.510	44.510	1.5	1.5	2.0	10.04	12.01	0.000	0.780
SIGN HANGER	ALL	22.990	25.290	1.5	1.5	2.0	3.790	2.500	0.000	0.000
SPRINKLER FITTER	BLD	49.200	51.200	1.5	1.5	2.0	10.25	8.350	0.000	0.450
STONE MASON	BLD	40.680	44.750	1.5	1.5	2.0	9.550	12.00	0.000	0.970
TERRAZZO FINISHER	BLD	35.510	0.000	1.5	1.5	2.0	9.700	9.320	0.000	0.400
TERRAZZO MASON	BLD	39.370	42.370	1.5	1.5	2.0	9.700	10.66	0.000	0.550
TILE MASON	BLD	41.430	45.430	2.0	1.5	2.0	9.700	8.640	0.000	0.710
TRUCK DRIVER	ALL 1	35.650	36.200	1.5	1.5	2.0	7.250	6.319	0.000	0.250
TRUCK DRIVER	ALL 2	35.800	36.200	1.5	1.5	2.0	7.250	6.319	0.000	0.250
TRUCK DRIVER	ALL 3	36.000	36.200	1.5	1.5	2.0	7.250	6.319	0.000	0.250
TRUCK DRIVER	ALL 4	36.200	36.200	1.5	1.5	2.0	7.250	6.319	0.000	0.250
TUCKPOINTER	BLD	40.950	41.950	1.5	1.5	2.0	8.180	10.82	0.000	0.940

Legend :

RG (Region)

TYP (Trade Type - All,Highway,Building,Floating,Oil & Chip,Rivers)

C (Class)

Base (Base Wage Rate)

FRMAN (Foreman Rate)

M-F>8 (OT required for any hour greater than 8 worked each day, Mon through Fri.)

OSA (Overtime (OT) is required for every hour worked on Saturday)

OSH (Overtime is required for every hour worked on Sunday and Holidays)

H/W (Health & Welfare Insurance)

Pensn (Pension)

Vac (Vacation)

Explanations

GRUNDY COUNTY

PLUMBERS & PIPEFITTERS (WEST) - That part of the county West of Rt. 47 excluding the City of Morris.

The following list is considered as those days for which holiday rates of wages for work performed apply: New Years Day, Memorial Day, Fourth of July, Labor Day, Thanksgiving Day, Christmas Day and Veterans Day in some classifications/counties. Generally, any of these holidays which fall on a Sunday is celebrated on the following Monday. This then makes work performed on that Monday payable at the appropriate overtime rate for holiday pay. Common practice in a given local may alter certain days of celebration. If in doubt, please check with IDOL.

EXPLANATION OF CLASSES

ASBESTOS - GENERAL - removal of asbestos material/mold and hazardous materials from any place in a building, including mechanical systems where those mechanical systems are to be removed. This includes the removal of asbestos materials/mold and hazardous materials from ductwork or pipes in a building when the building is to be demolished at the time or at some close future date.

ASBESTOS - MECHANICAL - removal of asbestos material from mechanical systems, such as pipes, ducts, and boilers, where the mechanical systems are to remain.

CERAMIC TILE FINISHER

The grouting, cleaning, and polishing of all classes of tile, whether for interior or exterior purposes, all burned, glazed or unglazed products; all composition materials, granite tiles, warning detectable tiles, cement tiles, epoxy composite materials, pavers, glass, mosaics, fiberglass, and all substitute materials, for tile made in tile-like units; all mixtures in tile like form of cement, metals, and other materials that are for and intended for use as a finished floor surface, stair treads, promenade roofs, walks, walls, ceilings, swimming pools, and all other places where tile is to form a finished interior or exterior. The mixing of all setting mortars including but not limited to thin-set mortars, epoxies, wall mud, and any other sand and cement mixtures or adhesives when used in the preparation, installation, repair, or maintenance of tile and/or similar materials. The handling and unloading of all sand, cement, lime, tile, fixtures, equipment, adhesives, or any other materials to be used in the preparation, installation, repair, or maintenance of tile and/or similar materials. Ceramic Tile Finishers shall fill all joints and voids regardless of method on all tile work, particularly and especially after installation of said tile work. Application of any and all protective coverings to all types of tile installations including, but not be limited to, all soap compounds, paper products, tapes, and all polyethylene coverings, plywood, masonite, cardboard, and any new type of products that may be used to protect tile installations, Blastrac equipment, and all floor scarifying equipment used in preparing floors to receive tile. The clean up and removal of all waste and materials. All demolition of existing tile floors and walls to be re-tiled.

COMMUNICATIONS TECHNICIAN

Installation, operation, inspection, maintenance, repair and service of radio, television, recording, voice, sound and vision production and reproduction, telephone and telephone interconnect, facsimile, equipment and appliances used for domestic, commercial, educational and entertainment purposes, pulling of wire through conduit but not the installation of conduit.

MARBLE FINISHER

Loading and unloading trucks, distribution of all materials (all stone, sand, etc.), stocking of floors with material, performing all rigging for heavy work, the handling of all material that may be needed for the installation of such materials, building of scaffolding, polishing if needed, patching, waxing of material if damaged, pointing up, caulking, grouting and cleaning of marble, holding water on diamond or Carborundum blade or saw for setters cutting, use of tub saw or any other saw needed for preparation of material, drilling of holes for wires that anchor material set by setters, mixing up of molding plaster for installation of material, mixing up thin set for the installation of material, mixing up of sand to cement for the installation of material and such other work as may be required in helping a Marble Setter in the handling of all material in the erection or installation of interior marble, slate, travertine, art marble, serpentine, alberene stone, blue stone, granite and other stones (meaning as to stone any foreign or domestic materials as are specified and used in building interiors and exteriors and customarily known as stone in the trade), carrara, sanionyx, vitrolite and similar opaque glass and the laying of all marble tile, terrazzo tile, slate tile and precast tile, steps, risers treads, base, or any other materials that may be used as substitutes for any of the aforementioned materials and which are used on interior and exterior which are installed in a similar manner.

MATERIAL TESTER I: Hand coring and drilling for testing of materials; field inspection of uncured concrete and asphalt.

MATERIAL TESTER II: Field inspection of welds, structural steel, fireproofing, masonry, soil, facade, reinforcing steel, formwork, cured concrete, and concrete and asphalt batch plants; adjusting proportions of bituminous mixtures.

OPERATING ENGINEER - BUILDING

Class 1. Asphalt Plant; Asphalt Spreader; Autograde; Backhoes with Caisson Attachment; Batch Plant; Benoto (requires Two Engineers); Boiler and Throttle Valve; Caisson Rigs; Central Redi-Mix Plant; Combination Back Hoe Front End-loader Machine; Compressor and Throttle Valve; Concrete Breaker (Truck Mounted); Concrete Conveyor; Concrete Conveyor (Truck Mounted); Concrete Paver Over 27E cu. ft; Concrete Paver 27E cu. ft. and Under; Concrete Placer; Concrete Placing Boom; Concrete Pump (Truck Mounted); Concrete Tower; Cranes, All; Cranes, Hammerhead; Cranes, (GCI and similar Type); Creter Crane; Spider Crane; Crusher, Stone, etc.; Derricks, All; Derricks, Traveling; Formless Curb and Gutter Machine; Grader, Elevating; Grouting Machines; Heavy Duty Self-Propelled Transporter or Prime Mover; Highlift Shovels or Front Endloader 2-1/4 yd. and over; Hoists, Elevators, outside type rack and pinion and similar machines; Hoists, One, Two and Three Drum; Hoists, Two Tugger One Floor; Hydraulic Backhoes; Hydraulic Boom Trucks; Hydro Vac (and similar equipment); Locomotives, All; Motor Patrol; Lubrication Technician; Manipulators; Pile Drivers and Skid Rig; Post Hole Digger; Pre-Stress Machine; Pump Cretes Dual Ram; Pump Cretes: Squeeze Cretes-Screw Type Pumps; Gypsum

Bulker and Pump; Raised and Blind Hole Drill; Roto Mill Grinder; Scoops - Tractor Drawn; Slip-Form Paver; Straddle Buggies; Operation of Tie Back Machine; Tournapull; Tractor with Boom and Side Boom; Trenching Machines.

Class 2. Boilers; Broom, All Power Propelled; Bulldozers; Concrete Mixer (Two Bag and Over); Conveyor, Portable; Forklift Trucks; Highlift Shovels or Front Endloaders under 2-1/4 yd.; Hoists, Automatic; Hoists, Inside Elevators; Hoists, Sewer Dragging Machine; Hoists, Tugger Single Drum; Laser Screed; Rock Drill (Self-Propelled); Rock Drill (Truck Mounted); Rollers, All; Steam Generators; Tractors, All; Tractor Drawn Vibratory Roller; Winch Trucks with "A" Frame.

Class 3. Air Compressor; Combination Small Equipment Operator; Generators; Heaters, Mechanical; Hoists, Inside Elevators (remodeling or renovation work); Hydraulic Power Units (Pile Driving, Extracting, and Drilling); Pumps, over 3" (1 to 3 not to exceed a total of 300 ft.); Low Boys; Pumps, Well Points; Welding Machines (2 through 5); Winches, 4 Small Electric Drill Winches.

Class 4. Bobcats and/or other Skid Steer Loaders; Oilers; and Brick Forklift.

Class 5. Assistant Craft Foreman.

Class 6. Gradall.

Class 7. Mechanics; Welders.

OPERATING ENGINEERS - HIGHWAY CONSTRUCTION

Class 1. Asphalt Plant; Asphalt Heater and Planer Combination; Asphalt Heater Scarfire; Asphalt Spreader; Autograder/GOMACO or other similar type machines: ABG Paver; Backhoes with Caisson Attachment; Ballast Regulator; Belt Loader; Caisson Rigs; Car Dumper; Central Redi-Mix Plant; Combination Backhoe Front Endloader Machine, (1 cu. yd. Backhoe Bucket or over or with attachments); Concrete Breaker (Truck Mounted); Concrete Conveyor; Concrete Paver over 27E cu. ft.; Concrete Placer; Concrete Tube Float; Cranes, all attachments; Cranes, Tower Cranes of all types: Creter Crane; Spider Crane; Crusher, Stone, etc.; Derricks, All; Derrick Boats; Derricks, Traveling; Dredges; Elevators, Outside type Rack & Pinion and Similar Machines; Formless Curb and Gutter Machine; Grader, Elevating; Grader, Motor Grader, Motor Patrol, Auto Patrol, Form Grader, Pull Grader, Subgrader; Guard Rail Post Driver Truck Mounted; Hoists, One, Two and Three Drum; Heavy Duty Self-Propelled Transporter or Prime Mover; Hydraulic Backhoes; Backhoes with shear attachments up to 40' of boom reach; Lubrication Technician; Manipulators; Mucking Machine; Pile Drivers and Skid Rig; Pre-Stress Machine; Pump Cretes Dual Ram; Rock Drill - Crawler or Skid Rig; Rock Drill - Truck Mounted; Rock/Track Tamper; Roto Mill Grinder; Slip-Form Paver; Snow Melters; Soil Test Drill Rig (Truck Mounted); Straddle Buggies; Hydraulic Telescoping Form (Tunnel); Operation of Tieback Machine; Tractor Drawn Belt Loader; Tractor Drawn Belt Loader (with attached pusher - two engineers); Tractor with Boom; Tractaire with Attachments; Traffic Barrier Transfer Machine; Trenching; Truck Mounted Concrete Pump with Boom; Raised or Blind Hole Drills (Tunnel Shaft); Underground Boring and/or Mining Machines 5 ft. in diameter and over tunnel, etc; Underground Boring and/or Mining Machines under 5 ft. in diameter; Wheel Excavator; Widener (APSCO).

Class 2. Batch Plant; Bituminous Mixer; Boiler and Throttle Valve; Bulldozers; Car Loader Trailing Conveyors; Combination Backhoe Front Endloader Machine (Less than 1 cu. yd. Backhoe Bucket or over or with attachments); Compressor and Throttle Valve; Compressor, Common

Receiver (3); Concrete Breaker or Hydro Hammer; Concrete Grinding Machine; Concrete Mixer or Paver 7S Series to and including 27 cu. ft.; Concrete Spreader; Concrete Curing Machine, Burlap Machine, Belting Machine and Sealing Machine; Concrete Wheel Saw; Conveyor Muck Cars (Haglund or Similar Type); Drills, All; Finishing Machine - Concrete; Highlift Shovels or Front Endloader; Hoist - Sewer Dragging Machine; Hydraulic Boom Trucks (All Attachments); Hydro-Blaster; Hydro Excavating (excluding hose work); Laser Screed; All Locomotives, Dinky; Off-Road Hauling Units (including articulating) Non Self-Loading Ejection Dump; Pump Cretes: Squeeze Cretes - Screw Type Pumps, Gypsum Bulker and Pump; Roller, Asphalt; Rotary Snow Plows; Rototiller, Seaman, etc., self-propelled; Self-Propelled Compactor; Spreader - Chip - Stone, etc.; Scraper - Single/Twin Engine/Push and Pull; Scraper - Prime Mover in Tandem (Regardless of Size); Tractors pulling attachments, Sheeps Foot, Disc, Compactor, etc.; Tug Boats.

Class 3. Boilers; Brooms, All Power Propelled; Cement Supply Tender; Compressor, Common Receiver (2); Concrete Mixer (Two Bag and Over); Conveyor, Portable; Farm-Type Tractors Used for Mowing, Seeding, etc.; Forklift Trucks; Grouting Machine; Hoists, Automatic; Hoists, All Elevators; Hoists, Tugger Single Drum; Jeep Diggers; Low Boys; Pipe Jacking Machines; Post-Hole Digger; Power Saw, Concrete Power Driven; Pug Mills; Rollers, other than Asphalt; Seed and Straw Blower; Steam Generators; Stump Machine; Winch Trucks with "A" Frame; Work Boats; Tamper-Form-Motor Driven.

Class 4. Air Compressor; Combination - Small Equipment Operator; Directional Boring Machine; Generators; Heaters, Mechanical; Hydraulic Power Unit (Pile Driving, Extracting, or Drilling); Light Plants, All (1 through 5); Pumps, over 3" (1 to 3 not to exceed a total of 300 ft.); Pumps, Well Points; Vacuum Trucks (excluding hose work); Welding Machines (2 through 5); Winches, 4 Small Electric Drill Winches.

Class 5. SkidSteer Loader (all); Brick Forklifts; Oilers.

Class 6. Field Mechanics and Field Welders

Class 7. Dowell Machine with Air Compressor; Gradall and machines of like nature.

TRUCK DRIVER - BUILDING, HEAVY AND HIGHWAY CONSTRUCTION

Class 1. Two or three Axle Trucks. A-frame Truck when used for transportation purposes; Air Compressors and Welding Machines, including those pulled by cars, pick-up trucks and tractors; Ambulances; Batch Gate Lockers; Batch Hopperman; Car and Truck Washers; Carry-alls; Fork Lifts and Hoisters; Helpers; Mechanics Helpers and Greasers; Oil Distributors 2-man operation; Pavement Breakers; Pole Trailer, up to 40 feet; Power Mower Tractors; Self-propelled Chip Spreader; Skipman; Slurry Trucks, 2-man operation; Slurry Truck Conveyor Operation, 2 or 3 man; Teamsters Unskilled dumpman; and Truck Drivers hauling warning lights, barricades, and portable toilets on the job site.

Class 2. Four axle trucks; Dump Crets and Adgetors under 7 yards; Dumpsters, Track Trucks, Euclids, Hug Bottom Dump Turnapulls or Turnatrailers when pulling other than self-loading equipment or similar equipment under 16 cubic yards; Mixer Trucks under 7 yards; Ready-mix Plant Hopper Operator, and Winch Trucks, 2 Axles.

Class 3. Five axle trucks; Dump Crets and Adgetors 7 yards and over; Dumpsters, Track Trucks, Euclids, Hug Bottom Dump Turnatrailers or turnapulls when pulling other than self-loading equipment or similar equipment over 16 cubic yards; Explosives and/or Fission Material Trucks; Mixer Trucks 7 yards or over; Mobile Cranes while in transit;

Oil Distributors, 1-man operation; Pole Trailer, over 40 feet; Pole and Expandable Trailers hauling material over 50 feet long; Slurry trucks, 1-man operation; Winch trucks, 3 axles or more; Mechanic--Truck Welder and Truck Painter.

Class 4. Six axle trucks; Dual-purpose vehicles, such as mounted crane trucks with hoist and accessories; Foreman; Master Mechanic; Self-loading equipment like P.B. and trucks with scoops on the front.

TERRAZZO FINISHER

The handling of sand, cement, marble chips, and all other materials that may be used by the Mosaic Terrazzo Mechanic, and the mixing, grinding, grouting, cleaning and sealing of all Marble, Mosaic, and Terrazzo work, floors, base, stairs, and wainscoting by hand or machine, and in addition, assisting and aiding Marble, Masonic, and Terrazzo Mechanics.

Other Classifications of Work:

For definitions of classifications not otherwise set out, the Department generally has on file such definitions which are available. If a task to be performed is not subject to one of the classifications of pay set out, the Department will upon being contacted state which neighboring county has such a classification and provide such rate, such rate being deemed to exist by reference in this document. If no neighboring county rate applies to the task, the Department shall undertake a special determination, such special determination being then deemed to have existed under this determination. If a project requires these, or any classification not listed, please contact IDOL at 217-782-1710 for wage rates or clarifications.

LANDSCAPING

Landscaping work falls under the existing classifications for laborer, operating engineer and truck driver. The work performed by landscape plantsman and landscape laborer is covered by the existing classification of laborer. The work performed by landscape operators (regardless of equipment used or its size) is covered by the classifications of operating engineer. The work performed by landscape truck drivers (regardless of size of truck driven) is covered by the classifications of truck driver.

Hamilton County Prevailing Wage for May 2013

(See explanation of column headings at bottom of wages)

Trade Name	RG	TYP	C	Base	FRMAN	M-F>8	OSA	OSH	H/W	Pensn	Vac	Trng
=====	==	===	=	=====	=====	=====	===	===	=====	=====	=====	=====
ASBESTOS ABT-GEN		ALL		25.300	25.750	1.5	1.5	2.0	5.750	10.35	0.000	0.900
ASBESTOS ABT-MEC		BLD		21.150	22.150	1.5	1.5	2.0	6.400	5.150	0.000	0.650
BOILERMAKER		BLD		31.500	34.000	1.5	1.5	2.0	7.070	18.73	1.000	0.350
BRICK MASON		BLD		28.620	30.120	1.5	1.5	2.0	8.200	7.030	0.000	0.430
CARPENTER		BLD		31.890	33.390	1.5	1.5	2.0	6.550	6.750	0.000	0.400
CARPENTER		HWY		31.890	33.640	1.5	1.5	2.0	6.550	6.750	0.000	0.400
CEMENT MASON		BLD		28.200	29.700	1.5	1.5	2.0	6.600	5.400	0.000	0.500
CEMENT MASON		HWY		27.080	28.580	1.5	1.5	2.0	6.600	5.800	0.000	0.300
CERAMIC TILE FNSHER		BLD		27.120	0.000	1.5	1.5	2.0	8.200	7.030	0.000	0.430
ELECTRIC PWR EQMT OP		ALL	1	35.570	0.000	1.5	1.5	2.0	5.000	9.960	0.000	0.360
ELECTRIC PWR EQMT OP		ALL	2	31.740	0.000	1.5	1.5	2.0	5.000	8.880	0.000	0.320

ELECTRIC PWR GRNDMAN	ALL	26.100	0.000	1.5	1.5	2.0	5.000	7.310	0.000	0.260
ELECTRIC PWR LINEMAN	ALL	44.630	47.650	1.5	1.5	2.0	5.000	12.50	0.000	0.450
ELECTRICIAN	ALL	39.350	41.600	1.5	1.5	2.0	6.140	9.440	0.000	0.790
ELECTRONIC SYS TECH	BLD	32.570	34.320	1.5	1.5	2.0	6.000	4.240	0.000	0.400
FLOOR LAYER	BLD	29.330	30.080	1.5	1.5	2.0	6.550	6.750	0.000	0.400
GLAZIER	BLD	26.780	28.030	1.5	1.5	2.0	6.120	5.200	0.000	0.300
HT/FROST INSULATOR	BLD	29.450	30.450	1.5	1.5	2.0	5.050	9.730	0.000	0.280
IRON WORKER	ALL	27.020	28.270	1.5	1.5	2.0	7.010	9.200	0.000	0.345
LABORER	BLD	25.300	25.750	1.5	1.5	2.0	5.750	10.35	0.000	0.800
LABORER	HWY	25.300	25.750	1.5	1.5	2.0	5.750	10.35	0.000	0.800
LABORER	O&C	17.740	18.190	1.5	1.5	2.0	5.450	8.450	0.000	0.800
MACHINIST	BLD	43.550	46.050	1.5	1.5	2.0	6.130	8.950	1.850	0.000
MARBLE FINISHERS	BLD	27.120	0.000	1.5	1.5	2.0	8.200	7.030	0.000	0.430
MARBLE MASON	BLD	28.620	30.120	1.5	1.5	2.0	8.200	7.030	0.000	0.430
MILLWRIGHT	BLD	31.890	33.390	1.5	1.5	2.0	6.550	6.750	0.000	0.400
MILLWRIGHT	HWY	32.390	34.140	1.5	1.5	2.0	6.550	6.750	0.000	0.400
OE RIVER 1	RIV 1	33.550	34.550	1.5	1.5	2.0	7.000	8.800	0.000	1.450
OE RIVER 2	RIV 2	30.100	34.550	1.5	1.5	2.0	7.000	8.800	0.000	1.450
OPERATING ENGINEER	ALL 1	33.450	34.450	1.5	1.5	2.0	7.000	8.800	0.000	1.450
OPERATING ENGINEER	ALL 2	31.550	34.450	1.5	1.5	2.0	7.000	8.800	0.000	1.450
OPERATING ENGINEER	ALL 3	24.150	34.450	1.5	1.5	2.0	7.000	8.800	0.000	1.450
OPERATING ENGINEER	ALL 4	21.400	27.800	1.5	1.5	2.0	5.650	6.100	0.000	1.100
OPERATING ENGINEER	O&C 1	25.090	26.090	1.5	1.5	2.0	7.000	8.800	0.000	1.450
OPERATING ENGINEER	O&C 2	23.660	26.090	1.5	1.5	2.0	7.000	8.800	0.000	1.450
OPERATING ENGINEER	O&C 3	18.120	26.090	1.5	1.5	2.0	7.000	8.800	0.000	1.450
OPERATING ENGINEER	O&C 4	16.050	21.100	1.5	1.5	2.0	5.650	6.100	0.000	1.100
PAINTER	ALL	23.190	23.690	1.5	1.5	2.0	5.000	6.840	0.000	0.480
PAINTER OVER 30FT	ALL	26.290	26.790	1.5	1.5	2.0	5.000	6.840	0.000	0.480
PAINTER PWR EQMT	ALL	26.290	26.790	1.5	1.5	2.0	5.000	6.840	0.000	0.480
PILEDRIVER	BLD	31.890	33.390	1.5	1.5	2.0	6.550	6.750	0.000	0.400
PILEDRIVER	HWY	32.390	34.140	1.5	1.5	2.0	6.550	6.750	0.000	0.400
PIPEFITTER	BLD	37.000	40.700	1.5	1.5	2.0	8.500	9.300	0.000	1.350
PLASTERER	BLD	28.200	29.700	1.5	1.5	2.0	6.600	5.400	0.000	0.500
PLUMBER	BLD	37.000	40.700	1.5	1.5	2.0	8.500	9.300	0.000	1.350
ROOFER	BLD	23.900	24.900	1.5	1.5	2.0	8.650	3.800	0.000	0.000
SHEETMETAL WORKER	ALL	31.690	33.190	1.5	1.5	2.0	7.130	6.730	1.910	0.360
SPRINKLER FITTER	BLD	36.390	39.140	1.5	1.5	2.0	8.420	8.500	0.000	0.450
STONE MASON	BLD	28.620	30.120	1.5	1.5	2.0	8.200	7.030	0.000	0.430
TERRAZZO FINISHER	BLD	27.120	0.000	1.5	1.5	2.0	8.200	7.030	0.000	0.430
TERRAZZO MASON	BLD	28.620	30.120	1.5	1.5	2.0	8.200	7.030	0.000	0.430
TRUCK DRIVER	ALL 1	30.070	0.000	1.5	1.5	2.0	10.30	6.100	0.000	0.250
TRUCK DRIVER	ALL 2	30.520	0.000	1.5	1.5	2.0	10.30	6.100	0.000	0.250
TRUCK DRIVER	ALL 3	30.740	0.000	1.5	1.5	2.0	10.30	6.100	0.000	0.250
TRUCK DRIVER	ALL 4	31.030	0.000	1.5	1.5	2.0	10.30	6.100	0.000	0.250
TRUCK DRIVER	ALL 5	31.850	0.000	1.5	1.5	2.0	10.30	6.100	0.000	0.250
TRUCK DRIVER	O&C 1	22.750	0.000	1.5	1.5	2.0	2.920	6.700	0.000	0.250
TRUCK DRIVER	O&C 2	19.150	0.000	1.5	1.5	2.0	2.920	6.700	0.000	0.250
TRUCK DRIVER	O&C 3	19.650	0.000	1.5	1.5	2.0	2.920	6.700	0.000	0.250
TUCKPOINTER	BLD	28.620	30.120	1.5	1.5	2.0	8.200	7.030	0.000	0.430

Legend :

RG (Region)

TYP (Trade Type - All,Highway,Building,Floating,Oil & Chip,Rivers)

C (Class)

Base (Base Wage Rate)

FRMAN (Foreman Rate)

M-F>8 (OT required for any hour greater than 8 worked each day, Mon through Fri.

OSA (Overtime (OT) is required for every hour worked on Saturday)

OSH (Overtime is required for every hour worked on Sunday and Holidays)

H/W (Health & Welfare Insurance)

Pensn (Pension)

Vac (Vacation)

Trng (Training)

Explanations

HAMILTON COUNTY

The following list is considered as those days for which holiday rates of wages for work performed apply: New Years Day, Memorial Day, Fourth of July, Labor Day, Thanksgiving Day, Christmas Day and Veterans Day in some classifications/counties. Generally, any of these holidays which fall on a Sunday is celebrated on the following Monday. This then makes work performed on that Monday payable at the appropriate overtime rate for holiday pay. Common practice in a given local may alter certain days of celebration. If in doubt, please check with IDOL.

Oil and chip resealing (O&C) means the application of road oils and liquid asphalt to coat an existing road surface, followed by application of aggregate chips or gravel to coated surface, and subsequent rolling of material to seal the surface.

EXPLANATION OF CLASSES

ASBESTOS - GENERAL - removal of asbestos material/mold and hazardous materials from any place in a building, including mechanical systems where those mechanical systems are to be removed. This includes the removal of asbestos materials/mold and hazardous materials from ductwork or pipes in a building when the building is to be demolished at the time or at some close future date.

ASBESTOS - MECHANICAL - removal of asbestos material from mechanical systems, such as pipes, ducts, and boilers, where the mechanical systems are to remain.

CERAMIC TILE FINISHER, MARBLE FINISHER, TERRAZZO FINISHER

Assisting, helping or supporting the tile, marble and terrazzo mechanic by performing their historic and traditional work assignments required to complete the proper installation of the work covered by said crafts. The term "Ceramic" is used for naming the classification only, and is in no a limitation of the product handled. Ceramic takes into consideration most hard tiles.

LABORER - OIL AND CHIP RESEALING ONLY

Hook and unhook chip box from aggregate truck; distribute material within chip box; perform flagging work related to oil and chip resealing; hand spray oil fluids; handle traffic control, including setting-up and maintaining barricades, drums, cones, delineators, signs and other such items, as well as laying-out and applying or removing temporary roadway markings used to control traffic in job site related to oil and chip resealing; and perform clean- up related

to oil and chip resealing.

ELECTRIC POWER LINEMAN

Construction, maintenance and dismantling of overhead and underground electric power lines, including high voltage pipe type cable work, and associated structures and equipment.

ELECTRIC POWER EQUIPMENT OPERATOR - CLASS 1

Operation of all crawler type equipment D-4 and larger from the ground to assist the Electric Power Linemen in performing their duties.

ELECTRIC POWER EQUIPMENT OPERATORS - CLASS 2

Operation of all other equipment from the ground to assist the Electric Power Linemen in performing their duties.

ELECTRIC POWER GROUNDMAN

Applies to workers who assist the Electric Power Lineman from the ground.

ELECTRONIC SYSTEMS TECHNICIAN

Installation, service and maintenance of low-voltage systems which utilizes the transmission and/or transference of voice, sound, vision, or digital for commercial, education, security and entertainment purposes for the following: TV monitoring and surveillance, background/foreground music, intercom and telephone interconnect, field programming, inventory control systems, microwave transmission, multi-media, multiplex, radio page, school, intercom and sound burglar alarms and low voltage master clock systems.

Excluded from this classification are energy management systems, life safety systems, supervisory controls and data acquisition systems not intrinsic with the above listed systems, fire alarm systems, nurse call systems and raceways exceeding fifteen feet in length.

TRUCK DRIVER - BUILDING, HEAVY AND HIGHWAY CONSTRUCTION

Class 1. Drivers on 2 axle trucks hauling less than 9 ton. Air compressor and welding machines and brooms, including those pulled by separate units, truck driver helpers, warehouse employees, mechanic helpers, greasers and tiremen, pickup trucks when hauling materials, tools, or workers to and from and on-the-job site, and fork lifts up to 6,000 lb. capacity.

Class 2. Two or three axle trucks hauling more than 9 ton but hauling less than 16 ton. A-frame winch trucks, hydrolift trucks, vactor trucks or similar equipment when used for transportation purposes. Fork lifts over 6,000 lb. capacity, winch trucks, four axle combination units, and ticket writers.

Class 3. Two, three or four axle trucks hauling 16 ton or more. Drivers on water pulls, articulated dump trucks, mechanics and working forepersons, and dispatchers. Five axle or more combination units.

Class 4. Low Boy and Oil Distributors.

Class 5. Drivers who require special protective clothing while employed on hazardous waste work.

TRUCK DRIVER - O & C (Oil and Chip Resealing ONLY)

It involves driving of contractor or subcontractor owned, leased, or

hired pickup, dump, service, or oil distributor trucks. Includes transporting materials and equipment (including, but not limited to oils, aggregate supplies, parts, machinery and tools) to or from the job site; distributing oil or liquid asphalt and aggregate; stock piling material; and maintaining trucks at job site related to oil and chip resealing.

Class 1. Distributors, liquid asphalt hauling and hauling of asphalt rubber-tired rollers.

Class 2. Stockpiling.

Class 3. Tandem hauling to job site.

OPERATING ENGINEERS - BUILDING, HEAVY AND HIGHWAY CONSTRUCTION

Class 1. APSCO or Equal Spreading Machine, Backhoe, Backfiller, Boom or Winch Cat, Bituminous Mixplane Machine, Blacksmith, Bituminous Surfacing Machine, Bull-Dozer, Crane, Shovel, Dragline, Truck Crane, Pile Driver, Concrete Breaker, Concrete or Pumpcrete Pumps, Dinky or Standard Locomotives, Well or Caisson Drills, Elevating Grader, Fork Lifts, Flexplane, Gradeall, Hi-Lift Hoists, Guy-Derricks, Hysters, Mechanic Motor Patrol, Mixers-21 cu. ft. or over, Push Cats, Pulls and Scrapers, Two Well Point Pumps, Pulverizer or Tiller, PugMill, Rubber-Tired Farm Type Tractor with Bulldozer/Blade/Auger or hi-lift over 1/2 yd., Jersey Spreader, Tract-Air used with Drill or Hi-Lift, Trenching or Ditching Machines, Wood Chipper w/Tractor, Self-Propelled Roller w/Blade, Equipment Greaser, Self-Propelled Bump Grinder on Concrete pavement, Boat Operator, Skid-Loaders, Tuggers, Lazer Screed, and Self-Propelled Chip Spreader (when others run conveyors).

Class 2. Any type tractor pulling any type roller or disc, Two Air Compressors (220 cu. ft. capacity or over), Two AirTract Drills, Air-Track Drill w/Compressor, Automatic Bins or Scales w/Compressor or Generator, Pipeline Boring Machine, Bulk Cement Plant w/Separate Compressor, Power Operated Bull Float, Hydra-Lift w/Single Motor, Straw Mulcher Blower w/Spout, Self-Propelled Roller/Compactor, Back-End man on Bituminous Surfacing Machine, oiler on milling machine.

Class 3. Air Compressor w/Valve driving piling, Boom or Winch Type Truck, Two Conveyors, Self-Propelled Concrete Saw, Form Grader, Truck Crane Oiler, Self-Propelled Vibrator, Rubber Tired Farm Type Tractor w/Blade/Bulldozer/Auger/hi-lift - 1/2 yd. or less, Elevator Operator, Man Lift (scissor lift) when lifting materials.

Class 4. Air-Track Drill (one), Belt Drag Machine, Power Broom, Mechanical Plasterer Applicator, Trac-Air, Air Compressor (220 cu. ft. or over) One, Air Compressor (under 220 cu. ft) four, Automatic Bin, Bulk Cement Plant w/Built-in Compressor running off same motor or electric motor, Fireman or Switchman, Self-Propelled Form Tamper, Light Plants (4), Welding Machines (4), Pumps (4), or Combination of four (4) Pumps, Light Plants, Welding Machines, Air-Compressors (under 220 cu. ft.), Mudjacks or Wood Chipper, Mixers - less than 21 cu. ft. Mortar Mixer w/Skip or Pump, Pipeline Tract Jack. One Operating Engineer may operate and maintain any combination of the following pieces of equipment, not to exceed four (4) which shall be within a reasonable distance, such combination may include any equipment in this classification: (Compressors, Light Plants, Generators, Welding Machines, Pumps or Conveyors), One Well- Point Pump, Two Motor Driven Heaters, One Air Compressor (under 220 cu. ft.), One Engine-Driven Conveyor, One Motor Driven Heater, One Light Plant, One Pump, One Welding Machine, One Ulmac or Equal Spreader, Oilers, and one Generator 10 kw or greater.

OPERATING ENGINEER - O & C (Oil and Chip Resealing ONLY). Includes the operation of all motorized heavy equipment used in oil and chip resealing, including but not limited to operating self-propelled chip spreaders, and all types of rollers (both hard and rubber tired); and other duties pertaining to the operation or maintenance of heavy equipment relatd to oil and chip resealing.

Class 1. See Class 1 above for types of equipment operated.

Class 2. See Class 2 above for types of equipment operated.

Class 3. See Class 3 above for types of equipment operated.

Class 4. See Class 4 above for types of equipment operated.

OPERATING ENGINEER RIVER WORK 1 - operate the following machines when working on River Work and Levee Work on the Mississippi and Ohio Rivers, Lakes and Tributaries: Crane, Shovel, Drageline, Scrapers, Dredge, Derrick, Pile-Driver, Push Boat, all power boat operators, Mechanic, Engineman on Dredge, Leverman on Dredge, All Bituminous Spreader machines, Backhoe, Backfiller, Boom, or Winch Cat, Bituminous Mixplane Machine, Blacksmith, Bituminous Surfacing Machine, Bulldozer, Truck Cranes, Hydraulic Truck Mounted Boom/Crane, Concrete Finishing Machine, or Spreader Machine, Concrete Breaker, Concrete or Pumpcrete Machines, Concrete Plant Operator, All Off Road Material Hauling Equipment, Dinky or Standard Locomotives, Well Drill, Elevating Grader, Fork-Lifts, Flexplane, Gradeall, Hi-Lift, Power Handblade Tugger type Hoist, Hoist Two Drum (or over one), Gyderrick, Hyster, Motor Patrol, Mixers - 21 Cu. Ft. or over, Push Cat, Pulls, & Scrapers, Pumps-Two Well Points, Equipment Greaser, P & H Pulverizer or Pulverizer equal to Pugmill, Pugmill, Rubber-Tired farm type tractor w/Bulldozer/Blade/Auger or Hi-Lift over ½ yard, Skimmer Scoops, Seaman Tiller, Jersey Spreader, Tract-Air used with Drill or Hi-Lift, Trenching or Ditching Machine, Wood Chipper w/Tractor, self-propelled roller w/Blade, Concrete Pumps and Small Equipment Operators.

OPERATING ENGINEER RIVER 2 - when working on River Work and Levee Work on the Mississippi and Ohio Rivers, Lakes and Tributaries shall be employed as the Oiler or Fireman on Crane, Dragline, Shovel, Dredge, Truck Crane, Pile Driver, Gradeall, Dinky or Standard Locomotive, Guy Derrick, Trenching Machine or Ditching Machine 80 H.P. and over, All Terrain (cherry-picker) with over 40 ton Lifting Capacity, Deck Oiler and Deckhands.

Other Classifications of Work:

For definitions of classifications not otherwise set out, the Department generally has on file such definitions which are available. If a task to be performed is not subject to one of the classifications of pay set out, the Department will upon being contacted state which neighboring county has such a classification and provide such rate, such rate being deemed to exist by reference in this document. If no neighboring county rate applies to the task, the Department shall undertake a special determination, such special determination being then deemed to have existed under this determination. If a project requires these, or any classification not listed, please contact IDOL at 217-782-1710 for wage rates or clarifications.

LANDSCAPING

Landscaping work falls under the existing classifications for laborer, operating engineer and truck driver. The work performed by landscape

plantsman and landscape laborer is covered by the existing classification of laborer. The work performed by landscape operators (regardless of equipment used or its size) is covered by the classifications of operating engineer. The work performed by landscape truck drivers (regardless of size of truck driven) is covered by the classifications of truck driver.

Hancock County Prevailing Wage for May 2013

(See explanation of column headings at bottom of wages)

Trade Name	RG	TYP	C	Base	FRMAN	M-F>8	OSA	OSH	H/W	Pensn	Vac	Trng
=====	==	===	=	=====	=====	=====	===	===	=====	=====	=====	=====
ASBESTOS ABT-GEN		BLD		27.060	27.810	1.5	1.5	2.0	7.550	10.63	0.000	0.800
ASBESTOS ABT-GEN		HWY		24.600	25.600	1.5	1.5	2.0	7.550	11.50	0.000	0.800
ASBESTOS ABT-MEC		BLD		20.500	21.500	1.5	1.5	2.0	6.250	3.500	0.000	0.000
BOILERMAKER		BLD		35.010	38.010	2.0	2.0	2.0	7.070	13.83	0.000	0.300
BRICK MASON		BLD		29.250	30.250	1.5	1.5	2.0	8.200	8.330	0.000	0.580
CARPENTER		BLD		29.400	31.650	1.5	1.5	2.0	7.450	13.63	0.000	0.520
CARPENTER		HWY		29.210	30.960	1.5	1.5	2.0	7.450	13.61	0.000	0.520
CEMENT MASON		BLD		25.200	26.700	1.5	1.5	2.0	6.600	12.10	0.000	0.500
CEMENT MASON		HWY		27.280	28.280	1.5	1.5	2.0	6.600	9.420	0.000	0.500
CERAMIC TILE FNSHER		BLD		25.600	0.000	1.5	1.5	2.0	8.200	7.230	0.000	0.000
ELECTRIC PWR EQMT OP		ALL		35.440	0.000	1.5	1.5	2.0	5.000	10.98	0.000	0.270
ELECTRIC PWR GRNDMAN		ALL		24.320	0.000	1.5	1.5	2.0	5.000	7.540	0.000	0.180
ELECTRIC PWR LINEMAN		ALL		39.370	41.910	1.5	1.5	2.0	5.000	12.20	0.000	0.300
ELECTRIC PWR TRK DRV		ALL		25.510	0.000	1.5	1.5	2.0	5.000	7.920	0.000	0.190
ELECTRICIAN		BLD		28.360	30.860	1.5	1.5	2.0	5.350	8.550	0.000	0.400
ELECTRONIC SYS TECH		BLD		27.430	29.180	1.5	1.5	2.0	5.350	9.320	0.000	0.400
ELEVATOR CONSTRUCTOR		BLD		40.520	45.585	2.0	2.0	2.0	11.88	12.71	3.240	0.600
GLAZIER		BLD		30.770	32.770	1.5	1.5	2.0	9.700	7.700	0.000	1.250
HT/FROST INSULATOR		BLD		29.190	30.390	1.5	1.5	2.0	5.420	12.05	0.000	0.900
IRON WORKER		ALL		24.440	25.690	1.5	1.5	2.0	7.010	9.890	0.000	0.570
LABORER		BLD		25.560	26.310	1.5	1.5	2.0	7.550	10.63	0.000	0.800
LABORER		HWY		24.600	25.600	1.5	1.5	2.0	7.550	11.50	0.000	0.800
LATHER		BLD		29.400	31.650	1.5	1.5	2.0	7.450	13.63	0.000	0.520
MACHINIST		BLD		43.550	46.050	1.5	1.5	2.0	6.130	8.950	1.850	0.000
MARBLE FINISHERS		BLD		25.600	0.000	1.5	1.5	2.0	8.200	7.230	0.000	0.000
MARBLE MASON		BLD		27.100	27.850	1.5	1.5	2.0	8.200	7.230	0.000	0.000
MILLWRIGHT		BLD		30.240	32.490	1.5	1.5	2.0	7.450	13.09	0.000	0.520
MILLWRIGHT		HWY		31.690	33.440	1.5	1.5	2.0	7.450	13.54	0.000	0.520
OPERATING ENGINEER		BLD	1	36.000	39.000	1.5	1.5	2.0	9.750	13.60	0.000	3.000
OPERATING ENGINEER		BLD	2	33.490	39.000	1.5	1.5	2.0	9.750	13.60	0.000	3.000
OPERATING ENGINEER		BLD	3	29.340	39.000	1.5	1.5	2.0	9.750	13.60	0.000	3.000
OPERATING ENGINEER		HWY	1	36.000	39.500	1.5	1.5	2.0	9.750	13.60	0.000	3.000
OPERATING ENGINEER		HWY	2	33.490	39.500	1.5	1.5	2.0	9.750	13.60	0.000	3.000
OPERATING ENGINEER		HWY	3	29.340	39.500	1.5	1.5	2.0	9.750	13.60	0.000	3.000
PAINTER		ALL		32.900	34.900	1.5	1.5	1.5	9.650	8.200	0.000	1.250
PILEDRIVER		BLD		29.900	32.150	1.5	1.5	2.0	7.450	13.63	0.000	0.520
PILEDRIVER		HWY		30.210	31.960	1.5	1.5	2.0	7.450	13.61	0.000	0.520
PIPEFITTER	E	BLD		37.400	41.510	1.5	1.5	2.0	7.000	11.63	0.000	1.060
PIPEFITTER	W	ALL		36.550	40.210	1.5	1.5	2.0	5.650	12.15	0.000	1.000
PLASTERER		BLD		28.500	30.250	1.5	1.5	2.0	7.330	11.29	0.000	0.500
PLUMBER	E	BLD		33.570	36.590	1.5	1.5	2.0	7.000	13.31	0.000	0.900
PLUMBER	W	ALL		36.550	40.210	1.5	1.5	2.0	5.650	12.15	0.000	1.000
ROOFER		BLD		28.580	30.010	1.5	1.5	2.0	8.450	7.220	0.000	0.250
SHEETMETAL WORKER		BLD		26.150	27.950	1.5	1.5	2.0	7.140	9.340	0.000	0.540
SPRINKLER FITTER		BLD		36.390	39.140	1.5	1.5	2.0	8.420	8.500	0.000	0.450
STONE MASON		BLD		29.250	30.250	1.5	1.5	2.0	8.200	8.330	0.000	0.580
TERRAZZO FINISHER		BLD		25.600	0.000	1.5	1.5	2.0	8.200	7.230	0.000	0.000
TILE MASON		BLD		27.100	27.850	1.5	1.5	2.0	8.200	7.230	0.000	0.000
TRUCK DRIVER		ALL	1	31.230	0.000	1.5	1.5	2.0	10.30	4.840	0.000	0.250
TRUCK DRIVER		ALL	2	31.680	0.000	1.5	1.5	2.0	10.30	4.840	0.000	0.250
TRUCK DRIVER		ALL	3	31.890	0.000	1.5	1.5	2.0	10.30	4.840	0.000	0.250

TRUCK DRIVER	ALL	4	32.180	0.000	1.5	1.5	2.0	10.30	4.840	0.000	0.250
TRUCK DRIVER	ALL	5	33.020	0.000	1.5	1.5	2.0	10.30	4.840	0.000	0.250
TRUCK DRIVER	O&C	1	24.980	0.000	1.5	1.5	2.0	10.30	4.840	0.000	0.250
TRUCK DRIVER	O&C	2	25.340	0.000	1.5	1.5	2.0	10.30	4.840	0.000	0.250
TRUCK DRIVER	O&C	3	25.510	0.000	1.5	1.5	2.0	10.30	4.840	0.000	0.250
TRUCK DRIVER	O&C	4	25.740	0.000	1.5	1.5	2.0	10.30	4.840	0.000	0.250
TRUCK DRIVER	O&C	5	26.420	0.000	1.5	1.5	2.0	10.30	4.840	0.000	0.250
TUCKPOINTER	BLD		29.250	30.250	1.5	1.5	2.0	8.200	8.330	0.000	0.580

Legend:

RG (Region)

TYP (Trade Type - All,Highway,Building,Floating,Oil & Chip,Rivers)

C (Class)

Base (Base Wage Rate)

FRMAN (Foreman Rate)

M-F>8 (OT required for any hour greater than 8 worked each day, Mon through Fri.

OSA (Overtime (OT) is required for every hour worked on Saturday)

OSH (Overtime is required for every hour worked on Sunday and Holidays)

H/W (Health & Welfare Insurance)

Pensn (Pension)

Vac (Vacation)

Trng (Training)

Explanations

HANCOCK COUNTY

PLUMBERS & PIPEFITTERS (WEST) - That part of the county West of Rt. 94 excluding the City of Carthage by one mile.

The following list is considered as those days for which holiday rates of wages for work performed apply: New Years Day, Memorial Day, Fourth of July, Labor Day, Thanksgiving Day, Christmas Day and Veterans Day in some classifications/counties. Generally, any of these holidays which fall on a Sunday is celebrated on the following Monday. This then makes work performed on that Monday payable at the appropriate overtime rate for holiday pay. Common practice in a given local may alter certain days of celebration. If in doubt, please check with IDOL.

Oil and chip resealing (O&C) means the application of road oils and liquid asphalt to coat an existing road surface, followed by application of aggregate chips or gravel to coated surface, and subsequent rolling of material to seal the surface.

EXPLANATION OF CLASSES

ASBESTOS - GENERAL - removal of asbestos material/mold and hazardous materials from any place in a building, including mechanical systems

where those mechanical systems are to be removed. This includes the removal of asbestos materials/mold and hazardous materials from ductwork or pipes in a building when the building is to be demolished at the time or at some close future date.

ASBESTOS - MECHANICAL - removal of asbestos material from mechanical systems, such as pipes, ducts, and boilers, where the mechanical systems are to remain.

CERAMIC TILE FINISHER, MARBLE FINISHER, TERRAZZO FINISHER

Assisting, helping or supporting the tile, marble and terrazzo mechanic by performing their historic and traditional work assignments required to complete the proper installation of the work covered by said crafts. The term "Ceramic" is used for naming the classification only and is in no way a limitation of the product handled. Ceramic takes into consideration most hard tiles.

ELECTRONIC SYSTEMS TECHNICIAN

Installation, service and maintenance of low-voltage systems which utilizes the transmission and/or transference of voice, sound, vision, or digital for commercial, education, security and entertainment purposes for the following: TV monitoring and surveillance, background/foreground music, intercom and telephone interconnect, field programming, inventory control systems, microwave transmission, multi-media, multiplex, radio page, school, intercom and sound burglar alarms and low voltage master clock systems.

Excluded from this classification are energy management systems, life safety systems, supervisory controls and data acquisition systems not intrinsic with the above listed systems, fire alarm systems, nurse call systems and raceways exceeding fifteen feet in length.

TRUCK DRIVER - BUILDING, HEAVY AND HIGHWAY CONSTRUCTION

Class 1. Drivers on 2 axle trucks hauling less than 9 ton. Air compressor and welding machines and brooms, including those pulled by separate units, truck driver helpers, warehouse employees, mechanic helpers, greasers and tiremen, pickup trucks when hauling materials, tools, or workers to and from and on-the-job site, and fork lifts up to 6,000 lb. capacity.

Class 2. Two or three axle trucks hauling more than 9 ton but hauling less than 16 ton. A-frame winch trucks, hydrolift trucks, vector trucks or similar equipment when used for transportation purposes. Fork lifts over 6,000 lb. capacity, winch trucks, four axle combination units, and ticket writers.

Class 3. Two, three or four axle trucks hauling 16 ton or more. Drivers on water pulls, articulated dump trucks, mechanics and working forepersons, and dispatchers. Five axle or more combination units.

Class 4. Low Boy and Oil Distributors.

Class 5. Drivers who require special protective clothing while employed on hazardous waste work.

TRUCK DRIVER - OIL AND CHIP RESEALING ONLY.

This shall encompass laborers, workers and mechanics who drive contractor or subcontractor owned, leased, or hired pickup, dump, service, or oil distributor trucks. The work includes transporting materials and equipment (including but not limited to, oils, aggregate supplies, parts, machinery and tools) to or from the job site;

distributing oil or liquid asphalt and aggregate; stock piling material when in connection with the actual oil and chip contract. The Truck Driver (Oil & Chip Resealing) wage classification does not include supplier delivered materials.

OPERATING ENGINEERS - BUILDING

Class 1. Cranes; Overhead Cranes; Gradall; All Cherry Pickers; Mechanics; Central Concrete Mixing Plant Operator; Road Pavers (27E - Dual Drum - Tri Batchers); Blacktop Plant Operators and Plant Engineers; 3 Drum Hoist; Derricks; Hydro Cranes; Shovels; Skimmer Scoops; Koehring Scooper; Drag Lines; Backhoe; Derrick Boats; Pile Drivers and Skid Rigs; Clamshells; Locomotive Cranes; Dredge (all types) Motor Patrol; Power Blades - Dumore - Elevating and similar types; Tower Cranes (Crawler-Mobile) and Stationary; Crane-type Backfiller; Drott Yumbo and similar types considered as Cranes; Caisson Rigs; Dozer; Tournadozer; Work Boats; Ross Carrier; Helicopter; Tournapulls - all and similar types; Scoops (all sizes); Pushcats; Endloaders (all types); Asphalt Surfacing Machine; Slip Form Paver; Rock Crusher; Heavy Equipment Greaser; CMI, CMI Belt Placer, Auto Grade & 3 Track and similar types; Side Booms; Multiple Unit Earth Movers; Creter Crane; Trench Machine; Pump-crete-Belt Crete-Squeeze Cretes-Screw-type Pumps and Gypsum; Bulker & Pump - Operator will clean; Formless Finishing Machine; Flaherty Spreader or similar types; Screed Man on Laydown Machine; Wheel Tractors (industrial or Farm-type w/Dozer-Hoe-Endloader or other attachments); F.W.D. & Similar Types; Vermeer Concrete Saw.

Class 2. Dinkeys; Power Launches; PH One-pass Soil Cement Machine (and similar types); Pugmill with Pump; Backfillers; Euclid Loader; Forklifts; Jeeps w/Ditching Machine or other attachments; Tuneluger; Automatic Cement and Gravel Batching Plants; Mobile Drills (Soil Testing) and similar types; Gurries and Similar Types; (1) and (2) Drum Hoists (Buck Hoist and Similar Types); Chicago Boom; Boring Machine & Pipe Jacking Machine; Hydro Boom; Dewatering System; Straw Blower; Hydro Seeder; Assistant Heavy Equipment Greaser on Spread; Tractors (Track type) without Power Unit pulling Rollers; Rollers on Asphalt -- Brick Macadem; Concrete Breakers; Concrete Spreaders; Mule Pulling Rollers; Center Stripper; Cement Finishing Machines & CMI Texture & Reel Curing Machines; Cement Finishing Machine; Barber Green or similar loaders; Vibro Tamper (All similar types) Self-propelled; Winch or Boom Truck; Mechanical Bull Floats; Mixers over 3 Bag to 27E; Tractor pulling Power Blade or Elevating Grader; Porter Rex Rail; Clary Screed; Truck Type Hoptoe Oilers; Fireman; Spray Machine on Paving; Curb Machines; Truck Crane Oilers; Oil Distributor; Truck-Mounted Saws.

Class 3. Air Compressor; Power Subgrader; Straight Tractor; Trac Air without attachments; Herman Nelson Heater, Dravo, Warner, Silent Glo, and similar types; Roller: Five (5) Ton and under on Earth or Gravel; Form Grader; Crawler Crane & Skid Rig Oilers; Freight Elevators - permanently installed; Pump; Light Plant; Generator; Conveyor (1) or (2) - Operator will clean; Welding Machine; Mixer (3) Bag and Under (Standard Capacity with skip); Bulk Cement Plant; Oiler on Central Concrete Mixing Plant.

OPERATING ENGINEERS - HEAVY AND HIGHWAY CONSTRUCTION

CLASS 1. Cranes; Hydro Cranes; Shovels; Crane Type Backfiller; Tower, Mobile, Crawler, & Stationary Cranes; Derricks; Hoists (3 Drum); Draglines; Drott Yumbo & Similar Types considered as Cranes; 360 Degree Swing Excavator (Shears, Grapples, Movacs, etc.); Back Hoe; Derrick Boats; Pile Driver and Skid Rigs; Clam Shell; Locomotive - Cranes; Road Pavers - Single Drum - Dual Drum - Tri Batchers; Motor Patrols & Power Blades - Dumore - Elevating & Similar Types;

Mechanics; Central Concrete Mixing Plant Operator; Asphalt Batch Plant Operators and Plant Engineers; Gradall; Caisson Rigs; Skimmer Scoop - Koering Scooper; Dredges (all types); Hoptoe; All Cherry Pickers; Work Boat; Ross Carrier; Helicopter; Dozer; Tournadozer; Tournapulls - all and similar types; Operation of Concrete and all Recycle Machines; Multiple Unit Earth Movers; Scoops (all sizes); Pushcats; Endloaders (all types); Asphalt Surfacing Machine; Slip Form Paver; Rock Crusher; Operation of Material Crusher, Screening Plants, and Tunnel Boring Machine; Heavy Equipment Greaser (top greaser on spread); CMI, Auto Grade, CMI Belt Placer & 3 Track and Similar Types; Side Booms; Asphalt Heater & Planer Combination (used to plane streets); Wheel Tractors (with Dozer, Hoe or Endloader Attachments); CAT Earthwork Compactors and Similar Types; Blaw Knox Spreader and Similar Types; Trench Machines; Pump Crete - Belt Crete - Squeeze Crete - Screw Type Pumps and Gypsum (operator will clean); Creter Crane; Operation of Concrete Pump Truck; Formless Finishing Machines; Flaherty Spreader or Similar Types; Screed Man on Laydown Machine; Vermeer Concrete Saw; Operation of Laser Screed; Span Saw; Dredge Leverman; Dredge Engineer; Lull or Similar Type; Hydro-Boom Truck; Operation of Guard Rail Machine; and Starting Engineer on Pipeline or Construction (11 or more pieces) including: Air Compressor (Trailer Mounted), All Forced Air Heaters (regardless of Size), Water Pumps (Greater than 4-1/2" or Total Discharge Over 4-1/2"), Light Plants, Generators (Trailer Mounted - Excluding Decontamination Trailer), Welding Machines (Any Size or Mode of Power), Conveyor, Mixer (any size), Stud Welder, Power Pac, etc, and Ground Heater (Trailer Mounted).

CLASS 2. Bulker & Pump; Power Launches; Boring Machine & Pipe Jacking Machine; Dinkeys; Operation of Carts, Powered Haul Unit for a Boring Machine; P & H One Pass Soil Cement Machines and Similar Types; Wheel Tractors (Industry or Farm Type - Other); Back Fillers; Euclid Loader; Fork Lifts; Jeep w/Ditching Machine or Other Attachments; Tunneluger; Automatic Cement & Gravel Batching Plants; Mobile Drills - Soil Testing and Similar Types; Pugmill with Pump; All (1) and (2) Drum Hoists; Dewatering System; Straw Blower; Hydro-Seeder; Bump Grinders (self-propelled); Assistant Heavy Equipment Greaser; Apsco Spreader; Tractors (Track-Type) without Power Units Pulling Rollers; Rollers on Asphalt - Brick or Macadam; Concrete Breakers; Concrete Spreaders; Cement Strippers; Cement Finishing Machines & CMI Texture & Reel Curing Machines; Vibro-Tampers (All Similar Types Self-Propelled); Mechanical Bull Floats; Self-Propelled Concrete Saws; Truck Mounted Power Saws; Operation of Curb Cutters; Mixers - Over Three (3) Bags; Winch and Boom Trucks; Tractor Pulling Power Blade or Elevating Grader; Porter Rex Rail; Clary Screed; Mule Pulling Rollers; Pugmill without Pump; Barber Greene or Similar Loaders; Track Type Tractor w/Power Unit attached (minimum); Fireman; Spray Machine on Paving; Curb Machines; Paved Ditch Machine; Power Broom; Self-Propelled Sweepers; Self-Propelled Conveyors; Power Subgrader; Oil Distributor; Straight Tractor; Truck Crane Oiler; Truck Type Oilers; Directional Boring Machine; Horizontal Directional Drill; Articulating End Dump Vehicles; Starting Engineer on Pipeline or Construction (6 -10 pieces) including: Air Compressor (Trailer Mounted), All Forced Air Heaters (regardless of Size), Water Pumps (Greater than 4-1/2" or Total Discharge Over 4-1/2"), Light Plants, Generators (Trailer Mounted - Excluding Decontamination Trailer), Welding Machines (Any Size or Mode of Power), Conveyor, Mixer (any size), Stud Welder, Power Pac, etc., and Ground Heater (Trailer Mounted).

CLASS 3. Straight Framed Truck Mounted Vac Unit (separately powered); Trac Air Machine (without attachments); Rollers - Five Ton and Under on Earth and Gravel; Form Graders; Bulk Cement Plant; Oilers; and Starting Engineer on Pipeline or Construction (3 - 5 pieces) including: Air Compressor (Trailer Mounted), All Forced Air Heaters (regardless of Size), Water Pumps (Greater than 4-1/2" or Total

Discharge Over 4-1/2"), Light Plants, Generators (Trailer Mounted - Excluding Decontamination Trailer), Welding Machines (Any Size or Mode of Power), Conveyor, Mixer (any size), Stud Welder, Power Pac, etc., and Ground Heater (Trailer Mounted).

Other Classifications of Work:

For definitions of classifications not otherwise set out, the Department generally has on file such definitions which are available. If a task to be performed is not subject to one of the classifications of pay set out, the Department will upon being contacted state which neighboring county has such a classification and provide such rate, such rate being deemed to exist by reference in this document. If no neighboring county rate applies to the task, the Department shall undertake a special determination, such special determination being then deemed to have existed under this determination. If a project requires these, or any classification not listed, please contact IDOL at 217-782-1710 for wage rates or clarifications.

LANDSCAPING

Landscaping work falls under the existing classifications for laborer, operating engineer and truck driver. The work performed by landscape plantsman and landscape laborer is covered by the existing classification of laborer. The work performed by landscape operators (regardless of equipment used or its size) is covered by the classifications of operating engineer. The work performed by landscape truck drivers (regardless of size of truck driven) is covered by the classifications of truck driver.

Hardin County Prevailing Wage for May 2013

(See explanation of column headings at bottom of wages)

Trade Name	RG	TYP	C	Base	FRMAN	M-F>8	OSA	OSH	H/W	Pensn	Vac	Trng
=====	==	===	=	=====	=====	=====	===	===	=====	=====	=====	=====
ASBESTOS ABT-GEN		ALL		25.300	25.750	1.5	1.5	2.0	5.750	10.35	0.000	0.900
ASBESTOS ABT-MEC		BLD		21.150	22.150	1.5	1.5	2.0	6.400	5.150	0.000	0.650
BOILERMAKER		BLD		31.500	34.000	1.5	1.5	2.0	7.070	18.73	1.000	0.350
BRICK MASON		BLD		28.620	30.120	1.5	1.5	2.0	8.200	7.030	0.000	0.430
CARPENTER		BLD		31.890	33.390	1.5	1.5	2.0	6.550	6.750	0.000	0.400
CARPENTER		HWY		31.840	33.340	1.5	1.5	2.0	6.550	6.750	0.000	0.400
CEMENT MASON		BLD		28.200	29.700	1.5	1.5	2.0	6.600	5.400	0.000	0.500
CEMENT MASON		HWY		27.290	28.290	1.5	1.5	2.0	6.600	5.160	0.000	0.400
CERAMIC TILE FNSHER		BLD		27.120	0.000	1.5	1.5	2.0	8.200	7.030	0.000	0.430
ELECTRIC PWR EQMT OP	1	ALL		35.570	0.000	1.5	1.5	2.0	5.000	9.960	0.000	0.360
ELECTRIC PWR EQMT OP	2	ALL		31.740	0.000	1.5	1.5	2.0	5.000	8.880	0.000	0.320
ELECTRIC PWR GRNDMAN		ALL		26.100	0.000	1.5	1.5	2.0	5.000	7.310	0.000	0.260
ELECTRIC PWR LINEMAN		ALL		44.630	47.650	1.5	1.5	2.0	5.000	12.50	0.000	0.450
ELECTRICIAN		ALL		39.350	41.600	1.5	1.5	2.0	6.140	9.440	0.000	0.790
ELECTRONIC SYS TECH		BLD		32.570	34.320	1.5	1.5	2.0	6.000	4.240	0.000	0.400
FLOOR LAYER		BLD		29.330	30.080	1.5	1.5	2.0	6.550	6.750	0.000	0.400
GLAZIER		BLD		26.780	28.030	1.5	1.5	2.0	6.120	5.200	0.000	0.300
HT/FROST INSULATOR		BLD		29.450	30.450	1.5	1.5	2.0	5.050	9.730	0.000	0.280
IRON WORKER		ALL		27.730	29.730	1.5	1.5	2.0	7.010	11.41	0.000	0.500
LABORER		BLD		25.300	25.750	1.5	1.5	2.0	5.750	10.35	0.000	0.800
LABORER		HWY		25.300	25.750	1.5	1.5	2.0	5.750	10.35	0.000	0.800
LABORER		O&C		17.740	18.190	1.5	1.5	2.0	5.450	8.450	0.000	0.800
MACHINIST		BLD		43.550	46.050	1.5	1.5	2.0	6.130	8.950	1.850	0.000
MARBLE FINISHERS		BLD		27.120	0.000	1.5	1.5	2.0	8.200	7.030	0.000	0.430
MARBLE MASON		BLD		28.620	30.120	1.5	1.5	2.0	8.200	7.030	0.000	0.430
MILLWRIGHT		BLD		31.890	33.390	1.5	1.5	2.0	6.550	6.750	0.000	0.400
MILLWRIGHT		HWY		31.840	33.340	1.5	1.5	2.0	6.550	6.750	0.000	0.400

OE RIVER 1	RIV 1	33.550	34.550	1.5	1.5	2.0	7.000	8.800	0.000	1.450
OE RIVER 2	RIV 2	30.100	34.550	1.5	1.5	2.0	7.000	8.800	0.000	1.450
OPERATING ENGINEER	ALL 1	33.450	34.450	1.5	1.5	2.0	7.000	8.800	0.000	1.450
OPERATING ENGINEER	ALL 2	31.550	34.450	1.5	1.5	2.0	7.000	8.800	0.000	1.450
OPERATING ENGINEER	ALL 3	24.150	34.450	1.5	1.5	2.0	7.000	8.800	0.000	1.450
OPERATING ENGINEER	ALL 4	21.400	27.800	1.5	1.5	2.0	5.650	6.100	0.000	1.100
OPERATING ENGINEER	O&C 1	25.090	26.090	1.5	1.5	2.0	7.000	8.800	0.000	1.450
OPERATING ENGINEER	O&C 2	23.660	26.090	1.5	1.5	2.0	7.000	8.800	0.000	1.450
OPERATING ENGINEER	O&C 3	18.120	26.090	1.5	1.5	2.0	7.000	8.800	0.000	1.450
OPERATING ENGINEER	O&C 4	16.050	21.100	1.5	1.5	2.0	5.650	6.100	0.000	1.100
PAINTER	BLD	26.260	27.760	1.5	1.5	2.0	6.630	7.070	0.000	0.500
PAINTER	HWY	30.560	32.060	1.5	1.5	2.0	6.630	7.070	0.000	0.500
PAINTER OVER 30FT	BLD	27.260	28.760	1.5	1.5	2.0	6.630	7.070	0.000	0.500
PAINTER PWR EQMT	BLD	27.260	28.760	1.5	1.5	2.0	6.630	7.070	0.000	0.500
PAINTER PWR EQMT	HWY	31.560	33.060	1.5	1.5	2.0	6.630	7.070	0.000	0.500
PILEDRIVER	BLD	31.890	33.390	1.5	1.5	2.0	6.550	6.750	0.000	0.400
PILEDRIVER	HWY	31.840	33.340	1.5	1.5	2.0	6.550	6.750	0.000	0.400
PIPEFITTER	BLD	41.470	45.620	1.5	2.0	2.0	8.450	5.780	0.000	1.250
PLASTERER	BLD	28.200	29.700	1.5	1.5	2.0	6.600	5.400	0.000	0.500
PLUMBER	BLD	41.470	45.620	1.5	2.0	2.0	8.450	5.780	0.000	1.250
ROOFER	BLD	27.240	29.240	1.5	1.5	2.0	7.200	5.250	0.000	0.540
SHEETMETAL WORKER	ALL	31.690	33.190	1.5	1.5	2.0	7.130	6.730	1.910	0.360
SPRINKLER FITTER	BLD	36.390	39.140	1.5	1.5	2.0	8.420	8.500	0.000	0.450
STONE MASON	BLD	28.620	30.120	1.5	1.5	2.0	8.200	7.030	0.000	0.430
TERRAZZO FINISHER	BLD	27.120	0.000	1.5	1.5	2.0	8.200	7.030	0.000	0.430
TRUCK DRIVER	ALL 1	30.070	0.000	1.5	1.5	2.0	10.30	6.100	0.000	0.250
TRUCK DRIVER	ALL 2	30.520	0.000	1.5	1.5	2.0	10.30	6.100	0.000	0.250
TRUCK DRIVER	ALL 3	30.740	0.000	1.5	1.5	2.0	10.30	6.100	0.000	0.250
TRUCK DRIVER	ALL 4	31.030	0.000	1.5	1.5	2.0	10.30	6.100	0.000	0.250
TRUCK DRIVER	ALL 5	31.850	0.000	1.5	1.5	2.0	10.30	6.100	0.000	0.250
TRUCK DRIVER	O&C 1	22.750	0.000	1.5	1.5	2.0	2.920	6.700	0.000	0.250
TRUCK DRIVER	O&C 2	19.150	0.000	1.5	1.5	2.0	2.920	6.700	0.000	0.250
TRUCK DRIVER	O&C 3	19.650	0.000	1.5	1.5	2.0	2.920	6.700	0.000	0.250
TUCKPOINTER	BLD	28.620	30.120	1.5	1.5	2.0	8.200	7.030	0.000	0.430

Legend :

RG (Region)

TYP (Trade Type - All,Highway,Building,Floating,Oil & Chip,Rivers)

C (Class)

Base (Base Wage Rate)

FRMAN (Foreman Rate)

M-F>8 (OT required for any hour greater than 8 worked each day, Mon through Fri.

OSA (Overtime (OT) is required for every hour worked on Saturday)

OSH (Overtime is required for every hour worked on Sunday and Holidays)

H/W (Health & Welfare Insurance)

Pensn (Pension)

Vac (Vacation)

Trng (Training)

Explanations

HARDIN COUNTY

The following list is considered as those days for which holiday rates of wages for work performed apply: New Years Day, Memorial Day, Fourth of July, Labor Day, Thanksgiving Day, Christmas Day and Veterans Day in some classifications/counties. Generally, any of these holidays which fall on a Sunday is celebrated on the following Monday. This then makes work performed on that Monday payable at the appropriate overtime rate for holiday pay. Common practice in a given local may alter certain days of celebration. If in doubt, please check with IDOL.

Oil and chip resealing (O&C) means the application of road oils and liquid asphalt to coat an existing road surface, followed by application of aggregate chips or gravel to coated surface, and subsequent rolling of material to seal the surface.

EXPLANATION OF CLASSES

ASBESTOS - GENERAL - removal of asbestos material/mold and hazardous materials from any place in a building, including mechanical systems where those mechanical systems are to be removed. This includes the removal of asbestos materials/mold and hazardous materials from ductwork or pipes in a building when the building is to be demolished at the time or at some close future date.

ASBESTOS - MECHANICAL - removal of asbestos material from mechanical systems, such as pipes, ducts, and boilers, where the mechanical systems are to remain.

LABORER - OIL AND CHIP RESEALING ONLY

Hook and unhook chip box from aggregate truck; distribute material within chip box; perform flagging work related to oil and chip resealing; hand spray oil fluids; handle traffic control, including setting-up and maintaining barricades, drums, cones, delineators, signs and other such items, as well as laying-out and applying or removing temporary roadway markings used to control traffic in job site related to oil and chip resealing; and perform clean-up related to oil and chip resealing.

CERAMIC TILE FINISHER, MARBLE FINISHER, TERRAZZO FINISHER

Assisting, helping or supporting the tile, marble and terrazzo mechanic by performing their historic and traditional work assignments required to complete the proper installation of the work covered by said crafts. The term "Ceramic" is used for naming the classification only, and is in no a limitation of the product handled. Ceramic takes into consideration most hard tiles.

ELECTRIC POWER LINEMAN

Construction, maintenance and dismantling of overhead and underground electric power lines, including high voltage pipe type cable work, and associated structures and equipment.

ELECTRIC POWER EQUIPMENT OPERATOR - CLASS 1

Operation of all crawler type equipment D-4 and larger from the ground to assist the Electric Power Linemen in performing their duties.

ELECTRIC POWER EQUIPMENT OPERATORS - CLASS 2

Operation of all other equipment from the ground to assist the Electric Power Linemen in performing their duties.

ELECTRIC POWER GROUNDMAN

Applies to workers who assist the Electric Power Lineman from the ground.

ELECTRONIC SYSTEMS TECHNICIAN

Installation, service and maintenance of low-voltage systems which utilizes the transmission and/or transference of voice, sound, vision, or digital for commercial, education, security and entertainment purposes for the following: TV monitoring and surveillance, background/foreground music, intercom and telephone interconnect, field programming, inventory control systems, microwave transmission, multi-media, multiplex, radio page, school, intercom and sound burglar alarms and low voltage master clock systems.

Excluded from this classification are energy management systems, life safety systems, supervisory controls and data acquisition systems not intrinsic with the above listed systems, fire alarm systems, nurse call systems and raceways exceeding fifteen feet in length.

TRUCK DRIVER - BUILDING, HEAVY AND HIGHWAY CONSTRUCTION

Class 1. Drivers on 2 axle trucks hauling less than 9 ton. Air compressor and welding machines and brooms, including those pulled by separate units, truck driver helpers, warehouse employees, mechanic helpers, greasers and tiremen, pickup trucks when hauling materials, tools, or workers to and from and on-the-job site, and fork lifts up to 6,000 lb. capacity.

Class 2. Two or three axle trucks hauling more than 9 ton but hauling less than 16 ton. A-frame winch trucks, hydrolift trucks, vector trucks or similar equipment when used for transportation purposes. Fork lifts over 6,000 lb. capacity, winch trucks, four axle combination units, and ticket writers.

Class 3. Two, three or four axle trucks hauling 16 ton or more. Drivers on water pulls, articulated dump trucks, mechanics and working forepersons, and dispatchers. Five axle or more combination units.

Class 4. Low Boy and Oil Distributors.

Class 5. Drivers who require special protective clothing while employed on hazardous waste work.

TRUCK DRIVER - O & C (Oil and Chip Resealing ONLY)

It involves driving of contractor or subcontractor owned, leased, or hired pickup, dump, service, or oil distributor trucks. Includes transporting materials and equipment (including, but not limited to oils, aggregate supplies, parts, machinery and tools) to or from the job site; distributing oil or liquid asphalt and aggregate; stock piling material; and maintaining trucks at job site related to oil and chip resealing.

Class 1. Distributors, liquid asphalt hauling and hauling of asphalt rubber-tired rollers.

Class 2. Stockpiling.

Class 3. Tandem hauling to job site.

OPERATING ENGINEERS - BUILDING, HEAVY AND HIGHWAY CONSTRUCTION

Class 1. APSCO or Equal Spreading Machine, Backhoe, Backfiller, Boom or Winch Cat, Bituminous Mixplane Machine, Blacksmith, Bituminous Surfacing Machine, Bull-Dozer, Crane, Shovel, Dragline, Truck Crane, Pile Driver, Concrete Breaker, Concrete or Pumpcrete Pumps, Dinky or Standard Locomotives, Well or Caisson Drills, Elevating Grader, Fork Lifts, Flexplane, Gradeall, Hi-Lift Hoists, Guy-Derricks, Hysters, Mechanic Motor Patrol, Mixers-21 cu. ft. or over, Push Cats, Pulls and Scrapers, Two Well Point Pumps, Pulverizer or Tiller, PugMill, Rubber-Tired Farm Type Tractor with Bulldozer/Blade/Auger or hi-lift over 1/2 yd., Jersey Spreader, Tract-Air used with Drill or Hi-Lift, Trenching or Ditching Machines, Wood Chipper w/Tractor, Self-Propelled Roller w/Blade, Equipment Greaser, Self-Propelled Bump Grinder on Concrete pavement, Boat Operator, Skid-Loaders, Tuggers, Lazer Screed, and Self-Propelled Chip Spreader (when others run conveyors).

Class 2. Any type tractor pulling any type roller or disc, Two Air Compressors (220 cu. ft. capacity or over), Two AirTract Drills, Air-Track Drill w/Compressor, Automatic Bins or Scales w/Compressor or Generator, Pipeline Boring Machine, Bulk Cement Plant w/Separate Compressor, Power Operated Bull Float, Hydra-Lift w/Single Motor, Straw Mulcher Blower w/Spout, Self-Propelled Roller/Compactor, Back-End man on Bituminous Surfacing Machine, oiler on milling machine.

Class 3. Air Compressor w/Valve driving piling, Boom or Winch Type Truck, Two Conveyors, Self-Propelled Concrete Saw, Form Grader, Truck Crane Oiler, Self-Propelled Vibrator, Rubber Tired Farm Type Tractor w/Blade/Bulldozer/Auger/hi-lift - 1/2 yd. or less, Elevator Operator, Man Lift (scissor lift) when lifting materials.

Class 4. Air-Track Drill (one), Belt Drag Machine, Power Broom, Mechanical Plasterer Applicator, Trac-Air, Air Compressor (220 cu. ft. or over) One, Air Compressor (under 220 cu. ft) four, Automatic Bin, Bulk Cement Plant w/Built-in Compressor running off same motor or electric motor, Fireman or Switchman, Self-Propelled Form Tamper, Light Plants (4), Welding Machines (4), Pumps (4), or Combination of four (4) Pumps, Light Plants, Welding Machines, Air-Compressors (under 220 cu. ft.), Mudjacks or Wood Chipper, Mixers - less than 21 cu. ft. Mortar Mixer w/Skip or Pump, Pipeline Tract Jack. One Operating Engineer may operate and maintain any combination of the following pieces of equipment, not to exceed four (4) which shall be within a reasonable distance, such combination may include any equipment in this classification: (Compressors, Light Plants, Generators, Welding Machines, Pumps or Conveyors), One Well- Point Pump, Two Motor Driven Heaters, One Air Compressor (under 220 cu. ft.), One Engine-Driven Conveyor, One Motor Driven Heater, One Light Plant, One Pump, One Welding Machine, One Ulmac or Equal Spreader, Oilers, and one Generator 10 kw or greater.

OPERATING ENGINEER - O & C (Oil and Chip Resealing ONLY). Includes the operation of all motorized heavy equipment used in oil and chip rsealing, including but not limited to operating self-propelled chip spreaders, and all types of rollers (both hard and rubber tired); and other duties pertaining to the operation or maintenance of heavy equipment relatd to oil and chip resealing.

Class 1. See Class 1 above for types of equipment operated.

Class 2. See Class 2 above for types of equipment operated.

Class 3. See Class 3 above for types of equipment operated.

Class 4. See Class 4 above for types of equipment operated.

OPERATING ENGINEER RIVER WORK 1 - operate the following machines when working on River Work and Levee Work on the Mississippi and Ohio Rivers, Lakes and Tributaries: Crane, Shovel, Drageline, Scrapers, Dredge, Derrick, Pile-Driver, Push Boat, all power boat operators, Mechanic, Engineman on Dredge, Leverman on Dredge, All Bituminous Spreader machines, Backhoe, Backfiller, Boom, or Winch Cat, Bituminous Mixplane Machine, Blacksmith, Bituminous Surfacing Machine, Bulldozer, Truck Cranes, Hydraulic Truck Mounted Boom/Crane, Concrete Finishing Machine, or Spreader Machine, Concrete Breaker, Concrete or Pumpcrete Machines, Concrete Plant Operator, All Off Road Material Hauling Equipment, Dinky or Standard Locomotives, Well Drill, Elevating Grader, Fork-Lifts, Flexplane, Gradeall, Hi-Lift, Power Handblade Tugger type Hoist, Hoist Two Drum (or over one), Gyderrick, Hyster, Motor Patrol, Mixers - 21 Cu. Ft. or over, Push Cat, Pulls, & Scrapers, Pumps-Two Well Points, Equipment Greaser, P & H Pulverizer or Pulverizer equal to Pugmill, Pugmill, Rubber-Tired farm type tractor w/Bulldozer/Blade/Auger or Hi-Lift over ½ yard, Skimmer Scoops, Seaman Tiller, Jersey Spreader, Tract-Air used with Drill or Hi-Lift, Trenching or Ditching Machine, Wood Chipper w/Tractor, self-propelled roller w/Blade, Concrete Pumps and Small Equipment Operators.

OPERATING ENGINEER RIVER 2 - when working on River Work and Levee Work on the Mississippi and Ohio Rivers, Lakes and Tributaries shall be employed as the Oiler or Fireman on Crane, Dragline, Shovel, Dredge, Truck Crane, Pile Driver, Gradeall, Dinky or Standard Locomotive, Guy Derrick, Trenching Machine or Ditching Machine 80 H.P. and over, All Terrain (cherry-picker) with over 40 ton Lifting Capacity, Deck Oiler and Deckhands.

Other Classifications of Work:

For definitions of classifications not otherwise set out, the Department generally has on file such definitions which are available. If a task to be performed is not subject to one of the classifications of pay set out, the Department will upon being contacted state which neighboring county has such a classification and provide such rate, such rate being deemed to exist by reference in this document. If no neighboring county rate applies to the task, the Department shall undertake a special determination, such special determination being then deemed to have existed under this determination. If a project requires these, or any classification not listed, please contact IDOL at 217-782-1710 for wage rates or clarifications.

LANDSCAPING

Landscaping work falls under the existing classifications for laborer, operating engineer and truck driver. The work performed by landscape plantsman and landscape laborer is covered by the existing classification of laborer. The work performed by landscape operators (regardless of equipment used or its size) is covered by the classifications of operating engineer. The work performed by landscape truck drivers (regardless of size of truck driven) is covered by the classifications of truck driver.

Henderson County Prevailing Wage for May 2013

(See explanation of column headings at bottom of wages)

Trade Name	RG	TYP	C	Base	FRMAN	M-F>8	OSA	OSH	H/W	Pensn	Vac	Trng
------------	----	-----	---	------	-------	-------	-----	-----	-----	-------	-----	------

ASBESTOS ABT-GEN	BLD	27.490	28.490	1.5	1.5	2.0	8.240	10.07	0.000	0.800
ASBESTOS ABT-GEN	HWY	26.060	26.560	1.5	1.5	2.0	8.240	9.550	0.000	0.800
ASBESTOS ABT-MEC	BLD	20.500	21.500	1.5	1.5	2.0	6.250	3.500	0.000	0.000
BOILERMAKER	BLD	35.010	38.010	2.0	2.0	2.0	7.070	13.83	0.000	0.300
BRICK MASON	BLD	32.060	33.560	1.5	1.5	2.0	7.700	9.130	0.000	0.560
CARPENTER	BLD	26.380	27.700	1.5	1.5	2.0	7.960	8.660	0.000	0.600
CARPENTER	HWY	27.640	29.390	1.5	1.5	2.0	9.080	11.34	0.000	0.450
CEMENT MASON	BLD	25.200	26.700	1.5	1.5	2.0	6.600	12.10	0.000	0.500
CEMENT MASON	HWY	26.280	27.280	1.5	1.5	2.0	6.400	9.420	0.000	0.500
CERAMIC TILE FNSHER	BLD	29.750	0.000	1.5	1.5	2.0	7.700	9.130	0.000	0.550
ELECTRIC PWR EQMT OP	ALL	35.440	0.000	1.5	1.5	2.0	5.000	10.98	0.000	0.270
ELECTRIC PWR GRNDMAN	ALL	24.320	0.000	1.5	1.5	2.0	5.000	7.540	0.000	0.180
ELECTRIC PWR LINEMAN	ALL	39.370	41.910	1.5	1.5	2.0	5.000	12.20	0.000	0.300
ELECTRIC PWR TRK DRV	ALL	25.510	0.000	1.5	1.5	2.0	5.000	7.920	0.000	0.190
ELECTRICIAN	BLD	30.190	32.690	1.5	1.5	2.0	5.350	9.390	0.000	0.400
ELECTRONIC SYS TECH	BLD	27.430	29.180	1.5	1.5	2.0	5.350	9.320	0.000	0.400
ELEVATOR CONSTRUCTOR	BLD	40.520	45.585	2.0	2.0	2.0	11.88	12.71	3.240	0.600
GLAZIER	BLD	22.020	23.520	1.5	1.5	2.0	6.940	6.520	0.000	0.350
HT/FROST INSULATOR	BLD	29.190	30.390	1.5	1.5	2.0	5.420	12.05	0.000	0.900
IRON WORKER	ALL	24.440	25.690	1.5	1.5	2.0	7.010	9.890	0.000	0.570
LABORER	BLD	26.490	27.490	1.5	1.5	2.0	8.240	10.07	0.000	0.800
LABORER	HWY	25.060	25.560	1.5	1.5	2.0	8.240	9.550	0.000	0.800
LABORER, SKILLED	BLD	26.490	27.490	1.5	1.5	2.0	8.240	10.07	0.000	0.800
LABORER, SKILLED	HWY	25.360	25.860	1.5	1.5	2.0	8.240	9.550	0.000	0.800
LATHER	BLD	26.380	27.700	1.5	1.5	2.0	7.960	8.660	0.000	0.600
MACHINIST	BLD	43.550	46.050	1.5	1.5	2.0	6.130	8.950	1.850	0.000
MARBLE FINISHERS	BLD	29.750	0.000	1.5	1.5	2.0	7.700	9.130	0.000	0.550
MARBLE MASON	BLD	31.510	32.760	1.5	1.5	2.0	7.700	9.130	0.000	0.550
MILLWRIGHT	BLD	27.250	28.950	1.5	1.5	2.0	6.700	12.32	0.000	0.500
MILLWRIGHT	HWY	26.740	28.440	1.5	1.5	2.0	6.700	12.32	0.000	0.500
OPERATING ENGINEER	BLD 1	36.000	39.000	1.5	1.5	2.0	9.750	13.60	0.000	3.000
OPERATING ENGINEER	BLD 2	33.490	39.000	1.5	1.5	2.0	9.750	13.60	0.000	3.000
OPERATING ENGINEER	BLD 3	29.340	39.000	1.5	1.5	2.0	9.750	13.60	0.000	3.000
OPERATING ENGINEER	HWY 1	36.000	39.500	1.5	1.5	2.0	9.750	13.60	0.000	3.000
OPERATING ENGINEER	HWY 2	33.490	39.500	1.5	1.5	2.0	9.750	13.60	0.000	3.000
OPERATING ENGINEER	HWY 3	29.340	39.500	1.5	1.5	2.0	9.750	13.60	0.000	3.000
PAINTER	ALL	27.320	28.320	1.5	1.5	1.5	5.000	6.100	0.000	0.600
PAINTER OVER 30FT	ALL	28.570	29.570	1.5	1.5	1.5	5.000	6.100	0.000	0.600
PAINTER PWR EQMT	ALL	27.820	28.820	1.5	1.5	1.5	5.000	6.100	0.000	0.600
PILEDRIVER	BLD	26.380	27.700	1.5	1.5	2.0	7.960	8.660	0.000	0.600
PILEDRIVER	HWY	27.640	29.390	1.5	1.5	2.0	9.080	11.34	0.000	0.450
PIPEFITTER	ALL	36.550	40.210	1.5	1.5	2.0	5.650	12.15	0.000	1.000
PLASTERER	BLD	27.800	29.800	1.5	1.5	2.0	6.600	6.500	0.000	0.600
PLUMBER	ALL	36.550	40.210	1.5	1.5	2.0	5.650	12.15	0.000	1.000
ROOFER	BLD	25.130	26.380	1.5	1.5	2.0	8.610	5.620	0.000	0.260
SHEETMETAL WORKER	BLD	26.150	27.950	1.5	1.5	2.0	7.140	9.340	0.000	0.540
SPRINKLER FITTER	BLD	36.390	39.140	1.5	1.5	2.0	8.420	8.500	0.000	0.450
STONE MASON	BLD	32.060	33.560	1.5	1.5	2.0	7.700	9.130	0.000	0.560
TERRAZZO FINISHER	BLD	29.750	0.000	1.5	1.5	2.0	7.700	9.130	0.000	0.550
TERRAZZO MASON	BLD	31.510	32.760	1.5	1.5	2.0	7.700	9.130	0.000	0.550
TILE LAYER	BLD	26.380	27.700	1.5	1.5	2.0	7.960	8.660	0.000	0.600
TILE MASON	BLD	31.510	32.760	1.5	1.5	2.0	7.700	9.130	0.000	0.550
TRUCK DRIVER	ALL 1	31.230	0.000	1.5	1.5	2.0	10.30	4.840	0.000	0.250
TRUCK DRIVER	ALL 2	31.680	0.000	1.5	1.5	2.0	10.30	4.840	0.000	0.250
TRUCK DRIVER	ALL 3	31.890	0.000	1.5	1.5	2.0	10.30	4.840	0.000	0.250
TRUCK DRIVER	ALL 4	32.180	0.000	1.5	1.5	2.0	10.30	4.840	0.000	0.250
TRUCK DRIVER	ALL 5	33.020	0.000	1.5	1.5	2.0	10.30	4.840	0.000	0.250
TRUCK DRIVER	O&C 1	24.980	0.000	1.5	1.5	2.0	10.30	4.840	0.000	0.250
TRUCK DRIVER	O&C 2	25.340	0.000	1.5	1.5	2.0	10.30	4.840	0.000	0.250
TRUCK DRIVER	O&C 3	25.510	0.000	1.5	1.5	2.0	10.30	4.840	0.000	0.250
TRUCK DRIVER	O&C 4	25.740	0.000	1.5	1.5	2.0	10.30	4.840	0.000	0.250
TRUCK DRIVER	O&C 5	26.420	0.000	1.5	1.5	2.0	10.30	4.840	0.000	0.250
TUCKPOINTER	BLD	32.060	33.560	1.5	1.5	2.0	7.700	9.130	0.000	0.560

Legend :

RG (Region)

TYP (Trade Type - All,Highway,Building,Floating,Oil & Chip,Rivers)

C (Class)

Base (Base Wage Rate)

FRMAN (Foreman Rate)

M-F>8 (OT required for any hour greater than 8 worked each day, Mon through Fri.)

OSA (Overtime (OT) is required for every hour worked on Saturday)

OSH (Overtime is required for every hour worked on Sunday and Holidays)

H/W (Health & Welfare Insurance)

Pensn (Pension)

Vac (Vacation)

Trng (Training)

Explanations

HENDERSON COUNTY

The following list is considered as those days for which holiday rates of wages for work performed apply: New Years Day, Memorial Day, Fourth of July, Labor Day, Thanksgiving Day, Christmas Day and Veterans Day in some classifications/counties. Generally, any of these holidays which fall on a Sunday is celebrated on the following Monday. This then makes work performed on that Monday payable at the appropriate overtime rate for holiday pay. Common practice in a given local may alter certain days of celebration. If in doubt, please check with IDOL.

Oil and chip resealing (O&C) means the application of road oils and liquid asphalt to coat an existing road surface, followed by application of aggregate chips or gravel to coated surface, and subsequent rolling of material to seal the surface.

EXPLANATION OF CLASSES

ASBESTOS - GENERAL - removal of asbestos material/mold and hazardous materials from any place in a building, including mechanical systems where those mechanical systems are to be removed. This includes the removal of asbestos materials/mold and hazardous materials from ductwork or pipes in a building when the building is to be demolished at the time or at some close future date.

ASBESTOS - MECHANICAL - removal of asbestos material from mechanical systems, such as pipes, ducts, and boilers, where the mechanical systems are to remain.

CERAMIC TILE FINISHER, MARBLE FINISHER, TERRAZZO FINISHER

Assisting, helping or supporting the tile, marble and terrazzo

mechanic by performing their historic and traditional work assignments required to complete the proper installation of the work covered by said crafts. The term "Ceramic" is used for naming the classification only and is in no way a limitation of the product handled. Ceramic takes into consideration most hard tiles.

ELECTRONIC SYSTEMS TECHNICIAN

Installation, service and maintenance of low-voltage systems which utilizes the transmission and/or transference of voice, sound, vision, or digital for commercial, education, security and entertainment purposes for the following: TV monitoring and surveillance, background/foreground music, intercom and telephone interconnect, field programming, inventory control systems, microwave transmission, multi-media, multiplex, radio page, school, intercom and sound burglar alarms and low voltage master clock systems.

Excluded from this classification are energy management systems, life safety systems, supervisory controls and data acquisition systems not intrinsic with the above listed systems, fire alarm systems, nurse call systems and raceways exceeding fifteen feet in length.

LABORER, SKILLED - BUILDING

The skilled laborer building (BLD) classification shall encompass the following types of work, irrespective of the site of the work: tending of carpenters in unloading, handling, stockpiling and distribution operations, also other building crafts, mixing, handling, and conveying of all materials used by masons, plasterers and other building construction crafts, whether done by hand or by any process. The drying of plastering when done by salamander heat, and the cleaning and clearing of all debris. All work pertaining to and in preparation of asbestos abatement and removal. The building of scaffolding and staging for masons and plasterers. The excavations for buildings and all other construction, digging, of trenches, piers, foundations and holes, digging, lagging, sheeting, cribbing, bracing and propping of foundations, holes, caissons, cofferdams, and dikes, the setting of all guidelines for machine or hand excavation and subgrading. The mixing, handling, conveying, pouring, vibrating, gunniting and otherwise applying of concrete, whether by hand or other method of concrete for any walls, foundations, floors, or for other construction concrete sealant men. The wrecking, stripping, dismantling, and handling of concrete forms and false work, and the building of centers for fireproofing purposes. Boring machine, gas, electric or air in preparation for shoving pipe, telephone cable, and so forth, under highways, roads, streets and alleys. All hand and power operating cross cut saws when used for clearing. All work in compressed air construction. All work on acetylene burners in salvaging. The blocking and tamping of concrete. The laying of sewer tile and conduit, and pre-cast materials. The assembling and dismantling of all jacks and sectional scaffolding, including elevator construction and running of slip form jacks. The work of drill running and blasting, including wagon drills. The wrecking, stripping, dismantling, cleaning, moving and oiling of forms. The cutting off of concrete piles. The loading, unloading, handling and carrying to place of installation of all rods, (and materials for use in reinforcing) concrete and the hoisting of same and all signaling where hoist is used in this type of construction coming under the jurisdiction of the Laborers' Union. And, all other labor work not awarded to any other craft. Mortar mixers, kettlemen and carrier of hot stuff, tool crib men, watchmen (Laborer), firemen or salamander tenders, flagmen, deck hands, installation and maintenance of temporary gas-fired heating units, gravel box men, dumpmen and spotters, fencing Laborers, cleaning lumber, pit men, material checkers, dispatchers, unloading explosives, asphalt plant laborers,

writer of scale tickets, fireproofing laborers, janitors, asbestos abatement and removal laborers, handling of materials treated with oil, creosote, chloride, asphalt, and/or foreign material harmful to skin or clothing, Laborers with de-watering systems, gunnite nozzle men, laborers tending masons with hot material or where foreign materials are used, Laborers handling masterplate or similar materials, laser beam operator, concrete burning machine operator, material selector men working with firebrick or combustible material, dynamite men, track laborers, cement handlers, chloride handlers, the unloading and laborers with steel workers and re-bars, concrete workers (wet), luteman, asphalt raker, curb asphalt machine operator, ready mix scalemen, permanent, portable or temporary plant drilling machine operator, plaster tenders, underpinning and shoring of buildings, fire watch, signaling of all power equipment, to include trucks excavating equipment, etc., tree topper or trimmer when in connection to construction, tunnel helpers in free air, batch dumpers, kettle and tar men, tank cleaners, plastic installers, scaffold workers, motorized buggies or motorized unit used for wet concrete or handling of building materials, sewer workers, rod and chain men, vibrator operators, mortar mixer operator, cement silica, clay, fly ash, lime and plasters, handlers (bulk or bag), cofferdam workers, on concrete paving, placing, cutting and tying of reinforcing, deck hand, dredge hand and shore laborers, bankmen on floating plant, asphalt workers with machine & layers, grade checker, power tools, caisson workers, lead man on sewer work, welders, cutters, burners and torch men, chain saw operators, paving breaker, jackhammer and drill operator, layout man and/or drainage tile layer, steel formsetters -- street and highway, air tamping hammerman, signal man on crane, concrete saw operator, screen man on asphalt pavers, front end man on chip spreader, multiple concrete duct -- lead man.

LABORER, SKILLED - HIGHWAY

The skilled laborer heavy and highway (HWY) classification shall encompass the following types of work, irrespective of the site of the work: handling of materials treated with oil, creosote, asphalt and/or any foreign materials harmful to skin or clothing, track laborers, chloride handlers, the unloading and loading with steel workers and re-bars, concrete workers (wet), tunnel helpers in free air, batch dumpers, mason tenders, kettle and tar men, plastic installers, scaffold workers, motorized buggies or motorized unit used for wet concrete or handling of building materials, laborers with de-watering systems, sewer workers plus depth, rod and chainmen, vibrator operators, mortar mixer operators, cement silica, clay, fly ash, lime and plasters, handlers (bulk or bag), cofferdam workers plus depth, on concrete paving, placing, cutting and tying or reinforcing, deck hand, dredge hand shore laborers, bankmen on floating plant, asphalt workers with machine, and layers, grade checker, power tools, stripping of all concrete forms excluding paving forms, dumpmen and spotters, when necessary, caisson workers plus depth, gunnite nozzle men, welders, cutters, burners and torchmen, chain saw operators, paving breaker, jackhammer and drill operators, layout man and/or drainage tile layer, steel form setters - street and highway, air tamping hammerman, signal man on crane, concrete saw operator, screedman on asphalt pavers, front end man on chip spreader, multiple concrete duct, luteman, asphalt raker, curb asphalt machine operator, ready mix scalemen (portable or temporary plant), laser beam operator, concrete burning machine operator, and coring machine operator.

TRUCK DRIVER - BUILDING, HEAVY AND HIGHWAY CONSTRUCTION

Class 1. Drivers on 2 axle trucks hauling less than 9 ton. Air compressor and welding machines and brooms, including those pulled by separate units, truck driver helpers, warehouse employees, mechanic helpers, greasers and tiremen, pickup trucks when hauling materials,

tools, or workers to and from and on-the-job site, and fork lifts up to 6,000 lb. capacity.

Class 2. Two or three axle trucks hauling more than 9 ton but hauling less than 16 ton. A-frame winch trucks, hydrolift trucks, vactor trucks or similar equipment when used for transportation purposes. Fork lifts over 6,000 lb. capacity, winch trucks, four axle combination units, and ticket writers.

Class 3. Two, three or four axle trucks hauling 16 ton or more. Drivers on water pulls, articulated dump trucks, mechanics and working forepersons, and dispatchers. Five axle or more combination units.

Class 4. Low Boy and Oil Distributors.

Class 5. Drivers who require special protective clothing while employed on hazardous waste work.

TRUCK DRIVER - OIL AND CHIP RESEALING ONLY.

This shall encompass laborers, workers and mechanics who drive contractor or subcontractor owned, leased, or hired pickup, dump, service, or oil distributor trucks. The work includes transporting materials and equipment (including but not limited to, oils, aggregate supplies, parts, machinery and tools) to or from the job site; distributing oil or liquid asphalt and aggregate; stock piling material when in connection with the actual oil and chip contract. The Truck Driver (Oil & Chip Resealing) wage classification does not include supplier delivered materials.

OPERATING ENGINEERS - BUILDING

Class 1. Cranes; Overhead Cranes; Gradall; All Cherry Pickers; Mechanics; Central Concrete Mixing Plant Operator; Road Pavers (27E - Dual Drum - Tri Batchers); Blacktop Plant Operators and Plant Engineers; 3 Drum Hoist; Derricks; Hydro Cranes; Shovels; Skimmer Scoops; Koehring Scooper; Drag Lines; Backhoe; Derrick Boats; Pile Drivers and Skid Rigs; Clamshells; Locomotive Cranes; Dredge (all types) Motor Patrol; Power Blades - Dumore - Elevating and similar types; Tower Cranes (Crawler-Mobile) and Stationary; Crane-type Backfiller; Drott Yumbo and similar types considered as Cranes; Caisson Rigs; Dozer; Tournadozer; Work Boats; Ross Carrier; Helicopter; Tournapulls - all and similar types; Scoops (all sizes); Pushcats; Endloaders (all types); Asphalt Surfacing Machine; Slip Form Paver; Rock Crusher; Heavy Equipment Greaser; CMI, CMI Belt Placer, Auto Grade & 3 Track and similar types; Side Booms; Multiple Unit Earth Movers; Creter Crane; Trench Machine; Pump-crete-Belt Crete-Squeeze Cretes-Screw-type Pumps and Gypsum; Bulker & Pump - Operator will clean; Formless Finishing Machine; Flaherty Spreader or similar types; Screed Man on Laydown Machine; Wheel Tractors (industrial or Farm-type w/Dozer-Hoe-Endloader or other attachments); F.W.D. & Similar Types; Vermeer Concrete Saw.

Class 2. Dinkeys; Power Launches; PH One-pass Soil Cement Machine (and similar types); Pugmill with Pump; Backfillers; Euclid Loader; Forklifts; Jeeps w/Ditching Machine or other attachments; Tuneluger; Automatic Cement and Gravel Batching Plants; Mobile Drills (Soil Testing) and similar types; Gurries and Similar Types; (1) and (2) Drum Hoists (Buck Hoist and Similar Types); Chicago Boom; Boring Machine & Pipe Jacking Machine; Hydro Boom; Dewatering System; Straw Blower; Hydro Seeder; Assistant Heavy Equipment Greaser on Spread; Tractors (Track type) without Power Unit pulling Rollers; Rollers on Asphalt -- Brick Macadem; Concrete Breakers; Concrete Spreaders; Mule Pulling Rollers; Center Stripper; Cement Finishing Machines & CMI Texture & Reel Curing Machines; Cement Finishing Machine; Barber

Green or similar loaders; Vibro Tamper (All similar types)
Self-propelled; Winch or Boom Truck; Mechanical Bull Floats; Mixers
over 3 Bag to 27E; Tractor pulling Power Blade or Elevating Grader;
Porter Rex Rail; Clary Screed; Truck Type Hoptoe Oilers; Fireman;
Spray Machine on Paving; Curb Machines; Truck Crane Oilers; Oil
Distributor; Truck-Mounted Saws.

Class 3. Air Compressor; Power Subgrader; Straight Tractor; Trac Air
without attachments; Herman Nelson Heater, Dravo, Warner, Silent Glo,
and similar types; Roller: Five (5) Ton and under on Earth or
Gravel; Form Grader; Crawler Crane & Skid Rig Oilers; Freight
Elevators - permanently installed; Pump; Light Plant; Generator;
Conveyor (1) or (2) - Operator will clean; Welding Machine; Mixer (3)
Bag and Under (Standard Capacity with skip); Bulk Cement Plant; Oiler
on Central Concrete Mixing Plant.

OPERATING ENGINEERS - HEAVY AND HIGHWAY CONSTRUCTION

CLASS 1. Cranes; Hydro Cranes; Shovels; Crane Type Backfiller; Tower,
Mobile, Crawler, & Stationary Cranes; Derricks; Hoists (3 Drum);
Draglines; Drott Yumbo & Similar Types considered as Cranes; 360
Degree Swing Excavator (Shears, Grapples, Movacs, etc.); Back Hoe;
Derrick Boats; Pile Driver and Skid Rigs; Clam Shell; Locomotive -
Cranes; Road Pavers - Single Drum - Dual Drum - Tri Batcher; Motor
Patrols & Power Blades - Dumore - Elevating & Similar Types;
Mechanics; Central Concrete Mixing Plant Operator; Asphalt Batch Plant
Operators and Plant Engineers; Gradall; Caisson Rigs; Skimmer Scoop -
Koering Scooper; Dredges (all types); Hoptoe; All Cherry Pickers;
Work Boat; Ross Carrier; Helicopter; Dozer; Tournadozer; Tournapulls -
all and similar types; Operation of Concrete and all Recycle
Machines; Multiple Unit Earth Movers; Scoops (all sizes); Pushcats;
Endloaders (all types); Asphalt Surfacing Machine; Slip Form Paver;
Rock Crusher; Operation of Material Crusher, Screening Plants, and
Tunnel Boring Machine; Heavy Equipment Greaser (top greaser on
spread); CMI, Auto Grade, CMI Belt Placer & 3 Track and Similar Types;
Side Booms; Asphalt Heater & Planer Combination (used to plane
streets); Wheel Tractors (with Dozer, Hoe or Endloader Attachments);
CAT Earthwork Compactors and Similar Types; Blaw Knox Spreader and
Similar Types; Trench Machines; Pump Crete - Belt Crete - Squeeze
Crete - Screw Type Pumps and Gypsum (operator will clean); Creter
Crane; Operation of Concrete Pump Truck; Formless Finishing Machines;
Flaherty Spreader or Similar Types; Screed Man on Laydown Machine;
Vermeer Concrete Saw; Operation of Laser Screed; Span Saw; Dredge
Leverman; Dredge Engineer; Lull or Similar Type; Hydro-Boom Truck;
Operation of Guard Rail Machine; and Starting Engineer on Pipeline or
Construction (11 or more pieces) including: Air Compressor (Trailer
Mounted), All Forced Air Heaters (regardless of Size), Water Pumps
(Greater than 4-1/2" or Total Discharge Over 4-1/2"), Light Plants,
Generators (Trailer Mounted - Excluding Decontamination Trailer),
Welding Machines (Any Size or Mode of Power), Conveyor, Mixer (any
size), Stud Welder, Power Pac, etc, and Ground Heater (Trailer
Mounted).

CLASS 2. Bulker & Pump; Power Launches; Boring Machine & Pipe Jacking
Machine; Dinkeys; Operation of Carts, Powered Haul Unit for a Boring
Machine; P & H One Pass Soil Cement Machines and Similar Types; Wheel
Tractors (Industry or Farm Type - Other); Back Fillers; Euclid Loader;
Fork Lifts; Jeep w/Ditching Machine or Other Attachments; Tunneluger;
Automatic Cement & Gravel Batching Plants; Mobile Drills - Soil
Testing and Similar Types; Pugmill with Pump; All (1) and (2) Drum
Hoists; Dewatering System; Straw Blower; Hydro-Seeder; Bump Grinders
(self-propelled); Assistant Heavy Equipment Greaser; Apsco Spreader;
Tractors (Track-Type) without Power Units Pulling Rollers; Rollers on
Asphalt - Brick or Macadam; Concrete Breakers; Concrete Spreaders;
Cement Strippers; Cement Finishing Machines & CMI Texture & Reel

Curing Machines; Vibro-Tampers (All Similar Types Self-Propelled); Mechanical Bull Floats; Self-Propelled Concrete Saws; Truck Mounted Power Saws; Operation of Curb Cutters; Mixers - Over Three (3) Bags; Winch and Boom Trucks; Tractor Pulling Power Blade or Elevating Grader; Porter Rex Rail; Clary Screed; Mule Pulling Rollers; Pugmill without Pump; Barber Greene or Similar Loaders; Track Type Tractor w/Power Unit attached (minimum); Fireman; Spray Machine on Paving; Curb Machines; Paved Ditch Machine; Power Broom; Self-Propelled Sweepers; Self-Propelled Conveyors; Power Subgrader; Oil Distributor; Straight Tractor; Truck Crane Oiler; Truck Type Oilers; Directional Boring Machine; Horizontal Directional Drill; Articulating End Dump Vehicles; Starting Engineer on Pipeline or Construction (6 -10 pieces) including: Air Compressor (Trailer Mounted), All Forced Air Heaters (regardless of Size), Water Pumps (Greater than 4-1/2" or Total Discharge Over 4-1/2"), Light Plants, Generators (Trailer Mounted - Excluding Decontamination Trailer), Welding Machines (Any Size or Mode of Power), Conveyor, Mixer (any size), Stud Welder, Power Pac, etc., and Ground Heater (Trailer Mounted).

CLASS 3. Straight Framed Truck Mounted Vac Unit (separately powered); Trac Air Machine (without attachments); Rollers - Five Ton and Under on Earth and Gravel; Form Graders; Bulk Cement Plant; Oilers; and Starting Engineer on Pipeline or Construction (3 - 5 pieces) including: Air Compressor (Trailer Mounted), All Forced Air Heaters (regardless of Size), Water Pumps (Greater than 4-1/2" or Total Discharge Over 4-1/2"), Light Plants, Generators (Trailer Mounted - Excluding Decontamination Trailer), Welding Machines (Any Size or Mode of Power), Conveyor, Mixer (any size), Stud Welder, Power Pac, etc., and Ground Heater (Trailer Mounted).

Other Classifications of Work:

For definitions of classifications not otherwise set out, the Department generally has on file such definitions which are available. If a task to be performed is not subject to one of the classifications of pay set out, the Department will upon being contacted state which neighboring county has such a classification and provide such rate, such rate being deemed to exist by reference in this document. If no neighboring county rate applies to the task, the Department shall undertake a special determination, such special determination being then deemed to have existed under this determination. If a project requires these, or any classification not listed, please contact IDOL at 217-782-1710 for wage rates or clarifications.

LANDSCAPING

Landscaping work falls under the existing classifications for laborer, operating engineer and truck driver. The work performed by landscape plantsman and landscape laborer is covered by the existing classification of laborer. The work performed by landscape operators (regardless of equipment used or its size) is covered by the classifications of operating engineer. The work performed by landscape truck drivers (regardless of size of truck driven) is covered by the classifications of truck driver.

Henry County Prevailing Wage for May 2013

(See explanation of column headings at bottom of wages)

Trade Name	RG	TYP	C	Base	FRMAN	M-F>8	OSA	OSH	H/W	Pensn	Vac	Trng
ASBESTOS ABT-GEN		BLD		27.490	28.490	1.5	1.5	2.0	8.240	10.07	0.000	0.800
ASBESTOS ABT-GEN		HWY		26.060	26.560	1.5	1.5	2.0	8.240	9.550	0.000	0.800

ASBESTOS ABT-MEC		BLD	20.500	21.500	1.5	1.5	2.0	6.250	3.500	0.000	0.000
BOILERMAKER		BLD	35.010	38.010	2.0	2.0	2.0	7.070	13.83	0.000	0.300
BRICK MASON		BLD	36.720	37.720	1.5	1.5	2.0	8.720	7.950	0.000	0.580
CARPENTER		BLD	26.380	27.700	1.5	1.5	2.0	7.960	8.660	0.000	0.600
CARPENTER		HWY	27.640	29.390	1.5	1.5	2.0	9.080	11.34	0.000	0.450
CEMENT MASON		ALL	35.000	36.000	1.5	1.5	2.0	7.700	11.67	0.000	0.500
CERAMIC TILE FNSHER		BLD	32.410	0.000	1.5	1.5	2.0	7.700	4.840	0.000	0.530
COMMUNICATION TECH	SE	BLD	31.200	32.700	1.5	1.5	2.0	12.32	10.77	0.000	0.320
ELECTRIC PWR EQMT OP		ALL	35.440	0.000	1.5	1.5	2.0	5.000	10.98	0.000	0.270
ELECTRIC PWR GRNDMAN		ALL	24.320	0.000	1.5	1.5	2.0	5.000	7.540	0.000	0.180
ELECTRIC PWR LINEMAN		ALL	39.370	41.910	1.5	1.5	2.0	5.000	12.20	0.000	0.300
ELECTRIC PWR TRK DRV		ALL	25.510	0.000	1.5	1.5	2.0	5.000	7.920	0.000	0.190
ELECTRICIAN	NW	BLD	31.520	33.520	1.5	1.5	2.0	7.320	10.82	0.000	0.310
ELECTRICIAN	SE	BLD	37.950	41.370	1.5	1.5	2.0	13.17	15.06	0.000	1.200
ELECTRONIC SYS TECH	NW	BLD	23.750	25.500	1.5	1.5	2.0	7.120	5.260	0.000	0.310
ELEVATOR CONSTRUCTOR		BLD	39.380	44.300	2.0	2.0	2.0	11.88	12.71	3.150	0.600
GLAZIER		BLD	26.360	27.860	1.5	1.5	2.0	6.940	6.520	0.000	0.350
HT/FROST INSULATOR		BLD	29.190	30.390	1.5	1.5	2.0	5.420	12.05	0.000	0.900
IRON WORKER		ALL	28.000	30.240	1.5	1.5	2.0	9.390	10.68	0.000	0.620
LABORER		BLD	26.490	27.490	1.5	1.5	2.0	8.240	10.07	0.000	0.800
LABORER		HWY	25.060	25.560	1.5	1.5	2.0	8.240	9.550	0.000	0.800
LABORER, SKILLED		BLD	26.490	27.490	1.5	1.5	2.0	8.240	10.07	0.000	0.800
LABORER, SKILLED		HWY	25.360	25.860	1.5	1.5	2.0	8.240	9.550	0.000	0.800
LATHER		BLD	26.380	27.700	1.5	1.5	2.0	7.960	8.660	0.000	0.600
MACHINIST		BLD	43.550	46.050	1.5	1.5	2.0	6.130	8.950	1.850	0.000
MARBLE FINISHERS		BLD	32.410	0.000	1.5	1.5	2.0	7.700	4.840	0.000	0.530
MARBLE MASON		BLD	35.090	35.340	1.5	1.5	2.0	7.700	7.150	0.000	0.560
MILLWRIGHT	N	BLD	29.820	32.800	1.5	1.5	2.0	4.300	8.730	0.000	0.560
MILLWRIGHT	S	BLD	27.250	28.950	1.5	1.5	2.0	6.700	12.32	0.000	0.500
OPERATING ENGINEER		BLD 5	30.150	31.150	1.5	1.5	2.0	13.95	6.600	1.500	0.800
OPERATING ENGINEER		BLD 6	30.650	31.650	1.5	1.5	2.0	13.95	6.600	1.500	0.800
OPERATING ENGINEER		BLD 7	30.400	31.400	1.5	1.5	2.0	13.95	6.600	1.500	0.800
OPERATING ENGINEER	E	BLD 1	36.000	39.000	1.5	1.5	2.0	9.750	13.60	0.000	3.000
OPERATING ENGINEER	E	BLD 2	33.490	39.000	1.5	1.5	2.0	9.750	13.60	0.000	3.000
OPERATING ENGINEER	E	BLD 3	29.340	39.000	1.5	1.5	2.0	9.750	13.60	0.000	3.000
OPERATING ENGINEER	E	HWY 1	36.000	39.500	1.5	1.5	2.0	9.750	13.60	0.000	3.000
OPERATING ENGINEER	E	HWY 2	33.490	39.500	1.5	1.5	2.0	9.750	13.60	0.000	3.000
OPERATING ENGINEER	E	HWY 3	29.340	39.500	1.5	1.5	2.0	9.750	13.60	0.000	3.000
OPERATING ENGINEER	W	BLD 1	29.900	31.900	1.5	1.5	2.0	15.40	6.600	1.500	0.850
OPERATING ENGINEER	W	BLD 2	28.300	31.900	1.5	1.5	2.0	15.40	6.600	1.500	0.850
OPERATING ENGINEER	W	BLD 3	27.150	31.900	1.5	1.5	2.0	15.40	6.600	1.500	0.850
OPERATING ENGINEER	W	BLD 4	30.150	31.900	1.5	1.5	2.0	15.40	6.600	1.500	0.850
OPERATING ENGINEER	W	BLD 5	30.650	31.900	1.5	1.5	2.0	15.40	6.600	1.500	0.850
OPERATING ENGINEER	W	BLD 6	31.150	31.900	1.5	1.5	2.0	15.40	6.600	1.500	0.850
OPERATING ENGINEER	W	BLD 7	30.900	31.900	1.5	1.5	2.0	15.40	6.600	1.500	0.850
OPERATING ENGINEER	W	HWY 1	29.900	31.900	1.5	1.5	2.0	15.40	6.600	1.500	0.850
OPERATING ENGINEER	W	HWY 2	28.300	31.900	1.5	1.5	2.0	15.40	6.600	1.500	0.850
OPERATING ENGINEER	W	HWY 3	27.150	31.900	1.5	1.5	2.0	15.40	6.600	1.500	0.850
OPERATING ENGINEER	W	HWY 4	30.150	31.900	1.5	1.5	2.0	15.40	6.600	1.500	0.850
OPERATING ENGINEER	W	HWY 5	30.650	31.900	1.5	1.5	2.0	15.40	6.600	1.500	0.850
OPERATING ENGINEER	W	HWY 6	31.150	31.900	1.5	1.5	2.0	15.40	6.600	1.500	0.850
OPERATING ENGINEER	W	HWY 7	30.400	31.900	1.5	1.5	2.0	15.40	6.600	1.500	0.850
OPERATING ENGINEER	W	HWY 8	30.900	31.900	1.5	1.5	2.0	15.40	6.600	1.500	0.850
PAINTER		ALL	27.320	28.320	1.5	1.5	1.5	5.000	6.100	0.000	0.600
PAINTER OVER 30FT		ALL	28.570	29.570	1.5	1.5	1.5	5.000	6.100	0.000	0.600
PAINTER PWR EQMT		ALL	27.820	28.820	1.5	1.5	1.5	5.000	6.100	0.000	0.600
PILEDRIVER		BLD	26.380	27.700	1.5	1.5	2.0	7.960	8.660	0.000	0.600
PILEDRIVER		HWY	27.640	29.390	1.5	1.5	2.0	9.080	11.34	0.000	0.450
PIPEFITTER		ALL	36.550	40.210	1.5	1.5	2.0	5.650	12.15	0.000	1.000
PLASTERER		BLD	35.000	36.000	1.5	1.5	2.0	7.700	11.67	0.000	0.500
PLUMBER		ALL	36.550	40.210	1.5	1.5	2.0	5.650	12.15	0.000	1.000
ROOFER		BLD	25.130	26.380	1.5	1.5	2.0	8.610	5.620	0.000	0.260
SHEETMETAL WORKER		BLD	30.070	32.070	1.5	1.5	2.0	7.140	10.54	0.000	0.540
SPRINKLER FITTER		BLD	36.390	39.140	1.5	1.5	2.0	8.420	8.500	0.000	0.450
STONE MASON		BLD	36.720	37.720	1.5	1.5	2.0	8.720	7.950	0.000	0.580

TERRAZZO FINISHER	BLD	32.410	0.000	1.5	1.5	2.0	7.700	4.840	0.000	0.530
TILE LAYER	BLD	26.380	27.700	1.5	1.5	2.0	7.960	8.660	0.000	0.600
TILE MASON	BLD	35.090	35.340	1.5	1.5	2.0	7.700	7.150	0.000	0.560
TRUCK DRIVER	ALL 1	31.340	0.000	1.5	1.5	2.0	10.30	5.010	0.000	0.250
TRUCK DRIVER	ALL 2	31.780	0.000	1.5	1.5	2.0	10.30	5.010	0.000	0.250
TRUCK DRIVER	ALL 3	32.020	0.000	1.5	1.5	2.0	10.30	5.010	0.000	0.250
TRUCK DRIVER	ALL 4	32.280	0.000	1.5	1.5	2.0	10.30	5.010	0.000	0.250
TRUCK DRIVER	ALL 5	33.130	0.000	1.5	1.5	2.0	10.30	5.010	0.000	0.250
TRUCK DRIVER	O&C 1	25.070	0.000	1.5	1.5	2.0	10.30	5.010	0.000	0.250
TRUCK DRIVER	O&C 2	25.420	0.000	1.5	1.5	2.0	10.30	5.010	0.000	0.250
TRUCK DRIVER	O&C 3	25.620	0.000	1.5	1.5	2.0	10.30	5.010	0.000	0.250
TRUCK DRIVER	O&C 4	25.820	0.000	1.5	1.5	2.0	10.30	5.010	0.000	0.250
TRUCK DRIVER	O&C 5	26.500	0.000	1.5	1.5	2.0	10.30	5.010	0.000	0.250
TUCKPOINTER	BLD	36.720	37.720	1.5	1.5	2.0	8.720	7.950	0.000	0.580

Legend:

RG (Region)

TYP (Trade Type - All,Highway,Building,Floating,Oil & Chip,Rivers)

C (Class)

Base (Base Wage Rate)

FRMAN (Foreman Rate)

M-F>8 (OT required for any hour greater than 8 worked each day, Mon through Fri.

OSA (Overtime (OT) is required for every hour worked on Saturday)

OSH (Overtime is required for every hour worked on Sunday and Holidays)

H/W (Health & Welfare Insurance)

Pensn (Pension)

Vac (Vacation)

Trng (Training)

Explanations

HENRY COUNTY

COMMUNICATIONS TECHNICIAN (SE) - Townships of Annawan, Cambridge, Burns, Kewanee, Weller, Galva, and Wethersfield.

ELECTRICIANS AND ELECTRONIC SYSTEMS TECHNICIAN (NW) - That portion North and West of Annawan, Burns, Cambridge, and Weller Townships.

MILLWRIGHT (NORTH) - North of interstate 80.

OPERATING ENGINEERS (EAST) - The eastern half of the county divided by highway 82 excluding Geneseo.

The following list is considered as those days for which holiday rates of wages for work performed apply: New Years Day, Memorial Day, Fourth of July, Labor Day, Thanksgiving Day, Christmas Day and Veterans Day in some classifications/counties. Generally, any of these holidays which fall on a Sunday is celebrated on the following

Monday. This then makes work performed on that Monday payable at the appropriate overtime rate for holiday pay. Common practice in a given local may alter certain days of celebration. If in doubt, please check with IDOL.

Oil and chip resealing (O&C) means the application of road oils and liquid asphalt to coat an existing road surface, followed by application of aggregate chips or gravel to coated surface, and subsequent rolling of material to seal the surface.

EXPLANATION OF CLASSES

ASBESTOS - GENERAL - removal of asbestos material/mold and hazardous materials from any place in a building, including mechanical systems where those mechanical systems are to be removed. This includes the removal of asbestos materials/mold and hazardous materials from ductwork or pipes in a building when the building is to be demolished at the time or at some close future date.

ASBESTOS - MECHANICAL - removal of asbestos material from mechanical systems, such as pipes, ducts, and boilers, where the mechanical systems are to remain.

CERAMIC TILE FINISHER, MARBLE FINISHER, TERRAZO FINISHER

Assisting, helping or supporting the tile, marble and terrazzo mechanic by performing their historic and traditional work assignments required to complete the proper installation of the work covered by said crafts. The term "Ceramic" is used for naming the classification only and is in no way a limitation of the product handled. Ceramic takes into consideration most hard tiles.

COMMUNICATIONS TECHNICIAN - Southeast

Installation, operation, inspection, maintenance, repair and service of radio, television, recording, voice, sound and vision production and reproduction, telephone and telephone interconnect, facsimile, equipment and appliances used for domestic, commercial, educational and entertainment purposes, pulling of wire through conduit but not the installation of conduit.

ELECTRONIC SYSTEMS TECHNICIAN - Northwest

Installing, assembling and maintaining sound and intercom, protection alarm (security), master antenna television, closed circuit television, computer hardware and software programming and installation to the network's outlet and input (EXCLUDING all cabling, power and cable termination work historically performed by wiremen), door monitoring and control, nurse and emergency call programming and installation to the system's outlet and input (EXCLUDING all cabling, power and cable termination work historically performed by wiremen), clock and timing; and the installation and maintenance of transmit and receive antennas, transmitters, receivers, and associated apparatus which operates in conjunction with the above systems. All work associated with these system installations will be included EXCEPT (1) installation of protective metallic conduit, excluding less than ten-foot runs strictly for protection of cable, and (2) 120 volt AC (or higher) power wiring and associated hardware.

LABORER, SKILLED - BUILDING

The skilled laborer building (BLD) classification shall encompass the following types of work, irrespective of the site of the work: tending of carpenters in unloading, handling, stockpiling and distribution

operations, also other building crafts, mixing, handling, and conveying of all materials used by masons, plasterers and other building construction crafts, whether done by hand or by any process. The drying of plastering when done by salamander heat, and the cleaning and clearing of all debris. All work pertaining to and in preparation of asbestos abatement and removal. The building of scaffolding and staging for masons and plasterers. The excavations for buildings and all other construction, digging, of trenches, piers, foundations and holes, digging, lagging, sheeting, cribbing, bracing and propping of foundations, holes, caissons, cofferdams, and dikes, the setting of all guidelines for machine or hand excavation and subgrading. The mixing, handling, conveying, pouring, vibrating, gunniting and otherwise applying of concrete, whether by hand or other method of concrete for any walls, foundations, floors, or for other construction concrete sealant men. The wrecking, stripping, dismantling, and handling of concrete forms and false work, and the building of centers for fireproofing purposes. Boring machine, gas, electric or air in preparation for shoving pipe, telephone cable, and so forth, under highways, roads, streets and alleys. All hand and power operating cross cut saws when used for clearing. All work in compressed air construction. All work on acetylene burners in salvaging. The blocking and tamping of concrete. The laying of sewer tile and conduit, and pre-cast materials. The assembling and dismantling of all jacks and sectional scaffolding, including elevator construction and running of slip form jacks. The work of drill running and blasting, including wagon drills. The wrecking, stripping, dismantling, cleaning, moving and oiling of forms. The cutting off of concrete piles. The loading, unloading, handling and carrying to place of installation of all rods, (and materials for use in reinforcing) concrete and the hoisting of same and all signaling where hoist is used in this type of construction coming under the jurisdiction of the Laborers' Union. And, all other labor work not awarded to any other craft. Mortar mixers, kettlemen and carrier of hot stuff, tool crib men, watchmen (Laborer), firemen or salamander tenders, flagmen, deck hands, installation and maintenance of temporary gas-fired heating units, gravel box men, dumpmen and spotters, fencing Laborers, cleaning lumber, pit men, material checkers, dispatchers, unloading explosives, asphalt plant laborers, writer of scale tickets, fireproofing laborers, janitors, asbestos abatement and removal laborers, handling of materials treated with oil, creosote, chloride, asphalt, and/or foreign material harmful to skin or clothing, Laborers with de-watering systems, gunnite nozzle men, laborers tending masons with hot material or where foreign materials are used, Laborers handling masterplate or similar materials, laser beam operator, concrete burning machine operator, material selector men working with firebrick or combustible material, dynamite men, track laborers, cement handlers, chloride handlers, the unloading and laborers with steel workers and re-bars, concrete workers (wet), luteman, asphalt raker, curb asphalt machine operator, ready mix scalemen, permanent, portable or temporary plant drilling machine operator, plaster tenders, underpinning and shoring of buildings, fire watch, signaling of all power equipment, to include trucks excavating equipment, etc., tree topper or trimmer when in connection to construction, tunnel helpers in free air, batch dumpers, kettle and tar men, tank cleaners, plastic installers, scaffold workers, motorized buggies or motorized unit used for wet concrete or handling of building materials, sewer workers, rod and chain men, vibrator operators, mortar mixer operator, cement silica, clay, fly ash, lime and plasters, handlers (bulk or bag), cofferdam workers, on concrete paving, placing, cutting and tying of reinforcing, deck hand, dredge hand and shore laborers, bankmen on floating plant, asphalt workers with machine & layers, grade checker, power tools, caisson workers, lead man on sewer work, welders, cutters, burners and torch men, chain saw operators, paving breaker, jackhammer and drill operator, layout man and/or drainage tile layer, steel form setters --

street and highway, air tamping hammerman, signal man on crane, concrete saw operator, screen man on asphalt pavers, front end man on chip spreader, multiple concrete duct -- lead man.

LABORER, SKILLED - HIGHWAY

The skilled laborer heavy and highway (HWY) classification shall encompass the following types of work, irrespective of the site of the work: handling of materials treated with oil, creosote, asphalt and/or any foreign materials harmful to skin or clothing, track laborers, chloride handlers, the unloading and loading with steel workers and re-bars, concrete workers (wet), tunnel helpers in free air, batch dumpers, mason tenders, kettle and tar men, plastic installers, scaffold workers, motorized buggies or motorized unit used for wet concrete or handling of building materials, laborers with de-watering systems, sewer workers plus depth, rod and chainmen, vibrator operators, mortar mixer operators, cement silica, clay, fly ash, lime and plasters, handlers (bulk or bag), cofferdam workers plus depth, on concrete paving, placing, cutting and tying or reinforcing, deck hand, dredge hand shore laborers, bankmen on floating plant, asphalt workers with machine, and layers, grade checker, power tools, stripping of all concrete forms excluding paving forms, dumpmen and spotters, when necessary, caisson workers plus depth, gunnite nozzle men, welders, cutters, burners and torchmen, chain saw operators, paving breaker, jackhammer and drill operators, layout man and/or drainage tile layer, steel form setters - street and highway, air tamping hammerman, signal man on crane, concrete saw operator, screedman on asphalt pavers, front end man on chip spreader, multiple concrete duct, luteman, asphalt raker, curb asphalt machine operator, ready mix scalemen (portable or temporary plant), laser beam operator, concrete burning machine operator, and coring machine operator.

OPERATING ENGINEERS - BUILDING (West)

Class 1. Shovel; Concrete Spreader; Dipper Dredge Operator; Dipper Dredge Crane man; Dual Purpose Truck (boom, Boom, Winch, etc.); Mechanic-Welder; Pile Driver; Boom Tractor or Side Boom; Trenching Machine (40 H.P. and over); Building Hoist (1, 2 or 3 drums); Cleaning and Priming Machine; Backfiller (throw bucket); Locomotive Engineer; Concrete Paver; Slip Form Paver; Caisson Augering Machines; Mucking Machine; Asphalt Heater-Planer Unit; Laser Screed; Pug Mill; Concrete Conveyor or Pump; Mechanical loaded Log Chippers or similar machines; Group Equipment Greaser; Off-Road Haul Units; Pipe Bending; Automatic Curbing Machines; Blastholer; Self-Propelled Rotary Drill or similar machines; Work Boat; Combination Concrete Finishing Machine and Float; Asphalt Paver Screed Operator; Forklift (6,000 lb. cap. or over or working heights 28 ft. and above); Chip Spreader; Straddle Carrier; Asphalt Paver; Asphalt Plant Operator; Boring Machine (Directional, Vertical, or Horizontal); Central Redi-Mix Plant Operator; Combination Backhoe Front End loader; Concrete Breaker or Hydro-Hammer (excluding walk-behinds); Concrete Wheel Saw (Large self-propelled - excluding walk-behinds); Crusher (Stone, Concrete, Asphalt, etc.); Curing-Tinning Machine; Excavator; Farm-type Tractor Operating Scoop or Scraper or with Power Attachment; Grader; Motor Grader; Motor Patrol; Auto Grader; Form Grader; Pull Grader; Sub Grader; Elevating Grader; Guard Rail Post Driver; Hoists; Hydraulic Dredge Leverman or Engineer; Hydro-Vac truck mounted or pull type (excluding hose work), and similar equipment; Loader (Track, Rubber Tire, or Articulated); Milling Machine (excluding walk-behinds); Road Widener-Shoulder Spreader; Scraper (Self-Propelled); Self-Propelled Roller or Tire Roller (on asphalt or Blacktop); Sheep Foot or Pad Foot Compactor (excluding walk-behinds); Steel Track-Type Tractor (Dozer, Push Cat, etc.); Transfer or Shuttle Buggy (excluding motorized wheel barrows and Georgia buggies).

Class 2. Asphalt Booster; Fireman and Pump Operator at Asphalt Plant; Mud Jack; Distributor; Self-propelled Roller (other than provided for in Class I); Pump Operator (more than one well-point pump); Trench Machine (under 40 H.P.); Forklift (less than 6,000 lb. cap. or working heights below 28 ft.); Gypsum Pump; Conveyor over 20 H.P.; Light Plant; Boiler (Engineer or Fireman); Mechanical Broom; Driver on Truck Crane or similar machines; Elevator (Permanent inside or Temporary outside); Farm-Type Tractor (without Power Attachment); Grout Pump (excluding hose work).

Class 3. Skid Loader; Oiler; Mechanic's Helper; Mechanical Heater (other than steam boiler); Small Outboard Motor Boat (Safety Boat and Life Boat); Engine Driven Welding Machine; Water Pumps; Air Compressor (400 c.f.m. or over); Deck Engineers.

Class 4. Leadman - Mechanic or Equipment Greaser.

Class 5. Track Excavator with Bucket (4 cubic yard and up to but not including 6 cubic yard).

Class 6. Track Excavator with Bucket (6 cubic yard and over).

Class 7. Crane (Friction or Hydraulic, regardless of size or attachments); Tow or Push Boat.

OPERATING ENGINEERS- HIGHWAY (West)

Class 1. Shovel; Concrete Spreader; Dipper Dredge Operator; Dipper Dredge Crane man; Dual Purpose Truck (Boom, Winch, etc.); Mechanic-Welder; Pile Driver; Boom Tractor or Side Boom; Building Hoist (1, 2 or 3 drums); Cleaning and Priming Machine; Backfiller (throw bucket); Locomotive Engineer; Concrete Paver; Slip Form Paver; Caisson Augering Machines; Mucking Machine; Asphalt Heater Planer Unit; Laser Screed; Pug Mill; Concrete Conveyor or Pump (excluding truck-mounted); Mechanical loaded Log Chippers or similar machines; Group Equipment Greaser; off-road haul units; Pipe Bending; Automatic Curbing Machines; Blastholer; Self-propelled Rotary Drill or similar machines; Work Boat; Combination Concrete Finishing Machine and Float; Asphalt Paver Screed Operator; Forklift (6,000 lb. cap. or over or working heights above 28 ft.); Chip Spreader; Asphalt Paver; Asphalt Plant Operator; Boring Machine (Directional, Vertical, or Horizontal); Central Redi-Mix Plant Operator; Combination Backhoe Front End loader; Concrete Breaker or Hydro-Hammer (excluding walk-behinds); Concrete Wheel Saw (Large self-propelled - excluding walk-behinds); Crusher (Stone, Concrete, Asphalt, etc.); Curing-Tinning Machine; Excavator; Farm-Type Tractor Operating Scoop or Scraper with Power Attachment; Grader; Motor Grader; Motor Patrol; Auto Grader; Form Grader; Pull Grader; Sub Grader; Elevating Grader; Guard Rail Post Driver; Hoists; Hydraulic Dredge Leverman or Engineer; Hydro-Vac truck mounted or pull type, and similar equipment; Loader (Track, Rubber Tire, or Articulated); Milling Machine (excluding walk-behinds); Road Widener-Shoulder Spreader; Scraper (self-propelled); Self-propelled Roller or Tire Roller (on asphalt or Blacktop); Sheep Foot or Pad Foot Compactor (excluding walk-behinds); Steel Track-Type Tractor (Dozer, Push Cat, etc.); Transfer or Shuttle Buggy (excluding motorized wheel barrows and Georgia buggies); Trenching Machine (40 H.P. and over).

Class 2. Asphalt Booster; Fireman and Pump Operator at Asphalt Plant; Mud Jack; Farm-Type Tractor without Power attachment; Distributor; Straddle Carrier; Self-propelled Roller or Compactor (other than provided for in Class I); Pump Operator (more than one well-point pump); Trench Machine (under 40 H.P.); Forklift (less than 6,000 lb. capacity or working heights below 28 ft.); Conveyor over 20 H.P.; Air Compressor (400 c.f.m. or over); Light Plant; Boiler (Engineer or

Fireman); Mechanical Broom; Driver on Truck Crane or similar machines; Elevator (Permanent inside or Temporary outside); Grout Pump (excluding hose work).

Class 3. Oiler; Mechanic's Helper; Mechanical Heater (other than steam boiler); Small Outboard Motor Boat (Safety Boat and Life Boat); Engine Driven Welding Machine; skid steer.

Class 4. Leadman - Mechanic or Equipment Greaser.

Class 5. Track Excavator with Bucket (4 cubic yard and up to but not including 6 cubic yard).

Class 6. Track Excavator with Bucket (6 cubic yard and over).

Class 7. Truck mounted Concrete Conveyor or Pumps Extending to 90 ft. or more.

Class 8. Crane (Friction or Hydraulic, regardless of size or attachments); Tow or Push Boat.

OPERATING ENGINEERS - BUILDING - EAST

Class 1. Cranes; Overhead Cranes; Gradall; All Cherry Pickers; Mechanics; Central Concrete Mixing Plant Operator; Road Pavers (27E - Dual Drum - Tri Batchers); Blacktop Plant Operators and Plant Engineers; 3 Drum Hoist; Derricks; Hydro Cranes; Shovels; Skimmer Scoops; Koehring Scooper; Drag Lines; Backhoe; Derrick Boats; Pile Drivers and Skid Rigs; Clamshells; Locomotive Cranes; Dredge (all types) Motor Patrol; Power Blades - Dumore - Elevating and similar types; Tower Cranes (Crawler-Mobile) and Stationary; Crane-type Backfiller; Drott Yumbo and similar types considered as Cranes; Caisson Rigs; Dozer; Tournadozer; Work Boats; Ross Carrier; Helicopter; Tournapulls - all and similar types; Scoops (all sizes); Pushcats; Endloaders (all types); Asphalt Surfacing Machine; Slip Form Paver; Rock Crusher; Heavy Equipment Greaser; CMI, CMI Belt Placer, Auto Grade & 3 Track and similar types; Side Booms; Multiple Unit Earth Movers; Creter Crane; Trench Machine; Pump-crete-Belt Crete-Squeeze Cretes-Screw-type Pumps and Gypsum; Bulker & Pump - Operator will clean; Formless Finishing Machine; Flaherty Spreader or similar types; Screed Man on Laydown Machine; Wheel Tractors (industrial or Farm-type w/Dozer-Hoe-Endloader or other attachments); F.W.D. & Similar Types; Vermeer Concrete Saw.

Class 2. Dinkeys; Power Launches; PH One-pass Soil Cement Machine (and similar types); Pugmill with Pump; Backfillers; Euclid Loader; Forklifts; Jeeps w/Ditching Machine or other attachments; Tuneluger; Automatic Cement and Gravel Batching Plants; Mobile Drills (Soil Testing) and similar types; Gurries and Similar Types; (1) and (2) Drum Hoists (Buck Hoist and Similar Types); Chicago Boom; Boring Machine & Pipe Jacking Machine; Hydro Boom; Dewatering System; Straw Blower; Hydro Seeder; Assistant Heavy Equipment Greaser on Spread; Tractors (Track type) without Power Unit pulling Rollers; Rollers on Asphalt -- Brick Macadem; Concrete Breakers; Concrete Spreaders; Mule Pulling Rollers; Center Stripper; Cement Finishing Machines & CMI Texture & Reel Curing Machines; Cement Finishing Machine; Barber Green or similar loaders; Vibro Tamper (All similar types) Self-propelled; Winch or Boom Truck; Mechanical Bull Floats; Mixers over 3 Bag to 27E; Tractor pulling Power Blade or Elevating Grader; Porter Rex Rail; Clary Screed; Truck Type Hoptoe Oilers; Fireman; Spray Machine on Paving; Curb Machines; Truck Crane Oilers; Oil Distributor; Truck-Mounted Saws.

Class 3. Air Compressor; Power Subgrader; Straight Tractor; Trac Air

without attachments; Herman Nelson Heater, Dravo, Warner, Silent Glo, and similar types; Roller: Five (5) Ton and under on Earth or Gravel; Form Grader; Crawler Crane & Skid Rig Oilers; Freight Elevators - permanently installed; Pump; Light Plant; Generator; Conveyor (1) or (2) - Operator will clean; Welding Machine; Mixer (3) Bag and Under (Standard Capacity with skip); Bulk Cement Plant; Oiler on Central Concrete Mixing Plant.

OPERATING ENGINEERS - HEAVY AND HIGHWAY CONSTRUCTION - EAST

CLASS 1. Cranes; Hydro Cranes; Shovels; Crane Type Backfiller; Tower, Mobile, Crawler, & Stationary Cranes; Derricks; Hoists (3 Drum); Draglines; Drott Yumbo & Similar Types considered as Cranes; 360 Degree Swing Excavator (Shears, Grapples, Movacs, etc.); Back Hoe; Derrick Boats; Pile Driver and Skid Rigs; Clam Shell; Locomotive - Cranes; Road Pavers - Single Drum - Dual Drum - Tri Batcher; Motor Patrols & Power Blades - Dumore - Elevating & Similar Types; Mechanics; Central Concrete Mixing Plant Operator; Asphalt Batch Plant Operators and Plant Engineers; Gradall; Caisson Rigs; Skimmer Scoop - Koering Scooper; Dredges (all types); Hoptoe; All Cherry Pickers; Work Boat; Ross Carrier; Helicopter; Dozer; Tournadozer; Tournapulls - all and similar types; Operation of Concrete and all Recycle Machines; Multiple Unit Earth Movers; Scoops (all sizes); Pushcats; Endloaders (all types); Asphalt Surfacing Machine; Slip Form Paver; Rock Crusher; Operation of Material Crusher, Screening Plants, and Tunnel Boring Machine; Heavy Equipment Greaser (top greaser on spread); CMI, Auto Grade, CMI Belt Placer & 3 Track and Similar Types; Side Booms; Asphalt Heater & Planer Combination (used to plane streets); Wheel Tractors (with Dozer, Hoe or Endloader Attachments); CAT Earthwork Compactors and Similar Types; Blaw Knox Spreader and Similar Types; Trench Machines; Pump Crete - Belt Crete - Squeeze Crete - Screw Type Pumps and Gypsum (operator will clean); Creter Crane; Operation of Concrete Pump Truck; Formless Finishing Machines; Flaherty Spreader or Similar Types; Screed Man on Laydown Machine; Vermeer Concrete Saw; Operation of Laser Screed; Span Saw; Dredge Leverman; Dredge Engineer; Lull or Similar Type; Hydro-Boom Truck; Operation of Guard Rail Machine; and Starting Engineer on Pipeline or Construction (11 or more pieces) including: Air Compressor (Trailer Mounted), All Forced Air Heaters (regardless of Size), Water Pumps (Greater than 4-1/2" or Total Discharge Over 4-1/2"), Light Plants, Generators (Trailer Mounted - Excluding Decontamination Trailer), Welding Machines (Any Size or Mode of Power), Conveyor, Mixer (any size), Stud Welder, Power Pac, etc, and Ground Heater (Trailer Mounted).

CLASS 2. Bulker & Pump; Power Launches; Boring Machine & Pipe Jacking Machine; Dinkeys; Operation of Carts, Powered Haul Unit for a Boring Machine; P & H One Pass Soil Cement Machines and Similar Types; Wheel Tractors (Industry or Farm Type - Other); Back Fillers; Euclid Loader; Fork Lifts; Jeep w/Ditching Machine or Other Attachments; Tunneluger; Automatic Cement & Gravel Batching Plants; Mobile Drills - Soil Testing and Similar Types; Pugmill with Pump; All (1) and (2) Drum Hoists; Dewatering System; Straw Blower; Hydro-Seeder; Bump Grinders (self-propelled); Assistant Heavy Equipment Greaser; Apsco Spreader; Tractors (Track-Type) without Power Units Pulling Rollers; Rollers on Asphalt - Brick or Macadam; Concrete Breakers; Concrete Spreaders; Cement Strippers; Cement Finishing Machines & CMI Texture & Reel Curing Machines; Vibro-Tampers (All Similar Types Self-Propelled); Mechanical Bull Floats; Self-Propelled Concrete Saws; Truck Mounted Power Saws; Operation of Curb Cutters; Mixers - Over Three (3) Bags; Winch and Boom Trucks; Tractor Pulling Power Blade or Elevating Grader; Porter Rex Rail; Clary Screed; Mule Pulling Rollers; Pugmill without Pump; Barber Greene or Similar Loaders; Track Type Tractor w/Power Unit attached (minimum); Fireman; Spray Machine on Paving; Curb Machines; Paved Ditch Machine; Power Broom; Self-Propelled

Sweepers; Self-Propelled Conveyors; Power Subgrader; Oil Distributor; Straight Tractor; Truck Crane Oiler; Truck Type Oilers; Directional Boring Machine; Horizontal Directional Drill; Articulating End Dump Vehicles; Starting Engineer on Pipeline or Construction (6 -10 pieces) including: Air Compressor (Trailer Mounted), All Forced Air Heaters (regardless of Size), Water Pumps (Greater than 4-1/2" or Total Discharge Over 4-1/2"), Light Plants, Generators (Trailer Mounted - Excluding Decontamination Trailer), Welding Machines (Any Size or Mode of Power), Conveyor, Mixer (any size), Stud Welder, Power Pac, etc., and Ground Heater (Trailer Mounted).

CLASS 3. Straight Framed Truck Mounted Vac Unit (separately powered); Trac Air Machine (without attachments); Rollers - Five Ton and Under on Earth and Gravel; Form Graders; Bulk Cement Plant; Oilers; and Starting Engineer on Pipeline or Construction (3 - 5 pieces) including: Air Compressor (Trailer Mounted), All Forced Air Heaters (regardless of Size), Water Pumps (Greater than 4-1/2" or Total Discharge Over 4-1/2"), Light Plants, Generators (Trailer Mounted - Excluding Decontamination Trailer), Welding Machines (Any Size or Mode of Power), Conveyor, Mixer (any size), Stud Welder, Power Pac, etc., and Ground Heater (Trailer Mounted).

TRUCK DRIVER - BUILDING, HEAVY AND HIGHWAY CONSTRUCTION

Class 1. Drivers on 2 axle trucks hauling less than 9 ton. Air compressor and welding machines and brooms, including those pulled by separate units, truck driver helpers, warehouse employees, mechanic helpers, greasers and tiremen, pickup trucks when hauling materials, tools, or workers to and from and on-the-job site, and fork lifts up to 6,000 lb. capacity.

Class 2. Two or three axle trucks hauling more than 9 ton but hauling less than 16 ton. A-frame winch trucks, hydrolift trucks, vactor trucks or similar equipment when used for transportation purposes. Fork lifts over 6,000 lb. capacity, winch trucks, four axle combination units, and ticket writers.

Class 3. Two, three or four axle trucks hauling 16 ton or more. Drivers on water pulls, articulated dump trucks, mechanics and working forepersons, and dispatchers. Five axle or more combination units.

Class 4. Low Boy and Oil Distributors.

Class 5. Drivers who require special protective clothing while employed on hazardous waste work.

TRUCK DRIVER - OIL AND CHIP RESEALING ONLY.

This shall encompass laborers, workers and mechanics who drive contractor or subcontractor owned, leased, or hired pickup, dump, service, or oil distributor trucks. The work includes transporting materials and equipment (including but not limited to, oils, aggregate supplies, parts, machinery and tools) to or from the job site; distributing oil or liquid asphalt and aggregate; stock piling material when in connection with the actual oil and chip contract. The Truck Driver (Oil & Chip Resealing) wage classification does not include supplier delivered materials.

Other Classifications of Work:

For definitions of classifications not otherwise set out, the Department generally has on file such definitions which are available. If a task to be performed is not subject to one of the classifications of pay set out, the Department will upon being contacted state which neighboring county has such a classification and

provide such rate, such rate being deemed to exist by reference in this document. If no neighboring county rate applies to the task, the Department shall undertake a special determination, such special determination being then deemed to have existed under this determination. If a project requires these, or any classification not listed, please contact IDOL at 217-782-1710 for wage rates or clarifications.

LANDSCAPING

Landscaping work falls under the existing classifications for laborer, operating engineer and truck driver. The work performed by landscape plantsman and landscape laborer is covered by the existing classification of laborer. The work performed by landscape operators (regardless of equipment used or its size) is covered by the classifications of operating engineer. The work performed by landscape truck drivers (regardless of size of truck driven) is covered by the classifications of truck driver.

Iroquois County Prevailing Wage for May 2013

(See explanation of column headings at bottom of wages)

Trade Name	RG	TYP	C	Base	FRMAN	M-F>8	OSA	OSH	H/W	Pensn	Vac	Trng
=====	==	===	=	=====	=====	=====	===	===	=====	=====	=====	=====
ASBESTOS ABT-GEN		BLD		32.910	33.910	1.5	1.5	2.0	8.240	12.26	0.000	0.800
ASBESTOS ABT-GEN		HWY		34.160	35.160	1.5	1.5	2.0	8.240	11.62	0.000	0.800
ASBESTOS ABT-MEC		BLD		34.160	36.660	1.5	1.5	2.0	10.82	10.66	0.000	0.720
BOILERMAKER		BLD		35.010	38.010	2.0	2.0	2.0	7.070	13.83	0.000	0.300
BRICK MASON		BLD		40.000	42.000	1.5	1.5	2.0	7.700	10.42	0.000	0.610
CARPENTER		BLD		35.390	37.390	1.5	1.5	2.0	10.00	13.15	0.000	0.530
CARPENTER		HWY		34.690	36.690	1.5	1.5	2.0	10.00	13.15	0.000	0.530
CEMENT MASON		BLD		40.000	42.000	1.5	1.5	2.0	7.700	10.42	0.000	0.610
CERAMIC TILE FNSHER		BLD		36.000	0.000	1.5	1.5	2.0	7.700	10.42	0.000	0.610
COMMUNICATION TECH		BLD		31.200	32.700	1.5	1.5	2.0	12.32	10.77	0.000	0.320
ELECTRICIAN	NE	BLD		37.950	41.370	1.5	1.5	2.0	13.17	15.06	0.000	1.200
ELECTRICIAN	SW	BLD		37.090	39.090	1.5	1.5	2.0	5.350	7.760	0.000	0.560
ELEVATOR CONSTRUCTOR		BLD		40.520	45.585	2.0	2.0	2.0	11.88	12.71	3.240	0.600
GLAZIER		BLD		30.770	32.770	1.5	1.5	2.0	9.700	7.700	0.000	1.250
HT/FROST INSULATOR		BLD		45.550	48.050	1.5	1.5	2.0	10.82	11.86	0.000	0.720
IRON WORKER		ALL		39.500	43.450	2.0	2.0	2.0	9.390	18.98	0.000	0.700
LABORER		BLD		31.910	32.910	1.5	1.5	2.0	8.240	12.26	0.000	0.800
LABORER		HWY		33.160	34.160	1.5	1.5	2.0	8.240	11.62	0.000	0.800
LABORER, SKILLED		BLD		31.910	32.910	1.5	1.5	2.0	8.240	12.26	0.000	0.800
LABORER, SKILLED		HWY		33.160	34.160	1.5	1.5	2.0	8.240	11.62	0.000	0.800
LATHER		BLD		35.390	37.390	1.5	1.5	2.0	10.00	13.15	0.000	0.530
MACHINIST		BLD		43.550	46.050	1.5	1.5	2.0	6.130	8.950	1.850	0.000
MARBLE FINISHERS		BLD		36.000	0.000	1.5	1.5	2.0	7.700	10.42	0.000	0.610
MARBLE MASON		BLD		40.000	42.000	1.5	1.5	2.0	7.700	10.42	0.000	0.610
MILLWRIGHT		BLD		35.390	37.390	1.5	1.5	2.0	10.00	13.15	0.000	0.530
OPERATING ENGINEER		ALL	1	36.950	0.000	1.5	1.5	2.0	7.250	8.700	0.000	0.800
OPERATING ENGINEER		ALL	2	23.900	0.000	1.5	1.5	2.0	7.250	8.700	0.000	0.800
PAINTER		ALL		32.900	34.900	1.5	1.5	1.5	9.650	8.200	0.000	1.250
PAINTER SIGNS		BLD		33.920	38.090	1.5	1.5	1.5	2.600	2.710	0.000	0.000
PILEDRIVER		BLD		35.390	37.390	1.5	1.5	2.0	10.00	13.15	0.000	0.530
PIPEFITTER		BLD		45.050	48.050	1.5	1.5	2.0	8.460	14.85	0.000	1.780
PLASTERER		BLD		40.000	42.000	1.5	1.5	2.0	7.700	10.42	0.000	0.610
PLUMBER		BLD		43.760	45.760	1.5	1.5	2.0	12.53	10.06	0.000	0.880
ROOFER		BLD		38.350	41.350	1.5	1.5	2.0	8.280	8.770	0.000	0.430
SHEETMETAL WORKER		BLD		42.510	44.510	1.5	1.5	2.0	10.04	12.01	0.000	0.780
SIGN HANGER		BLD		35.390	37.390	1.5	1.5	2.0	10.00	13.15	0.000	0.530
SPRINKLER FITTER		BLD		36.390	39.140	1.5	1.5	2.0	8.420	8.500	0.000	0.450
TERRAZZO FINISHER		BLD		36.000	0.000	1.5	1.5	2.0	7.700	10.42	0.000	0.610
TERRAZZO MASON		BLD		40.000	42.000	1.5	1.5	2.0	7.700	10.42	0.000	0.610

TILE MASON	BLD	40.000	42.000	1.5	1.5	2.0	7.700	10.42	0.000	0.610
TRUCK DRIVER	NW ALL 1	33.410	33.960	1.5	1.5	2.0	8.040	5.610	0.000	0.250
TRUCK DRIVER	NW ALL 2	33.610	33.960	1.5	1.5	2.0	8.040	5.610	0.000	0.250
TRUCK DRIVER	NW ALL 3	33.810	33.960	1.5	1.5	2.0	8.040	5.610	0.000	0.250
TRUCK DRIVER	NW ALL 4	33.960	33.960	1.5	1.5	2.0	8.040	5.610	0.000	0.250
TRUCK DRIVER	SE ALL 1	31.230	0.000	1.5	1.5	2.0	10.30	4.840	0.000	0.250
TRUCK DRIVER	SE ALL 2	31.680	0.000	1.5	1.5	2.0	10.30	4.840	0.000	0.250
TRUCK DRIVER	SE ALL 3	31.890	0.000	1.5	1.5	2.0	10.30	4.840	0.000	0.250
TRUCK DRIVER	SE ALL 4	32.180	0.000	1.5	1.5	2.0	10.30	4.840	0.000	0.250
TRUCK DRIVER	SE ALL 5	33.020	0.000	1.5	1.5	2.0	10.30	4.840	0.000	0.250
TUCKPOINTER	BLD	39.000	41.000	1.5	1.5	2.0	7.400	9.760	0.000	0.580

Legend:

RG (Region)

TYP (Trade Type - All,Highway,Building,Floating,Oil & Chip,Rivers)

C (Class)

Base (Base Wage Rate)

FRMAN (Foreman Rate)

M-F>8 (OT required for any hour greater than 8 worked each day, Mon through Fri.

OSA (Overtime (OT) is required for every hour worked on Saturday)

OSH (Overtime is required for every hour worked on Sunday and Holidays)

H/W (Health & Welfare Insurance)

Pensn (Pension)

Vac (Vacation)

Trng (Training)

Explanations

IROQUOIS COUNTY

ELECTRICIANS (SOUTHWEST) - Townships of Artesia, Loda and Pigeon Grove.

TRUCK DRIVER (SOUTHEAST) - Pigeon Grove, Fountain Creek, Lovejoy, Prairie Green, Milford and Stockland Townships.

The following list is considered as those days for which holiday rates of wages for work performed apply: New Years Day, Memorial Day, Fourth of July, Labor Day, Thanksgiving Day, Christmas Day and Veterans Day in some classifications/counties. Generally, any of these holidays which fall on a Sunday is celebrated on the following Monday. This then makes work performed on that Monday payable at the appropriate overtime rate for holiday pay. Common practice in a given local may alter certain days of celebration. If in doubt, please check with IDOL.

EXPLANATION OF CLASSES

ASBESTOS - GENERAL - removal of asbestos material/mold and hazardous

materials from any place in a building, including mechanical systems where those mechanical systems are to be removed. This includes the removal of asbestos materials/mold and hazardous materials from ductwork or pipes in a building when the building is to be demolished at the time or at some close future date.

ASBESTOS - MECHANICAL - removal of asbestos material from mechanical systems, such as pipes, ducts, and boilers, where the mechanical systems are to remain.

CERAMIC TILE FINISHER, MARBLE FINISHER, AND TERRAZZO FINISHER

The laying, setting and finishing of all tile where used for floors, walls, ceilings, walks, promenade roofs, stair treads, stair risers, facings, hearths, fireplaces, and decorative inserts, together with any marble plinths, thresholds or window stools used in connection with any tile work; also to prepare and set all concrete, cement, brickwork, or other foundation or materials that may be required to properly set and complete such work; the setting or bedding of all tiling, stone, marble, composition, glass, mosaic, or other materials forming the facing, hearth or fireplace of a mantle, or the mantle complete, together with the setting of all cement, brickwork, or other material required in connection with the above work; also the slabbing and fabrication of tile mantels, counters and tile panels of every description and the erection and installation of same and the building, shaping, forming, construction, or repairing of all fireplace work, whether in connection with the mantle hearth facing or not, and the setting and preparing of all material, such as cement, plaster, mortar, brickwork, iron work or other materials necessary for the proper and safe construction and completion of such work. The term "Ceramic" is used for naming the classification only and is in no way a limitation of the product handled. Ceramic takes into consideration most hard tiles.

COMMUNICATIONS TECHNICIAN

Installation, operation, inspection, maintenance, repair and service of radio, television, recording, voice, sound and vision production and reproduction, telephone and telephone interconnect, facsimile, equipment and appliances used for domestic, commercial, educational and entertainment purposes, pulling of wire through conduit but not the installation of conduit.

LABORER, SKILLED - BUILDING

The skilled laborer building (BLD) classification shall encompass the following types of work, irrespective of the site of the work: caisson workers plus depth, gunnite nozzle men, lead man on sewer work, welders, cutters, burners and torchmen, chain saw operators, paving breaker, jackhammer and drill operators, layout man and/or drainage tile layer, steel form setters - street and highway, air tamping hammerman, signal man on crane, concrete saw operator, screenman on asphalt pavers, front end man on chip spreader, laborers tending masons with hot materials or where foreign materials are used, multiple concrete duct-leadman, luteman, asphalt raker, curb asphalt machine operator, ready mix scalemen (permanent, portable or temporary plant), laborers handling masterplate or similar materials, laser beam operator, concrete burning machine operator, coring machine operator, plaster tenders, underpinning and shoring of buildings, material selector when working with fire-brick or castable material, fire watch, signaling of all power equipment, and tree topper or trimmer when in connection with construction.

LABORER, SKILLED - HIGHWAY

The skilled laborer heavy and highway (HWY) classification shall

encompass the following types of work, irrespective of the site of the work: handling of materials treated with oil, creosote, asphalt and/or any foreign materials harmful to skin or clothing, track laborers, chloride handlers, the unloading and loading with steel workers and re-bars, concrete workers (wet), tunnel helpers in free air, batch dumpers, mason tenders, kettle and tar men, plastic installers, scaffold workers, motorized buggies or motorized unit used for wet concrete or handling of building materials, laborers with de-watering systems, sewer workers plus depth, rod and chainmen, vibrator operators, mortar mixer operators, cement silica, clay, fly ash, lime and plasters, handlers (bulk or bag), cofferdam workers plus depth, on concrete paving, placing, cutting and tying or reinforcing, deck hand, dredge hand shore laborers, bankmen on floating plant, asphalt workers with machine, and layers, grade checker, power tools, stripping of all concrete forms excluding paving forms, dumpmen and spotters, when necessary, caisson workers plus depth, gunnite nozzle men, welders, cutters, burners and torchmen, chain saw operators, paving breaker, jackhammer and drill operators, layout man and/or drainage tile layer, steel form setters - street and highway, air tamping hammerman, signal man on crane, concrete saw operator, screedman on asphalt pavers, front end man on chip spreader, multiple concrete duct, luteman, asphalt raker, curb asphalt machine operator, ready mix scalemen (portable or temporary plant), laser beam operator, concrete burning machine operator, and coring machine operator.

TRUCK DRIVER - BUILDING, HEAVY AND HIGHWAY CONSTRUCTION - SOUTHEAST

Class 1. Drivers on 2 axle trucks hauling less than 9 ton. Air compressor and welding machines and brooms, including those pulled by separate units, truck driver helpers, warehouse employees, mechanic helpers, greasers and tiremen, pickup trucks when hauling materials, tools, or workers to and from and on-the-job site, and fork lifts up to 6,000 lb. capacity.

Class 2. Two or three axle trucks hauling more than 9 ton but hauling less than 16 ton. A-frame winch trucks, hydrolift trucks, vactor trucks or similar equipment when used for transportation purposes. Fork lifts over 6,000 lb. capacity, winch trucks, four axle combination units, and ticket writers.

Class 3. Two, three or four axle trucks hauling 16 ton or more. Drivers on water pulls, articulated dump trucks, mechanics and working forepersons, and dispatchers. Five axle or more combination units.

Class 4. Low Boy and Oil Distributors.

Class 5. Drivers who require special protective clothing while employed on hazardous waste work.

TRUCK DRIVER - BUILDING, HEAVY AND HIGHWAY CONSTRUCTION - NORTHWEST

Class 1. Two or three Axle Trucks. A-frame Truck when used for transportation purposes; Air Compressors and Welding Machines, including those pulled by cars, pick-up trucks and tractors; Ambulances; Batch Gate Lockers; Batch Hopperman; Car and Truck Washers; Carry-alls; Fork Lifts and Hoisters; Helpers; Mechanics Helpers and Greasers; Oil Distributors 2-man operation; Pavement Breakers; Pole Trailer, up to 40 feet; Power Mower Tractors; Self-propelled Chip Shreader; Skipman; Slurry Trucks, 2-man operation; Slurry Truck Conveyor Operation, 2 or 3 man; Teamsters; Unskilled dumpman; and Truck Drivers hauling warning lights, barricades, and portable toilets on the job site.

Class 2. Four axle trucks; Dump Crets and Adgetors under 7 yards; Dumpsters, Track Trucks, Euclids, Hug Bottom Dump Turnapulls or

Turntrailers when pulling other than self-loading equipment or similar equipment under 16 cubic yards; Mixer Trucks under 7 yards; Ready-mix Plant Hopper Operator, and Winch Trucks, 2 Axles.

Class 3. Five axle trucks; Dump Crets and Adgetors 7 yards and over; Dumpsters, Track Trucks, Euclids, Hug Bottom Dump Turntrailers or turnpulls when pulling other than self-loading equipment or similar equipment over 16 cubic yards; Explosives and/or Fission Material Trucks; Mixer Trucks 7 yards or over; Mobile Cranes while in transit; Oil Distributors, 1-man operation; Pole Trailer, over 40 feet; Pole and Expandable Trailers hauling material over 50 feet long; Slurry trucks, 1-man operation; Winch trucks, 3 axles or more; Mechanic--Truck Welder and Truck Painter.

Class 4. Six axle trucks; Dual-purpose vehicles, such as mounted crane trucks with hoist and accessories; Foreman; Master Mechanic; Self-loading equipment like P.B. and trucks with scoops on the front.

OPERATING ENGINEERS - BUILDING, HEAVY AND HIGHWAY CONSTRUCTION

Class 1. Power Cranes, Draglines, Derricks, Shovels, Gradalls, Mechanics, Tractor Highlift, Tournadozer, Concrete Mixers with Skip, Tournamixer, Two Drum Machine, One Drum Hoist with Tower or Boom, Cableways, Tower Machines, Motor Patrol, Boom Tractor, Boom or Winch Truck, Winch or Hydraulic Boom Truck, Truck Crane, Tournapull, Tractor Operating Scoops, Bulldozer, Push Tractor, Asphalt Planer, Finishing Machine on Asphalt, Large Rollers on Earth, Rollers on Asphalt Mix, Ross Carrier or similar Machine, Gravel Processing Machine, Asphalt Plant Engineer, Paver Operator, Dredging Equipment, or Dredge Engineer, or Dredge Operator, Central Mix Plant Engineer, CMI or similar type machine, Concrete Pump, Truck or Skid Mounted, Tower Crane, Engineer or Rock Crusher Plant, Concrete Plant Engineer, Ditching Machine with dual attachment, Tractor Mounted Loaders, Cherry Picker, Hydro Crane, Standard or Dinkey Locomotives, Scoopmobiles, Euclid Loader, Soil Cement Machine, Back Filler, Elevating Machine, Power Blade, Drilling Machine, including Well Testing, Caissons, Shaft or any similar type drilling machines, Motor Driven Paint Machine, Pipe Cleaning Machine, Pipe Wrapping Machine, Pipe Bending Machine, Apsco Paver, Boring Machine, (Head Equipment Greaser), Barber-Greene Loaders, Formless Paver, (Well Point System), Concrete Spreader, Hydra Ax, Span Saw, Marine Scoops, Brush Mulcher, Brush Burner, Mesh Placer, Tree Mover, Helicopter Crew (3), Piledriver-Skid or Crawler, Stump Remover, Root Rake, Tug Boat Operator, Refrigerating Machine, Freezing Operator, Chair Cart-Self-Propelled, Hydra Seeder, Straw Blower, Power Sub Grader, Bull Float, Finishing Machine, Self-Propelled Pavement Breaker, Lull (or similar type Machine), Two Air Compressors, Compressors hooked in Manifold, Overhead Crane, Chip Spreader, Mud Cat, Sull-Air, Fork Lifts (except when used for landscaping work), Soil Stabilizer (Seaman Tiller, Bo Mag, Rago Gator, and similar types of equipment), Tube Float, Spray Machine, Curing Machine, Concrete or Asphalt Milling Machine, Snooper Truck-Operator, Backhoe, Farm Tractors (with attachments), 4 Point Lift System (Power Lift or similar type), Skid-Steer (Bob Cat or similar type), Wrecking Shears, Water Blaster.

Class 2. Concrete Mixers without Skips, Rock Crusher, Ditching Machine under 6', Curbing Machine, One Drum Machines without Tower or Boom, Air Tugger, Self-Propelled Concrete Saw, Machine Mounted Post Hole Digger, two to four Generators, Water Pumps or Welding Machines, within 400 feet, Air Compressor 600 cu. ft. and under, Rollers on Aggregate and Seal Coat Surfaces, Fork Lift (when used for landscaping work), Concrete and Blacktop Curb Machine, One Water Pump, Oilers, Air Valves or Steam Valves, One Welding Machine, Truck Jack, Mud Jack, Gunnite Machine, House Elevators when used for hoisting material,

Engine Tenders, Fireman, Wagon Drill, Flex Plane, Conveyor, Siphons and Pulsometer, Switchman, Fireman on Paint Pots, Fireman on Asphalt Plants, Distributor Operator on Trucks, Tampers, Self-Propelled Power Broom, Striping Machine (motor driven), Form Tamper, Bulk Cement Plant, Equipment Greaser, Deck Hands, Truck Crane Oiler-Driver, Cement Blimps, Form Grader, Temporary Heat, Throttle Valve, Super Sucker (and similar type of equipment).

Other Classifications of Work:

For definitions of classifications not otherwise set out, the Department generally has on file such definitions which are available. If a task to be performed is not subject to one of the classifications of pay set out, the Department will upon being contacted state which neighboring county has such a classification and provide such rate, such rate being deemed to exist by reference in this document. If no neighboring county rate applies to the task, the Department shall undertake a special determination, such special determination being then deemed to have existed under this determination. If a project requires these, or any classification not listed, please contact IDOL at 217-782-1710 for wage rates or clarifications.

LANDSCAPING

Landscaping work falls under the existing classifications for laborer, operating engineer and truck driver. The work performed by landscape plantsman and landscape laborer is covered by the existing classification of laborer. The work performed by landscape operators (regardless of equipment used or its size) is covered by the classifications of operating engineer. The work performed by landscape truck drivers (regardless of size of truck driven) is covered by the classifications of truck driver.

Jackson County Prevailing Wage for May 2013

(See explanation of column headings at bottom of wages)

Trade Name	RG	TYP	C	Base	FRMAN	M-F>8	OSA	OSH	H/W	Pensn	Vac	Trng
=====	==	===	=	=====	=====	=====	===	===	=====	=====	=====	=====
ASBESTOS ABT-GEN		ALL		25.300	25.750	1.5	1.5	2.0	5.750	10.35	0.000	0.900
ASBESTOS ABT-MEC		BLD		29.860	30.860	1.5	1.5	2.0	6.950	3.000	0.000	0.000
BOILERMAKER		BLD		31.500	34.000	1.5	1.5	2.0	7.070	18.73	1.000	0.350
BRICK MASON		BLD		28.620	30.120	1.5	1.5	2.0	8.200	7.030	0.000	0.430
CARPENTER		BLD		31.890	33.390	1.5	1.5	2.0	6.550	6.750	0.000	0.400
CARPENTER		HWY		31.840	33.340	1.5	1.5	2.0	6.550	6.750	0.000	0.400
CEMENT MASON		BLD		28.200	29.700	1.5	1.5	2.0	6.600	5.400	0.000	0.500
CEMENT MASON		HWY		27.290	28.290	1.5	1.5	2.0	6.600	5.160	0.000	0.400
CERAMIC TILE FNSHER		BLD		27.120	0.000	1.5	1.5	2.0	8.200	7.030	0.000	0.430
ELECTRIC PWR EQMT OP		ALL	1	35.570	0.000	1.5	1.5	2.0	5.000	9.960	0.000	0.360
ELECTRIC PWR EQMT OP		ALL	2	31.740	0.000	1.5	1.5	2.0	5.000	8.880	0.000	0.320
ELECTRIC PWR GRNDMAN		ALL		26.100	0.000	1.5	1.5	2.0	5.000	7.310	0.000	0.260
ELECTRIC PWR LINEMAN		ALL		44.630	47.650	1.5	1.5	2.0	5.000	12.50	0.000	0.450
ELECTRICIAN		ALL		39.350	41.600	1.5	1.5	2.0	6.140	9.440	0.000	0.790
ELECTRONIC SYS TECH		BLD		32.570	34.320	1.5	1.5	2.0	6.000	4.240	0.000	0.400
FLOOR LAYER		BLD		29.330	30.080	1.5	1.5	2.0	6.550	6.750	0.000	0.400
GLAZIER		BLD		32.780	0.000	2.0	2.0	2.0	9.020	10.80	2.630	0.310
HT/FROST INSULATOR		BLD		37.260	38.260	1.5	1.5	2.0	7.850	11.16	0.000	0.500
IRON WORKER		ALL		27.730	29.730	1.5	1.5	2.0	7.010	11.41	0.000	0.500
LABORER		BLD		25.300	25.750	1.5	1.5	2.0	5.750	10.35	0.000	0.800
LABORER		HWY		25.300	25.750	1.5	1.5	2.0	5.750	10.35	0.000	0.800
LABORER		O&C		17.740	18.190	1.5	1.5	2.0	5.450	8.450	0.000	0.800
MACHINIST		BLD		43.550	46.050	1.5	1.5	2.0	6.130	8.950	1.850	0.000
MARBLE FINISHERS		BLD		27.120	0.000	1.5	1.5	2.0	8.200	7.030	0.000	0.430

MARBLE MASON	BLD	28.620	30.120	1.5	1.5	2.0	8.200	7.030	0.000	0.430
MILLWRIGHT	BLD	31.890	33.390	1.5	1.5	2.0	6.550	6.750	0.000	0.400
MILLWRIGHT	HWY	31.840	33.340	1.5	1.5	2.0	6.550	6.750	0.000	0.400
OE RIVER 1	RIV 1	33.550	34.550	1.5	1.5	2.0	7.000	8.800	0.000	1.450
OE RIVER 2	RIV 2	30.100	34.550	1.5	1.5	2.0	7.000	8.800	0.000	1.450
OPERATING ENGINEER	ALL 1	33.450	34.450	1.5	1.5	2.0	7.000	8.800	0.000	1.450
OPERATING ENGINEER	ALL 2	31.550	34.450	1.5	1.5	2.0	7.000	8.800	0.000	1.450
OPERATING ENGINEER	ALL 3	24.150	34.450	1.5	1.5	2.0	7.000	8.800	0.000	1.450
OPERATING ENGINEER	ALL 4	21.400	27.800	1.5	1.5	2.0	5.650	6.100	0.000	1.100
OPERATING ENGINEER	O&C 1	25.090	26.090	1.5	1.5	2.0	7.000	8.800	0.000	1.450
OPERATING ENGINEER	O&C 2	23.660	26.090	1.5	1.5	2.0	7.000	8.800	0.000	1.450
OPERATING ENGINEER	O&C 3	18.120	26.090	1.5	1.5	2.0	7.000	8.800	0.000	1.450
OPERATING ENGINEER	O&C 4	16.050	21.100	1.5	1.5	2.0	5.650	6.100	0.000	1.100
PAINTER	BLD	26.260	27.760	1.5	1.5	2.0	6.630	7.070	0.000	0.500
PAINTER	HWY	30.560	32.060	1.5	1.5	2.0	6.630	7.070	0.000	0.500
PAINTER OVER 30FT	BLD	27.260	28.760	1.5	1.5	2.0	6.630	7.070	0.000	0.500
PAINTER PWR EQMT	BLD	27.260	28.760	1.5	1.5	2.0	6.630	7.070	0.000	0.500
PAINTER PWR EQMT	HWY	31.560	33.060	1.5	1.5	2.0	6.630	7.070	0.000	0.500
PILEDRIVER	BLD	31.890	33.390	1.5	1.5	2.0	6.550	6.750	0.000	0.400
PILEDRIVER	HWY	31.840	33.340	1.5	1.5	2.0	6.550	6.750	0.000	0.400
PIPEFITTER	BLD	41.470	45.620	1.5	2.0	2.0	8.450	5.780	0.000	1.250
PLASTERER	BLD	28.200	29.700	1.5	1.5	2.0	6.600	5.400	0.000	0.500
PLUMBER	BLD	41.470	45.620	1.5	2.0	2.0	8.450	5.780	0.000	1.250
ROOFER	BLD	23.900	24.900	1.5	1.5	2.0	8.650	3.800	0.000	0.000
SHEETMETAL WORKER	ALL	31.690	33.190	1.5	1.5	2.0	7.130	6.730	1.910	0.360
SPRINKLER FITTER	BLD	36.390	39.140	1.5	1.5	2.0	8.420	8.500	0.000	0.450
STONE MASON	BLD	28.620	30.120	1.5	1.5	2.0	8.200	7.030	0.000	0.430
TERRAZZO FINISHER	BLD	27.120	0.000	1.5	1.5	2.0	8.200	7.030	0.000	0.430
TERRAZZO MASON	BLD	28.620	30.120	1.5	1.5	2.0	8.200	7.030	0.000	0.430
TRUCK DRIVER	ALL 1	30.070	0.000	1.5	1.5	2.0	10.30	6.100	0.000	0.250
TRUCK DRIVER	ALL 2	30.520	0.000	1.5	1.5	2.0	10.30	6.100	0.000	0.250
TRUCK DRIVER	ALL 3	30.740	0.000	1.5	1.5	2.0	10.30	6.100	0.000	0.250
TRUCK DRIVER	ALL 4	31.030	0.000	1.5	1.5	2.0	10.30	6.100	0.000	0.250
TRUCK DRIVER	ALL 5	31.850	0.000	1.5	1.5	2.0	10.30	6.100	0.000	0.250
TRUCK DRIVER	O&C 1	22.750	0.000	1.5	1.5	2.0	2.920	6.700	0.000	0.250
TRUCK DRIVER	O&C 2	19.150	0.000	1.5	1.5	2.0	2.920	6.700	0.000	0.250
TRUCK DRIVER	O&C 3	19.650	0.000	1.5	1.5	2.0	2.920	6.700	0.000	0.250
TUCKPOINTER	BLD	28.620	30.120	1.5	1.5	2.0	8.200	7.030	0.000	0.430

Legend :

RG (Region)

TYP (Trade Type - All,Highway,Building,Floating,Oil & Chip,Rivers)

C (Class)

Base (Base Wage Rate)

FRMAN (Foreman Rate)

M-F>8 (OT required for any hour greater than 8 worked each day, Mon through Fri.)

OSA (Overtime (OT) is required for every hour worked on Saturday)

OSH (Overtime is required for every hour worked on Sunday and Holidays)

H/W (Health & Welfare Insurance)

Pensn (Pension)

Vac (Vacation)

Explanations

JACKSON COUNTY

The following list is considered as those days for which holiday rates of wages for work performed apply: New Years Day, Memorial Day, Fourth of July, Labor Day, Thanksgiving Day, Christmas Day and Veterans Day in some classifications/counties. Generally, any of these holidays which fall on a Sunday is celebrated on the following Monday. This then makes work performed on that Monday payable at the appropriate overtime rate for holiday pay. Common practice in a given local may alter certain days of celebration. If in doubt, please check with IDOL.

Oil and chip resealing (O&C) means the application of road oils and liquid asphalt to coat an existing road surface, followed by application of aggregate chips or gravel to coated surface, and subsequent rolling of material to seal the surface.

EXPLANATION OF CLASSES

ASBESTOS - GENERAL - removal of asbestos material/mold and hazardous materials from any place in a building, including mechanical systems where those mechanical systems are to be removed. This includes the removal of asbestos materials/mold and hazardous materials from ductwork or pipes in a building when the building is to be demolished at the time or at some close future date.

ASBESTOS - MECHANICAL - removal of asbestos material from mechanical systems, such as pipes, ducts, and boilers, where the mechanical systems are to remain.

LABORER - OIL AND CHIP RESEALING

Hook and unhook chip box from aggregate truck; distribute material within chip box; perform flagging work related to oil and chip resealing; hand spray oil fluids; handle traffic control, including setting-up and maintaining barricades, drums, cones, delineators, signs and other such items, as well as laying-out and applying or removing temporary roadway markings used to control traffic in job site related to oil and chip resealing; and perform clean-up related to oil and chip resealing.

CERAMIC TILE FINISHER, MARBLE FINISHER, TERRAZZO FINISHER

Assisting, helping or supporting the tile, marble and terrazzo mechanic by performing their historic and traditional work assignments required to complete the proper installation of the work covered by said crafts. The term "Ceramic" is used for naming the classification only, and is in no a limitation of the product handled. Ceramic takes into consideration most hard tiles.

ELECTRIC POWER LINEMAN

Construction, maintenance and dismantling of overhead and underground electric power lines, including high voltage pipe type cable work, and associated structures and equipment.

ELECTRIC POWER EQUIPMENT OPERATOR - CLASS 1

Operation of all crawler type equipment D-4 and larger from the ground to assist the Electric Power Linemen in performing their duties.

ELECTRIC POWER EQUIPMENT OPERATORS - CLASS 2

Operation of all other equipment from the ground to assist the Electric Power Linemen in performing their duties.

ELECTRIC POWER GROUNDMAN

Applies to workers who assist the Electric Power Lineman from the ground.

ELECTRONIC SYSTEMS TECHNICIAN

Installation, service and maintenance of low-voltage systems which utilizes the transmission and/or transference of voice, sound, vision, or digital for commercial, education, security and entertainment purposes for the following: TV monitoring and surveillance, background/foreground music, intercom and telephone interconnect, field programming, inventory control systems, microwave transmission, multi-media, multiplex, radio page, school, intercom and sound burglar alarms and low voltage master clock systems.

Excluded from this classification are energy management systems, life safety systems, supervisory controls and data acquisition systems not intrinsic with the above listed systems, fire alarm systems, nurse call systems and raceways exceeding fifteen feet in length.

TRUCK DRIVER - BUILDING, HEAVY AND HIGHWAY CONSTRUCTION

Class 1. Drivers on 2 axle trucks hauling less than 9 ton. Air compressor and welding machines and brooms, including those pulled by separate units, truck driver helpers, warehouse employees, mechanic helpers, greasers and tiremen, pickup trucks when hauling materials, tools, or workers to and from and on-the-job site, and fork lifts up to 6,000 lb. capacity.

Class 2. Two or three axle trucks hauling more than 9 ton but hauling less than 16 ton. A-frame winch trucks, hydrolift trucks, vactor trucks or similar equipment when used for transportation purposes. Fork lifts over 6,000 lb. capacity, winch trucks, four axle combination units, and ticket writers.

Class 3. Two, three or four axle trucks hauling 16 ton or more. Drivers on water pulls, articulated dump trucks, mechanics and working forepersons, and dispatchers. Five axle or more combination units.

Class 4. Low Boy and Oil Distributors.

Class 5. Drivers who require special protective clothing while employed on hazardous waste work.

TRUCK DRIVER - O & C (Oil and Chip Resealing ONLY)

It involves driving of contractor or subcontractor owned, leased, or hired pickup, dump, service, or oil distributor trucks. Includes transporting materials and equipment (including, but not limited to oils, aggregate supplies, parts, machinery and tools) to or from the job site; distributing oil or liquid asphalt and aggregate; stock piling material; and maintaining trucks at job site related to oil and chip resealing.

Class 1. Distributors, liquid asphalt hauling and hauling of asphalt rubber-tired rollers.

Class 2. Stockpiling.

Class 3. Tandem hauling to job site.

OPERATING ENGINEERS - BUILDING, HEAVY AND HIGHWAY CONSTRUCTION

Class 1. APSCO or Equal Spreading Machine, Backhoe, Backfiller, Boom or Winch Cat, Bituminous Mixplane Machine, Blacksmith, Bituminous Surfacing Machine, Bull-Dozer, Crane, Shovel, Dragline, Truck Crane, Pile Driver, Concrete Breaker, Concrete or Pumpcrete Pumps, Dinky or Standard Locomotives, Well or Caisson Drills, Elevating Grader, Fork Lifts, Flexplane, Gradeall, Hi-Lift Hoists, Guy-Derricks, Hysters, Mechanic Motor Patrol, Mixers-21 cu. ft. or over, Push Cats, Pulls and Scrapers, Two Well Point Pumps, Pulverizer or Tiller, PugMill, Rubber-Tired Farm Type Tractor with Bulldozer/Blade/Auger or hi-lift over 1/2 yd., Jersey Spreader, Tract-Air used with Drill or Hi-Lift, Trenching or Ditching Machines, Wood Chipper w/Tractor, Self-Propelled Roller w/Blade, Equipment Greaser, Self-Propelled Bump Grinder on Concrete pavement, Boat Operator, Skid-Loaders, Tuggers, Lazer Screed, and Self-Propelled Chip Spreader (when others run conveyors).

Class 2. Any type tractor pulling any type roller or disc, Two Air Compressors (220 cu. ft. capacity or over), Two AirTract Drills, Air-Track Drill w/Compressor, Automatic Bins or Scales w/Compressor or Generator, Pipeline Boring Machine, Bulk Cement Plant w/Separate Compressor, Power Operated Bull Float, Hydra-Lift w/Single Motor, Straw Mulcher Blower w/Spout, Self-Propelled Roller/Compactor, Back-End man on Bituminous Surfacing Machine, oiler on milling machine.

Class 3. Air Compressor w/Valve driving piling, Boom or Winch Type Truck, Two Conveyors, Self-Propelled Concrete Saw, Form Grader, Truck Crane Oiler, Self-Propelled Vibrator, Rubber Tired Farm Type Tractor w/Blade/Bulldozer/Auger/hi-lift - 1/2 yd. or less, Elevator Operator, Man Lift (scissor lift) when lifting materials.

Class 4. Air-Track Drill (one), Belt Drag Machine, Power Broom, Mechanical Plasterer Applicator, Trac-Air, Air Compressor (220 cu. ft. or over) One, Air Compressor (under 220 cu. ft) four, Automatic Bin, Bulk Cement Plant w/Built-in Compressor running off same motor or electric motor, Fireman or Switchman, Self-Propelled Form Tamper, Light Plants (4), Welding Machines (4), Pumps (4), or Combination of four (4) Pumps, Light Plants, Welding Machines, Air-Compressors (under 220 cu. ft.), Mudjacks or Wood Chipper, Mixers - less than 21 cu. ft. Mortar Mixer w/Skip or Pump, Pipeline Tract Jack. One Operating Engineer may operate and maintain any combination of the following pieces of equipment, not to exceed four (4) which shall be within a reasonable distance, such combination may include any equipment in this classification: (Compressors, Light Plants, Generators, Welding Machines, Pumps or Conveyors), One Well- Point Pump, Two Motor Driven Heaters, One Air Compressor (under 220 cu. ft.), One Engine-Driven Conveyor, One Motor Driven Heater, One Light Plant, One Pump, One Welding Machine, One Ulmac or Equal Spreader, Oilers, and one Generator 10 kw or greater.

OPERATING ENGINEER - O & C (Oil and Chip Resealing ONLY). Includes the operation of all motorized heavy equipment used in oil and chip rsealing, including but not limited to operating self-propelled chip spreaders, and all types of rollers (both hard and rubber tired); and other duties pertaining to the operation or maintenance of heavy equipment relatd to oil and chip resealing.

Class 1. See Class 1 above for types of equipment operated.

Class 2. See Class 2 above for types of equipment operated.

Class 3. See Class 3 above for types of equipment operated.

Class 4. See Class 4 above for types of equipment operated.

OPERATING ENGINEER RIVER WORK 1 - operate the following machines when working on River Work and Levee Work on the Mississippi and Ohio Rivers, Lakes and Tributaries: Crane, Shovel, Dragline, Scrapers, Dredge, Derrick, Pile-Driver, Push Boat, all power boat operators, Mechanic, Engineman on Dredge, Leverman on Dredge, All Bituminous Spreader machines, Backhoe, Backfiller, Boom, or Winch Cat, Bituminous Mixplane Machine, Blacksmith, Bituminous Surfacing Machine, Bulldozer, Truck Cranes, Hydraulic Truck Mounted Boom/Crane, Concrete Finishing Machine, or Spreader Machine, Concrete Breaker, Concrete or Pumpcrete Machines, Concrete Plant Operator, All Off Road Material Hauling Equipment, Dinky or Standard Locomotives, Well Drill, Elevating Grader, Fork-Lifts, Flexplane, Gradeall, Hi-Lift, Power Handblade Tugger type Hoist, Hoist Two Drum (or over one), Gyderrick, Hyster, Motor Patrol, Mixers - 21 Cu. Ft. or over, Push Cat, Pulls, & Scrapers, Pumps-Two Well Points, Equipment Greaser, P & H Pulverizer or Pulverizer equal to Pugmill, Pugmill, Rubber-Tired farm type tractor w/Bulldozer/Blade/Auger or Hi-Lift over ½ yard, Skimmer Scoops, Seaman Tiller, Jersey Spreader, Tract-Air used with Drill or Hi-Lift, Trenching or Ditching Machine, Wood Chipper w/Tractor, self-propelled roller w/Blade, Concrete Pumps and Small Equipment Operators.

OPERATING ENGINEER RIVER 2 - when working on River Work and Levee Work on the Mississippi and Ohio Rivers, Lakes and Tributaries shall be employed as the Oiler or Fireman on Crane, Dragline, Shovel, Dredge, Truck Crane, Pile Driver, Gradeall, Dinky or Standard Locomotive, Guy Derrick, Trenching Machine or Ditching Machine 80 H.P. and over, All Terrain (cherry-picker) with over 40 ton Lifting Capacity, Deck Oiler and Deckhands.

Other Classifications of Work:

For definitions of classifications not otherwise set out, the Department generally has on file such definitions which are available. If a task to be performed is not subject to one of the classifications of pay set out, the Department will upon being contacted state which neighboring county has such a classification and provide such rate, such rate being deemed to exist by reference in this document. If no neighboring county rate applies to the task, the Department shall undertake a special determination, such special determination being then deemed to have existed under this determination. If a project requires these, or any classification not listed, please contact IDOL at 217-782-1710 for wage rates or clarifications.

LANDSCAPING

Landscaping work falls under the existing classifications for laborer, operating engineer and truck driver. The work performed by landscape plantsman and landscape laborer is covered by the existing classification of laborer. The work performed by landscape operators (regardless of equipment used or its size) is covered by the classifications of operating engineer. The work performed by landscape truck drivers (regardless of size of truck driven) is covered by the classifications of truck driver.

Jasper County Prevailing Wage for May 2013

(See explanation of column headings at bottom of wages)

Trade Name	RG	TYP	C	Base	FRMAN	M-F>8	OSA	OSH	H/W	Pensn	Vac	Trng
=====	==	===	=	=====	=====	=====	===	===	=====	=====	=====	=====
ASBESTOS ABT-GEN		ALL		25.300	25.750	1.5	1.5	2.0	5.750	10.35	0.000	0.900
ASBESTOS ABT-MEC		BLD		21.150	22.150	1.5	1.5	2.0	6.400	5.150	0.000	0.650
BOILERMAKER		BLD		31.500	34.000	1.5	1.5	2.0	7.070	18.73	1.000	0.350
BRICK MASON		BLD		29.000	30.500	2.0	2.0	2.0	6.600	9.730	0.000	0.630
CARPENTER		BLD		29.600	31.850	1.5	1.5	2.0	7.450	12.65	0.000	0.520
CARPENTER		HWY		28.290	30.040	1.5	1.5	2.0	7.450	12.65	0.000	0.520
CEMENT MASON		BLD		28.200	29.700	1.5	1.5	2.0	6.600	5.400	0.000	0.500
CEMENT MASON		HWY		27.080	28.580	1.5	1.5	2.0	6.600	5.800	0.000	0.300
CERAMIC TILE FNSHER		BLD		28.400	0.000	1.5	1.5	2.0	6.600	7.930	0.000	0.000
COMM SYSTEMS TECH		BLD		26.110	28.700	1.5	1.5	2.0	5.350	5.680	0.000	0.290
ELECTRIC PWR EQMT OP		ALL	1	35.570	0.000	1.5	1.5	2.0	5.000	9.960	0.000	0.360
ELECTRIC PWR EQMT OP		ALL	2	31.740	0.000	1.5	1.5	2.0	5.000	8.880	0.000	0.320
ELECTRIC PWR GRNDMAN		ALL		26.100	0.000	1.5	1.5	2.0	5.000	7.310	0.000	0.260
ELECTRIC PWR LINEMAN		ALL		44.630	47.650	1.5	1.5	2.0	5.000	12.50	0.000	0.450
ELECTRICIAN		BLD		34.920	37.360	1.5	1.5	2.0	5.350	9.030	0.000	0.290
ELEVATOR CONSTRUCTOR		BLD		40.520	45.585	2.0	2.0	2.0	11.88	12.71	3.240	0.600
GLAZIER		BLD		26.780	28.030	1.5	1.5	2.0	6.120	5.200	0.000	0.300
HT/FROST INSULATOR		BLD		29.450	30.450	1.5	1.5	2.0	5.050	9.730	0.000	0.280
IRON WORKER		ALL		28.600	31.460	1.5	1.5	2.0	6.450	11.30	0.000	0.300
LABORER		BLD		25.300	25.750	1.5	1.5	2.0	5.750	10.35	0.000	0.800
LABORER		HWY		25.300	25.750	1.5	1.5	2.0	5.750	10.35	0.000	0.800
LATHER		BLD		29.600	31.850	1.5	1.5	2.0	7.450	12.65	0.000	0.520
MACHINIST		BLD		43.550	46.050	1.5	1.5	2.0	6.130	8.950	1.850	0.000
MARBLE FINISHERS		BLD		28.400	0.000	1.5	1.5	2.0	6.600	7.930	0.000	0.000
MARBLE MASON		BLD		29.900	0.000	1.5	1.5	2.0	6.600	7.930	0.000	0.000
MILLWRIGHT		BLD		29.620	31.870	1.5	1.5	2.0	7.450	13.09	0.000	0.520
MILLWRIGHT		HWY		31.980	33.730	1.5	1.5	2.0	7.450	13.40	0.000	0.520
OPERATING ENGINEER		ALL	1	36.950	0.000	1.5	1.5	2.0	7.250	8.700	0.000	0.800
OPERATING ENGINEER		ALL	2	23.900	0.000	1.5	1.5	2.0	7.250	8.700	0.000	0.800
PAINTER		ALL		26.000	27.500	1.5	1.5	2.0	7.700	8.230	0.000	0.450
PILEDRIVER		BLD		30.100	32.350	1.5	1.5	2.0	7.450	12.65	0.000	0.520
PILEDRIVER		HWY		29.290	31.040	1.5	1.5	2.0	7.450	12.65	0.000	0.520
PIPEFITTER		BLD		37.680	40.180	1.5	1.5	2.0	7.000	10.61	0.000	0.980
PLASTERER		BLD		28.200	29.700	1.5	1.5	2.0	6.600	5.400	0.000	0.500
PLUMBER		BLD		37.680	40.180	1.5	1.5	2.0	7.000	10.61	0.000	0.980
ROOFER		BLD		26.100	28.600	1.5	1.5	2.0	9.600	6.280	0.000	0.550
SHEETMETAL WORKER		ALL		31.690	33.190	1.5	1.5	2.0	7.130	6.730	1.910	0.360
SPRINKLER FITTER		BLD		36.390	39.140	1.5	1.5	2.0	8.420	8.500	0.000	0.450
STONE MASON		BLD		29.000	30.500	2.0	2.0	2.0	6.600	9.730	0.000	0.630
TERRAZZO FINISHER		BLD		28.400	0.000	1.5	1.5	2.0	6.600	7.930	0.000	0.000
TERRAZZO MASON		BLD		29.900	0.000	1.5	1.5	2.0	6.600	7.930	0.000	0.000
TILE LAYER		BLD		29.600	31.850	1.5	1.5	2.0	7.450	12.65	0.000	0.520
TILE MASON		BLD		29.900	0.000	1.5	1.5	2.0	6.600	7.930	0.000	0.000
TRUCK DRIVER		ALL	1	31.230	0.000	1.5	1.5	2.0	10.30	4.840	0.000	0.250
TRUCK DRIVER		ALL	2	31.680	0.000	1.5	1.5	2.0	10.30	4.840	0.000	0.250
TRUCK DRIVER		ALL	3	31.890	0.000	1.5	1.5	2.0	10.30	4.840	0.000	0.250
TRUCK DRIVER		ALL	4	32.180	0.000	1.5	1.5	2.0	10.30	4.840	0.000	0.250
TRUCK DRIVER		ALL	5	33.020	0.000	1.5	1.5	2.0	10.30	4.840	0.000	0.250
TRUCK DRIVER		O&C	1	24.980	0.000	1.5	1.5	2.0	10.30	4.840	0.000	0.250
TRUCK DRIVER		O&C	2	25.340	0.000	1.5	1.5	2.0	10.30	4.840	0.000	0.250
TRUCK DRIVER		O&C	3	25.510	0.000	1.5	1.5	2.0	10.30	4.840	0.000	0.250
TRUCK DRIVER		O&C	4	25.740	0.000	1.5	1.5	2.0	10.30	4.840	0.000	0.250
TRUCK DRIVER		O&C	5	26.420	0.000	1.5	1.5	2.0	10.30	4.840	0.000	0.250
TUCKPOINTER		BLD		29.000	30.500	2.0	2.0	2.0	6.600	9.730	0.000	0.630

Legend:

RG (Region)

TYP (Trade Type - All,Highway,Building,Floating,Oil & Chip,Rivers)

C (Class)

Base (Base Wage Rate)

FRMAN (Foreman Rate)

M-F>8 (OT required for any hour greater than 8 worked each day, Mon through Fri.)

OSA (Overtime (OT) is required for every hour worked on Saturday)

OSH (Overtime is required for every hour worked on Sunday and Holidays)

H/W (Health & Welfare Insurance)

Pensn (Pension)

Vac (Vacation)

Trng (Training)

Explanations

JASPER COUNTY

The following list is considered as those days for which holiday rates of wages for work performed apply: New Years Day, Memorial Day, Fourth of July, Labor Day, Thanksgiving Day, Christmas Day and Veterans Day in some classifications/counties. Generally, any of these holidays which fall on a Sunday is celebrated on the following Monday. This then makes work performed on that Monday payable at the appropriate overtime rate for holiday pay. Common practice in a given local may alter certain days of celebration. If in doubt, please check with IDOL.

Oil and chip resealing (O&C) means the application of road oils and liquid asphalt to coat an existing road surface, followed by application of aggregate chips or gravel to coated surface, and subsequent rolling of material to seal the surface.

EXPLANATION OF CLASSES

ASBESTOS - GENERAL - removal of asbestos material/mold and hazardous materials from any place in a building, including mechanical systems where those mechanical systems are to be removed. This includes the removal of asbestos materials/mold and hazardous materials from ductwork or pipes in a building when the building is to be demolished at the time or at some close future date.

ASBESTOS - MECHANICAL - removal of asbestos material from mechanical systems, such as pipes, ducts, and boilers, where the mechanical systems are to remain.

CERAMIC TILE FINISHER, MARBLE FINISHER, TERRAZZO FINISHER

Assisting, helping or supporting the tile, marble and terrazzo mechanic by performing their historic and traditional work assignments required to complete the proper installation of the work covered by said crafts. The term "Ceramic" is used for naming the classification only and is in no way a limitation of the product handled. Ceramic takes into consideration most hard tiles.

COMMUNICATION SYSTEMS TECHNICIAN

Installation, operation, inspection, maintenance, repair, and service of radio, television, recording, voice sound and vision production and reproduction apparatus, equipment and appliances used for domestic, commercial, education, entertainment and private telephone systems.

ELECTRIC POWER LINEMAN

Construction, maintenance and dismantling of overhead and underground electric power lines, including high voltage pipe type cable work, and associated structures and equipment.

ELECTRIC POWER EQUIPMENT OPERATOR - CLASS 1

Operation of all crawler type equipment D-4 and larger from the ground to assist the Electric Power Linemen in performing their duties.

ELECTRIC POWER EQUIPMENT OPERATORS - CLASS 2

Operation of all other equipment from the ground to assist the Electric Power Linemen in performing their duties.

ELECTRIC POWER GROUNDMAN

Applies to workers who assist the Electric Power Lineman from the ground.

TRUCK DRIVER - BUILDING, HEAVY AND HIGHWAY CONSTRUCTION

Class 1. Drivers on 2 axle trucks hauling less than 9 ton. Air compressor and welding machines and brooms, including those pulled by separate units, truck driver helpers, warehouse employees, mechanic helpers, greasers and tiremen, pickup trucks when hauling materials, tools, or workers to and from and on-the-job site, and fork lifts up to 6,000 lb. capacity.

Class 2. Two or three axle trucks hauling more than 9 ton but hauling less than 16 ton. A-frame winch trucks, hydrolift trucks, vector trucks or similar equipment when used for transportation purposes. Fork lifts over 6,000 lb. capacity, winch trucks, four axle combination units, and ticket writers.

Class 3. Two, three or four axle trucks hauling 16 ton or more. Drivers on water pulls, articulated dump trucks, mechanics and working forepersons, and dispatchers. Five axle or more combination units.

Class 4. Low Boy and Oil Distributors.

Class 5. Drivers who require special protective clothing while employed on hazardous waste work.

TRUCK DRIVER - OIL AND CHIP RESEALING ONLY.

This shall encompass laborers, workers and mechanics who drive contractor or subcontractor owned, leased, or hired pickup, dump, service, or oil distributor trucks. The work includes transporting materials and equipment (including but not limited to, oils, aggregate supplies, parts, machinery and tools) to or from the job site; distributing oil or liquid asphalt and aggregate; stock piling material when in connection with the actual oil and chip contract. The Truck Driver (Oil & Chip Resealing) wage classification does not include supplier delivered materials.

OPERATING ENGINEERS - BUILDING, HEAVY AND HIGHWAY CONSTRUCTION

Class 1. Power Cranes, Draglines, Derricks, Shovels, Gradalls, Mechanics, Tractor Highlift, Tournadozer, Concrete Mixers with Skip, Tournamixer, Two Drum Machine, One Drum Hoist with Tower or Boom, Cableways, Tower Machines, Motor Patrol, Boom Tractor, Boom or Winch Truck, Winch or Hydraulic Boom Truck, Truck Crane, Tournapull, Tractor Operating Scoops, Bulldozer, Push Tractor, Asphalt Planer, Finishing Machine on Asphalt, Large Rollers on Earth, Rollers on Asphalt Mix, Ross Carrier or similar Machine, Gravel Processing Machine, Asphalt Plant Engineer, Paver Operator, Dredging Equipment, or Dredge Engineer, or Dredge Operator, Central Mix Plant Engineer, CMI or similar type machine, Concrete Pump, Truck or Skid Mounted, Tower Crane, Engineer or Rock Crusher Plant, Concrete Plant Engineer, Ditching Machine with dual attachment, Tractor Mounted Loaders, Cherry Picker, Hydro Crane, Standard or Dinkey Locomotives, Scoopmobiles, Euclid Loader, Soil Cement Machine, Back Filler, Elevating Machine, Power Blade, Drilling Machine, including Well Testing, Caissons, Shaft or any similar type drilling machines, Motor Driven Paint Machine, Pipe Cleaning Machine, Pipe Wrapping Machine, Pipe Bending Machine, Apsco Paver, Boring Machine, (Head Equipment Greaser), Barber-Greene Loaders, Formless Paver, (Well Point System), Concrete Spreader, Hydra Ax, Span Saw, Marine Scoops, Brush Mulcher, Brush Burner, Mesh Placer, Tree Mover, Helicopter Crew (3), Piledriver-Skid or Crawler, Stump Remover, Root Rake, Tug Boat Operator, Refrigerating Machine, Freezing Operator, Chair Cart-Self-Propelled, Hydra Seeder, Straw Blower, Power Sub Grader, Bull Float, Finishing Machine, Self-Propelled Pavement Breaker, Lull (or similar type Machine), Two Air Compressors, Compressors hooked in Manifold, Overhead Crane, Chip Spreader, Mud Cat, Sull-Air, Fork Lifts (except when used for landscaping work), Soil Stabilizer (Seaman Tiller, Bo Mag, Rago Gator, and similar types of equipment), Tube Float, Spray Machine, Curing Machine, Concrete or Asphalt Milling Machine, Snooper Truck-Operator, Backhoe, Farm Tractors (with attachments), 4 Point Lift System (Power Lift or similar type), Skid-Steer (Bob Cat or similar type), Wrecking Shears, Water Blaster.

Class 2. Concrete Mixers without Skips, Rock Crusher, Ditching Machine under 6', Curbing Machine, One Drum Machines without Tower or Boom, Air Tugger, Self-Propelled Concrete Saw, Machine Mounted Post Hole Digger, two to four Generators, Water Pumps or Welding Machines, within 400 feet, Air Compressor 600 cu. ft. and under, Rollers on Aggregate and Seal Coat Surfaces, Fork Lift (when used for landscaping work), Concrete and Blacktop Curb Machine, One Water Pump, Oilers, Air Valves or Steam Valves, One Welding Machine, Truck Jack, Mud Jack, Gunnite Machine, House Elevators when used for hoisting material, Engine Tenders, Fireman, Wagon Drill, Flex Plane, Conveyer, Siphons and Pulsometer, Switchman, Fireman on Paint Pots, Fireman on Asphalt Plants, Distributor Operator on Trucks, Tampers, Self-Propelled Power Broom, Striping Machine (motor driven), Form Tamper, Bulk Cement Plant, Equipment Greaser, Deck Hands, Truck Crane Oiler-Driver, Cement Blimps, Form Grader, Temporary Heat, Throttle Valve, Super Sucker (and similar type of equipment).

Other Classifications of Work:

For definitions of classifications not otherwise set out, the Department generally has on file such definitions which are available. If a task to be performed is not subject to one of the classifications of pay set out, the Department will upon being contacted state which neighboring county has such a classification and provide such rate, such rate being deemed to exist by reference in this document. If no neighboring county rate applies to the task, the Department shall undertake a special determination, such special determination being then deemed to have existed under this determination. If a project requires these, or any classification not

listed, please contact IDOL at 217-782-1710 for wage rates or clarifications.

LANDSCAPING

Landscaping work falls under the existing classifications for laborer, operating engineer and truck driver. The work performed by landscape plantsman and landscape laborer is covered by the existing classification of laborer. The work performed by landscape operators (regardless of equipment used or its size) is covered by the classifications of operating engineer. The work performed by landscape truck drivers (regardless of size of truck driven) is covered by the classifications of truck driver.

Jefferson County Prevailing Wage for May 2013

(See explanation of column headings at bottom of wages)

Trade Name	RG	TYP	C	Base	FRMAN	M-F>8	OSA	OSH	H/W	Pensn	Vac	Trng
=====	==	===	=	=====	=====	=====	===	===	=====	=====	=====	=====
ASBESTOS ABT-GEN		ALL		25.300	25.750	1.5	1.5	2.0	5.750	10.35	0.000	0.900
ASBESTOS ABT-MEC		BLD		29.860	30.860	1.5	1.5	2.0	6.950	3.000	0.000	0.000
BOILERMAKER		BLD		31.500	34.000	1.5	1.5	2.0	7.070	18.73	1.000	0.350
BRICK MASON		BLD		28.620	30.120	1.5	1.5	2.0	8.200	7.030	0.000	0.430
CARPENTER		BLD		31.890	33.390	1.5	1.5	2.0	6.550	6.750	0.000	0.400
CARPENTER		HWY		31.890	33.640	1.5	1.5	2.0	6.550	6.750	0.000	0.400
CEMENT MASON		BLD		28.200	29.700	1.5	1.5	2.0	6.600	5.400	0.000	0.500
CEMENT MASON		HWY		27.080	28.580	1.5	1.5	2.0	6.600	5.800	0.000	0.300
CERAMIC TILE FNSHER		BLD		27.120	0.000	1.5	1.5	2.0	8.200	7.030	0.000	0.430
ELECTRIC PWR EQMT OP		ALL	1	35.570	0.000	1.5	1.5	2.0	5.000	9.960	0.000	0.360
ELECTRIC PWR EQMT OP		ALL	2	31.740	0.000	1.5	1.5	2.0	5.000	8.880	0.000	0.320
ELECTRIC PWR GRNDMAN		ALL		26.100	0.000	1.5	1.5	2.0	5.000	7.310	0.000	0.260
ELECTRIC PWR LINEMAN		ALL		44.630	47.650	1.5	1.5	2.0	5.000	12.50	0.000	0.450
ELECTRICIAN		ALL		39.350	41.600	1.5	1.5	2.0	6.140	9.440	0.000	0.790
ELECTRONIC SYS TECH		BLD		32.570	34.320	1.5	1.5	2.0	6.000	4.240	0.000	0.400
FLOOR LAYER		BLD		29.330	30.080	1.5	1.5	2.0	6.550	6.750	0.000	0.400
GLAZIER		BLD		26.780	28.030	1.5	1.5	2.0	6.120	5.200	0.000	0.300
HT/FROST INSULATOR		BLD		37.260	38.260	1.5	1.5	2.0	7.850	11.16	0.000	0.500
IRON WORKER		ALL		31.500	33.500	1.5	1.5	2.0	7.610	13.33	0.000	0.420
LABORER		BLD		25.300	25.750	1.5	1.5	2.0	5.750	10.35	0.000	0.800
LABORER		HWY		25.300	25.750	1.5	1.5	2.0	5.750	10.35	0.000	0.800
MACHINIST		BLD		43.550	46.050	1.5	1.5	2.0	6.130	8.950	1.850	0.000
MARBLE FINISHERS		BLD		27.120	0.000	1.5	1.5	2.0	8.200	7.030	0.000	0.430
MARBLE MASON		BLD		28.620	30.120	1.5	1.5	2.0	8.200	7.030	0.000	0.430
MILLWRIGHT		BLD		31.890	33.390	1.5	1.5	2.0	6.550	6.750	0.000	0.400
MILLWRIGHT		HWY		32.390	34.140	1.5	1.5	2.0	6.550	6.750	0.000	0.400
OPERATING ENGINEER		BLD	1	34.200	37.200	1.5	1.5	2.0	9.000	17.00	0.000	1.000
OPERATING ENGINEER		BLD	2	33.070	37.200	1.5	1.5	2.0	9.000	17.00	0.000	1.000
OPERATING ENGINEER		BLD	3	28.590	37.200	1.5	1.5	2.0	9.000	17.00	0.000	1.000
OPERATING ENGINEER		BLD	4	28.650	37.200	1.5	1.5	2.0	9.000	17.00	0.000	1.000
OPERATING ENGINEER		BLD	5	28.320	37.200	1.5	1.5	2.0	9.000	17.00	0.000	1.000
OPERATING ENGINEER		BLD	6	35.750	37.200	1.5	1.5	2.0	9.000	17.00	0.000	1.000
OPERATING ENGINEER		BLD	7	36.050	37.200	1.5	1.5	2.0	9.000	17.00	0.000	1.000
OPERATING ENGINEER		BLD	8	36.330	37.200	1.5	1.5	2.0	9.000	17.00	0.000	1.000
OPERATING ENGINEER		BLD	9	35.650	37.200	1.5	1.5	2.0	9.000	17.00	0.000	1.000
OPERATING ENGINEER		HWY	1	32.700	35.700	1.5	1.5	2.0	9.000	17.00	0.000	1.000
OPERATING ENGINEER		HWY	2	31.570	35.700	1.5	1.5	2.0	9.000	17.00	0.000	1.000
OPERATING ENGINEER		HWY	3	27.090	35.700	1.5	1.5	2.0	9.000	17.00	0.000	1.000
OPERATING ENGINEER		HWY	4	27.150	35.700	1.5	1.5	2.0	9.000	17.00	0.000	1.000
OPERATING ENGINEER		HWY	5	26.820	35.700	1.5	1.5	2.0	9.000	17.00	0.000	1.000
OPERATING ENGINEER		HWY	6	34.250	35.700	1.5	1.5	2.0	9.000	17.00	0.000	1.000
OPERATING ENGINEER		HWY	7	34.550	35.700	1.5	1.5	2.0	9.000	17.00	0.000	1.000
OPERATING ENGINEER		HWY	8	34.830	35.700	1.5	1.5	2.0	9.000	17.00	0.000	1.000
OPERATING ENGINEER		HWY	9	34.150	35.700	1.5	1.5	2.0	9.000	17.00	0.000	1.000

PAINTER	ALL	23.190	23.690	1.5	1.5	2.0	5.000	6.840	0.000	0.480
PAINTER OVER 30FT	ALL	26.290	26.790	1.5	1.5	2.0	5.000	6.840	0.000	0.480
PAINTER PWR EQMT	ALL	26.290	26.790	1.5	1.5	2.0	5.000	6.840	0.000	0.480
PILEDRIVER	BLD	31.890	33.390	1.5	1.5	2.0	6.550	6.750	0.000	0.400
PILEDRIVER	HWY	32.390	34.140	1.5	1.5	2.0	6.550	6.750	0.000	0.400
PIPEFITTER	BLD	37.000	40.700	1.5	1.5	2.0	8.500	9.300	0.000	1.350
PLASTERER	BLD	28.200	29.700	1.5	1.5	2.0	6.600	5.400	0.000	0.500
PLUMBER	BLD	37.000	40.700	1.5	1.5	2.0	8.500	9.300	0.000	1.350
ROOFER	BLD	23.900	24.900	1.5	1.5	2.0	8.650	3.800	0.000	0.000
SHEETMETAL WORKER	ALL	31.690	33.190	1.5	1.5	2.0	7.130	6.730	1.910	0.360
SPRINKLER FITTER	BLD	36.390	39.140	1.5	1.5	2.0	8.420	8.500	0.000	0.450
STONE MASON	BLD	28.620	30.120	1.5	1.5	2.0	8.200	7.030	0.000	0.430
TERRAZZO FINISHER	BLD	27.120	0.000	1.5	1.5	2.0	8.200	7.030	0.000	0.430
TERRAZZO MASON	BLD	28.620	30.120	1.5	1.5	2.0	8.200	7.030	0.000	0.430
TRUCK DRIVER	ALL 1	31.340	0.000	1.5	1.5	2.0	10.30	5.010	0.000	0.250
TRUCK DRIVER	ALL 2	31.780	0.000	1.5	1.5	2.0	10.30	5.010	0.000	0.250
TRUCK DRIVER	ALL 3	32.020	0.000	1.5	1.5	2.0	10.30	5.010	0.000	0.250
TRUCK DRIVER	ALL 4	32.280	0.000	1.5	1.5	2.0	10.30	5.010	0.000	0.250
TRUCK DRIVER	ALL 5	33.130	0.000	1.5	1.5	2.0	10.30	5.010	0.000	0.250
TRUCK DRIVER	O&C 1	25.070	0.000	1.5	1.5	2.0	10.30	5.010	0.000	0.250
TRUCK DRIVER	O&C 2	25.420	0.000	1.5	1.5	2.0	10.30	5.010	0.000	0.250
TRUCK DRIVER	O&C 3	25.620	0.000	1.5	1.5	2.0	10.30	5.010	0.000	0.250
TRUCK DRIVER	O&C 4	25.820	0.000	1.5	1.5	2.0	10.30	5.010	0.000	0.250
TRUCK DRIVER	O&C 5	26.500	0.000	1.5	1.5	2.0	10.30	5.010	0.000	0.250
TUCKPOINTER	BLD	28.620	30.120	1.5	1.5	2.0	8.200	7.030	0.000	0.430

Legend :

RG (Region)

TYP (Trade Type - All,Highway,Building,Floating,Oil & Chip,Rivers)

C (Class)

Base (Base Wage Rate)

FRMAN (Foreman Rate)

M-F>8 (OT required for any hour greater than 8 worked each day, Mon through Fri.)

OSA (Overtime (OT) is required for every hour worked on Saturday)

OSH (Overtime is required for every hour worked on Sunday and Holidays)

H/W (Health & Welfare Insurance)

Pensn (Pension)

Vac (Vacation)

Trng (Training)

Explanations

JEFFERSON COUNTY

The following list is considered as those days for which holiday rates of wages for work performed apply: New Years Day, Memorial Day, Fourth of July, Labor Day, Thanksgiving Day, Christmas Day and Veterans Day in some classifications/counties. Generally, any of these holidays which fall on a Sunday is celebrated on the following

Monday. This then makes work performed on that Monday payable at the appropriate overtime rate for holiday pay. Common practice in a given local may alter certain days of celebration. If in doubt, please check with IDOL.

Oil and chip resealing (O&C) means the application of road oils and liquid asphalt to coat an existing road surface, followed by application of aggregate chips or gravel to coated surface, and subsequent rolling of material to seal the surface.

EXPLANATION OF CLASSES

ASBESTOS - GENERAL - removal of asbestos material/mold and hazardous materials from any place in a building, including mechanical systems where those mechanical systems are to be removed. This includes the removal of asbestos materials/mold and hazardous materials from ductwork or pipes in a building when the building is to be demolished at the time or at some close future date.

ASBESTOS - MECHANICAL - removal of asbestos material from mechanical systems, such as pipes, ducts, and boilers, where the mechanical systems are to remain.

CERAMIC TILE FINISHER, MARBLE FINISHER, TERRAZZO FINISHER

Assisting, helping or supporting the tile, marble and terrazzo mechanic by performing their historic and traditional work assignments required to complete the proper installation of the work covered by said crafts. The term "Ceramic" is used for naming the classification only, and is in no a limitation of the product handled. Ceramic takes into consideration most hard tiles.

ELECTRIC POWER LINEMAN

Construction, maintenance and dismantling of overhead and underground electric power lines, including high voltage pipe type cable work, and associated structures and equipment.

ELECTRIC POWER EQUIPMENT OPERATOR - CLASS 1

Operation of all crawler type equipment D-4 and larger from the ground to assist the Electric Power Linemen in performing their duties.

ELECTRIC POWER EQUIPMENT OPERATORS - CLASS 2

Operation of all other equipment from the ground to assist the Electric Power Linemen in performing their duties.

ELECTRIC POWER GROUNDMAN

Applies to workers who assist the Electric Power Lineman from the ground.

ELECTRONIC SYSTEMS TECHNICIAN

Installation, service and maintenance of low-voltage systems which utilizes the transmission and/or transference of voice, sound, vision, or digital for commercial, education, security and entertainment purposes for the following: TV monitoring and surveillance, background/foreground music, intercom and telephone interconnect, field programming, inventory control systems, microwave transmission, multi-media, multiplex, radio page, school, intercom and sound burglar alarms and low voltage master clock systems.

Excluded from this classification are energy management systems, life

safety systems, supervisory controls and data acquisition systems not intrinsic with the above listed systems, fire alarm systems, nurse call systems and raceways exceeding fifteen feet in length.

OPERATING ENGINEER - BUILDING

GROUP I. Cranes, Dragline, Shovels, Skimmer Scoops, Clamshells or Derrick Boats, Pile Drivers, Crane-Type Backhoes, Asphalt Plant Operators, Concrete Plant Operators, Dredges, Asphalt Spreading Machines, All Locomotives, Cable Ways or Tower Machines, Hoists, Hydraulic Backhoes, Ditching Machines or Backfiller, Cherrypickers, Overhead Cranes, Roller - Steam or Gas, Concrete Pavers, Excavators, Concrete Breakers, Concrete Pumps, Bulk Cement Plants, Cement Pumps, Derrick-Type Drills, Boat Operators, Motor Graders or Pushcats, Scoops or Tournapulls, Bulldozers, Endloaders or Fork Lifts, Power Blade or Elevating Graders, Winch Cats, Boom or Winch Trucks or Boom Tractors, Pipe Wrapping or Painting Machines, Asphalt Plant Engineer, Journeyman Lubricating Engineer, Drills (other than Derrick Type), Mud Jacks, or Well Drilling Machines, Boring Machines or Track Jacks, Mixers, Conveyors (Two), Air Compressors (Two), Water Pumps regardless of size (Two), Welding Machines (Two), Siphons or Jets (Two), Winch Heads or Apparatuses (Two), Light Plants (Two), All Tractors regardless of size (straight tractor only), Fireman on Stationary Boilers, Automatic Elevators, Form Grading Machines, Finishing Machines, Power Sub-Grader or Ribbon Machines, Longitudinal Floats, Distributor Operators on Trucks, Winch Heads or Apparatuses (One), Mobil Track air and heaters (two to five), Heavy Equipment Greaser, Relief Operator, Assistant Master Mechanic and Heavy Duty Mechanic, self-propelled concrete saws of all types and sizes with their attachments, gob-hoppers, excavators all sizes, the repair and greasing of all diesel hammers, the operation and set-up of bidwells, water blasters of all sizes and their clutches, hydraulic jacks where used for hoisting, operation of log skidders, iceolators used on and off of pipeline, condor cranes, bow boats, survey boats, bobcats and all their attachments, skid steer loaders and all their attachments, creter cranes, batch plants, operator (all sizes), self propelled roto mills, operation of conveyor systems of any size and any configuration, operation, repair and service of all vibratory hammers, all power pacs and their controls regardless of location, curtains or brush burning machines, stump cutter machines, Nail launchers when mounted on a machine or self-propelled, operation of con-cover machines, and all Operators except those listed below).

GROUP II. Assistant Operators.

GROUP III. Air Compressors (One), Water Pumps, regardless of Size (One), Waterblasters (one), Welding Machine (One), Mixers (One Bag), Conveyor (One), Siphon or Jet (One), Light Plant (One), Heater (One), Immobile Track Air (One), and Self Propelled Walk-Behind Rollers.

GROUP IV. Asphalt Spreader Oilers, Fireman on Whirlies and Heavy Equipment Oilers, Truck Cranes, Dredges, Monigans, Large Cranes - (Over 65-ton rated capacity) Concrete Plant Oiler, Blacktop Plant Oiler, and Creter Crane Oiler (when required).

GROUP V. Oiler.

GROUP VI. Operators on equipment with Booms, including jibs, 100 feet and over, and less than 150 feet long.

GROUP VII. Operators on equipment with Booms, including jibs, 150 feet and over, and less than 200 feet long.

GROUP VIII. Operators on Equipment with Booms, including jibs, 200 feet and over; Tower Cranes; and Whirlie Cranes.

GROUP IX. Master Mechanic

OPERATING ENGINEERS - Highway

GROUP I. Cranes, Dragline, Shovels, Skimmer Scoops, Clamshells or Derrick Boats, Pile Drivers, Crane-Type Backhoes, Asphalt Plant Operators, Concrete Plant Operators, Dredges, Asphalt Spreading Machines, All Locomotives, Cable Ways or Tower Machines, Hoists, Hydraulic Backhoes, Ditching Machines or Backfiller, Cherrypickers, Overhead Cranes, Roller - Steam or Gas, Concrete Pavers, Excavators, Concrete Breakers, Concrete Pumps, Bulk Cement Plants, Cement Pumps, Derrick-Type Drills, Boat Operators, Motor Graders or Pushcats, Scoops or Tournapulls, Bulldozers, Endloaders or Fork Lifts, Power Blade or Elevating Graders, Winch Cats, Boom or Winch Trucks or Boom Tractors, Pipe Wrapping or Painting Machines, Asphalt Plant Engineer, Journeyman Lubricating Engineer, Drills (other than Derrick Type), Mud Jacks, Well Drilling Machines, Boring Machines, Track Jacks, Mixers, Conveyors (Two), Air Compressors (Two), Water Pumps regardless of size (Two), Welding Machines (Two), Siphons or Jets (Two), Winch Heads or Apparatuses (Two), Light Plants (Two), All Tractors regardless of size (straight tractor only), Fireman on Stationary Boilers, Automatic Elevators, Form Grading Machines, Finishing Machines, Power Sub-Grader or Ribbon Machines, Longitudinal Floats, Distributor Operators on Trucks, Winch Heads or Apparatuses (One), Mobil Track air and heaters (two to five), Heavy Equipment Greaser, Relief Operator, Assistant Master Mechanic and Heavy Duty Mechanic, self-propelled concrete saws of all types and sizes with their attachments, gob-hoppers, excavators all sizes, the repair and greasing of all diesel hammers, the operation and set-up of bidwells, water blasters of all sizes and their clutches, hydraulic jacks where used for hoisting, operation of log skidders, iceolators used on and off of pipeline, condor cranes, bow boats, survey boats, bobcats and all their attachments, skid steer loaders and all their attachments, creter cranes, batch plants, operator (all sizes), self propelled roto mills, operation of conveyor systems of any size and any configuration, operation, repair and service of all vibratory hammers, all power pacs and their controls regardless of location, curtains or brush burning machines, stump cutter machines, Nail launchers when mounted on a machine or self-propelled, operation of con-cover machines, and all Operators (except those listed below).

GROUP II. Assistant Operators.

GROUP III. Air Compressors (One), Water Pumps, regardless of Size (One), Waterblasters (one), Welding Machine (One), Mixers (One Bag), Conveyor (One), Siphon or Jet (One), Light Plant (One), Heater (One), Immobile Track Air (One), and Self Propelled Walk-Behind Rollers.

GROUP IV. Asphalt Spreader Oilers, Fireman on Whirlies and Heavy Equipment Oilers, Truck Cranes, Dredges, Monigans, Large Cranes - (Over 65-ton rated capacity) Concrete Plant Oiler, Blacktop Plant Oiler, and Creter Crane Oiler (when required).

GROUP V. Oiler.

GROUP VI. Operators on equipment with Booms, including jibs, 100 feet and over, and less than 150 feet long.

GROUP VII. Operators on equipment with Booms, including jibs, 150 feet and over, and less than 200 feet long.

GROUP VIII. Operators on Equipment with Booms, including jibs, 200 feet and over; Tower Cranes; and Whirlie Cranes.

GROUP IX. Mechanic

TRUCK DRIVER - BUILDING, HEAVY AND HIGHWAY CONSTRUCTION

Class 1. Drivers on 2 axle trucks hauling less than 9 ton. Air compressor and welding machines and brooms, including those pulled by separate units, truck driver helpers, warehouse employees, mechanic helpers, greasers and tiremen, pickup trucks when hauling materials, tools, or workers to and from and on-the-job site, and fork lifts up to 6,000 lb. capacity.

Class 2. Two or three axle trucks hauling more than 9 ton but hauling less than 16 ton. A-frame winch trucks, hydrolift trucks, vactor trucks or similar equipment when used for transportation purposes. Fork lifts over 6,000 lb. capacity, winch trucks, four axle combination units, and ticket writers.

Class 3. Two, three or four axle trucks hauling 16 ton or more. Drivers on water pulls, articulated dump trucks, mechanics and working forepersons, and dispatchers. Five axle or more combination units.

Class 4. Low Boy and Oil Distributors.

Class 5. Drivers who require special protective clothing while employed on hazardous waste work.

TRUCK DRIVER - OIL AND CHIP RESEALING ONLY.

This shall encompass laborers, workers and mechanics who drive contractor or subcontractor owned, leased, or hired pickup, dump, service, or oil distributor trucks. The work includes transporting materials and equipment (including but not limited to, oils, aggregate supplies, parts, machinery and tools) to or from the job site; distributing oil or liquid asphalt and aggregate; stock piling material when in connection with the actual oil and chip contract. The Truck Driver (Oil & Chip Resealing) wage classification does not include supplier delivered materials.

Other Classifications of Work:

For definitions of classifications not otherwise set out, the Department generally has on file such definitions which are available. If a task to be performed is not subject to one of the classification of pay set out, the Department will upon being contacted state which neighboring county has such a classification and provide such rate, such rate being deemed to exist by reference in this document. If no neighboring county rate applies to the task, the Department shall undertake a special determination, such special determination being then deemed to have existed under this determination. If a project requires these, or any classification not listed, please contact IDOL at 217-782-1710 for wage rates or clarifications.

LANDSCAPING

Landscaping work falls under the existing classifications for laborer, operating engineer and truck driver. The work performed by landscape plantsman and landscape laborer is covered by the existing classification of laborer. The work performed by landscape operators (regardless of equipment used or its size) is covered by the classifications of operating engineer. The work performed by landscape truck drivers (regardless of size of truck driven) is covered by the classifications of truck driver.

Jersey County Prevailing Wage for May 2013

(See explanation of column headings at bottom of wages)

Trade Name	RG	TYP	C	Base	FRMAN	M-F>8	OSA	OSH	H/W	Pensn	Vac	Trng
=====	==	===	=	=====	=====	=====	===	===	=====	=====	=====	=====
ASBESTOS ABT-GEN		ALL		30.860	31.360	1.5	1.5	2.0	5.750	9.840	0.000	0.800
ASBESTOS ABT-MEC		BLD		29.860	30.860	1.5	1.5	2.0	6.950	3.000	0.000	0.000
BOILERMAKER		BLD		31.500	34.000	1.5	1.5	2.0	7.070	18.73	1.000	0.350
BRICK MASON		BLD		29.280	33.160	1.5	1.5	2.0	7.750	9.430	2.000	0.400
CARPENTER		ALL		34.630	36.130	1.5	1.5	2.0	6.550	6.750	0.000	0.400
CEMENT MASON		ALL		31.000	32.000	1.5	1.5	2.0	9.250	11.75	0.000	0.200
CERAMIC TILE FNSHER		BLD		25.890	0.000	1.5	1.5	2.0	6.000	5.200	0.000	0.530
ELECTRIC PWR EQMT OP		ALL		36.690	44.520	1.5	2.0	2.0	5.000	9.170	0.000	0.280
ELECTRIC PWR GRNDMAN		ALL		24.940	44.520	1.5	2.0	2.0	5.000	6.240	0.000	0.190
ELECTRIC PWR LINEMAN		ALL		42.210	44.520	1.5	2.0	2.0	5.000	10.56	0.000	0.320
ELECTRIC PWR TRK DRV		ALL		25.560	44.520	1.5	2.0	2.0	5.000	6.390	0.000	0.190
ELECTRICIAN		ALL		36.400	38.650	1.5	1.5	2.0	7.500	9.090	0.000	0.550
ELECTRONIC SYS TECH		BLD		28.740	30.490	1.5	1.5	2.0	7.500	5.860	0.000	0.400
ELEVATOR CONSTRUCTOR		BLD		43.715	49.180	2.0	2.0	2.0	11.88	12.71	3.500	0.600
FLOOR LAYER		BLD		29.330	30.080	1.5	1.5	2.0	6.550	6.750	0.000	0.400
GLAZIER		BLD		32.780	0.000	2.0	2.0	2.0	9.020	10.80	2.630	0.310
HT/FROST INSULATOR		BLD		37.260	38.260	1.5	1.5	2.0	7.850	11.16	0.000	0.500
IRON WORKER		ALL		31.500	33.500	1.5	1.5	2.0	7.610	13.33	0.000	0.420
LABORER		ALL		30.360	30.860	1.5	1.5	2.0	5.750	9.840	0.000	0.800
MACHINIST		BLD		43.550	46.050	1.5	1.5	2.0	6.130	8.950	1.850	0.000
MARBLE FINISHERS		BLD		25.890	0.000	1.5	1.5	2.0	6.000	5.200	0.000	0.530
MILLWRIGHT		ALL		34.630	36.130	1.5	1.5	2.0	6.550	6.750	0.000	0.400
OPERATING ENGINEER		BLD 1		34.200	37.200	1.5	1.5	2.0	9.000	17.00	0.000	1.000
OPERATING ENGINEER		BLD 2		33.070	37.200	1.5	1.5	2.0	9.000	17.00	0.000	1.000
OPERATING ENGINEER		BLD 3		28.590	37.200	1.5	1.5	2.0	9.000	17.00	0.000	1.000
OPERATING ENGINEER		BLD 4		28.650	37.200	1.5	1.5	2.0	9.000	17.00	0.000	1.000
OPERATING ENGINEER		BLD 5		28.320	37.200	1.5	1.5	2.0	9.000	17.00	0.000	1.000
OPERATING ENGINEER		BLD 6		35.750	37.200	1.5	1.5	2.0	9.000	17.00	0.000	1.000
OPERATING ENGINEER		BLD 7		36.050	37.200	1.5	1.5	2.0	9.000	17.00	0.000	1.000
OPERATING ENGINEER		BLD 8		36.330	37.200	1.5	1.5	2.0	9.000	17.00	0.000	1.000
OPERATING ENGINEER		BLD 9		35.650	37.200	1.5	1.5	2.0	9.000	17.00	0.000	1.000
OPERATING ENGINEER		HWY 1		32.700	35.700	1.5	1.5	2.0	9.000	17.00	0.000	1.000
OPERATING ENGINEER		HWY 2		31.570	35.700	1.5	1.5	2.0	9.000	17.00	0.000	1.000
OPERATING ENGINEER		HWY 3		27.090	35.700	1.5	1.5	2.0	9.000	17.00	0.000	1.000
OPERATING ENGINEER		HWY 4		27.150	35.700	1.5	1.5	2.0	9.000	17.00	0.000	1.000
OPERATING ENGINEER		HWY 5		26.820	35.700	1.5	1.5	2.0	9.000	17.00	0.000	1.000
OPERATING ENGINEER		HWY 6		34.250	35.700	1.5	1.5	2.0	9.000	17.00	0.000	1.000
OPERATING ENGINEER		HWY 7		34.550	35.700	1.5	1.5	2.0	9.000	17.00	0.000	1.000
OPERATING ENGINEER		HWY 8		34.830	35.700	1.5	1.5	2.0	9.000	17.00	0.000	1.000
OPERATING ENGINEER		HWY 9		34.150	35.700	1.5	1.5	2.0	9.000	17.00	0.000	1.000
PAINTER		BLD		29.250	30.750	1.5	1.5	2.0	5.000	7.920	0.000	0.600
PAINTER		HWY		30.450	31.950	1.5	1.5	2.0	5.000	7.920	0.000	0.600
PAINTER OVER 30FT		BLD		30.250	31.750	1.5	1.5	2.0	5.000	7.920	0.000	0.600
PAINTER PWR EQMT		BLD		30.250	31.750	1.5	1.5	2.0	5.000	7.920	0.000	0.600
PAINTER PWR EQMT		HWY		31.450	32.950	1.5	1.5	2.0	5.000	7.920	0.000	0.600
PILEDRIVER		ALL		34.630	36.130	1.5	1.5	2.0	6.550	6.750	0.000	0.400
PIPEFITTER		BLD		37.800	39.690	2.0	2.0	2.0	4.500	8.360	0.000	0.300
PLASTERER		BLD		30.250	31.250	1.5	1.5	2.0	9.250	8.600	0.000	0.050
PLUMBER		BLD		37.800	39.690	2.0	2.0	2.0	4.500	8.360	0.000	0.300
ROOFER		BLD		29.500	31.500	1.5	1.5	2.0	8.600	6.850	0.000	0.200
SHEETMETAL WORKER		ALL		31.690	33.190	1.5	1.5	2.0	7.130	6.730	1.910	0.360
SPRINKLER FITTER		BLD		38.780	41.780	2.0	2.0	2.0	8.370	11.18	0.000	1.000
TERRAZZO FINISHER		BLD		31.240	0.000	1.5	1.5	2.0	6.000	3.230	0.000	0.200
TERRAZZO MASON		BLD		32.530	32.830	1.5	1.5	2.0	6.000	5.230	0.000	0.210
TRUCK DRIVER		ALL 1		31.340	0.000	1.5	1.5	2.0	10.30	5.010	0.000	0.250
TRUCK DRIVER		ALL 2		31.780	0.000	1.5	1.5	2.0	10.30	5.010	0.000	0.250
TRUCK DRIVER		ALL 3		32.020	0.000	1.5	1.5	2.0	10.30	5.010	0.000	0.250
TRUCK DRIVER		ALL 4		32.280	0.000	1.5	1.5	2.0	10.30	5.010	0.000	0.250
TRUCK DRIVER		ALL 5		33.130	0.000	1.5	1.5	2.0	10.30	5.010	0.000	0.250

TRUCK DRIVER	O&C 1	25.070	0.000	1.5	1.5	2.0	10.30	5.010	0.000	0.250
TRUCK DRIVER	O&C 2	25.420	0.000	1.5	1.5	2.0	10.30	5.010	0.000	0.250
TRUCK DRIVER	O&C 3	25.620	0.000	1.5	1.5	2.0	10.30	5.010	0.000	0.250
TRUCK DRIVER	O&C 4	25.820	0.000	1.5	1.5	2.0	10.30	5.010	0.000	0.250
TRUCK DRIVER	O&C 5	26.500	0.000	1.5	1.5	2.0	10.30	5.010	0.000	0.250

Legend:

RG (Region)

TYP (Trade Type - All,Highway,Building,Floating,Oil & Chip,Rivers)

C (Class)

Base (Base Wage Rate)

FRMAN (Foreman Rate)

M-F>8 (OT required for any hour greater than 8 worked each day, Mon through Fri.

OSA (Overtime (OT) is required for every hour worked on Saturday)

OSH (Overtime is required for every hour worked on Sunday and Holidays)

H/W (Health & Welfare Insurance)

Pensn (Pension)

Vac (Vacation)

Trng (Training)

Explanations

JERSEY COUNTY

The following list is considered as those days for which holiday rates of wages for work performed apply: New Years Day, Memorial Day, Fourth of July, Labor Day, Thanksgiving Day, Christmas Day and Veterans Day in some classifications/counties. Generally, any of these holidays which fall on a Sunday is celebrated on the following Monday. This then makes work performed on that Monday payable at the appropriate overtime rate for holiday pay. Common practice in a given local may alter certain days of celebration. If in doubt, please check with IDOL.

Oil and chip resealing (O&C) means the application of road oils and liquid asphalt to coat an existing road surface, followed by application of aggregate chips or gravel to coated surface, and subsequent rolling of material to seal the surface.

EXPLANATION OF CLASSES

ASBESTOS - GENERAL - removal of asbestos material/mold and hazardous materials from any place in a building, including mechanical systems where those mechanical systems are to be removed. This includes the removal of asbestos materials/mold and hazardous materials from ductwork or pipes in a building when the building is to be demolished at the time or at some close future date.

ASBESTOS - MECHANICAL - removal of asbestos material from mechanical systems, such as pipes, ducts, and boilers, where the mechanical

systems are to remain.

CERAMIC TILE FINISHER AND MARBLE FINISHER

The handling, at the building site, of all sand, cement, tile, marble or stone and all other materials that may be used and installed by [a] tile layer or marble mason. In addition, the grouting, cleaning, sealing, and mixing on the job site, and all other work as required in assisting the setter. The term "Ceramic" is used for naming the classification only and is in no way a limitation of the product handled. Ceramic takes into consideration most hard tiles.

ELECTRONIC SYSTEMS TECHNICIAN

Installation, service and maintenance of low-voltage systems which utilizes the transmission and/or transference of voice, sound, vision, or digital for commercial, education, security and entertainment purposes for the following: TV monitoring and surveillance, background/foreground music, intercom and telephone interconnect, field programming, inventory control systems, microwave transmission, multi-media, multiplex, radio page, school, intercom and sound burglar alarms and low voltage master clock systems.

Excluded from this classification are energy management systems, life safety systems, supervisory controls and data acquisition systems not intrinsic with the above listed systems, fire alarm systems, nurse call systems and raceways exceeding fifteen feet in length.

OPERATING ENGINEER - BUILDING

GROUP I. Cranes, Dragline, Shovels, Skimmer Scoops, Clamshells or Derrick Boats, Pile Drivers, Crane-Type Backhoes, Asphalt Plant Operators, Concrete Plant Operators, Dredges, Asphalt Spreading Machines, All Locomotives, Cable Ways or Tower Machines, Hoists, Hydraulic Backhoes, Ditching Machines or Backfiller, Cherrypickers, Overhead Cranes, Roller - Steam or Gas, Concrete Pavers, Excavators, Concrete Breakers, Concrete Pumps, Bulk Cement Plants, Cement Pumps, Derrick-Type Drills, Boat Operators, Motor Graders or Pushcats, Scoops or Tournapulls, Bulldozers, Endloaders or Fork Lifts, Power Blade or Elevating Graders, Winch Cats, Boom or Winch Trucks or Boom Tractors, Pipe Wrapping or Painting Machines, Asphalt Plant Engineer, Journeyman Lubricating Engineer, Drills (other than Derrick Type), Mud Jacks, or Well Drilling Machines, Boring Machines or Track Jacks, Mixers, Conveyors (Two), Air Compressors (Two), Water Pumps regardless of size (Two), Welding Machines (Two), Siphons or Jets (Two), Winch Heads or Apparatuses (Two), Light Plants (Two), All Tractors regardless of size (straight tractor only), Fireman on Stationary Boilers, Automatic Elevators, Form Grading Machines, Finishing Machines, Power Sub-Grader or Ribbon Machines, Longitudinal Floats, Distributor Operators on Trucks, Winch Heads or Apparatuses (One), Mobil Track air and heaters (two to five), Heavy Equipment Greaser, Relief Operator, Assistant Master Mechanic and Heavy Duty Mechanic, self-propelled concrete saws of all types and sizes with their attachments, gob-hoppers, excavators all sizes, the repair and greasing of all diesel hammers, the operation and set-up of bidwells, water blasters of all sizes and their clutches, hydraulic jacks where used for hoisting, operation of log skidders, iceolators used on and off of pipeline, condor cranes, bow boats, survey boats, bobcats and all their attachments, skid steer loaders and all their attachments, creter cranes, batch plants, operator (all sizes), self propelled roto mills, operation of conveyor systems of any size and any configuration, operation, repair and service of all vibratory hammers, all power pacs and their controls regardless of location, curtains or brush burning machines, stump cutter machines, Nail launchers when mounted on a machine or self-propelled, operation of con-cover machines, and all Operators

except those listed below).

GROUP II. Assistant Operators.

GROUP III. Air Compressors (One), Water Pumps, regardless of Size (One), Waterblasters (one), Welding Machine (One), Mixers (One Bag), Conveyor (One), Siphon or Jet (One), Light Plant (One), Heater (One), Immobile Track Air (One), and Self Propelled Walk-Behind Rollers.

GROUP IV. Asphalt Spreader Oilers, Fireman on Whirlies and Heavy Equipment Oilers, Truck Cranes, Dredges, Monigans, Large Cranes - (Over 65-ton rated capacity) Concrete Plant Oiler, Blacktop Plant Oiler, and Creter Crane Oiler (when required).

GROUP V. Oiler.

GROUP VI. Operators on equipment with Booms, including jibs, 100 feet and over, and less than 150 feet long.

GROUP VII. Operators on equipment with Booms, including jibs, 150 feet and over, and less than 200 feet long.

GROUP VIII. Operators on Equipment with Booms, including jibs, 200 feet and over; Tower Cranes; and Whirlie Cranes.

GROUP IX. Master Mechanic

OPERATING ENGINEERS - Highway

GROUP I. Cranes, Dragline, Shovels, Skimmer Scoops, Clamshells or Derrick Boats, Pile Drivers, Crane-Type Backhoes, Asphalt Plant Operators, Concrete Plant Operators, Dredges, Asphalt Spreading Machines, All Locomotives, Cable Ways or Tower Machines, Hoists, Hydraulic Backhoes, Ditching Machines or Backfiller, Cherrypickers, Overhead Cranes, Roller - Steam or Gas, Concrete Pavers, Excavators, Concrete Breakers, Concrete Pumps, Bulk Cement Plants, Cement Pumps, Derrick-Type Drills, Boat Operators, Motor Graders or Pushcats, Scoops or Tournapulls, Bulldozers, Endloaders or Fork Lifts, Power Blade or Elevating Graders, Winch Cats, Boom or Winch Trucks or Boom Tractors, Pipe Wrapping or Painting Machines, Asphalt Plant Engineer, Journeyman Lubricating Engineer, Drills (other than Derrick Type), Mud Jacks, Well Drilling Machines, Boring Machines, Track Jacks, Mixers, Conveyors (Two), Air Compressors (Two), Water Pumps regardless of size (Two), Welding Machines (Two), Siphons or Jets (Two), Winch Heads or Apparatuses (Two), Light Plants (Two), All Tractors regardless of size (straight tractor only), Fireman on Stationary Boilers, Automatic Elevators, Form Grading Machines, Finishing Machines, Power Sub-Grader or Ribbon Machines, Longitudinal Floats, Distributor Operators on Trucks, Winch Heads or Apparatuses (One), Mobil Track air and heaters (two to five), Heavy Equipment Greaser, Relief Operator, Assistant Master Mechanic and Heavy Duty Mechanic, self-propelled concrete saws of all types and sizes with their attachments, gob-hoppers, excavators all sizes, the repair and greasing of all diesel hammers, the operation and set-up of bidwells, water blasters of all sizes and their clutches, hydraulic jacks where used for hoisting, operation of log skidders, iceolators used on and off of pipeline, condor cranes, bow boats, survey boats, bobcats and all their attachments, skid steer loaders and all their attachments, creter cranes, batch plants, operator (all sizes), self propelled roto mills, operation of conveyor systems of any size and any configuration, operation, repair and service of all vibratory hammers, all power pacs and their controls regardless of location, curtains or brush burning machines, stump cutter machines, Nail launchers when mounted on a machine or self-propelled, operation of con-cover machines, and all Operators (except those listed below).

GROUP II. Assistant Operators.

GROUP III. Air Compressors (One), Water Pumps, regardless of Size (One), Waterblasters (one), Welding Machine (One), Mixers (One Bag), Conveyor (One), Siphon or Jet (One), Light Plant (One), Heater (One), Immobile Track Air (One), and Self Propelled Walk-Behind Rollers.

GROUP IV. Asphalt Spreader Oilers, Fireman on Whirlies and Heavy Equipment Oilers, Truck Cranes, Dredges, Monigans, Large Cranes - (Over 65-ton rated capacity) Concrete Plant Oiler, Blacktop Plant Oiler, and Creter Crane Oiler (when required).

GROUP V. Oiler.

GROUP VI. Operators on equipment with Booms, including jibs, 100 feet and over, and less than 150 feet long.

GROUP VII. Operators on equipment with Booms, including jibs, 150 feet and over, and less than 200 feet long.

GROUP VIII. Operators on Equipment with Booms, including jibs, 200 feet and over; Tower Cranes; and Whirlie Cranes.

GROUP IX. Mechanic

TRUCK DRIVER - BUILDING, HEAVY AND HIGHWAY CONSTRUCTION

Class 1. Drivers on 2 axle trucks hauling less than 9 ton. Air compressor and welding machines and brooms, including those pulled by separate units, truck driver helpers, warehouse employees, mechanic helpers, greasers and tiremen, pickup trucks when hauling materials, tools, or workers to and from and on-the-job site, and fork lifts up to 6,000 lb. capacity.

Class 2. Two or three axle trucks hauling more than 9 ton but hauling less than 16 ton. A-frame winch trucks, hydrolift trucks, vector trucks or similar equipment when used for transportation purposes. Fork lifts over 6,000 lb. capacity, winch trucks, four axle combination units, and ticket writers.

Class 3. Two, three or four axle trucks hauling 16 ton or more. Drivers on water pulls, articulated dump trucks, mechanics and working forepersons, and dispatchers. Five axle or more combination units.

Class 4. Low Boy and Oil Distributors.

Class 5. Drivers who require special protective clothing while employed on hazardous waste work.

TRUCK DRIVER - OIL AND CHIP RESEALING ONLY.

This shall encompass laborers, workers and mechanics who drive contractor or subcontractor owned, leased, or hired pickup, dump, service, or oil distributor trucks. The work includes transporting materials and equipment (including but not limited to, oils, aggregate supplies, parts, machinery and tools) to or from the job site; distributing oil or liquid asphalt and aggregate; stock piling material when in connection with the actual oil and chip contract. The Truck Driver (Oil & Chip Resealing) wage classification does not include supplier delivered materials.

TERRAZZO FINISHER

The handling of all materials used for Mosaic and Terrazzo work including preparing, mixing by hand, by mixing machine or transporting of pre-mixed materials and distributing with shovel, rake, hoe, or pail, all kinds of concrete foundations necessary for Mosaic and Terrazzo work, all cement terrazzo, magnesite terrazzo, Do-O-Text terrazzo, epoxy matrix terrazzo, exposed aggregate, rustic or rough washed for exterior or interior of buildings placed either by machine or by hand, and any other kind of mixture of plastics composed of chips or granules when mixed with cement, rubber, neoprene, vinyl, magnesium chloride or any other resinous or chemical substances used for seamless flooring systems, and all other building materials, all similar materials and all precast terrazzo work on jobs, all scratch coat used for Mosaic and Terrazzo work and sub-bed, tar paper and wire mesh (2x2 etc.) or lath. The rubbing, grinding, cleaning and finishing of same either by hand or by machine or by terrazzo resurfacing equipment on new or existing floors. When necessary finishers shall be allowed to assist the mechanics to spread sand bed, lay tarpaper and wire mesh (2x2 etc.) or lath. The finishing of cement floors where additional aggregate of stone is added by spreading or sprinkling on top of the finished base, and troweled or rolled into the finish and then the surface is ground by grinding machines.

Other Classifications of Work:

For definitions of classifications not otherwise set out, the Department generally has on file such definitions which are available. If a task to be performed is not subject to one of the classifications of pay set out, the Department will upon being contacted state which neighboring county has such a classification and provide such rate, such rate being deemed to exist by reference in this document. If no neighboring county rate applies to the task, the Department shall undertake a special determination, such special determination being then deemed to have existed under this determination. If a project requires these, or any classification not listed, please contact IDOL at 217-782-1710 for wage rates or clarifications.

LANDSCAPING

Landscaping work falls under the existing classifications for laborer, operating engineer and truck driver. The work performed by landscape plantsman and landscape laborer is covered by the existing classification of laborer. The work performed by landscape operators (regardless of equipment used or its size) is covered by the classifications of operating engineer. The work performed by landscape truck drivers (regardless of size of truck driven) is covered by the classifications of truck driver.

Jo Daviess County Prevailing Wage for May 2013

(See explanation of column headings at bottom of wages)

Trade Name	RG	TYP	C	Base	FRMAN	M-F>8	OSA	OSH	H/W	Pensn	Vac	Trng
=====	==	===	=	=====	=====	=====	===	===	=====	=====	=====	=====
ASBESTOS ABT-GEN		BLD		29.550	30.550	1.5	1.5	2.0	8.240	12.42	0.000	0.800
ASBESTOS ABT-MEC		BLD		20.500	21.500	1.5	1.5	2.0	6.250	3.500	0.000	0.000
BOILERMAKER		BLD		35.010	38.010	2.0	2.0	2.0	7.070	13.83	0.000	0.300
BRICK MASON		BLD		35.880	38.630	1.5	1.5	2.0	7.950	11.73	0.000	0.600
CARPENTER		BLD		27.040	29.040	1.5	1.5	2.0	7.140	9.490	0.000	0.360
CARPENTER		HWY		33.790	35.540	1.5	1.5	2.0	9.750	12.99	0.000	0.490
CEMENT MASON		ALL		32.520	35.270	1.5	1.5	2.0	7.700	13.98	0.000	0.500

CERAMIC TILE FNSHER		BLD	32.410	0.000	1.5	1.5	2.0	7.700	4.840	0.000	0.530
COMMUNICATION TECH		BLD	36.000	39.600	1.5	1.5	2.0	10.14	11.20	0.000	0.720
ELECTRIC PWR EQMT OP		ALL	36.610	49.750	1.5	1.5	2.0	5.000	11.35	0.000	0.270
ELECTRIC PWR GRNDMAN		ALL	28.310	49.750	1.5	1.5	2.0	5.000	8.780	0.000	0.210
ELECTRIC PWR LINEMAN		ALL	43.830	49.750	1.5	1.5	2.0	5.000	13.58	0.000	0.330
ELECTRIC PWR TRK DRV		ALL	29.310	49.750	1.5	1.5	2.0	5.000	9.090	0.000	0.220
ELECTRICIAN	E	BLD	40.000	44.000	1.5	1.5	2.0	10.14	16.93	0.000	0.800
ELECTRICIAN	W	BLD	29.000	30.450	1.5	1.5	2.0	6.000	7.070	0.000	0.290
ELEVATOR CONSTRUCTOR		BLD	45.350	51.020	2.0	2.0	2.0	11.88	12.71	3.630	0.600
GLAZIER		BLD	22.020	23.520	1.5	1.5	2.0	6.940	6.520	0.000	0.350
HT/FROST INSULATOR		BLD	29.190	30.390	1.5	1.5	2.0	5.420	12.05	0.000	0.900
IRON WORKER	E	ALL	35.090	36.840	2.0	2.0	2.0	8.250	20.59	0.000	0.700
IRON WORKER	W	ALL	28.000	30.240	1.5	1.5	2.0	9.390	10.68	0.000	0.620
LABORER		BLD	29.550	30.550	1.5	1.5	2.0	8.240	12.42	0.000	0.800
LABORER		HWY	32.100	32.850	1.5	1.5	2.0	8.240	12.42	0.000	0.800
LABORER, SKILLED		HWY	34.400	35.150	1.5	1.5	2.0	8.240	12.42	0.000	0.800
LATHER		BLD	27.040	29.040	1.5	1.5	2.0	7.140	9.490	0.000	0.360
MACHINIST		BLD	43.550	46.050	1.5	1.5	2.0	6.130	8.950	1.850	0.000
MARBLE FINISHERS		BLD	32.410	0.000	1.5	1.5	2.0	7.700	4.840	0.000	0.530
MARBLE MASON		BLD	35.090	35.340	1.5	1.5	2.0	7.700	7.150	0.000	0.560
MILLWRIGHT		BLD	35.000	38.500	1.5	1.5	2.0	7.700	13.87	0.000	0.500
OPERATING ENGINEER		BLD 1	40.800	44.850	2.0	2.0	2.0	15.85	9.800	2.350	1.300
OPERATING ENGINEER		BLD 2	40.100	44.850	2.0	2.0	2.0	15.85	9.800	2.350	1.300
OPERATING ENGINEER		BLD 3	37.650	44.850	2.0	2.0	2.0	15.85	9.800	2.350	1.300
OPERATING ENGINEER		BLD 4	35.650	44.850	2.0	2.0	2.0	15.85	9.800	2.350	1.300
OPERATING ENGINEER		BLD 5	44.600	44.850	2.0	2.0	2.0	15.85	9.800	2.350	1.300
OPERATING ENGINEER		BLD 6	43.350	44.850	2.0	2.0	2.0	15.85	9.800	2.350	1.300
OPERATING ENGINEER		BLD 7	40.350	44.850	2.0	2.0	2.0	15.85	9.800	2.350	1.300
OPERATING ENGINEER		HWY 1	40.650	44.700	1.5	1.5	2.0	15.85	9.800	2.350	1.300
OPERATING ENGINEER		HWY 2	40.100	44.700	1.5	1.5	2.0	15.85	9.800	2.350	1.300
OPERATING ENGINEER		HWY 3	38.800	44.700	1.5	1.5	2.0	15.85	9.800	2.350	1.300
OPERATING ENGINEER		HWY 4	37.350	44.700	1.5	1.5	2.0	15.85	9.800	2.350	1.300
OPERATING ENGINEER		HWY 5	35.900	44.700	1.5	1.5	2.0	15.85	9.800	2.350	1.300
OPERATING ENGINEER		HWY 6	43.700	44.700	1.5	1.5	2.0	15.85	9.800	2.350	1.300
OPERATING ENGINEER		HWY 7	41.700	44.700	1.5	1.5	2.0	15.85	9.800	2.350	1.300
PAINTER		ALL	35.700	37.700	1.5	1.5	1.5	9.650	8.460	0.000	1.250
PILEDRIVER		BLD	29.040	31.040	1.5	1.5	2.0	7.140	9.490	0.000	0.360
PILEDRIVER		HWY	33.790	35.540	1.5	1.5	2.0	9.750	12.99	0.000	0.490
PIPEFITTER		BLD	40.600	43.440	1.5	1.5	2.0	7.980	10.79	0.000	1.000
PLASTERER		BLD	33.360	36.700	2.0	2.0	2.0	8.150	11.05	0.000	0.500
PLUMBER		BLD	40.600	43.440	1.5	1.5	2.0	7.980	10.79	0.000	1.000
ROOFER		BLD	38.350	41.350	1.5	1.5	2.0	8.280	8.770	0.000	0.430
SHEETMETAL WORKER		BLD	35.780	37.710	1.5	1.5	2.0	5.450	15.44	0.520	0.290
SPRINKLER FITTER		BLD	36.390	39.140	1.5	1.5	2.0	8.420	8.500	0.000	0.450
STONE MASON		BLD	35.880	38.630	1.5	1.5	2.0	7.950	11.73	0.000	0.600
TERRAZZO FINISHER		BLD	32.410	0.000	1.5	1.5	2.0	7.700	4.840	0.000	0.530
TERRAZZO MASON		BLD	35.090	35.340	1.5	1.5	2.0	7.700	7.150	0.000	0.560
TILE LAYER		BLD	27.040	29.040	1.5	1.5	2.0	7.140	9.490	0.000	0.360
TILE MASON		BLD	35.090	35.340	1.5	1.5	2.0	7.700	7.150	0.000	0.560
TRUCK DRIVER		O&C 1	24.980	0.000	1.5	1.5	2.0	10.30	4.840	0.000	0.250
TRUCK DRIVER		O&C 2	25.340	0.000	1.5	1.5	2.0	10.30	4.840	0.000	0.250
TRUCK DRIVER		O&C 3	25.510	0.000	1.5	1.5	2.0	10.30	4.840	0.000	0.250
TRUCK DRIVER		O&C 4	25.740	0.000	1.5	1.5	2.0	10.30	4.840	0.000	0.250
TRUCK DRIVER		O&C 5	26.420	0.000	1.5	1.5	2.0	10.30	4.840	0.000	0.250
TRUCK DRIVER	E	ALL 1	32.960	33.420	1.5	1.5	2.0	6.900	8.220	0.000	0.000
TRUCK DRIVER	E	ALL 2	33.110	33.420	1.5	1.5	2.0	6.900	8.220	0.000	0.000
TRUCK DRIVER	E	ALL 3	33.310	33.420	1.5	1.5	2.0	6.900	8.220	0.000	0.000
TRUCK DRIVER	E	ALL 4	33.420	33.420	1.5	1.5	2.0	6.900	8.220	0.000	0.000
TRUCK DRIVER	W	ALL 1	31.230	0.000	1.5	1.5	2.0	10.30	4.840	0.000	0.250
TRUCK DRIVER	W	ALL 2	31.680	0.000	1.5	1.5	2.0	10.30	4.840	0.000	0.250
TRUCK DRIVER	W	ALL 3	31.890	0.000	1.5	1.5	2.0	10.30	4.840	0.000	0.250
TRUCK DRIVER	W	ALL 4	32.180	0.000	1.5	1.5	2.0	10.30	4.840	0.000	0.250
TRUCK DRIVER	W	ALL 5	33.020	0.000	1.5	1.5	2.0	10.30	4.840	0.000	0.250
TUCKPOINTER		BLD	35.880	38.630	1.5	1.5	2.0	7.950	11.73	0.000	0.600

Legend :

RG (Region)

TYP (Trade Type - All,Highway,Building,Floating,Oil & Chip,Rivers)

C (Class)

Base (Base Wage Rate)

FRMAN (Foreman Rate)

M-F>8 (OT required for any hour greater than 8 worked each day, Mon through Fri.)

OSA (Overtime (OT) is required for every hour worked on Saturday)

OSH (Overtime is required for every hour worked on Sunday and Holidays)

H/W (Health & Welfare Insurance)

Pensn (Pension)

Vac (Vacation)

Trng (Training)

Explanations

JO DAVIESS COUNTY

ELECTRICIANS (EAST) - Townships of Warren, Rush, Nora, Stockton, Wards Grove, Pleasant Valley and Berrenman.

IRONWORKERS (EAST) - That part of the county East of a North-South line from the North county line through Elizabeth, and East of a diagonal line from Elizabeth through Derinda Center to the South county line.

TRUCK DRIVERS (WEST) - That part of the county West of Rt. 78 including Stockton.

The following list is considered as those days for which holiday rates of wages for work performed apply: New Years Day, Memorial Day, Fourth of July, Labor Day, Thanksgiving Day, Christmas Day and Veterans Day in some classifications/counties. Generally, any of these holidays which fall on a Sunday is celebrated on the following Monday. This then makes work performed on that Monday payable at the appropriate overtime rate for holiday pay. Common practice in a given local may alter certain days of celebration. If in doubt, please check with IDOL.

Oil and chip resealing (O&C) means the application of road oils and liquid asphalt to coat an existing road surface, followed by application of aggregate chips or gravel to coated surface, and subsequent rolling of material to seal the surface.

EXPLANATION OF CLASSES

ASBESTOS - GENERAL - removal of asbestos material/mold and hazardous materials from any place in a building, including mechanical systems where those mechanical systems are to be removed. This includes the

removal of asbestos materials/mold and hazardous materials from ductwork or pipes in a building when the building is to be demolished at the time or at some close future date.

ASBESTOS - MECHANICAL - removal of asbestos material from mechanical systems, such as pipes, ducts, and boilers, where the mechanical systems are to remain.

CERAMIC TILE FINISHER, MARBLE FINISHER, TERRAZZO FINISHER

Assisting, helping or supporting the tile, marble and terrazzo mechanic by performing their historic and traditional work assignments required to complete the proper installation of the work covered by said crafts. The term "Ceramic" is used for naming the classification only and is in no way a limitation of the product handled. Ceramic takes into consideration most hard tiles.

COMMUNICATIONS TECHNICIAN

Installing, manufacturing, assembling and maintaining sound and intercom, protection alarm (security), fire alarm, master antenna television, closed circuit television, low voltage control for computers and/or door monitoring, school communications systems, telephones and servicing of nurse and emergency calls, and the installation and maintenance of transmit and receive antennas, transmitters, receivers, and associated apparatus which operates in conjunction with above systems. All work associated with these system installations will be included EXCEPT the installation of protective metallic conduit in new construction projects (excluding less than ten-foot runs strictly for protection of cable) and 120 volt AC (or higher) power wiring and associated hardware.

LABORER, SKILLED - HIGHWAY

Individuals engaged in the following types of work, irrespective of the site of the work: asbestos abatement worker, handling of any materials with any foreign matter harmful to skin or clothing, track laborer, cement handlers, chloride handlers, the unloading and loading with steel workers and re-bars, concrete workers wet, tunnel helpers in free air, batch dumpers, mason tenders, kettle and tar men, tank cleaners, plastic installers, scaffold workers, motorized buggies or motorized unit used for wet concrete or handling of building materials, laborers with de-watering systems, sewer workers plus depth, rod and chainmen with technical engineers, rod and chainmen with land surveyors, rod and chainmen with surveyors, vibrator operators, cement silica, clay, fly ash, lime and plasters, handlers (bulk or bag), cofferdam workers plus depth, on concrete paving, placing, cutting and tying of reinforcing, deck hand, dredge hand, and shore laborers, bankmen on floating plant, grade checker, power tools, front end man on chip spreaders, cession workers plus depth, gunnite nozzle men, lead man on sewer work, welders, cutters, burners and torchmen, chainsaw operators, jackhammer and drill operators, layout man and/or drainage tile layer, steel form setter - street and highway, air tamping hammermen, signal man on crane, concrete saw operator, screedman on asphalt pavers, laborers tending masons with hot material or where foreign materials are used, mortar mixer operators, multiple concrete duct - leadsman, lumen, asphalt raker, curb asphalt machine operator, ready mix scalemen (permanent, portable or temporary plant), laborers handling masterplate or similar materials, laser beam operator, concrete burning machine operator, coring machine operator, plaster tender, underpinning and shoring of buildings, pump men, manhole and catch basin, dirt and stone tamper, hose men on concrete pumps, hazardous waste worker, lead base paint abatement worker, lining of pipe, refusing machine, assisting on direct boring machine, the work of laying watermain, fire hydrants, all mechanical joints to watermain work, sewer worker, and tapping

water service and forced lift station mechanical worker.

OPERATING ENGINEERS - BUILDING

Class 1. Asphalt Plant; Asphalt Spreader; Autograde; Backhoes with Caisson Attachment; Batch Plant; Benoto (requires Two Engineers); Boiler and Throttle Valve; Caisson Rigs; Central Redi-Mix Plant; Combination Back Hoe Front End-loader Machine; Compressor and Throttle Valve; Concrete Breaker (Truck Mounted); Concrete Conveyor; Concrete Paver (over 27E cu. ft.): Concrete Paver (27 cu. ft. and under); Concrete Placer; Concrete Pump (Truck Mounted); Concrete Conveyor (Truck Mounted); Concrete Tower; Cranes, All; GCI and similar types (required two operators only); Cranes, Hammerhead; Creter Crane; Crusher, Stone, etc.; Derricks, All; Derricks, Traveling; Formless Curb and Gutter Machine; Grader, Elevating; Grouting Machines; Highlift Shovels or Front Endloader 2-1/4 yd. and over; Hoists, Elevators, outside type rack and pinion and similar machines; Hoists, one, two and three Drum; Hoists, Two Tugger One Floor; Hydraulic Backhoes; Hydraulic Boom Trucks; Hydro Vac (and similar equipment - excluding hose work and any sewer work); Locomotives, All; Lubrication Technician; Manipulators; Motor Patrol; Pile Drivers and Skid Rig; Post Hole Digger; Pre-Stress Machine; Pump Cretes Dual Ram; Pump Cretes: Squeeze Cretes - Screw Type Pumps, Gypsum Bulker and Pump; Raised and Blind Hole Drill; Rock Drill (self-propelled); Rock Drill - Truck Mounted; Roto Mill Grinder; Scoops - Tractor Drawn; Slipform Paver; Scrapers Prime Movers; Straddle Buggies; Tie Back Machine; Tractor with Boom and Side Boom; Trenching Machines.

Class 2. Bobcat (over 3/4 cu. yd.); Boilers; Brick Forklift; Broom, All Power Propelled; Bulldozers; Concrete Mixer (Two Bag and Over); Conveyor, Portable; Forklift Trucks; Highlift Shovels or Front Endloaders under 2-1/4 yd.; Hoists, Automatic; Hoists, Sewer Dragging Machine; Hoists, Tugger Single Drum; Laser Screed; Rollers, All; Steam Generators; Tractors, All; Tractor Drawn Vibratory Roller; Winch Trucks with "A" Frame.

Class 3. Air Compressor; Asphalt Spreader; Combination - Small Equipment Operator; Generators; Heaters, Mechanical; Hoists, Inside Elevators - (Rheostat Manual Controlled); Hydraulic Power Units (Pile Driving, Extracting, or Drilling - with a seat); Lowboys; Pumps, Over 3" (1 to 3 not to exceed total of 300 ft.); Pumps, Well Points; Welding Machines (2 through 5); Winches, 4 Small Electric Drill Winches; Bobcat (up to and including 3/4 cu. yd.).

Class 4. Elevator push button with automatic doors; Hoists, Inside; Oilers; Brick Forklift.

Class 5. Assistant Craft Foreman

Class 6. Mechanics; Welders.

Class 7. Gradall

OPERATING ENGINEERS - HIGHWAY CONSTRUCTION

Class 1. Asphalt Plant; Asphalt Heater and Planer Combination; Asphalt Heater Scarfire; Asphalt Silo Tender; Asphalt Spreader; Autograder; ABG Paver; Backhoes with Caisson Attachment; Ballast Regulator; Belt Loader; Caisson Rigs; Car Dumper; Central Redi-Mix Plant; Backhoe w/shear attachments; Combination Backhoe Front Endloader Machine, (1 cu. yd. Backhoe Bucket or over or with attachments); Concrete Breaker (Truck Mounted); Concrete Conveyor; Concrete Paver over 27E cu. ft.; Concrete Placer; Concrete Tube Float; Cranes, all attachments; Cranes, Tower of all types; Creter Crane; Crusher, Stone, etc.; Derricks,

All; Derrick Boats; Derricks, Traveling; Directional Boring Machine over 12"; Dredges; Formless Curb and Gutter Machine; Grader, Elevating; Grader, Motor Grader, Motor Patrol, Auto Patrol, Form Grader, Pull Grader, Subgrader; Guard Rail Post Driver Mounted; Hoists, One, Two and Three Drum; Hydraulic Backhoes; Hydro Vac, Self Propelled, Truck Mounted (excluding hose work and any sewer work); Lubrication Technician; Manipulators; Pile Drivers and Skid Rig; Pre-Stress Machine; Pump Cretes Dual Ram; Rock Drill - Crawler or Skid Rig; Rock Drill - Truck Mounted; Rock/Track Tamper; Roto Mill Grinder; Slip-Form Paver; Snow Melters; Soil Test Drill Rig (Truck Mounted); Straddle Buggies; GCI Crane; Hydraulic Telescoping Form (Tunnel); Tie Back Machine; Tractor Drawn Belt Loader; Tractor Drawn Belt Loader with attached pusher; Tractor with Boom; Tractaire with Attachments; Traffic Barrier Conveyor Machine; Raised or Blind Hole Drills; Trenching Machine (over 12"); Truck Mounted Concrete Pump with Boom; Truck Mounted Concrete Conveyor; Work Boat (no license required - 90 h.p. or above); Underground Boring and/or Mining Machines; Wheel Excavator; Widener (APSCO).

Class 2. Batch Plant; Bituminous Mixer; Boiler and Throttle Valve; Bulldozers; Car Loader Trailing Conveyors; Combination Backhoe Front Endloader Machine (less than 1 cu. yd. Backhoe Bucket or over or with attachments); Compressor and Throttle Valve; Compressor, Common Receiver (3); Concrete Breaker or Hydro Hammer; Concrete Grinding Machine; Concrete Mixer or Paver 7S Series to and including 27 cu. ft.; Concrete Spreader; Concrete Curing Machine, Burlap Machine, Belting Machine and Sealing Machine; Concrete Wheel Saw (large self-propelled - excluding walk-behinds and hand-held); Conveyor Muck Cars (Haglund or Similar Type); Drills, all; Finishing Machine - Concrete; Highlift Shovels or Front Endloader; Hoist - Sewer Dragging Machine; Hydraulic Boom Trucks (All Attachments); Hydro Blaster; All Locomotives, Dinky; Off-Road Hauling Units; Non-Self Loading Dump; Ejection Dump; Pump Cretes: Squeeze Cretes - Screw Type Pumps, Gypsum Bulker and Pump; Roller, Asphalt; Rotary Snow Plows; Rototiller, Seaman, etc., self-propelled; Scoops - Tractor Drawn; Self-Propelled Compactor; Spreader - Chip - Stone, etc.; Scraper; Scraper - Prime Mover in Tandem (Regardless of Size); Tank Car Heater; Tractors, Push, Pulling Sheeps Foot, Disc, Compactor, etc.; Tug Boats.

Class 3. Boilers; Brooms, All Power Propelled; Cement Supply Tender; Compressor, Common Receiver (2); Concrete Mixer (Two Bag and Over); Conveyor, Portable; Farm-Type Tractors Used for Mowing, Seeding, etc.; Fireman on Boilers; Forklift Trucks; Grouting Machine; Hoists, Automatic; Hoists, All Elevators; Hoists, Tugger Single Drum; Jeep Diggers; Low Boys; Pipe Jacking Machines; Post-Hole Digger; Power Saw, Concrete Power Driven; Pug Mills; Rollers, other than asphalt; Seed and Straw Blower; Steam Generators; Stump Machine; Winch Trucks with "A" Frame; Work Boats; Tamper - Form - Motor Driven.

Class 4. Air Compressor - Small and Large; Asphalt Spreader, Backend Man; Bobcat (Skid Steer) all; Brick Forklift; Combination - Small Equipment Operator; Directional Boring Machine up to 12"; Generators; Heaters, Mechanical; Hydraulic Power Unit (Pile Driving, Extracting, or Drilling); Hydro-Blaster; Light Plants, All (1 through 5); Pumps, over 3" (1 to 3 not to exceed a total of 300 ft.); Pumps, Well Points; Tractaire; Trencher 12" and under; Welding Machines (2 through 5); Winches, 4 Small Electric Drill Winches.

Class 5. Oilers and Directional Boring Machine Locator.

Class 6. Field Mechanics and Field Welders

Class 7. Gradall and machines of like nature.

TRUCK DRIVER - BUILDING, HEAVY AND HIGHWAY CONSTRUCTION - WEST

Class 1. Drivers on 2 axle trucks hauling less than 9 ton. Air compressor and welding machines and brooms, including those pulled by separate units, truck driver helpers, warehouse employees, mechanic helpers, greasers and tiremen, pickup trucks when hauling materials, tools, or workers to and from and on-the-job site, and fork lifts up to 6,000 lb. capacity.

Class 2. Two or three axle trucks hauling more than 9 ton but hauling less than 16 ton. A-frame winch trucks, hydrolift trucks, vector trucks or similar equipment when used for transportation purposes. Fork lifts over 6,000 lb. capacity, winch trucks, four axle combination units, and ticket writers.

Class 3. Two, three or four axle trucks hauling 16 ton or more. Drivers on water pulls, articulated dump trucks, mechanics and working forepersons, and dispatchers. Five axle or more combination units.

Class 4. Low Boy and Oil Distributors.

Class 5. Drivers who require special protective clothing while employed on hazardous waste work.

TRUCK DRIVER - BUILDING, HEAVY AND HIGHWAY CONSTRUCTION - EAST

Class 1. Two or three Axle Trucks. A-frame Truck when used for transportation purposes; Air Compressors and Welding Machines, including those pulled by cars, pick-up trucks and tractors; Ambulances; Batch Gate Lockers; Batch Hopperman; Car and Truck Washers; Carry-alls; Fork Lifts and Hoisters; Helpers; Mechanics Helpers and Greasers; Oil Distributors 2-man operation; Pavement Breakers; Pole Trailer, up to 40 feet; Power Mower Tractors; Self-propelled Chip Spreader; Skipman; Slurry Trucks, 2-man operation; Slurry Truck Conveyor Operation, 2 or 3 man; Teamsters; Unskilled dumpman; and Truck Drivers hauling warning lights, barricades, and portable toilets on the job site.

Class 2. Four axle trucks; Dump Crets and Adgetors under 7 yards; Dumpsters, Track Trucks, Euclids, Hug Bottom Dump Turnapulls or Turnatrailers when pulling other than self-loading equipment or similar equipment under 16 cubic yards; Mixer Trucks under 7 yards; Ready-mix Plant Hopper Operator, and Winch Trucks, 2 Axles.

Class 3. Five axle trucks; Dump Crets and Adgetors 7 yards and over; Dumpsters, Track Trucks, Euclids, Hug Bottom Dump Turnatrailers or turnapulls when pulling other than self-loading equipment or similar equipment over 16 cubic yards; Explosives and/or Fission Material Trucks; Mixer Trucks 7 yards or over; Mobile Cranes while in transit; Oil Distributors, 1-man operation; Pole Trailer, over 40 feet; Pole and Expandable Trailers hauling material over 50 feet long; Slurry trucks, 1-man operation; Winch trucks, 3 axles or more; Mechanic--Truck Welder and Truck Painter.

Class 4. Six axle trucks; Dual-purpose vehicles, such as mounted crane trucks with hoist and accessories; Foreman; Master Mechanic; Self-loading equipment like P.B. and trucks with scoops on the front.

TRUCK DRIVER - OIL AND CHIP RESEALING ONLY.

This shall encompass laborers, workers and mechanics who drive contractor or subcontractor owned, leased, or hired pickup, dump, service, or oil distributor trucks. The work includes transporting

materials and equipment (including but not limited to, oils, aggregate supplies, parts, machinery and tools) to or from the job site; distributing oil or liquid asphalt and aggregate; stock piling material when in connection with the actual oil and chip contract. The Truck Driver (Oil & Chip Resealing) wage classification does not include supplier delivered materials.

Other Classifications of Work:

For definitions of classifications not otherwise set out, the Department generally has on file such definitions which are available. If a task to be performed is not subject to one of the classifications of pay set out, the Department will upon being contacted state which neighboring county has such a classification and provide such rate, such rate being deemed to exist by reference in this document. If no neighboring county rate applies to the task, the Department shall undertake a special determination, such special determination being then deemed to have existed under this determination. If a project requires these, or any classification not listed, please contact IDOL at 217-782-1710 for wage rates or clarifications.

LANDSCAPING

Landscaping work falls under the existing classifications for laborer, operating engineer and truck driver. The work performed by landscape plantsman and landscape laborer is covered by the existing classification of laborer. The work performed by landscape operators (regardless of equipment used or its size) is covered by the classifications of operating engineer. The work performed by landscape truck drivers (regardless of size of truck driven) is covered by the classifications of truck driver.

Johnson County Prevailing Wage for May 2013

(See explanation of column headings at bottom of wages)

Trade Name	RG	TYP	C	Base	FRMAN	M-F>8	OSA	OSH	H/W	Pensn	Vac	Trng
=====	==	===	=	=====	=====	=====	===	===	=====	=====	=====	=====
ASBESTOS ABT-GEN		ALL		25.300	25.750	1.5	1.5	2.0	5.750	10.35	0.000	0.900
ASBESTOS ABT-MEC		BLD		21.150	22.150	1.5	1.5	2.0	6.400	5.150	0.000	0.650
BOILERMAKER		BLD		31.500	34.000	1.5	1.5	2.0	7.070	18.73	1.000	0.350
BRICK MASON		BLD		28.620	30.120	1.5	1.5	2.0	8.200	7.030	0.000	0.430
CARPENTER		BLD		31.890	33.390	1.5	1.5	2.0	6.550	6.750	0.000	0.400
CARPENTER		HWY		31.840	33.340	1.5	1.5	2.0	6.550	6.750	0.000	0.400
CEMENT MASON		BLD		28.200	29.700	1.5	1.5	2.0	6.600	5.400	0.000	0.500
CEMENT MASON		HWY		27.290	28.290	1.5	1.5	2.0	6.600	5.160	0.000	0.400
CERAMIC TILE FNSHER		BLD		27.120	0.000	1.5	1.5	2.0	8.200	7.030	0.000	0.430
ELECTRIC PWR EQMT OP		ALL	1	35.570	0.000	1.5	1.5	2.0	5.000	9.960	0.000	0.360
ELECTRIC PWR EQMT OP		ALL	2	31.740	0.000	1.5	1.5	2.0	5.000	8.880	0.000	0.320
ELECTRIC PWR GRNDMAN		ALL		26.100	0.000	1.5	1.5	2.0	5.000	7.310	0.000	0.260
ELECTRIC PWR LINEMAN		ALL		44.630	47.650	1.5	1.5	2.0	5.000	12.50	0.000	0.450
ELECTRICIAN		ALL		39.350	41.600	1.5	1.5	2.0	6.140	9.440	0.000	0.790
ELECTRONIC SYS TECH		BLD		32.570	34.320	1.5	1.5	2.0	6.000	4.240	0.000	0.400
FLOOR LAYER		BLD		29.330	30.080	1.5	1.5	2.0	6.550	6.750	0.000	0.400
GLAZIER		BLD		26.780	28.030	1.5	1.5	2.0	6.120	5.200	0.000	0.300
HT/FROST INSULATOR		BLD		29.450	30.450	1.5	1.5	2.0	5.050	9.730	0.000	0.280
IRON WORKER		ALL		27.730	29.730	1.5	1.5	2.0	7.010	11.41	0.000	0.500
LABORER		BLD		25.300	25.750	1.5	1.5	2.0	5.750	10.35	0.000	0.800
LABORER		HWY		25.300	25.750	1.5	1.5	2.0	5.750	10.35	0.000	0.800
LABORER		O&C		17.740	18.190	1.5	1.5	2.0	5.450	8.450	0.000	0.800

MACHINIST	BLD	43.550	46.050	1.5	1.5	2.0	6.130	8.950	1.850	0.000
MARBLE FINISHERS	BLD	27.120	0.000	1.5	1.5	2.0	8.200	7.030	0.000	0.430
MARBLE MASON	BLD	28.620	30.120	1.5	1.5	2.0	8.200	7.030	0.000	0.430
MILLWRIGHT	BLD	31.890	33.390	1.5	1.5	2.0	6.550	6.750	0.000	0.400
MILLWRIGHT	HWY	31.840	33.340	1.5	1.5	2.0	6.550	6.750	0.000	0.400
OE RIVER 1	RIV 1	33.550	34.550	1.5	1.5	2.0	7.000	8.800	0.000	1.450
OE RIVER 2	RIV 2	30.100	34.550	1.5	1.5	2.0	7.000	8.800	0.000	1.450
OPERATING ENGINEER	ALL 1	33.450	34.450	1.5	1.5	2.0	7.000	8.800	0.000	1.450
OPERATING ENGINEER	ALL 2	31.550	34.450	1.5	1.5	2.0	7.000	8.800	0.000	1.450
OPERATING ENGINEER	ALL 3	24.150	34.450	1.5	1.5	2.0	7.000	8.800	0.000	1.450
OPERATING ENGINEER	ALL 4	21.400	27.800	1.5	1.5	2.0	5.650	6.100	0.000	1.100
OPERATING ENGINEER	O&C 1	25.090	26.090	1.5	1.5	2.0	7.000	8.800	0.000	1.450
OPERATING ENGINEER	O&C 2	23.660	26.090	1.5	1.5	2.0	7.000	8.800	0.000	1.450
OPERATING ENGINEER	O&C 3	18.120	26.090	1.5	1.5	2.0	7.000	8.800	0.000	1.450
OPERATING ENGINEER	O&C 4	16.050	21.100	1.5	1.5	2.0	5.650	6.100	0.000	1.100
PAINTER	BLD	26.260	27.760	1.5	1.5	2.0	6.630	7.070	0.000	0.500
PAINTER	HWY	30.560	32.060	1.5	1.5	2.0	6.630	7.070	0.000	0.500
PAINTER OVER 30FT	BLD	27.260	28.760	1.5	1.5	2.0	6.630	7.070	0.000	0.500
PAINTER PWR EQMT	BLD	27.260	28.760	1.5	1.5	2.0	6.630	7.070	0.000	0.500
PAINTER PWR EQMT	HWY	31.560	33.060	1.5	1.5	2.0	6.630	7.070	0.000	0.500
PILEDRIVER	BLD	31.890	33.390	1.5	1.5	2.0	6.550	6.750	0.000	0.400
PILEDRIVER	HWY	31.840	33.340	1.5	1.5	2.0	6.550	6.750	0.000	0.400
PIPEFITTER	BLD	41.470	45.620	1.5	2.0	2.0	8.450	5.780	0.000	1.250
PLASTERER	BLD	28.200	29.700	1.5	1.5	2.0	6.600	5.400	0.000	0.500
PLUMBER	BLD	41.470	45.620	1.5	2.0	2.0	8.450	5.780	0.000	1.250
ROOFER	BLD	23.900	24.900	1.5	1.5	2.0	8.650	3.800	0.000	0.000
SHEETMETAL WORKER	ALL	31.690	33.190	1.5	1.5	2.0	7.130	6.730	1.910	0.360
SPRINKLER FITTER	BLD	36.390	39.140	1.5	1.5	2.0	8.420	8.500	0.000	0.450
STONE MASON	BLD	28.620	30.120	1.5	1.5	2.0	8.200	7.030	0.000	0.430
TERRAZZO FINISHER	BLD	27.120	0.000	1.5	1.5	2.0	8.200	7.030	0.000	0.430
TERRAZZO MASON	BLD	28.620	30.120	1.5	1.5	2.0	8.200	7.030	0.000	0.430
TRUCK DRIVER	ALL 1	30.070	0.000	1.5	1.5	2.0	10.30	6.100	0.000	0.250
TRUCK DRIVER	ALL 2	30.520	0.000	1.5	1.5	2.0	10.30	6.100	0.000	0.250
TRUCK DRIVER	ALL 3	30.740	0.000	1.5	1.5	2.0	10.30	6.100	0.000	0.250
TRUCK DRIVER	ALL 4	31.030	0.000	1.5	1.5	2.0	10.30	6.100	0.000	0.250
TRUCK DRIVER	ALL 5	31.850	0.000	1.5	1.5	2.0	10.30	6.100	0.000	0.250
TRUCK DRIVER	O&C 1	22.750	0.000	1.5	1.5	2.0	2.920	6.700	0.000	0.250
TRUCK DRIVER	O&C 2	19.150	0.000	1.5	1.5	2.0	2.920	6.700	0.000	0.250
TRUCK DRIVER	O&C 3	19.650	0.000	1.5	1.5	2.0	2.920	6.700	0.000	0.250
TUCK POINTER	BLD	28.620	30.120	1.5	1.5	2.0	8.200	7.030	0.000	0.430

Legend :

RG (Region)

TYP (Trade Type - All,Highway,Building,Floating,Oil & Chip,Rivers)

C (Class)

Base (Base Wage Rate)

FRMAN (Foreman Rate)

M-F>8 (OT required for any hour greater than 8 worked each day, Mon through Fri.)

OSA (Overtime (OT) is required for every hour worked on Saturday)

OSH (Overtime is required for every hour worked on Sunday and Holidays)

H/W (Health & Welfare Insurance)

Pensn (Pension)

Vac (Vacation)

Trng (Training)

Explanations

JOHNSON COUNTY

The following list is considered as those days for which holiday rates of wages for work performed apply: New Years Day, Memorial Day, Fourth of July, Labor Day, Thanksgiving Day, Christmas Day and Veterans Day in some classifications/counties. Generally, any of these holidays which fall on a Sunday is celebrated on the following Monday. This then makes work performed on that Monday payable at the appropriate overtime rate for holiday pay. Common practice in a given local may alter certain days of celebration. If in doubt, please check with IDOL.

Oil and chip resealing (O&C) means the application of road oils and liquid asphalt to coat an existing road surface, followed by application of aggregate chips or gravel to coated surface, and subsequent rolling of material to seal the surface.

EXPLANATION OF CLASSES

ASBESTOS - GENERAL - removal of asbestos material/mold and hazardous materials from any place in a building, including mechanical systems where those mechanical systems are to be removed. This includes the removal of asbestos materials/mold and hazardous materials from ductwork or pipes in a building when the building is to be demolished at the time or at some close future date.

ASBESTOS - MECHANICAL - removal of asbestos material from mechanical systems, such as pipes, ducts, and boilers, where the mechanical systems are to remain.

LABORER - OIL AND CHIP RESEALING ONLY

Hook and unhook chip box from aggregate truck; distribute material within chip box; perform flagging work related to oil and chip resealing; hand spray oil fluids; handle traffic control, including setting-up and maintaining barricades, drums, cones, delineators, signs and other such items, as well as laying-out and applying or removing temporary roadway markings used to control traffic in job site related to oil and chip resealing; and perform clean-up related to oil and chip resealing.

CERAMIC TILE FINISHER, MARBLE FINISHER, TERRAZZO FINISHER

Assisting, helping or supporting the tile, marble and terrazzo mechanic by performing their historic and traditional work assignments required to complete the proper installation of the work covered by said crafts. The term "Ceramic" is used for naming the classification only, and is in no a limitation of the product handled. Ceramic takes into consideration most hard tiles.

ELECTRIC POWER LINEMAN

Construction, maintenance and dismantling of overhead and underground electric power lines, including high voltage pipe type cable work, and associated structures and equipment.

ELECTRIC POWER EQUIPMENT OPERATOR - CLASS 1

Operation of all crawler type equipment D-4 and larger from the ground to assist the Electric Power Linemen in performing their duties.

ELECTRIC POWER EQUIPMENT OPERATORS - CLASS 2

Operation of all other equipment from the ground to assist the Electric Power Linemen in performing their duties.

ELECTRIC POWER GROUNDMAN

Applies to workers who assist the Electric Power Lineman from the ground.

ELECTRONIC SYSTEMS TECHNICIAN

Installation, service and maintenance of low-voltage systems which utilizes the transmission and/or transference of voice, sound, vision, or digital for commercial, education, security and entertainment purposes for the following: TV monitoring and surveillance, background/foreground music, intercom and telephone interconnect, field programming, inventory control systems, microwave transmission, multi-media, multiplex, radio page, school, intercom and sound burglar alarms and low voltage master clock systems.

Excluded from this classification are energy management systems, life safety systems, supervisory controls and data acquisition systems not intrinsic with the above listed systems, fire alarm systems, nurse call systems and raceways exceeding fifteen feet in length.

TRUCK DRIVER - BUILDING, HEAVY AND HIGHWAY CONSTRUCTION

Class 1. Drivers on 2 axle trucks hauling less than 9 ton. Air compressor and welding machines and brooms, including those pulled by separate units, truck driver helpers, warehouse employees, mechanic helpers, greasers and tiremen, pickup trucks when hauling materials, tools, or workers to and from and on-the-job site, and fork lifts up to 6,000 lb. capacity.

Class 2. Two or three axle trucks hauling more than 9 ton but hauling less than 16 ton. A-frame winch trucks, hydrolift trucks, vactor trucks or similar equipment when used for transportation purposes. Fork lifts over 6,000 lb. capacity, winch trucks, four axle combination units, and ticket writers.

Class 3. Two, three or four axle trucks hauling 16 ton or more. Drivers on water pulls, articulated dump trucks, mechanics and working forepersons, and dispatchers. Five axle or more combination units.

Class 4. Low Boy and Oil Distributors.

Class 5. Drivers who require special protective clothing while employed on hazardous waste work.

TRUCK DRIVER - O & C (Oil and Chip Resealing ONLY)

It involves driving of contractor or subcontractor owned, leased, or hired pickup, dump, service, or oil distributor trucks. Includes transporting materials and equipment (including, but not limited to oils, aggregate supplies, parts, machinery and tools) to or from the job site; distributing oil or liquid asphalt and aggregate; stock piling material; and maintaining trucks at job site related to oil and chip resealing.

Class 1. Distributors, liquid asphalt hauling and hauling of asphalt rubber-tired rollers.

Class 2. Stockpiling.

Class 3. Tandem hauling to job site.

OPERATING ENGINEERS - BUILDING, HEAVY AND HIGHWAY CONSTRUCTION

Class 1. APSCO or Equal Spreading Machine, Backhoe, Backfiller, Boom or Winch Cat, Bituminous Mixplane Machine, Blacksmith, Bituminous Surfacing Machine, Bull-Dozer, Crane, Shovel, Dragline, Truck Crane, Pile Driver, Concrete Breaker, Concrete or Pumpcrete Pumps, Dinky or Standard Locomotives, Well or Caisson Drills, Elevating Grader, Fork Lifts, Flexplane, Gradeall, Hi-Lift Hoists, Guy-Derricks, Hysters, Mechanic Motor Patrol, Mixers-21 cu. ft. or over, Push Cats, Pulls and Scrapers, Two Well Point Pumps, Pulverizer or Tiller, PugMill, Rubber-Tired Farm Type Tractor with Bulldozer/Blade/Auger or hi-lift over 1/2 yd., Jersey Spreader, Tract-Air used with Drill or Hi-Lift, Trenching or Ditching Machines, Wood Chipper w/Tractor, Self-Propelled Roller w/Blade, Equipment Greaser, Self-Propelled Bump Grinder on Concrete pavement, Boat Operator, Skid-Loaders, Tuggers, Lazer Screed, and Self-Propelled Chip Spreader (when others run conveyors).

Class 2. Any type tractor pulling any type roller or disc, Two Air Compressors (220 cu. ft. capacity or over), Two AirTract Drills, Air-Track Drill w/Compressor, Automatic Bins or Scales w/Compressor or Generator, Pipeline Boring Machine, Bulk Cement Plant w/Separate Compressor, Power Operated Bull Float, Hydra-Lift w/Single Motor, Straw Mulcher Blower w/Spout, Self-Propelled Roller/Compactor, Back-End man on Bituminous Surfacing Machine, oiler on milling machine.

Class 3. Air Compressor w/Valve driving piling, Boom or Winch Type Truck, Two Conveyors, Self-Propelled Concrete Saw, Form Grader, Truck Crane Oiler, Self-Propelled Vibrator, Rubber Tired Farm Type Tractor w/Blade/Bulldozer/Auger/hi-lift - 1/2 yd. or less, Elevator Operator, Man Lift (scissor lift) when lifting materials.

Class 4. Air-Track Drill (one), Belt Drag Machine, Power Broom, Mechanical Plasterer Applicator, Trac-Air, Air Compressor (220 cu. ft. or over) One, Air Compressor (under 220 cu. ft) four, Automatic Bin, Bulk Cement Plant w/Built-in Compressor running off same motor or electric motor, Fireman or Switchman, Self-Propelled Form Tamper, Light Plants (4), Welding Machines (4), Pumps (4), or Combination of four (4) Pumps, Light Plants, Welding Machines, Air-Compressors (under 220 cu. ft.), Mudjacks or Wood Chipper, Mixers - less than 21 cu. ft. Mortar Mixer w/Skip or Pump, Pipeline Tract Jack. One Operating Engineer may operate and maintain any combination of the following pieces of equipment, not to exceed four (4) which shall be within a reasonable distance, such combination may include any equipment in this classification: (Compressors, Light Plants, Generators, Welding Machines, Pumps or Conveyors), One Well- Point Pump, Two Motor Driven Heaters, One Air Compressor (under 220 cu. ft.), One Engine-Driven Conveyor, One Motor Driven Heater, One Light Plant, One Pump, One Welding Machine, One Ulmac or Equal Spreader, Oilers, and one Generator 10 kw or greater.

OPERATING ENGINEER - O & C (Oil and Chip Resealing ONLY). Includes the operation of all motorized heavy equipment used in oil and chip rsealing, including but not limited to operating self-propelled chip spreaders, and all types of rollers (both hard and rubber tired); and other duties pertaining to the operation or maintenance of heavy equipment related to oil and chip resealing.

Class 1. See Class 1 above for types of equipment operated.

Class 2. See Class 2 above for types of equipment operated.

Class 3. See Class 3 above for types of equipment operated.

Class 4. See Class 4 above for types of equipment operated.

OPERATING ENGINEER RIVER WORK 1 - operate the following machines when working on River Work and Levee Work on the Mississippi and Ohio Rivers, Lakes and Tributaries: Crane, Shovel, Drageline, Scrapers, Dredge, Derrick, Pile-Driver, Push Boat, all power boat operators, Mechanic, Engineman on Dredge, Leverman on Dredge, All Bituminous Spreader machines, Backhoe, Backfiller, Boom, or Winch Cat, Bituminous Mixplane Machine, Blacksmith, Bituminous Surfacing Machine, Bulldozer, Truck Cranes, Hydraulic Truck Mounted Boom/Crane, Concrete Finishing Machine, or Spreader Machine, Concrete Breaker, Concrete or Pumpcrete Machines, Concrete Plant Operator, All Off Road Material Hauling Equipment, Dinky or Standard Locomotives, Well Drill, Elevating Grader, Fork-Lifts, Flexplane, Gradeall, Hi-Lift, Power Handblade Tugger type Hoist, Hoist Two Drum (or over one), Gyderrick, Hyster, Motor Patrol, Mixers - 21 Cu. Ft. or over, Push Cat, Pulls, & Scrapers, Pumps-Two Well Points, Equipment Greaser, P & H Pulverizer or Pulverizer equal to Pugmill, Pugmill, Rubber-Tired farm type tractor w/Bulldozer/Blade/Auger or Hi-Lift over ½ yard, Skimmer Scoops, Seaman Tiller, Jersey Spreader, Tract-Air used with Drill or Hi-Lift, Trenching or Ditching Machine, Wood Chipper w/Tractor, self-propelled roller w/Blade, Concrete Pumps and Small Equipment Operators.

OPERATING ENGINEER RIVER 2 - when working on River Work and Levee Work on the Mississippi and Ohio Rivers, Lakes and Tributaries shall be employed as the Oiler or Fireman on Crane, Dragline, Shovel, Dredge, Truck Crane, Pile Driver, Gradeall, Dinky or Standard Locomotive, Guy Derrick, Trenching Machine or Ditching Machine 80 H.P. and over, All Terrain (cherry-picker) with over 40 ton Lifting Capacity, Deck Oiler and Deckhands.

Other Classifications of Work:

For definitions of classifications not otherwise set out, the Department generally has on file such definitions which are available. If a task to be performed is not subject to one of the classifications of pay set out, the Department will upon being contacted state which neighboring county has such a classification and provide such rate, such rate being deemed to exist by reference in this document. If no neighboring county rate applies to the task, the Department shall undertake a special determination, such special determination being then deemed to have existed under this determination. If a project requires these, or any classification not listed, please contact IDOL at 217-782-1710 for wage rates or clarifications.

LANDSCAPING

Landscaping work falls under the existing classifications for laborer, operating engineer and truck driver. The work performed by landscape plantsman and landscape laborer is covered by the existing classification of laborer. The work performed by landscape operators (regardless of equipment used or its size) is covered by the classifications of operating engineer. The work performed by landscape truck drivers (regardless of size of truck driven) is covered by the classifications of truck driver.

Kane County Prevailing Wage for May 2013

(See explanation of column headings at bottom of wages)

Trade Name	RG	TYP	C	Base	FRMAN	M-F>8	OSA	OSH	H/W	Pensn	Vac	Trng
=====	==	===	=	=====	=====	=====	===	===	=====	=====	=====	=====
ASBESTOS ABT-GEN		ALL		36.200	36.700	1.5	1.5	2.0	12.78	9.020	0.000	0.500
ASBESTOS ABT-MEC		BLD		34.160	36.660	1.5	1.5	2.0	10.82	10.66	0.000	0.720
BOILERMAKER		BLD		43.450	47.360	2.0	2.0	2.0	6.970	14.66	0.000	0.350
BRICK MASON		BLD		40.680	44.750	1.5	1.5	2.0	9.550	12.00	0.000	0.970
CARPENTER		ALL		41.520	43.520	1.5	1.5	2.0	13.19	11.76	0.000	0.530
CEMENT MASON		ALL		41.550	43.550	2.0	1.5	2.0	9.500	13.76	0.000	0.500
CERAMIC TILE FNSHER		BLD		34.440	0.000	2.0	1.5	2.0	9.700	6.930	0.000	0.610
COMMUNICATION TECH	N	BLD		35.770	37.870	1.5	1.5	2.0	12.07	9.370	0.000	0.450
COMMUNICATION TECH	S	BLD		36.390	38.490	1.5	1.5	2.0	10.02	10.19	0.000	1.090
ELECTRIC PWR EQMT OP		ALL		36.610	49.750	1.5	1.5	2.0	5.000	11.35	0.000	0.270
ELECTRIC PWR GRNDMAN		ALL		28.310	49.750	1.5	1.5	2.0	5.000	8.780	0.000	0.210
ELECTRIC PWR LINEMAN		ALL		43.830	49.750	1.5	1.5	2.0	5.000	13.58	0.000	0.330
ELECTRIC PWR TRK DRV		ALL		29.310	49.750	1.5	1.5	2.0	5.000	9.090	0.000	0.220
ELECTRICIAN	N	ALL		43.080	47.380	1.5	1.5	2.0	12.06	11.41	0.000	0.540
ELECTRICIAN	S	BLD		43.560	47.920	1.5	1.5	2.0	10.02	12.20	0.000	1.310
ELEVATOR CONSTRUCTOR		BLD		49.080	55.215	2.0	2.0	2.0	11.88	12.71	3.930	0.600
FENCE ERECTOR		ALL		44.950	47.200	2.0	2.0	2.0	8.890	17.69	0.000	0.400
GLAZIER		BLD		39.500	41.000	1.5	2.0	2.0	11.99	14.30	0.000	0.840
HT/FROST INSULATOR		BLD		45.550	48.050	1.5	1.5	2.0	10.82	11.86	0.000	0.720
IRON WORKER		ALL		44.950	47.200	2.0	2.0	2.0	8.890	17.69	0.000	0.400
LABORER		ALL		36.200	36.950	1.5	1.5	2.0	12.52	9.280	0.000	0.500
LATHER		ALL		41.520	43.520	1.5	1.5	2.0	13.19	11.76	0.000	0.530
MACHINIST		BLD		43.550	46.050	1.5	1.5	2.0	6.130	8.950	1.850	0.000
MARBLE FINISHERS		ALL		29.700	0.000	1.5	1.5	2.0	9.550	11.75	0.000	0.620
MARBLE MASON		BLD		39.880	43.870	1.5	1.5	2.0	9.550	11.75	0.000	0.730
MATERIAL TESTER I		ALL		26.200	0.000	1.5	1.5	2.0	12.52	9.280	0.000	0.500
MATERIALS TESTER II		ALL		31.200	0.000	1.5	1.5	2.0	12.52	9.280	0.000	0.500
MILLWRIGHT		ALL		41.520	43.520	1.5	1.5	2.0	13.19	11.76	0.000	0.530
OPERATING ENGINEER		BLD	1	45.100	49.100	2.0	2.0	2.0	15.70	10.55	1.900	1.250
OPERATING ENGINEER		BLD	2	43.800	49.100	2.0	2.0	2.0	15.70	10.55	1.900	1.250
OPERATING ENGINEER		BLD	3	41.250	49.100	2.0	2.0	2.0	15.70	10.55	1.900	1.250
OPERATING ENGINEER		BLD	4	39.500	49.100	2.0	2.0	2.0	15.70	10.55	1.900	1.250
OPERATING ENGINEER		BLD	5	48.850	49.100	2.0	2.0	2.0	15.70	10.55	1.900	1.250
OPERATING ENGINEER		BLD	6	46.100	49.100	2.0	2.0	2.0	15.70	10.55	1.900	1.250
OPERATING ENGINEER		BLD	7	48.100	49.100	2.0	2.0	2.0	15.70	10.55	1.900	1.250
OPERATING ENGINEER		HWY	1	43.300	47.300	1.5	1.5	2.0	15.70	10.55	1.900	1.250
OPERATING ENGINEER		HWY	2	42.750	47.300	1.5	1.5	2.0	15.70	10.55	1.900	1.250
OPERATING ENGINEER		HWY	3	40.700	47.300	1.5	1.5	2.0	15.70	10.55	1.900	1.250
OPERATING ENGINEER		HWY	4	39.300	47.300	1.5	1.5	2.0	15.70	10.55	1.900	1.250
OPERATING ENGINEER		HWY	5	38.100	47.300	1.5	1.5	2.0	15.70	10.55	1.900	1.250
OPERATING ENGINEER		HWY	6	46.300	47.300	1.5	1.5	2.0	15.70	10.55	1.900	1.250
OPERATING ENGINEER		HWY	7	44.300	47.300	1.5	1.5	2.0	15.70	10.55	1.900	1.250
ORNAMNTL IRON WORKER		ALL		44.950	47.200	2.0	2.0	2.0	8.890	17.69	0.000	0.400
PAINTER		ALL		40.880	42.880	1.5	1.5	1.5	9.650	8.200	0.000	1.250
PAINTER SIGNS		BLD		33.920	38.090	1.5	1.5	1.5	2.600	2.710	0.000	0.000
PILEDRIVER		ALL		41.520	43.520	1.5	1.5	2.0	13.19	11.76	0.000	0.530
PIPEFITTER		BLD		41.200	43.200	1.5	1.5	2.0	9.750	16.34	0.000	1.710
PLASTERER		BLD		40.250	42.670	1.5	1.5	2.0	10.85	10.94	0.000	0.550
PLUMBER		BLD		41.200	43.200	1.5	1.5	2.0	9.750	16.34	0.000	1.710
ROOFER		BLD		38.350	41.350	1.5	1.5	2.0	8.280	8.770	0.000	0.430
SHEETMETAL WORKER		BLD		42.510	44.510	1.5	1.5	2.0	10.04	12.01	0.000	0.780
SIGN HANGER		BLD		26.070	27.570	1.5	1.5	2.0	3.800	3.550	0.000	0.000
SPRINKLER FITTER		BLD		49.200	51.200	1.5	1.5	2.0	10.25	8.350	0.000	0.450
STEEL ERECTOR		ALL		44.950	47.200	2.0	2.0	2.0	8.890	17.69	0.000	0.400
STONE MASON		BLD		40.680	44.750	1.5	1.5	2.0	9.550	12.00	0.000	0.970
TERRAZZO FINISHER		BLD		35.510	0.000	1.5	1.5	2.0	9.700	9.320	0.000	0.400
TERRAZZO MASON		BLD		39.370	42.370	1.5	1.5	2.0	9.700	10.66	0.000	0.550
TILE MASON		BLD		41.430	45.430	2.0	1.5	2.0	9.700	8.640	0.000	0.710
TRAFFIC SAFETY WRKR		HWY		28.250	29.850	1.5	1.5	2.0	4.896	4.175	0.000	0.000
TRUCK DRIVER		ALL	1	32.550	33.100	1.5	1.5	2.0	6.500	4.350	0.000	0.150
TRUCK DRIVER		ALL	2	32.700	33.100	1.5	1.5	2.0	6.500	4.350	0.000	0.150
TRUCK DRIVER		ALL	3	32.900	33.100	1.5	1.5	2.0	6.500	4.350	0.000	0.150

TRUCK DRIVER	ALL	4	33.100	33.100	1.5	1.5	2.0	6.500	4.350	0.000	0.150
TUCKPOINTER	BLD		40.950	41.950	1.5	1.5	2.0	8.180	10.82	0.000	0.940

Legend:

RG (Region)

TYP (Trade Type - All,Highway,Building,Floating,Oil & Chip,Rivers)

C (Class)

Base (Base Wage Rate)

FRMAN (Foreman Rate)

M-F>8 (OT required for any hour greater than 8 worked each day, Mon through Fri.)

OSA (Overtime (OT) is required for every hour worked on Saturday)

OSH (Overtime is required for every hour worked on Sunday and Holidays)

H/W (Health & Welfare Insurance)

Pensn (Pension)

Vac (Vacation)

Trng (Training)

Explanations

KANE COUNTY

ELECTRICIANS AND COMMUNICATIONS TECHNICIAN (NORTH) - Townships of Burlington, Campton, Dundee, Elgin, Hampshire, Plato, Rutland, St. Charles (except the West half of Sec. 26, all of Secs. 27, 33, and 34, South half of Sec. 28, West half of Sec. 35), Virgil and Valley View CCC and Elgin Mental Health Center.

The following list is considered as those days for which holiday rates of wages for work performed apply: New Years Day, Memorial Day, Fourth of July, Labor Day, Thanksgiving Day, Christmas Day and Veterans Day in some classifications/counties. Generally, any of these holidays which fall on a Sunday is celebrated on the following Monday. This then makes work performed on that Monday payable at the appropriate overtime rate for holiday pay. Common practice in a given local may alter certain days of celebration. If in doubt, please check with IDOL.

EXPLANATION OF CLASSES

ASBESTOS - GENERAL - removal of asbestos material/mold and hazardous materials from any place in a building, including mechanical systems where those mechanical systems are to be removed. This includes the removal of asbestos materials/mold and hazardous materials from ductwork or pipes in a building when the building is to be demolished at the time or at some close future date.

ASBESTOS - MECHANICAL - removal of asbestos material from mechanical

systems, such as pipes, ducts, and boilers, where the mechanical systems are to remain.

CERAMIC TILE FINISHER

The grouting, cleaning, and polishing of all classes of tile, whether for interior or exterior purposes, all burned, glazed or unglazed products; all composition materials, granite tiles, warning detectable tiles, cement tiles, epoxy composite materials, pavers, glass, mosaics, fiberglass, and all substitute materials, for tile made in tile-like units; all mixtures in tile like form of cement, metals, and other materials that are for and intended for use as a finished floor surface, stair treads, promenade roofs, walks, walls, ceilings, swimming pools, and all other places where tile is to form a finished interior or exterior. The mixing of all setting mortars including but not limited to thin-set mortars, epoxies, wall mud, and any other sand and cement mixtures or adhesives when used in the preparation, installation, repair, or maintenance of tile and/or similar materials. The handling and unloading of all sand, cement, lime, tile, fixtures, equipment, adhesives, or any other materials to be used in the preparation, installation, repair, or maintenance of tile and/or similar materials. Ceramic Tile Finishers shall fill all joints and voids regardless of method on all tile work, particularly and especially after installation of said tile work. Application of any and all protective coverings to all types of tile installations including, but not be limited to, all soap compounds, paper products, tapes, and all polyethylene coverings, plywood, masonite, cardboard, and any new type of products that may be used to protect tile installations, Blastrac equipment, and all floor scarifying equipment used in preparing floors to receive tile. The clean up and removal of all waste and materials. All demolition of existing tile floors and walls to be re-tiled.

COMMUNICATIONS TECHNICIAN

Construction, installation, maintenance and removal of telecommunication facilities (voice, sound, data and video), telephone, security systems, fire alarm systems that are a component of a multiplex system and share a common cable, and data inside wire, interconnect, terminal equipment, central offices, PABX and equipment, micro waves, V-SAT, bypass, CATV, WAN (wide area network), LAN (local area networks), and ISDN (integrated system digital network), pulling of wire in raceways, but not the installation of raceways.

MARBLE FINISHER

Loading and unloading trucks, distribution of all materials (all stone, sand, etc.), stocking of floors with material, performing all rigging for heavy work, the handling of all material that may be needed for the installation of such materials, building of scaffolding, polishing if needed, patching, waxing of material if damaged, pointing up, caulking, grouting and cleaning of marble, holding water on diamond or Carborundum blade or saw for setters cutting, use of tub saw or any other saw needed for preparation of material, drilling of holes for wires that anchor material set by setters, mixing up of molding plaster for installation of material, mixing up thin set for the installation of material, mixing up of sand to cement for the installation of material and such other work as may be required in helping a Marble Setter in the handling of all material in the erection or installation of interior marble, slate, travertine, art marble, serpentine, alberene stone, blue stone, granite and other stones (meaning as to stone any foreign or domestic materials as are specified and used in building interiors and exteriors and customarily known as stone in the trade), carrara,

sanionyx, vitrolite and similar opaque glass and the laying of all marble tile, terrazzo tile, slate tile and precast tile, steps, risers treads, base, or any other materials that may be used as substitutes for any of the aforementioned materials and which are used on interior and exterior which are installed in a similar manner.

MATERIAL TESTER I: Hand coring and drilling for testing of materials; field inspection of uncured concrete and asphalt.

MATERIAL TESTER II: Field inspection of welds, structural steel, fireproofing, masonry, soil, facade, reinforcing steel, formwork, cured concrete, and concrete and asphalt batch plants; adjusting proportions of bituminous mixtures.

OPERATING ENGINEER - BUILDING

Class 1. Asphalt Plant; Asphalt Spreader; Autograde; Backhoes with Caisson Attachment; Batch Plant; Benoto (requires Two Engineers); Boiler and Throttle Valve; Caisson Rigs; Central Redi-Mix Plant; Combination Back Hoe Front End-loader Machine; Compressor and Throttle Valve; Concrete Breaker (Truck Mounted); Concrete Conveyor; Concrete Conveyor (Truck Mounted); Concrete Paver Over 27E cu. ft; Concrete Paver 27E cu. ft. and Under; Concrete Placer; Concrete Placing Boom; Concrete Pump (Truck Mounted); Concrete Tower; Cranes, All; Cranes, Hammerhead; Cranes, (GCI and similar Type); Creter Crane; Spider Crane; Crusher, Stone, etc.; Derricks, All; Derricks, Traveling; Formless Curb and Gutter Machine; Grader, Elevating; Grouting Machines; Heavy Duty Self-Propelled Transporter or Prime Mover; Highlift Shovels or Front Endloader 2-1/4 yd. and over; Hoists, Elevators, outside type rack and pinion and similar machines; Hoists, One, Two and Three Drum; Hoists, Two Tugger One Floor; Hydraulic Backhoes; Hydraulic Boom Trucks; Hydro Vac (and similar equipment); Locomotives, All; Motor Patrol; Lubrication Technician; Manipulators; Pile Drivers and Skid Rig; Post Hole Digger; Pre-Stress Machine; Pump Cretes Dual Ram; Pump Cretes: Squeeze Cretes-Screw Type Pumps; Gypsum Bulker and Pump; Raised and Blind Hole Drill; Roto Mill Grinder; Scoops - Tractor Drawn; Slip-Form Paver; Straddle Buggies; Operation of Tie Back Machine; Tournapull; Tractor with Boom and Side Boom; Trenching Machines.

Class 2. Boilers; Broom, All Power Propelled; Bulldozers; Concrete Mixer (Two Bag and Over); Conveyor, Portable; Forklift Trucks; Highlift Shovels or Front Endloaders under 2-1/4 yd.; Hoists, Automatic; Hoists, Inside Elevators; Hoists, Sewer Dragging Machine; Hoists, Tugger Single Drum; Laser Screed; Rock Drill (Self-Propelled); Rock Drill (Truck Mounted); Rollers, All; Steam Generators; Tractors, All; Tractor Drawn Vibratory Roller; Winch Trucks with "A" Frame.

Class 3. Air Compressor; Combination Small Equipment Operator; Generators; Heaters, Mechanical; Hoists, Inside Elevators (remodeling or renovation work); Hydraulic Power Units (Pile Driving, Extracting, and Drilling); Pumps, over 3" (1 to 3 not to exceed a total of 300 ft.); Low Boys; Pumps, Well Points; Welding Machines (2 through 5); Winches, 4 Small Electric Drill Winches.

Class 4. Bobcats and/or other Skid Steer Loaders; Oilers; and Brick Forklift.

Class 5. Assistant Craft Foreman.

Class 6. Gradall.

Class 7. Mechanics; Welders.

OPERATING ENGINEERS - HIGHWAY CONSTRUCTION

Class 1. Asphalt Plant; Asphalt Heater and Planer Combination; Asphalt Heater Scarfire; Asphalt Spreader; Autograder/GOMACO or other similar type machines: ABG Paver; Backhoes with Caisson Attachment; Ballast Regulator; Belt Loader; Caisson Rigs; Car Dumper; Central Redi-Mix Plant; Combination Backhoe Front Endloader Machine, (1 cu. yd. Backhoe Bucket or over or with attachments); Concrete Breaker (Truck Mounted); Concrete Conveyor; Concrete Paver over 27E cu. ft.; Concrete Placer; Concrete Tube Float; Cranes, all attachments; Cranes, Tower Cranes of all types: Creter Crane; Spider Crane; Crusher, Stone, etc.; Derricks, All; Derrick Boats; Derricks, Traveling; Dredges; Elevators, Outside type Rack & Pinion and Similar Machines; Formless Curb and Gutter Machine; Grader, Elevating; Grader, Motor Grader, Motor Patrol, Auto Patrol, Form Grader, Pull Grader, Subgrader; Guard Rail Post Driver Truck Mounted; Hoists, One, Two and Three Drum; Heavy Duty Self-Propelled Transporter or Prime Mover; Hydraulic Backhoes; Backhoes with shear attachments up to 40' of boom reach; Lubrication Technician; Manipulators; Mucking Machine; Pile Drivers and Skid Rig; Pre-Stress Machine; Pump Cretes Dual Ram; Rock Drill - Crawler or Skid Rig; Rock Drill - Truck Mounted; Rock/Track Tamper; Roto Mill Grinder; Slip-Form Paver; Snow Melters; Soil Test Drill Rig (Truck Mounted); Straddle Buggies; Hydraulic Telescoping Form (Tunnel); Operation of Tieback Machine; Tractor Drawn Belt Loader; Tractor Drawn Belt Loader (with attached pusher - two engineers); Tractor with Boom; Tractaire with Attachments; Traffic Barrier Transfer Machine; Trenching; Truck Mounted Concrete Pump with Boom; Raised or Blind Hole Drills (Tunnel Shaft); Underground Boring and/or Mining Machines 5 ft. in diameter and over tunnel, etc; Underground Boring and/or Mining Machines under 5 ft. in diameter; Wheel Excavator; Widener (APSCO).

Class 2. Batch Plant; Bituminous Mixer; Boiler and Throttle Valve; Bulldozers; Car Loader Trailing Conveyors; Combination Backhoe Front Endloader Machine (Less than 1 cu. yd. Backhoe Bucket or over or with attachments); Compressor and Throttle Valve; Compressor, Common Receiver (3); Concrete Breaker or Hydro Hammer; Concrete Grinding Machine; Concrete Mixer or Paver 7S Series to and including 27 cu. ft.; Concrete Spreader; Concrete Curing Machine, Burlap Machine, Belting Machine and Sealing Machine; Concrete Wheel Saw; Conveyor Muck Cars (Haglund or Similar Type); Drills, All; Finishing Machine - Concrete; Highlift Shovels or Front Endloader; Hoist - Sewer Dragging Machine; Hydraulic Boom Trucks (All Attachments); Hydro-Blaster; Hydro Excavating (excluding hose work); Laser Screed; All Locomotives, Dinky; Off-Road Hauling Units (including articulating) Non Self-Loading Ejection Dump; Pump Cretes: Squeeze Cretes - Screw Type Pumps, Gypsum Bulker and Pump; Roller, Asphalt; Rotary Snow Plows; Rototiller, Seaman, etc., self-propelled; Self-Propelled Compactor; Spreader - Chip - Stone, etc.; Scraper - Single/Twin Engine/Push and Pull; Scraper - Prime Mover in Tandem (Regardless of Size); Tractors pulling attachments, Sheeps Foot, Disc, Compactor, etc.; Tug Boats.

Class 3. Boilers; Brooms, All Power Propelled; Cement Supply Tender; Compressor, Common Receiver (2); Concrete Mixer (Two Bag and Over); Conveyor, Portable; Farm-Type Tractors Used for Mowing, Seeding, etc.; Forklift Trucks; Grouting Machine; Hoists, Automatic; Hoists, All Elevators; Hoists, Tugger Single Drum; Jeep Diggers; Low Boys; Pipe Jacking Machines; Post-Hole Digger; Power Saw, Concrete Power Driven; Pug Mills; Rollers, other than Asphalt; Seed and Straw Blower; Steam Generators; Stump Machine; Winch Trucks with "A" Frame; Work Boats; Tamper-Form-Motor Driven.

Class 4. Air Compressor; Combination - Small Equipment Operator; Directional Boring Machine; Generators; Heaters, Mechanical; Hydraulic Power Unit (Pile Driving, Extracting, or Drilling); Light Plants, All (1 through 5); Pumps, over 3" (1 to 3 not to exceed a total of 300

ft.); Pumps, Well Points; Vacuum Trucks (excluding hose work); Welding Machines (2 through 5); Winches, 4 Small Electric Drill Winches.

Class 5. SkidSteer Loader (all); Brick Forklifts; Oilers.

Class 6. Field Mechanics and Field Welders

Class 7. Dowell Machine with Air Compressor; Gradall and machines of like nature.

TRAFFIC SAFETY - work associated with barricades, horses and drums used to reduce lane usage on highway work, the installation and removal of temporary lane markings, and the installation and removal of temporary road signs.

TRUCK DRIVER - BUILDING, HEAVY AND HIGHWAY CONSTRUCTION

Class 1. Two or three Axle Trucks. A-frame Truck when used for transportation purposes; Air Compressors and Welding Machines, including those pulled by cars, pick-up trucks and tractors; Ambulances; Batch Gate Lockers; Batch Hopperman; Car and Truck Washers; Carry-alls; Fork Lifts and Hoisters; Helpers; Mechanics Helpers and Greasers; Oil Distributors 2-man operation; Pavement Breakers; Pole Trailer, up to 40 feet; Power Mower Tractors; Self-propelled Chip Spreader; Skipman; Slurry Trucks, 2-man operation; Slurry Truck Conveyor Operation, 2 or 3 man; Teamsters; Unskilled Dumpman; and Truck Drivers hauling warning lights, barricades, and portable toilets on the job site.

Class 2. Four axle trucks; Dump Crets and Adgetors under 7 yards; Dumpsters, Track Trucks, Euclids, Hug Bottom Dump Turnapulls or Turnatrailers when pulling other than self-loading equipment or similar equipment under 16 cubic yards; Mixer Trucks under 7 yards; Ready-mix Plant Hopper Operator, and Winch Trucks, 2 Axles.

Class 3. Five axle trucks; Dump Crets and Adgetors 7 yards and over; Dumpsters, Track Trucks, Euclids, Hug Bottom Dump Turnatrailers or turnapulls when pulling other than self-loading equipment or similar equipment over 16 cubic yards; Explosives and/or Fission Material Trucks; Mixer Trucks 7 yards or over; Mobile Cranes while in transit; Oil Distributors, 1-man operation; Pole Trailer, over 40 feet; Pole and Expandable Trailers hauling material over 50 feet long; Slurry trucks, 1-man operation; Winch trucks, 3 axles or more; Mechanic--Truck Welder and Truck Painter.

Class 4. Six axle trucks; Dual-purpose vehicles, such as mounted crane trucks with hoist and accessories; Foreman; Master Mechanic; Self-loading equipment like P.B. and trucks with scoops on the front.

TERRAZZO FINISHER

The handling of sand, cement, marble chips, and all other materials that may be used by the Mosaic Terrazzo Mechanic, and the mixing, grinding, grouting, cleaning and sealing of all Marble, Mosaic, and Terrazzo work, floors, base, stairs, and wainscoting by hand or machine, and in addition, assisting and aiding Marble, Masonic, and Terrazzo Mechanics.

Other Classifications of Work:

For definitions of classifications not otherwise set out, the Department generally has on file such definitions which are available.

If a task to be performed is not subject to one of the classifications of pay set out, the Department will upon being contacted state which neighboring county has such a classification and provide such rate, such rate being deemed to exist by reference in this document. If no neighboring county rate applies to the task, the Department shall undertake a special determination, such special determination being then deemed to have existed under this determination. If a project requires these, or any classification not listed, please contact IDOL at 217-782-1710 for wage rates or clarifications.

LANDSCAPING

Landscaping work falls under the existing classifications for laborer, operating engineer and truck driver. The work performed by landscape plantsman and landscape laborer is covered by the existing classification of laborer. The work performed by landscape operators (regardless of equipment used or its size) is covered by the classifications of operating engineer. The work performed by landscape truck drivers (regardless of size of truck driven) is covered by the classifications of truck driver.

Kankakee County Prevailing Wage for May 2013

(See explanation of column headings at bottom of wages)

Trade Name	RG	TYP	C	Base	FRMAN	M-F>8	OSA	OSH	H/W	Pensn	Vac	Trng
ASBESTOS ABT-GEN		BLD		32.910	33.910	1.5	1.5	2.0	8.240	12.26	0.000	0.800
ASBESTOS ABT-GEN		HWY		34.160	35.160	1.5	1.5	2.0	8.240	11.62	0.000	0.800
ASBESTOS ABT-MEC		BLD		34.160	36.660	1.5	1.5	2.0	10.82	10.66	0.000	0.720
BOILERMAKER		BLD		43.450	47.360	2.0	2.0	2.0	6.970	14.66	0.000	0.350
BRICK MASON		BLD		40.000	42.000	1.5	1.5	2.0	7.700	10.42	0.000	0.610
CARPENTER		BLD		35.390	37.390	1.5	1.5	2.0	10.00	13.15	0.000	0.530
CARPENTER		HWY		34.690	36.690	1.5	1.5	2.0	10.00	13.15	0.000	0.530
CEMENT MASON		BLD		40.000	42.000	1.5	1.5	2.0	7.700	10.42	0.000	0.610
CERAMIC TILE FNSHER		BLD		36.000	0.000	1.5	1.5	2.0	7.700	10.42	0.000	0.610
COMMUNICATION TECH		BLD		31.200	32.700	1.5	1.5	2.0	12.32	10.77	0.000	0.320
ELECTRIC PWR EQMT OP		ALL		43.350	48.350	1.5	1.5	2.0	10.38	13.50	0.000	0.430
ELECTRIC PWR GRNDMAN		ALL		33.810	48.350	1.5	1.5	2.0	8.090	10.53	0.000	0.330
ELECTRIC PWR LINEMAN		ALL		43.350	48.350	1.5	1.5	2.0	10.38	13.50	0.000	0.430
ELECTRICIAN		BLD		39.100	42.620	1.5	1.5	2.0	13.17	15.10	0.000	1.200
ELEVATOR CONSTRUCTOR		BLD		40.520	45.585	2.0	2.0	2.0	11.88	12.71	3.240	0.600
GLAZIER		BLD		39.500	41.000	1.5	2.0	2.0	11.99	14.30	0.000	0.840
HT/FROST INSULATOR		BLD		45.550	48.050	1.5	1.5	2.0	10.82	11.86	0.000	0.720
IRON WORKER		ALL		39.500	43.450	2.0	2.0	2.0	9.390	18.98	0.000	0.700
LABORER		BLD		31.910	32.910	1.5	1.5	2.0	8.240	12.26	0.000	0.800
LABORER		HWY		33.160	34.160	1.5	1.5	2.0	8.240	11.62	0.000	0.800
LABORER, SKILLED		BLD		31.910	32.910	1.5	1.5	2.0	8.240	12.26	0.000	0.800
LABORER, SKILLED		HWY		33.160	34.160	1.5	1.5	2.0	8.240	11.62	0.000	0.800
LATHER		BLD		35.390	37.390	1.5	1.5	2.0	10.00	13.15	0.000	0.530
MACHINIST		BLD		43.550	46.050	1.5	1.5	2.0	6.130	8.950	1.850	0.000
MARBLE FINISHERS		BLD		36.000	0.000	1.5	1.5	2.0	7.700	10.42	0.000	0.610
MARBLE MASON		BLD		40.000	42.000	1.5	1.5	2.0	7.700	10.42	0.000	0.610
MATERIAL TESTER I		ALL		21.550	0.000	1.5	1.5	2.0	7.460	4.840	0.000	0.170
MATERIALS TESTER II		ALL		26.550	0.000	1.5	1.5	2.0	7.460	4.840	0.000	0.170
MILLWRIGHT		BLD		35.390	37.390	1.5	1.5	2.0	10.00	13.15	0.000	0.530
OPERATING ENGINEER		BLD 1		45.100	49.100	2.0	2.0	2.0	15.70	10.55	1.900	1.250
OPERATING ENGINEER		BLD 2		43.800	49.100	2.0	2.0	2.0	15.70	10.55	1.900	1.250
OPERATING ENGINEER		BLD 3		41.250	49.100	2.0	2.0	2.0	15.70	10.55	1.900	1.250
OPERATING ENGINEER		BLD 4		39.500	49.100	2.0	2.0	2.0	15.70	10.55	1.900	1.250
OPERATING ENGINEER		BLD 5		48.850	49.100	2.0	2.0	2.0	15.70	10.55	1.900	1.250
OPERATING ENGINEER		BLD 6		46.100	49.100	2.0	2.0	2.0	15.70	10.55	1.900	1.250
OPERATING ENGINEER		BLD 7		48.100	49.100	2.0	2.0	2.0	15.70	10.55	1.900	1.250

OPERATING ENGINEER	HWY 1	43.300	47.300	1.5	1.5	2.0	15.70	10.55	1.900	1.250
OPERATING ENGINEER	HWY 2	42.750	47.300	1.5	1.5	2.0	15.70	10.55	1.900	1.250
OPERATING ENGINEER	HWY 3	40.700	47.300	1.5	1.5	2.0	15.70	10.55	1.900	1.250
OPERATING ENGINEER	HWY 4	39.300	47.300	1.5	1.5	2.0	15.70	10.55	1.900	1.250
OPERATING ENGINEER	HWY 5	38.100	47.300	1.5	1.5	2.0	15.70	10.55	1.900	1.250
OPERATING ENGINEER	HWY 6	46.300	47.300	1.5	1.5	2.0	15.70	10.55	1.900	1.250
OPERATING ENGINEER	HWY 7	44.300	47.300	1.5	1.5	2.0	15.70	10.55	1.900	1.250
PAINTER	ALL	32.900	34.900	1.5	1.5	1.5	9.650	8.200	0.000	1.250
PAINTER SIGNS	BLD	33.920	38.090	1.5	1.5	1.5	2.600	2.710	0.000	0.000
PILEDRIIVER	BLD	35.390	37.390	1.5	1.5	2.0	10.00	13.15	0.000	0.530
PIPEFITTER	BLD	45.050	48.050	1.5	1.5	2.0	8.460	14.85	0.000	1.780
PLASTERER	BLD	40.000	42.000	1.5	1.5	2.0	7.700	10.42	0.000	0.610
PLUMBER	BLD	43.760	45.760	1.5	1.5	2.0	12.53	10.06	0.000	0.880
ROOFER	BLD	38.350	41.350	1.5	1.5	2.0	8.280	8.770	0.000	0.430
SHEETMETAL WORKER	BLD	42.510	44.510	1.5	1.5	2.0	10.04	12.01	0.000	0.780
SIGN HANGER	BLD	35.390	37.390	1.5	1.5	2.0	10.00	13.15	0.000	0.530
SPRINKLER FITTER	BLD	36.390	39.140	1.5	1.5	2.0	8.420	8.500	0.000	0.450
TERRAZZO FINISHER	BLD	36.000	0.000	1.5	1.5	2.0	7.700	10.42	0.000	0.610
TERRAZZO MASON	BLD	40.000	42.000	1.5	1.5	2.0	7.700	10.42	0.000	0.610
TILE MASON	BLD	40.000	42.000	1.5	1.5	2.0	7.700	10.42	0.000	0.610
TRUCK DRIVER	ALL 1	33.410	33.960	1.5	1.5	2.0	8.040	5.610	0.000	0.250
TRUCK DRIVER	ALL 2	33.610	33.960	1.5	1.5	2.0	8.040	5.610	0.000	0.250
TRUCK DRIVER	ALL 3	33.810	33.960	1.5	1.5	2.0	8.040	5.610	0.000	0.250
TRUCK DRIVER	ALL 4	33.960	33.960	1.5	1.5	2.0	8.040	5.610	0.000	0.250
TUCKPOINTER	BLD	39.000	41.000	1.5	1.5	2.0	7.400	9.760	0.000	0.580

Legend :

RG (Region)

TYP (Trade Type - All,Highway,Building,Floating,Oil & Chip,Rivers)

C (Class)

Base (Base Wage Rate)

FRMAN (Foreman Rate)

M-F>8 (OT required for any hour greater than 8 worked each day, Mon through Fri.)

OSA (Overtime (OT) is required for every hour worked on Saturday)

OSH (Overtime is required for every hour worked on Sunday and Holidays)

H/W (Health & Welfare Insurance)

Pensn (Pension)

Vac (Vacation)

Trng (Training)

Explanations

KANKAKEE COUNTY

The following list is considered as those days for which holiday rates of wages for work performed apply: New Years Day, Memorial Day, Fourth of July, Labor Day, Thanksgiving Day, Christmas Day and Veterans Day in some classifications/counties. Generally, any of these holidays which fall on a Sunday is celebrated on the following

Monday. This then makes work performed on that Monday payable at the appropriate overtime rate for holiday pay. Common practice in a given local may alter certain days of celebration. If in doubt, please check with IDOL.

EXPLANATION OF CLASSES

ASBESTOS - GENERAL - removal of asbestos material/mold and hazardous materials from any place in a building, including mechanical systems where those mechanical systems are to be removed. This includes the removal of asbestos materials/mold and hazardous materials from ductwork or pipes in a building when the building is to be demolished at the time or at some close future date.

ASBESTOS - MECHANICAL - removal of asbestos material from mechanical systems, such as pipes, ducts, and boilers, where the mechanical systems are to remain.

CERAMIC TILE FINISHER, MARBLE FINISHER, AND TERRAZZO FINISHER

The laying, setting and finishing of all tile where used for floors, walls, ceilings, walks, promenade roofs, stair treads, stair risers, facings, hearths, fireplaces, and decorative inserts, together with any marble plinths, thresholds or window stools used in connection with any tile work; also to prepare and set all concrete, cement, brickwork, or other foundation or materials that may be required to properly set and complete such work; the setting or bedding of all tiling, stone, marble, composition, glass, mosaic, or other materials forming the facing, hearth or fireplace of a mantle, or the mantle complete, together with the setting of all cement, brickwork, or other material required in connection with the above work; also the slabbing and fabrication of tile mantels, counters and tile panels of every description and the erection and installation of same and the building, shaping, forming, construction, or repairing of all fireplace work, whether in connection with the mantle hearth facing or not, and the setting and preparing of all material, such as cement, plaster, mortar, brickwork, iron work or other materials necessary for the proper and safe construction and completion of such work. The term "Ceramic" is used for naming the classification only and is in no way a limitation of the product handled. Ceramic takes into consideration most hard tiles.

COMMUNICATIONS TECHNICIAN

Installing, manufacturing, assembling and maintaining sound and intercom, protection alarm (security), fire alarm, master antenna television, closed circuit television, low voltage control for computers and/or door monitoring, school communications systems, telephones and servicing of nurse and emergency calls, and the installation and maintenance of transmit and receive antennas, transmitters, receivers, and associated apparatus which operates in conjunction with above systems. All work associated with these system installations will be included EXCEPT the installation of protective metallic conduit in new construction projects (excluding less than ten-foot, runs strictly for protection of cable) and 120 volt AC (or higher) power wiring and associated hardware.

LABORER, SKILLED - BUILDING

The skilled laborer building (BLD) classification shall encompass the following types of work, irrespective of the site of the work: caisson workers plus depth, gunnite nozzle men, lead man on sewer work, welders, cutters, burners and torchmen, chain saw operators, paving breaker, jackhammer and drill operators, layout man and/or drainage

tile layer, steel form setters - street and highway, air tamping hammerman, signal man on crane, concrete saw operator, screenman on asphalt pavers, front end man on chip spreader, laborers tending masons with hot materials or where foreign materials are used, multiple concrete duct-leadman, luteman, asphalt raker, curb asphalt machine operator, ready mix scalemen (permanent, portable or temporary plant), laborers handling masterplate or similar materials, laser beam operator, concrete burning machine operator, coring machine operator, plaster tenders, underpinning and shoring of buildings, material selector when working with fire-brick or castable material, fire watch, signaling of all power equipment, and tree topper or trimmer when in connection with construction.

LABORER, SKILLED - HIGHWAY

The skilled laborer heavy and highway (HWY) classification shall encompass the following types of work, irrespective of the site of the work: handling of materials treated with oil, creosote, asphalt and/or any foreign materials harmful to skin or clothing, track laborers, chloride handlers, the unloading and loading with steel workers and re-bars, concrete workers (wet), tunnel helpers in free air, batch dumpers, mason tenders, kettle and tar men, plastic installers, scaffold workers, motorized buggies or motorized unit used for wet concrete or handling of building materials, laborers with de-watering systems, sewer workers plus depth, rod and chainmen, vibrator operators, mortar mixer operators, cement silica, clay, fly ash, lime and plasters, handlers (bulk or bag), cofferdam workers plus depth, on concrete paving, placing, cutting and tying or reinforcing, deck hand, dredge hand shore laborers, bankmen on floating plant, asphalt workers with machine, and layers, grade checker, power tools, stripping of all concrete forms excluding paving forms, dumpmen and spotters, when necessary, caisson workers plus depth, gunnite nozzle men, welders, cutters, burners and torchmen, chain saw operators, paving breaker, jackhammer and drill operators, layout man and/or drainage tile layer, steel form setters - street and highway, air tamping hammerman, signal man on crane, concrete saw operator, screedman on asphalt pavers, front end man on chip spreader, multiple concrete duct, luteman, asphalt raker, curb asphalt machine operator, ready mix scalemen (portable or temporary plant), laser beam operator, concrete burning machine operator, and coring machine operator.

MATERIAL TESTER I: Hand coring and drilling for testing of materials; field inspection of uncured concrete and asphalt.

MATERIAL TESTER II: Field inspection of welds, structural steel, fireproofing, masonry, soil, facade, reinforcing steel, formwork, cured concrete, and concrete and asphalt batch plants; adjusting proportions of bituminous mixtures.

OPERATING ENGINEER - BUILDING

Class 1. Asphalt Plant; Asphalt Spreader; Autograde; Backhoes with Caisson Attachment; Batch Plant; Benoto (requires Two Engineers); Boiler and Throttle Valve; Caisson Rigs; Central Redi-Mix Plant; Combination Back Hoe Front End-loader Machine; Compressor and Throttle Valve; Concrete Breaker (Truck Mounted); Concrete Conveyor; Concrete Conveyor (Truck Mounted); Concrete Paver Over 27E cu. ft; Concrete Paver 27E cu. ft. and Under; Concrete Placer; Concrete Placing Boom; Concrete Pump (Truck Mounted); Concrete Tower; Cranes, All; Cranes, Hammerhead; Cranes, (GCI and similar Type); Creter Crane; Spider Crane; Crusher, Stone, etc.; Derricks, All; Derricks, Traveling; Formless Curb and Gutter Machine; Grader, Elevating; Grouting Machines; Heavy Duty Self-Propelled Transporter or Prime Mover; Highlift Shovels or Front Endloader 2-1/4 yd. and over; Hoists,

Elevators, outside type rack and pinion and similar machines; Hoists, One, Two and Three Drum; Hoists, Two Tugger One Floor; Hydraulic Backhoes; Hydraulic Boom Trucks; Hydro Vac (and similar equipment); Locomotives, All; Motor Patrol; Lubrication Technician; Manipulators; Pile Drivers and Skid Rig; Post Hole Digger; Pre-Stress Machine; Pump Cretes Dual Ram; Pump Cretes: Squeeze Cretes-Screw Type Pumps; Gypsum Bulker and Pump; Raised and Blind Hole Drill; Roto Mill Grinder; Scoops - Tractor Drawn; Slip-Form Paver; Straddle Buggies; Operation of Tie Back Machine; Tournapull; Tractor with Boom and Side Boom; Trenching Machines.

Class 2. Boilers; Broom, All Power Propelled; Bulldozers; Concrete Mixer (Two Bag and Over); Conveyor, Portable; Forklift Trucks; Highlift Shovels or Front Endloaders under 2-1/4 yd.; Hoists, Automatic; Hoists, Inside Elevators; Hoists, Sewer Dragging Machine; Hoists, Tugger Single Drum; Laser Screed; Rock Drill (Self-Propelled); Rock Drill (Truck Mounted); Rollers, All; Steam Generators; Tractors, All; Tractor Drawn Vibratory Roller; Winch Trucks with "A" Frame.

Class 3. Air Compressor; Combination Small Equipment Operator; Generators; Heaters, Mechanical; Hoists, Inside Elevators (remodeling or renovation work); Hydraulic Power Units (Pile Driving, Extracting, and Drilling); Pumps, over 3" (1 to 3 not to exceed a total of 300 ft.); Low Boys; Pumps, Well Points; Welding Machines (2 through 5); Winches, 4 Small Electric Drill Winches.

Class 4. Bobcats and/or other Skid Steer Loaders; Oilers; and Brick Forklift.

Class 5. Assistant Craft Foreman.

Class 6. Gradall.

Class 7. Mechanics; Welders.

OPERATING ENGINEERS - HIGHWAY CONSTRUCTION

Class 1. Asphalt Plant; Asphalt Heater and Planer Combination; Asphalt Heater Scarfire; Asphalt Spreader; Autograder/GOMACO or other similar type machines: ABG Paver; Backhoes with Caisson Attachment; Ballast Regulator; Belt Loader; Caisson Rigs; Car Dumper; Central Redi-Mix Plant; Combination Backhoe Front Endloader Machine, (1 cu. yd. Backhoe Bucket or over or with attachments); Concrete Breaker (Truck Mounted); Concrete Conveyor; Concrete Paver over 27E cu. ft.; Concrete Placer; Concrete Tube Float; Cranes, all attachments; Cranes, Tower Cranes of all types: Creter Crane; Spider Crane; Crusher, Stone, etc.; Derricks, All; Derrick Boats; Derricks, Traveling; Dredges; Elevators, Outside type Rack & Pinion and Similar Machines; Formless Curb and Gutter Machine; Grader, Elevating; Grader, Motor Grader, Motor Patrol, Auto Patrol, Form Grader, Pull Grader, Subgrader; Guard Rail Post Driver Truck Mounted; Hoists, One, Two and Three Drum; Heavy Duty Self-Propelled Transporter or Prime Mover; Hydraulic Backhoes; Backhoes with shear attachments up to 40' of boom reach; Lubrication Technician; Manipulators; Mucking Machine; Pile Drivers and Skid Rig; Pre-Stress Machine; Pump Cretes Dual Ram; Rock Drill - Crawler or Skid Rig; Rock Drill - Truck Mounted; Rock/Track Tamper; Roto Mill Grinder; Slip-Form Paver; Snow Melters; Soil Test Drill Rig (Truck Mounted); Straddle Buggies; Hydraulic Telescoping Form (Tunnel); Operation of Tieback Machine; Tractor Drawn Belt Loader; Tractor Drawn Belt Loader (with attached pusher - two engineers); Tractor with Boom; Tractaire with Attachments; Traffic Barrier Transfer Machine; Trenching; Truck Mounted Concrete Pump with Boom; Raised or Blind Hole Drills (Tunnel Shaft); Underground Boring and/or Mining Machines 5 ft. in diameter and over tunnel, etc; Underground Boring and/or Mining

Machines under 5 ft. in diameter; Wheel Excavator; Widener (APSCO).

Class 2. Batch Plant; Bituminous Mixer; Boiler and Throttle Valve; Bulldozers; Car Loader Trailing Conveyors; Combination Backhoe Front Endloader Machine (Less than 1 cu. yd. Backhoe Bucket or over or with attachments); Compressor and Throttle Valve; Compressor, Common Receiver (3); Concrete Breaker or Hydro Hammer; Concrete Grinding Machine; Concrete Mixer or Paver 7S Series to and including 27 cu. ft.; Concrete Spreader; Concrete Curing Machine, Burlap Machine, Belting Machine and Sealing Machine; Concrete Wheel Saw; Conveyor Muck Cars (Haglund or Similar Type); Drills, All; Finishing Machine - Concrete; Highlift Shovels or Front Endloader; Hoist - Sewer Dragging Machine; Hydraulic Boom Trucks (All Attachments); Hydro-Blaster; Hydro Excavating (excluding hose work); Laser Screed; All Locomotives, Dinky; Off-Road Hauling Units (including articulating) Non Self-Loading Ejection Dump; Pump Cretes: Squeeze Cretes - Screw Type Pumps, Gypsum Bulker and Pump; Roller, Asphalt; Rotary Snow Plows; Rototiller, Seaman, etc., self-propelled; Self-Propelled Compactor; Spreader - Chip - Stone, etc.; Scraper - Single/Twin Engine/Push and Pull; Scraper - Prime Mover in Tandem (Regardless of Size); Tractors pulling attachments, Sheeps Foot, Disc, Compactor, etc.; Tug Boats.

Class 3. Boilers; Brooms, All Power Propelled; Cement Supply Tender; Compressor, Common Receiver (2); Concrete Mixer (Two Bag and Over); Conveyor, Portable; Farm-Type Tractors Used for Mowing, Seeding, etc.; Forklift Trucks; Grouting Machine; Hoists, Automatic; Hoists, All Elevators; Hoists, Tugger Single Drum; Jeep Diggers; Low Boys; Pipe Jacking Machines; Post-Hole Digger; Power Saw, Concrete Power Driven; Pug Mills; Rollers, other than Asphalt; Seed and Straw Blower; Steam Generators; Stump Machine; Winch Trucks with "A" Frame; Work Boats; Tamper-Form-Motor Driven.

Class 4. Air Compressor; Combination - Small Equipment Operator; Directional Boring Machine; Generators; Heaters, Mechanical; Hydraulic Power Unit (Pile Driving, Extracting, or Drilling); Light Plants, All (1 through 5); Pumps, over 3" (1 to 3 not to exceed a total of 300 ft.); Pumps, Well Points; Vacuum Trucks (excluding hose work); Welding Machines (2 through 5); Winches, 4 Small Electric Drill Winches.

Class 5. SkidSteer Loader (all); Brick Forklifts; Oilers.

Class 6. Field Mechanics and Field Welders

Class 7. Dowell Machine with Air Compressor; Gradall and machines of like nature.

TRUCK DRIVER - BUILDING, HEAVY AND HIGHWAY CONSTRUCTION

Class 1. Two or three Axle Trucks. A-frame Truck when used for transportation purposes; Air Compressors and Welding Machines, including those pulled by cars, pick-up trucks and tractors; Ambulances; Batch Gate Lockers; Batch Hopperman; Car and Truck Washers; Carry-alls; Fork Lifts and Hoisters; Helpers; Mechanics Helpers and Greasers; Oil Distributors 2-man operation; Pavement Breakers; Pole Trailer, up to 40 feet; Power Mower Tractors; Self-propelled Chip Spreader; Skipman; Slurry Trucks, 2-man operation; Slurry Truck Conveyor Operation, 2 or 3 man; Teamsters; Unskilled dumpman; and Truck Drivers hauling warning lights, barricades, and portable toilets on the job site.

Class 2. Four axle trucks; Dump Crets and Adgetors under 7 yards; Dumpsters, Track Trucks, Euclids, Hug Bottom Dump Turnapulls or Turnatrailers when pulling other than self-loading equipment or similar equipment under 16 cubic yards; Mixer Trucks under 7 yards; Ready-mix Plant Hopper Operator, and Winch Trucks, 2 Axles.

Class 3. Five axle trucks; Dump Crets and Adgetors 7 yards and over; Dumpsters, Track Trucks, Euclids, Hug Bottom Dump Turnatrailers or turnapulls when pulling other than self-loading equipment or similar equipment over 16 cubic yards; Explosives and/or Fission Material Trucks; Mixer Trucks 7 yards or over; Mobile Cranes while in transit; Oil Distributors, 1-man operation; Pole Trailer, over 40 feet; Pole and Expandable Trailers hauling material over 50 feet long; Slurry trucks, 1-man operation; Winch trucks, 3 axles or more; Mechanic--Truck Welder and Truck Painter.

Class 4. Six axle trucks; Dual-purpose vehicles, such as mounted crane trucks with hoist and accessories; Foreman; Master Mechanic; Self-loading equipment like P.B. and trucks with scoops on the front.

Other Classifications of Work:

For definitions of classifications not otherwise set out, the Department generally has on file such definitions which are available. If a task to be performed is not subject to one of the classifications of pay set out, the Department will upon being contacted state which neighboring county has such a classification and provide such rate, such rate being deemed to exist by reference in this document. If no neighboring county rate applies to the task, the Department shall undertake a special determination, such special determination being then deemed to have existed under this determination. If a project requires these, or any classification not listed, please contact IDOL at 217-782-1710 for wage rates or clarifications.

LANDSCAPING

Landscaping work falls under the existing classifications for laborer, operating engineer and truck driver. The work performed by landscape plantsman and landscape laborer is covered by the existing classification of laborer. The work performed by landscape operators (regardless of equipment used or its size) is covered by the classifications of operating engineer. The work performed by landscape truck drivers (regardless of size of truck driven) is covered by the classifications of truck driver.

Kendall County Prevailing Wage for May 2013

(See explanation of column headings at bottom of wages)

Trade Name	RG	TYP	C	Base	FRMAN	M-F>8	OSA	OSH	H/W	Pensn	Vac	Trng
=====	==	===	=	=====	=====	=====	===	===	=====	=====	=====	=====
ASBESTOS ABT-GEN		ALL		36.200	36.700	1.5	1.5	2.0	12.78	9.020	0.000	0.500
ASBESTOS ABT-MEC		BLD		34.160	36.660	1.5	1.5	2.0	10.82	10.66	0.000	0.720
BOILERMAKER		BLD		43.450	47.360	2.0	2.0	2.0	6.970	14.66	0.000	0.350
BRICK MASON		BLD		40.680	44.750	1.5	1.5	2.0	9.550	12.00	0.000	0.970
CARPENTER		ALL		41.520	43.520	1.5	1.5	2.0	13.19	11.76	0.000	0.530
CEMENT MASON		ALL		41.550	43.550	2.0	1.5	2.0	9.500	13.76	0.000	0.500
CERAMIC TILE FNSHER		BLD		34.440	0.000	2.0	1.5	2.0	9.700	6.930	0.000	0.610
COMMUNICATION TECH		BLD		36.390	38.490	1.5	1.5	2.0	10.02	10.19	0.000	1.090
ELECTRIC PWR EQMT OP		ALL		36.610	49.750	1.5	1.5	2.0	5.000	11.35	0.000	0.270
ELECTRIC PWR GRNDMAN		ALL		28.310	49.750	1.5	1.5	2.0	5.000	8.780	0.000	0.210
ELECTRIC PWR LINEMAN		ALL		43.830	49.750	1.5	1.5	2.0	5.000	13.58	0.000	0.330
ELECTRIC PWR TRK DRV		ALL		29.310	49.750	1.5	1.5	2.0	5.000	9.090	0.000	0.220
ELECTRICIAN		BLD		43.560	47.920	1.5	1.5	2.0	10.02	12.20	0.000	1.310
ELEVATOR CONSTRUCTOR		BLD		49.080	55.215	2.0	2.0	2.0	11.88	12.71	3.930	0.600
FENCE ERECTOR		ALL		44.950	47.200	2.0	2.0	2.0	8.890	17.69	0.000	0.400
GLAZIER		BLD		39.500	41.000	1.5	2.0	2.0	11.99	14.30	0.000	0.840
HT/FROST INSULATOR		BLD		45.550	48.050	1.5	1.5	2.0	10.82	11.86	0.000	0.720

IRON WORKER	ALL	44.950	47.200	2.0	2.0	2.0	8.890	17.69	0.000	0.400
LABORER	ALL	36.200	36.950	1.5	1.5	2.0	12.52	9.280	0.000	0.500
LATHER	ALL	41.520	43.520	1.5	1.5	2.0	13.19	11.76	0.000	0.530
MACHINIST	BLD	43.550	46.050	1.5	1.5	2.0	6.130	8.950	1.850	0.000
MARBLE FINISHERS	ALL	29.700	0.000	1.5	1.5	2.0	9.550	11.75	0.000	0.620
MARBLE MASON	BLD	39.880	43.870	1.5	1.5	2.0	9.550	11.75	0.000	0.730
MATERIAL TESTER I	ALL	26.200	0.000	1.5	1.5	2.0	12.52	9.280	0.000	0.500
MATERIALS TESTER II	ALL	31.200	0.000	1.5	1.5	2.0	12.52	9.280	0.000	0.500
MILLWRIGHT	ALL	41.520	43.520	1.5	1.5	2.0	13.19	11.76	0.000	0.530
OPERATING ENGINEER	BLD 1	45.100	49.100	2.0	2.0	2.0	15.70	10.55	1.900	1.250
OPERATING ENGINEER	BLD 2	43.800	49.100	2.0	2.0	2.0	15.70	10.55	1.900	1.250
OPERATING ENGINEER	BLD 3	41.250	49.100	2.0	2.0	2.0	15.70	10.55	1.900	1.250
OPERATING ENGINEER	BLD 4	39.500	49.100	2.0	2.0	2.0	15.70	10.55	1.900	1.250
OPERATING ENGINEER	BLD 5	48.850	49.100	2.0	2.0	2.0	15.70	10.55	1.900	1.250
OPERATING ENGINEER	BLD 6	46.100	49.100	2.0	2.0	2.0	15.70	10.55	1.900	1.250
OPERATING ENGINEER	BLD 7	48.100	49.100	2.0	2.0	2.0	15.70	10.55	1.900	1.250
OPERATING ENGINEER	HWY 1	43.300	47.300	1.5	1.5	2.0	15.70	10.55	1.900	1.250
OPERATING ENGINEER	HWY 2	42.750	47.300	1.5	1.5	2.0	15.70	10.55	1.900	1.250
OPERATING ENGINEER	HWY 3	40.700	47.300	1.5	1.5	2.0	15.70	10.55	1.900	1.250
OPERATING ENGINEER	HWY 4	39.300	47.300	1.5	1.5	2.0	15.70	10.55	1.900	1.250
OPERATING ENGINEER	HWY 5	38.100	47.300	1.5	1.5	2.0	15.70	10.55	1.900	1.250
OPERATING ENGINEER	HWY 6	46.300	47.300	1.5	1.5	2.0	15.70	10.55	1.900	1.250
OPERATING ENGINEER	HWY 7	44.300	47.300	1.5	1.5	2.0	15.70	10.55	1.900	1.250
ORNAMNTL IRON WORKER	ALL	44.950	47.200	2.0	2.0	2.0	8.890	17.69	0.000	0.400
PAINTER	ALL	40.880	42.880	1.5	1.5	1.5	9.650	8.200	0.000	1.250
PAINTER SIGNS	BLD	33.920	38.090	1.5	1.5	1.5	2.600	2.710	0.000	0.000
PILEDRIIVER	ALL	41.520	43.520	1.5	1.5	2.0	13.19	11.76	0.000	0.530
PIPEFITTER	BLD	41.200	43.200	1.5	1.5	2.0	9.750	16.34	0.000	1.710
PLASTERER	BLD	40.250	42.670	1.5	1.5	2.0	10.85	10.94	0.000	0.550
PLUMBER	BLD	41.200	43.200	1.5	1.5	2.0	9.750	16.34	0.000	1.710
ROOFER	BLD	38.350	41.350	1.5	1.5	2.0	8.280	8.770	0.000	0.430
SHEETMETAL WORKER	BLD	42.510	44.510	1.5	1.5	2.0	10.04	12.01	0.000	0.780
SPRINKLER FITTER	BLD	49.200	51.200	1.5	1.5	2.0	10.25	8.350	0.000	0.450
STEEL ERECTOR	ALL	44.950	47.200	2.0	2.0	2.0	8.890	17.69	0.000	0.400
STONE MASON	BLD	40.680	44.750	1.5	1.5	2.0	9.550	12.00	0.000	0.970
TERRAZZO FINISHER	BLD	35.510	0.000	1.5	1.5	2.0	9.700	9.320	0.000	0.400
TERRAZZO MASON	BLD	39.370	42.370	1.5	1.5	2.0	9.700	10.66	0.000	0.550
TILE MASON	BLD	41.430	45.430	2.0	1.5	2.0	9.700	8.640	0.000	0.710
TRUCK DRIVER	ALL 1	35.650	36.200	1.5	1.5	2.0	7.250	6.319	0.000	0.250
TRUCK DRIVER	ALL 2	35.800	36.200	1.5	1.5	2.0	7.250	6.319	0.000	0.250
TRUCK DRIVER	ALL 3	36.000	36.200	1.5	1.5	2.0	7.250	6.319	0.000	0.250
TRUCK DRIVER	ALL 4	36.200	36.200	1.5	1.5	2.0	7.250	6.319	0.000	0.250
TUCKPOINTER	BLD	40.950	41.950	1.5	1.5	2.0	8.180	10.82	0.000	0.940

Legend :

RG (Region)

TYP (Trade Type - All,Highway,Building,Floating,Oil & Chip,Rivers)

C (Class)

Base (Base Wage Rate)

FRMAN (Foreman Rate)

M-F>8 (OT required for any hour greater than 8 worked each day, Mon through Fri.)

Osa (Overtime (OT) is required for every hour worked on Saturday)

OSH (Overtime is required for every hour worked on Sunday and Holidays)

H/W (Health & Welfare Insurance)

Pensn (Pension)

Vac (Vacation)

Trng (Training)

Explanations

KENDALL COUNTY

The following list is considered as those days for which holiday rates of wages for work performed apply: New Years Day, Memorial Day, Fourth of July, Labor Day, Thanksgiving Day, Christmas Day and Veterans Day in some classifications/counties. Generally, any of these holidays which fall on a Sunday is celebrated on the following Monday. This then makes work performed on that Monday payable at the appropriate overtime rate for holiday pay. Common practice in a given local may alter certain days of celebration. If in doubt, please check with IDOL.

EXPLANATION OF CLASSES

ASBESTOS - GENERAL - removal of asbestos material/mold and hazardous materials from any place in a building, including mechanical systems where those mechanical systems are to be removed. This includes the removal of asbestos materials/mold and hazardous materials from ductwork or pipes in a building when the building is to be demolished at the time or at some close future date.

ASBESTOS - MECHANICAL - removal of asbestos material from mechanical systems, such as pipes, ducts, and boilers, where the mechanical systems are to remain.

CERAMIC TILE FINISHER

The grouting, cleaning, and polishing of all classes of tile, whether for interior or exterior purposes, all burned, glazed or unglazed products; all composition materials, granite tiles, warning detectable tiles, cement tiles, epoxy composite materials, pavers, glass, mosaics, fiberglass, and all substitute materials, for tile made in tile-like units; all mixtures in tile like form of cement, metals, and other materials that are for and intended for use as a finished floor surface, stair treads, promenade roofs, walks, walls, ceilings, swimming pools, and all other places where tile is to form a finished interior or exterior. The mixing of all setting mortars including but not limited to thin-set mortars, epoxies, wall mud, and any other sand and cement mixtures or adhesives when used in the preparation, installation, repair, or maintenance of tile and/or similar materials. The handling and unloading of all sand, cement, lime, tile, fixtures, equipment, adhesives, or any other materials to be used in the preparation, installation, repair, or maintenance of tile and/or similar materials. Ceramic Tile Finishers shall fill all joints and voids regardless of method on all tile work, particularly and especially after installation of said tile work. Application of any and all protective coverings to all types of tile installations including, but not be limited to, all soap compounds, paper products, tapes, and all polyethylene coverings, plywood, masonite, cardboard, and any new type of products that may be used to protect tile installations, Blastrac equipment, and all floor scarifying equipment used in preparing floors to receive tile. The clean up and removal of all waste and materials. All demolition of existing tile floors and walls to be re-tiled.

COMMUNICATIONS TECHNICIAN

Construction, installation, maintenance and removal of telecommunication facilities (voice, sound, data and video), telephone, security, and data inside wire, interconnect, terminal equipment, central offices, PABX and equipment, micro waves, V-SAT, bypass, CATV, WAN (wide area network), LAN (local area networks), and ISDN (integrated system digital network), pulling of wire in raceways, but not the installation of raceways.

MARBLE FINISHER

Loading and unloading trucks, distribution of all materials (all stone, sand, etc.), stocking of floors with material, performing all rigging for heavy work, the handling of all material that may be needed for the installation of such materials, building of scaffolding, polishing if needed, patching, waxing of material if damaged, pointing up, caulking, grouting and cleaning of marble, holding water on diamond or Carborundum blade or saw for setters cutting, use of tub saw or any other saw needed for preparation of material, drilling of holes for wires that anchor material set by setters, mixing up of molding plaster for installation of material, mixing up thin set for the installation of material, mixing up of sand to cement for the installation of material and such other work as may be required in helping a Marble Setter in the handling of all material in the erection or installation of interior marble, slate, travertine, art marble, serpentine, alberene stone, blue stone, granite and other stones (meaning as to stone any foreign or domestic materials as are specified and used in building interiors and exteriors and customarily known as stone in the trade), carrara, sanionyx, vitrolite and similar opaque glass and the laying of all marble tile, terrazzo tile, slate tile and precast tile, steps, risers treads, base, or any other materials that may be used as substitutes for any of the aforementioned materials and which are used on interior and exterior which are installed in a similar manner.

MATERIAL TESTER I: Hand coring and drilling for testing of materials; field inspection of uncured concrete and asphalt.

MATERIAL TESTER II: Field inspection of welds, structural steel, fireproofing, masonry, soil, facade, reinforcing steel, formwork, cured concrete, and concrete and asphalt batch plants; adjusting proportions of bituminous mixtures.

OPERATING ENGINEER - BUILDING

Class 1. Asphalt Plant; Asphalt Spreader; Autograde; Backhoes with Caisson Attachment; Batch Plant; Benoto (requires Two Engineers); Boiler and Throttle Valve; Caisson Rigs; Central Redi-Mix Plant; Combination Back Hoe Front End-loader Machine; Compressor and Throttle Valve; Concrete Breaker (Truck Mounted); Concrete Conveyor; Concrete Conveyor (Truck Mounted); Concrete Paver Over 27E cu. ft; Concrete Paver 27E cu. ft. and Under; Concrete Placer; Concrete Placing Boom; Concrete Pump (Truck Mounted); Concrete Tower; Cranes, All; Cranes, Hammerhead; Cranes, (GCI and similar Type); Creter Crane; Spider Crane; Crusher, Stone, etc.; Derricks, All; Derricks, Traveling; Formless Curb and Gutter Machine; Grader, Elevating; Grouting Machines; Heavy Duty Self-Propelled Transporter or Prime Mover; Highlift Shovels or Front Endloader 2-1/4 yd. and over; Hoists, Elevators, outside type rack and pinion and similar machines; Hoists, One, Two and Three Drum; Hoists, Two Tugger One Floor; Hydraulic Backhoes; Hydraulic Boom Trucks; Hydro Vac (and similar equipment); Locomotives, All; Motor Patrol; Lubrication Technician; Manipulators;

Pile Drivers and Skid Rig; Post Hole Digger; Pre-Stress Machine; Pump Cretes Dual Ram; Pump Cretes: Squeeze Cretes-Screw Type Pumps; Gypsum Bulker and Pump; Raised and Blind Hole Drill; Roto Mill Grinder; Scoops - Tractor Drawn; Slip-Form Paver; Straddle Buggies; Operation of Tie Back Machine; Tournapull; Tractor with Boom and Side Boom; Trenching Machines.

Class 2. Boilers; Broom, All Power Propelled; Bulldozers; Concrete Mixer (Two Bag and Over); Conveyor, Portable; Forklift Trucks; Highlift Shovels or Front Endloaders under 2-1/4 yd.; Hoists, Automatic; Hoists, Inside Elevators; Hoists, Sewer Dragging Machine; Hoists, Tugger Single Drum; Laser Screed; Rock Drill (Self-Propelled); Rock Drill (Truck Mounted); Rollers, All; Steam Generators; Tractors, All; Tractor Drawn Vibratory Roller; Winch Trucks with "A" Frame.

Class 3. Air Compressor; Combination Small Equipment Operator; Generators; Heaters, Mechanical; Hoists, Inside Elevators (remodeling or renovation work); Hydraulic Power Units (Pile Driving, Extracting, and Drilling); Pumps, over 3" (1 to 3 not to exceed a total of 300 ft.); Low Boys; Pumps, Well Points; Welding Machines (2 through 5); Winches, 4 Small Electric Drill Winches.

Class 4. Bobcats and/or other Skid Steer Loaders; Oilers; and Brick Forklift.

Class 5. Assistant Craft Foreman.

Class 6. Gradall.

Class 7. Mechanics; Welder.

OPERATING ENGINEERS - HIGHWAY CONSTRUCTION

Class 1. Asphalt Plant; Asphalt Heater and Planer Combination; Asphalt Heater Scarfire; Asphalt Spreader; Autograder/GOMACO or other similar type machines: ABG Paver; Backhoes with Caisson Attachment; Ballast Regulator; Belt Loader; Caisson Rigs; Car Dumper; Central Redi-Mix Plant; Combination Backhoe Front Endloader Machine, (1 cu. yd. Backhoe Bucket or over or with attachments); Concrete Breaker (Truck Mounted); Concrete Conveyor; Concrete Paver over 27E cu. ft.; Concrete Placer; Concrete Tube Float; Cranes, all attachments; Cranes, Tower Cranes of all types: Creter Crane; Spider Crane; Crusher, Stone, etc.; Derricks, All; Derrick Boats; Derricks, Traveling; Dredges; Elevators, Outside type Rack & Pinion and Similar Machines; Formless Curb and Gutter Machine; Grader, Elevating; Grader, Motor Grader, Motor Patrol, Auto Patrol, Form Grader, Subgrader, Subgrader; Guard Rail Post Driver Truck Mounted; Hoists, One, Two and Three Drum; Heavy Duty Self-Propelled Transporter or Prime Mover; Hydraulic Backhoes; Backhoes with shear attachments up to 40' of boom reach; Lubrication Technician; Manipulators; Mucking Machine; Pile Drivers and Skid Rig; Pre-Stress Machine; Pump Cretes Dual Ram; Rock Drill - Crawler or Skid Rig; Rock Drill - Truck Mounted; Rock/Track Tamper; Roto Mill Grinder; Slip-Form Paver; Snow Melters; Soil Test Drill Rig (Truck Mounted); Straddle Buggies; Hydraulic Telescoping Form (Tunnel); Operation of Tieback Machine; Tractor Drawn Belt Loader; Tractor Drawn Belt Loader (with attached pusher - two engineers); Tractor with Boom; Tractaire with Attachments; Traffic Barrier Transfer Machine; Trenching; Truck Mounted Concrete Pump with Boom; Raised or Blind Hole Drills (Tunnel Shaft); Underground Boring and/or Mining Machines 5 ft. in diameter and over tunnel, etc; Underground Boring and/or Mining Machines under 5 ft. in diameter; Wheel Excavator; Widener (APSCO).

Class 2. Batch Plant; Bituminous Mixer; Boiler and Throttle Valve; Bulldozers; Car Loader Trailing Conveyors; Combination Backhoe Front

Endloader Machine (Less than 1 cu. yd. Backhoe Bucket or over or with attachments); Compressor and Throttle Valve; Compressor, Common Receiver (3); Concrete Breaker or Hydro Hammer; Concrete Grinding Machine; Concrete Mixer or Paver 7S Series to and including 27 cu. ft.; Concrete Spreader; Concrete Curing Machine, Burlap Machine, Belting Machine and Sealing Machine; Concrete Wheel Saw; Conveyor Muck Cars (Haglund or Similar Type); Drills, All; Finishing Machine - Concrete; Highlift Shovels or Front Endloader; Hoist - Sewer Dragging Machine; Hydraulic Boom Trucks (All Attachments); Hydro-Blaster; Hydro Excavating (excluding hose work); Laser Screed; All Locomotives, Dinky; Off-Road Hauling Units (including articulating) Non Self-Loading Ejection Dump; Pump Cretes: Squeeze Cretes - Screw Type Pumps, Gypsum Bulker and Pump; Roller, Asphalt; Rotary Snow Plows; Rototiller, Seaman, etc., self-propelled; Self-Propelled Compactor; Spreader - Chip - Stone, etc.; Scraper - Single/Twin Engine/Push and Pull; Scraper - Prime Mover in Tandem (Regardless of Size); Tractors pulling attachments, Sheeps Foot, Disc, Compactor, etc.; Tug Boats.

Class 3. Boilers; Brooms, All Power Propelled; Cement Supply Tender; Compressor, Common Receiver (2); Concrete Mixer (Two Bag and Over); Conveyor, Portable; Farm-Type Tractors Used for Mowing, Seeding, etc.; Forklift Trucks; Grouting Machine; Hoists, Automatic; Hoists, All Elevators; Hoists, Tugger Single Drum; Jeep Diggers; Low Boys; Pipe Jacking Machines; Post-Hole Digger; Power Saw, Concrete Power Driven; Pug Mills; Rollers, other than Asphalt; Seed and Straw Blower; Steam Generators; Stump Machine; Winch Trucks with "A" Frame; Work Boats; Tamper-Form-Motor Driven.

Class 4. Air Compressor; Combination - Small Equipment Operator; Directional Boring Machine; Generators; Heaters, Mechanical; Hydraulic Power Unit (Pile Driving, Extracting, or Drilling); Light Plants, All (1 through 5); Pumps, over 3" (1 to 3 not to exceed a total of 300 ft.); Pumps, Well Points; Vacuum Trucks (excluding hose work); Welding Machines (2 through 5); Winches, 4 Small Electric Drill Winches.

Class 5. SkidSteer Loader (all); Brick Forklifts; Oilers.

Class 6. Field Mechanics and Field Welders

Class 7. Dowell Machine with Air Compressor; Gradall and machines of like nature.

TRUCK DRIVER - BUILDING, HEAVY AND HIGHWAY CONSTRUCTION

Class 1. Two or three Axle Trucks. A-frame Truck when used for transportation purposes; Air Compressors and Welding Machines, including those pulled by cars, pick-up trucks and tractors; Ambulances Batch Gate Lockers; Batch Hopperman; Car and Truck Washers; Carry-alls; Fork Lifts and Hoisters; Helpers; Mechanics Helpers and Greasers; Oil Distributors 2-man operation; Pavement Breakers; Pole Trailer, up to 40 feet; Power Mower Tractors; Self-propelled Chip Spreader; Skipman; Slurry Trucks, 2-man operation; Slurry Truck Conveyor Operation, 2 or 3 man; Teamsters; Unskilled Dumpman; and Truck Drivers hauling warning lights, barricades, and portable toilets on the job site.

Class 2. Four axle trucks; Dump Crets and Adgetors under 7 yards; Dumpsters, Track Trucks, Euclids, Hug Bottom Dump Turnapulls or Turnatrailers when pulling other than self-loading equipment or similar equipment under 16 cubic yards; Mixer Trucks under 7 yards; Ready-mix Plant Hopper Operator, and Winch Trucks, 2 Axles.

Class 3. Five axle trucks; Dump Crets and Adgetors 7 yards and over; Dumpsters, Track Trucks, Euclids, Hug Bottom Dump Turnatrailers or

turnapulls when pulling other than self-loading equipment or similar equipment over 16 cubic yards; Explosives and/or Fission Material Trucks; Mixer Trucks 7 yards or over; Mobile Cranes while in transit; Oil Distributors, 1-man operation; Pole Trailer, over 40 feet; Pole and Expandable Trailers hauling material over 50 feet long; Slurry trucks, 1-man operation; Winch trucks, 3 axles or more; Mechanic--Truck Welder and Truck Painter.

Class 4. Six axle trucks; Dual-purpose vehicles, such as mounted crane trucks with hoist and accessories; Foreman; Master Mechanic; Self-loading equipment like P.B. and trucks with scoops on the front.

TERRAZZO FINISHER

The handling of sand, cement, marble chips, and all other materials that may be used by the Mosaic Terrazzo Mechanic, and the mixing, grinding, grouting, cleaning and sealing of all Marble, Mosaic, and Terrazzo work, floors, base, stairs, and wainscoting by hand or machine, and in addition, assisting and aiding Marble, Masonic, and Terrazzo Mechanics.

Other Classifications of Work:

For definitions of classifications not otherwise set out, the Department generally has on file such definitions which are available. If a task to be performed is not subject to one of the classifications of pay set out, the Department will upon being contacted state which neighboring county has such a classification and provide such rate, such rate being deemed to exist by reference in this document. If no neighboring county rate applies to the task, the Department shall undertake a special determination, such special determination being then deemed to have existed under this determination. If a project requires these, or any classification not listed, please contact IDOL at 217-782-1710 for wage rates or clarifications.

LANDSCAPING

Landscaping work falls under the existing classifications for laborer, operating engineer and truck driver. The work performed by landscape plantsman and landscape laborer is covered by the existing classification of laborer. The work performed by landscape operators (regardless of equipment used or its size) is covered by the classifications of operating engineer. The work performed by landscape truck drivers (regardless of size of truck driven) is covered by the classifications of truck driver.

Knox County Prevailing Wage for May 2013

(See explanation of column headings at bottom of wages)

Trade Name	RG	TYP	C	Base	FRMAN	M-F>8	OSA	OSH	H/W	Pensn	Vac	Trng
=====	==	===	=	=====	=====	=====	===	===	=====	=====	=====	=====
ASBESTOS ABT-GEN		BLD		27.490	28.490	1.5	1.5	2.0	8.240	10.07	0.000	0.800
ASBESTOS ABT-GEN		HWY		26.060	26.560	1.5	1.5	2.0	8.240	9.550	0.000	0.800
ASBESTOS ABT-MEC		BLD		20.500	21.500	1.5	1.5	2.0	6.250	3.500	0.000	0.000
BOILERMAKER		BLD		35.010	38.010	2.0	2.0	2.0	7.070	13.83	0.000	0.300
BRICK MASON		BLD		32.060	33.560	1.5	1.5	2.0	7.700	9.130	0.000	0.560
CARPENTER		BLD		29.330	31.580	1.5	1.5	2.0	7.450	13.66	0.000	0.520
CARPENTER		HWY		30.820	33.070	1.5	1.5	2.0	7.450	13.94	0.000	0.520
CEMENT MASON		ALL		25.030	26.530	1.5	1.5	2.0	5.750	11.50	0.000	0.500
CERAMIC TILE FNSHER		BLD		29.750	0.000	1.5	1.5	2.0	7.700	9.130	0.000	0.550
ELECTRIC PWR EQMT OP		ALL		35.440	0.000	1.5	1.5	2.0	5.000	10.98	0.000	0.270

ELECTRIC PWR GRNDMAN	ALL		24.320	0.000	1.5	1.5	2.0	5.000	7.540	0.000	0.180
ELECTRIC PWR LINEMAN	ALL		39.370	41.910	1.5	1.5	2.0	5.000	12.20	0.000	0.300
ELECTRIC PWR TRK DRV	ALL		25.510	0.000	1.5	1.5	2.0	5.000	7.920	0.000	0.190
ELECTRICIAN	BLD		30.190	32.690	1.5	1.5	2.0	5.350	9.390	0.000	0.400
ELECTRONIC SYS TECH	BLD		27.430	29.180	1.5	1.5	2.0	5.350	9.320	0.000	0.400
ELEVATOR CONSTRUCTOR	BLD		40.520	45.585	2.0	2.0	2.0	11.88	12.71	3.240	0.600
GLAZIER	BLD		26.360	27.860	1.5	1.5	2.0	6.940	6.520	0.000	0.350
HT/FROST INSULATOR	BLD		29.190	30.390	1.5	1.5	2.0	5.420	12.05	0.000	0.900
IRON WORKER	NW ALL		28.000	30.240	1.5	1.5	2.0	9.390	10.68	0.000	0.620
IRON WORKER	SE BLD		30.330	32.230	1.5	1.5	2.0	9.390	11.56	0.000	0.440
IRON WORKER	SE HWY		34.020	36.020	1.5	1.5	2.0	9.390	11.56	0.000	0.390
IRON WORKER	SW ALL		24.440	25.690	1.5	1.5	2.0	7.010	9.890	0.000	0.570
LABORER	BLD		26.490	27.490	1.5	1.5	2.0	8.240	10.07	0.000	0.800
LABORER	HWY		25.060	25.560	1.5	1.5	2.0	8.240	9.550	0.000	0.800
LABORER, SKILLED	BLD		26.490	27.490	1.5	1.5	2.0	8.240	10.07	0.000	0.800
LABORER, SKILLED	HWY		25.360	25.860	1.5	1.5	2.0	8.240	9.550	0.000	0.800
LATHER	BLD		29.330	31.580	1.5	1.5	2.0	7.450	13.66	0.000	0.520
MACHINERY MOVER	SE HWY		34.020	36.020	1.5	1.5	2.0	9.390	11.56	0.000	0.390
MACHINIST	BLD		43.550	46.050	1.5	1.5	2.0	6.130	8.950	1.850	0.000
MARBLE FINISHERS	BLD		29.750	0.000	1.5	1.5	2.0	7.700	9.130	0.000	0.550
MARBLE MASON	BLD		31.510	32.760	1.5	1.5	2.0	7.700	9.130	0.000	0.550
MILLWRIGHT	BLD		30.240	32.490	1.5	1.5	2.0	7.450	13.09	0.000	0.520
MILLWRIGHT	HWY		31.820	34.070	1.5	1.5	2.0	7.450	13.44	0.000	0.520
OPERATING ENGINEER	BLD 1		36.000	39.000	1.5	1.5	2.0	9.750	13.60	0.000	3.000
OPERATING ENGINEER	BLD 2		33.490	39.000	1.5	1.5	2.0	9.750	13.60	0.000	3.000
OPERATING ENGINEER	BLD 3		29.340	39.000	1.5	1.5	2.0	9.750	13.60	0.000	3.000
OPERATING ENGINEER	HWY 1		36.000	39.500	1.5	1.5	2.0	9.750	13.60	0.000	3.000
OPERATING ENGINEER	HWY 2		33.490	39.500	1.5	1.5	2.0	9.750	13.60	0.000	3.000
OPERATING ENGINEER	HWY 3		29.340	39.500	1.5	1.5	2.0	9.750	13.60	0.000	3.000
PAINTER	ALL		27.320	28.320	1.5	1.5	1.5	5.000	6.100	0.000	0.600
PAINTER OVER 30FT	ALL		28.570	29.570	1.5	1.5	1.5	5.000	6.100	0.000	0.600
PAINTER PWR EQMT	ALL		27.820	28.820	1.5	1.5	1.5	5.000	6.100	0.000	0.600
PILEDRIVER	BLD		29.830	32.080	1.5	1.5	2.0	7.450	13.66	0.000	0.520
PILEDRIVER	HWY		31.820	34.070	1.5	1.5	2.0	7.450	13.94	0.000	0.520
PIPEFITTER	ALL		36.550	40.210	1.5	1.5	2.0	5.650	12.15	0.000	1.000
PLASTERER	BLD		27.770	28.770	1.5	1.5	2.0	8.140	12.76	0.000	0.600
PLUMBER	ALL		36.550	40.210	1.5	1.5	2.0	5.650	12.15	0.000	1.000
ROOFER	BLD		25.130	26.380	1.5	1.5	2.0	8.610	5.620	0.000	0.260
SHEETMETAL WORKER	BLD		30.070	32.070	1.5	1.5	2.0	7.140	10.54	0.000	0.540
SIGN HANGER	SE HWY		34.020	36.020	1.5	1.5	2.0	9.390	11.56	0.000	0.390
SPRINKLER FITTER	BLD		36.390	39.140	1.5	1.5	2.0	8.420	8.500	0.000	0.450
STEEL ERECTOR	SE HWY		34.020	36.020	1.5	1.5	2.0	9.390	11.56	0.000	0.390
STONE MASON	BLD		32.060	33.560	1.5	1.5	2.0	7.700	9.130	0.000	0.560
TERRAZZO FINISHER	BLD		29.750	0.000	1.5	1.5	2.0	7.700	9.130	0.000	0.550
TERRAZZO MASON	BLD		31.510	32.760	1.5	1.5	2.0	7.700	9.130	0.000	0.550
TILE MASON	BLD		31.510	32.760	1.5	1.5	2.0	7.700	9.130	0.000	0.550
TRUCK DRIVER	ALL 1		31.230	0.000	1.5	1.5	2.0	10.30	4.840	0.000	0.250
TRUCK DRIVER	ALL 2		31.680	0.000	1.5	1.5	2.0	10.30	4.840	0.000	0.250
TRUCK DRIVER	ALL 3		31.890	0.000	1.5	1.5	2.0	10.30	4.840	0.000	0.250
TRUCK DRIVER	ALL 4		32.180	0.000	1.5	1.5	2.0	10.30	4.840	0.000	0.250
TRUCK DRIVER	ALL 5		33.020	0.000	1.5	1.5	2.0	10.30	4.840	0.000	0.250
TRUCK DRIVER	O&C 1		24.980	0.000	1.5	1.5	2.0	10.30	4.840	0.000	0.250
TRUCK DRIVER	O&C 2		25.340	0.000	1.5	1.5	2.0	10.30	4.840	0.000	0.250
TRUCK DRIVER	O&C 3		25.510	0.000	1.5	1.5	2.0	10.30	4.840	0.000	0.250
TRUCK DRIVER	O&C 4		25.740	0.000	1.5	1.5	2.0	10.30	4.840	0.000	0.250
TRUCK DRIVER	O&C 5		26.420	0.000	1.5	1.5	2.0	10.30	4.840	0.000	0.250
TUCKPOINTER	BLD		32.060	33.560	1.5	1.5	2.0	7.700	9.130	0.000	0.560

Legend :

RG (Region)

TYP (Trade Type - All,Highway,Building,Floating,Oil & Chip,Rivers)

C (Class)

Base (Base Wage Rate)

FRMAN (Foreman Rate)

M-F>8 (OT required for any hour greater than 8 worked each day, Mon through Fri.)

OSA (Overtime (OT) is required for every hour worked on Saturday)

OSH (Overtime is required for every hour worked on Sunday and Holidays)

H/W (Health & Welfare Insurance)

Pensn (Pension)

Vac (Vacation)

Trng (Training)

Explanations

KNOX COUNTY

IRONWORKERS (SOUTHWEST) - That part of the county West of Rt. 41.

IRONWORKERS (SOUTHEAST) - That part of the county South and East of a line from Tolona (Stark County) North of Victoria to (but excluding) Galesburg looping East and South of the city to Rt. 41 South to the county line.

The following list is considered as those days for which holiday rates of wages for work performed apply: New Years Day, Memorial Day, Fourth of July, Labor Day, Thanksgiving Day, Christmas Day and Veterans Day in some classifications/counties. Generally, any of these holidays which fall on a Sunday is celebrated on the following Monday. This then makes work performed on that Monday payable at the appropriate overtime rate for holiday pay. Common practice in a given local may alter certain days of celebration. If in doubt, please check with IDOL.

Oil and chip resealing (O&C) means the application of road oils and liquid asphalt to coat an existing road surface, followed by application of aggregate chips or gravel to coated surface, and subsequent rolling of material to seal the surface.

EXPLANATION OF CLASSES

ASBESTOS - GENERAL - removal of asbestos material/mold and hazardous materials from any place in a building, including mechanical systems where those mechanical systems are to be removed. This includes the removal of asbestos materials/mold and hazardous materials from ductwork or pipes in a building when the building is to be demolished at the time or at some close future date.

ASBESTOS - MECHANICAL - removal of asbestos material from mechanical systems, such as pipes, ducts, and boilers, where the mechanical systems are to remain.

CERAMIC TILE FINISHER, MARBLE FINISHER, TERRAZZO FINISHER

Assisting, helping or supporting the tile, marble and terrazzo mechanic by performing their historic and traditional work assignments required to complete the proper installation of the work covered by said crafts. The term "Ceramic" is used for naming the classification only and is in no way a limitation of the product handled. Ceramic takes into consideration most hard tiles.

ELECTRONIC SYSTEMS TECHNICIAN

Installation, service and maintenance of low-voltage systems which utilizes the transmission and/or transference of voice, sound, vision, or digital for commercial, education, security and entertainment purposes for the following: TV monitoring and surveillance, background/foreground music, intercom and telephone interconnect, field programming, inventory control systems, microwave transmission, multi-media, multiplex, radio page, school, intercom and sound burglar alarms and low voltage master clock systems.

Excluded from this classification are energy management systems, life safety systems, supervisory controls and data acquisition systems not intrinsic with the above listed systems, fire alarm systems, nurse call systems and raceways exceeding fifteen feet in length.

LABORER, SKILLED - BUILDING

The skilled laborer building (BLD) classification shall encompass the following types of work, irrespective of the site of the work: tending of carpenters in unloading, handling, stockpiling and distribution operations, also other building crafts, mixing, handling, and conveying of all materials used by masons, plasterers and other building construction crafts, whether done by hand or by any process. The drying of plastering when done by salamander heat, and the cleaning and clearing of all debris. All work pertaining to and in preparation of asbestos abatement and removal. The building of scaffolding and staging for masons and plasterers. The excavations for buildings and all other construction, digging, of trenches, piers, foundations and holes, digging, lagging, sheeting, cribbing, bracing and propping of foundations, holes, caissons, cofferdams, and dikes, the setting of all guidelines for machine or hand excavation and subgrading. The mixing, handling, conveying, pouring, vibrating, gunniting and otherwise applying of concrete, whether by hand or other method of concrete for any walls, foundations, floors, or for other construction concrete sealant men. The wrecking, stripping, dismantling, and handling of concrete forms and false work, and the building of centers for fireproofing purposes. Boring machine, gas, electric or air in preparation for shoving pipe, telephone cable, and so forth, under highways, roads, streets and alleys. All hand and power operating cross cut saws when used for clearing. All work in compressed air construction. All work on acetylene burners in salvaging. The blocking and tamping of concrete. The laying of sewer tile and conduit, and pre-cast materials. The assembling and dismantling of all jacks and sectional scaffolding, including elevator construction and running of slip form jacks. The work of drill running and blasting, including wagon drills. The wrecking, stripping, dismantling, cleaning, moving and oiling of forms. The cutting off of concrete piles. The loading, unloading, handling and carrying to place of installation of all rods, (and materials for use in reinforcing) concrete and the hoisting of same and all signaling where hoist is used in this type of construction coming under the jurisdiction of the Laborers' Union. And, all other labor work not awarded to any other craft. Mortar mixers, kettlemen and carrier of hot stuff, tool crib men, watchmen (Laborer), firemen or salamander tenders, flagmen, deck hands, installation and maintenance of temporary gas-fired heating units, gravel box men, dumpmen and spotters, fencing Laborers, cleaning lumber, pit men, material

checkers, dispatchers, unloading explosives, asphalt plant laborers, writer of scale tickets, fireproofing laborers, janitors, asbestos abatement and removal laborers, handling of materials treated with oil, creosote, chloride, asphalt, and/or foreign material harmful to skin or clothing, Laborers with de-watering systems, gunnite nozzle men, laborers tending masons with hot material or where foreign materials are used, Laborers handling masterplate or similar materials, laser beam operator, concrete burning machine operator, material selector men working with firebrick or combustible material, dynamite men, track laborers, cement handlers, chloride handlers, the unloading and laborers with steel workers and re-bars, concrete workers (wet), luteman, asphalt raker, curb asphalt machine operator, ready mix scalemen, permanent, portable or temporary plant drilling machine operator, plaster tenders, underpinning and shoring of buildings, fire watch, signaling of all power equipment, to include trucks excavating equipment, etc., tree topper or trimmer when in connection to construction, tunnel helpers in free air, batch dumpers, kettle and tar men, tank cleaners, plastic installers, scaffold workers, motorized buggies or motorized unit used for wet concrete or handling of building materials, sewer workers, rod and chain men, vibrator operators, mortar mixer operator, cement silica, clay, fly ash, lime and plasters, handlers (bulk or bag), cofferdam workers, on concrete paving, placing, cutting and tying of reinforcing, deck hand, dredge hand and shore laborers, bankmen on floating plant, asphalt workers with machine & layers, grade checker, power tools, caisson workers, lead man on sewer work, welders, cutters, burners and torch men, chain saw operators, paving breaker, jackhammer and drill operator, layout man and/or drainage tile layer, steel form setters -- street and highway, air tamping hammerman, signal man on crane, concrete saw operator, screen man on asphalt pavers, front end man on chip spreader, multiple concrete duct -- lead man.

LABORER, SKILLED - HIGHWAY

The skilled laborer heavy and highway (HWY) classification shall encompass the following types of work, irrespective of the site of the work: handling of materials treated with oil, creosote, asphalt and/or any foreign materials harmful to skin or clothing, track laborers, chloride handlers, the unloading and loading with steel workers and re-bars, concrete workers (wet), tunnel helpers in free air, batch dumpers, mason tenders, kettle and tar men, plastic installers, scaffold workers, motorized buggies or motorized unit used for wet concrete or handling of building materials, laborers with de-watering systems, sewer workers plus depth, rod and chainmen, vibrator operators, mortar mixer operators, cement silica, clay, fly ash, lime and plasters, handlers (bulk or bag), cofferdam workers plus depth, on concrete paving, placing, cutting and tying or reinforcing, deck hand, dredge hand shore laborers, bankmen on floating plant, asphalt workers with machine, and layers, grade checker, power tools, stripping of all concrete forms excluding paving forms, dumpmen and spotters, when necessary, caisson workers plus depth, gunnite nozzle men, welders, cutters, burners and torchmen, chain saw operators, paving breaker, jackhammer and drill operators, layout man and/or drainage tile layer, steel form setters - street and highway, air tamping hammerman, signal man on crane, concrete saw operator, screedman on asphalt pavers, front end man on chip spreader, multiple concrete duct, luteman, asphalt raker, curb asphalt machine operator, ready mix scalemen (portable or temporary plant), laser beam operator, concrete burning machine operator, and coring machine operator.

TRUCK DRIVER - BUILDING, HEAVY AND HIGHWAY CONSTRUCTION

Class 1. Drivers on 2 axle trucks hauling less than 9 ton. Air compressor and welding machines and brooms, including those pulled by separate units, truck driver helpers, warehouse employees, mechanic helpers, greasers and tiremen, pickup trucks when hauling materials,

tools, or workers to and from and on-the-job site, and fork lifts up to 6,000 lb. capacity.

Class 2. Two or three axle trucks hauling more than 9 ton but hauling less than 16 ton. A-frame winch trucks, hydrolift trucks, vactor trucks or similar equipment when used for transportation purposes. Fork lifts over 6,000 lb. capacity, winch trucks, four axle combination units, and ticket writers.

Class 3. Two, three or four axle trucks hauling 16 ton or more. Drivers on water pulls, articulated dump trucks, mechanics and working forepersons, and dispatchers. Five axle or more combination units.

Class 4. Low Boy and Oil Distributors.

Class 5. Drivers who require special protective clothing while employed on hazardous waste work.

TRUCK DRIVER - OIL AND CHIP RESEALING ONLY.

This shall encompass laborers, workers and mechanics who drive contractor or subcontractor owned, leased, or hired pickup, dump, service, or oil distributor trucks. The work includes transporting materials and equipment (including but not limited to, oils, aggregate supplies, parts, machinery and tools) to or from the job site; distributing oil or liquid asphalt and aggregate; stock piling material when in connection with the actual oil and chip contract. The Truck Driver (Oil & Chip Resealing) wage classification does not include supplier delivered materials.

OPERATING ENGINEERS - BUILDING

Class 1. Cranes; Overhead Cranes; Gradall; All Cherry Pickers; Mechanics; Central Concrete Mixing Plant Operator; Road Pavers (27E - Dual Drum - Tri Batchers); Blacktop Plant Operators and Plant Engineers; 3 Drum Hoist; Derricks; Hydro Cranes; Shovels; Skimmer Scoops; Koehring Scooper; Drag Lines; Backhoe; Derrick Boats; Pile Drivers and Skid Rigs; Clamshells; Locomotive Cranes; Dredge (all types) Motor Patrol; Power Blades - Dumore - Elevating and similar types; Tower Cranes (Crawler-Mobile) and Stationary; Crane-type Backfiller; Drott Yumbo and similar types considered as Cranes; Caisson Rigs; Dozer; Tournadozer; Work Boats; Ross Carrier; Helicopter; Tournapulls - all and similar types; Scoops (all sizes); Pushcats; Endloaders (all types); Asphalt Surfacing Machine; Slip Form Paver; Rock Crusher; Heavy Equipment Greaser; CMI, CMI Belt Placer, Auto Grade & 3 Track and similar types; Side Booms; Multiple Unit Earth Movers; Creter Crane; Trench Machine; Pump-crete-Belt Crete-Squeeze Cretes-Screw-type Pumps and Gypsum; Bulker & Pump - Operator will clean; Formless Finishing Machine; Flaherty Spreader or similar types; Screed Man on Laydown Machine; Wheel Tractors (industrial or Farm-type w/Dozer-Hoe-Endloader or other attachments); F.W.D. & Similar Types; Vermeer Concrete Saw.

Class 2. Dinkeys; Power Launches; PH One-pass Soil Cement Machine (and similar types); Pugmill with Pump; Backfillers; Euclid Loader; Forklifts; Jeeps w/Ditching Machine or other attachments; Tuneluger; Automatic Cement and Gravel Batching Plants; Mobile Drills (Soil Testing) and similar types; Gurries and Similar Types; (1) and (2) Drum Hoists (Buck Hoist and Similar Types); Chicago Boom; Boring Machine & Pipe Jacking Machine; Hydro Boom; Dewatering System; Straw Blower; Hydro Seeder; Assistant Heavy Equipment Greaser on Spread; Tractors (Track type) without Power Unit pulling Rollers; Rollers on Asphalt -- Brick Macadem; Concrete Breakers; Concrete Spreaders; Mule Pulling Rollers; Center Stripper; Cement Finishing Machines & CMI

Texture & Reel Curing Machines; Cement Finishing Machine; Barber Green or similar loaders; Vibro Tamper (All similar types) Self-propelled; Winch or Boom Truck; Mechanical Bull Floats; Mixers over 3 Bag to 27E; Tractor pulling Power Blade or Elevating Grader; Porter Rex Rail; Clary Screed; Truck Type Hoptoe Oilers; Fireman; Spray Machine on Paving; Curb Machines; Truck Crane Oilers; Oil Distributor; Truck-Mounted Saws.

Class 3. Air Compressor; Power Subgrader; Straight Tractor; Trac Air without attachments; Herman Nelson Heater, Dravo, Warner, Silent Glo, and similar types; Roller: Five (5) Ton and under on Earth or Gravel; Form Grader; Crawler Crane & Skid Rig Oilers; Freight Elevators - permanently installed; Pump; Light Plant; Generator; Conveyor (1) or (2) - Operator will clean; Welding Machine; Mixer (3) Bag and Under (Standard Capacity with skip); Bulk Cement Plant; Oiler on Central Concrete Mixing Plant.

OPERATING ENGINEERS - HEAVY AND HIGHWAY CONSTRUCTION

CLASS 1. Cranes; Hydro Cranes; Shovels; Crane Type Backfiller; Tower, Mobile, Crawler, & Stationary Cranes; Derricks; Hoists (3 Drum); Draglines; Drott Yumbo & Similar Types considered as Cranes; 360 Degree Swing Excavator (Shears, Grapples, Movacs, etc.); Back Hoe; Derrick Boats; Pile Driver and Skid Rigs; Clam Shell; Locomotive - Cranes; Road Pavers - Single Drum - Dual Drum - Tri Batcher; Motor Patrols & Power Blades - Dumore - Elevating & Similar Types; Mechanics; Central Concrete Mixing Plant Operator; Asphalt Batch Plant Operators and Plant Engineers; Gradall; Caisson Rigs; Skimmer Scoop - Koering Scooper; Dredges (all types); Hoptoe; All Cherry Pickers; Work Boat; Ross Carrier; Helicopter; Dozer; Tournadozer; Tournapulls - all and similar types; Operation of Concrete and all Recycle Machines; Multiple Unit Earth Movers; Scoops (all sizes); Pushcats; Endloaders (all types); Asphalt Surfacing Machine; Slip Form Paver; Rock Crusher; Operation of Material Crusher, Screening Plants, and Tunnel Boring Machine; Heavy Equipment Greaser (top greaser on spread); CMI, Auto Grade, CMI Belt Placer & 3 Track and Similar Types; Side Booms; Asphalt Heater & Planer Combination (used to plane streets); Wheel Tractors (with Dozer, Hoe or Endloader Attachments); CAT Earthwork Compactors and Similar Types; Blaw Knox Spreader and Similar Types; Trench Machines; Pump Crete - Belt Crete - Squeeze Crete - Screw Type Pumps and Gypsum (operator will clean); Creter Crane; Operation of Concrete Pump Truck; Formless Finishing Machines; Flaherty Spreader or Similar Types; Screed Man on Laydown Machine; Vermeer Concrete Saw; Operation of Laser Screed; Span Saw; Dredge Leverman; Dredge Engineer; Lull or Similar Type; Hydro-Boom Truck; Operation of Guard Rail Machine; and Starting Engineer on Pipeline or Construction (11 or more pieces) including: Air Compressor (Trailer Mounted), All Forced Air Heaters (regardless of Size), Water Pumps (Greater than 4-1/2" or Total Discharge Over 4-1/2"), Light Plants, Generators (Trailer Mounted - Excluding Decontamination Trailer), Welding Machines (Any Size or Mode of Power), Conveyor, Mixer (any size), Stud Welder, Power Pac, etc, and Ground Heater (Trailer Mounted).

CLASS 2. Bulker & Pump; Power Launches; Boring Machine & Pipe Jacking Machine; Dinkeys; Operation of Carts, Powered Haul Unit for a Boring Machine; P & H One Pass Soil Cement Machines and Similar Types; Wheel Tractors (Industry or Farm Type - Other); Back Fillers; Euclid Loader; Fork Lifts; Jeep w/Ditching Machine or Other Attachments; Tunneluger; Automatic Cement & Gravel Batching Plants; Mobile Drills - Soil Testing and Similar Types; Pugmill with Pump; All (1) and (2) Drum Hoists; Dewatering System; Straw Blower; Hydro-Seeder; Bump Grinders (self-propelled); Assistant Heavy Equipment Greaser; Apsco Spreader; Tractors (Track-Type) without Power Units Pulling Rollers; Rollers on Asphalt - Brick or Macadam; Concrete Breakers; Concrete Spreaders;

Cement Strippers; Cement Finishing Machines & CMI Texture & Reel Curing Machines; Vibro-Tampers (All Similar Types Self-Propelled); Mechanical Bull Floats; Self-Propelled Concrete Saws; Truck Mounted Power Saws; Operation of Curb Cutters; Mixers - Over Three (3) Bags; Winch and Boom Trucks; Tractor Pulling Power Blade or Elevating Grader; Porter Rex Rail; Clary Screed; Mule Pulling Rollers; Pugmill without Pump; Barber Greene or Similar Loaders; Track Type Tractor w/Power Unit attached (minimum); Fireman; Spray Machine on Paving; Curb Machines; Paved Ditch Machine; Power Broom; Self-Propelled Sweepers; Self-Propelled Conveyors; Power Subgrader; Oil Distributor; Straight Tractor; Truck Crane Oiler; Truck Type Oilers; Directional Boring Machine; Horizontal Directional Drill; Articulating End Dump Vehicles; Starting Engineer on Pipeline or Construction (6 -10 pieces) including: Air Compressor (Trailer Mounted), All Forced Air Heaters (regardless of Size), Water Pumps (Greater than 4-1/2" or Total Discharge Over 4-1/2"), Light Plants, Generators (Trailer Mounted - Excluding Decontamination Trailer), Welding Machines (Any Size or Mode of Power), Conveyor, Mixer (any size), Stud Welder, Power Pac, etc., and Ground Heater (Trailer Mounted).

CLASS 3. Straight Framed Truck Mounted Vac Unit (separately powered); Trac Air Machine (without attachments); Rollers - Five Ton and Under on Earth and Gravel; Form Graders; Bulk Cement Plant; Oilers; and Starting Engineer on Pipeline or Construction (3 - 5 pieces) including: Air Compressor (Trailer Mounted), All Forced Air Heaters (regardless of Size), Water Pumps (Greater than 4-1/2" or Total Discharge Over 4-1/2"), Light Plants, Generators (Trailer Mounted - Excluding Decontamination Trailer), Welding Machines (Any Size or Mode of Power), Conveyor, Mixer (any size), Stud Welder, Power Pac, etc., and Ground Heater (Trailer Mounted).

Other Classifications of Work:

For definitions of classifications not otherwise set out, the Department generally has on file such definitions which are available. If a task to be performed is not subject to one of the classifications of pay set out, the Department will upon being contacted state which neighboring county has such a classification and provide such rate, such rate being deemed to exist by reference in this document. If no neighboring county rate applies to the task, the Department shall undertake a special determination, such special determination being then deemed to have existed under this determination. If a project requires these, or any classification not listed, please contact IDOL at 217-782-1710 for wage rates or clarifications.

LANDSCAPING

Landscaping work falls under the existing classifications for laborer, operating engineer and truck driver. The work performed by landscape plantsman and landscape laborer is covered by the existing classification of laborer. The work performed by landscape operators (regardless of equipment used or its size) is covered by the classifications of operating engineer. The work performed by landscape truck drivers (regardless of size of truck driven) is covered by the classifications of truck driver.

Lake County Prevailing Wage for May 2013

(See explanation of column headings at bottom of wages)

Trade Name	RG	TYP	C	Base	FRMAN	M-F>8	OSA	OSH	H/W	Pensn	Vac	Trng
=====	==	=	=	=====	=====	=====	==	==	=====	=====	=====	=====
ASBESTOS ABT-GEN		ALL		36.200	36.700	1.5	1.5	2.0	12.78	9.020	0.000	0.500

ASBESTOS ABT-MEC	BLD	34.160	36.660	1.5	1.5	2.0	10.82	10.66	0.000	0.720
BOILERMAKER	BLD	43.450	47.360	2.0	2.0	2.0	6.970	14.66	0.000	0.350
BRICK MASON	BLD	40.680	44.750	1.5	1.5	2.0	9.550	12.00	0.000	0.970
CARPENTER	ALL	41.520	43.520	1.5	1.5	2.0	13.19	11.75	0.000	0.530
CEMENT MASON	ALL	40.800	42.800	2.0	1.5	2.0	10.25	13.78	0.000	0.500
CERAMIC TILE FNSHER	BLD	34.440	0.000	2.0	1.5	2.0	9.700	6.930	0.000	0.610
COMMUNICATION TECH	BLD	34.650	36.750	1.5	1.5	2.0	10.40	11.09	1.040	0.520
ELECTRIC PWR EQMT OP	ALL	36.610	49.750	1.5	1.5	2.0	5.000	11.35	0.000	0.270
ELECTRIC PWR GRNDMAN	ALL	28.310	49.750	1.5	1.5	2.0	5.000	8.780	0.000	0.210
ELECTRIC PWR LINEMAN	ALL	43.830	49.750	1.5	1.5	2.0	5.000	13.58	0.000	0.330
ELECTRIC PWR TRK DRV	ALL	29.310	49.750	1.5	1.5	2.0	5.000	9.090	0.000	0.220
ELECTRICIAN	BLD	39.150	43.070	1.5	1.5	2.0	12.73	14.33	0.000	0.630
ELEVATOR CONSTRUCTOR	BLD	49.080	55.215	2.0	2.0	2.0	11.88	12.71	3.930	0.600
FENCE ERECTOR	ALL	33.740	35.740	1.5	1.5	2.0	12.61	10.18	0.000	0.250
GLAZIER	BLD	39.500	41.000	1.5	2.0	2.0	11.99	14.30	0.000	0.840
HT/FROST INSULATOR	BLD	45.550	48.050	1.5	1.5	2.0	10.82	11.86	0.000	0.720
IRON WORKER	ALL	40.750	42.750	2.0	2.0	2.0	13.20	19.09	0.000	0.350
LABORER	ALL	36.200	36.950	1.5	1.5	2.0	12.78	9.020	0.000	0.500
LATHER	ALL	41.520	43.520	1.5	1.5	2.0	13.19	11.75	0.000	0.530
MACHINIST	BLD	43.550	46.050	1.5	1.5	2.0	6.130	8.950	1.850	0.000
MARBLE FINISHERS	ALL	29.700	0.000	1.5	1.5	2.0	9.550	11.75	0.000	0.620
MARBLE MASON	BLD	39.880	43.870	1.5	1.5	2.0	9.550	11.75	0.000	0.730
MATERIAL TESTER I	ALL	26.200	0.000	1.5	1.5	2.0	12.78	9.020	0.000	0.500
MATERIALS TESTER II	ALL	31.200	0.000	1.5	1.5	2.0	12.78	9.020	0.000	0.500
MILLWRIGHT	ALL	41.520	43.520	1.5	1.5	2.0	13.19	11.75	0.000	0.530
OPERATING ENGINEER	BLD 1	45.100	49.100	2.0	2.0	2.0	15.70	10.55	1.900	1.250
OPERATING ENGINEER	BLD 2	43.800	49.100	2.0	2.0	2.0	15.70	10.55	1.900	1.250
OPERATING ENGINEER	BLD 3	41.250	49.100	2.0	2.0	2.0	15.70	10.55	1.900	1.250
OPERATING ENGINEER	BLD 4	39.500	49.100	2.0	2.0	2.0	15.70	10.55	1.900	1.250
OPERATING ENGINEER	BLD 5	48.850	49.100	2.0	2.0	2.0	15.70	10.55	1.900	1.250
OPERATING ENGINEER	BLD 6	46.100	49.100	2.0	2.0	2.0	15.70	10.55	1.900	1.250
OPERATING ENGINEER	BLD 7	48.100	49.100	2.0	2.0	2.0	15.70	10.55	1.900	1.250
OPERATING ENGINEER	FLT 1	51.300	51.300	1.5	1.5	2.0	14.40	9.550	1.900	1.250
OPERATING ENGINEER	FLT 2	49.800	51.300	1.5	1.5	2.0	14.40	9.550	1.900	1.250
OPERATING ENGINEER	FLT 3	44.350	51.300	1.5	1.5	2.0	14.40	9.550	1.900	1.250
OPERATING ENGINEER	FLT 4	36.850	51.300	1.5	1.5	2.0	14.40	9.550	1.900	1.250
OPERATING ENGINEER	FLT 5	52.800	51.300	1.5	1.5	2.0	14.40	9.550	1.900	1.250
OPERATING ENGINEER	HWY 1	43.300	47.300	1.5	1.5	2.0	15.70	10.55	1.900	1.250
OPERATING ENGINEER	HWY 2	42.750	47.300	1.5	1.5	2.0	15.70	10.55	1.900	1.250
OPERATING ENGINEER	HWY 3	40.700	47.300	1.5	1.5	2.0	15.70	10.55	1.900	1.250
OPERATING ENGINEER	HWY 4	39.300	47.300	1.5	1.5	2.0	15.70	10.55	1.900	1.250
OPERATING ENGINEER	HWY 5	38.100	47.300	1.5	1.5	2.0	15.70	10.55	1.900	1.250
OPERATING ENGINEER	HWY 6	46.300	47.300	1.5	1.5	2.0	15.70	10.55	1.900	1.250
OPERATING ENGINEER	HWY 7	44.300	47.300	1.5	1.5	2.0	15.70	10.55	1.900	1.250
ORNAMNTL IRON WORKER	ALL	41.800	44.300	2.0	2.0	2.0	12.86	15.81	0.000	0.550
PAINTER	ALL	40.000	44.750	1.5	1.5	1.5	9.750	11.10	0.000	0.770
PAINTER SIGNS	BLD	33.920	38.090	1.5	1.5	1.5	2.600	2.710	0.000	0.000
PILEDRIVER	ALL	41.520	43.520	1.5	1.5	2.0	13.19	11.75	0.000	0.530
PIPEFITTER	BLD	45.050	48.050	1.5	1.5	2.0	8.460	14.85	0.000	1.780
PLASTERER	BLD	39.190	41.190	2.0	1.5	2.0	10.25	15.58	0.000	0.500
PLUMBER	BLD	44.500	47.500	1.5	1.5	2.0	11.05	12.40	0.000	1.700
ROOFER	BLD	38.350	41.350	1.5	1.5	2.0	8.280	8.770	0.000	0.430
SHEETMETAL WORKER	BLD	40.810	44.070	1.5	1.5	2.0	10.13	17.79	0.000	0.630
SIGN HANGER	BLD	30.210	30.710	1.5	1.5	2.0	4.850	3.030	0.000	0.000
SPRINKLER FITTER	BLD	49.200	51.200	1.5	1.5	2.0	10.25	8.350	0.000	0.450
STEEL ERECTOR	ALL	40.750	42.750	2.0	2.0	2.0	13.20	19.09	0.000	0.350
STONE MASON	BLD	40.680	44.750	1.5	1.5	2.0	9.550	12.00	0.000	0.970
TERRAZZO FINISHER	BLD	35.510	0.000	1.5	1.5	2.0	9.700	9.320	0.000	0.400
TERRAZZO MASON	BLD	39.370	42.370	1.5	1.5	2.0	9.700	10.66	0.000	0.550
TILE MASON	BLD	41.430	45.430	2.0	1.5	2.0	9.700	8.640	0.000	0.710
TRAFFIC SAFETY WRKR	HWY	28.250	29.850	1.5	1.5	2.0	4.896	4.175	0.000	0.000
TRUCK DRIVER	ALL 1	35.850	36.400	1.5	1.5	2.0	7.200	6.000	0.000	0.150
TRUCK DRIVER	ALL 2	36.000	36.400	1.5	1.5	2.0	7.200	6.000	0.000	0.150
TRUCK DRIVER	ALL 3	36.200	36.400	1.5	1.5	2.0	7.200	6.000	0.000	0.150
TRUCK DRIVER	ALL 4	36.400	36.400	1.5	1.5	2.0	7.200	6.000	0.000	0.150

TUCKPOINTER BLD 40.950 41.950 1.5 1.5 2.0 8.180 10.82 0.000 0.940

Legend :

RG (Region)

TYP (Trade Type - All,Highway,Building,Floating,Oil & Chip,Rivers)

C (Class)

Base (Base Wage Rate)

FRMAN (Foreman Rate)

M-F>8 (OT required for any hour greater than 8 worked each day, Mon through Fri.

OSA (Overtime (OT) is required for every hour worked on Saturday)

OSH (Overtime is required for every hour worked on Sunday and Holidays)

H/W (Health & Welfare Insurance)

Pensn (Pension)

Vac (Vacation)

Trng (Training)

Explanations

LAKE COUNTY

The following list is considered as those days for which holiday rates of wages for work performed apply: New Years Day, Memorial Day, Fourth of July, Labor Day, Thanksgiving Day, Christmas Day and Veterans Day in some classifications/counties. Generally, any of these holidays which fall on a Sunday is celebrated on the following Monday. This then makes work performed on that Monday payable at the appropriate overtime rate for holiday pay. Common practice in a given local may alter certain days of celebration. If in doubt, please check with IDOL.

EXPLANATION OF CLASSES

ASBESTOS - GENERAL - removal of asbestos material/mold and hazardous materials from any place in a building, including mechanical systems where those mechanical systems are to be removed. This includes the removal of asbestos materials/mold and hazardous materials from ductwork or pipes in a building when the building is to be demolished at the time or at some close future date.

ASBESTOS - MECHANICAL - removal of asbestos material from mechanical systems, such as pipes, ducts, and boilers, where the mechanical systems are to remain.

CERAMIC TILE FINISHER

The grouting, cleaning, and polishing of all classes of tile, whether for interior or exterior purposes, all burned, glazed or unglazed products; all composition materials, granite tiles, warning detectable

tiles, cement tiles, epoxy composite materials, pavers, glass, mosaics, fiberglass, and all substitute materials, for tile made in tile-like units; all mixtures in tile like form of cement, metals, and other materials that are for and intended for use as a finished floor surface, stair treads, promenade roofs, walks, walls, ceilings, swimming pools, and all other places where tile is to form a finished interior or exterior. The mixing of all setting mortars including but not limited to thin-set mortars, epoxies, wall mud, and any other sand and cement mixtures or adhesives when used in the preparation, installation, repair, or maintenance of tile and/or similar materials. The handling and unloading of all sand, cement, lime, tile, fixtures, equipment, adhesives, or any other materials to be used in the preparation, installation, repair, or maintenance of tile and/or similar materials. Ceramic Tile Finishers shall fill all joints and voids regardless of method on all tile work, particularly and especially after installation of said tile work. Application of any and all protective coverings to all types of tile installations including, but not be limited to, all soap compounds, paper products, tapes, and all polyethylene coverings, plywood, masonite, cardboard, and any new type of products that may be used to protect tile installations, Blastrac equipment, and all floor scarifying equipment used in preparing floors to receive tile. The clean up and removal of all waste and materials. All demolition of existing tile floors and walls to be re-tiled.

COMMUNICATION TECHNICIAN

Low voltage construction, installation, maintenance and removal of telecommunication facilities (voice, sound, data and video) including outside plant, telephone, security systems and data inside wire, interconnect, terminal equipment, central offices, PABX, fiber optic cable and equipment, micro waves, V-SAT, bypass, CATV, WAN (wide area network), LAN (local area networks), and ISDN (integrated system digital network), pulling of wire in raceways, but not the installation of raceways.

MARBLE FINISHER

Loading and unloading trucks, distribution of all materials (all stone, sand, etc.), stocking of floors with material, performing all rigging for heavy work, the handling of all material that may be needed for the installation of such materials, building of scaffolding, polishing if needed, patching, waxing of material if damaged, pointing up, caulking, grouting and cleaning of marble, holding water on diamond or Carborundum blade or saw for setters cutting, use of tub saw or any other saw needed for preparation of material, drilling of holes for wires that anchor material set by setters, mixing up of molding plaster for installation of material, mixing up thin set for the installation of material, mixing up of sand to cement for the installation of material and such other work as may be required in helping a Marble Setter in the handling of all material in the erection or installation of interior marble, slate, travertine, art marble, serpentine, alberene stone, blue stone, granite and other stones (meaning as to stone any foreign or domestic materials as are specified and used in building interiors and exteriors and customarily known as stone in the trade), carrara, sanionyx, vitrolite and similar opaque glass and the laying of all marble tile, terrazzo tile, slate tile and precast tile, steps, risers treads, base, or any other materials that may be used as substitutes for any of the aforementioned materials and which are used on interior and exterior which are installed in a similar manner.

MATERIAL TESTER I: Hand coring and drilling for testing of materials; field inspection of uncured concrete and asphalt.

MATERIAL TESTER II: Field inspection of welds, structural steel, fireproofing, masonry, soil, facade, reinforcing steel, formwork, cured concrete, and concrete and asphalt batch plants; adjusting proportions of bituminous mixtures.

OPERATING ENGINEER - BUILDING

Class 1. Asphalt Plant; Asphalt Spreader; Autograde; Backhoes with Caisson Attachment; Batch Plant; Benoto (requires Two Engineers); Boiler and Throttle Valve; Caisson Rigs; Central Redi-Mix Plant; Combination Back Hoe Front End-loader Machine; Compressor and Throttle Valve; Concrete Breaker (Truck Mounted); Concrete Conveyor; Concrete Conveyor (Truck Mounted); Concrete Paver Over 27E cu. ft; Concrete Paver 27E cu. ft. and Under; Concrete Placer; Concrete Placing Boom; Concrete Pump (Truck Mounted); Concrete Tower; Cranes, All; Cranes, Hammerhead; Cranes, (GCI and similar Type); Creter Crane; Spider Crane; Crusher, Stone, etc.; Derricks, All; Derricks, Traveling; Formless Curb and Gutter Machine; Grader, Elevating; Grouting Machines; Heavy Duty Self-Propelled Transporter or Prime Mover; Highlift Shovels or Front Endloader 2-1/4 yd. and over; Hoists, Elevators, outside type rack and pinion and similar machines; Hoists, One, Two and Three Drum; Hoists, Two Tugger One Floor; Hydraulic Backhoes; Hydraulic Boom Trucks; Hydro Vac (and similar equipment); Locomotives, All; Motor Patrol; Lubrication Technician; Manipulators; Pile Drivers and Skid Rig; Post Hole Digger; Pre-Stress Machine; Pump Cretes Dual Ram; Pump Cretes: Squeeze Cretes-Screw Type Pumps; Gypsum Bulker and Pump; Raised and Blind Hole Drill; Roto Mill Grinder; Scoops - Tractor Drawn; Slip-Form Paver; Straddle Buggies; Operation of Tie Back Machine; Tournapull; Tractor with Boom and Side Boom; Trenching Machines.

Class 2. Boilers; Broom, All Power Propelled; Bulldozers; Concrete Mixer (Two Bag and Over); Conveyor, Portable; Forklift Trucks; Highlift Shovels or Front Endloaders under 2-1/4 yd.; Hoists, Automatic; Hoists, Inside Elevators; Hoists, Sewer Dragging Machine; Hoists, Tugger Single Drum; Laser Screed; Rock Drill (Self-Propelled); Rock Drill (Truck Mounted); Rollers, All; Steam Generators; Tractors, All; Tractor Drawn Vibratory Roller; Winch Trucks with "A" Frame.

Class 3. Air Compressor; Combination Small Equipment Operator; Generators; Heaters, Mechanical; Hoists, Inside Elevators (remodeling or renovation work); Hydraulic Power Units (Pile Driving, Extracting, and Drilling); Pumps, over 3" (1 to 3 not to exceed a total of 300 ft.); Low Boys; Pumps, Well Points; Welding Machines (2 through 5); Winches, 4 Small Electric Drill Winches.

Class 4. Bobcats and/or other Skid Steer Loaders; Oilers; and Brick Forklift.

Class 5. Assistant Craft Foreman.

Class 6. Gradall.

Class 7. Mechanics; Welders.

OPERATING ENGINEERS - HIGHWAY CONSTRUCTION

Class 1. Asphalt Plant; Asphalt Heater and Planer Combination; Asphalt Heater Scarfire; Asphalt Spreader; Autograder/GOMACO or other similar type machines: ABG Paver; Backhoes with Caisson Attachment; Ballast Regulator; Belt Loader; Caisson Rigs; Car Dumper; Central Redi-Mix Plant; Combination Backhoe Front Endloader Machine, (1 cu. yd. Backhoe Bucket or over or with attachments); Concrete Breaker (Truck

Mounted); Concrete Conveyor; Concrete Paver over 27E cu. ft.; Concrete Placer; Concrete Tube Float; Cranes, all attachments; Cranes, Tower Cranes of all types: Creter Crane: Spider Crane; Crusher, Stone, etc.; Derricks, All; Derrick Boats; Derricks, Traveling; Dredges; Elevators, Outside type Rack & Pinion and Similar Machines; Formless Curb and Gutter Machine; Grader, Elevating; Grader, Motor Grader, Motor Patrol, Auto Patrol, Form Grader, Pull Grader, Subgrader; Guard Rail Post Driver Truck Mounted; Hoists, One, Two and Three Drum; Heavy Duty Self-Propelled Transporter or Prime Mover; Hydraulic Backhoes; Backhoes with shear attachments up to 40' of boom reach; Lubrication Technician; Manipulators; Mucking Machine; Pile Drivers and Skid Rig; Pre-Stress Machine; Pump Cretes Dual Ram; Rock Drill - Crawler or Skid Rig; Rock Drill - Truck Mounted; Rock/Track Tamper; Roto Mill Grinder; Slip-Form Paver; Snow Melters; Soil Test Drill Rig (Truck Mounted); Straddle Buggies; Hydraulic Telescoping Form (Tunnel); Operation of Tieback Machine; Tractor Drawn Belt Loader; Tractor Drawn Belt Loader (with attached pusher - two engineers); Tractor with Boom; Tractaire with Attachments; Traffic Barrier Transfer Machine; Trenching; Truck Mounted Concrete Pump with Boom; Raised or Blind Hole Drills (Tunnel Shaft); Underground Boring and/or Mining Machines 5 ft. in diameter and over tunnel, etc; Underground Boring and/or Mining Machines under 5 ft. in diameter; Wheel Excavator; Widener (APSCO).

Class 2. Batch Plant; Bituminous Mixer; Boiler and Throttle Valve; Bulldozers; Car Loader Trailing Conveyors; Combination Backhoe Front Endloader Machine (Less than 1 cu. yd. Backhoe Bucket or over or with attachments); Compressor and Throttle Valve; Compressor, Common Receiver (3); Concrete Breaker or Hydro Hammer; Concrete Grinding Machine; Concrete Mixer or Paver 7S Series to and including 27 cu. ft.; Concrete Spreader; Concrete Curing Machine, Burlap Machine, Belting Machine and Sealing Machine; Concrete Wheel Saw; Conveyor Muck Cars (Haglund or Similar Type); Drills, All; Finishing Machine - Concrete; Highlift Shovels or Front Endloader; Hoist - Sewer Dragging Machine; Hydraulic Boom Trucks (All Attachments); Hydro-Blaster; Hydro Excavating (excluding hose work); Laser Screed; All Locomotives, Dinky; Off-Road Hauling Units (including articulating) Non Self-Loading Ejection Dump; Pump Cretes: Squeeze Cretes - Screw Type Pumps, Gypsum Bulker and Pump; Roller, Asphalt; Rotary Snow Plows; Rototiller, Seaman, etc., self-propelled; Self-Propelled Compactor; Spreader - Chip - Stone, etc.; Scraper - Single/Twin Engine/Push and Pull; Scraper - Prime Mover in Tandem (Regardless of Size); Tractors pulling attachments, Sheeps Foot, Disc, Compactor, etc.; Tug Boats.

Class 3. Boilers; Brooms, All Power Propelled; Cement Supply Tender; Compressor, Common Receiver (2); Concrete Mixer (Two Bag and Over); Conveyor, Portable; Farm-Type Tractors Used for Mowing, Seeding, etc.; Forklift Trucks; Grouting Machine; Hoists, Automatic; Hoists, All Elevators; Hoists, Tugger Single Drum; Jeep Diggers; Low Boys; Pipe Jacking Machines; Post-Hole Digger; Power Saw, Concrete Power Driven; Pug Mills; Rollers, other than Asphalt; Seed and Straw Blower; Steam Generators; Stump Machine; Winch Trucks with "A" Frame; Work Boats; Tamper-Form-Motor Driven.

Class 4. Air Compressor; Combination - Small Equipment Operator; Directional Boring Machine; Generators; Heaters, Mechanical; Hydraulic Power Unit (Pile Driving, Extracting, or Drilling); Light Plants, All (1 through 5); Pumps, over 3" (1 to 3 not to exceed a total of 300 ft.); Pumps, Well Points; Vacuum Trucks (excluding hose work); Welding Machines (2 through 5); Winches, 4 Small Electric Drill Winches.

Class 5. SkidSteer Loader (all); Brick Forklifts; Oilers.

Class 6. Field Mechanics and Field Welders

Class 7. Dowell Machine with Air Compressor; Gradall and machines of

like nature.

OPERATING ENGINEER - FLOATING

Class 1. Craft Foreman; Master Mechanic; Diver/Wet Tender; Engineer; Engineer (Hydraulic Dredge).

Class 2. Crane/Backhoe Operator; Boat Operator with towing endorsement; Mechanic/Welder; Assistant Engineer (Hydraulic Dredge); Leverman (Hydraulic Dredge); Diver Tender.

Class 3. Deck Equipment Operator, Machineryman, Maintenance of Crane (over 50 ton capacity) or Backhoe (115,000 lbs. or more); Tug/Launch Operator; Loader/Dozer and like equipment on Barge, Breakwater Wall, Slip/Dock, or Scow, Deck Machinery, etc.

Class 4. Deck Equipment Operator, Machineryman/Fireman (4 Equipment Units or More); Off Road Trucks; Deck Hand, Tug Engineer, Crane Maintenance (50 Ton Capacity and Under) or Backhoe Weighing (115,000 pounds or less); Assistant Tug Operator.

Class 5. Friction or Lattice Boom Cranes.

TRAFFIC SAFETY - work associated with barricades, horses and drums used to reduce lane usage on highway work, the installation and removal of temporary lane markings, and the installation and removal of temporary road signs.

TRUCK DRIVER - BUILDING, HEAVY AND HIGHWAY CONSTRUCTION

Class 1. Two or three Axle Trucks. A-frame Truck when used for transportation purposes; Air Compressors and Welding Machines, including those pulled by cars, pick-up trucks and tractors; Ambulances; Batch Gate Lockers; Batch Hopperman; Car and Truck Washers; Carry-alls; Fork Lifts and Hoisters; Helpers; Mechanics Helpers and Greasers; Oil Distributors 2-man operation; Pavement Breakers; Pole Trailer, up to 40 feet; Power Mower Tractors; Self-propelled Chip Spreader; Skipman; Slurry Trucks, 2-man operation; Slurry Truck Conveyor Operation, 2 or 3 man; Teamsters; Unskilled Dumpman; and Truck Drivers hauling warning lights, barricades, and portable toilets on the job site.

Class 2. Four axle trucks; Dump Crets and Adgetors under 7 yards; Dumpsters, Track Trucks, Euclids, Hug Bottom Dump Turnapulls or Turnatrailers when pulling other than self-loading equipment or similar equipment under 16 cubic yards; Mixer Trucks under 7 yards; Ready-mix Plant Hopper Operator, and Winch Trucks, 2 Axles.

Class 3. Five axle trucks; Dump Crets and Adgetors 7 yards and over; Dumpsters, Track Trucks, Euclids, Hug Bottom Dump Turnatrailers or turnapulls when pulling other than self-loading equipment or similar equipment over 16 cubic yards; Explosives and/or Fission Material Trucks; Mixer Trucks 7 yards or over; Mobile Cranes while in transit; Oil Distributors, 1-man operation; Pole Trailer, over 40 feet; Pole and Expandable Trailers hauling material over 50 feet long; Slurry trucks, 1-man operation; Winch trucks, 3 axles or more; Mechanic--Truck Welder and Truck Painter.

Class 4. Six axle trucks; Dual-purpose vehicles, such as mounted crane trucks with hoist and accessories; Foreman; Master Mechanic; Self-loading equipment like P.B. and trucks with scoops on the front.

TERRAZZO FINISHER

The handling of sand, cement, marble chips, and all other materials that may be used by the Mosaic Terrazzo Mechanic, and the mixing, grinding, grouting, cleaning and sealing of all Marble, Mosaic, and Terrazzo work, floors, base, stairs, and wainscoting by hand or machine, and in addition, assisting and aiding Marble, Masonic, and Terrazzo Mechanics.

Other Classifications of Work:

For definitions of classifications not otherwise set out, the Department generally has on file such definitions which are available. If a task to be performed is not subject to one of the classifications of pay set out, the Department will upon being contacted state which neighboring county has such a classification and provide such rate, such rate being deemed to exist by reference in this document. If no neighboring county rate applies to the task, the Department shall undertake a special determination, such special determination being then deemed to have existed under this determination. If a project requires these, or any classification not listed, please contact IDOL at 217-782-1710 for wage rates or clarifications.

LANDSCAPING

Landscaping work falls under the existing classifications for laborer, operating engineer and truck driver. The work performed by landscape plantsman and landscape laborer is covered by the existing classification of laborer. The work performed by landscape operators (regardless of equipment used or its size) is covered by the classifications of operating engineer. The work performed by landscape truck drivers (regardless of size of truck driven) is covered by the classifications of truck driver.

La Salle County Prevailing Wage for May 2013

(See explanation of column headings at bottom of wages)

Trade Name	RG	TYP	C	Base	FRMAN	M-F>8	OSA	OSH	H/W	Pensn	Vac	Trng
=====	==	===	=	=====	=====	=====	===	===	=====	=====	=====	=====
ASBESTOS ABT-GEN		ALL		29.530	30.780	1.5	1.5	2.0	8.240	8.630	0.000	0.800
ASBESTOS ABT-MEC		BLD		34.160	36.660	1.5	1.5	2.0	10.82	10.66	0.000	0.720
BOILERMAKER		BLD		35.010	38.010	2.0	2.0	2.0	7.070	13.83	0.000	0.300
BRICK MASON		BLD		36.720	37.720	1.5	1.5	2.0	8.720	7.950	0.000	0.580
CARPENTER		BLD		30.250	32.370	1.5	1.5	2.0	8.900	13.68	0.000	0.570
CARPENTER		HWY		30.250	32.000	1.5	1.5	2.0	8.830	13.34	0.000	0.500
CEMENT MASON		ALL		35.000	36.250	2.0	2.0	2.0	7.700	11.67	0.000	0.500
CERAMIC TILE FNSHER		BLD		32.410	0.000	1.5	1.5	2.0	7.700	4.840	0.000	0.530
COMMUNICATION TECH		BLD		31.200	32.700	1.5	1.5	2.0	12.32	10.77	0.000	0.320
ELECTRIC PWR EQMT OP		ALL		35.440	0.000	1.5	1.5	2.0	5.000	10.98	0.000	0.270
ELECTRIC PWR GRNDMAN		ALL		24.320	0.000	1.5	1.5	2.0	5.000	7.540	0.000	0.180
ELECTRIC PWR LINEMAN		ALL		39.370	41.910	1.5	1.5	2.0	5.000	12.20	0.000	0.300
ELECTRIC PWR TRK DRV		ALL		25.510	0.000	1.5	1.5	2.0	5.000	7.920	0.000	0.190
ELECTRICIAN	N	BLD		39.100	42.620	1.5	1.5	2.0	13.17	15.10	0.000	1.200
ELECTRICIAN	S	BLD		37.090	39.090	1.5	1.5	2.0	5.350	7.760	0.000	0.560
ELEVATOR CONSTRUCTOR		BLD		40.520	45.585	2.0	2.0	2.0	11.88	12.71	3.240	0.600
GLAZIER		BLD		30.770	32.770	1.5	1.5	2.0	9.700	7.700	0.000	1.250
HT/FROST INSULATOR		BLD		45.550	48.050	1.5	1.5	2.0	10.82	11.86	0.000	0.720
IRON WORKER		ALL		38.500	39.500	2.0	2.0	2.0	9.390	18.84	0.000	0.700
LABORER		ALL		28.530	29.780	1.5	1.5	2.0	8.240	8.630	0.000	0.800
LABORER, SKILLED		ALL		28.930	30.180	1.5	1.5	2.0	8.240	8.630	0.000	0.800
LATHER		BLD		30.250	32.370	1.5	1.5	2.0	8.900	13.68	0.000	0.570
MACHINIST		BLD		43.550	46.050	1.5	1.5	2.0	6.130	8.950	1.850	0.000
MARBLE FINISHERS		BLD		32.410	0.000	1.5	1.5	2.0	7.700	4.840	0.000	0.530

MARBLE MASON		BLD	35.090	35.340	1.5	1.5	2.0	7.700	7.150	0.000	0.560
MILLWRIGHT		BLD	34.400	37.840	1.5	1.5	2.0	8.770	13.85	0.000	0.500
MILLWRIGHT		HWY	34.120	37.530	1.5	1.5	2.0	8.770	13.85	0.000	0.500
OPERATING ENGINEER		BLD 1	43.300	47.300	2.0	2.0	2.0	15.70	10.55	1.900	1.250
OPERATING ENGINEER		BLD 2	42.000	47.300	2.0	2.0	2.0	15.70	10.55	1.900	1.250
OPERATING ENGINEER		BLD 3	39.450	47.300	2.0	2.0	2.0	15.70	10.55	1.900	1.250
OPERATING ENGINEER		BLD 4	37.700	47.300	2.0	2.0	2.0	15.70	10.55	1.900	1.250
OPERATING ENGINEER		BLD 5	46.300	47.300	2.0	2.0	2.0	15.70	10.55	1.900	1.250
OPERATING ENGINEER		BLD 6	46.300	47.300	2.0	2.0	2.0	15.70	10.55	1.900	1.250
OPERATING ENGINEER		BLD 7	44.300	47.300	2.0	2.0	2.0	15.70	10.55	1.900	1.250
OPERATING ENGINEER		HWY 1	43.300	47.300	1.5	1.5	2.0	15.70	10.55	1.900	1.250
OPERATING ENGINEER		HWY 2	42.750	47.300	1.5	1.5	2.0	15.70	10.55	1.900	1.250
OPERATING ENGINEER		HWY 3	40.700	47.300	1.5	1.5	2.0	15.70	10.55	1.900	1.250
OPERATING ENGINEER		HWY 4	39.300	47.300	1.5	1.5	2.0	15.70	10.55	1.900	1.250
OPERATING ENGINEER		HWY 5	38.100	47.300	1.5	1.5	2.0	15.70	10.55	1.900	1.250
OPERATING ENGINEER		HWY 6	46.300	47.300	1.5	1.5	2.0	15.70	10.55	1.900	1.250
OPERATING ENGINEER		HWY 7	44.300	47.300	1.5	1.5	2.0	15.70	10.55	1.900	1.250
PAINTER		ALL	32.900	34.900	1.5	1.5	1.5	9.650	8.200	0.000	1.250
PAINTER SIGNS		BLD	33.920	38.090	1.5	1.5	1.5	2.600	2.710	0.000	0.000
PILEDRIVER		BLD	30.500	33.550	1.5	1.5	2.0	8.900	13.68	0.000	0.570
PILEDRIVER		HWY	30.250	32.000	1.5	1.5	2.0	8.830	13.34	0.000	0.500
PIPEFITTER		BLD	45.050	48.050	1.5	1.5	2.0	8.460	14.85	0.000	1.780
PLASTERER	N	BLD	35.000	36.250	2.0	2.0	2.0	7.700	11.67	0.000	0.500
PLASTERER	S	BLD	39.250	41.610	1.5	1.5	2.0	10.60	10.69	0.000	0.550
PLUMBER		BLD	45.000	47.000	1.5	1.5	2.0	12.53	10.06	0.000	0.880
ROOFER		BLD	30.210	32.210	1.5	1.5	2.0	8.280	8.770	0.000	0.430
SHEETMETAL WORKER		BLD	35.360	37.010	1.5	1.5	2.0	8.020	12.70	0.000	0.650
SPRINKLER FITTER		BLD	36.390	39.140	1.5	1.5	2.0	8.420	8.500	0.000	0.450
STONE MASON		BLD	36.720	37.720	1.5	1.5	2.0	8.720	7.950	0.000	0.580
TERRAZZO FINISHER		BLD	32.410	0.000	1.5	1.5	2.0	7.700	4.840	0.000	0.530
TILE LAYER		BLD	30.250	32.370	1.5	1.5	2.0	8.900	13.68	0.000	0.570
TILE MASON		BLD	35.090	35.340	1.5	1.5	2.0	7.700	7.150	0.000	0.560
TRUCK DRIVER		ALL 1	31.230	0.000	1.5	1.5	2.0	10.30	4.840	0.000	0.250
TRUCK DRIVER		ALL 2	31.680	0.000	1.5	1.5	2.0	10.30	4.840	0.000	0.250
TRUCK DRIVER		ALL 3	31.890	0.000	1.5	1.5	2.0	10.30	4.840	0.000	0.250
TRUCK DRIVER		ALL 4	32.180	0.000	1.5	1.5	2.0	10.30	4.840	0.000	0.250
TRUCK DRIVER		ALL 5	33.020	0.000	1.5	1.5	2.0	10.30	4.840	0.000	0.250
TRUCK DRIVER		O&C 1	24.980	0.000	1.5	1.5	2.0	10.30	4.840	0.000	0.250
TRUCK DRIVER		O&C 2	25.340	0.000	1.5	1.5	2.0	10.30	4.840	0.000	0.250
TRUCK DRIVER		O&C 3	25.510	0.000	1.5	1.5	2.0	10.30	4.840	0.000	0.250
TRUCK DRIVER		O&C 4	25.740	0.000	1.5	1.5	2.0	10.30	4.840	0.000	0.250
TRUCK DRIVER		O&C 5	26.420	0.000	1.5	1.5	2.0	10.30	4.840	0.000	0.250
TUCKPOINTER		BLD	36.720	37.720	1.5	1.5	2.0	8.720	7.950	0.000	0.580

Legend :

RG (Region)

TYP (Trade Type - All,Highway,Building,Floating,Oil & Chip,Rivers)

C (Class)

Base (Base Wage Rate)

FRMAN (Foreman Rate)

M-F>8 (OT required for any hour greater than 8 worked each day, Mon through Fri.)

OSA (Overtime (OT) is required for every hour worked on Saturday)

OSH (Overtime is required for every hour worked on Sunday and Holidays)

H/W (Health & Welfare Insurance)

Pensn (Pension)

Vac (Vacation)

Trng (Training)

Explanations

LASALLE COUNTY

ELECTRICIANS (NORTH) - Townships of Mendota, Meriden, Earl, Adams, Troy Grove, Ophir, Northville, Freedom, Serena, Mission, Dimmick, Waltham, Wallace, Dayton, Rutland, Miller, Manlius, Peru, LaSalle, Utica, Ottawa, South Ottawa, Eden, Vermilion, Deer Park, Farm Ridge.

MILLWRIGHTS (EAST) - The Eastern 1/3 of the county (approx.).

The following list is considered as those days for which holiday rates of wages for work performed apply: New Years Day, Memorial Day, Fourth of July, Labor Day, Thanksgiving Day, Christmas Day and Veterans Day in some classifications/counties. Generally, any of these holidays which fall on a Sunday is celebrated on the following Monday. This then makes work performed on that Monday payable at the appropriate overtime rate for holiday pay. Common practice in a given local may alter certain days of celebration. If in doubt, please check with IDOL.

Oil and chip resealing (O&C) means the application of road oils and liquid asphalt to coat an existing road surface, followed by application of aggregate chips or gravel to coated surface, and subsequent rolling of material to seal the surface.

EXPLANATION OF CLASSES

ASBESTOS - GENERAL - removal of asbestos material/mold and hazardous materials from any place in a building, including mechanical systems where those mechanical systems are to be removed. This includes the removal of asbestos materials/mold and hazardous materials from ductwork or pipes in a building when the building is to be demolished at the time or at some close future date.

ASBESTOS - MECHANICAL - removal of asbestos material from mechanical systems, such as pipes, ducts, and boilers, where the mechanical systems are to remain.

CERAMIC TILE FINISHER, MARBLE FINISHER, TERRAZO FINISHER

Assisting, helping or supporting the tile, marble and terrazzo mechanic by performing their historic and traditional work assignments required to complete the proper installation of the work covered by said crafts. The term "Ceramic" is used for naming the classification only and is in no way a limitation of the product handled. Ceramic takes into consideration most hard tiles.

COMMUNICATIONS TECHNICIAN

Installation, operation, inspection, maintenance, repair and service of radio, television, recording, voice, sound and vision production and reproduction, telephone and telephone interconnect, facsimile, equipment and appliances used for domestic, commercial, educational and entertainment purposes, pulling of wire through conduit but not the installation of conduit.

LABORER, SKILLED - BUILDING AND HIGHWAY

The skilled laborer building (BLD) and heavy & highway (HWY) classification shall encompass the following types of work, irrespective of the site of the work: flagging, caisson worker plus depth, gunnite nozzle men, lead man on sewer work, welders, cutter burners and torchmen, chain saw operator, paving breaker, jackhammer and drill operators, layout man and/or drainage tile layer, steel form setter - street and highway, air tamping hammerman, signal man on crane, concrete saw operator, concrete saw operator walk behind, screenman on asphalt pavers, front end man on chip spreader, laborers tending masons with hot material or where foreign materials are used, multiple concrete duct - leadman, luteman, asphalt raker, curb asphalt machine operator, ready mix scalemen (permanent, portable or temporary plant), laborers handling masterplate or similar materials, laser beam operator, coring machine operator, plaster tenders, underpinning and shoring of buildings, material selector when working with fire-brick or castable material, fire watch, signaling of all power equipment, tree topper or trimmer when in connection with construction, and diver tender.

OPERATING ENGINEERS - BUILDING

Class 1. Mechanic; Asphalt Plant; Asphalt Spreader; Autograde; Backhoes w/Caisson attachment; Batch Plant; Benoto (require 2 engineers); Boiler and Throttle Valve; Caisson Rigs; Central Redi-Mix Plant; Combination Back Hoe Front End-Loader Machine; Compressor and Throttle Valve; Concrete Breaker (Truck Mounted); Concrete Conveyor; Concrete Paver over 27E cu. ft.; Concrete Paver 27E cu.ft. and under; Concrete Placer; Concrete Pump (Truck Mounted); Concrete Tower; Cranes, All; Cranes Hammerhead; Creter Crane; Spider Crane; Crusher, Stone, etc.; Derricks, All; Derricks, Traveling; Formless Curb and Gutter Machine; Grader, Elevating; Grouting Machines; Heavy Duty Self-Propelled Transporter or Prime Mover; Highlift Shovels or Front Endloader 2-1/4 yd. and over; Hoists, Elevators, outside type rack and pinion and similar machines; Hoists, One, Two and Three Drum; Hoists, Two Tugger One Floor; Hydraulic Backhoes; Hydraulic Boom Trucks; Hydro Vac (and similar equipment); Locomotives, All; Lubrication Technician; Manipulators; Motor Patrol; Pile Drivers and Skid Rig; Post Hole Digger; Pre-Stress Machine; Pump Cretes Dual Ram; Squeeze Cretes - Screw Type Pumps; Gypsum Bulker and Pump; Roto Mill Grinder; Scoops - Tractor Drawn; Slip-Form Paver; Straddle Buggies; Operation or Tieback Machine; Tournapull; Tractor with Boom and Side Boom; Trenching Machines.

Class 2. Boilers; Brick Forklift servicing seven (7) or more Brick Masons; Broom, All Power Propelled; Bulldozers; Concrete Mixer (Two Bag and Over); Conveyor, Portable; Forklift Trucks; Highlift Shovels or Front Endloaders under 2-1/4 yd; Hoists, Automatic; Hoists, inside Freight Elevators; Hoists, Sewer Dragging Machine; Hoists, Tugger Single Drum; Hydro Excavating (excluding hose work); Laser Screed; Rock Drill (self-propelled); Non Self-Loading Ejection Dump; Rock Drill (Truck Mounted); Rollers, All; Steam Generators; Tractors, All; Tractor Drawn Vibratory Roller; Winch Trucks with "A" Frame.

Class 3. Air Compressors; Combination - Small Equipment Operator; Generators; Heaters, Mechanical; Hoists, Inside Elevators - (Rheostat Manual Controlled); Hoists, Inside Elevators; Hydraulic Power Units (Pile Driving and Extracting); Lowboys; Pumps, over 3" (1 to 3 not to exceed a total of 300 ft.); Pumps, Well Points; Welding Machines (2 through 5); Winches, 4 Small Electric Drill Winches.

Class 4. Brick Forklift; Boom Trucks (Residential); Hoists, Inside

Elevators push button with automatic doors; Oilers; Skidsteer Loaders; Vacuum Trucks (excluding hose work).

Class 5. Assistant Craft Foreman

Class 6. Mechanics and Welders

Class 7. Gradall

OPERATING ENGINEERS - HIGHWAY CONSTRUCTION

Class 1. Asphalt Plant; Asphalt Heater and Planer Combination; Asphalt Heater Scarfire; Asphalt Spreader; Autograder/Gomaco or other similar type machines: ABG Paver; Backhoes with Caisson Attachment; Belt Loader; Caisson Rigs; Car Dumper; Central Redi-Mix Plant; Combination Backhoe Front Endloader Machine; Concrete Breaker (Truck Mounted); Concrete Conveyor; Concrete Paver over 27E cu. ft.; Concrete Placer; Concrete Tube Float; Cranes, all attachments; Cranes, Tower of all types; Creter Crane; Spider Crane; Crusher, Stone, etc.; Derricks, All; Derrick Boats; Derricks, Traveling; Dredges; Elevators, Outside Type Rack & Pinion and Similar Machines; Formless Curb and Gutter Machine; Grader, Elevating; Grader, Motor Grader, Motor Patrol, Auto Patrol, Form Grader, Pull Grader, Subgrader; Guard Rail Post Driver Truck Mounted; Heavy Duty Self-Propelled Transporter or Prime Mover; Hoists, One, Two and Three Drum; Hydraulic Backhoes; Locomotives, All; Backhoes with Shear Attachments; Lubrication Technician; Manipulators; Mucking Machine; Pile Drivers and Skid Rig; Pre-Stress Machine; Pump Cretes Dual Ram; Rock Drill-Crawler or Skid Rig; Rock Drill - Truck Mounted; Roto Mill Grinder; Slip-Form Paver; Snow Melters; Soil Test Drill Rig (Truck Mounted); Straddle Buggies; Hydraulic Telescoping Form (Tunnel); Operation of Tieback Machine; Tractor Drawn Belt Loader; Tractor Drawn Belt Loader with attached pusher; Tractor with Boom; Tractaire with Attachments; Transfer Barrier Transfer Machine; Trenching Machine; Truck Mounted Concrete Pump with Boom; Raised or Blind Hole Drills (Tunnel Shaft); Underground Boring and/or Mining Machine; Wheel Excavator; Widener (APSCO).

Class 2. Batch Plant; Bituminous Mixer; Boiler and Throttle Valve; Bulldozers; Car Loader Trailing Conveyors; Combination Backhoe Front Endloader Machine (less than 1 cu. yd. Backhoe Bucket or over or with attachments); Compressor and Throttle Valve; Compressor, Common Receiver (3); Concrete Breaker or Hydro Hammer; Concrete Grinding Machine; Concrete Mixer or Paver 7S Series to and including 27 cu. ft.; Concrete Spreader; Concrete Curing Machine, Burlap Machine, Belting Machine and Sealing Machine; Concrete Wheel Saw; Conveyor Muck Cars (Haglund or Similar Type); Drills, All; Finishing Machine - Concrete; Forklifts; Highlift Shovels or Front Endloader; Hoist - Sewer Dragging Machine; Hydraulic Boom Trucks (All Attachments); Hydro-Blaster (requires 2 operators; one being Class 4); Hydro Excavating (excluding hose work); Laser Screed; Locomotives, Dinky; Oil Distributor; Off-Road Hauling Units (Including Articulating); Non Self-Loading Ejection Dump; Pump Cretes; Squeeze Cretes - Screw Type Pumps, Gypsum Bulker and Pump; Roller, Asphalt; Rotary Snow Plows; Rototiller, Seaman, etc., Self-Propelled; Self-Propelled Compactor; Spreader - Chip - Stone, etc.; Scraper; Scraper - Prime Mover in Tandem; Tractors, Push, Pulling Sheeps Foot, Disc, Compactor, etc.; Tug Boats; Mechanic Welders working in permanent shop.

Class 3. Boilers; Brooms, All Power Propelled; Cement Supply Tender; Compressor, Common Receiver (2); Concrete Mixer (Two Bag and Over); Conveyor, Portable; Farm-Type Tractors Used for Mowing, Seeding, etc.; Grouting Machine; Hoists, Automatic; Hoists, All Elevators; Hoists, Tugger Single Drum; Jeep Diggers; Low Boys; Pipe Jacking Machine;

Post-Hole Digger; Power Saw, Concrete Power Driven; Pug Mills; Rollers, other than asphalt; Seed and Straw Blower; Steam Generators; Stump Machine Heaters, Mechanical; Winch Trucks with "A" Frame; Work Boats; Tamper - Form - Motor Driven.

Class 4. Air Compressor; Brick Forklifts (Servicing Seven (7) or more Brick Masons; Combination - Small Equipment Operator; Directional Boring Machine; Generators; Heaters, Mechanical; Hydraulic Power Unit (Pile Driving, Extracting, or Drilling); Hydro-Blaster (requires 2 operators - one being class 2); Light Plants, All (1 through 5); Pumps, over 3" (1 to 3 not to exceed a total of 300 ft.); Pumps, Well Points; Tractaire; Vacuum Trucks (excluding hose work); Welding Machines (2 through 5); Winches, 4 Small Electric Drill Winches.

Class 5. Brick Forklifts; Oilers; Skidsteer Loaders (All).

Class 6. Field Mechanics and Field Welders.

Class 7. Dowell Machine with Air Compressor; Gradall and machines of like nature.

TRUCK DRIVER - BUILDING, HEAVY AND HIGHWAY CONSTRUCTION

Class 1. Drivers on 2 axle trucks hauling less than 9 ton. Air compressor and welding machines and brooms, including those pulled by separate units, truck driver helpers, warehouse employees, mechanic helpers, greasers and tiremen, pickup trucks when hauling materials, tools, or workers to and from and on-the-job site, and fork lifts up to 6,000 lb. capacity.

Class 2. Two or three axle trucks hauling more than 9 ton but hauling less than 16 ton. A-frame winch trucks, hydrolift trucks, vector trucks or similar equipment when used for transportation purposes. Fork lifts over 6,000 lb. capacity, winch trucks, four axle combination units, and ticket writers.

Class 3. Two, three or four axle trucks hauling 16 ton or more. Drivers on water pulls, articulated dump trucks, mechanics and working forepersons, and dispatchers. Five axle or more combination units.

Class 4. Low Boy and Oil Distributors.

Class 5. Drivers who require special protective clothing while employed on hazardous waste work.

TRUCK DRIVER - OIL AND CHIP RESEALING ONLY.

This shall encompass laborers, workers and mechanics who drive contractor or subcontractor owned, leased, or hired pickup, dump, service, or oil distributor trucks. The work includes transporting materials and equipment (including but not limited to, oils, aggregate supplies, parts, machinery and tools) to or from the job site; distributing oil or liquid asphalt and aggregate; stock piling material when in connectin with the actual oil and chip contract. The Truck Driver (Oil & Chip Resealing) wage classification does not include supplier delivered materials.

Other Classifications of Work:

For definitions of classifications not otherwise set out, the Department generally has on file such definitions which are available. If a task to be performed is not subject to one of the classifications of pay set out, the Department will upon being contacted state which neighboring county has such a classification and provide such rate, such rate being deemed to exist by reference in

this document. If no neighboring county rate applies to the task, the Department shall undertake a special determination, such special determination being then deemed to have existed under this determination. If a project requires these, or any classification not listed, please contact IDOL at 217-782-1710 for wage rates or clarifications.

LANDSCAPING

Landscaping work falls under the existing classifications for laborer, operating engineer and truck driver. The work performed by landscape plantsman and landscape laborer is covered by the existing classification of laborer. The work performed by landscape operators (regardless of equipment used or its size) is covered by the classifications of operating engineer. The work performed by landscape truck drivers (regardless of size of truck driven) is covered by the classifications of truck driver.

Lawrence County Prevailing Wage for May 2013

(See explanation of column headings at bottom of wages)

Trade Name	RG	TYP	C	Base	FRMAN	M-F>8	OSA	OSH	H/W	Pensn	Vac	Trng
=====	==	===	=	=====	=====	=====	===	===	=====	=====	=====	=====
ASBESTOS ABT-GEN		ALL		25.300	25.750	1.5	1.5	2.0	5.750	10.35	0.000	0.900
ASBESTOS ABT-MEC		BLD		21.150	22.150	1.5	1.5	2.0	6.400	5.150	0.000	0.650
BOILERMAKER		BLD		31.500	34.000	1.5	1.5	2.0	7.070	18.73	1.000	0.350
BRICK MASON		BLD		28.620	30.120	1.5	1.5	2.0	8.200	7.030	0.000	0.430
CARPENTER		BLD		31.890	33.390	1.5	1.5	2.0	6.550	6.750	0.000	0.400
CARPENTER		HWY		31.890	33.640	1.5	1.5	2.0	6.550	6.750	0.000	0.400
CEMENT MASON		BLD		29.800	31.300	1.5	1.5	2.0	6.600	8.360	0.000	0.500
CEMENT MASON		HWY		27.080	28.580	1.5	1.5	2.0	6.600	5.800	0.000	0.300
CERAMIC TILE FNSHER		BLD		27.120	0.000	1.5	1.5	2.0	8.200	7.030	0.000	0.430
COMM SYSTEMS TECH		BLD		26.110	28.700	1.5	1.5	2.0	5.350	5.680	0.000	0.290
ELECTRIC PWR EQMT OP		ALL	1	35.570	0.000	1.5	1.5	2.0	5.000	9.960	0.000	0.360
ELECTRIC PWR EQMT OP		ALL	2	31.740	0.000	1.5	1.5	2.0	5.000	8.880	0.000	0.320
ELECTRIC PWR GRNDMAN		ALL		26.100	0.000	1.5	1.5	2.0	5.000	7.310	0.000	0.260
ELECTRIC PWR LINEMAN		ALL		44.630	47.650	1.5	1.5	2.0	5.000	12.50	0.000	0.450
ELECTRICIAN		BLD		34.920	37.360	1.5	1.5	2.0	5.350	9.030	0.000	0.290
FLOOR LAYER		BLD		29.330	30.080	1.5	1.5	2.0	6.550	6.750	0.000	0.400
GLAZIER		BLD		26.780	28.030	1.5	1.5	2.0	6.120	5.200	0.000	0.300
HT/FROST INSULATOR		BLD		29.450	30.450	1.5	1.5	2.0	5.050	9.730	0.000	0.280
IRON WORKER		ALL		27.020	28.270	1.5	1.5	2.0	7.010	9.200	0.000	0.345
LABORER		BLD		25.300	25.750	1.5	1.5	2.0	5.750	10.35	0.000	0.800
LABORER		HWY		25.300	25.750	1.5	1.5	2.0	5.750	10.35	0.000	0.800
MACHINIST		BLD		43.550	46.050	1.5	1.5	2.0	6.130	8.950	1.850	0.000
MARBLE FINISHERS		BLD		27.120	0.000	1.5	1.5	2.0	8.200	7.030	0.000	0.430
MARBLE MASON		BLD		28.620	30.120	1.5	1.5	2.0	8.200	7.030	0.000	0.430
MILLWRIGHT		BLD		31.890	33.390	1.5	1.5	2.0	6.550	6.750	0.000	0.400
MILLWRIGHT		HWY		32.390	34.140	1.5	1.5	2.0	6.550	6.750	0.000	0.400
OPERATING ENGINEER		ALL	1	36.950	0.000	1.5	1.5	2.0	7.250	8.700	0.000	0.800
OPERATING ENGINEER		ALL	2	23.900	0.000	1.5	1.5	2.0	7.250	8.700	0.000	0.800
PAINTER		ALL		26.000	27.500	1.5	1.5	2.0	7.700	8.230	0.000	0.450
PILEDRIVER		BLD		31.890	33.390	1.5	1.5	2.0	6.550	6.750	0.000	0.400
PILEDRIVER		HWY		32.390	34.140	1.5	1.5	2.0	6.550	6.750	0.000	0.400
PIPEFITTER		BLD		33.640	35.660	1.5	1.5	2.0	6.100	8.310	0.000	0.800
PLASTERER		BLD		30.000	32.000	1.5	1.5	2.0	6.600	10.17	0.000	0.500
PLUMBER		BLD		33.640	35.660	1.5	1.5	2.0	6.100	8.310	0.000	0.800
ROOFER		BLD		26.500	29.500	1.5	1.5	2.0	4.600	5.100	0.000	0.350
SHEETMETAL WORKER		BLD		31.390	32.960	1.5	1.5	2.0	7.350	7.690	0.000	1.090
SPRINKLER FITTER		BLD		36.390	39.140	1.5	1.5	2.0	8.420	8.500	0.000	0.450
STONE MASON		BLD		28.620	30.120	1.5	1.5	2.0	8.200	7.030	0.000	0.430
TERRAZZO FINISHER		BLD		27.120	0.000	1.5	1.5	2.0	8.200	7.030	0.000	0.430
TILE MASON		BLD		28.620	30.120	1.5	1.5	2.0	8.200	7.030	0.000	0.430

TRUCK DRIVER	ALL	1	28.955	0.000	1.5	1.5	2.0	9.300	2.900	0.000	0.250
TRUCK DRIVER	ALL	2	29.355	0.000	1.5	1.5	2.0	9.300	2.900	0.000	0.250
TRUCK DRIVER	ALL	3	29.555	0.000	1.5	1.5	2.0	9.300	2.900	0.000	0.250
TRUCK DRIVER	ALL	4	29.805	0.000	1.5	1.5	2.0	9.300	2.900	0.000	0.250
TRUCK DRIVER	ALL	5	30.555	0.000	1.5	1.5	2.0	9.300	2.900	0.000	0.250
TUCKPOINTER	BLD		28.620	30.120	1.5	1.5	2.0	8.200	7.030	0.000	0.430

Legend:

RG (Region)

TYP (Trade Type - All,Highway,Building,Floating,Oil & Chip,Rivers)

C (Class)

Base (Base Wage Rate)

FRMAN (Foreman Rate)

M-F>8 (OT required for any hour greater than 8 worked each day, Mon through Fri.

OSA (Overtime (OT) is required for every hour worked on Saturday)

OSH (Overtime is required for every hour worked on Sunday and Holidays)

H/W (Health & Welfare Insurance)

Pensn (Pension)

Vac (Vacation)

Trng (Training)

Explanations

LAWRENCE COUNTY

The following list is considered as those days for which holiday rates of wages for work performed apply: New Years Day, Memorial Day, Fourth of July, Labor Day, Thanksgiving Day, Christmas Day and Veterans Day in some classifications/counties. Generally, any of these holidays which fall on a Sunday is celebrated on the following Monday. This then makes work performed on that Monday payable at the appropriate overtime rate for holiday pay. Common practice in a given local may alter certain days of celebration. If in doubt, please check with IDOL.

EXPLANATION OF CLASSES

ASBESTOS - GENERAL - removal of asbestos material/mold and hazardous materials from any place in a building, including mechanical systems where those mechanical systems are to be removed. This includes the removal of asbestos materials/mold and hazardous materials from ductwork or pipes in a building when the building is to be demolished at the time or at some close future date.

ASBESTOS - MECHANICAL - removal of asbestos material from mechanical systems, such as pipes, ducts, and boilers, where the mechanical systems are to remain.

CERAMIC TILE FINISHER, MARBLE FINISHER, TERRAZZO FINISHER

Assisting, helping or supporting the tile, marble and terrazzo mechanic by performing their historic and traditional work assignments required to complete the proper installation of the work covered by said crafts. The term "Ceramic" is used for naming the classification only, and is in no a limitation of the product handled. Ceramic takes into consideration most hard tiles.

COMMUNICATION SYSTEMS TECHNICIAN

Installation, operation, inspection, maintenance, repair, and service of radio, television, recording, voice sound and vision production and reproduction apparatus, equipment and appliances used for domestic, commercial, education, entertainment and private telephone systems.

ELECTRIC POWER LINEMAN

Construction, maintenance and dismantling of overhead and underground electric power lines, including high voltage pipe type cable work, and associated structures and equipment.

ELECTRIC POWER EQUIPMENT OPERATOR - CLASS 1

Operation of all crawler type equipment D-4 and larger from the ground to assist the Electric Power Linemen in performing their duties.

ELECTRIC POWER EQUIPMENT OPERATORS - CLASS 2

Operation of all other equipment from the ground to assist the Electric Power Linemen in performing their duties.

ELECTRIC POWER GROUNDMAN

Applies to workers who assist the Electric Power Lineman from the ground.

TRUCK DRIVER - BUILDING, HEAVY AND HIGHWAY CONSTRUCTION

Class 1. Drivers on 2 axle trucks hauling less than 9 ton. Air compressor and welding machines and brooms, including those pulled by separate units, truck driver helpers, warehouse employees, mechanic helpers, greasers and tiremen, pickup trucks when hauling materials, tools, or workers to and from and on-the-job site, and fork lifts up to 6,000 lb. capacity.

Class 2. Two or three axle trucks hauling more than 9 ton but hauling less than 16 ton. A-frame winch trucks, hydrolift trucks, vector trucks or similar equipment when used for transportation purposes. Fork lifts over 6,000 lb. capacity, winch trucks, four axle combination units, and ticket writers.

Class 3. Two, three or four axle trucks hauling 16 ton or more. Drivers on water pulls, articulated dump trucks, mechanics and working forepersons, and dispatchers. Five axle or more combination units.

Class 4. Low Boy and Oil Distributors.

Class 5. Drivers who require special protective clothing while employed on hazardous waste work.

OPERATING ENGINEERS - BUILDING, HEAVY AND HIGHWAY CONSTRUCTION

Class 1. Power Cranes, Draglines, Derricks, Shovels, Gradalls, Mechanics, Tractor Highlift, Tournadozer, Concrete Mixers with Skip, Tournamixer, Two Drum Machine, One Drum Hoist with Tower or Boom, Cableways, Tower Machines, Motor Patrol, Boom Tractor, Boom or Winch Truck, Winch or Hydraulic Boom Truck, Truck Crane, Tournapull,

Tractor Operating Scoops, Bulldozer, Push Tractor, Asphalt Planer, Finishing Machine on Asphalt, Large Rollers on Earth, Rollers on Asphalt Mix, Ross Carrier or similar Machine, Gravel Processing Machine, Asphalt Plant Engineer, Paver Operator, Dredging Equipment, or Dredge Engineer, or Dredge Operator, Central Mix Plant Engineer, CMI or similar type machine, Concrete Pump, Truck or Skid Mounted, Tower Crane, Engineer or Rock Crusher Plant, Concrete Plant Engineer, Ditching Machine with dual attachment, Tractor Mounted Loaders, Cherry Picker, Hydro Crane, Standard or Dinkey Locomotives, Scoopmobiles, Euclid Loader, Soil Cement Machine, Back Filler, Elevating Machine, Power Blade, Drilling Machine, including Well Testing, Caissons, Shaft or any similar type drilling machines, Motor Driven Paint Machine, Pipe Cleaning Machine, Pipe Wrapping Machine, Pipe Bending Machine, Apsco Paver, Boring Machine, (Head Equipment Greaser), Barber-Greene Loaders, Formless Paver, (Well Point System), Concrete Spreader, Hydra Ax, Span Saw, Marine Scoops, Brush Mulcher, Brush Burner, Mesh Placer, Tree Mover, Helicopter Crew (3), Piledriver-Skid or Crawler, Stump Remover, Root Rake, Tug Boat Operator, Refrigerating Machine, Freezing Operator, Chair Cart-Self-Propelled, Hydra Seeder, Straw Blower, Power Sub Grader, Bull Float, Finishing Machine, Self-Propelled Pavement Breaker, Lull (or similar type Machine), Two Air Compressors, Compressors hooked in Manifold, Overhead Crane, Chip Spreader, Mud Cat, Sull-Air, Fork Lifts (except when used for landscaping work), Soil Stabilizer (Seaman Tiller, Bo Mag, Rago Gator, and similar types of equipment), Tube Float, Spray Machine, Curing Machine, Concrete or Asphalt Milling Machine, Snooper Truck-Operator, Backhoe, Farm Tractors (with attachments), 4 Point Lift System (Power Lift or similar type), Skid-Steer (Bob Cat or similar type), Wrecking Shears, Water Blaster.

Class 2. Concrete Mixers without Skips, Rock Crusher, Ditching Machine under 6', Curbing Machine, One Drum Machines without Tower or Boom, Air Tugger, Self-Propelled Concrete Saw, Machine Mounted Post Hole Digger, two to four Generators, Water Pumps or Welding Machines, within 400 feet, Air Compressor 600 cu. ft. and under, Rollers on Aggregate and Seal Coat Surfaces, Fork Lift (when used for landscaping work), Concrete and Blacktop Curb Machine, One Water Pump, Oilers, Air Valves or Steam Valves, One Welding Machine, Truck Jack, Mud Jack, Gunnite Machine, House Elevators when used for hoisting material, Engine Tenders, Fireman, Wagon Drill, Flex Plane, Conveyor, Siphons and Pulsometer, Switchman, Fireman on Paint Pots, Fireman on Asphalt Plants, Distributor Operator on Trucks, Tampers, Self-Propelled Power Broom, Striping Machine (motor driven), Form Tamper, Bulk Cement Plant, Equipment Greaser, Deck Hands, Truck Crane Oiler-Driver, Cement Blimps, Form Grader, Temporary Heat, Throttle Valve, Super Sucker (and similar type of equipment).

Other Classifications of Work:

For definitions of classifications not otherwise set out, the Department generally has on file such definitions which are available. If a task to be performed is not subject to one of the classifications of pay set out, the Department will upon being contacted state which neighboring county has such a classification and provide such rate, such rate being deemed to exist by reference in this document. If no neighboring county rate applies to the task, the Department shall undertake a special determination, such special determination being then deemed to have existed under this determination. If a project requires these, or any classification not listed, please contact IDOL at 217-782-1710 for wage rates or clarifications.

LANDSCAPING

Landscaping work falls under the existing classifications for laborer,

operating engineer and truck driver. The work performed by landscape plantsman and landscape laborer is covered by the existing classification of laborer. The work performed by landscape operators (regardless of equipment used or its size) is covered by the classifications of operating engineer. The work performed by landscape truck drivers (regardless of size of truck driven) is covered by the classifications of truck driver.

Lee County Prevailing Wage for May 2013

(See explanation of column headings at bottom of wages)

Trade Name	RG	TYP	C	Base	FRMAN	M-F>8	OSA	OSH	H/W	Pensn	Vac	Trng
=====	==	===	=	=====	=====	=====	===	===	=====	=====	=====	=====
ASBESTOS ABT-GEN		BLD		29.550	30.550	1.5	1.5	2.0	8.240	12.42	0.000	0.800
ASBESTOS ABT-MEC		BLD		34.160	36.660	1.5	1.5	2.0	10.82	10.66	0.000	0.720
BOILERMAKER		BLD		35.010	38.010	2.0	2.0	2.0	7.070	13.83	0.000	0.300
BRICK MASON		BLD		35.880	38.630	1.5	1.5	2.0	7.950	11.73	0.000	0.600
CARPENTER		BLD		32.040	35.560	1.5	1.5	2.0	8.630	13.87	0.000	0.600
CARPENTER		HWY		33.790	35.540	1.5	1.5	2.0	9.750	12.99	0.000	0.490
CEMENT MASON		ALL		32.520	35.270	1.5	1.5	2.0	7.700	13.98	0.000	0.500
CERAMIC TILE FNSHER		BLD		32.410	0.000	1.5	1.5	2.0	7.700	4.840	0.000	0.530
COMMUNICATION TECH		BLD		36.000	39.600	1.5	1.5	2.0	10.14	11.20	0.000	0.720
ELECTRIC PWR EQMT OP		ALL		36.610	49.750	1.5	1.5	2.0	5.000	11.35	0.000	0.270
ELECTRIC PWR GRNDMAN		ALL		28.310	49.750	1.5	1.5	2.0	5.000	8.780	0.000	0.210
ELECTRIC PWR LINEMAN		ALL		43.830	49.750	1.5	1.5	2.0	5.000	13.58	0.000	0.330
ELECTRIC PWR TRK DRV		ALL		29.310	49.750	1.5	1.5	2.0	5.000	9.090	0.000	0.220
ELECTRICIAN		BLD		40.000	44.000	1.5	1.5	2.0	10.14	16.93	0.000	0.800
ELEVATOR CONSTRUCTOR		BLD		45.350	51.020	2.0	2.0	2.0	11.88	12.71	3.630	0.600
GLAZIER		BLD		30.770	32.770	1.5	1.5	2.0	9.700	7.700	0.000	1.250
HT/FROST INSULATOR		BLD		45.550	48.050	1.5	1.5	2.0	10.82	11.86	0.000	0.720
IRON WORKER	N	ALL		35.090	36.840	2.0	2.0	2.0	8.250	20.59	0.000	0.700
IRON WORKER	S	ALL		38.500	39.500	2.0	2.0	2.0	9.390	18.84	0.000	0.700
LABORER		BLD		29.550	30.550	1.5	1.5	2.0	8.240	12.42	0.000	0.800
LABORER		HWY		32.100	32.850	1.5	1.5	2.0	8.240	12.42	0.000	0.800
LABORER, SKILLED		HWY		34.400	35.150	1.5	1.5	2.0	8.240	12.42	0.000	0.800
LATHER		BLD		32.040	35.560	1.5	1.5	2.0	8.630	13.87	0.000	0.600
MACHINIST		BLD		43.550	46.050	1.5	1.5	2.0	6.130	8.950	1.850	0.000
MARBLE FINISHERS		BLD		32.410	0.000	1.5	1.5	2.0	7.700	4.840	0.000	0.530
MARBLE MASON		BLD		35.090	35.340	1.5	1.5	2.0	7.700	7.150	0.000	0.560
MATERIAL TESTER I		ALL		21.550	0.000	1.5	1.5	2.0	7.460	4.840	0.000	0.170
MATERIALS TESTER II		ALL		26.550	0.000	1.5	1.5	2.0	7.460	4.840	0.000	0.170
MILLWRIGHT		BLD		34.400	37.840	1.5	1.5	2.0	8.770	13.85	0.000	0.500
OPERATING ENGINEER		BLD	1	40.800	44.850	2.0	2.0	2.0	15.85	9.800	2.350	1.300
OPERATING ENGINEER		BLD	2	40.100	44.850	2.0	2.0	2.0	15.85	9.800	2.350	1.300
OPERATING ENGINEER		BLD	3	37.650	44.850	2.0	2.0	2.0	15.85	9.800	2.350	1.300
OPERATING ENGINEER		BLD	4	35.650	44.850	2.0	2.0	2.0	15.85	9.800	2.350	1.300
OPERATING ENGINEER		BLD	5	44.600	44.850	2.0	2.0	2.0	15.85	9.800	2.350	1.300
OPERATING ENGINEER		BLD	6	43.350	44.850	2.0	2.0	2.0	15.85	9.800	2.350	1.300
OPERATING ENGINEER		BLD	7	40.350	44.850	2.0	2.0	2.0	15.85	9.800	2.350	1.300
OPERATING ENGINEER		HWY	1	40.650	44.700	1.5	1.5	2.0	15.85	9.800	2.350	1.300
OPERATING ENGINEER		HWY	2	40.100	44.700	1.5	1.5	2.0	15.85	9.800	2.350	1.300
OPERATING ENGINEER		HWY	3	38.800	44.700	1.5	1.5	2.0	15.85	9.800	2.350	1.300
OPERATING ENGINEER		HWY	4	37.350	44.700	1.5	1.5	2.0	15.85	9.800	2.350	1.300
OPERATING ENGINEER		HWY	5	35.900	44.700	1.5	1.5	2.0	15.85	9.800	2.350	1.300
OPERATING ENGINEER		HWY	6	43.700	44.700	1.5	1.5	2.0	15.85	9.800	2.350	1.300
OPERATING ENGINEER		HWY	7	41.700	44.700	1.5	1.5	2.0	15.85	9.800	2.350	1.300
PAINTER		ALL		35.700	37.700	1.5	1.5	1.5	9.650	8.460	0.000	1.250
PILEDRIVER		BLD		33.040	36.670	1.5	1.5	2.0	8.630	13.87	0.000	0.600
PILEDRIVER		HWY		33.790	35.540	1.5	1.5	2.0	9.750	12.99	0.000	0.490
PIPEFITTER		ALL		36.550	40.210	1.5	1.5	2.0	5.650	12.15	0.000	1.000
PLASTERER		BLD		33.360	36.700	2.0	2.0	2.0	8.150	11.05	0.000	0.500
PLUMBER		ALL		36.550	40.210	1.5	1.5	2.0	5.650	12.15	0.000	1.000
ROOFER		BLD		38.350	41.350	1.5	1.5	2.0	8.280	8.770	0.000	0.430

SHEETMETAL WORKER	BLD		35.780	37.710	1.5	1.5	2.0	5.450	15.44	0.520	0.290	
SPRINKLER FITTER	BLD		36.390	39.140	1.5	1.5	2.0	8.420	8.500	0.000	0.450	
STONE MASON	BLD		35.880	38.630	1.5	1.5	2.0	7.950	11.73	0.000	0.600	
TERRAZZO FINISHER	BLD		32.410	0.000	1.5	1.5	2.0	7.700	4.840	0.000	0.530	
TERRAZZO MASON	BLD		35.090	35.340	1.5	1.5	2.0	7.700	7.150	0.000	0.560	
TILE LAYER	BLD		32.040	35.560	1.5	1.5	2.0	8.630	13.87	0.000	0.600	
TILE MASON	BLD		35.090	35.340	1.5	1.5	2.0	7.700	7.150	0.000	0.560	
TRUCK DRIVER	O&C	1	24.980	0.000	1.5	1.5	2.0	10.30	4.840	0.000	0.250	
TRUCK DRIVER	O&C	2	25.340	0.000	1.5	1.5	2.0	10.30	4.840	0.000	0.250	
TRUCK DRIVER	O&C	3	25.510	0.000	1.5	1.5	2.0	10.30	4.840	0.000	0.250	
TRUCK DRIVER	O&C	4	25.740	0.000	1.5	1.5	2.0	10.30	4.840	0.000	0.250	
TRUCK DRIVER	O&C	5	26.420	0.000	1.5	1.5	2.0	10.30	4.840	0.000	0.250	
TRUCK DRIVER	E	ALL	1	32.550	33.100	1.5	1.5	2.0	6.500	4.350	0.000	0.000
TRUCK DRIVER	E	ALL	2	32.700	33.100	1.5	1.5	2.0	6.500	4.350	0.000	0.000
TRUCK DRIVER	E	ALL	3	32.900	33.100	1.5	1.5	2.0	6.500	4.350	0.000	0.000
TRUCK DRIVER	E	ALL	4	33.100	33.100	1.5	1.5	2.0	6.500	4.350	0.000	0.000
TRUCK DRIVER	W	ALL	1	31.230	0.000	1.5	1.5	2.0	10.30	4.840	0.000	0.250
TRUCK DRIVER	W	ALL	2	31.680	0.000	1.5	1.5	2.0	10.30	4.840	0.000	0.250
TRUCK DRIVER	W	ALL	3	31.890	0.000	1.5	1.5	2.0	10.30	4.840	0.000	0.250
TRUCK DRIVER	W	ALL	4	32.180	0.000	1.5	1.5	2.0	10.30	4.840	0.000	0.250
TRUCK DRIVER	W	ALL	5	33.020	0.000	1.5	1.5	2.0	10.30	4.840	0.000	0.250
TUCKPOINTER	BLD		35.880	38.630	1.5	1.5	2.0	7.950	11.73	0.000	0.600	

Legend :

RG (Region)

TYP (Trade Type - All,Highway,Building,Floating,Oil & Chip,Rivers)

C (Class)

Base (Base Wage Rate)

FRMAN (Foreman Rate)

M-F>8 (OT required for any hour greater than 8 worked each day, Mon through Fri.)

OSA (Overtime (OT) is required for every hour worked on Saturday)

OSH (Overtime is required for every hour worked on Sunday and Holidays)

H/W (Health & Welfare Insurance)

Pensn (Pension)

Vac (Vacation)

Trng (Training)

Explanations

LEE COUNTY

IRONWORKERS (SOUTH) - That part of the county South of Route 30.

TRUCK DRIVERS (EAST) - That part of the county East of U.S. 251 and North of Route 30.

The following list is considered as those days for which holiday rates of wages for work performed apply: New Years Day, Memorial Day, Fourth of July, Labor Day, Thanksgiving Day, Christmas Day and

Veterans Day in some classifications/counties. Generally, any of these holidays which fall on a Sunday is celebrated on the following Monday. This then makes work performed on that Monday payable at the appropriate overtime rate for holiday pay. Common practice in a given local may alter certain days of celebration. If in doubt, please check with IDOL.

Oil and chip resealing (O&C) means the application of road oils and liquid asphalt to coat an existing road surface, followed by application of aggregate chips or gravel to coated surface, and subsequent rolling of material to seal the surface.

EXPLANATION OF CLASSES

ASBESTOS - GENERAL - removal of asbestos material/mold and hazardous materials from any place in a building, including mechanical systems where those mechanical systems are to be removed. This includes the removal of asbestos materials/mold and hazardous materials from ductwork or pipes in a building when the building is to be demolished at the time or at some close future date.

ASBESTOS - MECHANICAL - removal of asbestos material from mechanical systems, such as pipes, ducts, and boilers, where the mechanical systems are to remain.

CERAMIC TILE FINISHER, MARBLE FINISHER, TERRAZZO FINISHER

Assisting, helping or supporting the tile, marble and terrazzo mechanic by performing their historic and traditional work assignments required to complete the proper installation of the work covered by said crafts. The term "Ceramic" is used for naming the classification only and is in no way a limitation of the product handled. Ceramic takes into consideration most hard tiles.

COMMUNICATIONS TECHNICIAN

Installing, manufacturing, assembling and maintaining sound and intercom, protection alarm (security), fire alarm, master antenna television, closed circuit television, low voltage control for computers and/or door monitoring, school communications systems, telephones and servicing of nurse and emergency calls, and the installation and maintenance of transmit and receive antennas, transmitters, receivers, and associated apparatus which operates in conjunction with above systems. All work associated with these system installations will be included EXCEPT the installation of protective metallic conduit in new construction projects (excluding less than ten-foot runs strictly for protection of cable) and 120 volt AC (or higher) power wiring and associated hardware.

LABORER, SKILLED - HIGHWAY

Individuals engaged in the following types of work, irrespective of the site of the work: asbestos abatement worker, handling of any materials with any foreign matter harmful to skin or clothing, track laborer, cement handlers, chloride handlers, the unloading and loading with steel workers and re-bars, concrete workers wet, tunnel helpers in free air, batch dumpers, mason tenders, kettle and tar men, tank cleaners, plastic installers, scaffold workers, motorized buggies or motorized unit used for wet concrete or handling of building materials, laborers with de-watering systems, sewer workers plus depth, rod and chainmen with technical engineers, rod and chainmen with land surveyors, rod and chainmen with surveyors, vibrator operators, cement silica, clay, fly ash, lime and plasters, handlers (bulk or bag), cofferdam workers plus depth, on concrete paving, placing, cutting and tying of reinforcing, deck hand, dredge hand, and shore laborers, bankmen on floating plant, grade checker, power

tools, front end man on chip spreaders, cassion workers plus depth, gunnite nozzle men, lead man on sewer work, welders, cutters, burners and torchmen, chainsaw operators, jackhammer and drill operators, layout man and/or drainage tile layer, steel form setter - street and highway, air tamping hammermen, signal man on crane, concrete saw operator, screedman on asphalt pavers, laborers tending masons with hot material or where foreign materials are used, mortar mixer operators, multiple concrete duct - leadsman, lumen, asphalt raker, curb asphalt machine operator, ready mix scalemen (permanent, portable or temporary plant), laborers handling masterplate or similar materials, laser beam operator, concrete burning machine operator, coring machine operator, plaster tender, underpinning and shoring of buildings, pump men, manhole and catch basin, dirt and stone tamper, hose men on concrete pumps, hazardous waste worker, lead base paint abatement worker, lining of pipe, refusing machine, assisting on direct boring machine, the work of laying watermain, fire hydrants, all mechanical joints to watermain work, sewer worker, and tapping water service and forced lift station mechanical worker.

MATERIAL TESTER I: Hand coring and drilling for testing of materials; field inspection of uncured concrete and asphalt.

MATERIAL TESTER II: Field inspection of welds, structural steel, fireproofing, masonry, soil, facade, reinforcing steel, formwork, cured concrete, and concrete and asphalt batch plants; adjusting proportions of bituminous mixtures.

OPERATING ENGINEERS - BUILDING

Class 1. Asphalt Plant; Asphalt Spreader; Autograde; Backhoes with Caisson Attachment; Batch Plant; Benoto (requires Two Engineers); Boiler and Throttle Valve; Caisson Rigs; Central Redi-Mix Plant; Combination Back Hoe Front End-loader Machine; Compressor and Throttle Valve; Concrete Breaker (Truck Mounted); Concrete Conveyor; Concrete Paver (over 27E cu. ft.): Concrete Paver (27 cu. ft. and under); Concrete Placer; Concrete Pump (Truck Mounted); Concrete Conveyor (Truck Mounted); Concrete Tower; Cranes, All; GCI and similar types (required two operators only); Cranes, Hammerhead; Creter Crane; Crusher, Stone, etc.; Derricks, All; Derricks, Traveling; Formless Curb and Gutter Machine; Grader, Elevating; Grouting Machines; Highlift Shovels or Front Endloader 2-1/4 yd. and over; Hoists, Elevators, outside type rack and pinion and similar machines; Hoists, one, two and three Drum; Hoists, Two Tugger One Floor; Hydraulic Backhoes; Hydraulic Boom Trucks; Hydro Vac (and similar equipment - excluding hose work and any sewer work); Locomotives, All; Lubrication Technician; Manipulators; Motor Patrol; Pile Drivers and Skid Rig; Post Hole Digger; Pre-Stress Machine; Pump Cretes Dual Ram; Pump Cretes: Squeeze Cretes - Screw Type Pumps, Gypsum Bulker and Pump; Raised and Blind Hole Drill; Rock Drill (self-propelled); Rock Drill - Truck Mounted; Roto Mill Grinder; Scoops - Tractor Drawn; Slipform Paver; Scrapers Prime Movers; Straddle Buggies; Tie Back Machine; Tractor with Boom and Side Boom; Trenching Machines.

Class 2. Bobcat (over 3/4 cu. yd.); Boilers; Brick Forklift; Broom, All Power Propelled; Bulldozers; Concrete Mixer (Two Bag and Over); Conveyor, Portable; Forklift Trucks; Highlift Shovels or Front Endloaders under 2-1/4 yd.; Hoists, Automatic; Hoists, Sewer Dragging Machine; Hoists, Tugger Single Drum; Laser Screed; Rollers, All; Steam Generators; Tractors, All; Tractor Drawn Vibratory Roller; Winch Trucks with "A" Frame.

Class 3. Air Compressor; Asphalt Spreader; Combination - Small Equipment Operator; Generators; Heaters, Mechanical; Hoists, Inside Elevators - (Rheostat Manual Controlled); Hydraulic Power Units (Pile Driving, Extracting, or Drilling - with a seat); Lowboys; Pumps, Over

3" (1 to 3 not to exceed total of 300 ft.); Pumps, Well Points; Welding Machines (2 through 5); Winches, 4 Small Electric Drill Winches; Bobcat (up to and including 3/4 cu. yd.).

Class 4. Elevator push button with automatic doors; Hoists, Inside; Oilers; Brick Forklift.

Class 5. Assistant Craft Foreman

Class 6. Mechanics; Welders.

Class 7. Gradall

OPERATING ENGINEERS - HIGHWAY CONSTRUCTION

Class 1. Asphalt Plant; Asphalt Heater and Planer Combination; Asphalt Heater Scarfire; Asphalt Silo Tender; Asphalt Spreader; Autograder; ABG Paver; Backhoes with Caisson Attachment; Ballast Regulator; Belt Loader; Caisson Rigs; Car Dumper; Central Redi-Mix Plant; Backhoe w/shear attachments; Combination Backhoe Front Endloader Machine, (1 cu. yd. Backhoe Bucket or over or with attachments); Concrete Breaker (Truck Mounted); Concrete Conveyor; Concrete Paver over 27E cu. ft.; Concrete Placer; Concrete Tube Float; Cranes, all attachments; Cranes, Tower of all types; Creter Crane; Crusher, Stone, etc.; Derricks, All; Derrick Boats; Derricks, Traveling; Directional Boring Machine over 12"; Dredges; Formless Curb and Gutter Machine; Grader, Elevating; Grader, Motor Grader, Motor Patrol, Auto Patrol, Form Grader, Pull Grader, Subgrader; Guard Rail Post Driver Mounted; Hoists, One, Two and Three Drum; Hydraulic Backhoes; Hydro Vac, Self Propelled, Truck Mounted (excluding hose work and any sewer work); Lubrication Technician; Manipulators; Pile Drivers and Skid Rig; Pre-Stress Machine; Pump Cretes Dual Ram; Rock Drill - Crawler or Skid Rig; Rock Drill - Truck Mounted; Rock/Track Tamper; Roto Mill Grinder; Slip-Form Paver; Snow Melters; Soil Test Drill Rig (Truck Mounted); Straddle Buggies; GCI Crane; Hydraulic Telescoping Form (Tunnel); Tie Back Machine; Tractor Drawn Belt Loader; Tractor Drawn Belt Loader with attached pusher; Tractor with Boom; Tractaire with Attachments; Traffic Barrier Conveyor Machine; Raised or Blind Hole Drills; Trenching Machine (over 12"); Truck Mounted Concrete Pump with Boom; Truck Mounted Concrete Conveyor; Work Boat (no license required - 90 h.p. or above); Underground Boring and/or Mining Machines; Wheel Excavator; Widener (APSCO).

Class 2. Batch Plant; Bituminous Mixer; Boiler and Throttle Valve; Bulldozers; Car Loader Trailing Conveyors; Combination Backhoe Front Endloader Machine (less than 1 cu. yd. Backhoe Bucket or over or with attachments); Compressor and Throttle Valve; Compressor, Common Receiver (3); Concrete Breaker or Hydro Hammer; Concrete Grinding Machine; Concrete Mixer or Paver 7S Series to and including 27 cu. ft.; Concrete Spreader; Concrete Curing Machine, Burlap Machine, Belting Machine and Sealing Machine; Concrete Wheel Saw (large self-propelled - excluding walk-behinds and hand-held); Conveyor Muck Cars (Haglund or Similar Type); Drills, all; Finishing Machine - Concrete; Highlift Shovels or Front Endloader; Hoist - Sewer Dragging Machine; Hydraulic Boom Trucks (All Attachments); Hydro Blaster; All Locomotives, Dinky; Off-Road Hauling Units; Non-Self Loading Dump; Ejection Dump; Pump Cretes: Squeeze Cretes - Screw Type Pumps, Gypsum Bulker and Pump; Roller, Asphalt; Rotary Snow Plows; Rototiller, Seaman, etc., self-propelled; Scoops - Tractor Drawn; Self-Propelled Compactor; Spreader - Chip - Stone, etc.; Scraper; Scraper - Prime Mover in Tandem (Regardless of Size); Tank Car Heater; Tractors, Push, Pulling Sheeps Foot, Disc, Compactor, etc.; Tug Boats.

Class 3. Boilers; Brooms, All Power Propelled; Cement Supply Tender;

Compressor, Common Receiver (2); Concrete Mixer (Two Bag and Over); Conveyor, Portable; Farm-Type Tractors Used for Mowing, Seeding, etc.; Fireman on Boilers; Forklift Trucks; Grouting Machine; Hoists, Automatic; Hoists, All Elevators; Hoists, Tugger Single Drum; Jeep Diggers; Low Boys; Pipe Jacking Machines; Post-Hole Digger; Power Saw, Concrete Power Driven; Pug Mills; Rollers, other than asphalt; Seed and Straw Blower; Steam Generators; Stump Machine; Winch Trucks with "A" Frame; Work Boats; Tamper - Form - Motor Driven.

Class 4. Air Compressor - Small and Large; Asphalt Spreader, Backend Man; Bobcat (Skid Steer) all; Brick Forklift; Combination - Small Equipment Operator; Directional Boring Machine up to 12"; Generators; Heaters, Mechanical; Hydraulic Power Unit (Pile Driving, Extracting, or Drilling); Hydro-Blaster; Light Plants, All (1 through 5); Pumps, over 3" (1 to 3 not to exceed a total of 300 ft.); Pumps, Well Points; Tractaire; Trencher 12" and under; Welding Machines (2 through 5); Winches, 4 Small Electric Drill Winches.

Class 5. Oilers and Directional Boring Machine Locator.

Class 6. Field Mechanics and Field Welders

Class 7. Gradall and machines of like nature.

TRUCK DRIVER - BUILDING, HEAVY AND HIGHWAY CONSTRUCTION - WEST

Class 1. Drivers on 2 axle trucks hauling less than 9 ton. Air compressor and welding machines and brooms, including those pulled by separate units, truck driver helpers, warehouse employees, mechanic helpers, greasers and tiremen, pickup trucks when hauling materials, tools, or workers to and from and on-the-job site, and fork lifts up to 6,000 lb. capacity.

Class 2. Two or three axle trucks hauling more than 9 ton but hauling less than 16 ton. A-frame winch trucks, hydrolift trucks, vector trucks or similar equipment when used for transportation purposes. Fork lifts over 6,000 lb. capacity, winch trucks, four axle combination units, and ticket writers.

Class 3. Two, three or four axle trucks hauling 16 ton or more. Drivers on water pulls, articulated dump trucks, mechanics and working forepersons, and dispatchers. Five axle or more combination units.

Class 4. Low Boy and Oil Distributors.

Class 5. Drivers who require special protective clothing while employed on hazardous waste work.

TRUCK DRIVER - BUILDING, HEAVY AND HIGHWAY CONSTRUCTION - EAST

Class 1. Two or three Axle Trucks. A-frame Truck when used for transportation purposes; Air Compressors and Welding Machines, including those pulled by cars, pick-up trucks and tractors; Ambulances; Batch Gate Lockers; Batch Hopperman; Car and Truck Washers; Carry-alls; Fork Lifts and Hoisters; Helpers; Mechanics Helpers and Greasers; Oil Distributors 2-man operation; Pavement Breakers; Pole Trailer, up to 40 feet; Power Mower Tractors; Self-propelled Chip Spreader; Skipman; Slurry Trucks, 2-man operation; Slurry Truck Conveyor Operation, 2 or 3 man; Teamsters; Unskilled dumpman; and Truck Drivers hauling warning lights, barricades, and portable toilets on the job site.

Class 2. Four axle trucks; Dump Crets and Adgetors under 7 yards; Dumpsters, Track Trucks, Euclids, Hug Bottom Dump Turnapulls or

Turntrailers when pulling other than self-loading equipment or similar equipment under 16 cubic yards; Mixer Trucks under 7 yards; Ready-mix Plant Hopper Operator, and Winch Trucks, 2 Axles.

Class 3. Five axle trucks; Dump Crets and Adgetors 7 yards and over; Dumpsters, Track Trucks, Euclids, Hug Bottom Dump Turntrailers or turnpulls when pulling other than self-loading equipment or similar equipment over 16 cubic yards; Explosives and/or Fission Material Trucks; Mixer Trucks 7 yards or over; Mobile Cranes while in transit; Oil Distributors, 1-man operation; Pole Trailer, over 40 feet; Pole and Expandable Trailers hauling material over 50 feet long; Slurry trucks, 1-man operation; Winch trucks, 3 axles or more; Mechanic--Truck Welder and Truck Painter.

Class 4. Six axle trucks; Dual-purpose vehicles, such as mounted crane trucks with hoist and accessories; Foreman; Master Mechanic; Self-loading equipment like P.B. and trucks with scoops on the front.

TRUCK DRIVER - OIL AND CHIP RESEALING ONLY.

This shall encompass laborers, workers and mechanics who drive contractor or subcontractor owned, leased, or hired pickup, dump, service, or oil distributor trucks. The work includes transporting materials and equipment (including but not limited to, oils, aggregate supplies, parts, machinery and tools) to or from the job site; distributing oil or liquid asphalt and aggregate; stock piling material when in connection with the actual oil and chip contract. The Truck Driver (Oil & Chip Resealing) wage classification does not include supplier delivered materials.

Other Classifications of Work:

For definitions of classifications not otherwise set out, the Department generally has on file such definitions which are available. If a task to be performed is not subject to one of the classifications of pay set out, the Department will upon being contacted state which neighboring county has such a classification and provide such rate, such rate being deemed to exist by reference in this document. If no neighboring county rate applies to the task, the Department shall undertake a special determination, such special determination being then deemed to have existed under this determination. If a project requires these, or any classification not listed, please contact IDOL at 217-782-1710 for wage rates or clarifications.

LANDSCAPING

Landscaping work falls under the existing classifications for laborer, operating engineer and truck driver. The work performed by landscape plantsman and landscape laborer is covered by the existing classification of laborer. The work performed by landscape operators (regardless of equipment used or its size) is covered by the classifications of operating engineer. The work performed by landscape truck drivers (regardless of size of truck driven) is covered by the classifications of truck driver.

Livingston County Prevailing Wage for May 2013

(See explanation of column headings at bottom of wages)

Trade Name	RG	TYP	C	Base	FRMAN	M-F>8	OSA	OSH	H/W	Pensn	Vac	Trng
------------	----	-----	---	------	-------	-------	-----	-----	-----	-------	-----	------

ASBESTOS ABT-GEN		BLD	30.030	31.030	1.5	1.5	2.0	7.700	8.230	0.000	0.800
ASBESTOS ABT-GEN		HWY	31.590	32.140	1.5	1.5	2.0	7.700	8.230	0.000	0.800
ASBESTOS ABT-MEC		BLD	34.160	36.660	1.5	1.5	2.0	10.82	10.66	0.000	0.720
BOILERMAKER		BLD	35.010	38.010	2.0	2.0	2.0	7.070	13.83	0.000	0.300
BRICK MASON		BLD	36.720	37.720	1.5	1.5	2.0	8.720	7.950	0.000	0.580
CARPENTER		BLD	30.050	32.300	1.5	1.5	2.0	7.450	12.91	0.000	0.520
CARPENTER		HWY	31.000	33.250	1.5	1.5	2.0	7.450	13.76	0.000	0.520
CEMENT MASON	N	ALL	35.000	36.000	1.5	1.5	2.0	7.700	11.67	0.000	0.500
CEMENT MASON	S	ALL	30.590	31.590	1.5	1.5	2.0	5.750	11.23	0.000	0.500
CERAMIC TILE FNSHER		BLD	32.410	0.000	1.5	1.5	2.0	7.700	4.840	0.000	0.530
ELECTRIC PWR EQMT OP		ALL	35.440	0.000	1.5	1.5	2.0	5.000	10.98	0.000	0.270
ELECTRIC PWR GRNDMAN		ALL	24.320	0.000	1.5	1.5	2.0	5.000	7.540	0.000	0.180
ELECTRIC PWR LINEMAN		ALL	39.370	41.910	1.5	1.5	2.0	5.000	12.20	0.000	0.300
ELECTRIC PWR TRK DRV		ALL	25.510	0.000	1.5	1.5	2.0	5.000	7.920	0.000	0.190
ELECTRICIAN		BLD	37.090	39.090	1.5	1.5	2.0	5.350	7.760	0.000	0.560
ELECTRONIC SYS TECH		BLD	30.830	32.580	1.5	1.5	2.0	5.350	6.720	0.000	0.400
ELEVATOR CONSTRUCTOR		BLD	40.520	45.585	2.0	2.0	2.0	11.88	12.71	3.240	0.600
GLAZIER		BLD	30.770	32.770	1.5	1.5	2.0	9.700	7.700	0.000	1.250
HT/FROST INSULATOR		BLD	45.550	48.050	1.5	1.5	2.0	10.82	11.86	0.000	0.720
IRON WORKER	E	ALL	39.500	43.450	2.0	2.0	2.0	9.390	18.98	0.000	0.700
IRON WORKER	W	ALL	38.500	39.500	2.0	2.0	2.0	9.390	18.84	0.000	0.700
LABORER		BLD	29.030	30.030	1.5	1.5	2.0	7.700	8.230	0.000	0.800
LABORER		HWY	30.590	31.140	1.5	1.5	2.0	7.700	8.230	0.000	0.800
LABORER, SKILLED		BLD	29.030	30.030	1.5	1.5	2.0	7.700	8.230	0.000	0.800
LABORER, SKILLED		HWY	30.590	31.140	1.5	1.5	2.0	7.700	8.230	0.000	0.800
LATHER		BLD	30.050	32.300	1.5	1.5	2.0	7.450	12.91	0.000	0.520
MACHINIST		BLD	43.550	46.050	1.5	1.5	2.0	6.130	8.950	1.850	0.000
MARBLE FINISHERS		BLD	32.410	0.000	1.5	1.5	2.0	7.700	4.840	0.000	0.530
MARBLE MASON		BLD	35.090	35.340	1.5	1.5	2.0	7.700	7.150	0.000	0.560
MILLWRIGHT		BLD	30.300	32.550	1.5	1.5	2.0	7.450	13.09	0.000	0.520
MILLWRIGHT		HWY	31.820	34.070	1.5	1.5	2.0	7.450	13.44	0.000	0.520
OPERATING ENGINEER		BLD 1	43.300	47.300	2.0	2.0	2.0	15.70	10.55	1.900	1.250
OPERATING ENGINEER		BLD 2	42.000	47.300	2.0	2.0	2.0	15.70	10.55	1.900	1.250
OPERATING ENGINEER		BLD 3	39.450	47.300	2.0	2.0	2.0	15.70	10.55	1.900	1.250
OPERATING ENGINEER		BLD 4	37.700	47.300	2.0	2.0	2.0	15.70	10.55	1.900	1.250
OPERATING ENGINEER		BLD 5	46.300	47.300	2.0	2.0	2.0	15.70	10.55	1.900	1.250
OPERATING ENGINEER		BLD 6	46.300	47.300	2.0	2.0	2.0	15.70	10.55	1.900	1.250
OPERATING ENGINEER		BLD 7	44.300	47.300	2.0	2.0	2.0	15.70	10.55	1.900	1.250
OPERATING ENGINEER		HWY 1	43.300	47.300	1.5	1.5	2.0	15.70	10.55	1.900	1.250
OPERATING ENGINEER		HWY 2	42.750	47.300	1.5	1.5	2.0	15.70	10.55	1.900	1.250
OPERATING ENGINEER		HWY 3	40.700	47.300	1.5	1.5	2.0	15.70	10.55	1.900	1.250
OPERATING ENGINEER		HWY 4	39.300	47.300	1.5	1.5	2.0	15.70	10.55	1.900	1.250
OPERATING ENGINEER		HWY 5	38.100	47.300	1.5	1.5	2.0	15.70	10.55	1.900	1.250
OPERATING ENGINEER		HWY 6	46.300	47.300	1.5	1.5	2.0	15.70	10.55	1.900	1.250
OPERATING ENGINEER		HWY 7	44.300	47.300	1.5	1.5	2.0	15.70	10.55	1.900	1.250
PAINTER		ALL	32.900	34.900	1.5	1.5	1.5	9.650	8.200	0.000	1.250
PAINTER SIGNS		BLD	33.920	38.090	1.5	1.5	1.5	2.600	2.710	0.000	0.000
PILEDRIVER		BLD	30.550	32.800	1.5	1.5	2.0	7.450	12.91	0.000	0.520
PILEDRIVER		HWY	32.000	34.250	1.5	1.5	2.0	7.450	13.76	0.000	0.520
PIPEFITTER	N	BLD	45.050	48.050	1.5	1.5	2.0	8.460	14.85	0.000	1.780
PIPEFITTER	S	BLD	39.000	42.120	1.5	1.5	2.0	7.000	9.500	0.000	1.850
PLASTERER	N	BLD	40.250	42.670	1.5	1.5	2.0	10.85	10.94	0.000	0.550
PLASTERER	S	BLD	29.500	31.500	1.5	1.5	2.0	6.300	13.83	0.000	0.500
PLUMBER	N	BLD	45.000	47.000	1.5	1.5	2.0	12.53	10.06	0.000	0.880
PLUMBER	S	BLD	39.000	42.120	1.5	1.5	2.0	7.000	9.500	0.000	1.850
ROOFER		BLD	38.350	41.350	1.5	1.5	2.0	8.280	8.770	0.000	0.430
SHEETMETAL WORKER		BLD	42.510	44.510	1.5	1.5	2.0	10.04	12.01	0.000	0.780
SPRINKLER FITTER		BLD	36.390	39.140	1.5	1.5	2.0	8.420	8.500	0.000	0.450
STONE MASON		BLD	36.720	37.720	1.5	1.5	2.0	8.720	7.950	0.000	0.580
TERRAZZO FINISHER		BLD	32.410	0.000	1.5	1.5	2.0	7.700	4.840	0.000	0.530
TILE MASON		BLD	35.090	35.340	1.5	1.5	2.0	7.700	7.150	0.000	0.560
TRUCK DRIVER	NW	ALL 1	31.230	0.000	1.5	1.5	2.0	10.30	4.840	0.000	0.250
TRUCK DRIVER	NW	ALL 2	31.680	0.000	1.5	1.5	2.0	10.30	4.840	0.000	0.250
TRUCK DRIVER	NW	ALL 3	31.890	0.000	1.5	1.5	2.0	10.30	4.840	0.000	0.250
TRUCK DRIVER	NW	ALL 4	32.180	0.000	1.5	1.5	2.0	10.30	4.840	0.000	0.250

TRUCK DRIVER	NW ALL	5	33.020	0.000	1.5	1.5	2.0	10.30	4.840	0.000	0.250
TRUCK DRIVER	SE ALL	1	35.650	36.200	1.5	1.5	2.0	7.250	6.319	0.000	0.250
TRUCK DRIVER	SE ALL	2	35.800	36.200	1.5	1.5	2.0	7.250	6.319	0.000	0.250
TRUCK DRIVER	SE ALL	3	36.000	36.200	1.5	1.5	2.0	7.250	6.319	0.000	0.250
TRUCK DRIVER	SE ALL	4	36.200	36.200	1.5	1.5	2.0	7.250	6.319	0.000	0.250
TUCKPOINTER	BLD		36.720	37.720	1.5	1.5	2.0	8.720	7.950	0.000	0.580

Legend:

RG (Region)

TYP (Trade Type - All,Highway,Building,Floating,Oil & Chip,Rivers)

C (Class)

Base (Base Wage Rate)

FRMAN (Foreman Rate)

M-F>8 (OT required for any hour greater than 8 worked each day, Mon through Fri.

OSA (Overtime (OT) is required for every hour worked on Saturday)

OSH (Overtime is required for every hour worked on Sunday and Holidays)

H/W (Health & Welfare Insurance)

Pensn (Pension)

Vac (Vacation)

Trng (Training)

Explanations

LIVINGSTON COUNTY

CEMENT MASONS & PLASTERER - N That part of the county north of Illinois Route 116 and including all of the City of Pontiac.

IRONWORKERS - E East of I-55 from the northern boundary through Cayuga then East of a North-South line to a point East of Weston.

PLUMBERS & PIPEFITTERS - S That part of the county South of Rt. 116 including the City of Pontiac.

TRUCK DRIVERS - NW Townships of Reading, New Town, Sunbury, Nevada, Long Point and Amity.

The following list is considered as those days for which holiday rates of wages for work performed apply: New Years Day, Memorial Day, Fourth of July, Labor Day, Thanksgiving Day, Christmas Day and Veterans Day in some classifications/counties. Generally, any of these holidays which fall on a Sunday is celebrated on the following Monday. This then makes work performed on that Monday payable at the appropriate overtime rate for holiday pay. Common practice in a given local may alter certain days of celebration. If in doubt, please check with IDOL.

EXPLANATION OF CLASSES

ASBESTOS - GENERAL - removal of asbestos material/mold and hazardous materials from any place in a building, including mechanical systems where those mechanical systems are to be removed. This includes the removal of asbestos materials/mold and hazardous materials from ductwork or pipes in a building when the building is to be demolished at the time or at some close future date.

ASBESTOS - MECHANICAL - removal of asbestos material from mechanical systems, such as pipes, ducts, and boilers, where the mechanical systems are to remain.

CERAMIC TILE FINISHER, MARBLE FINISHER, TERRAZO FINISHER

Assisting, helping or supporting the tile, marble and terrazzo mechanic by performing their historic and traditional work assignments required to complete the proper installation of the work covered by said crafts. The term "Ceramic" is used for naming the classification only and is in no way a limitation of the product handled. Ceramic takes into consideration most hard tiles.

ELECTRONIC SYSTEMS TECHNICIAN

Installation, service and maintenance of low-voltage systems which utilizes the transmission and/or transference of voice, sound, vision, or digital for commercial, education, security and entertainment purposes for the following: TV monitoring and surveillance, background/foreground music, intercom and telephone interconnect, field programming, inventory control systems, microwave transmission, multi-media, multiplex, radio page, school, intercom and sound burglar alarms and low voltage master clock systems.

Excluded from this classification are energy management systems, life safety systems, supervisory controls and data acquisition systems not intrinsic with the above listed systems, fire alarm systems, nurse call systems and raceways exceeding fifteen feet in length.

LABORER, SKILLED - BUILDING

The skilled laborer building (BLD) classification shall encompass the following types of work, irrespective of the site of the work: tending of carpenters in unloading, handling, stockpiling and distribution operations, also other building crafts, mixing, handling, and conveying of all materials used by masons, plasterers and other building construction crafts, whether done by hand or by any process. The drying of plastering when done by salamander heat, and the cleaning and clearing of all debris. All work pertaining to and in preparation of asbestos abatement and removal. The building of scaffolding and staging for masons and plasterers. The excavations for buildings and all other construction, digging, of trenches, piers, foundations and holes, digging, lagging, sheeting, cribbing, bracing and propping of foundations, holes, caissons, cofferdams, and dikes, the setting of all guidelines for machine or hand excavation and subgrading. The mixing, handling, conveying, pouring, vibrating, gunniting and otherwise applying of concrete, whether by hand or other method of concrete for any walls, foundations, floors, or for other construction concrete sealant men. The wrecking, stripping, dismantling, and handling of concrete forms and false work, and the building of centers for fireproofing purposes. Boring machine, gas, electric or air in preparation for shoving pipe, telephone cable, and so forth, under highways, roads, streets and alleys. All hand and power operating cross cut saws when used for clearing. All work in compressed air construction. All work on acetylene burners in salvaging. The blocking and tamping of concrete. The laying of sewer tile and conduit, and pre-cast materials. The assembling and dismantling of all jacks and sectional scaffolding, including elevator

construction and running of slip form jacks. The work of drill running and blasting, including wagon drills. The wrecking, stripping, dismantling, cleaning, moving and oiling of forms. The cutting off of concrete piles. The loading, unloading, handling and carrying to place of installation of all rods, (and materials for use in reinforcing) concrete and the hoisting of same and all signaling where hoist is used in this type of construction coming under the jurisdiction of the Laborers' Union. And, all other labor work not awarded to any other craft. Mortar mixers, kettlemen and carrier of hot stuff, tool crib men, watchmen (Laborer), firemen or salamander tenders, flagmen, deck hands, installation and maintenance of temporary gas-fired heating units, gravel box men, dumpmen and spotters, fencing Laborers, cleaning lumber, pit men, material checkers, dispatchers, unloading explosives, asphalt plant laborers, writer of scale tickets, fireproofing laborers, janitors, asbestos abatement and removal laborers, handling of materials treated with oil, creosote, chloride, asphalt, and/or foreign material harmful to skin or clothing, Laborers with de-watering systems, gunnite nozzle men, laborers tending masons with hot material or where foreign materials are used, Laborers handling masterplate or similar materials, laser beam operator, concrete burning machine operator, material selector men working with firebrick or combustible material, dynamite men, track laborers, cement handlers, chloride handlers, the unloading and laborers with steel workers and re-bars, concrete workers (wet), luteman, asphalt raker, curb asphalt machine operator, ready mix scalemen, permanent, portable or temporary plant drilling machine operator, plaster tenders, underpinning and shoring of buildings, fire watch, signaling of all power equipment, to include trucks excavating equipment, etc., tree topper or trimmer when in connection to construction, tunnel helpers in free air, batch dumpers, kettle and tar men, tank cleaners, plastic installers, scaffold workers, motorized buggies or motorized unit used for wet concrete or handling of building materials, sewer workers, rod and chain men, vibrator operators, mortar mixer operator, cement silica, clay, fly ash, lime and plasters, handlers (bulk or bag), cofferdam workers, on concrete paving, placing, cutting and tying of reinforcing, deck hand, dredge hand and shore laborers, bankmen on floating plant, asphalt workers with machine & layers, grade checker, power tools, caisson workers, lead man on sewer work, welders, cutters, burners and torch men, chain saw operators, paving breaker, jackhammer and drill operator, layout man and/or drainage tile layer, steel form setters -- street and highway, air tamping hammerman, signal man on crane, concrete saw operator, screen man on asphalt pavers, front end man on chip spreader, multiple concrete duct -- lead man.

LABORER, SKILLED - HIGHWAY

The skilled laborer heavy and highway (HWY) classification shall encompass the following types of work, irrespective of the site of the work: handling of materials treated with oil, creosote, asphalt and/or any foreign materials harmful to skin or clothing, track laborers, chloride handlers, the unloading and loading with steel workers and re-bars, concrete workers (wet), tunnel helpers in free air, batch dumpers, mason tenders, kettle and tar men, plastic installers, scaffold workers, motorized buggies or motorized unit used for wet concrete or handling of building materials, laborers with de-watering systems, sewer workers plus depth, rod and chainmen, vibrator operators, mortar mixer operators, cement silica, clay, fly ash, lime and plasters, handlers (bulk or bag), cofferdam workers plus depth, on concrete paving, placing, cutting and tying or reinforcing, deck hand, dredge hand shore laborers, bankmen on floating plant, asphalt workers with machine, and layers, grade checker, power tools, stripping of all concrete forms excluding paving forms, dumpmen and spotters, when necessary, caisson workers plus depth, gunnite nozzle men, welders, cutters, burners and torchmen, chain saw operators,

paving breaker, jackhammer and drill operators, layout man and/or drainage tile layer, steel form setters - street and highway, air tamping hammerman, signal man on crane, concrete saw operator, screedman on asphalt pavers, front end man on chip spreader, multiple concrete duct, luteman, asphalt raker, curb asphalt machine operator, ready mix scalemen (portable or temporary plant), laser beam operator, concrete burning machine operator, and coring machine operator.

OPERATING ENGINEERS - BUILDING

Class 1. Mechanic; Asphalt Plant; Asphalt Spreader; Autograde; Backhoes w/Caisson attachment; Batch Plant; Benoto (require 2 engineers); Boiler and Throttle Valve; Caisson Rigs; Central Redi-Mix Plant; Combination Back Hoe Front End-Loader Machine; Compressor and Throttle Valve; Concrete Breaker (Truck Mounted); Concrete Conveyor; Concrete Paver over 27E cu. ft.; Concrete Paver 27E cu.ft. and under; Concrete Placer; Concrete Pump (Truck Mounted); Concrete Tower; Cranes, All; Cranes Hammerhead; Creter Crane; Spider Crane; Crusher, Stone, etc.; Derricks, All; Derricks, Traveling; Formless Curb and Gutter Machine; Grader, Elevating; Grouting Machines; Heavy Duty Self-Propelled Transporter or Prime Mover; Highlift Shovels or Front Endloader 2-1/4 yd. and over; Hoists, Elevators, outside type rack and pinion and similar machines; Hoists, One, Two and Three Drum; Hoists, Two Tugger One Floor; Hydraulic Backhoes; Hydraulic Boom Trucks; Hydro Vac (and similar equipment); Locomotives, All; Lubrication Technician; Manipulators; Motor Patrol; Pile Drivers and Skid Rig; Post Hole Digger; Pre-Stress Machine; Pump Cretes Dual Ram; Squeeze Cretes - Screw Type Pumps; Gypsum Bulker and Pump; Roto Mill Grinder; Scoops - Tractor Drawn; Slip-Form Paver; Straddle Buggies; Operation or Tieback Machine; Tournapull; Tractor with Boom and Side Boom; Trenching Machines.

Class 2. Boilers; Brick Forklift servicing seven (7) or more Brick Masons; Broom, All Power Propelled; Bulldozers; Concrete Mixer (Two Bag and Over); Conveyor, Portable; Forklift Trucks; Highlift Shovels or Front Endloaders under 2-1/4 yd; Hoists, Automatic; Hoists, inside Freight Elevators; Hoists, Sewer Dragging Machine; Hoists, Tugger Single Drum; Hydro Excavating (excluding hose work); Laser Screed; Rock Drill (self-propelled); Non Self-Loading Ejection Dump; Rock Drill (Truck Mounted); Rollers, All; Steam Generators; Tractors, All; Tractor Drawn Vibratory Roller; Winch Trucks with "A" Frame.

Class 3. Air Compressors; Combination - Small Equipment Operator; Generators; Heaters, Mechanical; Hoists, Inside Elevators - (Rheostat Manual Controlled); Hoists, Inside Elevators; Hydraulic Power Units (Pile Driving and Extracting); Lowboys; Pumps, over 3" (1 to 3 not to exceed a total of 300 ft.); Pumps, Well Points; Welding Machines (2 through 5); Winches, 4 Small Electric Drill Winches.

Class 4. Brick Forklift; Boom Trucks (Residential); Hoists, Inside Elevators push button with automatic doors; Oilers; Skidsteer Loaders; Vacuum Trucks (excluding hose work).

Class 5. Assistant Craft Foreman

Class 6. Mechanics and Welders

Class 7. Gradall

OPERATING ENGINEERS - HIGHWAY CONSTRUCTION

Class 1. Asphalt Plant; Asphalt Heater and Planer Combination; Asphalt Heater Scarfire; Asphalt Spreader; Autograder/Gomaco or other similar

type machines: ABG Paver; Backhoes with Caisson Attachment; Belt Loader; Caisson Rigs; Car Dumper; Central Redi-Mix Plant; Combination Backhoe Front Endloader Machine; Concrete Breaker (Truck Mounted); Concrete Conveyor; Concrete Paver over 27E cu. ft.; Concrete Placer; Concrete Tube Float; Cranes, all attachments; Cranes, Tower of all types; Creter Crane; Spider Crane; Crusher, Stone, etc.; Derricks, All; Derrick Boats; Derricks, Traveling; Dredges; Elevators, Outside Type Rack & Pinion and Similar Machines; Formless Curb and Gutter Machine; Grader, Elevating; Grader, Motor Grader, Motor Patrol, Auto Patrol, Form Grader, Pull Grader, Subgrader; Guard Rail Post Driver Truck Mounted; Heavy Duty Self-Propelled Transporter or Prime Mover; Hoists, One, Two and Three Drum; Hydraulic Backhoes; Locomotives, All; Backhoes with Shear Attachments; Lubrication Technician; Manipulators; Mucking Machine; Pile Drivers and Skid Rig; Pre-Stress Machine; Pump Cretes Dual Ram; Rock Drill-Crawler or Skid Rig; Rock Drill - Truck Mounted; Roto Mill Grinder; Slip-Form Paver; Snow Melters; Soil Test Drill Rig (Truck Mounted); Straddle Buggies; Hydraulic Telescoping Form (Tunnel); Operation of Tieback Machine; Tractor Drawn Belt Loader; Tractor Drawn Belt Loader with attached pusher; Tractor with Boom; Tractaire with Attachments; Transfer Barrier Transfer Machine; Trenching Machine; Truck Mounted Concrete Pump with Boom; Raised or Blind Hole Drills (Tunnel Shaft); Underground Boring and/or Mining Machine; Wheel Excavator; Widener (APSCO).

Class 2. Batch Plant; Bituminous Mixer; Boiler and Throttle Valve; Bulldozers; Car Loader Trailing Conveyors; Combination Backhoe Front Endloader Machine (less than 1 cu. yd. Backhoe Bucket or over or with attachments); Compressor and Throttle Valve; Compressor, Common Receiver (3); Concrete Breaker or Hydro Hammer; Concrete Grinding Machine; Concrete Mixer or Paver 7S Series to and including 27 cu. ft.; Concrete Spreader; Concrete Curing Machine, Burlap Machine, Belting Machine and Sealing Machine; Concrete Wheel Saw; Conveyor Muck Cars (Haglund or Similar Type); Drills, All; Finishing Machine - Concrete; Forklifts; Highlift Shovels or Front Endloader; Hoist - Sewer Dragging Machine; Hydraulic Boom Trucks (All Attachments); Hydro-Blaster (requires 2 operators; one being Class 4); Hydro Excavating (excluding hose work); Laser Screed; Locomotives, Dinky; Oil Distributor; Off-Road Hauling Units (Including Articulating); Non Self-Loading Ejection Dump; Pump Cretes; Squeeze Cretes - Screw Type Pumps, Gypsum Bulker and Pump; Roller, Asphalt; Rotary Snow Plows; Rototiller, Seaman, etc., Self-Propelled; Self-Propelled Compactor; Spreader - Chip - Stone, etc.; Scraper; Scraper - Prime Mover in Tandem; Tractors, Push, Pulling Sheeps Foot, Disc, Compactor, etc.; Tug Boats; Mechanic Welders working in permanent shop.

Class 3. Boilers; Brooms, All Power Propelled; Cement Supply Tender; Compressor, Common Receiver (2); Concrete Mixer (Two Bag and Over); Conveyor, Portable; Farm-Type Tractors Used for Mowing, Seeding, etc.; Grouting Machine; Hoists, Automatic; Hoists, All Elevators; Hoists, Tugger Single Drum; Jeep Diggers; Low Boys; Pipe Jacking Machine; Post-Hole Digger; Power Saw, Concrete Power Driven; Pug Mills; Rollers, other than asphalt; Seed and Straw Blower; Steam Generators; Stump Machine Heaters, Mechanical; Winch Trucks with "A" Frame; Work Boats; Tamper - Form - Motor Driven.

Class 4. Air Compressor; Brick Forklifts (Servicing Seven (7) or more Brick Masons); Combination - Small Equipment Operator; Directional Boring Machine; Generators; Heaters, Mechanical; Hydraulic Power Unit (Pile Driving, Extracting, or Drilling); Hydro-Blaster (requires 2 operators - one being class 2); Light Plants, All (1 through 5); Pumps, over 3" (1 to 3 not to exceed a total of 300 ft.); Pumps, Well Points; Tractaire; Vacuum Trucks (excluding hose work); Welding Machines (2 through 5); Winches, 4 Small Electric Drill Winches.

Class 5. Brick Forklifts; Oilers; Skidsteer Loaders (All).

Class 6. Field Mechanics and Field Welders.

Class 7. Dowell Machine with Air Compressor; Gradall and machines of like nature.

TRUCK DRIVER - BUILDING, HEAVY AND HIGHWAY CONSTRUCTION - NORTHWEST

Class 1. Drivers on 2 axle trucks hauling less than 9 ton. Air compressor and welding machines and brooms, including those pulled by separate units, truck driver helpers, warehouse employees, mechanic helpers, greasers and tiremen, pickup trucks when hauling materials, tools, or workers to and from and on-the-job site, and fork lifts up to 6,000 lb. capacity.

Class 2. Two or three axle trucks hauling more than 9 ton but hauling less than 16 ton. A-frame winch trucks, hydrolift trucks, vactor trucks or similar equipment when used for transportation purposes. Fork lifts over 6,000 lb. capacity, winch trucks, four axle combination units, and ticket writers.

Class 3. Two, three or four axle trucks hauling 16 ton or more. Drivers on water pulls, articulated dump trucks, mechanics and working forepersons, and dispatchers. Five axle or more combination units.

Class 4. Low Boy and Oil Distributors.

Class 5. Drivers who require special protective clothing while employed on hazardous waste work.

TRUCK DRIVER - BUILDING, HEAVY AND HIGHWAY CONSTRUCTION - SOUTHEAST

Class 1. Two or three Axle Trucks. A-frame Truck when used for transportation purposes; Air Compressors and Welding Machines, including those pulled by cars, pick-up trucks and tractors; Ambulances; Batch Gate Lockers; Batch Hopperman; Car and Truck Washers; Carry-alls; Fork Lifts and Hoisters; Helpers; Mechanics Helpers and Greasers; Oil Distributors 2-man operation; Pavement Breakers; Pole Trailer, up to 40 feet; Power Mower Tractors; Self-propelled Chip Spreader; Skipman; Slurry Trucks, 2-man operation; Slurry Truck Conveyor Operation, 2 or 3 man; Teamsters; Unskilled dumpman; and Truck Drivers hauling warning lights, barricades, and portable toilets on the job site.

Class 2. Four axle trucks; Dump Crets and Adgetors under 7 yards; Dumpsters, Track Trucks, Euclids, Hug Bottom Dump Turnapulls or Turnatrailers when pulling other than self-loading equipment or similar equipment under 16 cubic yards; Mixer Trucks under 7 yards; Ready-mix Plant Hopper Operator, and Winch Trucks, 2 Axles.

Class 3. Five axle trucks; Dump Crets and Adgetors 7 yards and over; Dumpsters, Track Trucks, Euclids, Hug Bottom Dump Turnatrailers or turnapulls when pulling other than self-loading equipment or similar equipment over 16 cubic yards; Explosives and/or Fission Material Trucks; Mixer Trucks 7 yards or over; Mobile Cranes while in transit; Oil Distributors, 1-man operation; Pole Trailer, over 40 feet; Pole and Expandable Trailers hauling material over 50 feet long; Slurry trucks, 1-man operation; Winch trucks, 3 axles or more; Mechanic--Truck Welder and Truck Painter.

Class 4. Six axle trucks; Dual-purpose vehicles, such as mounted crane trucks with hoist and accessories; Foreman; Master Mechanic;

Self-loading equipment like P.B. and trucks with scoops on the front.

Other Classifications of Work:

For definitions of classifications not otherwise set out, the Department generally has on file such definitions which are available. If a task to be performed is not subject to one of the classifications of pay set out, the Department will upon being contacted state which neighboring county has such a classification and provide such rate, such rate being deemed to exist by reference in this document. If no neighboring county rate applies to the task, the Department shall undertake a special determination, such special determination being then deemed to have existed under this determination. If a project requires these, or any classification not listed, please contact IDOL at 217-782-1710 for wage rates or clarifications.

LANDSCAPING

Landscaping work falls under the existing classifications for laborer, operating engineer and truck driver. The work performed by landscape plantsman and landscape laborer is covered by the existing classification of laborer. The work performed by landscape operators (regardless of equipment used or its size) is covered by the classifications of operating engineer. The work performed by landscape truck drivers (regardless of size of truck driven) is covered by the classifications of truck driver.

Logan County Prevailing Wage for May 2013

(See explanation of column headings at bottom of wages)

Trade Name	RG	TYP	C	Base	FRMAN	M-F>8	OSA	OSH	H/W	Pensn	Vac	Trng
=====	==	===	=	=====	=====	=====	===	===	=====	=====	=====	=====
ASBESTOS ABT-GEN		BLD		30.380	31.630	1.5	1.5	2.0	5.750	10.22	0.000	0.900
ASBESTOS ABT-MEC		BLD		29.860	30.860	1.5	1.5	2.0	6.950	3.000	0.000	0.000
BOILERMAKER		BLD		35.010	38.010	2.0	2.0	2.0	7.070	13.83	0.000	0.300
BRICK MASON		BLD		29.130	29.880	2.0	2.0	2.0	8.200	10.03	0.000	0.580
CARPENTER		BLD		29.680	31.930	1.5	1.5	2.0	7.450	13.31	0.000	0.520
CARPENTER		HWY		29.510	31.260	1.5	1.5	2.0	7.450	13.31	0.000	0.520
CEMENT MASON		BLD		29.250	30.250	2.0	2.0	2.0	8.200	8.330	0.000	0.580
CEMENT MASON		HWY		26.870	27.870	1.5	1.5	2.0	8.200	7.530	0.000	0.000
CERAMIC TILE FNSHER		BLD		25.480	0.000	1.5	1.5	2.0	8.200	8.930	0.000	0.000
ELECTRIC PWR EQMT OP		ALL		35.440	0.000	1.5	1.5	2.0	5.000	10.98	0.000	0.270
ELECTRIC PWR GRNDMAN		ALL		24.320	0.000	1.5	1.5	2.0	5.000	7.540	0.000	0.180
ELECTRIC PWR LINEMAN		ALL		39.370	41.910	1.5	1.5	2.0	5.000	12.20	0.000	0.300
ELECTRIC PWR TRK DRV		ALL		25.510	0.000	1.5	1.5	2.0	5.000	7.920	0.000	0.190
ELECTRICIAN		BLD		34.220	36.220	1.5	1.5	2.0	5.860	8.120	0.000	0.400
ELECTRONIC SYS TECH		BLD		30.390	32.140	1.5	1.5	2.0	5.350	7.160	0.000	0.400
ELEVATOR CONSTRUCTOR		BLD		40.520	45.585	2.0	2.0	2.0	11.88	12.71	3.240	0.600
GLAZIER		BLD		30.780	32.780	1.5	2.0	2.0	6.630	8.150	0.000	0.380
HT/FROST INSULATOR		BLD		37.260	38.260	1.5	1.5	2.0	7.850	11.16	0.000	0.500
IRON WORKER		BLD		29.460	31.460	1.5	1.5	2.0	7.740	11.38	0.000	0.660
IRON WORKER		HWY		30.600	32.100	1.5	1.5	2.0	7.740	11.69	0.000	0.660
LABORER		BLD		28.380	29.630	1.5	1.5	2.0	5.750	10.22	0.000	0.800
LABORER		HWY		28.210	28.960	1.5	1.5	2.0	5.750	10.32	0.000	0.800
LATHER		BLD		29.680	31.930	1.5	1.5	2.0	7.450	13.31	0.000	0.520
MACHINIST		BLD		43.550	46.050	1.5	1.5	2.0	6.130	8.950	1.850	0.000
MARBLE FINISHERS		BLD		25.480	0.000	1.5	1.5	2.0	8.200	8.930	0.000	0.000
MARBLE MASON		BLD		26.980	27.730	1.5	1.5	2.0	8.200	8.930	0.000	0.000
MILLWRIGHT		BLD		30.240	32.490	1.5	1.5	2.0	7.450	13.09	0.000	0.520
MILLWRIGHT		HWY		31.690	33.440	1.5	1.5	2.0	7.450	13.54	0.000	0.520

OPERATING ENGINEER	BLD	1	33.900	35.400	1.5	1.5	2.0	10.05	7.600	0.000	1.300
OPERATING ENGINEER	BLD	2	31.550	35.400	1.5	1.5	2.0	10.05	7.600	0.000	1.300
OPERATING ENGINEER	BLD	3	27.950	35.400	1.5	1.5	2.0	10.05	7.600	0.000	1.300
OPERATING ENGINEER	BLD	4	35.400	35.400	1.5	1.5	2.0	10.05	7.600	0.000	1.300
OPERATING ENGINEER	HWY	1	37.600	39.100	1.5	1.5	2.0	10.05	8.100	0.000	1.300
OPERATING ENGINEER	HWY	2	33.660	39.100	1.5	1.5	2.0	10.05	8.100	0.000	1.300
OPERATING ENGINEER	HWY	3	27.630	39.100	1.5	1.5	2.0	10.05	8.100	0.000	1.300
OPERATING ENGINEER	HWY	4	39.100	39.100	1.5	1.5	2.0	10.05	8.100	0.000	1.300
PAINTER	ALL		28.580	30.080	1.5	1.5	2.0	5.000	8.580	0.000	0.550
PAINTER OVER 30FT	ALL		29.580	31.080	1.5	1.5	2.0	5.000	8.580	0.000	0.550
PAINTER PWR EQMT	ALL		29.580	31.080	1.5	1.5	2.0	5.000	8.580	0.000	0.550
PILEDRIVER	BLD		30.180	32.430	1.5	1.5	2.0	7.450	13.31	0.000	0.520
PILEDRIVER	HWY		30.510	32.260	1.5	1.5	2.0	7.450	13.31	0.000	0.520
PIPEFITTER	BLD		40.020	44.020	1.5	1.5	2.0	7.000	7.750	0.000	0.900
PLASTERER	BLD		29.250	30.250	2.0	2.0	2.0	8.200	8.330	0.000	0.580
PLUMBER	BLD		40.020	44.020	1.5	1.5	2.0	7.000	7.750	0.000	0.900
ROOFER	BLD		27.900	30.400	1.5	1.5	2.0	8.600	6.750	0.000	0.500
SHEETMETAL WORKER	BLD		31.680	33.930	1.5	1.5	2.0	8.300	12.35	0.000	0.500
SPRINKLER FITTER	BLD		36.390	39.140	1.5	1.5	2.0	8.420	8.500	0.000	0.450
STONE MASON	BLD		29.130	29.880	2.0	2.0	2.0	8.200	10.03	0.000	0.580
TERRAZZO FINISHER	BLD		25.480	0.000	1.5	1.5	2.0	8.200	8.930	0.000	0.000
TERRAZZO MASON	BLD		26.980	27.730	1.5	1.5	2.0	8.200	8.930	0.000	0.000
TILE MASON	BLD		26.980	27.730	1.5	1.5	2.0	8.200	8.930	0.000	0.000
TRUCK DRIVER	ALL	1	31.340	0.000	1.5	1.5	2.0	10.30	5.010	0.000	0.250
TRUCK DRIVER	ALL	2	31.780	0.000	1.5	1.5	2.0	10.30	5.010	0.000	0.250
TRUCK DRIVER	ALL	3	32.020	0.000	1.5	1.5	2.0	10.30	5.010	0.000	0.250
TRUCK DRIVER	ALL	4	32.280	0.000	1.5	1.5	2.0	10.30	5.010	0.000	0.250
TRUCK DRIVER	ALL	5	33.130	0.000	1.5	1.5	2.0	10.30	5.010	0.000	0.250
TRUCK DRIVER	O&C	1	25.070	0.000	1.5	1.5	2.0	10.30	5.010	0.000	0.250
TRUCK DRIVER	O&C	2	25.420	0.000	1.5	1.5	2.0	10.30	5.010	0.000	0.250
TRUCK DRIVER	O&C	3	25.620	0.000	1.5	1.5	2.0	10.30	5.010	0.000	0.250
TRUCK DRIVER	O&C	4	25.820	0.000	1.5	1.5	2.0	10.30	5.010	0.000	0.250
TRUCK DRIVER	O&C	5	26.500	0.000	1.5	1.5	2.0	10.30	5.010	0.000	0.250
TUCKPOINTER	BLD		29.130	29.880	2.0	2.0	2.0	8.200	10.03	0.000	0.580

Legend :

RG (Region)

TYP (Trade Type - All,Highway,Building,Floating,Oil & Chip,Rivers)

C (Class)

Base (Base Wage Rate)

FRMAN (Foreman Rate)

M-F>8 (OT required for any hour greater than 8 worked each day, Mon through Fri.)

OSA (Overtime (OT) is required for every hour worked on Saturday)

OSH (Overtime is required for every hour worked on Sunday and Holidays)

H/W (Health & Welfare Insurance)

Pensn (Pension)

Vac (Vacation)

Trng (Training)

Explanations

LOGAN COUNTY

The following list is considered as those days for which holiday rates of wages for work performed apply: New Years Day, Memorial Day, Fourth of July, Labor Day, Thanksgiving Day, Christmas Day and Veterans Day in some classifications/counties. Generally, any of these holidays which fall on a Sunday is celebrated on the following Monday. This then makes work performed on that Monday payable at the appropriate overtime rate for holiday pay. Common practice in a given local may alter certain days of celebration. If in doubt, please check with IDOL.

Oil and chip resealing (O&C) means the application of road oils and liquid asphalt to coat an existing road surface, followed by application of aggregate chips or gravel to coated surface, and subsequent rolling of material to seal the surface.

EXPLANATION OF CLASSES

ASBESTOS - GENERAL - removal of asbestos material/mold and hazardous materials from any place in a building, including mechanical systems where those mechanical systems are to be removed. This includes the removal of asbestos materials/mold and hazardous materials from ductwork or pipes in a building when the building is to be demolished at the time or at some close future date.

ASBESTOS - MECHANICAL - removal of asbestos material from mechanical systems, such as pipes, ducts, and boilers, where the mechanical systems are to remain.

CERAMIC TILE FINISHER, MARBLE FINISHER, TERRAZZO FINISHER

Assisting, helping or supporting the tile, marble and terrazzo mechanic by performing their historic and traditional work assignments required to complete the proper installation of the work covered by said crafts. The term "Ceramic" is used for naming the classification only and is in no way a limitation of the product handled. Ceramic takes into consideration most hard tiles.

ELECTRONIC SYSTEMS TECHNICIAN

Installation, service and maintenance of low-voltage systems which utilizes the transmission and/or transference of voice, sound, vision, or digital for commercial, education, security and entertainment purposes for the following: TV monitoring and surveillance, background/foreground music, intercom and telephone interconnect, field programming, inventory control systems, microwave transmission, multi-media, multiplex, radio page, school, intercom and sound burglar alarms and low voltage master clock systems.

Excluded from this classification are energy management systems, life safety systems, supervisory controls and data acquisition systems not intrinsic with the above listed systems, fire alarm systems, nurse call systems and raceways exceeding fifteen feet in length.

TRUCK DRIVER - BUILDING, HEAVY AND HIGHWAY CONSTRUCTION

Class 1. Drivers on 2 axle trucks hauling less than 9 ton. Air compressor and welding machines and brooms, including those pulled by separate units, truck driver helpers, warehouse employees, mechanic helpers, greasers and tiremen, pickup trucks when hauling materials, tools, or workers to and from and on-the-job site, and fork lifts up

to 6,000 lb. capacity.

Class 2. Two or three axle trucks hauling more than 9 ton but hauling less than 16 ton. A-frame winch trucks, hydrolift trucks, vactor trucks or similar equipment when used for transportation purposes. Fork lifts over 6,000 lb. capacity, winch trucks, four axle combination units, and ticket writers.

Class 3. Two, three or four axle trucks hauling 16 ton or more. Drivers on water pulls, articulated dump trucks, mechanics and working forepersons, and dispatchers. Five axle or more combination units.

Class 4. Low Boy and Oil Distributors.

Class 5. Drivers who require special protective clothing while employed on hazardous waste work.

TRUCK DRIVER - OIL AND CHIP RESEALING ONLY.

This shall encompass laborers, workers and mechanics who drive contractor or subcontractor owned, leased, or hired pickup, dump, service, or oil distributor trucks. The work includes transporting materials and equipment (including but not limited to, oils, aggregate supplies, parts, machinery and tools) to or from the job site; distributing oil or liquid asphalt and aggregate; stock piling material when in connection with the actual oil and chip contract. The Truck Driver (Oil & Chip Resealing) wage classification does not include supplier delivered materials.

OPERATING ENGINEERS - BUILDING

CLASS 1. Asphalt Screed Man; Aspco Concrete Spreaders; Asphalt Pavers; Asphalt Plant Engineer; Asphalt Rollers on Bituminous Concrete; Athey Loaders; Backfillers, Crane Type; Backhoes; Barber Green Loaders; Bulldozers; Cableways; Cherry Pickers; Clam Shells; C.M.I. & similar type autograde formless paver, autograde placer & finisher; Concrete Breakers; Concrete Pumps; Derricks; Derrick Boats; Draglines; Earth Auger or Boring Machines; Elevating Graders; Engineers on Dredges; Gravel Processing Machines; Head Equipment Greaser; High Lifts or Fork Lifts; Hoists with two or more drums or two or more load lines; Locomotives, All; Mechanics; Motor Graders or Auto Patrols; Operators or Leverman on Dredges; Operators, Power Boat; Operators, Pug Mill (Asphalt Plants); Orange Peels; Overhead Cranes; Paving Mixers; Piledrivers; Pipe Wrapping and Painting Machines; Pushdozers, or Push Cats; Robotic Controlled Equipment in this Classification; Rock Crushers; Ross Carrier or Similar Machines; Rotomill; Scoops, Skimmer, two cu. yd. capacity and under; Scoops, All or Tournapull; Sheep-Foot Roller (Self Propelled); Shovels; Skid Steer; Skimmer Scoops; Temporary Concrete Plant Operators; Test Hole Drilling Machines; Tower Machines; Tower Mixers; Track Type End Loaders; Track Type Fork Lifts or High Lifts; Track Jacks and Tampers; Tractors, Sideboom; Trenching or Ditching Machine; Tunnelluggers; Vermeer Type Saws; Water Blaster Cutting Head; Wheel Type End Loaders; Winch Cat.

CLASS 2. Air Compressors (six to eight)*; Asphalt Boosters and Heaters; Asphalt Distributors; Asphalt Plant Fireman; Oiler on Two Paving Mixers When Used in Tandem; Boom or Winch Trucks; Bull Floats or Flexplanes; Concrete Finishing Machine; Concrete Saws, Self-Propelled; Concrete Spreading Machines; Conveyors (six to eight)*; Generators (six to eight)*; Gravel or Stone Spreader, Power Operated; Hoist (with One Drum and One Load Line); Light Plants (six to eight)*; Mechanical Heaters (six to eight)*; Mud Jacks; Post Hole Digger, Mechanical; Pug Mills when used for other than Asphalt operation; Robotic Controlled Equipment in this Classification; Road

or Street Sweeper, Self Propelled; Rollers (except bituminous concrete); Seaman Tiller; Straw Machine; Vibratory Compactor; Water Blaster, Power Unit; Welding Machines (six to eight)*; Well Drill Machines.

CLASS 3. Air Compressors(one to five)*; Air Compressors, Track or Self-Propelled; Automatic Hoist; Building Elevators; Bulk Cement Batching Plants; Conveyors (one to five)*; Concrete Mixers (Except Plant, Paver, or Tower); Firemen; Generators (one to five)*; Greasers; Helper on Single Paving Mixer; Hoist, Automatic; Light Plants (one to five)*; Mechanic Helpers; Mechanical Heaters (one to five)*; Oilers; Power Form Graders; Power Sub-Graders; Robotic Controlled Equipment in this Classification; Scissors Hoist; Tractors without power attachments regardless of size or type; Truck Crane Oiler and Driver (1 man); Vibratory Hammer (power source); Water Pumps (one to five)*; Welding Machines (1/300 Amp. or over)*; Welding machines (one to five)*

CLASS 4. Lattice Boom Crawler Cranes; Lattice Boom Truck Cranes; Telescopic Truck-Mounted Cranes; Tower Cranes.

* Combinations of one to eight of any Air Compressors, Conveyors, Welding Machines, Water Pumps, Light Plants, or Generators shall be in batteries or within 400 feet and shall be paid as per the Classification Schedule contained in this Article.

OPERATING ENGINEERS - HIGHWAY

CLASS 1. Asphalt Screed Man; Asphco Concrete Spreaders; Asphalt Pavers; Asphalt Plant Engineer; Asphalt Rollers on Bituminous Concrete; Athey Loaders; Backhoes; Barber Green Loaders; Bulldozers; Cableways; Carry Deck Pickers; Cherry Pickers (Rough Terrain); C.M.I. & similar type-autograde formless paver, autograde placer & finisher; Concrete Breakers; Concrete Plant Operators; Concrete Pumps; Derricks; Derrick Boats; Dewatering Systems; Earth Auger or Boring Machines; Elevating Graders; Engineers on Dredges; Gravel Processing Machines; Grout Pump; Head Equipment Greaser; High Lifts or Fork Lifts; Hoists with two or more drums or two or more load lines; Hydro Jet or Hydro Laser; Locomotives, All; Mechanics; Motor Graders or Auto Patrols; Multi-Point Power Lifting Equipment; Operators or Leverman on Dredges; Operators, Power Boat; Operators, Pug Mill (Asphalt Plants); Overhead Cranes; Paving Mixers; Piledrivers; Pipe Wrapping and Painting Machines; Push-dozers, or Push Cats; Robotic Controlled Equipment in this Classification; Rock Crushers; Ross Carrier or Similar Machines; Roto-Mill; Scoops, Skimmer, two cu. yd. capacity and under; Sheep-Foot Roller (Self Pro-pelled); Shovels; Skid Steer; Skimmer Scoops; Test Hole Drilling Machines; Tower Machines; Tower Mixers; Track Type End Loaders; Track Type Fork Lifts or High Lifts; Track Jacks and Tampers; Tractors, Side-boom; Trenching or Ditching Machine; Tunnelluggers; Vermeer-Type Saws; Wheel Type End Loaders; Winch Cat; Scoops, All or Tournapull.

CLASS 2. Air Compressors (six to eight)*; Articulated Dumps; Asphalt Boosters and Heaters; Asphalt Distributors; Asphalt Plant Fireman; Boom or Winch Trucks; Building Elevators; Bull Floats or Flexplanes; Concrete Finishing Machine; Concrete Saws, Self-Propelled; Concrete Spreading Machines; Conveyors (six to eight)*; Generators (six to eight)*; Gravel or Stone Spreader, Power Operated; Hoist, Automatic; Hoist with One Drum and One Load Line; Light Plants (six to eight)*; Mechanical Heaters (six to eight)*; Mud Jacks; Off Road Water Wagons; Oiler on Two Paving Mixers When Used in Tandem; Post Hole Digger, Mechanical; Robotic Controlled Equipment in This Classification; Road or Street Sweeper, Self-Propelled; Rollers (except bituminous concrete); Scissor Hoist; Sea-man Tiller; Straw Machine; Vibratory

Compactor; Water Pumps (six to eight)*; Well Drill Machines.

CLASS 3. Air Compressors (one to five)*; Air Compressors, Track or Self-Propelled; Bulk Cement Batching Plants; Conveyors (one to five)*; Concrete Mixers (Except Plant, Paver, or Tower); Firemen; Generators (one to five)*; Greasers; Helper on Single Paving Mixer; Light Plants (one to five)*; Mechanic Helpers; Mechanical Heaters (one to five)*; Oilers; Power Form Graders; Power Sub-Graders; Pug Mills when used for other than Asphalt operation; Robotic Controlled Equipment in This Classification; Tractors without power attachments, regardless of size or type; Truck Crane Oiler and Driver (1 man); Vibratory Hammer (power source); Water Pumps (one to five)*; Welding Machines (one 300 Amp. or over)*; Welding Machines (one to five)*.

CLASS 4. Lattice Boom Crawler Crane; Lattice Boom Truck Crane; Telescopic Truck-Mounted Crane; Tower Crane.

*Combinations of one to eight of any Air Compressors, Conveyors, Welding Machines, Water Pumps, Light Plants or Generators shall be in batteries or within 400 feet and shall be paid as per the Classification Schedule contained in this Article.

Other Classifications of Work:

For definitions of classifications not otherwise set out, the Department generally has on file such definitions which are available. If a task to be performed is not subject to one of the classifications of pay set out, the Department will upon being contacted state which neighboring county has such a classification and provide such rate, such rate being deemed to exist by reference in this document. If no neighboring county rate applies to the task, the Department shall undertake a special determination, such special determination being then deemed to have existed under this determination. If a project requires these, or any classification not listed, please contact IDOL at 217-782-1710 for wage rates or clarifications.

LANDSCAPING

Landscaping work falls under the existing classifications for laborer, operating engineer and truck driver. The work performed by landscape plantsman and landscape laborer is covered by the existing classification of laborer. The work performed by landscape operators (regardless of equipment used or its size) is covered by the classifications of operating engineer. The work performed by landscape truck drivers (regardless of size of truck driven) is covered by the classifications of truck driver.

Macon County Prevailing Wage for May 2013

(See explanation of column headings at bottom of wages)

Trade Name	RG	TYP	C	Base	FRMAN	M-F>8	OSA	OSH	H/W	Pensn	Vac	Trng
=====	==	===	=	=====	=====	=====	===	===	=====	=====	=====	=====
ASBESTOS ABT-GEN		BLD		30.010	31.260	1.5	1.5	2.0	5.750	9.920	0.000	0.900
ASBESTOS ABT-MEC		BLD		29.860	30.860	1.5	1.5	2.0	6.950	3.000	0.000	0.000
BOILERMAKER		BLD		31.500	34.000	1.5	1.5	2.0	7.070	18.73	1.000	0.350
BRICK MASON		BLD		29.130	30.630	1.5	1.5	2.0	8.200	10.03	0.000	0.580
CARPENTER		BLD		28.940	31.190	1.5	1.5	2.0	7.450	13.31	0.000	0.520
CARPENTER		HWY		29.290	31.040	1.5	1.5	2.0	7.450	13.31	0.000	0.520
CEMENT MASON		BLD		28.960	29.960	1.5	1.5	2.0	7.450	10.73	0.000	0.500
CEMENT MASON		HWY		27.370	28.870	1.5	1.5	2.0	7.450	10.73	0.000	0.500
CERAMIC TILE FNSHER		BLD		25.480	0.000	1.5	1.5	2.0	8.200	8.930	0.000	0.000

ELECTRIC PWR EQMT OP	ALL	35.440	0.000	1.5	1.5	2.0	5.000	10.98	0.000	0.270
ELECTRIC PWR GRNDMAN	ALL	24.320	0.000	1.5	1.5	2.0	5.000	7.540	0.000	0.180
ELECTRIC PWR LINEMAN	ALL	39.370	41.910	1.5	1.5	2.0	5.000	12.20	0.000	0.300
ELECTRIC PWR TRK DRV	ALL	25.510	0.000	1.5	1.5	2.0	5.000	7.920	0.000	0.190
ELECTRICIAN	BLD	34.200	37.620	1.5	1.5	2.0	5.350	7.610	0.000	0.510
ELECTRONIC SYS TECH	BLD	31.130	32.880	1.5	1.5	2.0	5.350	6.110	0.000	0.400
ELEVATOR CONSTRUCTOR	BLD	40.520	45.585	2.0	2.0	2.0	11.88	12.71	3.240	0.600
GLAZIER	BLD	30.780	32.780	1.5	2.0	2.0	6.630	8.150	0.000	0.380
HT/FROST INSULATOR	BLD	37.260	38.260	1.5	1.5	2.0	7.850	11.16	0.000	0.500
IRON WORKER	E ALL	30.610	32.510	1.5	1.5	2.0	8.840	8.420	0.000	0.900
IRON WORKER	W BLD	29.460	31.460	1.5	1.5	2.0	7.740	11.38	0.000	0.660
IRON WORKER	W HWY	30.600	32.100	1.5	1.5	2.0	7.740	11.69	0.000	0.660
LABORER	BLD	28.010	29.260	1.5	1.5	2.0	5.750	9.920	0.000	0.800
LABORER	HWY	29.120	30.120	1.5	1.5	2.0	5.750	9.920	0.000	0.800
LATHER	BLD	28.940	31.190	1.5	1.5	2.0	7.450	13.31	0.000	0.520
MACHINIST	BLD	43.550	46.050	1.5	1.5	2.0	6.130	8.950	1.850	0.000
MARBLE FINISHERS	BLD	25.480	0.000	1.5	1.5	2.0	8.200	8.930	0.000	0.000
MARBLE MASON	BLD	26.980	28.230	1.5	1.5	2.0	8.200	8.930	0.000	0.000
MILLWRIGHT	BLD	29.620	31.870	1.5	1.5	2.0	7.450	13.09	0.000	0.520
MILLWRIGHT	HWY	31.400	33.150	1.5	1.5	2.0	7.450	13.54	0.000	0.520
OPERATING ENGINEER	BLD 1	33.900	35.400	1.5	1.5	2.0	10.05	7.600	0.000	1.300
OPERATING ENGINEER	BLD 2	31.550	35.400	1.5	1.5	2.0	10.05	7.600	0.000	1.300
OPERATING ENGINEER	BLD 3	27.950	35.400	1.5	1.5	2.0	10.05	7.600	0.000	1.300
OPERATING ENGINEER	BLD 4	35.400	35.400	1.5	1.5	2.0	10.05	7.600	0.000	1.300
OPERATING ENGINEER	HWY 1	37.600	39.100	1.5	1.5	2.0	10.05	8.100	0.000	1.300
OPERATING ENGINEER	HWY 2	33.660	39.100	1.5	1.5	2.0	10.05	8.100	0.000	1.300
OPERATING ENGINEER	HWY 3	27.630	39.100	1.5	1.5	2.0	10.05	8.100	0.000	1.300
OPERATING ENGINEER	HWY 4	39.100	39.100	1.5	1.5	2.0	10.05	8.100	0.000	1.300
OPERATING ENGINEER	O&C	30.080	0.000	1.5	1.5	2.0	10.05	7.600	0.000	1.300
PAINTER	ALL	28.250	29.750	1.5	1.5	2.0	5.750	9.420	0.000	0.650
PAINTER OVER 30FT	ALL	28.500	30.000	1.5	1.5	2.0	5.750	9.420	0.000	0.650
PAINTER PWR EQMT	ALL	29.250	30.750	1.5	1.5	2.0	5.750	9.420	0.000	0.650
PILEDRIVER	BLD	29.440	31.690	1.5	1.5	2.0	7.450	13.31	0.000	0.520
PILEDRIVER	HWY	30.290	32.040	1.5	1.5	2.0	7.450	13.31	0.000	0.520
PIPEFITTER	BLD	36.050	39.050	1.5	1.5	2.0	7.000	7.650	0.000	1.220
PLASTERER	BLD	29.500	31.500	1.5	1.5	2.0	6.300	13.83	0.000	0.500
PLUMBER	BLD	36.050	39.050	1.5	1.5	2.0	7.000	7.650	0.000	1.220
ROOFER	BLD	26.100	28.600	1.5	1.5	2.0	9.600	6.280	0.000	0.550
SHEETMETAL WORKER	BLD	30.160	32.160	1.5	1.5	2.0	8.300	11.14	0.000	0.550
SPRINKLER FITTER	BLD	36.390	39.140	1.5	1.5	2.0	8.420	8.500	0.000	0.450
STONE MASON	BLD	29.130	30.630	1.5	1.5	2.0	8.200	10.03	0.000	0.580
TERRAZZO FINISHER	BLD	25.480	0.000	1.5	1.5	2.0	8.200	8.930	0.000	0.000
TERRAZZO MASON	BLD	26.980	28.230	1.5	1.5	2.0	8.200	8.930	0.000	0.000
TILE MASON	BLD	26.980	28.230	1.5	1.5	2.0	8.200	8.930	0.000	0.000
TRUCK DRIVER	ALL 1	31.340	0.000	1.5	1.5	2.0	10.30	5.010	0.000	0.250
TRUCK DRIVER	ALL 2	31.780	0.000	1.5	1.5	2.0	10.30	5.010	0.000	0.250
TRUCK DRIVER	ALL 3	32.020	0.000	1.5	1.5	2.0	10.30	5.010	0.000	0.250
TRUCK DRIVER	ALL 4	32.280	0.000	1.5	1.5	2.0	10.30	5.010	0.000	0.250
TRUCK DRIVER	ALL 5	33.130	0.000	1.5	1.5	2.0	10.30	5.010	0.000	0.250
TRUCK DRIVER	O&C 1	25.070	0.000	1.5	1.5	2.0	10.30	5.010	0.000	0.250
TRUCK DRIVER	O&C 2	25.420	0.000	1.5	1.5	2.0	10.30	5.010	0.000	0.250
TRUCK DRIVER	O&C 3	25.620	0.000	1.5	1.5	2.0	10.30	5.010	0.000	0.250
TRUCK DRIVER	O&C 4	25.820	0.000	1.5	1.5	2.0	10.30	5.010	0.000	0.250
TRUCK DRIVER	O&C 5	26.500	0.000	1.5	1.5	2.0	10.30	5.010	0.000	0.250
TUCKPOINTER	BLD	29.130	30.630	1.5	1.5	2.0	8.200	10.03	0.000	0.580

Legend :

RG (Region)

TYP (Trade Type - All,Highway,Building,Floating,Oil & Chip,Rivers)

C (Class)

Base (Base Wage Rate)

FRMAN (Foreman Rate)

M-F>8 (OT required for any hour greater than 8 worked each day, Mon through Fri.)

OSA (Overtime (OT) is required for every hour worked on Saturday)

OSH (Overtime is required for every hour worked on Sunday and Holidays)

H/W (Health & Welfare Insurance)

Pensn (Pension)

Vac (Vacation)

Trng (Training)

Explanations

MACON COUNTY

IRON WORKERS (WEST) - West of a straight line just east of Route 51 to the southeast corner where Shelby, Macon and Moultrie counties meet.

The following list is considered as those days for which holiday rates of wages for work performed apply: New Years Day, Memorial Day, Fourth of July, Labor Day, Thanksgiving Day, Christmas Day and Veterans Day in some classifications/counties. Generally, any of these holidays which fall on a Sunday is celebrated on the following Monday. This then makes work performed on that Monday payable at the appropriate overtime rate for holiday pay. Common practice in a given local may alter certain days of celebration. If in doubt, please check with IDOL.

Oil and chip resealing (O&C) means the application of road oils and liquid asphalt to coat an existing road surface, followed by application of aggregate chips or gravel to coated surface, and subsequent rolling of material to seal the surface.

EXPLANATION OF CLASSES

ASBESTOS - GENERAL - removal of asbestos material/mold and hazardous materials from any place in a building, including mechanical systems where those mechanical systems are to be removed. This includes the removal of asbestos materials/mold and hazardous materials from ductwork or pipes in a building when the building is to be demolished at the time or at some close future date.

ASBESTOS - MECHANICAL - removal of asbestos material from mechanical systems, such as pipes, ducts, and boilers, where the mechanical systems are to remain.

CERAMIC TILE FINISHER, MARBLE FINISHER, TERRAZZO FINISHER

Assisting, helping or supporting the tile, marble and terrazzo mechanic by performing their historic and traditional work assignments required to complete the proper installation of the work covered by said crafts. The term "Ceramic" is used for naming the classification only and is in no way a limitation of the product handled. Ceramic takes into consideration most hard tiles.

ELECTRONIC SYSTEMS TECHNICIAN

Installation, service and maintenance of low-voltage systems which utilizes the transmission and/or transference of voice, sound, vision, or digital for commercial, education, security and entertainment purposes for the following: TV monitoring and surveillance, background/foreground music, intercom and telephone interconnect, field programming, inventory control systems, microwave transmission, multi-media, multiplex, radio page, school, intercom and sound burglar alarms and low voltage master clock systems.

Excluded from this classification are energy management systems, life safety systems, supervisory controls and data acquisition systems not intrinsic with the above listed systems, fire alarm systems, nurse call systems and raceways exceeding fifteen feet in length.

TRUCK DRIVER - BUILDING, HEAVY AND HIGHWAY CONSTRUCTION

Class 1. Drivers on 2 axle trucks hauling less than 9 ton. Air compressor and welding machines and brooms, including those pulled by separate units, truck driver helpers, warehouse employees, mechanic helpers, greasers and tiremen, pickup trucks when hauling materials, tools, or workers to and from and on-the-job site, and fork lifts up to 6,000 lb. capacity.

Class 2. Two or three axle trucks hauling more than 9 ton but hauling less than 16 ton. A-frame winch trucks, hydrolift trucks, vactor trucks or similar equipment when used for transportation purposes. Fork lifts over 6,000 lb. capacity, winch trucks, four axle combination units, and ticket writers.

Class 3. Two, three or four axle trucks hauling 16 ton or more. Drivers on water pulls, articulated dump trucks, mechanics and working forepersons, and dispatchers. Five axle or more combination units.

Class 4. Low Boy and Oil Distributors.

Class 5. Drivers who require special protective clothing while employed on hazardous waste work.

TRUCK DRIVER - OIL AND CHIP RESEALING ONLY.

This shall encompass laborers, workers and mechanics who drive contractor or subcontractor owned, leased, or hired pickup, dump, service, or oil distributor trucks. The work includes transporting materials and equipment (including but not limited to, oils, aggregate supplies, parts, machinery and tools) to or from the job site; distributing oil or liquid asphalt and aggregate; stock piling material when in connection with the actual oil and chip contract. The Truck Driver (Oil & Chip Resealing) wage classification does not include supplier delivered materials.

OPERATING ENGINEERS - BUILDING

CLASS 1. Asphalt Screed Man; Aspco Concrete Spreaders; Asphalt Pavers; Asphalt Plant Engineer; Asphalt Rollers on Bituminous Concrete; Athey Loaders; Backfillers, Crane Type; Backhoes; Barber Green Loaders; Bulldozers; Cableways; Cherry Pickers; Clam Shells; C.M.I. & similar type autograde formless paver, autograde placer & finisher; Concrete Breakers; Concrete Pumps; Derricks; Derrick Boats; Draglines; Earth Auger or Boring Machines; Elevating Graders; Engineers on Dredges; Gravel Processing Machines; Head Equipment Greaser; High Lifts or Fork Lifts; Hoists with two or more drums or two or more load lines; Locomotives, All; Mechanics; Motor Graders or Auto Patrols; Operators or Leverman on Dredges; Operators, Power Boat; Operators, Pug Mill (Asphalt Plants); Orange Peels; Overhead Cranes; Paving Mixers; Piledrivers; Pipe Wrapping and Painting Machines;

Pushdozers, or Push Cats; Robotic Controlled Equipment in this Classification; Rock Crushers; Ross Carrier or Similar Machines; Rotomill; Scoops, Skimmer, two cu. yd. capacity and under; Scoops, All or Tournapull; Sheep-Foot Roller (Self Propelled); Shovels; Skid Steer; Skimmer Scoops; Temporary Concrete Plant Operators; Test Hole Drilling Machines; Tower Machines; Tower Mixers; Track Type End Loaders; Track Type Fork Lifts or High Lifts; Track Jacks and Tampers; Tractors, Sideboom; Trenching or Ditching Machine; Tunnelluggers; Vermeer Type Saws; Water Blaster Cutting Head; Wheel Type End Loaders; Winch Cat.

CLASS 2. Air Compressors (six to eight)*; Asphalt Boosters and Heaters; Asphalt Distributors; Asphalt Plant Fireman; Oiler on Two Paving Mixers When Used in Tandem; Boom or Winch Trucks; Bull Floats or Flexplanes; Concrete Finishing Machine; Concrete Saws, Self-Propelled; Concrete Spreading Machines; Conveyors (six to eight)*; Generators (six to eight)*; Gravel or Stone Spreader, Power Operated; Hoist (with One Drum and One Load Line); Light Plants (six to eight)*; Mechanical Heaters (six to eight)*; Mud Jacks; Post Hole Digger, Mechanical; Pug Mills when used for other than Asphalt operation; Robotic Controlled Equipment in this Classification; Road or Street Sweeper, Self Propelled; Rollers (except bituminous concrete); Seaman Tiller; Straw Machine; Vibratory Compactor; Water Blaster, Power Unit; Welding Machines (six to eight)*; Well Drill Machines.

CLASS 3. Air Compressors(one to five)*; Air Compressors, Track or Self-Propelled; Automatic Hoist; Building Elevators; Bulk Cement Batching Plants; Conveyors (one to five)*; Concrete Mixers (Except Plant, Paver, or Tower); Firemen; Generators (one to five)*; Greasers; Helper on Single Paving Mixer; Hoist, Automatic; Light Plants (one to five)*; Mechanic Helpers; Mechanical Heaters (one to five)*; Oilers; Power Form Graders; Power Sub-Graders; Robotic Controlled Equipment in this Classification; Scissors Hoist; Tractors without power attachments regardless of size or type; Truck Crane Oiler and Driver (1 man); Vibratory Hammer (power source); Water Pumps (one to five)*; Welding Machines (1/300 Amp. or over)*; Welding machines (one to five)*

CLASS 4. Lattice Boom Crawler Cranes; Lattice Boom Truck Cranes; Telescopic Truck-Mounted Cranes; Tower Cranes.

* Combinations of one to eight of any Air Compressors, Conveyors, Welding Machines, Water Pumps, Light Plants, or Generators shall be in batteries or within 400 feet and shall be paid as per the Classification Schedule contained in this Article.

OPERATING ENGINEERS - HIGHWAY

CLASS 1. Asphalt Screed Man; Asphco Concrete Spreaders; Asphalt Pavers; Asphalt Plant Engineer; Asphalt Rollers on Bituminous Concrete; Athey Loaders; Backhoes; Barber Green Loaders; Bulldozers; Cableways; Carry Deck Pickers; Cherry Pickers (Rough Terrain); C.M.I. & similar type-autograde formless paver, autograde placer & finisher; Concrete Breakers; Concrete Plant Operators; Concrete Pumps; Derricks; Derrick Boats; Dewatering Systems; Earth Auger or Boring Machines; Elevating Graders; Engineers on Dredges; Gravel Processing Machines; Grout Pump; Head Equipment Greaser; High Lifts or Fork Lifts; Hoists with two or more drums or two or more load lines; Hydro Jet or Hydro Laser; Locomotives, All; Mechanics; Motor Graders or Auto Patrols; Multi-Point Power Lifting Equipment; Operators or Leverman on Dredges; Operators, Power Boat; Operators, Pug Mill (Asphalt Plants); Overhead Cranes; Paving Mixers; Piledrivers; Pipe Wrapping and Painting Machines; Push-dozers, or Push Cats; Robotic Controlled Equipment in

this Classification; Rock Crushers; Ross Carrier or Similar Machines; Roto-Mill; Scoops, Skimmer, two cu. yd. capacity and under; Sheep-Foot Roller (Self Pro-pelled); Shovels; Skid Steer; Skimmer Scoops; Test Hole Drilling Machines; Tower Machines; Tower Mixers; Track Type End Loaders; Track Type Fork Lifts or High Lifts; Track Jacks and Tampers; Tractors, Side-boom; Trenching or Ditching Machine; Tunnelluggers; Vermeer-Type Saws; Wheel Type End Loaders; Winch Cat; Scoops, All or Tournapull.

CLASS 2. Air Compressors (six to eight)*; Articulated Dumps; Asphalt Boosters and Heaters; Asphalt Distributors; Asphalt Plant Fireman; Boom or Winch Trucks; Building Elevators; Bull Floats or Flexplanes; Concrete Finishing Machine; Concrete Saws, Self-Propelled; Concrete Spreading Machines; Conveyors (six to eight)*; Generators (six to eight)*; Gravel or Stone Spreader, Power Operated; Hoist, Automatic; Hoist with One Drum and One Load Line; Light Plants (six to eight)*; Mechanical Heaters (six to eight)*; Mud Jacks; Off Road Water Wagons; Oiler on Two Paving Mixers When Used in Tandem; Post Hole Digger, Mechanical; Robotic Controlled Equipment in This Classification; Road or Street Sweeper, Self-Propelled; Rollers (except bituminous concrete); Scissor Hoist; Sea-man Tiller; Straw Machine; Vibratory Compactor; Water Pumps (six to eight)*; Well Drill Machines.

CLASS 3. Air Compressors (one to five)*; Air Compressors, Track or Self-Propelled; Bulk Cement Batching Plants; Conveyors (one to five)*; Concrete Mixers (Except Plant, Paver, or Tower); Firemen; Generators (one to five)*; Greasers; Helper on Single Paving Mixer; Light Plants (one to five)*; Mechanic Helpers; Mechanical Heaters (one to five)*; Oilers; Power Form Graders; Power Sub-Graders; Pug Mills when used for other than Asphalt operation; Robotic Controlled Equipment in This Classification; Tractors without power attachments, regardless of size or type; Truck Crane Oiler and Driver (1 man); Vibratory Hammer (power source); Water Pumps (one to five)*; Welding Machines (one 300 Amp. or over)*; Welding Machines (one to five)*.

CLASS 4. Lattice Boom Crawler Crane; Lattice Boom Truck Crane; Telescopic Truck-Mounted Crane; Tower Crane.

*Combinations of one to eight of any Air Compressors, Conveyors, Welding Machines, Water Pumps, Light Plants or Generators shall be in batteries or within 400 feet and shall be paid as per the Classification Schedule contained in this Article.

OPERATING ENGINEER - OIL AND CHIP RESEALING ONLY.

This shall encompass the operation of all motorized heavy equipment used in oil and chip resealing, including but not limited to operating self-propelled chip spreaders, and all types of rollers (both hard and rubber tired); and other duties pertaining to the operation or maintenance of heavy equipment related to oil & chip resealing.

Other Classifications of Work:

For definitions of classifications not otherwise set out, the Department generally has on file such definitions which are available. If a task to be performed is not subject to one of the classifications of pay set out, the Department will upon being contacted state which neighboring county has such a classification and provide such rate, such rate being deemed to exist by reference in this document. If no neighboring county rate applies to the task, the Department shall undertake a special determination, such special determination being then deemed to have existed under this determination. If a project requires these, or any classification not listed, please contact IDOL at 217-782-1710 for wage rates or

clarifications.

LANDSCAPING

Landscaping work falls under the existing classifications for laborer, operating engineer and truck driver. The work performed by landscape plantsman and landscape laborer is covered by the existing classification of laborer. The work performed by landscape operators (regardless of equipment used or its size) is covered by the classifications of operating engineer. The work performed by landscape truck drivers (regardless of size of truck driven) is covered by the classifications of truck driver.

Macoupin County Prevailing Wage for May 2013

(See explanation of column headings at bottom of wages)

Trade Name	RG	TYP	C	Base	FRMAN	M-F>8	OSA	OSH	H/W	Pensn	Vac	Trng
=====	==	===	=	=====	=====	=====	===	===	=====	=====	=====	=====
ASBESTOS ABT-GEN		ALL		30.440	30.940	1.5	1.5	2.0	5.750	10.26	0.000	0.800
ASBESTOS ABT-MEC		BLD		29.860	30.860	1.5	1.5	2.0	6.950	3.000	0.000	0.000
BOILERMAKER		BLD		31.500	34.000	1.5	1.5	2.0	7.070	18.73	1.000	0.350
BRICK MASON	N	BLD		29.250	30.250	1.5	1.5	2.0	8.200	8.330	0.000	0.580
BRICK MASON	S	BLD		29.280	33.160	1.5	1.5	2.0	7.750	9.430	2.000	0.400
CARPENTER		BLD		28.850	31.100	1.5	1.5	2.0	7.450	13.40	0.000	0.520
CARPENTER		HWY		29.450	31.200	1.5	1.5	2.0	7.450	13.35	0.000	0.520
CEMENT MASON		ALL		31.000	32.000	1.5	1.5	2.0	9.250	11.75	0.000	0.200
CERAMIC TILE FNSHER		BLD		25.890	0.000	1.5	1.5	2.0	6.000	5.200	0.000	0.530
ELECTRIC PWR EQMT OP	N	ALL		35.440	0.000	1.5	1.5	2.0	5.000	10.98	0.000	0.270
ELECTRIC PWR EQMT OP	S	ALL		36.870	0.000	1.5	1.5	2.0	6.790	10.32	0.000	0.270
ELECTRIC PWR GRNDMAN	N	ALL		24.320	0.000	1.5	1.5	2.0	5.000	7.540	0.000	0.180
ELECTRIC PWR GRNDMAN	S	ALL		27.530	0.000	1.5	1.5	2.0	5.070	7.710	0.000	0.210
ELECTRIC PWR LINEMAN	N	ALL		39.370	41.910	1.5	1.5	2.0	5.000	12.20	0.000	0.300
ELECTRIC PWR LINEMAN	S	ALL		42.400	44.450	1.5	1.5	2.0	7.810	11.87	0.000	0.320
ELECTRIC PWR TRK DRV	N	ALL		25.510	0.000	1.5	1.5	2.0	5.000	7.920	0.000	0.190
ELECTRIC PWR TRK DRV	S	ALL		30.100	0.000	1.5	1.5	2.0	5.540	8.430	0.000	0.230
ELECTRICIAN	N	BLD		34.220	36.220	1.5	1.5	2.0	5.860	8.120	0.000	0.400
ELECTRICIAN	S	ALL		36.510	38.700	1.5	1.5	2.0	7.810	7.490	0.000	0.640
ELECTRONIC SYS TECH	N	BLD		30.720	32.470	1.5	1.5	2.0	3.650	7.920	0.000	0.400
ELECTRONIC SYS TECH	S	BLD		28.740	30.490	1.5	1.5	2.0	7.500	5.860	0.000	0.400
ELEVATOR CONSTRUCTOR		BLD		43.715	49.180	2.0	2.0	2.0	11.88	12.71	3.500	0.600
GLAZIER	N	BLD		30.780	32.780	1.5	2.0	2.0	6.630	8.150	0.000	0.380
GLAZIER	S	BLD		32.780	0.000	2.0	2.0	2.0	9.020	10.80	2.630	0.310
HT/FROST INSULATOR		BLD		37.260	38.260	1.5	1.5	2.0	7.850	11.16	0.000	0.500
IRON WORKER	N	BLD		29.460	31.460	1.5	1.5	2.0	7.740	11.38	0.000	0.660
IRON WORKER	N	HWY		30.600	32.100	1.5	1.5	2.0	7.740	11.69	0.000	0.660
IRON WORKER	S	ALL		31.500	33.500	1.5	1.5	2.0	7.610	13.33	0.000	0.420
LABORER		ALL		29.940	30.440	1.5	1.5	2.0	5.750	10.26	0.000	0.800
LATHER		BLD		28.850	31.100	1.5	1.5	2.0	7.450	13.40	0.000	0.520
MACHINIST		BLD		43.550	46.050	1.5	1.5	2.0	6.130	8.950	1.850	0.000
MARBLE FINISHERS		BLD		25.890	0.000	1.5	1.5	2.0	6.000	5.200	0.000	0.530
MARBLE MASON		BLD		27.100	27.850	1.5	1.5	2.0	8.200	7.230	0.000	0.000
MILLWRIGHT		BLD		29.620	31.870	1.5	1.5	2.0	7.450	13.09	0.000	0.520
MILLWRIGHT		HWY		31.690	33.440	1.5	1.5	2.0	7.450	13.54	0.000	0.520
OPERATING ENGINEER		BLD	1	34.200	37.200	1.5	1.5	2.0	9.000	17.00	0.000	1.000
OPERATING ENGINEER		BLD	2	33.070	37.200	1.5	1.5	2.0	9.000	17.00	0.000	1.000
OPERATING ENGINEER		BLD	3	28.590	37.200	1.5	1.5	2.0	9.000	17.00	0.000	1.000
OPERATING ENGINEER		BLD	4	28.650	37.200	1.5	1.5	2.0	9.000	17.00	0.000	1.000
OPERATING ENGINEER		BLD	5	28.320	37.200	1.5	1.5	2.0	9.000	17.00	0.000	1.000
OPERATING ENGINEER		BLD	6	35.750	37.200	1.5	1.5	2.0	9.000	17.00	0.000	1.000
OPERATING ENGINEER		BLD	7	36.050	37.200	1.5	1.5	2.0	9.000	17.00	0.000	1.000
OPERATING ENGINEER		BLD	8	36.330	37.200	1.5	1.5	2.0	9.000	17.00	0.000	1.000
OPERATING ENGINEER		BLD	9	35.650	37.200	1.5	1.5	2.0	9.000	17.00	0.000	1.000
OPERATING ENGINEER		HWY	1	32.700	35.700	1.5	1.5	2.0	9.000	17.00	0.000	1.000

OPERATING ENGINEER		HWY 2	31.570	35.700	1.5	1.5	2.0	9.000	17.00	0.000	1.000
OPERATING ENGINEER		HWY 3	27.090	35.700	1.5	1.5	2.0	9.000	17.00	0.000	1.000
OPERATING ENGINEER		HWY 4	27.150	35.700	1.5	1.5	2.0	9.000	17.00	0.000	1.000
OPERATING ENGINEER		HWY 5	26.820	35.700	1.5	1.5	2.0	9.000	17.00	0.000	1.000
OPERATING ENGINEER		HWY 6	34.250	35.700	1.5	1.5	2.0	9.000	17.00	0.000	1.000
OPERATING ENGINEER		HWY 7	34.550	35.700	1.5	1.5	2.0	9.000	17.00	0.000	1.000
OPERATING ENGINEER		HWY 8	34.830	35.700	1.5	1.5	2.0	9.000	17.00	0.000	1.000
OPERATING ENGINEER		HWY 9	34.150	35.700	1.5	1.5	2.0	9.000	17.00	0.000	1.000
PAINTER		BLD	29.250	30.750	1.5	1.5	2.0	5.000	7.920	0.000	0.600
PAINTER		HWY	30.450	31.950	1.5	1.5	2.0	5.000	7.920	0.000	0.600
PAINTER OVER 30FT		BLD	30.250	31.750	1.5	1.5	2.0	5.000	7.920	0.000	0.600
PAINTER PWR EQMT		BLD	30.250	31.750	1.5	1.5	2.0	5.000	7.920	0.000	0.600
PAINTER PWR EQMT		HWY	31.450	32.950	1.5	1.5	2.0	5.000	7.920	0.000	0.600
PILEDRIVER		BLD	29.350	31.600	1.5	1.5	2.0	7.450	13.40	0.000	0.520
PILEDRIVER		HWY	30.450	32.200	1.5	1.5	2.0	7.450	13.35	0.000	0.520
PIPEFITTER	N	BLD	40.020	44.020	1.5	1.5	2.0	7.000	7.750	0.000	0.900
PIPEFITTER	S	BLD	37.800	39.690	2.0	2.0	2.0	4.500	8.360	0.000	0.300
PLASTERER		BLD	30.250	31.250	1.5	1.5	2.0	9.250	8.600	0.000	0.050
PLUMBER	N	BLD	40.020	44.020	1.5	1.5	2.0	7.000	7.750	0.000	0.900
PLUMBER	S	BLD	37.800	39.690	2.0	2.0	2.0	4.500	8.360	0.000	0.300
ROOFER		BLD	27.900	30.400	1.5	1.5	2.0	8.600	6.750	0.000	0.500
SHEETMETAL WORKER		ALL	31.690	33.190	1.5	1.5	2.0	7.130	6.730	1.910	0.360
SPRINKLER FITTER		BLD	38.780	41.780	2.0	2.0	2.0	8.370	11.18	0.000	1.000
STONE MASON		BLD	29.250	30.250	1.5	1.5	2.0	8.200	8.330	0.000	0.580
TERRAZZO FINISHER		BLD	31.240	0.000	1.5	1.5	2.0	6.000	3.230	0.000	0.200
TERRAZZO MASON		BLD	32.530	32.830	1.5	1.5	2.0	6.000	5.230	0.000	0.210
TILE MASON		BLD	27.100	27.850	1.5	1.5	2.0	8.200	7.230	0.000	0.000
TRUCK DRIVER		ALL 1	31.340	0.000	1.5	1.5	2.0	10.30	5.010	0.000	0.250
TRUCK DRIVER		ALL 2	31.780	0.000	1.5	1.5	2.0	10.30	5.010	0.000	0.250
TRUCK DRIVER		ALL 3	32.020	0.000	1.5	1.5	2.0	10.30	5.010	0.000	0.250
TRUCK DRIVER		ALL 4	32.280	0.000	1.5	1.5	2.0	10.30	5.010	0.000	0.250
TRUCK DRIVER		ALL 5	33.130	0.000	1.5	1.5	2.0	10.30	5.010	0.000	0.250
TRUCK DRIVER		O&C 1	25.070	0.000	1.5	1.5	2.0	10.30	5.010	0.000	0.250
TRUCK DRIVER		O&C 2	25.420	0.000	1.5	1.5	2.0	10.30	5.010	0.000	0.250
TRUCK DRIVER		O&C 3	25.620	0.000	1.5	1.5	2.0	10.30	5.010	0.000	0.250
TRUCK DRIVER		O&C 4	25.820	0.000	1.5	1.5	2.0	10.30	5.010	0.000	0.250
TRUCK DRIVER		O&C 5	26.500	0.000	1.5	1.5	2.0	10.30	5.010	0.000	0.250
TUCKPOINTER	N	BLD	29.250	30.250	1.5	1.5	2.0	8.200	8.330	0.000	0.580

Legend :

RG (Region)

TYP (Trade Type - All,Highway,Building,Floating,Oil & Chip,Rivers)

C (Class)

Base (Base Wage Rate)

FRMAN (Foreman Rate)

M-F>8 (OT required for any hour greater than 8 worked each day, Mon through Fri.)

OSA (Overtime (OT) is required for every hour worked on Saturday)

OSH (Overtime is required for every hour worked on Sunday and Holidays)

H/W (Health & Welfare Insurance)

Pensn (Pension)

Vac (Vacation)

Explanations

MACOUPIN COUNTY

BRICKLAYERS (SOUTH) - Approximately the Southern 1/3 of the county including Hornsby (approx.).

CARPENTERS & PILEDRIVERS (NORTH) - North of Route 108.

ELECTRICIAN (NORTH) - Townships of Scottsville, North Palmyra, North Otter, Virden, Girard, Barr, South Palmyra, South Otter and Nilwood.

ELECTRICIAN (SOUTH) - Townships of Western Mound, Bird, Carlinville, Shaws Point, Chesterfield, Polk, Brushy Mound, Honey Point, Shipman, Hillyard, Gillespie, Cahokia, Bunker Hill, Dorchester, Mount Olive and Staunton.

GLAZIER (SOUTH) - South of Highway 108.

IRONWORKERS (SOUTH) - That part of the county South of a diagonal line between Rockbridge (Greene County) and Litchfield (Montgomery County).

PLUMBERS AND PIPEFITTERS (NORTH) - That part of the county North of Route 108.

The following list is considered as those days for which holiday rates of wages for work performed apply: New Years Day, Memorial Day, Fourth of July, Labor Day, Thanksgiving Day, Christmas Day and Veterans Day in some classifications/counties. Generally, any of these holidays which fall on a Sunday is celebrated on the following Monday. This then makes work performed on that Monday payable at the appropriate overtime rate for holiday pay. Common practice in a given local may alter certain days of celebration. If in doubt, please check with IDOL.

Oil and chip resealing (O&C) means the application of road oils and liquid asphalt to coat an existing road surface, followed by application of aggregate chips or gravel to coated surface, and subsequent rolling of material to seal the surface.

EXPLANATION OF CLASSES

ASBESTOS - GENERAL - removal of asbestos material/mold and hazardous materials from any place in a building, including mechanical systems where those mechanical systems are to be removed. This includes the removal of asbestos materials/mold and hazardous materials from ductwork or pipes in a building when the building is to be demolished at the time or at some close future date.

ASBESTOS - MECHANICAL - removal of asbestos material from mechanical systems, such as pipes, ducts, and boilers, where the mechanical systems are to remain.

CERAMIC TILE FINISHER AND MARBLE FINISHER

The handling, at the building site, of all sand, cement, tile, marble or stone and all other materials that may be used and installed by [a] tile layer or marble mason. In addition, the grouting, cleaning, sealing, and mixing on the job site, and all other work as required in

assisting the setter. The term "Ceramic" is used for naming the classification only and is in no way a limitation of the product handled. Ceramic takes into consideration most hard tiles.

ELECTRONIC SYSTEMS TECHNICIAN

Installation, service and maintenance of low-voltage systems which utilizes the transmission and/or transference of voice, sound, vision, or digital for commercial, education, security and entertainment purposes for the following: TV monitoring and surveillance, background/foreground music, intercom and telephone interconnect, field programming, inventory control systems, microwave transmission, multi-media, multiplex, radio page, school, intercom and sound burglar alarms and low voltage master clock systems.

Excluded from this classification are energy management systems, life safety systems, supervisory controls and data acquisition systems not intrinsic with the above listed systems, fire alarm systems, nurse call systems and raceways exceeding fifteen feet in length.

OPERATING ENGINEER - BUILDING

GROUP I. Cranes, Dragline, Shovels, Skimmer Scoops, Clamshells or Derrick Boats, Pile Drivers, Crane-Type Backhoes, Asphalt Plant Operators, Concrete Plant Operators, Dredges, Asphalt Spreading Machines, All Locomotives, Cable Ways or Tower Machines, Hoists, Hydraulic Backhoes, Ditching Machines or Backfiller, Cherrypickers, Overhead Cranes, Roller - Steam or Gas, Concrete Pavers, Excavators, Concrete Breakers, Concrete Pumps, Bulk Cement Plants, Cement Pumps, Derrick-Type Drills, Boat Operators, Motor Graders or Pushcats, Scoops or Tournapulls, Bulldozers, Endloaders or Fork Lifts, Power Blade or Elevating Graders, Winch Cats, Boom or Winch Trucks or Boom Tractors, Pipe Wrapping or Painting Machines, Asphalt Plant Engineer, Journeyman Lubricating Engineer, Drills (other than Derrick Type), Mud Jacks, or Well Drilling Machines, Boring Machines or Track Jacks, Mixers, Conveyors (Two), Air Compressors (Two), Water Pumps regardless of size (Two), Welding Machines (Two), Siphons or Jets (Two), Winch Heads or Apparatuses (Two), Light Plants (Two), All Tractors regardless of size (straight tractor only), Fireman on Stationary Boilers, Automatic Elevators, Form Grading Machines, Finishing Machines, Power Sub-Grader or Ribbon Machines, Longitudinal Floats, Distributor Operators on Trucks, Winch Heads or Apparatuses (One), Mobil Track air and heaters (two to five), Heavy Equipment Greaser, Relief Operator, Assistant Master Mechanic and Heavy Duty Mechanic, self-propelled concrete saws of all types and sizes with their attachments, gob-hoppers, excavators all sizes, the repair and greasing of all diesel hammers, the operation and set-up of bidwells, water blasters of all sizes and their clutches, hydraulic jacks where used for hoisting, operation of log skidders, iceolators used on and off of pipeline, condor cranes, bow boats, survey boats, bobcats and all their attachments, skid steer loaders and all their attachments, creter cranes, batch plants, operator (all sizes), self propelled roto mills, operation of conveyor systems of any size and any configuration, operation, repair and service of all vibratory hammers, all power pacs and their controls regardless of location, curtains or brush burning machines, stump cutter machines, Nail launchers when mounted on a machine or self-propelled, operation of con-cover machines, and all Operators except those listed below).

GROUP II. Assistant Operators.

GROUP III. Air Compressors (One), Water Pumps, regardless of Size (One), Waterblasters (one), Welding Machine (One), Mixers (One Bag), Conveyor (One), Siphon or Jet (One), Light Plant (One), Heater (One), Immobile Track Air (One), and Self Propelled Walk-Behind Rollers.

GROUP IV. Asphalt Spreader Oilers, Fireman on Whirlies and Heavy Equipment Oilers, Truck Cranes, Dredges, Monigans, Large Cranes - (Over 65-ton rated capacity) Concrete Plant Oiler, Blacktop Plant Oiler, and Creter Crane Oiler (when required).

GROUP V. Oiler.

GROUP VI. Operators on equipment with Booms, including jibs, 100 feet and over, and less than 150 feet long.

GROUP VII. Operators on equipment with Booms, including jibs, 150 feet and over, and less than 200 feet long.

GROUP VIII. Operators on Equipment with Booms, including jibs, 200 feet and over; Tower Cranes; and Whirlie Cranes.

GROUP IX. Master Mechanic

OPERATING ENGINEERS - Highway

GROUP I. Cranes, Dragline, Shovels, Skimmer Scoops, Clamshells or Derrick Boats, Pile Drivers, Crane-Type Backhoes, Asphalt Plant Operators, Concrete Plant Operators, Dredges, Asphalt Spreading Machines, All Locomotives, Cable Ways or Tower Machines, Hoists, Hydraulic Backhoes, Ditching Machines or Backfiller, Cherrypickers, Overhead Cranes, Roller - Steam or Gas, Concrete Pavers, Excavators, Concrete Breakers, Concrete Pumps, Bulk Cement Plants, Cement Pumps, Derrick-Type Drills, Boat Operators, Motor Graders or Pushcats, Scoops or Tournapulls, Bulldozers, Endloaders or Fork Lifts, Power Blade or Elevating Graders, Winch Cats, Boom or Winch Trucks or Boom Tractors, Pipe Wrapping or Painting Machines, Asphalt Plant Engineer, Journeyman Lubricating Engineer, Drills (other than Derrick Type), Mud Jacks, Well Drilling Machines, Boring Machines, Track Jacks, Mixers, Conveyors (Two), Air Compressors (Two), Water Pumps regardless of size (Two), Welding Machines (Two), Siphons or Jets (Two), Winch Heads or Apparatuses (Two), Light Plants (Two), All Tractors regardless of size (straight tractor only), Fireman on Stationary Boilers, Automatic Elevators, Form Grading Machines, Finishing Machines, Power Sub-Grader or Ribbon Machines, Longitudinal Floats, Distributor Operators on Trucks, Winch Heads or Apparatuses (One), Mobil Track air and heaters (two to five), Heavy Equipment Greaser, Relief Operator, Assistant Master Mechanic and Heavy Duty Mechanic, self-propelled concrete saws of all types and sizes with their attachments, gob-hoppers, excavators all sizes, the repair and greasing of all diesel hammers, the operation and set-up of bidwells, water blasters of all sizes and their clutches, hydraulic jacks where used for hoisting, operation of log skidders, iceolators used on and off of pipeline, condor cranes, bow boats, survey boats, bobcats and all their attachments, skid steer loaders and all their attachments, creter cranes, batch plants, operator (all sizes), self propelled roto mills, operation of conveyor systems of any size and any configuration, operation, repair and service of all vibratory hammers, all power pacs and their controls regardless of location, curtains or brush burning machines, stump cutter machines, Nail launchers when mounted on a machine or self-propelled, operation of con-cover machines, and all Operators (except those listed below).

GROUP II. Assistant Operators.

GROUP III. Air Compressors (One), Water Pumps, regardless of Size (One), Waterblasters (one), Welding Machine (One), Mixers (One Bag), Conveyor (One), Siphon or Jet (One), Light Plant (One), Heater (One), Immobile Track Air (One), and Self Propelled Walk-Behind Rollers.

GROUP IV. Asphalt Spreader Oilers, Fireman on Whirlies and Heavy Equipment Oilers, Truck Cranes, Dredges, Monigans, Large Cranes - (Over 65-ton rated capacity) Concrete Plant Oiler, Blacktop Plant Oiler, and Creter Crane Oiler (when required).

GROUP V. Oiler.

GROUP VI. Operators on equipment with Booms, including jibs, 100 feet and over, and less than 150 feet long.

GROUP VII. Operators on equipment with Booms, including jibs, 150 feet and over, and less than 200 feet long.

GROUP VIII. Operators on Equipment with Booms, including jibs, 200 feet and over; Tower Cranes; and Whirlie Cranes.

GROUP IX. Mechanic

TRUCK DRIVER - BUILDING, HEAVY AND HIGHWAY CONSTRUCTION

Class 1. Drivers on 2 axle trucks hauling less than 9 ton. Air compressor and welding machines and brooms, including those pulled by separate units, truck driver helpers, warehouse employees, mechanic helpers, greasers and tiremen, pickup trucks when hauling materials, tools, or workers to and from and on-the-job site, and fork lifts up to 6,000 lb. capacity.

Class 2. Two or three axle trucks hauling more than 9 ton but hauling less than 16 ton. A-frame winch trucks, hydrolift trucks, vactor trucks or similar equipment when used for transportation purposes. Fork lifts over 6,000 lb. capacity, winch trucks, four axle combination units, and ticket writers.

Class 3. Two, three or four axle trucks hauling 16 ton or more. Drivers on water pulls, articulated dump trucks, mechanics and working forepersons, and dispatchers. Five axle or more combination units.

Class 4. Low Boy and Oil Distributors.

Class 5. Drivers who require special protective clothing while employed on hazardous waste work.

TRUCK DRIVER - OIL AND CHIP RESEALING ONLY.

This shall encompass laborers, workers and mechanics who drive contractor or subcontractor owned, leased, or hired pickup, dump, service, or oil distributor trucks. The work includes transporting materials and equipment (including but not limited to, oils, aggregate supplies, parts, machinery and tools) to or from the job site; distributing oil or liquid asphalt and aggregate; stock piling material when in connection with the actual oil and chip contract. The Truck Driver (Oil & Chip Resealing) wage classification does not include supplier delivered materials.

TERRAZZO FINISHER

The handling of all materials used for Mosaic and Terrazzo work including preparing, mixing by hand, by mixing machine or transporting of pre-mixed materials and distributing with shovel, rake, hoe, or pail, all kinds of concrete foundations necessary for Mosaic and Terrazzo work, all cement terrazzo, magnesite terrazzo, Do-O-Tex terrazzo, epoxy matrix ter-razzo, exposed aggregate, rustic or rough washed for exterior or interior of buildings placed either by machine

or by hand, and any other kind of mixture of plastics composed of chips or granules when mixed with cement, rubber, neoprene, vinyl, magnesium chloride or any other resinous or chemical substances used for seamless flooring systems, and all other building materials, all similar materials and all precast terrazzo work on jobs, all scratch coat used for Mosaic and Terrazzo work and sub-bed, tar paper and wire mesh (2x2 etc.) or lath. The rubbing, grinding, cleaning and finishing of same either by hand or by machine or by terrazzo resurfacing equipment on new or existing floors. When necessary finishers shall be allowed to assist the mechanics to spread sand bed, lay tarpaper and wire mesh (2x2 etc.) or lath. The finishing of cement floors where additional aggregate of stone is added by spreading or sprinkling on top of the finished base, and troweled or rolled into the finish and then the surface is ground by grinding machines.

Other Classifications of Work:

For definitions of classifications not otherwise set out, the Department generally has on file such definitions which are available. If a task to be performed is not subject to one of the classifications of pay set out, the Department will upon being contacted state which neighboring county has such a classification and provide such rate, such rate being deemed to exist by reference in this document. If no neighboring county rate applies to the task, the Department shall undertake a special determination, such special determination being then deemed to have existed under this determination. If a project requires these, or any classification not listed, please contact IDOL at 217-782-1710 for wage rates or clarifications.

LANDSCAPING

Landscaping work falls under the existing classifications for laborer, operating engineer and truck driver. The work performed by landscape plantsman and landscape laborer is covered by the existing classification of laborer. The work performed by landscape operators (regardless of equipment used or its size) is covered by the classifications of operating engineer. The work performed by landscape truck drivers (regardless of size of truck driven) is covered by the classifications of truck driver.

Madison County Prevailing Wage for May 2013

(See explanation of column headings at bottom of wages)

Trade Name	RG	TYP	C	Base	FRMAN	M-F>8	OSA	OSH	H/W	Pensn	Vac	Trng
ASBESTOS ABT-GEN	NW	ALL		30.860	31.360	1.5	1.5	2.0	5.750	9.840	0.000	0.800
ASBESTOS ABT-GEN	SE	ALL		29.800	30.300	1.5	1.5	2.0	6.050	10.60	0.000	0.800
ASBESTOS ABT-MEC		BLD		29.860	30.860	1.5	1.5	2.0	6.950	3.000	0.000	0.000
BOILERMAKER		BLD		31.500	34.000	1.5	1.5	2.0	7.070	18.73	1.000	0.350
BRICK MASON		BLD		29.280	33.160	1.5	1.5	2.0	7.750	9.430	2.000	0.400
CARPENTER		ALL		34.630	36.130	1.5	1.5	2.0	6.550	6.750	0.000	0.400
CEMENT MASON		ALL		31.000	32.000	1.5	1.5	2.0	9.250	11.75	0.000	0.200
CERAMIC TILE FNSHER		BLD		25.890	0.000	1.5	1.5	2.0	6.000	5.200	0.000	0.530
ELECTRIC PWR EQMT OP NW	ALL			36.690	44.520	1.5	2.0	2.0	5.000	9.170	0.000	0.280
ELECTRIC PWR EQMT OP SE	ALL			36.870	0.000	1.5	1.5	2.0	6.790	10.32	0.000	0.270
ELECTRIC PWR GRNDMAN NW	ALL			24.940	44.520	1.5	2.0	2.0	5.000	6.240	0.000	0.190
ELECTRIC PWR GRNDMAN SE	ALL			27.530	0.000	1.5	1.5	2.0	5.070	7.710	0.000	0.210
ELECTRIC PWR LINEMAN NW	ALL			42.210	44.520	1.5	2.0	2.0	5.000	10.56	0.000	0.320
ELECTRIC PWR LINEMAN SE	ALL			42.400	44.450	1.5	1.5	2.0	7.810	11.87	0.000	0.320
ELECTRIC PWR TRK DRV NW	ALL			25.560	44.520	1.5	2.0	2.0	5.000	6.390	0.000	0.190

ELECTRIC PWR TRK DRV	SE	ALL	30.100	0.000	1.5	1.5	2.0	5.540	8.430	0.000	0.230
ELECTRICIAN	NW	ALL	36.400	38.650	1.5	1.5	2.0	7.500	9.090	0.000	0.550
ELECTRICIAN	SE	ALL	36.510	38.700	1.5	1.5	2.0	7.810	7.490	0.000	0.640
ELECTRONIC SYS TECH	NW	BLD	28.740	30.490	1.5	1.5	2.0	7.500	5.860	0.000	0.400
ELECTRONIC SYS TECH	SE	BLD	30.720	32.470	1.5	1.5	2.0	3.650	7.920	0.000	0.400
ELEVATOR CONSTRUCTOR		BLD	43.715	49.180	2.0	2.0	2.0	11.88	12.71	3.500	0.600
FLOOR LAYER		BLD	29.330	30.080	1.5	1.5	2.0	6.550	6.750	0.000	0.400
GLAZIER		BLD	32.780	0.000	2.0	2.0	2.0	9.020	10.80	2.630	0.310
HT/FROST INSULATOR		BLD	37.260	38.260	1.5	1.5	2.0	7.850	11.16	0.000	0.500
IRON WORKER		ALL	31.500	33.500	1.5	1.5	2.0	7.610	13.33	0.000	0.420
LABORER	NW	ALL	30.360	30.860	1.5	1.5	2.0	5.750	9.840	0.000	0.800
LABORER	SE	ALL	29.300	29.800	1.5	1.5	2.0	6.050	10.60	0.000	0.800
MACHINIST		BLD	43.550	46.050	1.5	1.5	2.0	6.130	8.950	1.850	0.000
MARBLE FINISHERS		BLD	25.890	0.000	1.5	1.5	2.0	6.000	5.200	0.000	0.530
MARBLE MASON		BLD	29.280	33.160	1.5	1.5	2.0	7.750	9.430	2.000	0.400
MILLWRIGHT		ALL	34.630	36.130	1.5	1.5	2.0	6.550	6.750	0.000	0.400
OPERATING ENGINEER		BLD 1	34.200	37.200	1.5	1.5	2.0	9.000	17.00	0.000	1.000
OPERATING ENGINEER		BLD 2	33.070	37.200	1.5	1.5	2.0	9.000	17.00	0.000	1.000
OPERATING ENGINEER		BLD 3	28.590	37.200	1.5	1.5	2.0	9.000	17.00	0.000	1.000
OPERATING ENGINEER		BLD 4	28.650	37.200	1.5	1.5	2.0	9.000	17.00	0.000	1.000
OPERATING ENGINEER		BLD 5	28.320	37.200	1.5	1.5	2.0	9.000	17.00	0.000	1.000
OPERATING ENGINEER		BLD 6	35.750	37.200	1.5	1.5	2.0	9.000	17.00	0.000	1.000
OPERATING ENGINEER		BLD 7	36.050	37.200	1.5	1.5	2.0	9.000	17.00	0.000	1.000
OPERATING ENGINEER		BLD 8	36.330	37.200	1.5	1.5	2.0	9.000	17.00	0.000	1.000
OPERATING ENGINEER		BLD 9	35.650	37.200	1.5	1.5	2.0	9.000	17.00	0.000	1.000
OPERATING ENGINEER		HWY 1	32.700	35.700	1.5	1.5	2.0	9.000	17.00	0.000	1.000
OPERATING ENGINEER		HWY 2	31.570	35.700	1.5	1.5	2.0	9.000	17.00	0.000	1.000
OPERATING ENGINEER		HWY 3	27.090	35.700	1.5	1.5	2.0	9.000	17.00	0.000	1.000
OPERATING ENGINEER		HWY 4	27.150	35.700	1.5	1.5	2.0	9.000	17.00	0.000	1.000
OPERATING ENGINEER		HWY 5	26.820	35.700	1.5	1.5	2.0	9.000	17.00	0.000	1.000
OPERATING ENGINEER		HWY 6	34.250	35.700	1.5	1.5	2.0	9.000	17.00	0.000	1.000
OPERATING ENGINEER		HWY 7	34.550	35.700	1.5	1.5	2.0	9.000	17.00	0.000	1.000
OPERATING ENGINEER		HWY 8	34.830	35.700	1.5	1.5	2.0	9.000	17.00	0.000	1.000
OPERATING ENGINEER		HWY 9	34.150	35.700	1.5	1.5	2.0	9.000	17.00	0.000	1.000
PAINTER		BLD	29.250	30.750	1.5	1.5	2.0	5.000	7.920	0.000	0.600
PAINTER		HWY	30.450	31.950	1.5	1.5	2.0	5.000	7.920	0.000	0.600
PAINTER OVER 30FT		BLD	30.250	31.750	1.5	1.5	2.0	5.000	7.920	0.000	0.600
PAINTER PWR EQMT		BLD	30.250	31.750	1.5	1.5	2.0	5.000	7.920	0.000	0.600
PAINTER PWR EQMT		HWY	31.450	32.950	1.5	1.5	2.0	5.000	7.920	0.000	0.600
PILEDRIVER		ALL	34.630	36.130	1.5	1.5	2.0	6.550	6.750	0.000	0.400
PIPEFITTER	N	BLD	37.800	39.690	2.0	2.0	2.0	4.500	8.360	0.000	0.300
PIPEFITTER	S	BLD	37.250	39.250	1.5	1.5	2.0	6.740	8.000	0.000	0.750
PLASTERER		BLD	30.250	31.250	1.5	1.5	2.0	9.250	8.600	0.000	0.050
PLUMBER	N	BLD	37.800	39.690	2.0	2.0	2.0	4.500	8.360	0.000	0.300
PLUMBER	S	BLD	36.300	38.800	1.5	1.5	2.0	6.250	6.850	0.000	0.500
ROOFER		BLD	29.500	31.500	1.5	1.5	2.0	8.600	6.850	0.000	0.200
SHEETMETAL WORKER		ALL	31.690	33.190	1.5	1.5	2.0	7.130	6.730	1.910	0.360
SPRINKLER FITTER		BLD	38.780	41.780	2.0	2.0	2.0	8.370	11.18	0.000	1.000
TERRAZZO FINISHER		BLD	31.240	0.000	1.5	1.5	2.0	6.000	3.230	0.000	0.200
TERRAZZO MASON		BLD	32.530	32.830	1.5	1.5	2.0	6.000	5.230	0.000	0.210
TRUCK DRIVER		ALL 1	31.340	0.000	1.5	1.5	2.0	10.30	5.010	0.000	0.250
TRUCK DRIVER		ALL 2	31.780	0.000	1.5	1.5	2.0	10.30	5.010	0.000	0.250
TRUCK DRIVER		ALL 3	32.020	0.000	1.5	1.5	2.0	10.30	5.010	0.000	0.250
TRUCK DRIVER		ALL 4	32.280	0.000	1.5	1.5	2.0	10.30	5.010	0.000	0.250
TRUCK DRIVER		ALL 5	33.130	0.000	1.5	1.5	2.0	10.30	5.010	0.000	0.250
TRUCK DRIVER		O&C 1	25.070	0.000	1.5	1.5	2.0	10.30	5.010	0.000	0.250
TRUCK DRIVER		O&C 2	25.420	0.000	1.5	1.5	2.0	10.30	5.010	0.000	0.250
TRUCK DRIVER		O&C 3	25.620	0.000	1.5	1.5	2.0	10.30	5.010	0.000	0.250
TRUCK DRIVER		O&C 4	25.820	0.000	1.5	1.5	2.0	10.30	5.010	0.000	0.250
TRUCK DRIVER		O&C 5	26.500	0.000	1.5	1.5	2.0	10.30	5.010	0.000	0.250

Legend :

RG (Region)

TYP (Trade Type - All,Highway,Building,Floating,Oil & Chip,Rivers)

C (Class)

Base (Base Wage Rate)

FRMAN (Foreman Rate)

M-F>8 (OT required for any hour greater than 8 worked each day, Mon through Fri.)

OSA (Overtime (OT) is required for every hour worked on Saturday)

OSH (Overtime is required for every hour worked on Sunday and Holidays)

H/W (Health & Welfare Insurance)

Pensn (Pension)

Vac (Vacation)

Trng (Training)

Explanations

MADISON COUNTY

ELECTRICIANS AND ELECTRIC SYSTEMS TECHNICIAN (NORTHWEST) - Townships of Godfrey, Foster and Wood River, and the western one mile of Moro, Ft. Russell and Edwardsville, south to the north side of Hwy. 66 and west to the Mississippi River. This includes SIU-Edwardsville Dental Facility and Alton Mental Health Hospital.

ELECTRICIANS AND ELECTRIC SYSTEMS TECHNICIAN (SOUTHEAST) - Remainder of county not covered by ELECTRICIANS AND ELECTRIC SYSTEMS TECHNICIAN (NW) including SIU-Edwardsville Main Campus.

LABORERS (NORTHWEST) - That area northwest of a diagonal line running from the Mississippi River at the intersection of the waterway known as Wood River at Maple Island, northeast through the highway intersection of Illinois Routes 3 and 143 and following the boundary of Alton/East Alton, then preceding northeast to the county line at a point approximately one mile west of Illinois Route 159.

PLUMBERS AND PIPEFITTERS (SOUTH) - That part of the county South of a line between Mitchell and Highland including the town of Glen Carbon.

The following list is considered as those days for which holiday rates of wages for work performed apply: New Years Day, Memorial Day, Fourth of July, Labor Day, Thanksgiving Day, Christmas Day and Veterans Day in some classifications/counties. Generally, any of these holidays which fall on a Sunday is celebrated on the following Monday. This then makes work performed on that Monday payable at the appropriate overtime rate for holiday pay. Common practice in a given local may alter certain days of celebration. If in doubt, please check with IDOL.

Oil and chip resealing (O&C) means the application of road oils and liquid asphalt to coat an existing road surface, followed by application of aggregate chips or gravel to coated surface, and subsequent rolling of material to seal the surface.

EXPLANATION OF CLASSES

ASBESTOS - GENERAL - removal of asbestos material/mold and hazardous materials from any place in a building, including mechanical systems where those mechanical systems are to be removed. This includes the removal of asbestos materials/mold and hazardous materials from ductwork or pipes in a building when the building is to be demolished at the time or at some close future date.

ASBESTOS - MECHANICAL - removal of asbestos material from mechanical systems, such as pipes, ducts, and boilers, where the mechanical systems are to remain.

CERAMIC TILE FINISHER AND MARBLE FINISHER

The handling, at the building site, of all sand, cement, tile, marble or stone and all other materials that may be used and installed by [a] tile layer or marble mason. In addition, the grouting, cleaning, sealing, and mixing on the job site, and all other work as required in assisting the setter. The term "Ceramic" is used for naming the classification only and is in no way a limitation of the product handled. Ceramic takes into consideration most hard tiles.

ELECTRONIC SYSTEMS TECHNICIAN

Installation, service and maintenance of low-voltage systems which utilizes the transmission and/or transference of voice, sound, vision, or digital for commercial, education, security and entertainment purposes for the following: TV monitoring and surveillance, background/foreground music, intercom and telephone interconnect, field programming, inventory control systems, microwave transmission, multi-media, multiplex, radio page, school, intercom and sound burglar alarms and low voltage master clock systems.

Excluded from this classification are energy management systems, life safety systems, supervisory controls and data acquisition systems not intrinsic with the above listed systems, fire alarm systems, nurse call systems and raceways exceeding fifteen feet in length.

OPERATING ENGINEER - BUILDING

GROUP I. Cranes, Dragline, Shovels, Skimmer Scoops, Clamshells or Derrick Boats, Pile Drivers, Crane-Type Backhoes, Asphalt Plant Operators, Concrete Plant Operators, Dredges, Asphalt Spreading Machines, All Locomotives, Cable Ways or Tower Machines, Hoists, Hydraulic Backhoes, Ditching Machines or Backfiller, Cherrypickers, Overhead Cranes, Roller - Steam or Gas, Concrete Pavers, Excavators, Concrete Breakers, Concrete Pumps, Bulk Cement Plants, Cement Pumps, Derrick-Type Drills, Boat Operators, Motor Graders or Pushcats, Scoops or Tournapulls, Bulldozers, Endloaders or Fork Lifts, Power Blade or Elevating Graders, Winch Cats, Boom or Winch Trucks or Boom Tractors, Pipe Wrapping or Painting Machines, Asphalt Plant Engineer, Journeyman Lubricating Engineer, Drills (other than Derrick Type), Mud Jacks, or Well Drilling Machines, Boring Machines or Track Jacks, Mixers, Conveyors (Two), Air Compressors (Two), Water Pumps regardless of size (Two), Welding Machines (Two), Siphons or Jets (Two), Winch Heads or Apparatuses (Two), Light Plants (Two), All Tractors regardless of size (straight tractor only), Fireman on Stationary Boilers, Automatic Elevators, Form Grading Machines, Finishing Machines, Power Sub-Grader or Ribbon Machines, Longitudinal Floats, Distributor Operators on Trucks, Winch Heads or Apparatuses (One), Mobil Track air and heaters (two to five), Heavy Equipment Greaser, Relief Operator, Assistant Master Mechanic and Heavy Duty Mechanic, self-propelled concrete saws

of all types and sizes with their attachments, gob-hoppers, excavators all sizes, the repair and greasing of all diesel hammers, the operation and set-up of bidwells, water blasters of all sizes and their clutches, hydraulic jacks where used for hoisting, operation of log skidders, iceolators used on and off of pipeline, condor cranes, bow boats, survey boats, bobcats and all their attachments, skid steer loaders and all their attachments, creter cranes, batch plants, operator (all sizes), self propelled roto mills, operation of conveyor systems of any size and any configuration, operation, repair and service of all vibratory hammers, all power pacs and their controls regardless of location, curtains or brush burning machines, stump cutter machines, Nail launchers when mounted on a machine or self-propelled, operation of con-cover machines, and all Operators except those listed below).

GROUP II. Assistant Operators.

GROUP III. Air Compressors (One), Water Pumps, regardless of Size (One), Waterblasters (one), Welding Machine (One), Mixers (One Bag), Conveyor (One), Siphon or Jet (One), Light Plant (One), Heater (One), Immobile Track Air (One), and Self Propelled Walk-Behind Rollers.

GROUP IV. Asphalt Spreader Oilers, Fireman on Whirlies and Heavy Equipment Oilers, Truck Cranes, Dredges, Monigans, Large Cranes - (Over 65-ton rated capacity) Concrete Plant Oiler, Blacktop Plant Oiler, and Creter Crane Oiler (when required).

GROUP V. Oiler.

GROUP VI. Operators on equipment with Booms, including jibs, 100 feet and over, and less than 150 feet long.

GROUP VII. Operators on equipment with Booms, including jibs, 150 feet and over, and less than 200 feet long.

GROUP VIII. Operators on Equipment with Booms, including jibs, 200 feet and over; Tower Cranes; and Whirlie Cranes.

GROUP IX. Master Mechanic

OPERATING ENGINEERS - Highway

GROUP I. Cranes, Dragline, Shovels, Skimmer Scoops, Clamshells or Derrick Boats, Pile Drivers, Crane-Type Backhoes, Asphalt Plant Operators, Concrete Plant Operators, Dredges, Asphalt Spreading Machines, All Locomotives, Cable Ways or Tower Machines, Hoists, Hydraulic Backhoes, Ditching Machines or Backfiller, Cherrypickers, Overhead Cranes, Roller - Steam or Gas, Concrete Pavers, Excavators, Concrete Breakers, Concrete Pumps, Bulk Cement Plants, Cement Pumps, Derrick-Type Drills, Boat Operators, Motor Graders or Pushcats, Scoops or Tournapulls, Bulldozers, Endloaders or Fork Lifts, Power Blade or Elevating Graders, Winch Cats, Boom or Winch Trucks or Boom Tractors, Pipe Wrapping or Painting Machines, Asphalt Plant Engineer, Journeyman Lubricating Engineer, Drills (other than Derrick Type), Mud Jacks, Well Drilling Machines, Boring Machines, Track Jacks, Mixers, Conveyors (Two), Air Compressors (Two), Water Pumps regardless of size (Two), Welding Machines (Two), Siphons or Jets (Two), Winch Heads or Apparatuses (Two), Light Plants (Two), All Tractors regardless of size (straight tractor only), Fireman on Stationary Boilers, Automatic Elevators, Form Grading Machines, Finishing Machines, Power Sub-Grader or Ribbon Machines, Longitudinal Floats, Distributor Operators on Trucks, Winch Heads or Apparatuses (One), Mobil Track air and heaters (two to five), Heavy Equipment Greaser, Relief Operator, Assistant Master Mechanic and Heavy Duty Mechanic, self-propelled concrete saws of all types and sizes with their attachments, gob-hoppers, excavators

all sizes, the repair and greasing of all diesel hammers, the operation and set-up of bidwells, water blasters of all sizes and their clutches, hydraulic jacks where used for hoisting, operation of log skidders, iceolators used on and off of pipeline, condor cranes, bow boats, survey boats, bobcats and all their attachments, skid steer loaders and all their attachments, creter cranes, batch plants, operator (all sizes), self propelled roto mills, operation of conveyor systems of any size and any configuration, operation, repair and service of all vibratory hammers, all power pacs and their controls regardless of location, curtains or brush burning machines, stump cutter machines, Nail launchers when mounted on a machine or self-propelled, operation of con-cover machines, and all Operators (except those listed below).

GROUP II. Assistant Operators.

GROUP III. Air Compressors (One), Water Pumps, regardless of Size (One), Waterblasters (one), Welding Machine (One), Mixers (One Bag), Conveyor (One), Siphon or Jet (One), Light Plant (One), Heater (One), Immobile Track Air (One), and Self Propelled Walk-Behind Rollers.

GROUP IV. Asphalt Spreader Oilers, Fireman on Whirlies and Heavy Equipment Oilers, Truck Cranes, Dredges, Monigans, Large Cranes - (Over 65-ton rated capacity) Concrete Plant Oiler, Blacktop Plant Oiler, and Creter Crane Oiler (when required).

GROUP V. Oiler.

GROUP VI. Operators on equipment with Booms, including jibs, 100 feet and over, and less than 150 feet long.

GROUP VII. Operators on equipment with Booms, including jibs, 150 feet and over, and less than 200 feet long.

GROUP VIII. Operators on Equipment with Booms, including jibs, 200 feet and over; Tower Cranes; and Whirlie Cranes.

GROUP IX. Mechanic

TRUCK DRIVER - BUILDING, HEAVY AND HIGHWAY CONSTRUCTION

Class 1. Drivers on 2 axle trucks hauling less than 9 ton. Air compressor and welding machines and brooms, including those pulled by separate units, truck driver helpers, warehouse employees, mechanic helpers, greasers and tiremen, pickup trucks when hauling materials, tools, or workers to and from and on-the-job site, and fork lifts up to 6,000 lb. capacity.

Class 2. Two or three axle trucks hauling more than 9 ton but hauling less than 16 ton. A-frame winch trucks, hydrolift trucks, vactor trucks or similar equipment when used for transportation purposes. Fork lifts over 6,000 lb. capacity, winch trucks, four axle combination units, and ticket writers.

Class 3. Two, three or four axle trucks hauling 16 ton or more. Drivers on water pulls, articulated dump trucks, mechanics and working forepersons, and dispatchers. Five axle or more combination units.

Class 4. Low Boy and Oil Distributors.

Class 5. Drivers who require special protective clothing while employed on hazardous waste work.

TRUCK DRIVER - OIL AND CHIP RESEALING ONLY.

This shall encompass laborers, workers and mechanics who drive contractor or subcontractor owned, leased, or hired pickup, dump, service, or oil distributor trucks. The work includes transporting materials and equipment (including but not limited to, oils, aggregate supplies, parts, machinery and tools) to or from the job site; distributing oil or liquid asphalt and aggregate; stock piling material when in connection with the actual oil and chip contract. The Truck Driver (Oil & Chip Resealing) wage classification does not include supplier delivered materials.

TERRAZZO FINISHER

The handling of all materials used for Mosaic and Terrazzo work including preparing, mixing by hand, by mixing machine or transporting of pre-mixed materials and distributing with shovel, rake, hoe, or pail, all kinds of concrete foundations necessary for Mosaic and Terrazzo work, all cement terrazzo, magnesite terrazzo, Do-O-Tex terrazzo, epoxy matrix ter-razzo, exposed aggregate, rustic or rough washed for exterior or interior of buildings placed either by machine or by hand, and any other kind of mixture of plastics composed of chips or granules when mixed with cement, rubber, neoprene, vinyl, magnesium chloride or any other resinous or chemical substances used for seamless flooring systems, and all other building materials, all similar materials and all precast terrazzo work on jobs, all scratch coat used for Mosaic and Terrazzo work and sub-bed, tar paper and wire mesh (2x2 etc.) or lath. The rubbing, grinding, cleaning and finishing of same either by hand or by machine or by terrazzo resurfacing equipment on new or existing floors. When necessary finishers shall be allowed to assist the mechanics to spread sand bed, lay tarpaper and wire mesh (2x2 etc.) or lath. The finishing of cement floors where additional aggregate of stone is added by spreading or sprinkling on top of the finished base, and troweled or rolled into the finish and then the surface is ground by grinding machines.

Other Classifications of Work:

For definitions of classifications not otherwise set out, the Department generally has on file such definitions which are available. If a task to be performed is not subject to one of the classifications of pay set out, the Department will upon being contacted state which neighboring county has such a classification and provide such rate, such rate being deemed to exist by reference in this document. If no neighboring county rate applies to the task, the Department shall undertake a special determination, such special determination being then deemed to have existed under this determination. If a project requires these, or any classification not listed, please contact IDOL at 217-782-1710 for wage rates or clarifications.

LANDSCAPING

Landscaping work falls under the existing classifications for laborer, operating engineer and truck driver. The work performed by landscape plantsman and landscape laborer is covered by the existing classification of laborer. The work performed by landscape operators (regardless of equipment used or its size) is covered by the classifications of operating engineer. The work performed by landscape truck drivers (regardless of size of truck driven) is covered by the classifications of truck driver.

Marion County Prevailing Wage for May 2013

(See explanation of column headings at bottom of wages)

Trade Name	RG	TYP	C	Base	FRMAN	M-F>8	OSA	OSH	H/W	Pensn	Vac	Trng
=====	==	===	=	=====	=====	=====	===	===	=====	=====	=====	=====
ASBESTOS ABT-GEN		ALL		25.300	25.750	1.5	1.5	2.0	5.750	10.35	0.000	0.900
ASBESTOS ABT-MEC		BLD		29.860	30.860	1.5	1.5	2.0	6.950	3.000	0.000	0.000
BOILERMAKER		BLD		31.500	34.000	1.5	1.5	2.0	7.070	18.73	1.000	0.350
BRICK MASON		BLD		29.280	33.160	1.5	1.5	2.0	7.750	9.430	2.000	0.400
CARPENTER		BLD		31.890	33.390	1.5	1.5	2.0	6.550	6.750	0.000	0.400
CARPENTER		HWY		31.890	33.640	1.5	1.5	2.0	6.550	6.750	0.000	0.400
CEMENT MASON		BLD		28.200	29.700	1.5	1.5	2.0	6.600	5.400	0.000	0.500
CEMENT MASON		HWY		27.080	28.580	1.5	1.5	2.0	6.600	5.800	0.000	0.300
CERAMIC TILE FNSHER		BLD		25.890	0.000	1.5	1.5	2.0	6.000	5.200	0.000	0.530
ELECTRIC PWR EQMT OP		ALL	1	35.570	0.000	1.5	1.5	2.0	5.000	9.960	0.000	0.360
ELECTRIC PWR EQMT OP		ALL	2	31.740	0.000	1.5	1.5	2.0	5.000	8.880	0.000	0.320
ELECTRIC PWR GRNDMAN		ALL		26.100	0.000	1.5	1.5	2.0	5.000	7.310	0.000	0.260
ELECTRIC PWR LINEMAN		ALL		44.630	47.650	1.5	1.5	2.0	5.000	12.50	0.000	0.450
ELECTRICIAN		ALL		39.350	41.600	1.5	1.5	2.0	6.140	9.440	0.000	0.790
ELECTRONIC SYS TECH		BLD		32.570	34.320	1.5	1.5	2.0	6.000	4.240	0.000	0.400
FLOOR LAYER		BLD		29.330	30.080	1.5	1.5	2.0	6.550	6.750	0.000	0.400
GLAZIER		BLD		32.780	0.000	2.0	2.0	2.0	9.020	10.80	2.630	0.310
HT/FROST INSULATOR		BLD		37.260	38.260	1.5	1.5	2.0	7.850	11.16	0.000	0.500
IRON WORKER		ALL		31.500	33.500	1.5	1.5	2.0	7.610	13.33	0.000	0.420
LABORER		BLD		25.300	25.750	1.5	1.5	2.0	5.750	10.35	0.000	0.800
LABORER		HWY		25.300	25.750	1.5	1.5	2.0	5.750	10.35	0.000	0.800
MACHINIST		BLD		43.550	46.050	1.5	1.5	2.0	6.130	8.950	1.850	0.000
MARBLE FINISHERS		BLD		25.890	0.000	1.5	1.5	2.0	6.000	5.200	0.000	0.530
MARBLE MASON		BLD		29.280	33.160	1.5	1.5	2.0	7.750	9.430	2.000	0.400
MILLWRIGHT		BLD		31.890	33.390	1.5	1.5	2.0	6.550	6.750	0.000	0.400
MILLWRIGHT		HWY		32.390	34.140	1.5	1.5	2.0	6.550	6.750	0.000	0.400
OPERATING ENGINEER		BLD	1	34.200	37.200	1.5	1.5	2.0	9.000	17.00	0.000	1.000
OPERATING ENGINEER		BLD	2	33.070	37.200	1.5	1.5	2.0	9.000	17.00	0.000	1.000
OPERATING ENGINEER		BLD	3	28.590	37.200	1.5	1.5	2.0	9.000	17.00	0.000	1.000
OPERATING ENGINEER		BLD	4	28.650	37.200	1.5	1.5	2.0	9.000	17.00	0.000	1.000
OPERATING ENGINEER		BLD	5	28.320	37.200	1.5	1.5	2.0	9.000	17.00	0.000	1.000
OPERATING ENGINEER		BLD	6	35.750	37.200	1.5	1.5	2.0	9.000	17.00	0.000	1.000
OPERATING ENGINEER		BLD	7	36.050	37.200	1.5	1.5	2.0	9.000	17.00	0.000	1.000
OPERATING ENGINEER		BLD	8	36.330	37.200	1.5	1.5	2.0	9.000	17.00	0.000	1.000
OPERATING ENGINEER		BLD	9	35.650	37.200	1.5	1.5	2.0	9.000	17.00	0.000	1.000
OPERATING ENGINEER		HWY	1	32.700	35.700	1.5	1.5	2.0	9.000	17.00	0.000	1.000
OPERATING ENGINEER		HWY	2	31.570	35.700	1.5	1.5	2.0	9.000	17.00	0.000	1.000
OPERATING ENGINEER		HWY	3	27.090	35.700	1.5	1.5	2.0	9.000	17.00	0.000	1.000
OPERATING ENGINEER		HWY	4	27.150	35.700	1.5	1.5	2.0	9.000	17.00	0.000	1.000
OPERATING ENGINEER		HWY	5	26.820	35.700	1.5	1.5	2.0	9.000	17.00	0.000	1.000
OPERATING ENGINEER		HWY	6	34.250	35.700	1.5	1.5	2.0	9.000	17.00	0.000	1.000
OPERATING ENGINEER		HWY	7	34.550	35.700	1.5	1.5	2.0	9.000	17.00	0.000	1.000
OPERATING ENGINEER		HWY	8	34.830	35.700	1.5	1.5	2.0	9.000	17.00	0.000	1.000
OPERATING ENGINEER		HWY	9	34.150	35.700	1.5	1.5	2.0	9.000	17.00	0.000	1.000
PAINTER		ALL		23.190	23.690	1.5	1.5	2.0	5.000	6.840	0.000	0.480
PAINTER OVER 30FT		ALL		26.290	26.790	1.5	1.5	2.0	5.000	6.840	0.000	0.480
PAINTER PWR EQMT		ALL		26.290	26.790	1.5	1.5	2.0	5.000	6.840	0.000	0.480
PILEDRIVER		BLD		31.890	33.390	1.5	1.5	2.0	6.550	6.750	0.000	0.400
PILEDRIVER		HWY		32.390	34.140	1.5	1.5	2.0	6.550	6.750	0.000	0.400
PIPEFITTER		BLD		34.450	37.900	1.5	1.5	2.0	6.050	6.550	0.000	0.800
PLASTERER		BLD		28.200	29.700	1.5	1.5	2.0	6.600	5.400	0.000	0.500
PLUMBER		BLD		34.450	37.900	1.5	1.5	2.0	6.050	6.550	0.000	0.800
ROOFER		BLD		23.900	24.900	1.5	1.5	2.0	8.650	3.800	0.000	0.000
SHEETMETAL WORKER		ALL		31.690	33.190	1.5	1.5	2.0	7.130	6.730	1.910	0.360
SPRINKLER FITTER		BLD		36.390	39.140	1.5	1.5	2.0	8.420	8.500	0.000	0.450
TERRAZZO FINISHER		BLD		31.240	0.000	1.5	1.5	2.0	6.000	3.230	0.000	0.200
TERRAZZO MASON		BLD		32.530	32.830	1.5	1.5	2.0	6.000	5.230	0.000	0.210
TRUCK DRIVER		ALL	1	31.340	0.000	1.5	1.5	2.0	10.30	5.010	0.000	0.250
TRUCK DRIVER		ALL	2	31.780	0.000	1.5	1.5	2.0	10.30	5.010	0.000	0.250

TRUCK DRIVER	ALL	3	32.020	0.000	1.5	1.5	2.0	10.30	5.010	0.000	0.250
TRUCK DRIVER	ALL	4	32.280	0.000	1.5	1.5	2.0	10.30	5.010	0.000	0.250
TRUCK DRIVER	ALL	5	33.130	0.000	1.5	1.5	2.0	10.30	5.010	0.000	0.250
TRUCK DRIVER	O&C	1	25.070	0.000	1.5	1.5	2.0	10.30	5.010	0.000	0.250
TRUCK DRIVER	O&C	2	25.420	0.000	1.5	1.5	2.0	10.30	5.010	0.000	0.250
TRUCK DRIVER	O&C	3	25.620	0.000	1.5	1.5	2.0	10.30	5.010	0.000	0.250
TRUCK DRIVER	O&C	4	25.820	0.000	1.5	1.5	2.0	10.30	5.010	0.000	0.250
TRUCK DRIVER	O&C	5	26.500	0.000	1.5	1.5	2.0	10.30	5.010	0.000	0.250

Legend:

RG (Region)

TYP (Trade Type - All,Highway,Building,Floating,Oil & Chip,Rivers)

C (Class)

Base (Base Wage Rate)

FRMAN (Foreman Rate)

M-F>8 (OT required for any hour greater than 8 worked each day, Mon through Fri.)

OSA (Overtime (OT) is required for every hour worked on Saturday)

OSH (Overtime is required for every hour worked on Sunday and Holidays)

H/W (Health & Welfare Insurance)

Pensn (Pension)

Vac (Vacation)

Trng (Training)

Explanations

MARION COUNTY

The following list is considered as those days for which holiday rates of wages for work performed apply: New Years Day, Memorial Day, Fourth of July, Labor Day, Thanksgiving Day, Christmas Day and Veterans Day in some classifications/counties. Generally, any of these holidays which fall on a Sunday is celebrated on the following Monday. This then makes work performed on that Monday payable at the appropriate overtime rate for holiday pay. Common practice in a given local may alter certain days of celebration. If in doubt, please check with IDOL.

Oil and chip resealing (O&C) means the application of road oils and liquid asphalt to coat an existing road surface, followed by application of aggregate chips or gravel to coated surface, and subsequent rolling of material to seal the surface.

EXPLANATION OF CLASSES

ASBESTOS - GENERAL - removal of asbestos material/mold and hazardous materials from any place in a building, including mechanical systems where those mechanical systems are to be removed. This includes the removal of asbestos materials/mold and hazardous materials from ductwork or pipes in a building when the building is to be demolished

at the time or at some close future date.

ASBESTOS - MECHANICAL - removal of asbestos material from mechanical systems, such as pipes, ducts, and boilers, where the mechanical systems are to remain.

CERAMIC TILE FINISHER AND MARBLE FINISHER

The handling, at the building site, of all sand, cement, tile, marble or stone and all other materials that may be used and installed by [a] tile layer or marble mason. In addition, the grouting, cleaning, sealing, and mixing on the job site, and all other work as required in assisting the setter. The term "Ceramic" is used for naming the classification only and is in no way a limitation of the product handled. Ceramic takes into consideration most hard tiles.

ELECTRIC POWER LINEMAN

Construction, maintenance and dismantling of overhead and underground electric power lines, including high voltage pipe type cable work, and associated structures and equipment.

ELECTRIC POWER EQUIPMENT OPERATOR - CLASS 1

Operation of all crawler type equipment D-4 and larger from the ground to assist the Electric Power Linemen in performing their duties.

ELECTRIC POWER EQUIPMENT OPERATORS - CLASS 2

Operation of all other equipment from the ground to assist the Electric Power Linemen in performing their duties.

ELECTRIC POWER GROUNDMAN

Applies to workers who assist the Electric Power Lineman from the ground.

ELECTRONIC SYSTEMS TECHNICIAN

Installation, service and maintenance of low-voltage systems which utilizes the transmission and/or transference of voice, sound, vision, or digital for commercial, education, security and entertainment purposes for the following: TV monitoring and surveillance, background/foreground music, intercom and telephone interconnect, field programming, inventory control systems, microwave transmission, multi-media, multiplex, radio page, school, intercom and sound burglar alarms and low voltage master clock systems.

Excluded from this classification are energy management systems, life safety systems, supervisory controls and data acquisition systems not intrinsic with the above listed systems, fire alarm systems, nurse call systems and raceways exceeding fifteen feet in length.

OPERATING ENGINEER - BUILDING

GROUP I. Cranes, Dragline, Shovels, Skimmer Scoops, Clamshells or Derrick Boats, Pile Drivers, Crane-Type Backhoes, Asphalt Plant Operators, Concrete Plant Operators, Dredges, Asphalt Spreading Machines, All Locomotives, Cable Ways or Tower Machines, Hoists, Hydraulic Backhoes, Ditching Machines or Backfiller, Cherrypickers, Overhead Cranes, Roller - Steam or Gas, Concrete Pavers, Excavators, Concrete Breakers, Concrete Pumps, Bulk Cement Plants, Cement Pumps, Derrick-Type Drills, Boat Operators, Motor Graders or Pushcats, Scoops or Tournapulls, Bulldozers, Endloaders or Fork Lifts, Power Blade or Elevating Graders, Winch Cats, Boom or Winch Trucks or Boom Tractors,

Pipe Wrapping or Painting Machines, Asphalt Plant Engineer, Journeyman Lubricating Engineer, Drills (other than Derrick Type), Mud Jacks, or Well Drilling Machines, Boring Machines or Track Jacks, Mixers, Conveyors (Two), Air Compressors (Two), Water Pumps regardless of size (Two), Welding Machines (Two), Siphons or Jets (Two), Winch Heads or Apparatuses (Two), Light Plants (Two), All Tractors regardless of size (straight tractor only), Fireman on Stationary Boilers, Automatic Elevators, Form Grading Machines, Finishing Machines, Power Sub-Grader or Ribbon Machines, Longitudinal Floats, Distributor Operators on Trucks, Winch Heads or Apparatuses (One), Mobil Track air and heaters (two to five), Heavy Equipment Greaser, Relief Operator, Assistant Master Mechanic and Heavy Duty Mechanic, self-propelled concrete saws of all types and sizes with their attachments, gob-hoppers, excavators all sizes, the repair and greasing of all diesel hammers, the operation and set-up of bidwells, water blasters of all sizes and their clutches, hydraulic jacks where used for hoisting, operation of log skidders, iceolators used on and off of pipeline, condor cranes, bow boats, survey boats, bobcats and all their attachments, skid steer loaders and all their attachments, creter cranes, batch plants, operator (all sizes), self propelled roto mills, operation of conveyor systems of any size and any configuration, operation, repair and service of all vibratory hammers, all power pacs and their controls regardless of location, curtains or brush burning machines, stump cutter machines, Nail launchers when mounted on a machine or self-propelled, operation of con-cover machines, and all Operators except those listed below).

GROUP II. Assistant Operators.

GROUP III. Air Compressors (One), Water Pumps, regardless of Size (One), Waterblasters (one), Welding Machine (One), Mixers (One Bag), Conveyor (One), Siphon or Jet (One), Light Plant (One), Heater (One), Immobile Track Air (One), and Self Propelled Walk-Behind Rollers.

GROUP IV. Asphalt Spreader Oilers, Fireman on Whirlies and Heavy Equipment Oilers, Truck Cranes, Dredges, Monigans, Large Cranes - (Over 65-ton rated capacity) Concrete Plant Oiler, Blacktop Plant Oiler, and Creter Crane Oiler (when required).

GROUP V. Oiler.

GROUP VI. Operators on equipment with Booms, including jibs, 100 feet and over, and less than 150 feet long.

GROUP VII. Operators on equipment with Booms, including jibs, 150 feet and over, and less than 200 feet long.

GROUP VIII. Operators on Equipment with Booms, including jibs, 200 feet and over; Tower Cranes; and Whirlie Cranes.

GROUP IX. Master Mechanic

OPERATING ENGINEERS - Highway

GROUP I. Cranes, Dragline, Shovels, Skimmer Scoops, Clamshells or Derrick Boats, Pile Drivers, Crane-Type Backhoes, Asphalt Plant Operators, Concrete Plant Operators, Dredges, Asphalt Spreading Machines, All Locomotives, Cable Ways or Tower Machines, Hoists, Hydraulic Backhoes, Ditching Machines or Backfiller, Cherrypickers, Overhead Cranes, Roller - Steam or Gas, Concrete Pavers, Excavators, Concrete Breakers, Concrete Pumps, Bulk Cement Plants, Cement Pumps, Derrick-Type Drills, Boat Operators, Motor Graders or Pushcats, Scoops or Tournapulls, Bulldozers, Endloaders or Fork Lifts, Power Blade or Elevating Graders, Winch Cats, Boom or Winch Trucks or Boom Tractors, Pipe Wrapping or Painting Machines, Asphalt Plant Engineer, Journeyman

Lubricating Engineer, Drills (other than Derrick Type), Mud Jacks, Well Drilling Machines, Boring Machines, Track Jacks, Mixers, Conveyors (Two), Air Compressors (Two), Water Pumps regardless of size (Two), Welding Machines (Two), Siphons or Jets (Two), Winch Heads or Apparatuses (Two), Light Plants (Two), All Tractors regardless of size (straight tractor only), Fireman on Stationary Boilers, Automatic Elevators, Form Grading Machines, Finishing Machines, Power Sub-Grader or Ribbon Machines, Longitudinal Floats, Distributor Operators on Trucks, Winch Heads or Apparatuses (One), Mobil Track air and heaters (two to five), Heavy Equipment Greaser, Relief Operator, Assistant Master Mechanic and Heavy Duty Mechanic, self-propelled concrete saws of all types and sizes with their attachments, gob-hoppers, excavators all sizes, the repair and greasing of all diesel hammers, the operation and set-up of bidwells, water blasters of all sizes and their clutches, hydraulic jacks where used for hoisting, operation of log skidders, iceolators used on and off of pipeline, condor cranes, bow boats, survey boats, bobcats and all their attachments, skid steer loaders and all their attachments, creter cranes, batch plants, operator (all sizes), self propelled roto mills, operation of conveyor systems of any size and any configuration, operation, repair and service of all vibratory hammers, all power pacs and their controls regardless of location, curtains or brush burning machines, stump cutter machines, Nail launchers when mounted on a machine or self-propelled, operation of con-cover machines, and all Operators (except those listed below).

GROUP II. Assistant Operators.

GROUP III. Air Compressors (One), Water Pumps, regardless of Size (One), Waterblasters (one), Welding Machine (One), Mixers (One Bag), Conveyor (One), Siphon or Jet (One), Light Plant (One), Heater (One), Immobile Track Air (One), and Self Propelled Walk-Behind Rollers.

GROUP IV. Asphalt Spreader Oilers, Fireman on Whirlies and Heavy Equipment Oilers, Truck Cranes, Dredges, Monigans, Large Cranes - (Over 65-ton rated capacity) Concrete Plant Oiler, Blacktop Plant Oiler, and Creter Crane Oiler (when required).

GROUP V. Oiler.

GROUP VI. Operators on equipment with Booms, including jibs, 100 feet and over, and less than 150 feet long.

GROUP VII. Operators on equipment with Booms, including jibs, 150 feet and over, and less than 200 feet long.

GROUP VIII. Operators on Equipment with Booms, including jibs, 200 feet and over; Tower Cranes; and Whirlie Cranes.

GROUP IX. Mechanic

TRUCK DRIVER - BUILDING, HEAVY AND HIGHWAY CONSTRUCTION

Class 1. Drivers on 2 axle trucks hauling less than 9 ton. Air compressor and welding machines and brooms, including those pulled by separate units, truck driver helpers, warehouse employees, mechanic helpers, greasers and tiremen, pickup trucks when hauling materials, tools, or workers to and from and on-the-job site, and fork lifts up to 6,000 lb. capacity.

Class 2. Two or three axle trucks hauling more than 9 ton but hauling less than 16 ton. A-frame winch trucks, hydrolift trucks, vactor trucks or similar equipment when used for transportation purposes. Fork lifts over 6,000 lb. capacity, winch trucks, four axle

combination units, and ticket writers.

Class 3. Two, three or four axle trucks hauling 16 ton or more. Drivers on water pulls, articulated dump trucks, mechanics and working forepersons, and dispatchers. Five axle or more combination units.

Class 4. Low Boy and Oil Distributors.

Class 5. Drivers who require special protective clothing while employed on hazardous waste work.

TRUCK DRIVER - OIL AND CHIP RESEALING ONLY.

This shall encompass laborers, workers and mechanics who drive contractor or subcontractor owned, leased, or hired pickup, dump, service, or oil distributor trucks. The work includes transporting materials and equipment (including but not limited to, oils, aggregate supplies, parts, machinery and tools) to or from the job site; distributing oil or liquid asphalt and aggregate; stock piling material when in connection with the actual oil and chip contract. The Truck Driver (Oil & Chip Resealing) wage classification does not include supplier delivered materials.

TERRAZZO FINISHER

The handling of all materials used for Mosaic and Terrazzo work including preparing, mixing by hand, by mixing machine or transporting of pre-mixed materials and distributing with shovel, rake, hoe, or pail, all kinds of concrete foundations necessary for Mosaic and Terrazzo work, all cement terrazzo, magnesite terrazzo, Do-O-Tex terrazzo, epoxy matrix ter-razzo, exposed aggregate, rustic or rough washed for exterior or interior of buildings placed either by machine or by hand, and any other kind of mixture of plastics composed of chips or granules when mixed with cement, rubber, neoprene, vinyl, magnesium chloride or any other resinous or chemical substances used for seamless flooring systems, and all other building materials, all similar materials and all precast terrazzo work on jobs, all scratch coat used for Mosaic and Terrazzo work and sub-bed, tar paper and wire mesh (2x2 etc.) or lath. The rubbing, grinding, cleaning and finishing of same either by hand or by machine or by terrazzo resurfacing equipment on new or existing floors. When necessary finishers shall be allowed to assist the mechanics to spread sand bed, lay tarpaper and wire mesh (2x2 etc.) or lath. The finishing of cement floors where additional aggregate of stone is added by spreading or sprinkling on top of the finished base, and troweled or rolled into the finish and then the surface is ground by grinding machines.

Other Classifications of Work:

For definitions of classifications not otherwise set out, the Department generally has on file such definitions which are available. If a task to be performed is not subject to one of the classifications of pay set out, the Department will upon being contacted state which neighboring county has such a classification and provide such rate, such rate being deemed to exist by reference in this document. If no neighboring county rate applies to the task, the Department shall undertake a special determination, such special determination being then deemed to have existed under this determination. If a project requires these, or any classification not listed, please contact IDOL at 217-782-1710 for wage rates or clarifications.

LANDSCAPING

Landscaping work falls under the existing classifications for laborer, operating engineer and truck driver. The work performed by landscape plantsman and landscape laborer is covered by the existing classification of laborer. The work performed by landscape operators (regardless of equipment used or its size) is covered by the classifications of operating engineer. The work performed by landscape truck drivers (regardless of size of truck driven) is covered by the classifications of truck driver.

Marshall County Prevailing Wage for May 2013

(See explanation of column headings at bottom of wages)

Trade Name	RG	TYP	C	Base	FRMAN	M-F>8	OSA	OSH	H/W	Pensn	Vac	Trng
=====	==	===	=	=====	=====	=====	===	===	=====	=====	=====	=====
ASBESTOS ABT-GEN		BLD		30.030	31.030	1.5	1.5	2.0	7.700	8.230	0.000	0.800
ASBESTOS ABT-GEN		HWY		31.590	32.140	1.5	1.5	2.0	7.700	8.230	0.000	0.800
ASBESTOS ABT-MEC		BLD		31.840	34.340	1.5	1.5	2.0	10.82	10.66	0.000	0.720
BOILERMAKER		BLD		35.010	38.010	2.0	2.0	2.0	7.070	13.83	0.000	0.300
BRICK MASON		BLD		32.060	33.560	1.5	1.5	2.0	7.700	9.130	0.000	0.560
CARPENTER		BLD		30.250	32.370	1.5	1.5	2.0	8.900	13.68	0.000	0.570
CARPENTER		HWY		30.250	32.000	1.5	1.5	2.0	8.830	13.34	0.000	0.500
CEMENT MASON	E	ALL		35.000	36.000	1.5	1.5	2.0	7.700	11.67	0.000	0.500
CEMENT MASON	W	BLD		27.090	28.840	1.5	1.5	2.0	8.140	13.55	0.000	0.500
CEMENT MASON	W	HWY		28.280	29.780	1.5	1.5	2.0	8.140	13.93	0.000	0.500
CERAMIC TILE FNSHER		BLD		29.750	0.000	1.5	1.5	2.0	7.700	9.130	0.000	0.550
ELECTRIC PWR EQMT OP		ALL		35.440	0.000	1.5	1.5	2.0	5.000	10.98	0.000	0.270
ELECTRIC PWR GRNDMAN		ALL		24.320	0.000	1.5	1.5	2.0	5.000	7.540	0.000	0.180
ELECTRIC PWR LINEMAN		ALL		39.370	41.910	1.5	1.5	2.0	5.000	12.20	0.000	0.300
ELECTRIC PWR TRK DRV		ALL		25.510	0.000	1.5	1.5	2.0	5.000	7.920	0.000	0.190
ELECTRICIAN	E	BLD		37.090	39.090	1.5	1.5	2.0	5.350	7.760	0.000	0.560
ELECTRICIAN	W	BLD		34.820	37.320	1.5	1.5	2.0	5.350	10.08	0.000	0.400
ELECTRONIC SYS TECH		BLD		27.430	29.180	1.5	1.5	2.0	5.350	9.320	0.000	0.400
ELEVATOR CONSTRUCTOR		BLD		40.520	45.585	2.0	2.0	2.0	11.88	12.71	3.240	0.600
GLAZIER		BLD		30.770	32.770	1.5	1.5	2.0	9.700	7.700	0.000	1.250
HT/FROST INSULATOR		BLD		42.450	44.950	1.5	1.5	2.0	10.82	11.86	0.000	0.720
IRON WORKER	NE	ALL		38.500	39.500	2.0	2.0	2.0	9.390	18.84	0.000	0.700
IRON WORKER	SW	BLD		30.330	32.230	1.5	1.5	2.0	9.390	11.56	0.000	0.440
IRON WORKER	SW	HWY		34.020	36.020	1.5	1.5	2.0	9.390	11.56	0.000	0.390
LABORER		BLD		29.030	30.030	1.5	1.5	2.0	7.700	8.230	0.000	0.800
LABORER		HWY		30.590	31.140	1.5	1.5	2.0	7.700	8.230	0.000	0.800
LABORER, SKILLED		BLD		29.030	30.030	1.5	1.5	2.0	7.700	8.230	0.000	0.800
LABORER, SKILLED		HWY		30.590	31.140	1.5	1.5	2.0	7.700	8.230	0.000	0.800
LATHER		BLD		30.250	32.370	1.5	1.5	2.0	8.900	13.68	0.000	0.570
MACHINERY MOVER	SW	HWY		34.020	36.020	1.5	1.5	2.0	9.390	11.56	0.000	0.390
MACHINIST		BLD		43.550	46.050	1.5	1.5	2.0	6.130	8.950	1.850	0.000
MARBLE FINISHERS		BLD		29.750	0.000	1.5	1.5	2.0	7.700	9.130	0.000	0.550
MARBLE MASON		BLD		31.510	32.760	1.5	1.5	2.0	7.700	9.130	0.000	0.550
MILLWRIGHT		BLD		34.400	37.840	1.5	1.5	2.0	8.770	13.85	0.000	0.500
MILLWRIGHT		HWY		34.120	37.530	1.5	1.5	2.0	8.770	13.85	0.000	0.500
OPERATING ENGINEER		BLD	1	36.000	39.000	1.5	1.5	2.0	9.750	13.60	0.000	3.000
OPERATING ENGINEER		BLD	2	33.490	39.000	1.5	1.5	2.0	9.750	13.60	0.000	3.000
OPERATING ENGINEER		BLD	3	29.340	39.000	1.5	1.5	2.0	9.750	13.60	0.000	3.000
OPERATING ENGINEER		HWY	1	36.000	39.500	1.5	1.5	2.0	9.750	13.60	0.000	3.000
OPERATING ENGINEER		HWY	2	33.490	39.500	1.5	1.5	2.0	9.750	13.60	0.000	3.000
OPERATING ENGINEER		HWY	3	29.340	39.500	1.5	1.5	2.0	9.750	13.60	0.000	3.000
PAINTER		ALL		32.900	34.900	1.5	1.5	1.5	9.650	8.200	0.000	1.250
PAINTER SIGNS		BLD		33.920	38.090	1.5	1.5	1.5	2.600	2.710	0.000	0.000
PILEDRIVER		BLD		30.500	33.550	1.5	1.5	2.0	8.900	13.68	0.000	0.570
PILEDRIVER		HWY		30.250	32.000	1.5	1.5	2.0	8.830	13.34	0.000	0.500
PIPEFITTER	N	BLD		45.050	48.050	1.5	1.5	2.0	8.460	14.85	0.000	1.780
PIPEFITTER	S	BLD		37.400	41.510	1.5	1.5	2.0	7.000	11.63	0.000	1.060

PLASTERER		BLD	27.770	28.770	1.5	1.5	2.0	8.140	12.76	0.000	0.600
PLUMBER	N	BLD	45.000	47.000	1.5	1.5	2.0	12.53	10.06	0.000	0.880
PLUMBER	S	BLD	33.570	36.590	1.5	1.5	2.0	7.000	13.31	0.000	0.900
ROOFER		BLD	28.580	30.010	1.5	1.5	2.0	8.450	7.220	0.000	0.250
SHEETMETAL WORKER		BLD	35.360	37.010	1.5	1.5	2.0	8.020	12.70	0.000	0.650
SIGN HANGER	SW	HWY	34.020	36.020	1.5	1.5	2.0	9.390	11.56	0.000	0.390
SPRINKLER FITTER		BLD	36.390	39.140	1.5	1.5	2.0	8.420	8.500	0.000	0.450
STEEL ERECTOR	SW	HWY	34.020	36.020	1.5	1.5	2.0	9.390	11.56	0.000	0.390
STONE MASON		BLD	32.060	33.560	1.5	1.5	2.0	7.700	9.130	0.000	0.560
TERRAZZO FINISHER		BLD	29.750	0.000	1.5	1.5	2.0	7.700	9.130	0.000	0.550
TERRAZZO MASON		BLD	31.510	32.760	1.5	1.5	2.0	7.700	9.130	0.000	0.550
TILE LAYER		BLD	30.250	32.370	1.5	1.5	2.0	8.900	13.68	0.000	0.570
TILE MASON		BLD	31.510	32.760	1.5	1.5	2.0	7.700	9.130	0.000	0.550
TRUCK DRIVER		ALL 1	31.230	0.000	1.5	1.5	2.0	10.30	4.840	0.000	0.250
TRUCK DRIVER		ALL 2	31.680	0.000	1.5	1.5	2.0	10.30	4.840	0.000	0.250
TRUCK DRIVER		ALL 3	31.890	0.000	1.5	1.5	2.0	10.30	4.840	0.000	0.250
TRUCK DRIVER		ALL 4	32.180	0.000	1.5	1.5	2.0	10.30	4.840	0.000	0.250
TRUCK DRIVER		ALL 5	33.020	0.000	1.5	1.5	2.0	10.30	4.840	0.000	0.250
TRUCK DRIVER		O&C 1	24.980	0.000	1.5	1.5	2.0	10.30	4.840	0.000	0.250
TRUCK DRIVER		O&C 2	25.340	0.000	1.5	1.5	2.0	10.30	4.840	0.000	0.250
TRUCK DRIVER		O&C 3	25.510	0.000	1.5	1.5	2.0	10.30	4.840	0.000	0.250
TRUCK DRIVER		O&C 4	25.740	0.000	1.5	1.5	2.0	10.30	4.840	0.000	0.250
TRUCK DRIVER		O&C 5	26.420	0.000	1.5	1.5	2.0	10.30	4.840	0.000	0.250
TUCKPOINTER		BLD	32.060	33.560	1.5	1.5	2.0	7.700	9.130	0.000	0.560

Legend :

RG (Region)

TYP (Trade Type - All,Highway,Building,Floating,Oil & Chip,Rivers)

C (Class)

Base (Base Wage Rate)

FRMAN (Foreman Rate)

M-F>8 (OT required for any hour greater than 8 worked each day, Mon through Fri.)

OSA (Overtime (OT) is required for every hour worked on Saturday)

OSH (Overtime is required for every hour worked on Sunday and Holidays)

H/W (Health & Welfare Insurance)

Pensn (Pension)

Vac (Vacation)

Trng (Training)

Explanations

MARSHALL COUNTY

CEMENT MASON (EAST) - The part east of a line which runs south from the point where Marshall, Putnam and LaSalle Counties meet to Route 166 just south and west of Benson, Illinois (in Woodford County).

ELECTRICIANS (EAST) - Townships of Roberts, Evans, Bill Plain, and Bennington.

IRONWORKERS (SOUTHWEST) - That part of the county Southwest of a diagonal line through Toluca, Varba and Bradford (Stark County).

PLUMBERS & PIPEFITTERS (NORTH) - That part of the county North of Route 17.

The following list is considered as those days for which holiday rates of wages for work performed apply: New Years Day, Memorial Day, Fourth of July, Labor Day, Thanksgiving Day, Christmas Day and Veterans Day in some classifications/counties. Generally, any of these holidays which fall on a Sunday is celebrated on the following Monday. This then makes work performed on that Monday payable at the appropriate overtime rate for holiday pay. Common practice in a given local may alter certain days of celebration. If in doubt, please check with IDOL.

Oil and chip resealing (O&C) means the application of road oils and liquid asphalt to coat an existing road surface, followed by application of aggregate chips or gravel to coated surface, and subsequent rolling of material to seal the surface.

EXPLANATION OF CLASSES

ASBESTOS - GENERAL - removal of asbestos material/mold and hazardous materials from any place in a building, including mechanical systems where those mechanical systems are to be removed. This includes the removal of asbestos materials/mold and hazardous materials from ductwork or pipes in a building when the building is to be demolished at the time or at some close future date.

ASBESTOS - MECHANICAL - removal of asbestos material from mechanical systems, such as pipes, ducts, and boilers, where the mechanical systems are to remain.

CERAMIC TILE FINISHER, MARBLE FINISHER, TERRAZZO FINISHER

Assisting, helping or supporting the tile, marble and terrazzo mechanic by performing their historic and traditional work assignments required to complete the proper installation of the work covered by said crafts. The term "Ceramic" is used for naming the classification only and is in no way a limitation of the product handled. Ceramic takes into consideration most hard tiles.

ELECTRONIC SYSTEMS TECHNICIAN

Installation, service and maintenance of low-voltage systems which utilizes the transmission and/or transference of voice, sound, vision, or digital for commercial, education, security and entertainment purposes for the following: TV monitoring and surveillance, background/foreground music, intercom and telephone interconnect, field programming, inventory control systems, microwave transmission, multi-media, multiplex, radio page, school, intercom and sound burglar alarms and low voltage master clock systems.

Excluded from this classification are energy management systems, life safety systems, supervisory controls and data acquisition systems not intrinsic with the above listed systems, fire alarm systems, nurse call systems and raceways exceeding fifteen feet in length.

LABORER, SKILLED - BUILDING

The skilled laborer building (BLD) classification shall encompass the following types of work, irrespective of the site of the work: tending of carpenters in unloading, handling, stockpiling and distribution

operations, also other building crafts, mixing, handling, and conveying of all materials used by masons, plasterers and other building construction crafts, whether done by hand or by any process. The drying of plastering when done by salamander heat, and the cleaning and clearing of all debris. All work pertaining to and in preparation of asbestos abatement and removal. The building of scaffolding and staging for masons and plasterers. The excavations for buildings and all other construction, digging, of trenches, piers, foundations and holes, dig-ging, lagging, sheeting, cribbing, bracing and propping of foundations, holes, caissons, cofferdams, and dikes, the setting of all guidelines for machine or hand excavation and subgrading. The mixing, handling, conveying, pouring, vibrating, gunniting and otherwise applying of concrete, whether by hand or other method of concrete for any walls, foundations, floors, or for other construction concrete sealant men. The wrecking, stripping, dismantling, and handling of concrete forms and false work, and the building of centers for fireproofing purposes. Boring machine, gas, electric or air in preparation for shoving pipe, telephone cable, and so forth, under highways, roads, streets and alleys. All hand and power operating cross cut saws when used for clearing. All work in compressed air construction. All work on acetylene burners in salvaging. The blocking and tamping of concrete. The laying of sewer tile and conduit, and pre-cast materials. The assembling and dismantling of all jacks and sectional scaffolding, including elevator construction and running of slip form jacks. The work of drill running and blasting, including wagon drills. The wrecking, stripping, dismantling, cleaning, moving and oiling of forms. The cutting off of concrete piles. The loading, unloading, handling and carrying to place of installation of all rods, (and materials for use in reinforcing) concrete and the hoisting of same and all signaling where hoist is used in this type of construction coming under the jurisdiction of the Laborers' Union. And, all other labor work not awarded to any other craft. Mortar mixers, kettlemen and carrier of hot stuff, tool crib men, watchmen (Laborer), firemen or salamander tenders, flagmen, deck hands, installation and maintenance of temporary gas-fired heating units, gravel box men, dumpmen and spotters, fencing Laborers, cleaning lumber, pit men, material checkers, dispatchers, unloading explosives, asphalt plant laborers, writer of scale tickets, fireproofing laborers, janitors, asbestos abatement and removal laborers, handling of materials treated with oil, creosote, chloride, asphalt, and/or foreign material harmful to skin or clothing, Laborers with de-watering systems, gunnite nozzle men, laborers tending masons with hot material or where foreign materials are used, Laborers handling masterplate or similar materials, laser beam operator, concrete burning machine operator, material selector men working with firebrick or combustible material, dynamite men, track laborers, cement handlers, chloride handlers, the unloading and laborers with steel workers and re-bars, concrete workers (wet), luteman, asphalt raker, curb asphalt machine operator, ready mix scalemen, permanent, portable or temporary plant drilling machine operator, plaster tenders, underpinning and shoring of buildings, fire watch, signaling of all power equipment, to include trucks excavating equipment, etc., tree topper or trimmer when in connection to construction, tunnel helpers in free air, batch dumpers, kettle and tar men, tank cleaners, plastic installers, scaffold workers, motorized buggies or motorized unit used for wet concrete or handling of building materials, sewer workers, rod and chain men, vibrator operators, mortar mixer operator, cement silica, clay, fly ash, lime and plasters, handlers (bulk or bag), cofferdam workers, on concrete paving, placing, cutting and tying of reinforcing, deck hand, dredge hand and shore laborers, bankmen on floating plant, asphalt workers with machine & layers, grade checker, power tools, caisson workers, lead man on sewer work, welders, cutters, burners and torch men, chain saw operators, paving breaker, jackhammer and drill operator, layout man and/or drainage tile layer, steel form setters --

street and highway, air tamping hammerman, signal man on crane, concrete saw operator, screen man on asphalt pavers, front end man on chip spreader, multiple concrete duct -- lead man.

LABORER, SKILLED - HIGHWAY

The skilled laborer heavy and highway (HWY) classification shall encompass the following types of work, irrespective of the site of the work: handling of materials treated with oil, creosote, asphalt and/or any foreign materials harmful to skin or clothing, track laborers, chloride handlers, the unloading and loading with steel workers and re-bars, concrete workers (wet), tunnel helpers in free air, batch dumpers, mason tenders, kettle and tar men, plastic installers, scaffold workers, motorized buggies or motorized unit used for wet concrete or handling of building materials, laborers with de-watering systems, sewer workers plus depth, rod and chainmen, vibrator operators, mortar mixer operators, cement silica, clay, fly ash, lime and plasters, handlers (bulk or bag), cofferdam workers plus depth, on concrete paving, placing, cutting and tying or reinforcing, deck hand, dredge hand shore laborers, bankmen on floating plant, asphalt workers with machine, and layers, grade checker, power tools, stripping of all concrete forms excluding paving forms, dumpmen and spotters, when necessary, caisson workers plus depth, gunnite nozzle men, welders, cutters, burners and torchmen, chain saw operators, paving breaker, jackhammer and drill operators, layout man and/or drainage tile layer, steel form setters - street and highway, air tamping hammerman, signal man on crane, concrete saw operator, screedman on asphalt pavers, front end man on chip spreader, multiple concrete duct, luteman, asphalt raker, curb asphalt machine operator, ready mix scalemen (portable or temporary plant), laser beam operator, concrete burning machine operator, and coring machine operator.

TRUCK DRIVER - OIL AND CHIP RESEALING ONLY.

This shall encompass laborers, workers and mechanics who drive contractor or subcontractor owned, leased, or hired pickup, dump, service, or oil distributor trucks. The work includes transporting materials and equipment (including but not limited to, oils, aggregate supplies, parts, machinery and tools) to or from the job site; distributing oil or liquid asphalt and aggregate; stock piling material when in connection with the actual oil and chip contract. The Truck Driver (Oil & Chip Resealing) wage classification does not include supplier delivered materials.

TRUCK DRIVER - BUILDING, HEAVY AND HIGHWAY CONSTRUCTION

Class 1. Drivers on 2 axle trucks hauling less than 9 ton. Air compressor and welding machines and brooms, including those pulled by separate units, truck driver helpers, warehouse employees, mechanic helpers, greasers and tiremen, pickup trucks when hauling materials, tools, or workers to and from and on-the-job site, and fork lifts up to 6,000 lb. capacity.

Class 2. Two or three axle trucks hauling more than 9 ton but hauling less than 16 ton. A-frame winch trucks, hydrolift trucks, vector trucks or similar equipment when used for transportation purposes. Fork lifts over 6,000 lb. capacity, winch trucks, four axle combination units, and ticket writers.

Class 3. Two, three or four axle trucks hauling 16 ton or more. Drivers on water pulls, articulated dump trucks, mechanics and working forepersons, and dispatchers. Five axle or more combination units.

Class 4. Low Boy and Oil Distributors.

Class 5. Drivers who require special protective clothing while employed on hazardous waste work.

OPERATING ENGINEERS - BUILDING

Class 1. Cranes; Overhead Cranes; GRADALL All Cherry Pickers; Mechanics; Central Concrete Mixing Plant Operator; Road Pavers (27E - Dual Drum - Tri Batchers); Blacktop Plant Operators and Plant Engineers; 3 Drum Hoist; Derricks; Hydro Cranes; Shovels; Skimmer Scoops; Koehring SCOOPER Drag Lines; Backhoe; Derrick Boats; Pile Drivers and Skid Rigs; Clamshells; Locomotive Cranes; Dredge (all types) Motor Patrol; Power Blades - Dumore - Elevating and similar types; Tower Cranes (Crawler-Mobile) and Stationary; Crane-type Backfiller; Drott Yumbo and similar types considered as Cranes; Caisson Rigs; Dozer; Tournadozer; Work Boats; Ross Carrier; Helicopter; Tournapulls - all and similar types; Scoops (all sizes); Pushcats; Endloaders (all types); Asphalt Surfacing Machine; Slip Form Paver; Rock Crusher; Heavy Equipment Greaser; CMI, CMI Belt Placer, Auto Grade & 3 Track and similar types; Side Booms; Multiple Unit Earth Movers; Creter Crane; Trench Machine; Pump-crete-Belt Crete-Squeeze Cretes-Screw-type Pumps and Gypsum; Bulker & Pump - Operator will clean; Formless Finishing Machine; Flaherty Spreader or similar types; Screed Man on Laydown Machine; Wheel Tractors (industrial or Farm-type w/Dozer-Hoe-Endloader or other attachments); F.W.D. & Similar Types; Vermeer Concrete Saw.

Class 2. Dinkeys; Power Launches; PH One-pass Soil Cement Machine (and similar types); Pugmill with Pump; Backfillers; Euclid Loader; Forklifts; Jeeps w/Ditching Machine or other attachments; Tuneluger; Automatic Cement and Gravel Batching Plants; Mobile Drills (Soil Testing) and similar types; Gurries and Similar Types; (1) and (2) Drum Hoists (Buck Hoist and Similar Types); Chicago Boom; Boring Machine & Pipe Jacking Machine; Hydro Boom; Dewatering System; Straw Blower; Hydro Seeder; Assistant Heavy Equipment Greaser on Spread; Tractors (Track type) without Power Unit pulling Rollers; Rollers on Asphalt -- Brick Macadem; Concrete Breakers; Concrete Spreaders; Mule Pulling Rollers; Center Stripper; Cement Finishing Machines & CMI Texture & Reel Curing Machines; Cement Finishing Machine; Barber Green or similar loaders; Vibro Tamper (All similar types) Self-propelled; Winch or Boom Truck; Mechanical Bull Floats; Mixers over 3 Bag to 27E; Tractor pulling Power Blade or Elevating Grader; Porter Rex Rail; Clary Screed; Truck Type Hoptoe Oilers; Fireman; Spray Machine on Paving; Curb Machines; Truck Crane Oilers; Oil Distributor; Truck-Mounted Saws.

Class 3. Air Compressor; Power Subgrader; Straight Tractor; Trac Air without attachments; Herman Nelson Heater, Dravo, Warner, Silent Glo, and similar types; Roller: Five (5) Ton and under on Earth or Gravel; Form Grader; Crawler Crane & Skid Rig Oilers; Freight Elevators - permanently installed; Pump; Light Plant; Generator; Conveyor (1) or (2) - Operator will clean; Welding Machine; Mixer (3) Bag and Under (Standard Capacity with skip); Bulk Cement Plant; Oiler on Central Concrete Mixing Plant.

OPERATING ENGINEERS - HEAVY AND HIGHWAY CONSTRUCTION

CLASS 1. Cranes; Hydro Cranes; Shovels; Crane Type Backfiller; Tower, Mobile, Crawler, & Stationary Cranes; Derricks; Hoists (3 Drum); Draglines; Drott Yumbo & Similar Types considered as Cranes; 360 Degree Swing Excavator (Shears, Grapples, Movacs, etc.); Back Hoe; Derrick Boats; Pile Driver and Skid Rigs; Clam Shell; Locomotive - Cranes; Road Pavers - Single Drum - Dual Drum - Tri Batchers; Motor Patrols & Power Blades - Dumore - Elevating & Similar Types; Mechanics; Central Concrete Mixing Plant Operator; Asphalt Batch Plant

Operators and Plant Engineers; Gradall; Caisson Rigs; Skimmer Scoop - Koering Scooper; Dredges (all types); Hoptoe; All Cherry Pickers; Work Boat; Ross Carrier; Helicopter; Dozer; Tournadozer; Tournapulls - all and similar types; Operation of Concrete and all Recycle Machines; Multiple Unit Earth Movers; Scoops (all sizes); Pushcats; Endloaders (all types); Asphalt Surfacing Machine; Slip Form Paver; Rock Crusher; Operation of Material Crusher, Screening Plants, and Tunnel Boring Machine; Heavy Equipment Greaser (top greaser on spread); CMI, Auto Grade, CMI Belt Placer & 3 Track and Similar Types; Side Booms; Asphalt Heater & Planer Combination (used to plane streets); Wheel Tractors (with Dozer, Hoe or Endloader Attachments); CAT Earthwork Compactors and Similar Types; Blaw Knox Spreader and Similar Types; Trench Machines; Pump Crete - Belt Crete - Squeeze Crete - Screw Type Pumps and Gypsum (operator will clean); Creter Crane; Operation of Concrete Pump Truck; Formless Finishing Machines; Flaherty Spreader or Similar Types; Screed Man on Laydown Machine; Vermeer Concrete Saw; Operation of Laser Screed; Span Saw; Dredge Leverman; Dredge Engineer; Lull or Similar Type; Hydro-Boom Truck; Operation of Guard Rail Machine; and Starting Engineer on Pipeline or Construction (11 or more pieces) including: Air Compressor (Trailer Mounted), All Forced Air Heaters (regardless of Size), Water Pumps (Greater than 4-1/2" or Total Discharge Over 4-1/2"), Light Plants, Generators (Trailer Mounted - Excluding Decontamination Trailer), Welding Machines (Any Size or Mode of Power), Conveyor, Mixer (any size), Stud Welder, Power Pac, etc, and Ground Heater (Trailer Mounted).

CLASS 2. Bulker & Pump; Power Launches; Boring Machine & Pipe Jacking Machine; Dinkeys; Operation of Carts, Powered Haul Unit for a Boring Machine; P & H One Pass Soil Cement Machines and Similar Types; Wheel Tractors (Industry or Farm Type - Other); Back Fillers; Euclid Loader; Fork Lifts; Jeep w/Ditching Machine or Other Attachments; Tunneluger; Automatic Cement & Gravel Batching Plants; Mobile Drills - Soil Testing and Similar Types; Pugmill with Pump; All (1) and (2) Drum Hoists; Dewatering System; Straw Blower; Hydro-Seeder; Bump Grinders (self-propelled); Assistant Heavy Equipment Greaser; Apsco Spreader; Tractors (Track-Type) without Power Units Pulling Rollers; Rollers on Asphalt - Brick or Macadam; Concrete Breakers; Concrete Spreaders; Cement Strippers; Cement Finishing Machines & CMI Texture & Reel Curing Machines; Vibro-Tampers (All Similar Types Self-Propelled); Mechanical Bull Floats; Self-Propelled Concrete Saws; Truck Mounted Power Saws; Operation of Curb Cutters; Mixers - Over Three (3) Bags; Winch and Boom Trucks; Tractor Pulling Power Blade or Elevating Grader; Porter Rex Rail; Clary Screed; Mule Pulling Rollers; Pugmill without Pump; Barber Greene or Similar Loaders; Track Type Tractor w/Power Unit attached (minimum); Fireman; Spray Machine on Paving; Curb Machines; Paved Ditch Machine; Power Broom; Self-Propelled Sweepers; Self-Propelled Conveyors; Power Subgrader; Oil Distributor; Straight Tractor; Truck Crane Oiler; Truck Type Oilers; Directional Boring Machine; Horizontal Directional Drill; Articulating End Dump Vehicles; Starting Engineer on Pipeline or Construction (6 -10 pieces) including: Air Compressor (Trailer Mounted), All Forced Air Heaters (regardless of Size), Water Pumps (Greater than 4-1/2" or Total Discharge Over 4-1/2"), Light Plants, Generators (Trailer Mounted - Excluding Decontamination Trailer), Welding Machines (Any Size or Mode of Power), Conveyor, Mixer (any size), Stud Welder, Power Pac, etc., and Ground Heater (Trailer Mounted).

CLASS 3. Straight Framed Truck Mounted Vac Unit (separately powered); Trac Air Machine (without attachments); Rollers - Five Ton and Under on Earth and Gravel; Form Graders; Bulk Cement Plant; Oilers; and Starting Engineer on Pipeline or Construction (3 - 5 pieces) including: Air Compressor (Trailer Mounted), All Forced Air Heaters (regardless of Size), Water Pumps (Greater than 4-1/2" or Total Discharge Over 4-1/2"), Light Plants, Generators (Trailer Mounted -

Excluding Decontamination Trailer), Welding Machines (Any Size or Mode of Power), Conveyor, Mixer (any size), Stud Welder, Power Pac, etc., and Ground Heater (Trailer Mounted).

Other Classifications of Work:

For definitions of classifications not otherwise set out, the Department generally has on file such definitions which are available. If a task to be performed is not subject to one of the classifications of pay set out, the Department will upon being contacted state which neighboring county has such a classification and provide such rate, such rate being deemed to exist by reference in this document. If no neighboring county rate applies to the task, the Department shall undertake a special determination, such special determination being then deemed to have existed under this determination. If a project requires these, or any classification not listed, please contact IDOL at 217-782-1710 for wage rates or clarifications.

LANDSCAPING

Landscaping work falls under the existing classifications for laborer, operating engineer and truck driver. The work performed by landscape plantsman and landscape laborer is covered by the existing classification of laborer. The work performed by landscape operators (regardless of equipment used or its size) is covered by the classifications of operating engineer. The work performed by landscape truck drivers (regardless of size of truck driven) is covered by the classifications of truck driver.

Mason County Prevailing Wage for May 2013

(See explanation of column headings at bottom of wages)

Trade Name	RG	TYP	C	Base	FRMAN	M-F>8	OSA	OSH	H/W	Pensn	Vac	Trng
=====	==	===	=	=====	=====	=====	===	===	=====	=====	=====	=====
ASBESTOS ABT-GEN		BLD		25.250	26.250	1.5	1.5	2.0	7.550	10.08	0.000	0.800
ASBESTOS ABT-MEC		BLD		29.860	30.860	1.5	1.5	2.0	6.950	3.000	0.000	0.000
BOILERMAKER		BLD		35.010	38.010	2.0	2.0	2.0	7.070	13.83	0.000	0.300
BRICK MASON		BLD		29.130	29.880	2.0	2.0	2.0	8.200	10.03	0.000	0.580
CARPENTER		BLD		29.330	31.580	1.5	1.5	2.0	7.450	13.66	0.000	0.520
CARPENTER		HWY		28.840	30.590	1.5	1.5	2.0	7.450	13.98	0.000	0.520
CEMENT MASON		BLD		27.090	28.840	1.5	1.5	2.0	8.140	13.55	0.000	0.500
CEMENT MASON		HWY		28.280	29.780	1.5	1.5	2.0	8.140	13.93	0.000	0.500
CERAMIC TILE FNSHER		BLD		25.480	0.000	1.5	1.5	2.0	8.200	8.930	0.000	0.000
ELECTRIC PWR EQMT OP		ALL		35.440	0.000	1.5	1.5	2.0	5.000	10.98	0.000	0.270
ELECTRIC PWR GRNDMAN		ALL		24.320	0.000	1.5	1.5	2.0	5.000	7.540	0.000	0.180
ELECTRIC PWR LINEMAN		ALL		39.370	41.910	1.5	1.5	2.0	5.000	12.20	0.000	0.300
ELECTRIC PWR TRK DRV		ALL		25.510	0.000	1.5	1.5	2.0	5.000	7.920	0.000	0.190
ELECTRICIAN	N	BLD		34.820	37.320	1.5	1.5	2.0	5.350	10.08	0.000	0.400
ELECTRICIAN	S	BLD		34.220	36.220	1.5	1.5	2.0	5.860	8.120	0.000	0.400
ELECTRONIC SYS TECH		BLD		27.430	29.180	1.5	1.5	2.0	5.350	9.320	0.000	0.400
ELEVATOR CONSTRUCTOR		BLD		40.520	45.585	2.0	2.0	2.0	11.88	12.71	3.240	0.600
GLAZIER		BLD		30.780	32.780	1.5	2.0	2.0	6.630	8.150	0.000	0.380
HT/FROST INSULATOR		BLD		37.260	38.260	1.5	1.5	2.0	7.850	11.16	0.000	0.500
IRON WORKER	N	BLD		30.330	32.230	1.5	1.5	2.0	9.390	11.56	0.000	0.440
IRON WORKER	N	HWY		34.020	36.020	1.5	1.5	2.0	9.390	11.56	0.000	0.390
IRON WORKER	S	BLD		29.460	31.460	1.5	1.5	2.0	7.740	11.38	0.000	0.660
IRON WORKER	S	HWY		30.600	32.100	1.5	1.5	2.0	7.740	11.69	0.000	0.660
LABORER		BLD		23.750	24.750	1.5	1.5	2.0	7.550	10.08	0.000	0.800
LABORER		HWY		24.910	25.910	1.5	1.5	2.0	7.550	10.63	0.000	0.800
LATHER		BLD		29.330	31.580	1.5	1.5	2.0	7.450	13.66	0.000	0.520
MACHINERY MOVER	N	HWY		34.020	36.020	1.5	1.5	2.0	9.390	11.56	0.000	0.390
MACHINIST		BLD		43.550	46.050	1.5	1.5	2.0	6.130	8.950	1.850	0.000

MARBLE FINISHERS		BLD	25.480	0.000	1.5	1.5	2.0	8.200	8.930	0.000	0.000
MARBLE MASON		BLD	26.980	27.730	1.5	1.5	2.0	8.200	8.930	0.000	0.000
MILLWRIGHT		BLD	30.240	32.490	1.5	1.5	2.0	7.450	13.09	0.000	0.520
MILLWRIGHT		HWY	31.690	33.440	1.5	1.5	2.0	7.450	13.54	0.000	0.520
OPERATING ENGINEER		BLD 1	36.000	39.000	1.5	1.5	2.0	9.750	13.60	0.000	3.000
OPERATING ENGINEER		BLD 2	33.490	39.000	1.5	1.5	2.0	9.750	13.60	0.000	3.000
OPERATING ENGINEER		BLD 3	29.340	39.000	1.5	1.5	2.0	9.750	13.60	0.000	3.000
OPERATING ENGINEER		HWY 1	36.000	39.500	1.5	1.5	2.0	9.750	13.60	0.000	3.000
OPERATING ENGINEER		HWY 2	33.490	39.500	1.5	1.5	2.0	9.750	13.60	0.000	3.000
OPERATING ENGINEER		HWY 3	29.340	39.500	1.5	1.5	2.0	9.750	13.60	0.000	3.000
PAINTER		ALL	32.900	34.900	1.5	1.5	1.5	9.650	8.200	0.000	1.250
PILEDRIVER		BLD	29.830	32.080	1.5	1.5	2.0	7.450	13.66	0.000	0.520
PILEDRIVER		HWY	29.840	31.590	1.5	1.5	2.0	7.450	13.98	0.000	0.520
PIPEFITTER	N	BLD	37.400	41.510	1.5	1.5	2.0	7.000	11.63	0.000	1.060
PIPEFITTER	S	BLD	40.020	44.020	1.5	1.5	2.0	7.000	7.750	0.000	0.900
PLASTERER		BLD	27.770	28.770	1.5	1.5	2.0	8.140	12.76	0.000	0.600
PLUMBER	N	BLD	33.570	36.590	1.5	1.5	2.0	7.000	13.31	0.000	0.900
PLUMBER	S	BLD	40.020	44.020	1.5	1.5	2.0	7.000	7.750	0.000	0.900
ROOFER		BLD	27.900	30.400	1.5	1.5	2.0	8.600	6.750	0.000	0.500
SHEETMETAL WORKER		BLD	31.680	33.930	1.5	1.5	2.0	8.300	12.35	0.000	0.500
SIGN HANGER	N	HWY	34.020	36.020	1.5	1.5	2.0	9.390	11.56	0.000	0.390
SPRINKLER FITTER		BLD	36.390	39.140	1.5	1.5	2.0	8.420	8.500	0.000	0.450
STEEL ERECTOR	N	HWY	34.020	36.020	1.5	1.5	2.0	9.390	11.56	0.000	0.390
STONE MASON		BLD	29.130	29.880	2.0	2.0	2.0	8.200	10.03	0.000	0.580
TERRAZZO FINISHER		BLD	25.480	0.000	1.5	1.5	2.0	8.200	8.930	0.000	0.000
TERRAZZO MASON		BLD	26.980	27.730	1.5	1.5	2.0	8.200	8.930	0.000	0.000
TILE MASON		BLD	26.980	27.730	1.5	1.5	2.0	8.200	8.930	0.000	0.000
TRUCK DRIVER		ALL 1	31.230	0.000	1.5	1.5	2.0	10.30	4.840	0.000	0.250
TRUCK DRIVER		ALL 2	31.680	0.000	1.5	1.5	2.0	10.30	4.840	0.000	0.250
TRUCK DRIVER		ALL 3	31.890	0.000	1.5	1.5	2.0	10.30	4.840	0.000	0.250
TRUCK DRIVER		ALL 4	32.180	0.000	1.5	1.5	2.0	10.30	4.840	0.000	0.250
TRUCK DRIVER		ALL 5	33.020	0.000	1.5	1.5	2.0	10.30	4.840	0.000	0.250
TRUCK DRIVER		O&C 1	24.980	0.000	1.5	1.5	2.0	10.30	4.840	0.000	0.250
TRUCK DRIVER		O&C 2	25.340	0.000	1.5	1.5	2.0	10.30	4.840	0.000	0.250
TRUCK DRIVER		O&C 3	25.510	0.000	1.5	1.5	2.0	10.30	4.840	0.000	0.250
TRUCK DRIVER		O&C 4	25.740	0.000	1.5	1.5	2.0	10.30	4.840	0.000	0.250
TRUCK DRIVER		O&C 5	26.420	0.000	1.5	1.5	2.0	10.30	4.840	0.000	0.250
TUCKPOINTER		BLD	29.130	29.880	2.0	2.0	2.0	8.200	10.03	0.000	0.580

Legend :

RG (Region)

TYP (Trade Type - All,Highway,Building,Floating,Oil & Chip,Rivers)

C (Class)

Base (Base Wage Rate)

FRMAN (Foreman Rate)

M-F>8 (OT required for any hour greater than 8 worked each day, Mon through Fri.)

OSA (Overtime (OT) is required for every hour worked on Saturday)

OSH (Overtime is required for every hour worked on Sunday and Holidays)

H/W (Health & Welfare Insurance)

Pensn (Pension)

Vac (Vacation)

Explanations

MASON COUNTY

ELECTRICIAN (SOUTH) - Townships of Lynchburg, Bath, Kilbourne, Crane Creek, Salt Creek and Mason.

IRONWORKERS (NORTH) - That part of the county North including the towns of Easton and Teheran.

PLUMBERS & PIPEFITTERS (SOUTH) - That part of the county South of Rt. 136 including the City of Havana.

The following list is considered as those days for which holiday rates of wages for work performed apply: New Years Day, Memorial Day, Fourth of July, Labor Day, Thanksgiving Day, Christmas Day and Veterans Day in some classifications/counties. Generally, any of these holidays which fall on a Sunday is celebrated on the following Monday. This then makes work performed on that Monday payable at the appropriate overtime rate for holiday pay. Common practice in a given local may alter certain days of celebration. If in doubt, please check with IDOL.

Oil and chip resealing (O&C) means the application of road oils and liquid asphalt to coat an existing road surface, followed by application of aggregate chips or gravel to coated surface, and subsequent rolling of material to seal the surface.

EXPLANATION OF CLASSES

ASBESTOS - GENERAL - removal of asbestos material/mold and hazardous materials from any place in a building, including mechanical systems where those mechanical systems are to be removed. This includes the removal of asbestos materials/mold and hazardous materials from ductwork or pipes in a building when the building is to be demolished at the time or at some close future date.

ASBESTOS - MECHANICAL - removal of asbestos material from mechanical systems, such as pipes, ducts, and boilers, where the mechanical systems are to remain.

CERAMIC TILE FINISHER, MARBLE FINISHER, TERRAZZO FINISHER

Assisting, helping or supporting the tile, marble and terrazzo mechanic by performing their historic and traditional work assignments required to complete the proper installation of the work covered by said crafts. The term "Ceramic" is used for naming the classification only and is in no way a limitation of the product handled. Ceramic takes into consideration most hard tiles.

ELECTRONIC SYSTEMS TECHNICIAN

Installation, service and maintenance of low-voltage systems which utilizes the transmission and/or transference of voice, sound, vision, or digital for commercial, education, security and entertainment purposes for the following: TV monitoring and surveillance, background/foreground music, intercom and telephone interconnect, field programming, inventory control systems, microwave transmission, multi-media, multiplex, radio page, school, intercom and sound burglar alarms and low voltage master clock systems.

Excluded from this classification are energy management systems, life safety systems, supervisory controls and data acquisition systems not intrinsic with the above listed systems, fire alarm systems, nurse call systems and raceways exceeding fifteen feet in length.

TRUCK DRIVER - BUILDING, HEAVY AND HIGHWAY CONSTRUCTION

Class 1. Drivers on 2 axle trucks hauling less than 9 ton. Air compressor and welding machines and brooms, including those pulled by separate units, truck driver helpers, warehouse employees, mechanic helpers, greasers and tiremen, pickup trucks when hauling materials, tools, or workers to and from and on-the-job site, and fork lifts up to 6,000 lb. capacity.

Class 2. Two or three axle trucks hauling more than 9 ton but hauling less than 16 ton. A-frame winch trucks, hydrolift trucks, vactor trucks or similar equipment when used for transportation purposes. Fork lifts over 6,000 lb. capacity, winch trucks, four axle combination units, and ticket writers.

Class 3. Two, three or four axle trucks hauling 16 ton or more. Drivers on water pulls, articulated dump trucks, mechanics and working forepersons, and dispatchers. Five axle or more combination units.

Class 4. Low Boy and Oil Distributors.

Class 5. Drivers who require special protective clothing while employed on hazardous waste work.

TRUCK DRIVER - OIL AND CHIP RESEALING ONLY.

This shall encompass laborers, workers and mechanics who drive contractor or subcontractor owned, leased, or hired pickup, dump, service, or oil distributor trucks. The work includes transporting materials and equipment (including but not limited to, oils, aggregate supplies, parts, machinery and tools) to or from the job site; distributing oil or liquid asphalt and aggregate; stock piling material when in connection with the actual oil and chip contract. The Truck Driver (Oil & Chip Resealing) wage classification does not include supplier delivered materials.

OPERATING ENGINEERS - BUILDING

Class 1. Cranes; Overhead Cranes; Gradall; All Cherry Pickers; Mechanics; Central Concrete Mixing Plant Operator; Road Pavers (27E - Dual Drum - Tri Batchers); Blacktop Plant Operators and Plant Engineers; 3 Drum Hoist; Derricks; Hydro Cranes; Shovels; Skimmer Scoops; Koehring Scooper; Drag Lines; Backhoe; Derrick Boats; Pile Drivers and Skid Rigs; Clamshells; Locomotive Cranes; Dredge (all types) Motor Patrol; Power Blades - Dumore - Elevating and similar types; Tower Cranes (Crawler-Mobile) and Stationary; Crane-type Backfiller; Drott Yumbo and similar types considered as Cranes; Caisson Rigs; Dozer; Tournadozer; Work Boats; Ross Carrier; Helicopter; Tournapulls - all and similar types; Scoops (all sizes); Pushcats; Endloaders (all types); Asphalt Surfacing Machine; Slip Form Paver; Rock Crusher; Heavy Equipment Greaser; CMI, CMI Belt Placer, Auto Grade & 3 Track and similar types; Side Booms; Multiple Unit Earth Movers; Creter Crane; Trench Machine; Pump-crete-Belt Crete-Squeeze Cretes-Screw-type Pumps and Gypsum; Bulker & Pump - Operator will clean; Formless Finishing Machine; Flaherty Spreader or similar types; Screed Man on Laydown Machine; Wheel Tractors (industrial or Farm-type w/Dozer-Hoe-Endloader or other attachments); F.W.D. & Similar Types; Vermeer Concrete Saw.

Class 2. Dinkeys; Power Launches; PH One-pass Soil Cement Machine (and similar types); Pugmill with Pump; Backfillers; Euclid Loader; Forklifts; Jeeps w/Ditching Machine or other attachments; Tunneluger; Automatic Cement and Gravel Batching Plants; Mobile Drills (Soil Testing) and similar types; Gurries and Similar Types; (1) and (2) Drum Hoists (Buck Hoist and Similar Types); Chicago Boom; Boring Machine & Pipe Jacking Machine; Hydro Boom; Dewatering System; Straw Blower; Hydro Seeder; Assistant Heavy Equipment Greaser on Spread; Tractors (Track type) without Power Unit pulling Rollers; Rollers on Asphalt -- Brick Macadem; Concrete Breakers; Concrete Spreaders; Mule Pulling Rollers; Center Stripper; Cement Finishing Machines & CMI Texture & Reel Curing Machines; Cement Finishing Machine; Barber Green or similar loaders; Vibro Tamper (All similar types) Self-propelled; Winch or Boom Truck; Mechanical Bull Floats; Mixers over 3 Bag to 27E; Tractor pulling Power Blade or Elevating Grader; Porter Rex Rail; Clary Screed; Truck Type Hoptoe Oilers; Fireman; Spray Machine on Paving; Curb Machines; Truck Crane Oilers; Oil Distributor; Truck-Mounted Saws.

Class 3. Air Compressor; Power Subgrader; Straight Tractor; Trac Air without attachments; Herman Nelson Heater, Dravo, Warner, Silent Glo, and similar types; Roller: Five (5) Ton and under on Earth or Gravel; Form Grader; Crawler Crane & Skid Rig Oilers; Freight Elevators - permanently installed; Pump; Light Plant; Generator; Conveyor (1) or (2) - Operator will clean; Welding Machine; Mixer (3) Bag and Under (Standard Capacity with skip); Bulk Cement Plant; Oiler on Central Concrete Mixing Plant.

OPERATING ENGINEERS - HEAVY AND HIGHWAY CONSTRUCTION

CLASS 1. Cranes; Hydro Cranes; Shovels; Crane Type Backfiller; Tower, Mobile, Crawler, & Stationary Cranes; Derricks; Hoists (3 Drum); Draglines; Drott Yumbo & Similar Types considered as Cranes; 360 Degree Swing Excavator (Shears, Grapples, Movacs, etc.); Back Hoe; Derrick Boats; Pile Driver and Skid Rigs; Clam Shell; Locomotive - Cranes; Road Pavers - Single Drum - Dual Drum - Tri Batcher; Motor Patrols & Power Blades - Dumore - Elevating & Similar Types; Mechanics; Central Concrete Mixing Plant Operator; Asphalt Batch Plant Operators and Plant Engineers; Gradall; Caisson Rigs; Skimmer Scoop - Koering Scooper; Dredges (all types); Hoptoe; All Cherry Pickers; Work Boat; Ross Carrier; Helicopter; Dozer; Tournadozer; Tournapulls - all and similar types; Operation of Concrete and all Recycle Machines; Multiple Unit Earth Movers; Scoops (all sizes); Pushcats; Endloaders (all types); Asphalt Surfacing Machine; Slip Form Paver; Rock Crusher; Operation of Material Crusher, Screening Plants, and Tunnel Boring Machine; Heavy Equipment Greaser (top greaser on spread); CMI, Auto Grade, CMI Belt Placer & 3 Track and Similar Types; Side Booms; Asphalt Heater & Planer Combination (used to plane streets); Wheel Tractors (with Dozer, Hoe or Endloader Attachments); CAT Earthwork Compactors and Similar Types; Blaw Knox Spreader and Similar Types; Trench Machines; Pump Crete - Belt Crete - Squeeze Crete - Screw Type Pumps and Gypsum (operator will clean); Creter Crane; Operation of Concrete Pump Truck; Formless Finishing Machines; Flaherty Spreader or Similar Types; Screed Man on Laydown Machine; Vermeer Concrete Saw; Operation of Laser Screed; Span Saw; Dredge Leverman; Dredge Engineer; Lull or Similar Type; Hydro-Boom Truck; Operation of Guard Rail Machine; and Starting Engineer on Pipeline or Construction (11 or more pieces) including: Air Compressor (Trailer Mounted), All Forced Air Heaters (regardless of Size), Water Pumps (Greater than 4-1/2" or Total Discharge Over 4-1/2"), Light Plants, Generators (Trailer Mounted - Excluding Decontamination Trailer), Welding Machines (Any Size or Mode of Power), Conveyor, Mixer (any size), Stud Welder, Power Pac, etc, and Ground Heater (Trailer Mounted).

CLASS 2. Bulker & Pump; Power Launches; Boring Machine & Pipe Jacking Machine; Dinkeys; Operation of Carts, Powered Haul Unit for a Boring Machine; P & H One Pass Soil Cement Machines and Similar Types; Wheel Tractors (Industry or Farm Type - Other); Back Fillers; Euclid Loader; Fork Lifts; Jeep w/Ditching Machine or Other Attachments; Tunneluger; Automatic Cement & Gravel Batching Plants; Mobile Drills - Soil Testing and Similar Types; Pugmill with Pump; All (1) and (2) Drum Hoists; Dewatering System; Straw Blower; Hydro-Seeder; Bump Grinders (self-propelled); Assistant Heavy Equipment Greaser; Apsco Spreader; Tractors (Track-Type) without Power Units Pulling Rollers; Rollers on Asphalt - Brick or Macadam; Concrete Breakers; Concrete Spreaders; Cement Strippers; Cement Finishing Machines & CMI Texture & Reel Curing Machines; Vibro-Tampers (All Similar Types Self-Propelled); Mechanical Bull Floats; Self-Propelled Concrete Saws; Truck Mounted Power Saws; Operation of Curb Cutters; Mixers - Over Three (3) Bags; Winch and Boom Trucks; Tractor Pulling Power Blade or Elevating Grader; Porter Rex Rail; Clary Screed; Mule Pulling Rollers; Pugmill without Pump; Barber Greene or Similar Loaders; Track Type Tractor w/Power Unit attached (minimum); Fireman; Spray Machine on Paving; Curb Machines; Paved Ditch Machine; Power Broom; Self-Propelled Sweepers; Self-Propelled Conveyors; Power Subgrader; Oil Distributor; Straight Tractor; Truck Crane Oiler; Truck Type Oilers; Directional Boring Machine; Horizontal Directional Drill; Articulating End Dump Vehicles; Starting Engineer on Pipeline or Construction (6 -10 pieces) including: Air Compressor (Trailer Mounted), All Forced Air Heaters (regardless of Size), Water Pumps (Greater than 4-1/2" or Total Discharge Over 4-1/2"), Light Plants, Generators (Trailer Mounted - Excluding Decontamination Trailer), Welding Machines (Any Size or Mode of Power), Conveyor, Mixer (any size), Stud Welder, Power Pac, etc., and Ground Heater (Trailer Mounted).

CLASS 3. Straight Framed Truck Mounted Vac Unit (separately powered); Trac Air Machine (without attachments); Rollers - Five Ton and Under on Earth and Gravel; Form Graders; Bulk Cement Plant; Oilers; and Starting Engineer on Pipeline or Construction (3 - 5 pieces) including: Air Compressor (Trailer Mounted), All Forced Air Heaters (regardless of Size), Water Pumps (Greater than 4-1/2" or Total Discharge Over 4-1/2"), Light Plants, Generators (Trailer Mounted - Excluding Decontamination Trailer), Welding Machines (Any Size or Mode of Power), Conveyor, Mixer (any size), Stud Welder, Power Pac, etc., and Ground Heater (Trailer Mounted).

Other Classifications of Work:

For definitions of classifications not otherwise set out, the Department generally has on file such definitions which are available. If a task to be performed is not subject to one of the classifications of pay set out, the Department will upon being contacted state which neighboring county has such a classification and provide such rate, such rate being deemed to exist by reference in this document. If no neighboring county rate applies to the task, the Department shall undertake a special determination, such special determination being then deemed to have existed under this determination. If a project requires these, or any classification not listed, please contact IDOL at 217-782-1710 for wage rates or clarifications.

LANDSCAPING

Landscaping work falls under the existing classifications for laborer, operating engineer and truck driver. The work performed by landscape plantsman and landscape laborer is covered by the existing classification of laborer. The work performed by landscape operators (regardless of equipment used or its size) is covered by the classifications of operating engineer. The work performed by

landscape truck drivers (regardless of size of truck driven) is covered by the classifications of truck driver.

Massac County Prevailing Wage for May 2013

(See explanation of column headings at bottom of wages)

Trade Name	RG	TYP	C	Base	FRMAN	M-F>8	OSA	OSH	H/W	Pensn	Vac	Trng
=====	==	==	=	=====	=====	=====	==	==	=====	=====	=====	=====
ASBESTOS ABT-GEN		ALL		25.300	25.750	1.5	1.5	2.0	5.750	10.35	0.000	0.900
ASBESTOS ABT-MEC		BLD		21.150	22.150	1.5	1.5	2.0	6.400	5.150	0.000	0.650
BOILERMAKER		BLD		31.500	34.000	1.5	1.5	2.0	7.070	18.73	1.000	0.350
BRICK MASON		BLD		28.620	30.120	1.5	1.5	2.0	8.200	7.030	0.000	0.430
CARPENTER		BLD		31.890	33.390	1.5	1.5	2.0	6.550	6.750	0.000	0.400
CARPENTER		HWY		31.840	33.340	1.5	1.5	2.0	6.550	6.750	0.000	0.400
CEMENT MASON		BLD		28.200	29.700	1.5	1.5	2.0	6.600	5.400	0.000	0.500
CEMENT MASON		HWY		27.290	28.290	1.5	1.5	2.0	6.600	5.160	0.000	0.400
CERAMIC TILE FNSHER		BLD		27.120	0.000	1.5	1.5	2.0	8.200	7.030	0.000	0.430
ELECTRIC PWR EQMT OP		ALL	1	35.570	0.000	1.5	1.5	2.0	5.000	9.960	0.000	0.360
ELECTRIC PWR EQMT OP		ALL	2	31.740	0.000	1.5	1.5	2.0	5.000	8.880	0.000	0.320
ELECTRIC PWR GRNDMAN		ALL		26.100	0.000	1.5	1.5	2.0	5.000	7.310	0.000	0.260
ELECTRIC PWR LINEMAN		ALL		44.630	47.650	1.5	1.5	2.0	5.000	12.50	0.000	0.450
ELECTRICIAN		ALL		39.350	41.600	1.5	1.5	2.0	6.140	9.440	0.000	0.790
ELECTRONIC SYS TECH		BLD		32.570	34.320	1.5	1.5	2.0	6.000	4.240	0.000	0.400
FLOOR LAYER		BLD		29.330	30.080	1.5	1.5	2.0	6.550	6.750	0.000	0.400
GLAZIER		BLD		26.780	28.030	1.5	1.5	2.0	6.120	5.200	0.000	0.300
HT/FROST INSULATOR		BLD		29.450	30.450	1.5	1.5	2.0	5.050	9.730	0.000	0.280
IRON WORKER		ALL		27.730	29.730	1.5	1.5	2.0	7.010	11.41	0.000	0.500
LABORER		BLD		25.300	25.750	1.5	1.5	2.0	5.750	10.35	0.000	0.800
LABORER		HWY		25.300	25.750	1.5	1.5	2.0	5.750	10.35	0.000	0.800
LABORER		O&C		17.740	18.190	1.5	1.5	2.0	5.450	8.450	0.000	0.800
MACHINIST		BLD		43.550	46.050	1.5	1.5	2.0	6.130	8.950	1.850	0.000
MARBLE FINISHERS		BLD		27.120	0.000	1.5	1.5	2.0	8.200	7.030	0.000	0.430
MARBLE MASON		BLD		28.620	30.120	1.5	1.5	2.0	8.200	7.030	0.000	0.430
MILLWRIGHT		BLD		31.890	33.390	1.5	1.5	2.0	6.550	6.750	0.000	0.400
MILLWRIGHT		HWY		31.840	33.340	1.5	1.5	2.0	6.550	6.750	0.000	0.400
OE RIVER 1		RIV	1	33.550	34.550	1.5	1.5	2.0	7.000	8.800	0.000	1.450
OE RIVER 2		RIV	2	30.100	34.550	1.5	1.5	2.0	7.000	8.800	0.000	1.450
OPERATING ENGINEER		ALL	1	33.450	34.450	1.5	1.5	2.0	7.000	8.800	0.000	1.450
OPERATING ENGINEER		ALL	2	31.550	34.450	1.5	1.5	2.0	7.000	8.800	0.000	1.450
OPERATING ENGINEER		ALL	3	24.150	34.450	1.5	1.5	2.0	7.000	8.800	0.000	1.450
OPERATING ENGINEER		ALL	4	21.400	27.800	1.5	1.5	2.0	5.650	6.100	0.000	1.100
OPERATING ENGINEER		O&C	1	25.090	26.090	1.5	1.5	2.0	7.000	8.800	0.000	1.450
OPERATING ENGINEER		O&C	2	23.660	26.090	1.5	1.5	2.0	7.000	8.800	0.000	1.450
OPERATING ENGINEER		O&C	3	18.120	26.090	1.5	1.5	2.0	7.000	8.800	0.000	1.450
OPERATING ENGINEER		O&C	4	16.050	21.100	1.5	1.5	2.0	5.650	6.100	0.000	1.100
PAINTER		BLD		19.000	20.000	1.5	1.5	2.0	6.500	4.750	0.000	0.050
PAINTER		HWY		25.250	26.250	1.5	1.5	2.0	6.500	4.750	0.000	0.050
PAINTER OVER 30FT		BLD		21.000	22.000	1.5	1.5	2.0	6.500	4.750	0.000	0.050
PAINTER OVER 30FT		HWY		24.250	25.250	1.5	1.5	2.0	5.250	2.750	0.000	0.000
PAINTER PWR EQMT		BLD		19.000	20.000	1.5	1.5	2.0	6.500	4.750	0.000	0.050
PAINTER PWR EQMT		HWY		26.250	27.250	1.5	1.5	2.0	6.500	4.750	0.000	0.050
PILEDRIVER		BLD		31.890	33.390	1.5	1.5	2.0	6.550	6.750	0.000	0.400
PILEDRIVER		HWY		31.840	33.340	1.5	1.5	2.0	6.550	6.750	0.000	0.400
PIPEFITTER		BLD		41.470	45.620	1.5	2.0	2.0	8.450	5.780	0.000	1.250
PLASTERER		BLD		28.200	29.700	1.5	1.5	2.0	6.600	5.400	0.000	0.500
PLUMBER		BLD		41.470	45.620	1.5	2.0	2.0	8.450	5.780	0.000	1.250
ROOFER		BLD		27.240	29.240	1.5	1.5	2.0	7.200	5.250	0.000	0.540
SHEETMETAL WORKER		ALL		31.690	33.190	1.5	1.5	2.0	7.130	6.730	1.910	0.360
SPRINKLER FITTER		BLD		36.390	39.140	1.5	1.5	2.0	8.420	8.500	0.000	0.450
STONE MASON		BLD		28.620	30.120	1.5	1.5	2.0	8.200	7.030	0.000	0.430
TERRAZZO FINISHER		BLD		27.120	0.000	1.5	1.5	2.0	8.200	7.030	0.000	0.430
TRUCK DRIVER		ALL	1	30.070	0.000	1.5	1.5	2.0	10.30	6.100	0.000	0.250
TRUCK DRIVER		ALL	2	30.520	0.000	1.5	1.5	2.0	10.30	6.100	0.000	0.250

TRUCK DRIVER	ALL	3	30.740	0.000	1.5	1.5	2.0	10.30	6.100	0.000	0.250
TRUCK DRIVER	ALL	4	31.030	0.000	1.5	1.5	2.0	10.30	6.100	0.000	0.250
TRUCK DRIVER	ALL	5	31.850	0.000	1.5	1.5	2.0	10.30	6.100	0.000	0.250
TRUCK DRIVER	O&C	1	22.750	0.000	1.5	1.5	2.0	2.920	6.700	0.000	0.250
TRUCK DRIVER	O&C	2	19.150	0.000	1.5	1.5	2.0	2.920	6.700	0.000	0.250
TRUCK DRIVER	O&C	3	19.650	0.000	1.5	1.5	2.0	2.920	6.700	0.000	0.250
TUCKPOINTER	BLD		28.620	30.120	1.5	1.5	2.0	8.200	7.030	0.000	0.430

Legend :

RG (Region)

TYP (Trade Type - All,Highway,Building,Floating,Oil & Chip,Rivers)

C (Class)

Base (Base Wage Rate)

FRMAN (Foreman Rate)

M-F>8 (OT required for any hour greater than 8 worked each day, Mon through Fri.

OSA (Overtime (OT) is required for every hour worked on Saturday)

OSH (Overtime is required for every hour worked on Sunday and Holidays)

H/W (Health & Welfare Insurance)

Pensn (Pension)

Vac (Vacation)

Trng (Training)

Explanations

MASSAC COUNTY

The following list is considered as those days for which holiday rates of wages for work performed apply: New Years Day, Memorial Day, Fourth of July, Labor Day, Thanksgiving Day, Christmas Day and Veterans Day in some classifications/counties. Generally, any of these holidays which fall on a Sunday is celebrated on the following Monday. This then makes work performed on that Monday payable at the appropriate overtime rate for holiday pay. Common practice in a given local may alter certain days of celebration. If in doubt, please check with IDOL.

Oil and chip resealing (O&C) means the application of road oils and liquid asphalt to coat an existing road surface, followed by application of aggregate chips or gravel to coated surface, and subsequent rolling of material to seal the surface.

EXPLANATION OF CLASSES

ASBESTOS - GENERAL - removal of asbestos material/mold and hazardous materials from any place in a building, including mechanical systems where those mechanical systems are to be removed. This includes the removal of asbestos materials/mold and hazardous materials from ductwork or pipes in a building when the building is to be demolished

at the time or at some close future date.

ASBESTOS - MECHANICAL - removal of asbestos material from mechanical systems, such as pipes, ducts, and boilers, where the mechanical systems are to remain.

LABORER - OIL AND CHIP RESEALING ONLY

Hook and unhook chip box from aggregate truck; distribute material within chip box; perform flagging work related to oil and chip resealing; hand spray oil fluids; handle traffic control, including setting-up and maintaining barricades, drums, cones, delineators, signs and other such items, as well as laying-out and applying or removing temporary roadway markings used to control traffic in job site related to oil and chip resealing; and perform clean-up related to oil and chip resealing.

CERAMIC TILE FINISHER, MARBLE FINISHER, TERRAZZO FINISHER

Assisting, helping or supporting the tile, marble and terrazzo mechanic by performing their historic and traditional work assignments required to complete the proper installation of the work covered by said crafts. The term "Ceramic" is used for naming the classification only, and is in no a limitation of the product handled. Ceramic takes into consideration most hard tiles.

ELECTRIC POWER LINEMAN

Construction, maintenance and dismantling of overhead and underground electric power lines, including high voltage pipe type cable work, and associated structures and equipment.

ELECTRIC POWER EQUIPMENT OPERATOR - CLASS 1

Operation of all crawler type equipment D-4 and larger from the ground to assist the Electric Power Linemen in performing their duties.

ELECTRIC POWER EQUIPMENT OPERATORS - CLASS 2

Operation of all other equipment from the ground to assist the Electric Power Linemen in performing their duties.

ELECTRIC POWER GROUNDMAN

Applies to workers who assist the Electric Power Lineman from the ground.

ELECTRONIC SYSTEMS TECHNICIAN

Installation, service and maintenance of low-voltage systems which utilizes the transmission and/or transference of voice, sound, vision, or digital for commercial, education, security and entertainment purposes for the following: TV monitoring and surveillance, background/foreground music, intercom and telephone interconnect, field programming, inventory control systems, microwave transmission, multi-media, multiplex, radio page, school, intercom and sound burglar alarms and low voltage master clock systems.

Excluded from this classification are energy management systems, life safety systems, supervisory controls and data acquisition systems not intrinsic with the above listed systems, fire alarm systems, nurse call systems and raceways exceeding fifteen feet in length.

TRUCK DRIVER - BUILDING, HEAVY AND HIGHWAY CONSTRUCTION

Class 1. Drivers on 2 axle trucks hauling less than 9 ton. Air

compressor and welding machines and brooms, including those pulled by separate units, truck driver helpers, warehouse employees, mechanic helpers, greasers and tiremen, pickup trucks when hauling materials, tools, or workers to and from and on-the-job site, and fork lifts up to 6,000 lb. capacity.

Class 2. Two or three axle trucks hauling more than 9 ton but hauling less than 16 ton. A-frame winch trucks, hydrolift trucks, vactor trucks or similar equipment when used for transportation purposes. Fork lifts over 6,000 lb. capacity, winch trucks, four axle combination units, and ticket writers.

Class 3. Two, three or four axle trucks hauling 16 ton or more. Drivers on water pulls, articulated dump trucks, mechanics and working forepersons, and dispatchers. Five axle or more combination units.

Class 4. Low Boy and Oil Distributors.

Class 5. Drivers who require special protective clothing while employed on hazardous waste work.

TRUCK DRIVER - O & C (Oil and Chip Resealing ONLY)

It involves driving of contractor or subcontractor owned, leased, or hired pickup, dump, service, or oil distributor trucks. Includes transporting materials and equipment (including, but not limited to oils, aggregate supplies, parts, machinery and tools) to or from the job site; distributing oil or liquid asphalt and aggregate; stock piling material; and maintaining trucks at job site related to oil and chip resealing.

Class 1. Distributors, liquid asphalt hauling and hauling of asphalt rubber-tired rollers.

Class 2. Stockpiling.

Class 3. Tandem hauling to job site.

OPERATING ENGINEERS - BUILDING, HEAVY AND HIGHWAY CONSTRUCTION

Class 1. APSCO or Equal Spreading Machine, Backhoe, Backfiller, Boom or Winch Cat, Bituminous Mixplane Machine, Blacksmith, Bituminous Surfacing Machine, Bull-Dozer, Crane, Shovel, Dragline, Truck Crane, Pile Driver, Concrete Breaker, Concrete or Pumpcrete Pumps, Dinky or Standard Locomotives, Well or Caisson Drills, Elevating Grader, Fork Lifts, Flexplane, Gradeall, Hi-Lift Hoists, Guy-Derricks, Hysters, Mechanic Motor Patrol, Mixers-21 cu. ft. or over, Push Cats, Pulls and Scrapers, Two Well Point Pumps, Pulverizer or Tiller, PugMill, Rubber-Tired Farm Type Tractor with Bulldozer/Blade/Auger or hi-lift over 1/2 yd., Jersey Spreader, Tract-Air used with Drill or Hi-Lift, Trenching or Ditching Machines, Wood Chipper w/Tractor, Self-Propelled Roller w/Blade, Equipment Greaser, Self-Propelled Bump Grinder on Concrete pavement, Boat Operator, Skid-Loaders, Tuggers, Lazer Screed, and Self-Propelled Chip Spreader (when others run conveyors).

Class 2. Any type tractor pulling any type roller or disc, Two Air Compressors (220 cu. ft. capacity or over), Two AirTract Drills, Air-Track Drill w/Compressor, Automatic Bins or Scales w/Compressor or Generator, Pipeline Boring Machine, Bulk Cement Plant w/Separate Compressor, Power Operated Bull Float, Hydra-Lift w/Single Motor, Straw Mulcher Blower w/Spout, Self-Propelled Roller/Compactor, Back-End man on Bituminous Surfacing Machine, oiler on milling machine.

Class 3. Air Compressor w/Valve driving piling, Boom or Winch Type Truck, Two Conveyors, Self-Propelled Concrete Saw, Form Grader, Truck

Crane Oiler, Self-Propelled Vibrator, Rubber Tired Farm Type Tractor w/Blade/Bulldozer/Auger/hi-lift - 1/2 yd. or less, Elevator Operator, Man Lift (scissor lift) when lifting materials.

Class 4. Air-Track Drill (one), Belt Drag Machine, Power Broom, Mechanical Plasterer Applicator, Trac-Air, Air Compressor (220 cu. ft. or over) One, Air Compressor (under 220 cu. ft) four, Automatic Bin, Bulk Cement Plant w/Built-in Compressor running off same motor or electric motor, Fireman or Switchman, Self-Propelled Form Tamper, Light Plants (4), Welding Machines (4), Pumps (4), or Combination of four (4) Pumps, Light Plants, Welding Machines, Air-Compressors (under 220 cu. ft.), Mudjacks or Wood Chipper, Mixers - less than 21 cu. ft. Mortar Mixer w/Skip or Pump, Pipeline Tract Jack. One Operating Engineer may operate and maintain any combination of the following pieces of equipment, not to exceed four (4) which shall be within a reasonable distance, such combination may include any equipment in this classification: (Compressors, Light Plants, Generators, Welding Machines, Pumps or Conveyors), One Well- Point Pump, Two Motor Driven Heaters, One Air Compressor (under 220 cu. ft.), One Engine-Driven Conveyor, One Motor Driven Heater, One Light Plant, One Pump, One Welding Machine, One Ulmac or Equal Spreader, Oilers, and one Generator 10 kw or greater.

OPERATING ENGINEER - O & C (Oil and Chip Resealing ONLY). Includes the operation of all motorized heavy equipment used in oil and chip resealing, including but not limited to operating self-propelled chip spreaders, and all types of rollers (both hard and rubber tired); and other duties pertaining to the operation or maintenance of heavy equipment related to oil and chip resealing.

Class 1. See Class 1 above for types of equipment operated.

Class 2. See Class 2 above for types of equipment operated.

Class 3. See Class 3 above for types of equipment operated.

Class 4. See Class 4 above for types of equipment operated.

OPERATING ENGINEER RIVER WORK 1 - operate the following machines when working on River Work and Levee Work on the Mississippi and Ohio Rivers, Lakes and Tributaries: Crane, Shovel, Drageline, Scrapers, Dredge, Derrick, Pile-Driver, Push Boat, all power boat operators, Mechanic, Engineman on Dredge, Leverman on Dredge, All Bituminous Spreader machines, Backhoe, Backfiller, Boom, or Winch Cat, Bituminous Mixplane Machine, Blacksmith, Bituminous Surfacing Machine, Bulldozer, Truck Cranes, Hydraulic Truck Mounted Boom/Crane, Concrete Finishing Machine, or Spreader Machine, Concrete Breaker, Concrete or Pumpcrete Machines, Concrete Plant Operator, All Off Road Material Hauling Equipment, Dinky or Standard Locomotives, Well Drill, Elevating Grader, Fork-Lifts, Flexplane, Gradeall, Hi-Lift, Power Handblade Tugger type Hoist, Hoist Two Drum (or over one), Gyderrick, Hyster, Motor Patrol, Mixers - 21 Cu. Ft. or over, Push Cat, Pulls, & Scrapers, Pumps-Two Well Points, Equipment Greaser, P & H Pulverizer or Pulverizer equal to Pugmill, Pugmill, Rubber-Tired farm type tractor w/Bulldozer/Blade/Auger or Hi-Lift over ½ yard, Skimmer Scoops, Seaman Tiller, Jersey Spreader, Tract-Air used with Drill or Hi-Lift, Trenching or Ditching Machine, Wood Chipper w/Tractor, self-propelled roller w/Blade, Concrete Pumps and Small Equipment Operators.

OPERATING ENGINEER RIVER 2 - when working on River Work and Levee Work on the Mississippi and Ohio Rivers, Lakes and Tributaries shall be employed as the Oiler or Fireman on Crane, Dragline, Shovel, Dredge, Truck Crane, Pile Driver, Gradeall, Dinky or Standard Locomotive, Guy

Derrick, Trenching Machine or Ditching Machine 80 H.P. and over, All Terrain (cherry-picker) with over 40 ton Lifting Capacity, Deck Oiler and Deckhands.

Other Classifications of Work:

For definitions of classifications not otherwise set out, the Department generally has on file such definitions which are available. If a task to be performed is not subject to one of the classifications of pay set out, the Department will upon being contacted state which neighboring county has such a classification and provide such rate, such rate being deemed to exist by reference in this document. If no neighboring county rate applies to the task, the Department shall undertake a special determination, such special determination being then deemed to have existed under this determination. If a project requires these, or any classification not listed, please contact IDOL at 217-782-1710 for wage rates or clarifications.

LANDSCAPING

Landscaping work falls under the existing classifications for laborer, operating engineer and truck driver. The work performed by landscape plantsman and landscape laborer is covered by the existing classification of laborer. The work performed by landscape operators (regardless of equipment used or its size) is covered by the classifications of operating engineer. The work performed by landscape truck drivers (regardless of size of truck driven) is covered by the classifications of truck driver.

McDonough County Prevailing Wage for May 2013

(See explanation of column headings at bottom of wages)

Trade Name	RG	TYP	C	Base	FRMAN	M-F>8	OSA	OSH	H/W	Pensn	Vac	Trng
=====	==	===	=	=====	=====	=====	===	===	=====	=====	=====	=====
ASBESTOS ABT-GEN		BLD		27.060	27.810	1.5	1.5	2.0	7.550	10.63	0.000	0.800
ASBESTOS ABT-GEN		HWY		24.600	25.600	1.5	1.5	2.0	7.550	11.50	0.000	0.800
ASBESTOS ABT-MEC		BLD		20.500	21.500	1.5	1.5	2.0	6.250	3.500	0.000	0.000
BOILERMAKER		BLD		35.010	38.010	2.0	2.0	2.0	7.070	13.83	0.000	0.300
BRICK MASON		BLD		29.250	30.250	1.5	1.5	2.0	8.200	8.330	0.000	0.580
CARPENTER		BLD		29.400	31.650	1.5	1.5	2.0	7.450	13.63	0.000	0.520
CARPENTER		HWY		31.150	33.400	1.5	1.5	2.0	7.450	13.61	0.000	0.520
CEMENT MASON		BLD		25.200	26.700	1.5	1.5	2.0	6.600	12.10	0.000	0.500
CEMENT MASON		HWY		27.280	28.280	1.5	1.5	2.0	6.600	9.420	0.000	0.500
CERAMIC TILE FNSHER		BLD		25.600	0.000	1.5	1.5	2.0	8.200	7.230	0.000	0.000
ELECTRIC PWR EQMT OP		ALL		35.440	0.000	1.5	1.5	2.0	5.000	10.98	0.000	0.270
ELECTRIC PWR GRNDMAN		ALL		24.320	0.000	1.5	1.5	2.0	5.000	7.540	0.000	0.180
ELECTRIC PWR LINEMAN		ALL		39.370	41.910	1.5	1.5	2.0	5.000	12.20	0.000	0.300
ELECTRIC PWR TRK DRV		ALL		25.510	0.000	1.5	1.5	2.0	5.000	7.920	0.000	0.190
ELECTRICIAN	N	BLD		30.190	32.690	1.5	1.5	2.0	5.350	9.390	0.000	0.400
ELECTRICIAN	S	BLD		28.360	30.860	1.5	1.5	2.0	5.350	8.550	0.000	0.400
ELECTRONIC SYS TECH		BLD		27.430	29.180	1.5	1.5	2.0	5.350	9.320	0.000	0.400
ELEVATOR CONSTRUCTOR		BLD		40.520	45.585	2.0	2.0	2.0	11.88	12.71	3.240	0.600
GLAZIER		BLD		30.770	32.770	1.5	1.5	2.0	9.700	7.700	0.000	1.250
HT/FROST INSULATOR		BLD		29.190	30.390	1.5	1.5	2.0	5.420	12.05	0.000	0.900
IRON WORKER		ALL		24.440	25.690	1.5	1.5	2.0	7.010	9.890	0.000	0.570
LABORER		BLD		25.560	26.310	1.5	1.5	2.0	7.550	10.63	0.000	0.800
LABORER		HWY		24.600	25.600	1.5	1.5	2.0	7.550	11.50	0.000	0.800
LATHER		BLD		29.400	31.650	1.5	1.5	2.0	7.450	13.63	0.000	0.520
MACHINIST		BLD		43.550	46.050	1.5	1.5	2.0	6.130	8.950	1.850	0.000
MARBLE FINISHERS		BLD		25.600	0.000	1.5	1.5	2.0	8.200	7.230	0.000	0.000
MARBLE MASON		BLD		27.100	27.850	1.5	1.5	2.0	8.200	7.230	0.000	0.000

MILLWRIGHT	BLD		30.240	32.490	1.5	1.5	2.0	7.450	13.09	0.000	0.520
MILLWRIGHT	HWY		31.820	34.070	1.5	1.5	2.0	7.450	13.44	0.000	0.520
OPERATING ENGINEER	BLD	1	36.000	39.000	1.5	1.5	2.0	9.750	13.60	0.000	3.000
OPERATING ENGINEER	BLD	2	33.490	39.000	1.5	1.5	2.0	9.750	13.60	0.000	3.000
OPERATING ENGINEER	BLD	3	29.340	39.000	1.5	1.5	2.0	9.750	13.60	0.000	3.000
OPERATING ENGINEER	HWY	1	36.000	39.500	1.5	1.5	2.0	9.750	13.60	0.000	3.000
OPERATING ENGINEER	HWY	2	33.490	39.500	1.5	1.5	2.0	9.750	13.60	0.000	3.000
OPERATING ENGINEER	HWY	3	29.340	39.500	1.5	1.5	2.0	9.750	13.60	0.000	3.000
PAINTER	ALL		32.900	34.900	1.5	1.5	1.5	9.650	8.200	0.000	1.250
PILEDRIVER	BLD		29.900	32.150	1.5	1.5	2.0	7.450	13.63	0.000	0.520
PILEDRIVER	HWY		32.150	34.400	1.5	1.5	2.0	7.450	13.61	0.000	0.520
PIPEFITTER	BLD		37.400	41.510	1.5	1.5	2.0	7.000	11.63	0.000	1.060
PLASTERER	BLD		28.500	30.250	1.5	1.5	2.0	7.330	11.29	0.000	0.500
PLUMBER	BLD		33.570	36.590	1.5	1.5	2.0	7.000	13.31	0.000	0.900
ROOFER	BLD		28.580	30.010	1.5	1.5	2.0	8.450	7.220	0.000	0.250
SHEETMETAL WORKER	BLD		30.070	32.070	1.5	1.5	2.0	7.140	10.54	0.000	0.540
SPRINKLER FITTER	BLD		36.390	39.140	1.5	1.5	2.0	8.420	8.500	0.000	0.450
STONE MASON	BLD		29.250	30.250	1.5	1.5	2.0	8.200	8.330	0.000	0.580
TERRAZZO FINISHER	BLD		25.600	0.000	1.5	1.5	2.0	8.200	7.230	0.000	0.000
TILE MASON	BLD		27.100	27.850	1.5	1.5	2.0	8.200	7.230	0.000	0.000
TRUCK DRIVER	ALL	1	31.230	0.000	1.5	1.5	2.0	10.30	4.840	0.000	0.250
TRUCK DRIVER	ALL	2	31.680	0.000	1.5	1.5	2.0	10.30	4.840	0.000	0.250
TRUCK DRIVER	ALL	3	31.890	0.000	1.5	1.5	2.0	10.30	4.840	0.000	0.250
TRUCK DRIVER	ALL	4	32.180	0.000	1.5	1.5	2.0	10.30	4.840	0.000	0.250
TRUCK DRIVER	ALL	5	33.020	0.000	1.5	1.5	2.0	10.30	4.840	0.000	0.250
TRUCK DRIVER	O&C	1	24.980	0.000	1.5	1.5	2.0	10.30	4.840	0.000	0.250
TRUCK DRIVER	O&C	2	25.340	0.000	1.5	1.5	2.0	10.30	4.840	0.000	0.250
TRUCK DRIVER	O&C	3	25.510	0.000	1.5	1.5	2.0	10.30	4.840	0.000	0.250
TRUCK DRIVER	O&C	4	25.740	0.000	1.5	1.5	2.0	10.30	4.840	0.000	0.250
TRUCK DRIVER	O&C	5	26.420	0.000	1.5	1.5	2.0	10.30	4.840	0.000	0.250
TUCKPOINTER	BLD		29.250	30.250	1.5	1.5	2.0	8.200	8.330	0.000	0.580

Legend :

RG (Region)

TYP (Trade Type - All,Highway,Building,Floating,Oil & Chip,Rivers)

C (Class)

Base (Base Wage Rate)

FRMAN (Foreman Rate)

M-F>8 (OT required for any hour greater than 8 worked each day, Mon through Fri.

OSA (Overtime (OT) is required for every hour worked on Saturday)

OSH (Overtime is required for every hour worked on Sunday and Holidays)

H/W (Health & Welfare Insurance)

Pensn (Pension)

Vac (Vacation)

Trng (Training)

Explanations

ELECTRICIANS (NORTH) - Blandinville, Bushnell, Chalmers, Colchester, Emmet, Hire, Macomb, Mound, New Sales, Prairie City, Scotland, Sciota, Tennessee, and Walnut Grove.

ELECTRICIANS (SOUTH) - Bethel, Eldorado, Industry and Lamoine.

The following list is considered as those days for which holiday rates of wages for work performed apply: New Years Day, Memorial Day, Fourth of July, Labor Day, Thanksgiving Day, Christmas Day and Veterans Day in some classifications/counties. Generally, any of these holidays which fall on a Sunday is celebrated on the following Monday. This then makes work performed on that Monday payable at the appropriate overtime rate for holiday pay. Common practice in a given local may alter certain days of celebration. If in doubt, please check with IDOL.

Oil and chip resealing (O&C) means the application of road oils and liquid asphalt to coat an existing road surface, followed by application of aggregate chips or gravel to coated surface, and subsequent rolling of material to seal the surface.

EXPLANATION OF CLASSES

ASBESTOS - GENERAL - removal of asbestos material/mold and hazardous materials from any place in a building, including mechanical systems where those mechanical systems are to be removed. This includes the removal of asbestos materials/mold and hazardous materials from ductwork or pipes in a building when the building is to be demolished at the time or at some close future date.

ASBESTOS - MECHANICAL - removal of asbestos material from mechanical systems, such as pipes, ducts, and boilers, where the mechanical systems are to remain.

CERAMIC TILE FINISHER, MARBLE FINISHER, TERRAZZO FINISHER

Assisting, helping or supporting the tile, marble and terrazzo mechanic by performing their historic and traditional work assignments required to complete the proper installation of the work covered by said crafts. The term "Ceramic" is used for naming the classification only and is in no way a limitation of the product handled. Ceramic takes into consideration most hard tiles.

ELECTRONIC SYSTEMS TECHNICIAN

Installation, service and maintenance of low-voltage systems which utilizes the transmission and/or transference of voice, sound, vision, or digital for commercial, education, security and entertainment purposes for the following: TV monitoring and surveillance, background/foreground music, intercom and telephone interconnect, field programming, inventory control systems, microwave transmission, multi-media, multiplex, radio page, school, intercom and sound burglar alarms and low voltage master clock systems.

Excluded from this classification are energy management systems, life safety systems, supervisory controls and data acquisition systems not intrinsic with the above listed systems, fire alarm systems, nurse call systems and raceways exceeding fifteen feet in length.

TRUCK DRIVER - BUILDING, HEAVY AND HIGHWAY CONSTRUCTION

Class 1. Drivers on 2 axle trucks hauling less than 9 ton. Air compressor and welding machines and brooms, including those pulled by separate units, truck driver helpers, warehouse employees, mechanic helpers, greasers and tiremen, pickup trucks when hauling materials,

tools, or workers to and from and on-the-job site, and fork lifts up to 6,000 lb. capacity.

Class 2. Two or three axle trucks hauling more than 9 ton but hauling less than 16 ton. A-frame winch trucks, hydrolift trucks, vactor trucks or similar equipment when used for transportation purposes. Fork lifts over 6,000 lb. capacity, winch trucks, four axle combination units, and ticket writers.

Class 3. Two, three or four axle trucks hauling 16 ton or more. Drivers on water pulls, articulated dump trucks, mechanics and working forepersons, and dispatchers. Five axle or more combination units.

Class 4. Low Boy and Oil Distributors.

Class 5. Drivers who require special protective clothing while employed on hazardous waste work.

TRUCK DRIVER - OIL AND CHIP RESEALING ONLY.

This shall encompass laborers, workers and mechanics who drive contractor or subcontractor owned, leased, or hired pickup, dump, service, or oil distributor trucks. The work includes transporting materials and equipment (including but not limited to, oils, aggregate supplies, parts, machinery and tools) to or from the job site; distributing oil or liquid asphalt and aggregate; stock piling material when in connection with the actual oil and chip contract. The Truck Driver (Oil & Chip Resealing) wage classification does not include supplier delivered materials.

OPERATING ENGINEERS - BUILDING

Class 1. Cranes; Overhead Cranes; Gradall; All Cherry Pickers; Mechanics; Central Concrete Mixing Plant Operator; Road Pavers (27E - Dual Drum - Tri Batchers); Blacktop Plant Operators and Plant Engineers; 3 Drum Hoist; Derricks; Hydro Cranes; Shovels; Skimmer Scoops; Koehring Scooper; Drag Lines; Backhoe; Derrick Boats; Pile Drivers and Skid Rigs; Clamshells; Locomotive Cranes; Dredge (all types) Motor Patrol; Power Blades - Dumore - Elevating and similar types; Tower Cranes (Crawler-Mobile) and Stationary; Crane-type Backfiller; Drott Yumbo and similar types considered as Cranes; Caisson Rigs; Dozer; Tournadozer; Work Boats; Ross Carrier; Helicopter; Tournapulls - all and similar types; Scoops (all sizes); Pushcats; Endloaders (all types); Asphalt Surfacing Machine; Slip Form Paver; Rock Crusher; Heavy Equipment Greaser; CMI, CMI Belt Placer, Auto Grade & 3 Track and similar types; Side Booms; Multiple Unit Earth Movers; Creter Crane; Trench Machine; Pump-crete-Belt Crete-Squeeze Cretes-Screw-type Pumps and Gypsum; Bulker & Pump - Operator will clean; Formless Finishing Machine; Flaherty Spreader or similar types; Screed Man on Laydown Machine; Wheel Tractors (industrial or Farm-type w/Dozer-Hoe-Endloader or other attachments); F.W.D. & Similar Types; Vermeer Concrete Saw.

Class 2. Dinkeys; Power Launches; PH One-pass Soil Cement Machine (and similar types); Pugmill with Pump; Backfillers; Euclid Loader; Forklifts; Jeeps w/Ditching Machine or other attachments; Tuneluger; Automatic Cement and Gravel Batching Plants; Mobile Drills (Soil Testing) and similar types; Gurries and Similar Types; (1) and (2) Drum Hoists (Buck Hoist and Similar Types); Chicago Boom; Boring Machine & Pipe Jacking Machine; Hydro Boom; Dewatering System; Straw Blower; Hydro Seeder; Assistant Heavy Equipment Greaser on Spread; Tractors (Track type) without Power Unit pulling Rollers; Rollers on Asphalt -- Brick Macadem; Concrete Breakers; Concrete Spreaders; Mule Pulling Rollers; Center Stripper; Cement Finishing Machines & CMI

Texture & Reel Curing Machines; Cement Finishing Machine; Barber Green or similar loaders; Vibro Tamper (All similar types) Self-propelled; Winch or Boom Truck; Mechanical Bull Floats; Mixers over 3 Bag to 27E; Tractor pulling Power Blade or Elevating Grader; Porter Rex Rail; Clary Screed; Truck Type Hoptoe Oilers; Fireman; Spray Machine on Paving; Curb Machines; Truck Crane Oilers; Oil Distributor; Truck-Mounted Saws.

Class 3. Air Compressor; Power Subgrader; Straight Tractor; Trac Air without attachments; Herman Nelson Heater, Dravo, Warner, Silent Glo, and similar types; Roller: Five (5) Ton and under on Earth or Gravel; Form Grader; Crawler Crane & Skid Rig Oilers; Freight Elevators - permanently installed; Pump; Light Plant; Generator; Conveyor (1) or (2) - Operator will clean; Welding Machine; Mixer (3) Bag and Under (Standard Capacity with skip); Bulk Cement Plant; Oiler on Central Concrete Mixing Plant.

OPERATING ENGINEERS - HEAVY AND HIGHWAY CONSTRUCTION

CLASS 1. Cranes; Hydro Cranes; Shovels; Crane Type Backfiller; Tower, Mobile, Crawler, & Stationary Cranes; Derricks; Hoists (3 Drum); Draglines; Drott Yumbo & Similar Types considered as Cranes; 360 Degree Swing Excavator (Shears, Grapples, Movacs, etc.); Back Hoe; Derrick Boats; Pile Driver and Skid Rigs; Clam Shell; Locomotive - Cranes; Road Pavers - Single Drum - Dual Drum - Tri Batcher; Motor Patrols & Power Blades - Dumore - Elevating & Similar Types; Mechanics; Central Concrete Mixing Plant Operator; Asphalt Batch Plant Operators and Plant Engineers; Gradall; Caisson Rigs; Skimmer Scoop - Koering Scooper; Dredges (all types); Hoptoe; All Cherry Pickers; Work Boat; Ross Carrier; Helicopter; Dozer; Tournadozer; Tournapulls - all and similar types; Operation of Concrete and all Recycle Machines; Multiple Unit Earth Movers; Scoops (all sizes); Pushcats; Endloaders (all types); Asphalt Surfacing Machine; Slip Form Paver; Rock Crusher; Operation of Material Crusher, Screening Plants, and Tunnel Boring Machine; Heavy Equipment Greaser (top greaser on spread); CMI, Auto Grade, CMI Belt Placer & 3 Track and Similar Types; Side Booms; Asphalt Heater & Planer Combination (used to plane streets); Wheel Tractors (with Dozer, Hoe or Endloader Attachments); CAT Earthwork Compactors and Similar Types; Blaw Knox Spreader and Similar Types; Trench Machines; Pump Crete - Belt Crete - Squeeze Crete - Screw Type Pumps and Gypsum (operator will clean); Creter Crane; Operation of Concrete Pump Truck; Formless Finishing Machines; Flaherty Spreader or Similar Types; Screed Man on Laydown Machine; Vermeer Concrete Saw; Operation of Laser Screed; Span Saw; Dredge Leverman; Dredge Engineer; Lull or Similar Type; Hydro-Boom Truck; Operation of Guard Rail Machine; and Starting Engineer on Pipeline or Construction (11 or more pieces) including: Air Compressor (Trailer Mounted), All Forced Air Heaters (regardless of Size), Water Pumps (Greater than 4-1/2" or Total Discharge Over 4-1/2"), Light Plants, Generators (Trailer Mounted - Excluding Decontamination Trailer), Welding Machines (Any Size or Mode of Power), Conveyor, Mixer (any size), Stud Welder, Power Pac, etc, and Ground Heater (Trailer Mounted).

CLASS 2. Bulker & Pump; Power Launches; Boring Machine & Pipe Jacking Machine; Dinkeys; Operation of Carts, Powered Haul Unit for a Boring Machine; P & H One Pass Soil Cement Machines and Similar Types; Wheel Tractors (Industry or Farm Type - Other); Back Fillers; Euclid Loader; Fork Lifts; Jeep w/Ditching Machine or Other Attachments; Tunneluger; Automatic Cement & Gravel Batching Plants; Mobile Drills - Soil Testing and Similar Types; Pugmill with Pump; All (1) and (2) Drum Hoists; Dewatering System; Straw Blower; Hydro-Seeder; Bump Grinders (self-propelled); Assistant Heavy Equipment Greaser; Apsco Spreader; Tractors (Track-Type) without Power Units Pulling Rollers; Rollers on Asphalt - Brick or Macadam; Concrete Breakers; Concrete Spreaders;

Cement Strippers; Cement Finishing Machines & CMI Texture & Reel Curing Machines; Vibro-Tampers (All Similar Types Self-Propelled); Mechanical Bull Floats; Self-Propelled Concrete Saws; Truck Mounted Power Saws; Operation of Curb Cutters; Mixers - Over Three (3) Bags; Winch and Boom Trucks; Tractor Pulling Power Blade or Elevating Grader; Porter Rex Rail; Clary Screed; Mule Pulling Rollers; Pugmill without Pump; Barber Greene or Similar Loaders; Track Type Tractor w/Power Unit attached (minimum); Fireman; Spray Machine on Paving; Curb Machines; Paved Ditch Machine; Power Broom; Self-Propelled Sweepers; Self-Propelled Conveyors; Power Subgrader; Oil Distributor; Straight Tractor; Truck Crane Oiler; Truck Type Oilers; Directional Boring Machine; Horizontal Directional Drill; Articulating End Dump Vehicles; Starting Engineer on Pipeline or Construction (6 -10 pieces) including: Air Compressor (Trailer Mounted), All Forced Air Heaters (regardless of Size), Water Pumps (Greater than 4-1/2" or Total Discharge Over 4-1/2"), Light Plants, Generators (Trailer Mounted - Excluding Decontamination Trailer), Welding Machines (Any Size or Mode of Power), Conveyor, Mixer (any size), Stud Welder, Power Pac, etc., and Ground Heater (Trailer Mounted).

CLASS 3. Straight Framed Truck Mounted Vac Unit (separately powered); Trac Air Machine (without attachments); Rollers - Five Ton and Under on Earth and Gravel; Form Graders; Bulk Cement Plant; Oilers; and Starting Engineer on Pipeline or Construction (3 - 5 pieces) including: Air Compressor (Trailer Mounted), All Forced Air Heaters (regardless of Size), Water Pumps (Greater than 4-1/2" or Total Discharge Over 4-1/2"), Light Plants, Generators (Trailer Mounted - Excluding Decontamination Trailer), Welding Machines (Any Size or Mode of Power), Conveyor, Mixer (any size), Stud Welder, Power Pac, etc., and Ground Heater (Trailer Mounted).

Other Classifications of Work:

For definitions of classifications not otherwise set out, the Department generally has on file such definitions which are available. If a task to be performed is not subject to one of the classifications of pay set out, the Department will upon being contacted state which neighboring county has such a classification and provide such rate, such rate being deemed to exist by reference in this document. If no neighboring county rate applies to the task, the Department shall undertake a special determination, such special determination being then deemed to have existed under this determination. If a project requires these, or any classification not listed, please contact IDOL at 217-782-1710 for wage rates or clarifications.

LANDSCAPING

Landscaping work falls under the existing classifications for laborer, operating engineer and truck driver. The work performed by landscape plantsman and landscape laborer is covered by the existing classification of laborer. The work performed by landscape operators (regardless of equipment used or its size) is covered by the classifications of operating engineer. The work performed by landscape truck drivers (regardless of size of truck driven) is covered by the classifications of truck driver.

Mchenry County Prevailing Wage for May 2013

(See explanation of column headings at bottom of wages)

Trade Name	RG	TYP	C	Base	FRMAN	M-F>8	OSA	OSH	H/W	Pensn	Vac	Trng
=====	==	=	=	=====	=====	=====	==	==	=====	=====	=====	=====
ASBESTOS ABT-GEN		ALL		36.200	36.700	1.5	1.5	2.0	12.78	9.020	0.000	0.500

ASBESTOS ABT-MEC		BLD	34.160	36.660	1.5	1.5	2.0	10.82	10.66	0.000	0.720
BOILERMAKER		BLD	43.450	47.360	2.0	2.0	2.0	6.970	14.66	0.000	0.350
BRICK MASON		BLD	40.680	44.750	1.5	1.5	2.0	9.550	12.00	0.000	0.970
CARPENTER		ALL	41.520	43.520	1.5	1.5	2.0	13.19	11.76	0.000	0.530
CEMENT MASON		ALL	41.550	43.550	2.0	1.5	2.0	9.500	13.76	0.000	0.500
CERAMIC TILE FNSHER		BLD	34.440	0.000	2.0	1.5	2.0	9.700	6.930	0.000	0.610
COMMUNICATION TECH		BLD	35.770	37.870	1.5	1.5	2.0	12.07	9.370	0.000	0.450
ELECTRIC PWR EQMT OP		ALL	36.610	49.750	1.5	1.5	2.0	5.000	11.35	0.000	0.270
ELECTRIC PWR GRNDMAN		ALL	28.310	49.750	1.5	1.5	2.0	5.000	8.780	0.000	0.210
ELECTRIC PWR LINEMAN		ALL	43.830	49.750	1.5	1.5	2.0	5.000	13.58	0.000	0.330
ELECTRIC PWR TRK DRV		ALL	29.310	49.750	1.5	1.5	2.0	5.000	9.090	0.000	0.220
ELECTRICIAN		ALL	43.080	47.380	1.5	1.5	2.0	12.06	11.41	0.000	0.540
ELEVATOR CONSTRUCTOR		BLD	49.080	55.215	2.0	2.0	2.0	11.88	12.71	3.930	0.600
FENCE ERECTOR	E	ALL	33.740	35.740	1.5	1.5	2.0	12.61	10.18	0.000	0.250
FENCE ERECTOR	S	ALL	44.950	47.200	2.0	2.0	2.0	8.890	17.69	0.000	0.400
GLAZIER		BLD	39.500	41.000	1.5	2.0	2.0	11.99	14.30	0.000	0.840
HT/FROST INSULATOR		BLD	45.550	48.050	1.5	1.5	2.0	10.82	11.86	0.000	0.720
IRON WORKER	E	ALL	40.750	42.750	2.0	2.0	2.0	13.20	19.09	0.000	0.350
IRON WORKER	S	ALL	44.950	47.200	2.0	2.0	2.0	8.890	17.69	0.000	0.400
IRON WORKER	W	ALL	35.090	36.840	2.0	2.0	2.0	8.250	20.59	0.000	0.700
LABORER		ALL	36.200	36.950	1.5	1.5	2.0	12.52	9.280	0.000	0.500
LATHER		ALL	41.520	43.520	1.5	1.5	2.0	13.19	11.76	0.000	0.530
MACHINIST		BLD	43.550	46.050	1.5	1.5	2.0	6.130	8.950	1.850	0.000
MARBLE FINISHERS		ALL	29.700	0.000	1.5	1.5	2.0	9.550	11.75	0.000	0.620
MARBLE MASON		BLD	39.880	43.870	1.5	1.5	2.0	9.550	11.75	0.000	0.730
MATERIAL TESTER I		ALL	26.200	0.000	1.5	1.5	2.0	12.52	9.280	0.000	0.500
MATERIALS TESTER II		ALL	31.200	0.000	1.5	1.5	2.0	12.52	9.280	0.000	0.500
MILLWRIGHT		ALL	41.520	43.520	1.5	1.5	2.0	13.19	11.76	0.000	0.530
OPERATING ENGINEER		BLD 1	45.100	49.100	2.0	2.0	2.0	15.70	10.55	1.900	1.250
OPERATING ENGINEER		BLD 2	43.800	49.100	2.0	2.0	2.0	15.70	10.55	1.900	1.250
OPERATING ENGINEER		BLD 3	41.250	49.100	2.0	2.0	2.0	15.70	10.55	1.900	1.250
OPERATING ENGINEER		BLD 4	39.500	49.100	2.0	2.0	2.0	15.70	10.55	1.900	1.250
OPERATING ENGINEER		BLD 5	48.850	49.100	2.0	2.0	2.0	15.70	10.55	1.900	1.250
OPERATING ENGINEER		BLD 6	46.100	49.100	2.0	2.0	2.0	15.70	10.55	1.900	1.250
OPERATING ENGINEER		BLD 7	48.100	49.100	2.0	2.0	2.0	15.70	10.55	1.900	1.250
OPERATING ENGINEER		HWY 1	43.300	47.300	1.5	1.5	2.0	15.70	10.55	1.900	1.250
OPERATING ENGINEER		HWY 2	42.750	47.300	1.5	1.5	2.0	15.70	10.55	1.900	1.250
OPERATING ENGINEER		HWY 3	40.700	47.300	1.5	1.5	2.0	15.70	10.55	1.900	1.250
OPERATING ENGINEER		HWY 4	39.300	47.300	1.5	1.5	2.0	15.70	10.55	1.900	1.250
OPERATING ENGINEER		HWY 5	38.100	47.300	1.5	1.5	2.0	15.70	10.55	1.900	1.250
OPERATING ENGINEER		HWY 6	46.300	47.300	1.5	1.5	2.0	15.70	10.55	1.900	1.250
OPERATING ENGINEER		HWY 7	44.300	47.300	1.5	1.5	2.0	15.70	10.55	1.900	1.250
ORNAMNTL IRON WORKER	E	ALL	41.800	44.300	2.0	2.0	2.0	12.86	15.81	0.000	0.550
ORNAMNTL IRON WORKER	S	ALL	44.950	47.200	2.0	2.0	2.0	8.890	17.69	0.000	0.400
PAINTER		ALL	40.880	42.880	1.5	1.5	1.5	9.650	8.200	0.000	1.250
PAINTER SIGNS		BLD	33.920	38.090	1.5	1.5	1.5	2.600	2.710	0.000	0.000
PILEDRIVER		ALL	41.520	43.520	1.5	1.5	2.0	13.19	11.76	0.000	0.530
PIPEFITTER		BLD	45.050	48.050	1.5	1.5	2.0	8.460	14.85	0.000	1.780
PLASTERER		BLD	40.250	42.670	1.5	1.5	2.0	10.85	10.94	0.000	0.550
PLUMBER		BLD	44.500	47.500	1.5	1.5	2.0	11.05	12.40	0.000	1.700
ROOFER		BLD	38.350	41.350	1.5	1.5	2.0	8.280	8.770	0.000	0.430
SHEETMETAL WORKER		BLD	42.510	44.510	1.5	1.5	2.0	10.04	12.01	0.000	0.780
SIGN HANGER		BLD	26.070	27.570	1.5	1.5	2.0	3.800	3.550	0.000	0.000
SPRINKLER FITTER		BLD	49.200	51.200	1.5	1.5	2.0	10.25	8.350	0.000	0.450
STEEL ERECTOR	E	ALL	40.750	42.750	2.0	2.0	2.0	13.20	19.09	0.000	0.350
STEEL ERECTOR	S	ALL	44.950	47.200	2.0	2.0	2.0	8.890	17.69	0.000	0.400
STONE MASON		BLD	40.680	44.750	1.5	1.5	2.0	9.550	12.00	0.000	0.970
TERRAZZO FINISHER		BLD	35.510	0.000	1.5	1.5	2.0	9.700	9.320	0.000	0.400
TERRAZZO MASON		BLD	39.370	42.370	1.5	1.5	2.0	9.700	10.66	0.000	0.550
TILE MASON		BLD	41.430	45.430	2.0	1.5	2.0	9.700	8.640	0.000	0.710
TRAFFIC SAFETY WRKR		HWY	28.250	29.850	1.5	1.5	2.0	4.896	4.175	0.000	0.000
TRUCK DRIVER		ALL 1	35.850	36.400	1.5	1.5	2.0	7.200	6.000	0.000	0.150
TRUCK DRIVER		ALL 2	36.000	36.400	1.5	1.5	2.0	7.200	6.000	0.000	0.150
TRUCK DRIVER		ALL 3	36.200	36.400	1.5	1.5	2.0	7.200	6.000	0.000	0.150
TRUCK DRIVER		ALL 4	36.400	36.400	1.5	1.5	2.0	7.200	6.000	0.000	0.150

TUCKPOINTER BLD 40.950 41.950 1.5 1.5 2.0 8.180 10.82 0.000 0.940

Legend :

RG (Region)

TYP (Trade Type - All,Highway,Building,Floating,Oil & Chip,Rivers)

C (Class)

Base (Base Wage Rate)

FRMAN (Foreman Rate)

M-F>8 (OT required for any hour greater than 8 worked each day, Mon through Fri.

OSA (Overtime (OT) is required for every hour worked on Saturday)

OSH (Overtime is required for every hour worked on Sunday and Holidays)

H/W (Health & Welfare Insurance)

Pensn (Pension)

Vac (Vacation)

Trng (Training)

Explanations

MCHENRY COUNTY

FENCE ERECTOR (EAST) - That part of the county East and Northeast of a line following Route 31 North to Route 14, northwest to Route 47 north to the Wisconsin State Line.

IRONWORKERS (EAST) - That part of the county East of Rts. 47 and 14.

IRONWORKERS (SOUTH) - That part of the county South of Route 14 and East of Route 47.

IRONWORKERS (WEST) - That part of the county West of Route 47.

The following list is considered as those days for which holiday rates of wages for work performed apply: New Years Day, Memorial Day, Fourth of July, Labor Day, Thanksgiving Day, Christmas Day and Veterans Day in some classifications/counties. Generally, any of these holidays which fall on a Sunday is celebrated on the following Monday. This then makes work performed on that Monday payable at the appropriate overtime rate for holiday pay. Common practice in a given local may alter certain days of celebration. If in doubt, please check with IDOL.

EXPLANATION OF CLASSES

ASBESTOS - GENERAL - removal of asbestos material/mold and hazardous materials from any place in a building, including mechanical systems where those mechanical systems are to be removed. This includes the removal of asbestos materials/mold and hazardous materials from ductwork or pipes in a building when the building is to be demolished

at the time or at some close future date.

ASBESTOS - MECHANICAL - removal of asbestos material from mechanical systems, such as pipes, ducts, and boilers, where the mechanical systems are to remain.

CERAMIC TILE FINISHER

The grouting, cleaning, and polishing of all classes of tile, whether for interior or exterior purposes, all burned, glazed or unglazed products; all composition materials, granite tiles, warning detectable tiles, cement tiles, epoxy composite materials, pavers, glass, mosaics, fiberglass, and all substitute materials, for tile made in tile-like units; all mixtures in tile like form of cement, metals, and other materials that are for and intended for use as a finished floor surface, stair treads, promenade roofs, walks, walls, ceilings, swimming pools, and all other places where tile is to form a finished interior or exterior. The mixing of all setting mortars including but not limited to thin-set mortars, epoxies, wall mud, and any other sand and cement mixtures or adhesives when used in the preparation, installation, repair, or maintenance of tile and/or similar materials. The handling and unloading of all sand, cement, lime, tile, fixtures, equipment, adhesives, or any other materials to be used in the preparation, installation, repair, or maintenance of tile and/or similar materials. Ceramic Tile Finishers shall fill all joints and voids regardless of method on all tile work, particularly and especially after installation of said tile work. Application of any and all protective coverings to all types of tile installations including, but not be limited to, all soap compounds, paper products, tapes, and all polyethylene coverings, plywood, masonite, cardboard, and any new type of products that may be used to protect tile installations, Blastrac equipment, and all floor scarifying equipment used in preparing floors to receive tile. The clean up and removal of all waste and materials. All demolition of existing tile floors and walls to be re-tiled.

COMMUNICATIONS TECHNICIAN

Construction, installation, maintenance and removal of telecommunication facilities (voice, sound, data and video), telephone, security systems, fire alarm systems that are a component of a multiplex system and share a common cable, and data inside wire, interconnect, terminal equipment, central offices, PABX and equipment, micro waves, V-SAT, bypass, CATV, WAN (wide area network), LAN (local area networks), and ISDN (integrated system digital network), pulling of wire in raceways, but not the installation of raceways.

MARBLE FINISHER

Loading and unloading trucks, distribution of all materials (all stone, sand, etc.), stocking of floors with material, performing all rigging for heavy work, the handling of all material that may be needed for the installation of such materials, building of scaffolding, polishing if needed, patching, waxing of material if damaged, pointing up, caulking, grouting and cleaning of marble, holding water on diamond or Carborundum blade or saw for setters cutting, use of tub saw or any other saw needed for preparation of material, drilling of holes for wires that anchor material set by setters, mixing up of molding plaster for installation of material, mixing up thin set for the installation of material, mixing up of sand to cement for the installation of material and such other work as may be required in helping a Marble Setter in the handling of all material in the erection or installation of interior marble, slate, travertine, art marble, serpentine, alberene stone, blue stone,

granite and other stones (meaning as to stone any foreign or domestic materials as are specified and used in building interiors and exteriors and customarily known as stone in the trade), carrara, sanionyx, vitrolite and similar opaque glass and the laying of all marble tile, terrazzo tile, slate tile and precast tile, steps, risers treads, base, or any other materials that may be used as substitutes for any of the aforementioned materials and which are used on interior and exterior which are installed in a similar manner.

MATERIAL TESTER I: Hand coring and drilling for testing of materials; field inspection of uncured concrete and asphalt.

MATERIAL TESTER II: Field inspection of welds, structural steel, fireproofing, masonry, soil, facade, reinforcing steel, formwork, cured concrete, and concrete and asphalt batch plants; adjusting proportions of bituminous mixtures.

OPERATING ENGINEER - BUILDING

Class 1. Asphalt Plant; Asphalt Spreader; Autograde; Backhoes with Caisson Attachment; Batch Plant; Benoto (requires Two Engineers); Boiler and Throttle Valve; Caisson Rigs; Central Redi-Mix Plant; Combination Back Hoe Front End-loader Machine; Compressor and Throttle Valve; Concrete Breaker (Truck Mounted); Concrete Conveyor; Concrete Conveyor (Truck Mounted); Concrete Paver Over 27E cu. ft; Concrete Paver 27E cu. ft. and Under; Concrete Placer; Concrete Placing Boom; Concrete Pump (Truck Mounted); Concrete Tower; Cranes, All; Cranes, Hammerhead; Cranes, (GCI and similar Type); Creter Crane; Spider Crane; Crusher, Stone, etc.; Derricks, All; Derricks, Traveling; Formless Curb and Gutter Machine; Grader, Elevating; Grouting Machines; Heavy Duty Self-Propelled Transporter or Prime Mover; Highlift Shovels or Front Endloader 2-1/4 yd. and over; Hoists, Elevators, outside type rack and pinion and similar machines; Hoists, One, Two and Three Drum; Hoists, Two Tugger One Floor; Hydraulic Backhoes; Hydraulic Boom Trucks; Hydro Vac (and similar equipment); Locomotives, All; Motor Patrol; Lubrication Technician; Manipulators; Pile Drivers and Skid Rig; Post Hole Digger; Pre-Stress Machine; Pump Cretes Dual Ram; Pump Cretes: Squeeze Cretes-Screw Type Pumps; Gypsum Bulker and Pump; Raised and Blind Hole Drill; Roto Mill Grinder; Scoops - Tractor Drawn; Slip-Form Paver; Straddle Buggies; Operation of Tie Back Machine; Tournapull; Tractor with Boom and Side Boom; Trenching Machines.

Class 2. Boilers; Broom, All Power Propelled; Bulldozers; Concrete Mixer (Two Bag and Over); Conveyor, Portable; Forklift Trucks; Highlift Shovels or Front Endloaders under 2-1/4 yd.; Hoists, Automatic; Hoists, Inside Elevators; Hoists, Sewer Dragging Machine; Hoists, Tugger Single Drum; Laser Screed; Rock Drill (Self-Propelled); Rock Drill (Truck Mounted); Rollers, All; Steam Generators; Tractors, All; Tractor Drawn Vibratory Roller; Winch Trucks with "A" Frame.

Class 3. Air Compressor; Combination Small Equipment Operator; Generators; Heaters, Mechanical; Hoists, Inside Elevators (remodeling or renovation work); Hydraulic Power Units (Pile Driving, Extracting, and Drilling); Pumps, over 3" (1 to 3 not to exceed a total of 300 ft.); Low Boys; Pumps, Well Points; Welding Machines (2 through 5); Winches, 4 Small Electric Drill Winches.

Class 4. Bobcats and/or other Skid Steer Loaders; Oilers; and Brick Forklift.

Class 5. Assistant Craft Foreman.

Class 6. Gradall.

Class 7. Mechanics; Welders.

OPERATING ENGINEERS - HIGHWAY CONSTRUCTION

Class 1. Asphalt Plant; Asphalt Heater and Planer Combination; Asphalt Heater Scarfire; Asphalt Spreader; Autograder/GOMACO or other similar type machines: ABG Paver; Backhoes with Caisson Attachment; Ballast Regulator; Belt Loader; Caisson Rigs; Car Dumper; Central Redi-Mix Plant; Combination Backhoe Front Endloader Machine, (1 cu. yd. Backhoe Bucket or over or with attachments); Concrete Breaker (Truck Mounted); Concrete Conveyor; Concrete Paver over 27E cu. ft.; Concrete Placer; Concrete Tube Float; Cranes, all attachments; Cranes, Tower Cranes of all types: Creter Crane: Spider Crane; Crusher, Stone, etc.; Derricks, All; Derrick Boats; Derricks, Traveling; Dredges; Elevators, Outside type Rack & Pinion and Similar Machines; Formless Curb and Gutter Machine; Grader, Elevating; Grader, Motor Grader, Motor Patrol, Auto Patrol, Form Grader, Pull Grader, Subgrader; Guard Rail Post Driver Truck Mounted; Hoists, One, Two and Three Drum; Heavy Duty Self-Propelled Transporter or Prime Mover; Hydraulic Backhoes; Backhoes with shear attachments up to 40' of boom reach; Lubrication Technician; Manipulators; Mucking Machine; Pile Drivers and Skid Rig; Pre-Stress Machine; Pump Cretes Dual Ram; Rock Drill - Crawler or Skid Rig; Rock Drill - Truck Mounted; Rock/Track Tamper; Roto Mill Grinder; Slip-Form Paver; Snow Melters; Soil Test Drill Rig (Truck Mounted); Straddle Buggies; Hydraulic Telescoping Form (Tunnel); Operation of Tieback Machine; Tractor Drawn Belt Loader; Tractor Drawn Belt Loader (with attached pusher - two engineers); Tractor with Boom; Tractaire with Attachments; Traffic Barrier Transfer Machine; Trenching; Truck Mounted Concrete Pump with Boom; Raised or Blind Hole Drills (Tunnel Shaft); Underground Boring and/or Mining Machines 5 ft. in diameter and over tunnel, etc; Underground Boring and/or Mining Machines under 5 ft. in diameter; Wheel Excavator; Widener (APSCO).

Class 2. Batch Plant; Bituminous Mixer; Boiler and Throttle Valve; Bulldozers; Car Loader Trailing Conveyors; Combination Backhoe Front Endloader Machine (Less than 1 cu. yd. Backhoe Bucket or over or with attachments); Compressor and Throttle Valve; Compressor, Common Receiver (3); Concrete Breaker or Hydro Hammer; Concrete Grinding Machine; Concrete Mixer or Paver 7S Series to and including 27 cu. ft.; Concrete Spreader; Concrete Curing Machine, Burlap Machine, Belting Machine and Sealing Machine; Concrete Wheel Saw; Conveyor Muck Cars (Haglund or Similar Type); Drills, All; Finishing Machine - Concrete; Highlift Shovels or Front Endloader; Hoist - Sewer Dragging Machine; Hydraulic Boom Trucks (All Attachments); Hydro-Blaster; Hydro Excavating (excluding hose work); Laser Screed; All Locomotives, Dinky; Off-Road Hauling Units (including articulating) Non Self-Loading Ejection Dump; Pump Cretes: Squeeze Cretes - Screw Type Pumps, Gypsum Bulker and Pump; Roller, Asphalt; Rotary Snow Plows; Rototiller, Seaman, etc., self-propelled; Self-Propelled Compactor; Spreader - Chip - Stone, etc.; Scraper - Single/Twin Engine/Push and Pull; Scraper - Prime Mover in Tandem (Regardless of Size); Tractors pulling attachments, Sheeps Foot, Disc, Compactor, etc.; Tug Boats.

Class 3. Boilers; Brooms, All Power Propelled; Cement Supply Tender; Compressor, Common Receiver (2); Concrete Mixer (Two Bag and Over); Conveyor, Portable; Farm-Type Tractors Used for Mowing, Seeding, etc.; Forklift Trucks; Grouting Machine; Hoists, Automatic; Hoists, All Elevators; Hoists, Tugger Single Drum; Jeep Diggers; Low Boys; Pipe Jacking Machines; Post-Hole Digger; Power Saw, Concrete Power Driven; Pug Mills; Rollers, other than Asphalt; Seed and Straw Blower; Steam Generators; Stump Machine; Winch Trucks with "A" Frame; Work Boats; Tamper-Form-Motor Driven.

Class 4. Air Compressor; Combination - Small Equipment Operator;

Directional Boring Machine; Generators; Heaters, Mechanical; Hydraulic Power Unit (Pile Driving, Extracting, or Drilling); Light Plants, All (1 through 5); Pumps, over 3" (1 to 3 not to exceed a total of 300 ft.); Pumps, Well Points; Vacuum Trucks (excluding hose work); Welding Machines (2 through 5); Winches, 4 Small Electric Drill Winches.

Class 5. SkidSteer Loader (all); Brick Forklifts; Oilers.

Class 6. Field Mechanics and Field Welders

Class 7. Dowell Machine with Air Compressor; Gradall and machines of like nature.

TRAFFIC SAFETY - work associated with barricades, horses and drums used to reduce lane usage on highway work, the installation and removal of temporary lane markings, and the installation and removal of temporary road signs.

TRUCK DRIVER - BUILDING, HEAVY AND HIGHWAY CONSTRUCTION

Class 1. Two or three Axle Trucks. A-frame Truck when used for transportation purposes; Air Compressors and Welding Machines, including those pulled by cars, pick-up trucks and tractors; Ambulances; Batch Gate Lockers; Batch Hopperman; Car and Truck Washers; Carry-alls; Fork Lifts and Hoisters; Helpers; Mechanics Helpers and Greasers; Oil Distributors 2-man operation; Pavement Breakers; Pole Trailer, up to 40 feet; Power Mower Tractors; Self-propelled Chip Spreader; Skipman; Slurry Trucks, 2-man operation; Slurry Truck Conveyor Operation, 2 or 3 man; Teamsters; Unskilled Dumpman; and Truck Drivers hauling warning lights, barricades, and portable toilets on the job site.

Class 2. Four axle trucks; Dump Crets and Adgetors under 7 yards; Dumpsters, Track Trucks, Euclids, Hug Bottom Dump Turnapulls or Turnatrailers when pulling other than self-loading equipment or similar equipment under 16 cubic yards; Mixer Trucks under 7 yards; Ready-mix Plant Hopper Operator, and Winch Trucks, 2 Axles.

Class 3. Five axle trucks; Dump Crets and Adgetors 7 yards and over; Dumpsters, Track Trucks, Euclids, Hug Bottom Dump Turnatrailers or turnapulls when pulling other than self-loading equipment or similar equipment over 16 cubic yards; Explosives and/or Fission Material Trucks; Mixer Trucks 7 yards or over; Mobile Cranes while in transit; Oil Distributors, 1-man operation; Pole Trailer, over 40 feet; Pole and Expandable Trailers hauling material over 50 feet long; Slurry trucks, 1-man operation; Winch trucks, 3 axles or more; Mechanic--Truck Welder and Truck Painter.

Class 4. Six axle trucks; Dual-purpose vehicles, such as mounted crane trucks with hoist and accessories; Foreman; Master Mechanic; Self-loading equipment like P.B. and trucks with scoops on the front.

TERRAZZO FINISHER

The handling of sand, cement, marble chips, and all other materials that may be used by the Mosaic Terrazzo Mechanic, and the mixing, grinding, grouting, cleaning and sealing of all Marble, Mosaic, and Terrazzo work, floors, base, stairs, and wainscoting by hand or machine, and in addition, assisting and aiding Marble, Masonic, and Terrazzo Mechanics.

Other Classifications of Work:

For definitions of classifications not otherwise set out, the Department generally has on file such definitions which are available. If a task to be performed is not subject to one of the classifications of pay set out, the Department will upon being contacted state which neighboring county has such a classification and provide such rate, such rate being deemed to exist by reference in this document. If no neighboring county rate applies to the task, the Department shall undertake a special determination, such special determination being then deemed to have existed under this determination. If a project requires these, or any classification not listed, please contact IDOL at 217-782-1710 for wage rates or clarifications.

LANDSCAPING

Landscaping work falls under the existing classifications for laborer, operating engineer and truck driver. The work performed by landscape plantsman and landscape laborer is covered by the existing classification of laborer. The work performed by landscape operators (regardless of equipment used or its size) is covered by the classifications of operating engineer. The work performed by landscape truck drivers (regardless of size of truck driven) is covered by the classifications of truck driver.

Mclean County Prevailing Wage for May 2013

(See explanation of column headings at bottom of wages)

Trade Name	RG	TYP	C	Base	FRMAN	M-F>8	OSA	OSH	H/W	Pensn	Vac	Trng
=====	==	===	=	=====	=====	=====	===	===	=====	=====	=====	=====
ASBESTOS ABT-GEN		BLD		29.340	30.340	1.5	1.5	2.0	7.700	8.920	0.000	0.800
ASBESTOS ABT-GEN		HWY		30.900	31.450	1.5	1.5	2.0	7.700	8.920	0.000	0.800
ASBESTOS ABT-MEC		BLD		31.840	34.340	1.5	1.5	2.0	10.82	10.66	0.000	0.720
BOILERMAKER		BLD		35.010	38.010	2.0	2.0	2.0	7.070	13.83	0.000	0.300
BRICK MASON		BLD		29.820	31.320	1.5	1.5	2.0	7.700	11.23	0.000	0.560
CARPENTER		BLD		30.050	32.300	1.5	1.5	2.0	7.450	12.91	0.000	0.520
CARPENTER		HWY		31.000	33.250	1.5	1.5	2.0	7.450	13.76	0.000	0.520
CEMENT MASON		ALL		30.590	31.590	1.5	1.5	2.0	5.750	11.23	0.000	0.500
CERAMIC TILE FNSHER		BLD		29.750	0.000	1.5	1.5	2.0	7.700	9.130	0.000	0.550
ELECTRIC PWR EQMT OP		ALL		35.440	0.000	1.5	1.5	2.0	5.000	10.98	0.000	0.270
ELECTRIC PWR GRNDMAN		ALL		24.320	0.000	1.5	1.5	2.0	5.000	7.540	0.000	0.180
ELECTRIC PWR LINEMAN		ALL		39.370	41.910	1.5	1.5	2.0	5.000	12.20	0.000	0.300
ELECTRIC PWR TRK DRV		ALL		25.510	0.000	1.5	1.5	2.0	5.000	7.920	0.000	0.190
ELECTRICIAN		BLD		34.950	38.340	1.5	1.5	2.0	5.350	9.500	0.000	0.870
ELECTRONIC SYS TECH		BLD		29.420	31.170	1.5	1.5	2.0	5.350	7.330	0.000	0.400
ELEVATOR CONSTRUCTOR		BLD		40.520	45.585	2.0	2.0	2.0	11.88	12.71	3.240	0.600
FENCE ERECTOR	E	ALL		30.610	32.510	1.5	1.5	2.0	8.840	8.420	0.000	0.900
GLAZIER		BLD		30.770	32.770	1.5	1.5	2.0	9.700	7.700	0.000	1.250
HT/FROST INSULATOR		BLD		42.450	44.950	1.5	1.5	2.0	10.82	11.86	0.000	0.720
IRON WORKER	E	ALL		30.610	32.510	1.5	1.5	2.0	8.840	8.420	0.000	0.900
IRON WORKER	W	BLD		30.330	32.230	1.5	1.5	2.0	9.390	11.56	0.000	0.440
IRON WORKER	W	HWY		34.020	36.020	1.5	1.5	2.0	9.390	11.56	0.000	0.390
LABORER		BLD		28.340	29.340	1.5	1.5	2.0	7.700	8.920	0.000	0.800
LABORER		HWY		29.900	30.450	1.5	1.5	2.0	7.700	8.920	0.000	0.800
LABORER, SKILLED		BLD		28.340	29.340	1.5	1.5	2.0	7.700	8.920	0.000	0.800
LABORER, SKILLED		HWY		29.900	30.450	1.5	1.5	2.0	7.700	8.920	0.000	0.800
LATHER		BLD		30.050	32.300	1.5	1.5	2.0	7.450	12.91	0.000	0.520
MACHINERY MOVER	W	HWY		34.020	36.020	1.5	1.5	2.0	9.390	11.56	0.000	0.390
MACHINIST		BLD		43.550	46.050	1.5	1.5	2.0	6.130	8.950	1.850	0.000
MARBLE FINISHERS		BLD		29.750	0.000	1.5	1.5	2.0	7.700	9.130	0.000	0.550
MARBLE MASON		BLD		31.510	32.760	1.5	1.5	2.0	7.700	9.130	0.000	0.550
MILLWRIGHT		BLD		30.300	32.550	1.5	1.5	2.0	7.450	13.09	0.000	0.520
MILLWRIGHT		HWY		31.820	34.070	1.5	1.5	2.0	7.450	13.44	0.000	0.520

OPERATING ENGINEER		BLD	1	36.000	39.000	1.5	1.5	2.0	9.750	13.60	0.000	3.000
OPERATING ENGINEER		BLD	2	33.490	39.000	1.5	1.5	2.0	9.750	13.60	0.000	3.000
OPERATING ENGINEER		BLD	3	29.340	39.000	1.5	1.5	2.0	9.750	13.60	0.000	3.000
OPERATING ENGINEER		HWY	1	36.000	39.500	1.5	1.5	2.0	9.750	13.60	0.000	3.000
OPERATING ENGINEER		HWY	2	33.490	39.500	1.5	1.5	2.0	9.750	13.60	0.000	3.000
OPERATING ENGINEER		HWY	3	29.340	39.500	1.5	1.5	2.0	9.750	13.60	0.000	3.000
PAINTER		ALL		32.900	34.900	1.5	1.5	1.5	9.650	8.200	0.000	1.250
PAINTER SIGNS		BLD		33.920	38.090	1.5	1.5	1.5	2.600	2.710	0.000	0.000
PILEDRIVER		BLD		30.550	32.800	1.5	1.5	2.0	7.450	12.91	0.000	0.520
PILEDRIVER		HWY		32.000	34.250	1.5	1.5	2.0	7.450	13.76	0.000	0.520
PIPEFITTER		BLD		39.000	42.120	1.5	1.5	2.0	7.000	9.500	0.000	1.850
PLASTERER		BLD		29.500	31.500	1.5	1.5	2.0	6.300	13.83	0.000	0.500
PLUMBER		BLD		39.000	42.120	1.5	1.5	2.0	7.000	9.500	0.000	1.850
ROOFER		BLD		28.580	30.010	1.5	1.5	2.0	8.450	7.220	0.000	0.250
SHEETMETAL WORKER		BLD		31.920	33.520	1.5	1.5	2.0	7.270	13.08	0.000	0.660
SIGN HANGER	W	HWY		34.020	36.020	1.5	1.5	2.0	9.390	11.56	0.000	0.390
SPRINKLER FITTER		BLD		36.390	39.140	1.5	1.5	2.0	8.420	8.500	0.000	0.450
STEEL ERECTOR	W	HWY		34.020	36.020	1.5	1.5	2.0	9.390	11.56	0.000	0.390
TERRAZZO FINISHER		BLD		29.750	0.000	1.5	1.5	2.0	7.700	9.130	0.000	0.550
TERRAZZO MASON		BLD		31.510	32.760	1.5	1.5	2.0	7.700	9.130	0.000	0.550
TILE MASON		BLD		31.510	32.760	1.5	1.5	2.0	7.700	9.130	0.000	0.550
TRUCK DRIVER		O&C	1	24.980	0.000	1.5	1.5	2.0	10.30	4.840	0.000	0.250
TRUCK DRIVER		O&C	2	25.340	0.000	1.5	1.5	2.0	10.30	4.840	0.000	0.250
TRUCK DRIVER		O&C	3	25.510	0.000	1.5	1.5	2.0	10.30	4.840	0.000	0.250
TRUCK DRIVER		O&C	4	25.740	0.000	1.5	1.5	2.0	10.30	4.840	0.000	0.250
TRUCK DRIVER		O&C	5	26.420	0.000	1.5	1.5	2.0	10.30	4.840	0.000	0.250
TRUCK DRIVER	N	ALL	1	35.650	36.200	1.5	1.5	2.0	7.250	6.319	0.000	0.250
TRUCK DRIVER	N	ALL	2	35.800	36.200	1.5	1.5	2.0	7.250	6.319	0.000	0.250
TRUCK DRIVER	N	ALL	3	36.000	36.200	1.5	1.5	2.0	7.250	6.319	0.000	0.250
TRUCK DRIVER	N	ALL	4	36.200	36.200	1.5	1.5	2.0	7.250	6.319	0.000	0.250
TRUCK DRIVER	S	ALL	1	31.230	0.000	1.5	1.5	2.0	10.30	4.840	0.000	0.250
TRUCK DRIVER	S	ALL	2	31.680	0.000	1.5	1.5	2.0	10.30	4.840	0.000	0.250
TRUCK DRIVER	S	ALL	3	31.890	0.000	1.5	1.5	2.0	10.30	4.840	0.000	0.250
TRUCK DRIVER	S	ALL	4	32.180	0.000	1.5	1.5	2.0	10.30	4.840	0.000	0.250
TRUCK DRIVER	S	ALL	5	33.020	0.000	1.5	1.5	2.0	10.30	4.840	0.000	0.250

Legend :

RG (Region)

TYP (Trade Type - All,Highway,Building,Floating,Oil & Chip,Rivers)

C (Class)

Base (Base Wage Rate)

FRMAN (Foreman Rate)

M-F>8 (OT required for any hour greater than 8 worked each day, Mon through Fri.

OSA (Overtime (OT) is required for every hour worked on Saturday)

OSH (Overtime is required for every hour worked on Sunday and Holidays)

H/W (Health & Welfare Insurance)

Pensn (Pension)

Vac (Vacation)

Trng (Training)

Explanations

MCLEAN COUNTY

FENCE ERECTOR - See Ironworkers.

IRONWORKERS (EAST) - That part of the county East of a diagonal line from Heyworth to a point half way between Chenoa and Weston.

TEAMSTERS (NORTH) - North of a straight line starting on the west side where Route 24 crosses McClean County line in a southeasterly direction to the most south-southwestern corner of Livingston County.

The following list is considered as those days for which holiday rates of wages for work performed apply: New Years Day, Memorial Day, Fourth of July, Labor Day, Thanksgiving Day, Christmas Day and Veterans Day in some classifications/counties. Generally, any of these holidays which fall on a Sunday is celebrated on the following Monday. This then makes work performed on that Monday payable at the appropriate overtime rate for holiday pay. Common practice in a given local may alter certain days of celebration. If in doubt, please check with IDOL.

Oil and chip resealing (O&C) means the application of road oils and liquid asphalt to coat an existing road surface, followed by application of aggregate chips or gravel to coated surface, and subsequent rolling of material to seal the surface.

EXPLANATION OF CLASSES

ASBESTOS - GENERAL - removal of asbestos material/mold and hazardous materials from any place in a building, including mechanical systems where those mechanical systems are to be removed. This includes the removal of asbestos materials/mold and hazardous materials from ductwork or pipes in a building when the building is to be demolished at the time or at some close future date.

ASBESTOS - MECHANICAL - removal of asbestos material from mechanical systems, such as pipes, ducts, and boilers, where the mechanical systems are to remain.

CERAMIC TILE FINISHER, MARBLE FINISHER, TERRAZZO FINISHER

Assisting, helping or supporting the tile, marble and terrazzo mechanic by performing their historic and traditional work assignments required to complete the proper installation of the work covered by said crafts. The term "Ceramic" is used for naming the classification only and is in no way a limitation of the product handled. Ceramic takes into consideration most hard tiles.

ELECTRONIC SYSTEMS TECHNICIAN

Installation, service and maintenance of low-voltage systems which utilizes the transmission and/or transference of voice, sound, vision, or digital for commercial, education, security and entertainment purposes for the following: TV monitoring and surveillance, background/foreground music, intercom and telephone interconnect, field programming, inventory control systems, microwave transmission, multi-media, multiplex, radio page, school, intercom and sound burglar alarms and low voltage master clock systems.

Excluded from this classification are energy management systems, life safety systems, supervisory controls and data acquisition systems not intrinsic with the above listed systems, fire alarm systems, nurse

call systems and raceways exceeding fifteen feet in length.

LABORER, SKILLED - BUILDING

The skilled laborer building (BLD) classification shall encompass the following types of work, irrespective of the site of the work: tending of carpenters in unloading, handling, stockpiling and distribution operations, also other building crafts, mixing, handling, and conveying of all materials used by masons, plasterers and other building construction crafts, whether done by hand or by any process. The drying of plastering when done by salamander heat, and the cleaning and clearing of all debris. All work pertaining to and in preparation of asbestos abatement and removal. The building of scaffolding and staging for masons and plasterers. The excavations for buildings and all other construction, digging, of trenches, piers, foundations and holes, digging, lagging, sheeting, cribbing, bracing and propping of foundations, holes, caissons, cofferdams, and dikes, the setting of all guidelines for machine or hand excavation and subgrading. The mixing, handling, conveying, pouring, vibrating, gunniting and otherwise applying of concrete, whether by hand or other method of concrete for any walls, foundations, floors, or for other construction concrete sealant men. The wrecking, stripping, dismantling, and handling of concrete forms and false work, and the building of centers for fireproofing purposes. Boring machine, gas, electric or air in preparation for shoving pipe, telephone cable, and so forth, under highways, roads, streets and alleys. All hand and power operating cross cut saws when used for clearing. All work in compressed air construction. All work on acetylene burners in salvaging. The blocking and tamping of concrete. The laying of sewer tile and conduit, and pre-cast materials. The assembling and dismantling of all jacks and sectional scaffolding, including elevator construction and running of slip form jacks. The work of drill running and blasting, including wagon drills. The wrecking, stripping, dismantling, cleaning, moving and oiling of forms. The cutting off of concrete piles. The loading, unloading, handling and carrying to place of installation of all rods, (and materials for use in reinforcing) concrete and the hoisting of same and all signaling where hoist is used in this type of construction coming under the jurisdiction of the Laborers' Union. And, all other labor work not awarded to any other craft. Mortar mixers, kettlemen and carrier of hot stuff, tool crib men, watchmen (Laborer), firemen or salamander tenders, flagmen, deck hands, installation and maintenance of temporary gas-fired heating units, gravel box men, dumpmen and spotters, fencing Laborers, cleaning lumber, pit men, material checkers, dispatchers, unloading explosives, asphalt plant laborers, writer of scale tickets, fireproofing laborers, janitors, asbestos abatement and removal laborers, handling of materials treated with oil, creosote, chloride, asphalt, and/or foreign material harmful to skin or clothing, Laborers with de-watering systems, gunnite nozzle men, laborers tending masons with hot material or where foreign materials are used, Laborers handling masterplate or similar materials, laser beam operator, concrete burning machine operator, material selector men working with firebrick or combustible material, dynamite men, track laborers, cement handlers, chloride handlers, the unloading and laborers with steel workers and re-bars, concrete workers (wet), luteman, asphalt raker, curb asphalt machine operator, ready mix scalemen, permanent, portable or temporary plant drilling machine operator, plaster tenders, underpinning and shoring of buildings, fire watch, signaling of all power equipment, to include trucks excavating equipment, etc., tree topper or trimmer when in connection to construction, tunnel helpers in free air, batch dumpers, kettle and tar men, tank cleaners, plastic installers, scaffold workers, motorized buggies or motorized unit used for wet concrete or handling of building materials, sewer workers, rod and chain men, vibrator operators, mortar mixer operator, cement silica, clay, fly

ash, lime and plasters, handlers (bulk or bag), cofferdam workers, on concrete paving, placing, cutting and tying of reinforcing, deck hand, dredge hand and shore laborers, bankmen on floating plant, asphalt workers with machine & layers, grade checker, power tools, caisson workers, lead man on sewer work, welders, cutters, burners and torch men, chain saw operators, paving breaker, jackhammer and drill operator, layout man and/or drainage tile layer, steel form setters -- street and highway, air tamping hammerman, signal man on crane, concrete saw operator, screen man on asphalt pavers, front end man on chip spreader, multiple concrete duct -- lead man.

LABORER, SKILLED - HIGHWAY

The skilled laborer heavy and highway (HWY) classification shall encompass the following types of work, irrespective of the site of the work: handling of materials treated with oil, creosote, asphalt and/or any foreign materials harmful to skin or clothing, track laborers, chloride handlers, the unloading and loading with steel workers and re-bars, concrete workers (wet), tunnel helpers in free air, batch dumpers, mason tenders, kettle and tar men, plastic installers, scaffold workers, motorized buggies or motorized unit used for wet concrete or handling of building materials, laborers with de-watering systems, sewer workers plus depth, rod and chainmen, vibrator operators, mortar mixer operators, cement silica, clay, fly ash, lime and plasters, handlers (bulk or bag), cofferdam workers plus depth, on concrete paving, placing, cutting and tying or reinforcing, deck hand, dredge hand shore laborers, bankmen on floating plant, asphalt workers with machine, and layers, grade checker, power tools, stripping of all concrete forms excluding paving forms, dumpmen and spotters, when necessary, caisson workers plus depth, gunnite nozzle men, welders, cutters, burners and torchmen, chain saw operators, paving breaker, jackhammer and drill operators, layout man and/or drainage tile layer, steel form setters - street and highway, air tamping hammerman, signal man on crane, concrete saw operator, screedman on asphalt pavers, front end man on chip spreader, multiple concrete duct, luteman, asphalt raker, curb asphalt machine operator, ready mix scalemen (portable or temporary plant), laser beam operator, concrete burning machine operator, and coring machine operator.

TRUCK DRIVER - BUILDING, HEAVY AND HIGHWAY CONSTRUCTION - SOUTH

Class 1. Drivers on 2 axle trucks hauling less than 9 ton. Air compressor and welding machines and brooms, including those pulled by separate units, truck driver helpers, warehouse employees, mechanic helpers, greasers and tiremen, pickup trucks when hauling materials, tools, or workers to and from and on-the-job site, and fork lifts up to 6,000 lb. capacity.

Class 2. Two or three axle trucks hauling more than 9 ton but hauling less than 16 ton. A-frame winch trucks, hydrolift trucks, vector trucks or similar equipment when used for transportation purposes. Fork lifts over 6,000 lb. capacity, winch trucks, four axle combination units, and ticket writers.

Class 3. Two, three or four axle trucks hauling 16 ton or more. Drivers on water pulls, articulated dump trucks, mechanics and working forepersons, and dispatchers. Five axle or more combination units.

Class 4. Low Boy and Oil Distributors.

Class 5. Drivers who require special protective clothing while employed on hazardous waste work.

TRUCK DRIVER - BUILDING, HEAVY AND HIGHWAY CONSTRUCTION - NORTH

Class 1. Two or three Axle Trucks. A-frame Truck when used for transportation purposes; Air Compressors and Welding Machines, including those pulled by cars, pick-up trucks and tractors; Ambulances; Batch Gate Lockers; Batch Hopperman; Car and Truck Washers; Carry-alls; Fork Lifts and Hoisters; Helpers; Mechanics Helpers and Greasers; Oil Distributors 2-man operation; Pavement Breakers; Pole Trailer, up to 40 feet; Power Mower Tractors; Self-propelled Chip Spreader; Skipman; Slurry Trucks, 2-man operation; Slurry Truck Conveyor Operation, 2 or 3 man; Teamsters; Unskilled dumpman; and Truck Drivers hauling warning lights, barricades, and portable toilets on the job site.

Class 2. Four axle trucks; Dump Crets and Adgetors under 7 yards; Dumpsters, Track Trucks, Euclids, Hug Bottom Dump Turnapulls or Turnatrailers when pulling other than self-loading equipment or similar equipment under 16 cubic yards; Mixer Trucks under 7 yards; Ready-mix Plant Hopper Operator, and Winch Trucks, 2 Axles.

Class 3. Five axle trucks; Dump Crets and Adgetors 7 yards and over; Dumpsters, Track Trucks, Euclids, Hug Bottom Dump Turnatrailers or turnapulls when pulling other than self-loading equipment or similar equipment over 16 cubic yards; Explosives and/or Fission Material Trucks; Mixer Trucks 7 yards or over; Mobile Cranes while in transit; Oil Distributors, 1-man operation; Pole Trailer, over 40 feet; Pole and Expandable Trailers hauling material over 50 feet long; Slurry trucks, 1-man operation; Winch trucks, 3 axles or more; Mechanic--Truck Welder and Truck Painter.

Class 4. Six axle trucks; Dual-purpose vehicles, such as mounted crane trucks with hoist and accessories; Foreman; Master Mechanic; Self-loading equipment like P.B. and trucks with scoops on the front.
TRUCK DRIVER - OIL AND CHIP RESEALING ONLY.

This shall encompass laborers, workers and mechanics who drive contractor or subcontractor owned, leased, or hired pickup, dump, service, or oil distributor trucks. The work includes transporting materials and equipment (including but not limited to, oils, aggregate supplies, parts, machinery and tools) to or from the job site; distributing oil or liquid asphalt and aggregate; stock piling material when in connection with the actual oil and chip contract. The Truck Driver (Oil & Chip Resealing) wage classification does not include supplier delivered materials.

OPERATING ENGINEERS - BUILDING

Class 1. Cranes; Overhead Cranes; Gradall; All Cherry Pickers; Mechanics; Central Concrete Mixing Plant Operator; Road Pavers (27E - Dual Drum - Tri Batchers); Blacktop Plant Operators and Plant Engineers; 3 Drum Hoist; Derricks; Hydro Cranes; Shovels; Skimmer Scoops; Koehring Scooper; Drag Lines; Backhoe; Derrick Boats; Pile Drivers and Skid Rigs; Clamshells; Locomotive Cranes; Dredge (all types) Motor Patrol; Power Blades - Dumore - Elevating and similar types; Tower Cranes (Crawler-Mobile) and Stationary; Crane-type Backfiller; Drott Yumbo and similar types considered as Cranes; Caisson Rigs; Dozer; Tournadozer; Work Boats; Ross Carrier; Helicopter; Tournapulls - all and similar types; Scoops (all sizes); Pushcats; Endloaders (all types); Asphalt Surfacing Machine; Slip Form Paver; Rock Crusher; Heavy Equipment Greaser; CMI, CMI Belt Placer, Auto Grade & 3 Track and similar types; Side Booms; Multiple Unit Earth Movers; Creter Crane; Trench Machine; Pump-crete-Belt Crete-Squeeze Cretes-Screw-type Pumps and Gypsum; Bulker & Pump - Operator will clean; Formless Finishing Machine; Flaherty Spreader or similar types; Screed Man on Laydown Machine; Wheel Tractors (industrial or Farm-type w/Dozer-Hoe-Endloader or other attachments);

F.W.D. & Similar Types; Vermeer Concrete Saw.

Class 2. Dinkeys; Power Launches; PH One-pass Soil Cement Machine (and similar types); Pugmill with Pump; Backfillers; Euclid Loader; Forklifts; Jeeps w/Ditching Machine or other attachments; Tunneler; Automatic Cement and Gravel Batching Plants; Mobile Drills (Soil Testing) and similar types; Gurries and Similar Types; (1) and (2) Drum Hoists (Buck Hoist and Similar Types); Chicago Boom; Boring Machine & Pipe Jacking Machine; Hydro Boom; Dewatering System; Straw Blower; Hydro Seeder; Assistant Heavy Equipment Greaser on Spread; Tractors (Track type) without Power Unit pulling Rollers; Rollers on Asphalt -- Brick Macadem; Concrete Breakers; Concrete Spreaders; Mule Pulling Rollers; Center Stripper; Cement Finishing Machines & CMI Texture & Reel Curing Machines; Cement Finishing Machine; Barber Green or similar loaders; Vibro Tamper (All similar types) Self-propelled; Winch or Boom Truck; Mechanical Bull Floats; Mixers over 3 Bag to 27E; Tractor pulling Power Blade or Elevating Grader; Porter Rex Rail; Clary Screed; Truck Type Hoptoe Oilers; Fireman; Spray Machine on Paving; Curb Machines; Truck Crane Oilers; Oil Distributor; Truck-Mounted Saws.

Class 3. Air Compressor; Power Subgrader; Straight Tractor; Trac Air without attachments; Herman Nelson Heater, Dravo, Warner, Silent Glo, and similar types; Roller: Five (5) Ton and under on Earth or Gravel; Form Grader; Crawler Crane & Skid Rig Oilers; Freight Elevators - permanently installed; Pump; Light Plant; Generator; Conveyor (1) or (2) - Operator will clean; Welding Machine; Mixer (3) Bag and Under (Standard Capacity with skip); Bulk Cement Plant; Oiler on Central Concrete Mixing Plant.

OPERATING ENGINEERS - HEAVY AND HIGHWAY CONSTRUCTION

CLASS 1. Cranes; Hydro Cranes; Shovels; Crane Type Backfiller; Tower, Mobile, Crawler, & Stationary Cranes; Derricks; Hoists (3 Drum); Draglines; Drott Yumbo & Similar Types considered as Cranes; 360 Degree Swing Excavator (Shears, Grapples, Movacs, etc.); Back Hoe; Derrick Boats; Pile Driver and Skid Rigs; Clam Shell; Locomotive - Cranes; Road Pavers - Single Drum - Dual Drum - Tri Batcher; Motor Patrols & Power Blades - Dumore - Elevating & Similar Types; Mechanics; Central Concrete Mixing Plant Operator; Asphalt Batch Plant Operators and Plant Engineers; Gradall; Caisson Rigs; Skimmer Scoop - Koering Scooper; Dredges (all types); Hoptoe; All Cherry Pickers; Work Boat; Ross Carrier; Helicopter; Dozer; Tournadozer; Tournapulls - all and similar types; Operation of Concrete and all Recycle Machines; Multiple Unit Earth Movers; Scoops (all sizes); Pushcats; Endloaders (all types); Asphalt Surfacing Machine; Slip Form Paver; Rock Crusher; Operation of Material Crusher, Screening Plants, and Tunnel Boring Machine; Heavy Equipment Greaser (top greaser on spread); CMI, Auto Grade, CMI Belt Placer & 3 Track and Similar Types; Side Booms; Asphalt Heater & Planer Combination (used to plane streets); Wheel Tractors (with Dozer, Hoe or Endloader Attachments); CAT Earthwork Compactors and Similar Types; Blaw Knox Spreader and Similar Types; Trench Machines; Pump Crete - Belt Crete - Squeeze Crete - Screw Type Pumps and Gypsum (operator will clean); Creter Crane; Operation of Concrete Pump Truck; Formless Finishing Machines; Flaherty Spreader or Similar Types; Screed Man on Laydown Machine; Vermeer Concrete Saw; Operation of Laser Screed; Span Saw; Dredge Leverman; Dredge Engineer; Lull or Similar Type; Hydro-Boom Truck; Operation of Guard Rail Machine; and Starting Engineer on Pipeline or Construction (11 or more pieces) including: Air Compressor (Trailer Mounted), All Forced Air Heaters (regardless of Size), Water Pumps (Greater than 4-1/2" or Total Discharge Over 4-1/2"), Light Plants, Generators (Trailer Mounted - Excluding Decontamination Trailer), Welding Machines (Any Size or Mode of Power), Conveyor, Mixer (any size), Stud Welder, Power Pac, etc, and Ground Heater (Trailer

Mounted).

CLASS 2. Bulker & Pump; Power Launches; Boring Machine & Pipe Jacking Machine; Dinkeys; Operation of Carts, Powered Haul Unit for a Boring Machine; P & H One Pass Soil Cement Machines and Similar Types; Wheel Tractors (Industry or Farm Type - Other); Back Fillers; Euclid Loader; Fork Lifts; Jeep w/Ditching Machine or Other Attachments; Tunneluger; Automatic Cement & Gravel Batching Plants; Mobile Drills - Soil Testing and Similar Types; Pugmill with Pump; All (1) and (2) Drum Hoists; Dewatering System; Straw Blower; Hydro-Seeder; Bump Grinders (self-propelled); Assistant Heavy Equipment Greaser; Apsco Spreader; Tractors (Track-Type) without Power Units Pulling Rollers; Rollers on Asphalt - Brick or Macadam; Concrete Breakers; Concrete Spreaders; Cement Strippers; Cement Finishing Machines & CMI Texture & Reel Curing Machines; Vibro-Tampers (All Similar Types Self-Propelled); Mechanical Bull Floats; Self-Propelled Concrete Saws; Truck Mounted Power Saws; Operation of Curb Cutters; Mixers - Over Three (3) Bags; Winch and Boom Trucks; Tractor Pulling Power Blade or Elevating Grader; Porter Rex Rail; Clary Screed; Mule Pulling Rollers; Pugmill without Pump; Barber Greene or Similar Loaders; Track Type Tractor w/Power Unit attached (minimum); Fireman; Spray Machine on Paving; Curb Machines; Paved Ditch Machine; Power Broom; Self-Propelled Sweepers; Self-Propelled Conveyors; Power Subgrader; Oil Distributor; Straight Tractor; Truck Crane Oiler; Truck Type Oilers; Directional Boring Machine; Horizontal Directional Drill; Articulating End Dump Vehicles; Starting Engineer on Pipeline or Construction (6 -10 pieces) including: Air Compressor (Trailer Mounted), All Forced Air Heaters (regardless of Size), Water Pumps (Greater than 4-1/2" or Total Discharge Over 4-1/2"), Light Plants, Generators (Trailer Mounted - Excluding Decontamination Trailer), Welding Machines (Any Size or Mode of Power), Conveyor, Mixer (any size), Stud Welder, Power Pac, etc., and Ground Heater (Trailer Mounted).

CLASS 3. Straight Framed Truck Mounted Vac Unit (separately powered); Trac Air Machine (without attachments); Rollers - Five Ton and Under on Earth and Gravel; Form Graders; Bulk Cement Plant; Oilers; and Starting Engineer on Pipeline or Construction (3 - 5 pieces) including: Air Compressor (Trailer Mounted), All Forced Air Heaters (regardless of Size), Water Pumps (Greater than 4-1/2" or Total Discharge Over 4-1/2"), Light Plants, Generators (Trailer Mounted - Excluding Decontamination Trailer), Welding Machines (Any Size or Mode of Power), Conveyor, Mixer (any size), Stud Welder, Power Pac, etc., and Ground Heater (Trailer Mounted).

Other Classifications of Work:

For definitions of classifications not otherwise set out, the Department generally has on file such definitions which are available. If a task to be performed is not subject to one of the classifications of pay set out, the Department will upon being contacted state which neighboring county has such a classification and provide such rate, such rate being deemed to exist by reference in this document. If no neighboring county rate applies to the task, the Department shall undertake a special determination, such special determination being then deemed to have existed under this determination. If a project requires these, or any classification not listed, please contact IDOL at 217-782-1710 for wage rates or clarifications.

LANDSCAPING

Landscaping work falls under the existing classifications for laborer, operating engineer and truck driver. The work performed by landscape plantsman and landscape laborer is covered by the existing classification of laborer. The work performed by landscape operators

(regardless of equipment used or its size) is covered by the classifications of operating engineer. The work performed by landscape truck drivers (regardless of size of truck driven) is covered by the classifications of truck driver.

Menard County Prevailing Wage for May 2013

(See explanation of column headings at bottom of wages)

Trade Name	RG	TYP	C	Base	FRMAN	M-F>8	OSA	OSH	H/W	Pensn	Vac	Trng
ASBESTOS ABT-GEN		BLD		30.360	31.610	1.5	1.5	2.0	5.750	10.22	0.000	0.900
ASBESTOS ABT-MEC		BLD		29.860	30.860	1.5	1.5	2.0	6.950	3.000	0.000	0.000
BOILERMAKER		BLD		31.500	34.000	1.5	1.5	2.0	7.070	18.73	1.000	0.350
BRICK MASON		BLD		29.130	29.880	2.0	2.0	2.0	8.200	10.03	0.000	0.580
CARPENTER		BLD		29.810	32.060	1.5	1.5	2.0	7.450	12.44	0.000	0.520
CARPENTER		HWY		29.810	31.560	1.5	1.5	2.0	7.450	12.99	0.000	0.520
CEMENT MASON		BLD		25.200	26.700	1.5	1.5	2.0	6.600	12.10	0.000	0.500
CEMENT MASON		HWY		24.850	25.850	1.5	1.5	2.0	6.600	11.85	0.000	0.500
CERAMIC TILE FNSHER		BLD		25.480	0.000	1.5	1.5	2.0	8.200	8.930	0.000	0.000
ELECTRIC PWR EQMT OP		ALL		35.440	0.000	1.5	1.5	2.0	5.000	10.98	0.000	0.270
ELECTRIC PWR GRNDMAN		ALL		24.320	0.000	1.5	1.5	2.0	5.000	7.540	0.000	0.180
ELECTRIC PWR LINEMAN		ALL		39.370	41.910	1.5	1.5	2.0	5.000	12.20	0.000	0.300
ELECTRIC PWR TRK DRV		ALL		25.510	0.000	1.5	1.5	2.0	5.000	7.920	0.000	0.190
ELECTRICIAN		BLD		34.220	36.220	1.5	1.5	2.0	5.860	8.120	0.000	0.400
ELECTRONIC SYS TECH		BLD		30.390	32.140	1.5	1.5	2.0	5.350	7.160	0.000	0.400
ELEVATOR CONSTRUCTOR		BLD		40.520	45.585	2.0	2.0	2.0	11.88	12.71	3.240	0.600
GLAZIER		BLD		30.780	32.780	1.5	2.0	2.0	6.630	8.150	0.000	0.380
HT/FROST INSULATOR		BLD		37.260	38.260	1.5	1.5	2.0	7.850	11.16	0.000	0.500
IRON WORKER		BLD		29.460	31.460	1.5	1.5	2.0	7.740	11.38	0.000	0.660
IRON WORKER		HWY		30.600	32.100	1.5	1.5	2.0	7.740	11.69	0.000	0.660
LABORER		BLD		28.360	29.610	1.5	1.5	2.0	5.750	10.22	0.000	0.800
LABORER		HWY		28.210	28.960	1.5	1.5	2.0	5.750	10.32	0.000	0.800
LATHER		BLD		29.810	32.060	1.5	1.5	2.0	7.450	12.44	0.000	0.520
MACHINIST		BLD		43.550	46.050	1.5	1.5	2.0	6.130	8.950	1.850	0.000
MARBLE FINISHERS		BLD		25.480	0.000	1.5	1.5	2.0	8.200	8.930	0.000	0.000
MARBLE MASON		BLD		26.980	27.730	1.5	1.5	2.0	8.200	8.930	0.000	0.000
MILLWRIGHT		BLD		29.620	31.870	1.5	1.5	2.0	7.450	13.09	0.000	0.520
MILLWRIGHT		HWY		31.690	33.440	1.5	1.5	2.0	7.450	13.54	0.000	0.520
OPERATING ENGINEER		BLD	1	33.900	35.400	1.5	1.5	2.0	10.05	7.600	0.000	1.300
OPERATING ENGINEER		BLD	2	31.550	35.400	1.5	1.5	2.0	10.05	7.600	0.000	1.300
OPERATING ENGINEER		BLD	3	27.950	35.400	1.5	1.5	2.0	10.05	7.600	0.000	1.300
OPERATING ENGINEER		BLD	4	35.400	35.400	1.5	1.5	2.0	10.05	7.600	0.000	1.300
OPERATING ENGINEER		HWY	1	37.600	39.100	1.5	1.5	2.0	10.05	8.100	0.000	1.300
OPERATING ENGINEER		HWY	2	33.660	39.100	1.5	1.5	2.0	10.05	8.100	0.000	1.300
OPERATING ENGINEER		HWY	3	27.630	39.100	1.5	1.5	2.0	10.05	8.100	0.000	1.300
OPERATING ENGINEER		HWY	4	39.100	39.100	1.5	1.5	2.0	10.05	8.100	0.000	1.300
PAINTER		ALL		28.580	30.080	1.5	1.5	2.0	5.000	8.580	0.000	0.550
PAINTER OVER 30FT		ALL		29.580	31.080	1.5	1.5	2.0	5.000	8.580	0.000	0.550
PAINTER PWR EQMT		ALL		29.580	31.080	1.5	1.5	2.0	5.000	8.580	0.000	0.550
PILEDRIVER		BLD		30.310	32.560	1.5	1.5	2.0	7.450	12.44	0.000	0.520
PILEDRIVER		HWY		30.810	32.560	1.5	1.5	2.0	7.450	12.99	0.000	0.520
PIPEFITTER		BLD		40.020	44.020	1.5	1.5	2.0	7.000	7.750	0.000	0.900
PLASTERER		BLD		28.500	30.250	1.5	1.5	2.0	7.330	11.29	0.000	0.500
PLUMBER		BLD		40.020	44.020	1.5	1.5	2.0	7.000	7.750	0.000	0.900
ROOFER		BLD		27.900	30.400	1.5	1.5	2.0	8.600	6.750	0.000	0.500
SHEETMETAL WORKER		BLD		31.680	33.930	1.5	1.5	2.0	8.300	12.35	0.000	0.500
SPRINKLER FITTER		BLD		36.390	39.140	1.5	1.5	2.0	8.420	8.500	0.000	0.450
STONE MASON		BLD		29.130	29.880	2.0	2.0	2.0	8.200	10.03	0.000	0.580
TERRAZZO FINISHER		BLD		25.480	0.000	1.5	1.5	2.0	8.200	8.930	0.000	0.000
TERRAZZO MASON		BLD		26.980	27.730	1.5	1.5	2.0	8.200	8.930	0.000	0.000
TILE MASON		BLD		26.980	27.730	1.5	1.5	2.0	8.200	8.930	0.000	0.000
TRUCK DRIVER		ALL	1	31.340	0.000	1.5	1.5	2.0	10.30	5.010	0.000	0.250
TRUCK DRIVER		ALL	2	31.780	0.000	1.5	1.5	2.0	10.30	5.010	0.000	0.250

TRUCK DRIVER	ALL	3	32.020	0.000	1.5	1.5	2.0	10.30	5.010	0.000	0.250
TRUCK DRIVER	ALL	4	32.280	0.000	1.5	1.5	2.0	10.30	5.010	0.000	0.250
TRUCK DRIVER	ALL	5	33.130	0.000	1.5	1.5	2.0	10.30	5.010	0.000	0.250
TRUCK DRIVER	O&C	1	25.070	0.000	1.5	1.5	2.0	10.30	5.010	0.000	0.250
TRUCK DRIVER	O&C	2	25.420	0.000	1.5	1.5	2.0	10.30	5.010	0.000	0.250
TRUCK DRIVER	O&C	3	25.620	0.000	1.5	1.5	2.0	10.30	5.010	0.000	0.250
TRUCK DRIVER	O&C	4	25.820	0.000	1.5	1.5	2.0	10.30	5.010	0.000	0.250
TRUCK DRIVER	O&C	5	26.500	0.000	1.5	1.5	2.0	10.30	5.010	0.000	0.250
TUCKPOINTER	BLD		29.130	29.880	2.0	2.0	2.0	8.200	10.03	0.000	0.580

Legend :

RG (Region)

TYP (Trade Type - All,Highway,Building,Floating,Oil & Chip,Rivers)

C (Class)

Base (Base Wage Rate)

FRMAN (Foreman Rate)

M-F>8 (OT required for any hour greater than 8 worked each day, Mon through Fri.

OSA (Overtime (OT) is required for every hour worked on Saturday)

OSH (Overtime is required for every hour worked on Sunday and Holidays)

H/W (Health & Welfare Insurance)

Pensn (Pension)

Vac (Vacation)

Trng (Training)

Explanations

MENARD COUNTY

The following list is considered as those days for which holiday rates of wages for work performed apply: New Years Day, Memorial Day, Fourth of July, Labor Day, Thanksgiving Day, Christmas Day and Veterans Day in some classifications/counties. Generally, any of these holidays which fall on a Sunday is celebrated on the following Monday. This then makes work performed on that Monday payable at the appropriate overtime rate for holiday pay. Common practice in a given local may alter certain days of celebration. If in doubt, please check with IDOL.

Oil and chip resealing (O&C) means the application of road oils and liquid asphalt to coat an existing road surface, followed by application of aggregate chips or gravel to coated surface, and subsequent rolling of material to seal the surface.

EXPLANATION OF CLASSES

ASBESTOS - GENERAL - removal of asbestos material/mold and hazardous materials from any place in a building, including mechanical systems

where those mechanical systems are to be removed. This includes the removal of asbestos materials/mold and hazardous materials from ductwork or pipes in a building when the building is to be demolished at the time or at some close future date.

ASBESTOS - MECHANICAL - removal of asbestos material from mechanical systems, such as pipes, ducts, and boilers, where the mechanical systems are to remain.

CERAMIC TILE FINISHER, MARBLE FINISHER, TERRAZZO FINISHER

Assisting, helping or supporting the tile, marble and terrazzo mechanic by performing their historic and traditional work assignments required to complete the proper installation of the work covered by said crafts. The term "Ceramic" is used for naming the classification only and is in no way a limitation of the product handled. Ceramic takes into consideration most hard tiles.

ELECTRONIC SYSTEMS TECHNICIAN

Installation, service and maintenance of low-voltage systems which utilizes the transmission and/or transference of voice, sound, vision, or digital for commercial, education, security and entertainment purposes for the following: TV monitoring and surveillance, background/foreground music, intercom and telephone interconnect, field programming, inventory control systems, microwave transmission, multi-media, multiplex, radio page, school, intercom and sound burglar alarms and low voltage master clock systems.

Excluded from this classification are energy management systems, life safety systems, supervisory controls and data acquisition systems not intrinsic with the above listed systems, fire alarm systems, nurse call systems and raceways exceeding fifteen feet in length.

TRUCK DRIVER - BUILDING, HEAVY AND HIGHWAY CONSTRUCTION

Class 1. Drivers on 2 axle trucks hauling less than 9 ton. Air compressor and welding machines and brooms, including those pulled by separate units, truck driver helpers, warehouse employees, mechanic helpers, greasers and tiremen, pickup trucks when hauling materials, tools, or workers to and from and on-the-job site, and fork lifts up to 6,000 lb. capacity.

Class 2. Two or three axle trucks hauling more than 9 ton but hauling less than 16 ton. A-frame winch trucks, hydrolift trucks, vactor trucks or similar equipment when used for transportation purposes. Fork lifts over 6,000 lb. capacity, winch trucks, four axle combination units, and ticket writers.

Class 3. Two, three or four axle trucks hauling 16 ton or more. Drivers on water pulls, articulated dump trucks, mechanics and working forepersons, and dispatchers. Five axle or more combination units.

Class 4. Low Boy and Oil Distributors.

Class 5. Drivers who require special protective clothing while employed on hazardous waste work.

TRUCK DRIVER - OIL AND CHIP RESEALING ONLY.

This shall encompass laborers, workers and mechanics who drive contractor or subcontractor owned, leased, or hired pickup, dump, service, or oil distributor trucks. The work includes transporting materials and equipment (including but not limited to, oils, aggregate supplies, parts, machinery and tools) to or from the job site; distributing oil or liquid asphalt and aggregate; stock piling

material when in connection with the actual oil and chip contract. The Truck Driver (Oil & Chip Resealing) wage classification does not include supplier delivered materials.

OPERATING ENGINEERS - BUILDING

CLASS 1. Asphalt Screed Man; Aspco Concrete Spreaders; Asphalt Pavers; Asphalt Plant Engineer; Asphalt Rollers on Bituminous Concrete; Athey Loaders; Backfillers, Crane Type; Backhoes; Barber Green Loaders; Bulldozers; Cableways; Cherry Pickers; Clam Shells; C.M.I. & similar type autograde formless paver, autograde placer & finisher; Concrete Breakers; Concrete Pumps; Derricks; Derrick Boats; Draglines; Earth Auger or Boring Machines; Elevating Graders; Engineers on Dredges; Gravel Processing Machines; Head Equipment Greaser; High Lifts or Fork Lifts; Hoists with two or more drums or two or more load lines; Locomotives, All; Mechanics; Motor Graders or Auto Patrols; Operators or Leverman on Dredges; Operators, Power Boat; Operators, Pug Mill (Asphalt Plants); Orange Peels; Overhead Cranes; Paving Mixers; Piledrivers; Pipe Wrapping and Painting Machines; Pushdozers, or Push Cats; Robotic Controlled Equipment in this Classification; Rock Crushers; Ross Carrier or Similar Machines; Rotomill; Scoops, Skimmer, two cu. yd. capacity and under; Scoops, All or Tournapull; Sheep-Foot Roller (Self Propelled); Shovels; Skid Steer; Skimmer Scoops; Temporary Concrete Plant Operators; Test Hole Drilling Machines; Tower Machines; Tower Mixers; Track Type End Loaders; Track Type Fork Lifts or High Lifts; Track Jacks and Tampers; Tractors, Sideboom; Trenching or Ditching Machine; Tunnelluggers; Vermeer Type Saws; Water Blaster Cutting Head; Wheel Type End Loaders; Winch Cat.

CLASS 2. Air Compressors (six to eight)*; Asphalt Boosters and Heaters; Asphalt Distributors; Asphalt Plant Fireman; Oiler on Two Paving Mixers When Used in Tandem; Boom or Winch Trucks; Bull Floats or Flexplanes; Concrete Finishing Machine; Concrete Saws, Self-Propelled; Concrete Spreading Machines; Conveyors (six to eight)*; Generators (six to eight)*; Gravel or Stone Spreader, Power Operated; Hoist (with One Drum and One Load Line); Light Plants (six to eight)*; Mechanical Heaters (six to eight)*; Mud Jacks; Post Hole Digger, Mechanical; Pug Mills when used for other than Asphalt operation; Robotic Controlled Equipment in this Classification; Road or Street Sweeper, Self Propelled; Rollers (except bituminous concrete); Seaman Tiller; Straw Machine; Vibratory Compactor; Water Blaster, Power Unit; Welding Machines (six to eight)*; Well Drill Machines.

CLASS 3. Air Compressors(one to five)*; Air Compressors, Track or Self-Propelled; Automatic Hoist; Building Elevators; Bulk Cement Batching Plants; Conveyors (one to five)*; Concrete Mixers (Except Plant, Paver, or Tower); Firemen; Generators (one to five)*; Greasers; Helper on Single Paving Mixer; Hoist, Automatic; Light Plants (one to five)*; Mechanic Helpers; Mechanical Heaters (one to five)*; Oilers; Power Form Graders; Power Sub-Graders; Robotic Controlled Equipment in this Classification; Scissors Hoist; Tractors without power attachments regardless of size or type; Truck Crane Oiler and Driver (1 man); Vibratory Hammer (power source); Water Pumps (one to five)*; Welding Machines (1/300 Amp. or over)*; Welding machines (one to five)*

CLASS 4. Lattice Boom Crawler Cranes; Lattice Boom Truck Cranes; Telescopic Truck-Mounted Cranes; Tower Cranes.

* Combinations of one to eight of any Air Compressors, Conveyors, Welding Machines, Water Pumps, Light Plants, or Generators shall be in batteries or within 400 feet and shall be paid as per the Classification Schedule contained in this Article.

OPERATING ENGINEERS - HIGHWAY

CLASS 1. Asphalt Screed Man; Asphco Concrete Spreaders; Asphalt Pavers; Asphalt Plant Engineer; Asphalt Rollers on Bituminous Concrete; Athey Loaders; Backhoes; Barber Green Loaders; Bulldozers; Cableways; Carry Deck Pickers; Cherry Pickers (Rough Terrain); C.M.I. & similar type-autograde formless paver, autograde placer & finisher; Concrete Breakers; Concrete Plant Operators; Concrete Pumps; Derricks; Derrick Boats; Dewatering Systems; Earth Auger or Boring Machines; Elevating Graders; Engineers on Dredges; Gravel Processing Machines; Grout Pump; Head Equipment Greaser; High Lifts or Fork Lifts; Hoists with two or more drums or two or more load lines; Hydro Jet or Hydro Laser; Locomotives, All; Mechanics; Motor Graders or Auto Patrols; Multi-Point Power Lifting Equipment; Operators or Leverman on Dredges; Operators, Power Boat; Operators, Pug Mill (Asphalt Plants); Overhead Cranes; Paving Mixers; Piledrivers; Pipe Wrapping and Painting Machines; Push-dozers, or Push Cats; Robotic Controlled Equipment in this Classification; Rock Crushers; Ross Carrier or Similar Machines; Roto-Mill; Scoops, Skimmer, two cu. yd. capacity and under; Sheep-Foot Roller (Self Pro-pelled); Shovels; Skid Steer; Skimmer Scoops; Test Hole Drilling Machines; Tower Machines; Tower Mixers; Track Type End Loaders; Track Type Fork Lifts or High Lifts; Track Jacks and Tampers; Tractors, Side-boom; Trenching or Ditching Machine; Tunnelluggers; Vermeer-Type Saws; Wheel Type End Loaders; Winch Cat; Scoops, All or Tournapull.

CLASS 2. Air Compressors (six to eight)*; Articulated Dumps; Asphalt Boosters and Heaters; Asphalt Distributors; Asphalt Plant Fireman; Boom or Winch Trucks; Building Elevators; Bull Floats or Flexplanes; Concrete Finishing Machine; Concrete Saws, Self-Propelled; Concrete Spreading Machines; Conveyors (six to eight)*; Generators (six to eight)*; Gravel or Stone Spreader, Power Operated; Hoist, Automatic; Hoist with One Drum and One Load Line; Light Plants (six to eight)*; Mechanical Heaters (six to eight)*; Mud Jacks; Off Road Water Wagons; Oiler on Two Paving Mixers When Used in Tandem; Post Hole Digger, Mechanical; Robotic Controlled Equipment in This Classification; Road or Street Sweeper, Self-Propelled; Rollers (except bituminous concrete); Scissor Hoist; Sea-man Tiller; Straw Machine; Vibratory Compactor; Water Pumps (six to eight)*; Well Drill Machines.

CLASS 3. Air Compressors (one to five)*; Air Compressors, Track or Self-Propelled; Bulk Cement Batching Plants; Conveyors (one to five)*; Concrete Mixers (Except Plant, Paver, or Tower); Firemen; Generators (one to five)*; Greasers; Helper on Single Paving Mixer; Light Plants (one to five)*; Mechanic Helpers; Mechanical Heaters (one to five)*; Oilers; Power Form Graders; Power Sub-Graders; Pug Mills when used for other than Asphalt operation; Robotic Controlled Equipment in This Classification; Tractors without power attachments, regardless of size or type; Truck Crane Oiler and Driver (1 man); Vibratory Hammer (power source); Water Pumps (one to five)*; Welding Machines (one 300 Amp. or over)*; Welding Machines (one to five)*.

CLASS 4. Lattice Boom Crawler Crane; Lattice Boom Truck Crane; Telescopic Truck-Mounted Crane; Tower Crane.

*Combinations of one to eight of any Air Compressors, Conveyors, Welding Machines, Water Pumps, Light Plants or Generators shall be in batteries or within 400 feet and shall be paid as per the Classification Schedule contained in this Article.

Other Classifications of Work:

For definitions of classifications not otherwise set out, the

Department generally has on file such definitions which are available. If a task to be performed is not subject to one of the classifications of pay set out, the Department will upon being contacted state which neighboring county has such a classification and provide such rate, such rate being deemed to exist by reference in this document. If no neighboring county rate applies to the task, the Department shall undertake a special determination, such special determination being then deemed to have existed under this determination. If a project requires these, or any classification not listed, please contact IDOL at 217-782-1710 for wage rates or clarifications.

LANDSCAPING

Landscaping work falls under the existing classifications for laborer, operating engineer and truck driver. The work performed by landscape plantsman and landscape laborer is covered by the existing classification of laborer. The work performed by landscape operators (regardless of equipment used or its size) is covered by the classifications of operating engineer. The work performed by landscape truck drivers (regardless of size of truck driven) is covered by the classifications of truck driver.

Mercer County Prevailing Wage for May 2013

(See explanation of column headings at bottom of wages)

Trade Name	RG	TYP	C	Base	FRMAN	M-F>8	OSA	OSH	H/W	Pensn	Vac	Trng
ASBESTOS ABT-GEN		BLD		23.440	24.380	1.5	1.5	2.0	6.450	7.060	0.000	0.800
ASBESTOS ABT-GEN		HWY		25.650	26.650	1.5	1.5	2.0	6.450	7.060	0.000	0.800
ASBESTOS ABT-MEC		BLD		20.500	21.500	1.5	1.5	2.0	6.250	3.500	0.000	0.000
BOILERMAKER		BLD		35.010	38.010	2.0	2.0	2.0	7.070	13.83	0.000	0.300
BRICK MASON		BLD		26.500	28.000	1.5	1.5	2.0	8.050	5.430	0.000	0.500
CARPENTER		BLD		26.380	27.700	1.5	1.5	2.0	7.960	8.660	0.000	0.600
CARPENTER		HWY		27.640	29.390	1.5	1.5	2.0	9.080	11.34	0.000	0.450
CEMENT MASON		BLD		25.100	27.100	1.5	1.5	2.0	6.400	8.840	0.000	0.500
CEMENT MASON		HWY		25.460	26.460	1.5	1.5	2.0	6.750	9.640	0.000	0.500
CERAMIC TILE FNSHER		BLD		18.460	0.000	1.5	1.5	2.0	8.050	5.510	0.000	0.240
ELECTRIC PWR EQMT OP		ALL		35.440	0.000	1.5	1.5	2.0	5.000	10.98	0.000	0.270
ELECTRIC PWR GRNDMAN		ALL		24.320	0.000	1.5	1.5	2.0	5.000	7.540	0.000	0.180
ELECTRIC PWR LINEMAN		ALL		39.370	41.910	1.5	1.5	2.0	5.000	12.20	0.000	0.300
ELECTRIC PWR TRK DRV		ALL		25.510	0.000	1.5	1.5	2.0	5.000	7.920	0.000	0.190
ELECTRICIAN	NW	BLD		31.520	33.520	1.5	1.5	2.0	7.320	10.82	0.000	0.310
ELECTRICIAN	SE	BLD		30.190	32.690	1.5	1.5	2.0	5.350	9.390	0.000	0.400
ELECTRONIC SYS TECH		BLD		27.430	29.180	1.5	1.5	2.0	5.350	9.320	0.000	0.400
ELEVATOR CONSTRUCTOR		BLD		39.380	44.300	2.0	2.0	2.0	11.88	12.71	3.150	0.600
GLAZIER		BLD		26.360	27.860	1.5	1.5	2.0	6.940	6.520	0.000	0.350
HT/FROST INSULATOR		BLD		29.190	30.390	1.5	1.5	2.0	5.420	12.05	0.000	0.900
IRON WORKER		ALL		28.000	30.240	1.5	1.5	2.0	9.390	10.68	0.000	0.620
LABORER		BLD	1	21.940	22.820	1.5	1.5	2.0	6.450	7.060	0.000	0.800
LABORER		BLD	2	23.440	24.380	1.5	1.5	2.0	6.450	7.060	0.000	0.800
LABORER		BLD	3	24.090	25.050	1.5	1.5	2.0	6.450	7.060	0.000	0.800
LABORER		HWY	1	25.150	26.150	1.5	1.5	2.0	6.450	7.060	0.000	0.800
LABORER		HWY	2	25.650	26.650	1.5	1.5	2.0	6.450	7.060	0.000	0.800
LABORER		HWY	3	26.280	27.280	1.5	1.5	2.0	6.450	7.060	0.000	0.800
LATHER		BLD		26.380	27.700	1.5	1.5	2.0	7.960	8.660	0.000	0.600
MACHINIST		BLD		43.550	46.050	1.5	1.5	2.0	6.130	8.950	1.850	0.000
MARBLE FINISHERS		BLD		18.460	0.000	1.5	1.5	2.0	8.050	5.510	0.000	0.240
MARBLE MASON		BLD		22.800	23.300	1.5	1.5	2.0	8.050	5.510	0.000	0.240
MILLWRIGHT		BLD		27.250	28.950	1.5	1.5	2.0	6.700	12.32	0.000	0.500
MILLWRIGHT		HWY		26.740	28.440	1.5	1.5	2.0	6.700	12.32	0.000	0.500
OPERATING ENGINEER		BLD	1	29.900	31.900	1.5	1.5	2.0	15.40	6.600	1.500	0.850
OPERATING ENGINEER		BLD	2	28.300	31.900	1.5	1.5	2.0	15.40	6.600	1.500	0.850

OPERATING ENGINEER	BLD	3	27.150	31.900	1.5	1.5	2.0	15.40	6.600	1.500	0.850
OPERATING ENGINEER	BLD	4	30.150	31.900	1.5	1.5	2.0	15.40	6.600	1.500	0.850
OPERATING ENGINEER	BLD	5	30.650	31.900	1.5	1.5	2.0	15.40	6.600	1.500	0.850
OPERATING ENGINEER	BLD	6	31.150	31.900	1.5	1.5	2.0	15.40	6.600	1.500	0.850
OPERATING ENGINEER	BLD	7	30.900	31.900	1.5	1.5	2.0	15.40	6.600	1.500	0.850
OPERATING ENGINEER	HWY	1	29.900	31.900	1.5	1.5	2.0	15.40	6.600	1.500	0.850
OPERATING ENGINEER	HWY	2	28.300	31.900	1.5	1.5	2.0	15.40	6.600	1.500	0.850
OPERATING ENGINEER	HWY	3	27.150	31.900	1.5	1.5	2.0	15.40	6.600	1.500	0.850
OPERATING ENGINEER	HWY	4	30.150	31.900	1.5	1.5	2.0	15.40	6.600	1.500	0.850
OPERATING ENGINEER	HWY	5	30.650	31.900	1.5	1.5	2.0	15.40	6.600	1.500	0.850
OPERATING ENGINEER	HWY	6	31.150	31.900	1.5	1.5	2.0	15.40	6.600	1.500	0.850
OPERATING ENGINEER	HWY	7	30.400	31.900	1.5	1.5	2.0	15.40	6.600	1.500	0.850
OPERATING ENGINEER	HWY	8	30.900	31.900	1.5	1.5	2.0	15.40	6.600	1.500	0.850
PAINTER	ALL		27.320	28.320	1.5	1.5	1.5	5.000	6.100	0.000	0.600
PAINTER OVER 30FT	ALL		28.570	29.570	1.5	1.5	1.5	5.000	6.100	0.000	0.600
PAINTER PWR EQMT	ALL		27.820	28.820	1.5	1.5	1.5	5.000	6.100	0.000	0.600
PILEDRIVER	BLD		26.380	27.700	1.5	1.5	2.0	7.960	8.660	0.000	0.600
PILEDRIVER	HWY		27.640	29.390	1.5	1.5	2.0	9.080	11.34	0.000	0.450
PIPEFITTER	ALL		36.550	40.210	1.5	1.5	2.0	5.650	12.15	0.000	1.000
PLASTERER	BLD		27.800	29.800	1.5	1.5	2.0	6.600	6.500	0.000	0.600
PLUMBER	ALL		36.550	40.210	1.5	1.5	2.0	5.650	12.15	0.000	1.000
ROOFER	BLD		25.130	26.380	1.5	1.5	2.0	8.610	5.620	0.000	0.260
SHEETMETAL WORKER	BLD		30.070	32.070	1.5	1.5	2.0	7.140	10.54	0.000	0.540
SPRINKLER FITTER	BLD		36.390	39.140	1.5	1.5	2.0	8.420	8.500	0.000	0.450
STONE MASON	BLD		26.500	28.000	1.5	1.5	2.0	8.050	5.430	0.000	0.500
TERRAZZO FINISHER	BLD		18.460	0.000	1.5	1.5	2.0	8.050	5.510	0.000	0.240
TERRAZZO MASON	BLD		22.800	23.300	1.5	1.5	2.0	8.050	5.510	0.000	0.240
TILE LAYER	BLD		26.380	27.700	1.5	1.5	2.0	7.960	8.660	0.000	0.600
TILE MASON	BLD		22.800	23.300	1.5	1.5	2.0	8.050	5.510	0.000	0.240
TRUCK DRIVER	ALL	1	31.340	0.000	1.5	1.5	2.0	10.30	5.010	0.000	0.250
TRUCK DRIVER	ALL	2	31.780	0.000	1.5	1.5	2.0	10.30	5.010	0.000	0.250
TRUCK DRIVER	ALL	3	32.020	0.000	1.5	1.5	2.0	10.30	5.010	0.000	0.250
TRUCK DRIVER	ALL	4	32.280	0.000	1.5	1.5	2.0	10.30	5.010	0.000	0.250
TRUCK DRIVER	ALL	5	33.130	0.000	1.5	1.5	2.0	10.30	5.010	0.000	0.250
TRUCK DRIVER	O&C	1	25.070	0.000	1.5	1.5	2.0	10.30	5.010	0.000	0.250
TRUCK DRIVER	O&C	2	25.420	0.000	1.5	1.5	2.0	10.30	5.010	0.000	0.250
TRUCK DRIVER	O&C	3	25.620	0.000	1.5	1.5	2.0	10.30	5.010	0.000	0.250
TRUCK DRIVER	O&C	4	25.820	0.000	1.5	1.5	2.0	10.30	5.010	0.000	0.250
TRUCK DRIVER	O&C	5	26.500	0.000	1.5	1.5	2.0	10.30	5.010	0.000	0.250
TUCKPOINTER	BLD		26.500	28.000	1.5	1.5	2.0	8.050	5.430	0.000	0.500

Legend :

RG (Region)

TYP (Trade Type - All,Highway,Building,Floating,Oil & Chip,Rivers)

C (Class)

Base (Base Wage Rate)

FRMAN (Foreman Rate)

M-F>8 (OT required for any hour greater than 8 worked each day, Mon through Fri.)

OSA (Overtime (OT) is required for every hour worked on Saturday)

OSH (Overtime is required for every hour worked on Sunday and Holidays)

H/W (Health & Welfare Insurance)

Pensn (Pension)

Vac (Vacation)

Trng (Training)

Explanations

MERCER COUNTY

ELECTRICIAN (SOUTHEAST) - Townships of Ohio Grove, Suez, and North Henderson.

The following list is considered as those days for which holiday rates of wages for work performed apply: New Years Day, Memorial Day, Fourth of July, Labor Day, Thanksgiving Day, Christmas Day and Veterans Day in some classifications/counties. Generally, any of these holidays which fall on a Sunday is celebrated on the following Monday. This then makes work performed on that Monday payable at the appropriate overtime rate for holiday pay. Common practice in a given local may alter certain days of celebration. If in doubt, please check with IDOL.

Oil and chip resealing (O&C) means the application of road oils and liquid asphalt to coat an existing road surface, followed by application of aggregate chips or gravel to coated surface, and subsequent rolling of material to seal the surface.

EXPLANATION OF CLASSES

ASBESTOS - GENERAL - removal of asbestos material/mold and hazardous materials from any place in a building, including mechanical systems where those mechanical systems are to be removed. This includes the removal of asbestos materials/mold and hazardous materials from ductwork or pipes in a building when the building is to be demolished at the time or at some close future date.

ASBESTOS - MECHANICAL - removal of asbestos material from mechanical systems, such as pipes, ducts, and boilers, where the mechanical systems are to remain.

CERAMIC TIEL FINISHER, MARBLE FINISHER, TERRAZZO FINISHER

Assisting, helping or supporting the tile, marble and terrazzo mechanic by performing their historic and traditional work assignments required to complete the proper installation of the work covered by said crafts. The term "Ceramic" is used for naming the classification only and is in no way a limitation of the product handled. Ceramic takes into consideration most hard tiles.

ELECTRONIC SYSTEMS TECHNICIAN

Installation, service and maintenance of low-voltage systems which utilizes the transmission and/or transference of voice, sound, vision, or digital for commercial, education, security and entertainment purposes for the following: TV monitoring and surveillance, background/foreground music, intercom and telephone interconnect, field programming, inventory control systems, microwave transmission, multi-media, multiplex, radio page, school, intercom and sound burglar alarms and low voltage master clock systems.

Excluded from this classification are energy management systems, life safety systems, supervisory controls and data acquisition systems not intrinsic with the above listed systems, fire alarm systems, nurse call systems and raceways exceeding fifteen feet in length.

LABORER - BUILDING

Class 1: General laborer, carpenter tender, tool cribman, salamander tender, flagman, form handler, floor sweeper, material handler, fencing laborer, cleaning lumber, landscaper, unloading explosives, laying of sod, planting/removal of trees, wrecking laborer, unloading of Re-Bars, scaffold worker, signal man on crane.

Class 2: Handling of materials treated with creosote, kettle men, prime mover or motorized unit used for wet concrete or handling of building materials, vibrator operator, mortar mixer, power tools used under the jurisdiction of laborers, sand points, gunnite nozzle men, welders, cutters, burners and torchmen, chain saw operator, jackhammer and drill operators, paving breakers, air tamping hammerman, concrete saw operator, concrete burning machine operator, coring machine operator - hod carrier and plasterer tender.

Class 3: Caisson worker after 6 foot depth, dynamite man, asbestos abatement worker, tunnel miners - mixerman (plaster only), pump man.

LABORER - HEAVY & HIGHWAY

Class 1: Rod or chain man, flagman, dumpman, spotter, broom man, landscaper, planting and removal of trees, fencing laborers, dispatcher, ticket writer, scaleman, cleaning of forms or lumber (in bone yard), laying of sod, moving and/or maintenance of flares and barricades.

Class 2: Operation of all hand, electric, air, hydraulic or mechanically powered tools under the jurisdiction of Laborers' including jackhammers, tempers, air spades, augers, concrete saws, chain saws, utility saws, rock drills, vibrators, mortar mixer, power and hand saw (when clearing timber) general laborer (not elsewhere covered), craft-tender, material checker, material handler, form handler, concrete dumper, puddler, form setter helper, explosives handler, dynamite helper, center strip, reinforcing in concrete, wire mesh handler and installer, prime mover or any mechanical device taking the place of concrete buggy or wheelbarrow, sandpoint setter, asphalt kettleman. Sheeting hammer drivers, laying and jointing of telephone conduit, gas distribution men, pipe setter on laterals, drain tiles, culvert pipe, and storm sewer catch basin leads, catch basins, manholes, batch dumpers, tank cleaners, cofferdam workers, bankman on floating plant, jointman with pipelayers. Back-up man (corker, joint maker) with pipe setter on sewer and water mains, batterboard man or laser operator on sewer and water main, labor in ditch, or tunnel, on sewer or water mains and telephone conduit. Cutters, burners, torchman, gravel box man, asphalt plant laborers, concrete plant laborer, deck hand, unloading of steel and rebar, laser beam operator, wrecking laborers.

Class 3: Asphalt raker or luteman, head form setter, head dynamite man (powderman) head string or wireline man (on paving), pipe setter on sewer or water main, gunnite nozzle man, asphalt or concrete curb machine operator, head grade man, head tunnel miner, concrete burning machine operator, coring machine operator, welder.

OPERATING ENGINEERS - BUILDING

Class 1. Shovel; Concrete Spreader; Dipper Dredge Operator; Dipper Dredge Crane man; Dual Purpose Truck (boom, Boom, Winch, etc.); Mechanic-Welder; Pile Driver; Boom Tractor or Side Boom; Trenching Machine (40 H.P. and over); Building Hoist (1, 2 or 3 drums); Cleaning and Priming Machine; Backfiller (throw bucket); Locomotive Engineer; Concrete Paver; Slip Form Paver; Caisson Augering Machines; Mucking Machine; Asphalt Heater-Planer Unit; Laser Screed; Pug Mill; Concrete

Conveyor or Pump; Mechanical loaded Log Chippers or similar machines; Group Equipment Greaser; Off-Road Haul Units; Pipe Bending; Automatic Curbing Machines; Blastholer; Self-Propelled Rotary Drill or similar machines; Work Boat; Combination Concrete Finishing Machine and Float; Asphalt Paver Screed Operator; Forklift (6,000 lb. cap. or over or working heights 28 ft. and above); Chip Spreader; Straddle Carrier; Asphalt Paver; Asphalt Plant Operator; Boring Machine (Directional, Vertical, or Horizontal); Central Redi-Mix Plant Operator; Combination Backhoe Front End loader; Concrete Breaker or Hydro-Hammer (excluding walk-behinds); Concrete Wheel Saw (Large self-propelled - excluding walk-behinds); Crusher (Stone, Concrete, Asphalt, etc.); Curing-Tinning Machine; Excavator; Farm-type Tractor Operating Scoop or Scraper or with Power Attachment; Grader; Motor Grader; Motor Patrol; Auto Grader; Form Grader; Pull Grader; Sub Grader; Elevating Grader; Guard Rail Post Driver; Hoists; Hydraulic Dredge Leverman or Engineer; Hydro-Vac truck mounted or pull type (excluding hose work), and similar equipment; Loader (Track, Rubber Tire, or Articulated); Milling Machine (excluding walk-behinds); Road Widener-Shoulder Spreader; Scraper (Self-Propelled); Self-Propelled Roller or Tire Roller (on asphalt or Blacktop); Sheep Foot or Pad Foot Compactor (excluding walk-behinds); Steel Track-Type Tractor (Dozer, Push Cat, etc.); Transfer or Shuttle Buggy (excluding motorized wheel barrows and Georgia buggies).

Class 2. Asphalt Booster; Fireman and Pump Operator at Asphalt Plant; Mud Jack; Distributor; Self-propelled Roller (other than provided for in Class I); Pump Operator (more than one well-point pump); Trench Machine (under 40 H.P.); Forklift (less than 6,000 lb. cap. or working heights below 28 ft.); Gypsum Pump; Conveyor over 20 H.P.; Light Plant; Boiler (Engineer or Fireman); Mechanical Broom; Driver on Truck Crane or similar machines; Elevator (Permanent inside or Temporary outside); Farm-Type Tractor (without Power Attachment); Grout Pump (excluding hose work).

Class 3. Skid Loader; Oiler; Mechanic's Helper; Mechanical Heater (other than steam boiler); Small Outboard Motor Boat (Safety Boat and Life Boat); Engine Driven Welding Machine; Water Pumps; Air Compressor (400 c.f.m. or over); Deck Engineers.

Class 4. Leadman - Mechanic or Equipment Greaser.

Class 5. Track Excavator with Bucket (4 cubic yard and up to but not including 6 cubic yard).

Class 6. Track Excavator with Bucket (6 cubic yard and over).

Class 7. Crane (Friction or Hydraulic, regardless of size or attachments); Tow or Push Boat.

OPERATING ENGINEERS- HIGHWAY

Class 1. Shovel; Concrete Spreader; Dipper Dredge Operator; Dipper Dredge Crane man; Dual Purpose Truck (Boom, Winch, etc.); Mechanic-Welder; Pile Driver; Boom Tractor or Side Boom; Building Hoist (1, 2 or 3 drums); Cleaning and Priming Machine; Backfiller (throw bucket); Locomotive Engineer; Concrete Paver; Slip Form Paver; Caisson Augering Machines; Mucking Machine; Asphalt Heater Planer Unit; Laser Screed; Pug Mill; Concrete Conveyor or Pump (excluding truck-mounted); Mechanical loaded Log Chippers or similar machines; Group Equipment Greaser; off-road haul units; Pipe Bending; Automatic Curbing Machines; Blastholer; Self-propelled Rotary Drill or similar machines; Work Boat; Combination Concrete Finishing Machine and Float; Asphalt Paver Screed Operator; Forklift (6,000 lb. cap. or over or working heights above 28 ft.); Chip Spreader; Asphalt Paver; Asphalt Plant Operator; Boring Machine (Directional, Vertical, or Horizontal);

Central Redi-Mix Plant Operator; Combination Backhoe Front End loader; Concrete Breaker or Hydro-Hammer (excluding walk-behinds); Concrete Wheel Saw (Large self-propelled - excluding walk-behinds); Crusher (Stone, Concrete, Asphalt, etc.); Curing-Tinning Machine; Excavator; Farm-Type Tractor Operating Scoop or Scraper with Power Attachment; Grader; Motor Grader; Motor Patrol; Auto Grader; Form Grader; Pull Grader; Sub Grader; Elevating Grader; Guard Rail Post Driver; Hoists; Hydraulic Dredge Leverman or Engineer; Hydro-Vac truck mounted or pull type, and similar equipment; Loader (Track, Rubber Tire, or Articulated); Milling Machine (excluding walk-behinds); Road Widener-Shoulder Spreader; Scraper (self-propelled); Self-propelled Roller or Tire Roller (on asphalt or Blacktop); Sheep Foot or Pad Foot Compactor (excluding walk-behinds); Steel Track-Type Tractor (Dozer, Push Cat, etc.); Transfer or Shuttle Buggy (excluding motorized wheel barrows and Georgia buggies); Trenching Machine (40 H.P. and over).

Class 2. Asphalt Booster; Fireman and Pump Operator at Asphalt Plant; Mud Jack; Farm-Type Tractor without Power attachment; Distributor; Straddle Carrier; Self-propelled Roller or Compactor (other than provided for in Class I); Pump Operator (more than one well-point pump); Trench Machine (under 40 H.P.); Forklift (less than 6,000 lb. capacity or working heights below 28 ft.); Conveyor over 20 H.P.; Air Compressor (400 c.f.m. or over); Light Plant; Boiler (Engineer or Fireman); Mechanical Broom; Driver on Truck Crane or similar machines; Elevator (Permanent inside or Temporary outside); Grout Pump (excluding hose work).

Class 3. Oiler; Mechanic's Helper; Mechanical Heater (other than steam boiler); Small Outboard Motor Boat (Safety Boat and Life Boat); Engine Driven Welding Machine; skid steer.

Class 4. Leadman - Mechanic or Equipment Greaser.

Class 5. Track Excavator with Bucket (4 cubic yard and up to but not including 6 cubic yard).

Class 6. Track Excavator with Bucket (6 cubic yard and over).

Class 7. Truck mounted Concrete Conveyor or Pumps Extending to 90 ft. or more.

Class 8. Crane (Friction or Hydraulic, regardless of size or attachments); Tow or Push Boat.

TRUCK DRIVER - BUILDING, HEAVY AND HIGHWAY CONSTRUCTION

Class 1. Drivers on 2 axle trucks hauling less than 9 ton. Air compressor and welding machines and brooms, including those pulled by separate units, truck driver helpers, warehouse employees, mechanic helpers, greasers and tiremen, pickup trucks when hauling materials, tools, or workers to and from and on-the-job site, and fork lifts up to 6,000 lb. capacity.

Class 2. Two or three axle trucks hauling more than 9 ton but hauling less than 16 ton. A-frame winch trucks, hydrolift trucks, vector trucks or similar equipment when used for transportation purposes. Fork lifts over 6,000 lb. capacity, winch trucks, four axle combination units, and ticket writers.

Class 3. Two, three or four axle trucks hauling 16 ton or more. Drivers on water pulls, articulated dump trucks, mechanics and working forepersons, and dispatchers. Five axle or more combination units.

Class 4. Low Boy and Oil Distributors.

Class 5. Drivers who require special protective clothing while employed on hazardous waste work.

TRUCK DRIVER - OIL AND CHIP RESEALING ONLY.

This shall encompass laborers, workers and mechanics who drive contractor or subcontractor owned, leased, or hired pickup, dump, service, or oil distributor trucks. The work includes transporting materials and equipment (including but not limited to, oils, aggregate supplies, parts, machinery and tools) to or from the job site; distributing oil or liquid asphalt and aggregate; stock piling material when in connection with the actual oil and chip contract. The Truck Driver (Oil & Chip Resealing) wage classification does not include supplier delivered materials.

Other Classifications of Work:

For definitions of classifications not otherwise set out, the Department generally has on file such definitions which are available. If a task to be performed is not subject to one of the classifications of pay set out, the Department will upon being contacted state which neighboring county has such a classification and provide such rate, such rate being deemed to exist by reference in this document. If no neighboring county rate applies to the task, the Department shall undertake a special determination, such special determination being then deemed to have existed under this determination. If a project requires these, or any classification not listed, please contact IDOL at 217-782-1710 for wage rates or clarifications.

LANDSCAPING

Landscaping work falls under the existing classifications for laborer, operating engineer and truck driver. The work performed by landscape plantsman and landscape laborer is covered by the existing classification of laborer. The work performed by landscape operators (regardless of equipment used or its size) is covered by the classifications of operating engineer. The work performed by landscape truck drivers (regardless of size of truck driven) is covered by the classifications of truck driver.

Monroe County Prevailing Wage for May 2013

(See explanation of column headings at bottom of wages)

Trade Name	RG	TYP	C	Base	FRMAN	M-F>8	OSA	OSH	H/W	Pensn	Vac	Trng
=====	==	===	=	=====	=====	=====	===	===	=====	=====	=====	=====
ASBESTOS ABT-GEN		ALL		27.000	27.500	1.5	1.5	2.0	5.750	13.70	0.000	0.800
ASBESTOS ABT-MEC		BLD		29.860	30.860	1.5	1.5	2.0	6.950	3.000	0.000	0.000
BOILERMAKER		BLD		31.500	34.000	1.5	1.5	2.0	7.070	18.73	1.000	0.350
BRICK MASON		BLD		29.280	33.160	1.5	1.5	2.0	7.750	9.430	2.000	0.400
CARPENTER		ALL		34.630	36.130	1.5	1.5	2.0	6.550	6.750	0.000	0.400
CEMENT MASON		ALL		31.000	32.000	1.5	1.5	2.0	9.250	11.75	0.000	0.200
CERAMIC TILE FNSHER		BLD		25.890	0.000	1.5	1.5	2.0	6.000	5.200	0.000	0.530
ELECTRIC PWR EQMT OP		ALL		36.870	0.000	1.5	1.5	2.0	6.790	10.32	0.000	0.270
ELECTRIC PWR GRNDMAN		ALL		27.530	0.000	1.5	1.5	2.0	5.070	7.710	0.000	0.210
ELECTRIC PWR LINEMAN		ALL		42.400	44.450	1.5	1.5	2.0	7.810	11.87	0.000	0.320
ELECTRIC PWR TRK DRV		ALL		30.100	0.000	1.5	1.5	2.0	5.540	8.430	0.000	0.230
ELECTRICIAN		ALL		36.510	38.700	1.5	1.5	2.0	7.210	7.490	0.000	0.640
ELECTRONIC SYS TECH		BLD		30.720	31.670	1.5	1.5	2.0	3.350	7.420	0.000	0.400
ELEVATOR CONSTRUCTOR		BLD		43.715	49.180	2.0	2.0	2.0	11.88	12.71	3.500	0.600
FLOOR LAYER		BLD		29.330	30.080	1.5	1.5	2.0	6.550	6.750	0.000	0.400

GLAZIER	BLD	32.780	0.000	2.0	2.0	2.0	9.020	10.80	2.630	0.310
HT/FROST INSULATOR	BLD	37.260	38.260	1.5	1.5	2.0	7.850	11.16	0.000	0.500
IRON WORKER	ALL	31.500	33.500	1.5	1.5	2.0	7.610	13.33	0.000	0.420
LABORER	ALL	26.500	27.000	1.5	1.5	2.0	5.750	13.70	0.000	0.800
MACHINIST	BLD	43.550	46.050	1.5	1.5	2.0	6.130	8.950	1.850	0.000
MARBLE FINISHERS	BLD	25.890	0.000	1.5	1.5	2.0	6.000	5.200	0.000	0.530
MARBLE MASON	BLD	29.280	33.160	1.5	1.5	2.0	7.750	9.430	2.000	0.400
MILLWRIGHT	ALL	34.630	36.130	1.5	1.5	2.0	6.550	6.750	0.000	0.400
OPERATING ENGINEER	BLD 1	34.200	37.200	1.5	1.5	2.0	9.000	17.00	0.000	1.000
OPERATING ENGINEER	BLD 2	33.070	37.200	1.5	1.5	2.0	9.000	17.00	0.000	1.000
OPERATING ENGINEER	BLD 3	28.590	37.200	1.5	1.5	2.0	9.000	17.00	0.000	1.000
OPERATING ENGINEER	BLD 4	28.650	37.200	1.5	1.5	2.0	9.000	17.00	0.000	1.000
OPERATING ENGINEER	BLD 5	28.320	37.200	1.5	1.5	2.0	9.000	17.00	0.000	1.000
OPERATING ENGINEER	BLD 6	35.750	37.200	1.5	1.5	2.0	9.000	17.00	0.000	1.000
OPERATING ENGINEER	BLD 7	36.050	37.200	1.5	1.5	2.0	9.000	17.00	0.000	1.000
OPERATING ENGINEER	BLD 8	36.330	37.200	1.5	1.5	2.0	9.000	17.00	0.000	1.000
OPERATING ENGINEER	BLD 9	35.650	37.200	1.5	1.5	2.0	9.000	17.00	0.000	1.000
OPERATING ENGINEER	HWY 1	32.700	35.700	1.5	1.5	2.0	9.000	17.00	0.000	1.000
OPERATING ENGINEER	HWY 2	31.570	35.700	1.5	1.5	2.0	9.000	17.00	0.000	1.000
OPERATING ENGINEER	HWY 3	27.090	35.700	1.5	1.5	2.0	9.000	17.00	0.000	1.000
OPERATING ENGINEER	HWY 4	27.150	35.700	1.5	1.5	2.0	9.000	17.00	0.000	1.000
OPERATING ENGINEER	HWY 5	26.820	35.700	1.5	1.5	2.0	9.000	17.00	0.000	1.000
OPERATING ENGINEER	HWY 6	34.250	35.700	1.5	1.5	2.0	9.000	17.00	0.000	1.000
OPERATING ENGINEER	HWY 7	34.550	35.700	1.5	1.5	2.0	9.000	17.00	0.000	1.000
OPERATING ENGINEER	HWY 8	34.830	35.700	1.5	1.5	2.0	9.000	17.00	0.000	1.000
OPERATING ENGINEER	HWY 9	34.150	35.700	1.5	1.5	2.0	9.000	17.00	0.000	1.000
PAINTER	BLD	29.250	30.750	1.5	1.5	2.0	5.000	7.920	0.000	0.600
PAINTER	HWY	30.450	31.950	1.5	1.5	2.0	5.000	7.920	0.000	0.600
PAINTER OVER 30FT	BLD	30.250	31.750	1.5	1.5	2.0	5.000	7.920	0.000	0.600
PAINTER PWR EQMT	BLD	30.250	31.750	1.5	1.5	2.0	5.000	7.920	0.000	0.600
PAINTER PWR EQMT	HWY	31.450	32.950	1.5	1.5	2.0	5.000	7.920	0.000	0.600
PILEDRIVER	ALL	34.630	36.130	1.5	1.5	2.0	6.550	6.750	0.000	0.400
PIPEFITTER	BLD	37.250	39.250	1.5	1.5	2.0	6.740	8.000	0.000	0.750
PLASTERER	BLD	30.250	31.250	1.5	1.5	2.0	9.250	8.600	0.000	0.050
PLUMBER	BLD	36.300	38.800	1.5	1.5	2.0	6.250	6.850	0.000	0.500
ROOFER	BLD	29.500	31.500	1.5	1.5	2.0	8.600	6.850	0.000	0.200
SHEETMETAL WORKER	ALL	31.690	33.190	1.5	1.5	2.0	7.130	6.730	1.910	0.360
SPRINKLER FITTER	BLD	38.780	41.780	2.0	2.0	2.0	8.370	11.18	0.000	1.000
TERRAZZO FINISHER	BLD	31.240	0.000	1.5	1.5	2.0	6.000	3.230	0.000	0.200
TERRAZZO MASON	BLD	32.530	32.830	1.5	1.5	2.0	6.000	5.230	0.000	0.210
TRUCK DRIVER	ALL 1	31.340	0.000	1.5	1.5	2.0	10.30	5.010	0.000	0.250
TRUCK DRIVER	ALL 2	31.780	0.000	1.5	1.5	2.0	10.30	5.010	0.000	0.250
TRUCK DRIVER	ALL 3	32.020	0.000	1.5	1.5	2.0	10.30	5.010	0.000	0.250
TRUCK DRIVER	ALL 4	32.280	0.000	1.5	1.5	2.0	10.30	5.010	0.000	0.250
TRUCK DRIVER	ALL 5	33.130	0.000	1.5	1.5	2.0	10.30	5.010	0.000	0.250
TRUCK DRIVER	O&C 1	25.070	0.000	1.5	1.5	2.0	10.30	5.010	0.000	0.250
TRUCK DRIVER	O&C 2	25.420	0.000	1.5	1.5	2.0	10.30	5.010	0.000	0.250
TRUCK DRIVER	O&C 3	25.620	0.000	1.5	1.5	2.0	10.30	5.010	0.000	0.250
TRUCK DRIVER	O&C 4	25.820	0.000	1.5	1.5	2.0	10.30	5.010	0.000	0.250
TRUCK DRIVER	O&C 5	26.500	0.000	1.5	1.5	2.0	10.30	5.010	0.000	0.250

Legend :

RG (Region)

TYP (Trade Type - All,Highway,Building,Floating,Oil & Chip,Rivers)

C (Class)

Base (Base Wage Rate)

FRMAN (Foreman Rate)

M-F>8 (OT required for any hour greater than 8 worked each day, Mon through Fri.)

OSA (Overtime (OT) is required for every hour worked on Saturday)

OSH (Overtime is required for every hour worked on Sunday and Holidays)

H/W (Health & Welfare Insurance)

Pensn (Pension)

Vac (Vacation)

Trng (Training)

Explanations

MONROE COUNTY

The following list is considered as those days for which holiday rates of wages for work performed apply: New Years Day, Memorial Day, Fourth of July, Labor Day, Thanksgiving Day, Christmas Day and Veterans Day in some classifications/counties. Generally, any of these holidays which fall on a Sunday is celebrated on the following Monday. This then makes work performed on that Monday payable at the appropriate overtime rate for holiday pay. Common practice in a given local may alter certain days of celebration. If in doubt, please check with IDOL.

Oil and chip resealing (O&C) means the application of road oils and liquid asphalt to coat an existing road surface, followed by application of aggregate chips or gravel to coated surface, and subsequent rolling of material to seal the surface.

EXPLANATION OF CLASSES

ASBESTOS - GENERAL - removal of asbestos material/mold and hazardous materials from any place in a building, including mechanical systems where those mechanical systems are to be removed. This includes the removal of asbestos materials/mold and hazardous materials from ductwork or pipes in a building when the building is to be demolished at the time or at some close future date.

ASBESTOS - MECHANICAL - removal of asbestos material from mechanical systems, such as pipes, ducts, and boilers, where the mechanical systems are to remain.

CERAMIC TILE FINISHER AND MARBLE FINISHER

The handling, at the building site, of all sand, cement, tile, marble or stone and all other materials that may be used and installed by [a] tile layer or marble mason. In addition, the grouting, cleaning, sealing, and mixing on the job site, and all other work as required in assisting the setter. The term "Ceramic" is used for naming the classification only and is in no way a limitation of the product handled. Ceramic takes into consideration most hard tiles.

ELECTRONIC SYSTEMS TECHNICIAN

Installation, service and maintenance of low-voltage systems which utilizes the transmission and/or transference of voice, sound, vision, or digital for commercial, education, security and entertainment

purposes for the following: TV monitoring and surveillance, background/foreground music, intercom and telephone interconnect, field programming, inventory control systems, microwave transmission, multi-media, multiplex, radio page, school, intercom and sound burglar alarms and low voltage master clock systems.

Excluded from this classification are energy management systems, life safety systems, supervisory controls and data acquisition systems not intrinsic with the above listed systems, fire alarm systems, nurse call systems and raceways exceeding fifteen feet in length.

OPERATING ENGINEER - BUILDING

GROUP I. Cranes, Dragline, Shovels, Skimmer Scoops, Clamshells or Derrick Boats, Pile Drivers, Crane-Type Backhoes, Asphalt Plant Operators, Concrete Plant Operators, Dredges, Asphalt Spreading Machines, All Locomotives, Cable Ways or Tower Machines, Hoists, Hydraulic Backhoes, Ditching Machines or Backfiller, Cherrypickers, Overhead Cranes, Roller - Steam or Gas, Concrete Pavers, Excavators, Concrete Breakers, Concrete Pumps, Bulk Cement Plants, Cement Pumps, Derrick-Type Drills, Boat Operators, Motor Graders or Pushcats, Scoops or Tournapulls, Bulldozers, Endloaders or Fork Lifts, Power Blade or Elevating Graders, Winch Cats, Boom or Winch Trucks or Boom Tractors, Pipe Wrapping or Painting Machines, Asphalt Plant Engineer, Journeyman Lubricating Engineer, Drills (other than Derrick Type), Mud Jacks, or Well Drilling Machines, Boring Machines or Track Jacks, Mixers, Conveyors (Two), Air Compressors (Two), Water Pumps regardless of size (Two), Welding Machines (Two), Siphons or Jets (Two), Winch Heads or Apparatuses (Two), Light Plants (Two), All Tractors regardless of size (straight tractor only), Fireman on Stationary Boilers, Automatic Elevators, Form Grading Machines, Finishing Machines, Power Sub-Grader or Ribbon Machines, Longitudinal Floats, Distributor Operators on Trucks, Winch Heads or Apparatuses (One), Mobil Track air and heaters (two to five), Heavy Equipment Greaser, Relief Operator, Assistant Master Mechanic and Heavy Duty Mechanic, self-propelled concrete saws of all types and sizes with their attachments, gob-hoppers, excavators all sizes, the repair and greasing of all diesel hammers, the operation and set-up of bidwells, water blasters of all sizes and their clutches, hydraulic jacks where used for hoisting, operation of log skidders, iceolators used on and off of pipeline, condor cranes, bow boats, survey boats, bobcats and all their attachments, skid steer loaders and all their attachments, creter cranes, batch plants, operator (all sizes), self propelled roto mills, operation of conveyor systems of any size and any configuration, operation, repair and service of all vibratory hammers, all power pacs and their controls regardless of location, curtains or brush burning machines, stump cutter machines, Nail launchers when mounted on a machine or self-propelled, operation of con-cover machines, and all Operators except those listed below).

GROUP II. Assistant Operators.

GROUP III. Air Compressors (One), Water Pumps, regardless of Size (One), Waterblasters (one), Welding Machine (One), Mixers (One Bag), Conveyor (One), Siphon or Jet (One), Light Plant (One), Heater (One), Immobile Track Air (One), and Self Propelled Walk-Behind Rollers.

GROUP IV. Asphalt Spreader Oilers, Fireman on Whirlies and Heavy Equipment Oilers, Truck Cranes, Dredges, Monigans, Large Cranes - (Over 65-ton rated capacity) Concrete Plant Oiler, Blacktop Plant Oiler, and Creter Crane Oiler (when required).

GROUP V. Oiler.

GROUP VI. Operators on equipment with Booms, including jibs, 100 feet

and over, and less than 150 feet long.

GROUP VII. Operators on equipment with Booms, including jibs, 150 feet and over, and less than 200 feet long.

GROUP VIII. Operators on Equipment with Booms, including jibs, 200 feet and over; Tower Cranes; and Whirlie Cranes.

GROUP IX. Master Mechanic

OPERATING ENGINEERS - Highway

GROUP I. Cranes, Dragline, Shovels, Skimmer Scoops, Clamshells or Derrick Boats, Pile Drivers, Crane-Type Backhoes, Asphalt Plant Operators, Concrete Plant Operators, Dredges, Asphalt Spreading Machines, All Locomotives, Cable Ways or Tower Machines, Hoists, Hydraulic Backhoes, Ditching Machines or Backfiller, Cherrypickers, Overhead Cranes, Roller - Steam or Gas, Concrete Pavers, Excavators, Concrete Breakers, Concrete Pumps, Bulk Cement Plants, Cement Pumps, Derrick-Type Drills, Boat Operators, Motor Graders or Pushcats, Scoops or Tournapulls, Bulldozers, Endloaders or Fork Lifts, Power Blade or Elevating Graders, Winch Cats, Boom or Winch Trucks or Boom Tractors, Pipe Wrapping or Painting Machines, Asphalt Plant Engineer, Journeyman Lubricating Engineer, Drills (other than Derrick Type), Mud Jacks, Well Drilling Machines, Boring Machines, Track Jacks, Mixers, Conveyors (Two), Air Compressors (Two), Water Pumps regardless of size (Two), Welding Machines (Two), Siphons or Jets (Two), Winch Heads or Apparatuses (Two), Light Plants (Two), All Tractors regardless of size (straight tractor only), Fireman on Stationary Boilers, Automatic Elevators, Form Grading Machines, Finishing Machines, Power Sub-Grader or Ribbon Machines, Longitudinal Floats, Distributor Operators on Trucks, Winch Heads or Apparatuses (One), Mobil Track air and heaters (two to five), Heavy Equipment Greaser, Relief Operator, Assistant Master Mechanic and Heavy Duty Mechanic, self-propelled concrete saws of all types and sizes with their attachments, gob-hoppers, excavators all sizes, the repair and greasing of all diesel hammers, the operation and set-up of bidwells, water blasters of all sizes and their clutches, hydraulic jacks where used for hoisting, operation of log skidders, iceolators used on and off of pipeline, condor cranes, bow boats, survey boats, bobcats and all their attachments, skid steer loaders and all their attachments, creter cranes, batch plants, operator (all sizes), self propelled roto mills, operation of conveyor systems of any size and any configuration, operation, repair and service of all vibratory hammers, all power pacs and their controls regardless of location, curtains or brush burning machines, stump cutter machines, Nail launchers when mounted on a machine or self-propelled, operation of con-cover machines, and all Operators (except those listed below).

GROUP II. Assistant Operators.

GROUP III. Air Compressors (One), Water Pumps, regardless of Size (One), Waterblasters (one), Welding Machine (One), Mixers (One Bag), Conveyor (One), Siphon or Jet (One), Light Plant (One), Heater (One), Immobile Track Air (One), and Self Propelled Walk-Behind Rollers.

GROUP IV. Asphalt Spreader Oilers, Fireman on Whirlies and Heavy Equipment Oilers, Truck Cranes, Dredges, Monigans, Large Cranes - (Over 65-ton rated capacity) Concrete Plant Oiler, Blacktop Plant Oiler, and Creter Crane Oiler (when required).

GROUP V. Oiler.

GROUP VI. Operators on equipment with Booms, including jibs, 100 feet

and over, and less than 150 feet long.

GROUP VII. Operators on equipment with Booms, including jibs, 150 feet and over, and less than 200 feet long.

GROUP VIII. Operators on Equipment with Booms, including jibs, 200 feet and over; Tower Cranes; and Whirlie Cranes.

GROUP IX. Mechanic

TRUCK DRIVER - BUILDING, HEAVY AND HIGHWAY CONSTRUCTION

Class 1. Drivers on 2 axle trucks hauling less than 9 ton. Air compressor and welding machines and brooms, including those pulled by separate units, truck driver helpers, warehouse employees, mechanic helpers, greasers and tiremen, pickup trucks when hauling materials, tools, or workers to and from and on-the-job site, and fork lifts up to 6,000 lb. capacity.

Class 2. Two or three axle trucks hauling more than 9 ton but hauling less than 16 ton. A-frame winch trucks, hydrolift trucks, vactor trucks or similar equipment when used for transportation purposes. Fork lifts over 6,000 lb. capacity, winch trucks, four axle combination units, and ticket writers.

Class 3. Two, three or four axle trucks hauling 16 ton or more. Drivers on water pulls, articulated dump trucks, mechanics and working forepersons, and dispatchers. Five axle or more combination units.

Class 4. Low Boy and Oil Distributors.

Class 5. Drivers who require special protective clothing while employed on hazardous waste work.

TRUCK DRIVER - OIL AND CHIP RESEALING ONLY.

This shall encompass laborers, workers and mechanics who drive contractor or subcontractor owned, leased, or hired pickup, dump, service, or oil distributor trucks. The work includes transporting materials and equipment (including but not limited to, oils, aggregate supplies, parts, machinery and tools) to or from the job site; distributing oil or liquid asphalt and aggregate; stock piling material when in connection with the actual oil and chip contract. The Truck Driver (Oil & Chip Resealing) wage classification does not include supplier delivered materials.

TERRAZZO FINISHER

The handling of all materials used for Mosaic and Terrazzo work including preparing, mixing by hand, by mixing machine or transporting of pre-mixed materials and distributing with shovel, rake, hoe, or pail, all kinds of concrete foundations necessary for Mosaic and Terrazzo work, all cement terrazzo, magnesite terrazzo, Do-O-Tex terrazzo, epoxy matrix ter-razzo, exposed aggregate, rustic or rough washed for exterior or interior of buildings placed either by machine or by hand, and any other kind of mixture of plastics composed of chips or granules when mixed with cement, rubber, neoprene, vinyl, magnesium chloride or any other resinous or chemical substances used for seamless flooring systems, and all other building materials, all similar materials and all precast terrazzo work on jobs, all scratch coat used for Mosaic and Terrazzo work and sub-bed, tar paper and wire mesh (2x2 etc.) or lath. The rubbing, grinding, cleaning and finishing of same either by hand or by machine or by terrazzo resurfacing equipment on new or existing floors. When necessary

finishers shall be allowed to assist the mechanics to spread sand bed, lay tarpaper and wire mesh (2x2 etc.) or lath. The finishing of cement floors where additional aggregate of stone is added by spreading or sprinkling on top of the finished base, and troweled or rolled into the finish and then the surface is ground by grinding machines.

Other Classifications of Work:

For definitions of classifications not otherwise set out, the Department generally has on file such definitions which are available. If a task to be performed is not subject to one of the classifications of pay set out, the Department will upon being contacted state which neighboring county has such a classification and provide such rate, such rate being deemed to exist by reference in this document. If no neighboring county rate applies to the task, the Department shall undertake a special determination, such special determination being then deemed to have existed under this determination. If a project requires these, or any classification not listed, please contact IDOL at 217-782-1710 for wage rates or clarifications.

LANDSCAPING

Landscaping work falls under the existing classifications for laborer, operating engineer and truck driver. The work performed by landscape plantsman and landscape laborer is covered by the existing classification of laborer. The work performed by landscape operators (regardless of equipment used or its size) is covered by the classifications of operating engineer. The work performed by landscape truck drivers (regardless of size of truck driven) is covered by the classifications of truck driver.

Montgomery County Prevailing Wage for May 2013

(See explanation of column headings at bottom of wages)

Trade Name	RG	TYP	C	Base	FRMAN	M-F>8	OSA	OSH	H/W	Pensn	Vac	Trng
=====	==	===	=	=====	=====	=====	===	===	=====	=====	=====	=====
ASBESTOS ABT-GEN		ALL		25.950	26.450	1.5	1.5	2.0	5.750	14.75	0.000	0.800
ASBESTOS ABT-MEC		BLD		29.860	30.860	1.5	1.5	2.0	6.950	3.000	0.000	0.000
BOILERMAKER		BLD		31.500	34.000	1.5	1.5	2.0	7.070	18.73	1.000	0.350
BRICK MASON		BLD		29.280	33.160	1.5	1.5	2.0	7.750	9.430	2.000	0.400
CARPENTER		BLD		28.850	31.100	1.5	1.5	2.0	7.450	13.40	0.000	0.520
CARPENTER		HWY		29.450	31.200	1.5	1.5	2.0	7.450	13.35	0.000	0.520
CEMENT MASON		ALL		31.000	32.000	1.5	1.5	2.0	9.250	11.75	0.000	0.200
CERAMIC TILE FNSHER		BLD		25.890	0.000	1.5	1.5	2.0	6.000	5.200	0.000	0.530
ELECTRIC PWR EQMT OP NE		ALL		35.440	0.000	1.5	1.5	2.0	5.000	10.98	0.000	0.270
ELECTRIC PWR EQMT OP SW		ALL		36.870	0.000	1.5	1.5	2.0	6.790	10.32	0.000	0.270
ELECTRIC PWR GRNDMAN NE		ALL		24.320	0.000	1.5	1.5	2.0	5.000	7.540	0.000	0.180
ELECTRIC PWR GRNDMAN SW		ALL		27.530	0.000	1.5	1.5	2.0	5.070	7.710	0.000	0.210
ELECTRIC PWR LINEMAN NE		ALL		39.370	41.910	1.5	1.5	2.0	5.000	12.20	0.000	0.300
ELECTRIC PWR LINEMAN SW		ALL		42.400	44.450	1.5	1.5	2.0	7.810	11.87	0.000	0.320
ELECTRIC PWR TRK DRV NE		ALL		25.510	0.000	1.5	1.5	2.0	5.000	7.920	0.000	0.190
ELECTRIC PWR TRK DRV SW		ALL		30.100	0.000	1.5	1.5	2.0	5.540	8.430	0.000	0.230
ELECTRICIAN		E BLD		34.200	37.620	1.5	1.5	2.0	5.350	7.610	0.000	0.510
ELECTRICIAN		NW BLD		34.220	36.220	1.5	1.5	2.0	5.860	8.120	0.000	0.400
ELECTRICIAN		SW ALL		36.510	38.700	1.5	1.5	2.0	7.810	7.490	0.000	0.640
ELECTRONIC SYS TECH E		BLD		31.130	32.880	1.5	1.5	2.0	5.350	6.110	0.000	0.400
ELECTRONIC SYS TECH W		BLD		30.720	32.470	1.5	1.5	2.0	3.650	7.920	0.000	0.400
ELEVATOR CONSTRUCTOR		BLD		43.715	49.180	2.0	2.0	2.0	11.88	12.71	3.500	0.600
GLAZIER		BLD		30.780	32.780	1.5	2.0	2.0	6.630	8.150	0.000	0.380
HT/FROST INSULATOR		BLD		37.260	38.260	1.5	1.5	2.0	7.850	11.16	0.000	0.500

IRON WORKER	N	BLD	29.460	31.460	1.5	1.5	2.0	7.740	11.38	0.000	0.660
IRON WORKER	N	HWY	30.600	32.100	1.5	1.5	2.0	7.740	11.69	0.000	0.660
IRON WORKER	S	ALL	31.500	33.500	1.5	1.5	2.0	7.610	13.33	0.000	0.420
LABORER		ALL	25.450	25.950	1.5	1.5	2.0	5.750	14.75	0.000	0.800
LATHER		BLD	28.850	31.100	1.5	1.5	2.0	7.450	13.40	0.000	0.520
MACHINIST		BLD	43.550	46.050	1.5	1.5	2.0	6.130	8.950	1.850	0.000
MARBLE FINISHERS		BLD	25.890	0.000	1.5	1.5	2.0	6.000	5.200	0.000	0.530
MILLWRIGHT		BLD	29.620	31.870	1.5	1.5	2.0	7.450	13.09	0.000	0.520
MILLWRIGHT		HWY	31.690	33.440	1.5	1.5	2.0	7.450	13.54	0.000	0.520
OPERATING ENGINEER		BLD 1	34.200	37.200	1.5	1.5	2.0	9.000	17.00	0.000	1.000
OPERATING ENGINEER		BLD 2	33.070	37.200	1.5	1.5	2.0	9.000	17.00	0.000	1.000
OPERATING ENGINEER		BLD 3	28.590	37.200	1.5	1.5	2.0	9.000	17.00	0.000	1.000
OPERATING ENGINEER		BLD 4	28.650	37.200	1.5	1.5	2.0	9.000	17.00	0.000	1.000
OPERATING ENGINEER		BLD 5	28.320	37.200	1.5	1.5	2.0	9.000	17.00	0.000	1.000
OPERATING ENGINEER		BLD 6	35.750	37.200	1.5	1.5	2.0	9.000	17.00	0.000	1.000
OPERATING ENGINEER		BLD 7	36.050	37.200	1.5	1.5	2.0	9.000	17.00	0.000	1.000
OPERATING ENGINEER		BLD 8	36.330	37.200	1.5	1.5	2.0	9.000	17.00	0.000	1.000
OPERATING ENGINEER		BLD 9	35.650	37.200	1.5	1.5	2.0	9.000	17.00	0.000	1.000
OPERATING ENGINEER		HWY 1	32.700	35.700	1.5	1.5	2.0	9.000	17.00	0.000	1.000
OPERATING ENGINEER		HWY 2	31.570	35.700	1.5	1.5	2.0	9.000	17.00	0.000	1.000
OPERATING ENGINEER		HWY 3	27.090	35.700	1.5	1.5	2.0	9.000	17.00	0.000	1.000
OPERATING ENGINEER		HWY 4	27.150	35.700	1.5	1.5	2.0	9.000	17.00	0.000	1.000
OPERATING ENGINEER		HWY 5	26.820	35.700	1.5	1.5	2.0	9.000	17.00	0.000	1.000
OPERATING ENGINEER		HWY 6	34.250	35.700	1.5	1.5	2.0	9.000	17.00	0.000	1.000
OPERATING ENGINEER		HWY 7	34.550	35.700	1.5	1.5	2.0	9.000	17.00	0.000	1.000
OPERATING ENGINEER		HWY 8	34.830	35.700	1.5	1.5	2.0	9.000	17.00	0.000	1.000
OPERATING ENGINEER		HWY 9	34.150	35.700	1.5	1.5	2.0	9.000	17.00	0.000	1.000
PAINTER		BLD	29.250	30.750	1.5	1.5	2.0	5.000	7.920	0.000	0.600
PAINTER		HWY	30.450	31.950	1.5	1.5	2.0	5.000	7.920	0.000	0.600
PAINTER OVER 30FT		BLD	30.250	31.750	1.5	1.5	2.0	5.000	7.920	0.000	0.600
PAINTER PWR EQMT		BLD	30.250	31.750	1.5	1.5	2.0	5.000	7.920	0.000	0.600
PAINTER PWR EQMT		HWY	31.450	32.950	1.5	1.5	2.0	5.000	7.920	0.000	0.600
PILEDRIVER		BLD	29.350	31.600	1.5	1.5	2.0	7.450	13.40	0.000	0.520
PILEDRIVER		HWY	30.450	32.200	1.5	1.5	2.0	7.450	13.35	0.000	0.520
PIPEFITTER	NE	BLD	40.020	44.020	1.5	1.5	2.0	7.000	7.750	0.000	0.900
PIPEFITTER	SW	BLD	37.800	39.690	2.0	2.0	2.0	4.500	8.360	0.000	0.300
PLASTERER		BLD	30.250	31.250	1.5	1.5	2.0	9.250	8.600	0.000	0.050
PLUMBER	NE	BLD	40.020	44.020	1.5	1.5	2.0	7.000	7.750	0.000	0.900
PLUMBER	SW	BLD	37.800	39.690	2.0	2.0	2.0	4.500	8.360	0.000	0.300
ROOFER		BLD	27.900	30.400	1.5	1.5	2.0	8.600	6.750	0.000	0.500
SHEETMETAL WORKER		ALL	31.690	33.190	1.5	1.5	2.0	7.130	6.730	1.910	0.360
SPRINKLER FITTER		BLD	36.390	39.140	1.5	1.5	2.0	8.420	8.500	0.000	0.450
TERRAZZO FINISHER		BLD	31.240	0.000	1.5	1.5	2.0	6.000	3.230	0.000	0.200
TERRAZZO MASON		BLD	32.530	32.830	1.5	1.5	2.0	6.000	5.230	0.000	0.210
TRUCK DRIVER		ALL 1	31.340	0.000	1.5	1.5	2.0	10.30	5.010	0.000	0.250
TRUCK DRIVER		ALL 2	31.780	0.000	1.5	1.5	2.0	10.30	5.010	0.000	0.250
TRUCK DRIVER		ALL 3	32.020	0.000	1.5	1.5	2.0	10.30	5.010	0.000	0.250
TRUCK DRIVER		ALL 4	32.280	0.000	1.5	1.5	2.0	10.30	5.010	0.000	0.250
TRUCK DRIVER		ALL 5	33.130	0.000	1.5	1.5	2.0	10.30	5.010	0.000	0.250
TRUCK DRIVER		O&C 1	25.070	0.000	1.5	1.5	2.0	10.30	5.010	0.000	0.250
TRUCK DRIVER		O&C 2	25.420	0.000	1.5	1.5	2.0	10.30	5.010	0.000	0.250
TRUCK DRIVER		O&C 3	25.620	0.000	1.5	1.5	2.0	10.30	5.010	0.000	0.250
TRUCK DRIVER		O&C 4	25.820	0.000	1.5	1.5	2.0	10.30	5.010	0.000	0.250
TRUCK DRIVER		O&C 5	26.500	0.000	1.5	1.5	2.0	10.30	5.010	0.000	0.250

Legend :

RG (Region)

TYP (Trade Type - All,Highway,Building,Floating,Oil & Chip,Rivers)

C (Class)

Base (Base Wage Rate)

FRMAN (Foreman Rate)

M-F>8 (OT required for any hour greater than 8 worked each day, Mon through Fri.)

OSA (Overtime (OT) is required for every hour worked on Saturday)

OSH (Overtime is required for every hour worked on Sunday and Holidays)

H/W (Health & Welfare Insurance)

Pensn (Pension)

Vac (Vacation)

Trng (Training)

Explanations

MONTGOMERY COUNTY

CARPENTERS AND PILEDRIVERS (NORTH) - The area north of Route 108, running east to Route 55, then north to Routes 48/127, east following Route 48 from Raymond to Harvel.

ELECTRICIANS (EAST) - Townships of Audubon, East Fork, Fillmore, Irving, Nikomis, Roundtree, South Fillmore and Witt.

ELECTRICIANS (NW) - Townships of Bois D'Arc, Pitman, and Harvel (Northern projection).

ELECTRICIANS (SW) - Townships of Zanesville, Raymond, North and South Litchfield, Butler Grove, Hillsboro, Walshville and Grishman.

ELECTRIC POWER LINEMAN, GROUNDMAN, EQUIPMENT OPERATOR, TRUCK DRIVER (NE) - Entire county except Butler Grove, Grisham, Hillsboro, North and South Litchfield, Raymond, Walshville, and Zanesville Townships.

IRONWORKERS (NORTH) - That part of the county north of a diagonal line through Taylor Springs and Chapman.

PLUMBERS & PIPEFITTERS (SW) - That part of the county South and West of Route 127.

ELECTRONIC SYSTEMS TECHNICIAN (WEST) - Townships of Zanesville, Raymond, North Litchfield, Butler Grove, South Litchfield, Hillsboro, Walshville and Grisham.

The following list is considered as those days for which holiday rates of wages for work performed apply: New Years Day, Memorial Day, Fourth of July, Labor Day, Thanksgiving Day, Christmas Day and Veterans Day in some classifications/counties. Generally, any of these holidays which fall on a Sunday is celebrated on the following Monday. This then makes work performed on that Monday payable at the appropriate overtime rate for holiday pay. Common practice in a given local may alter certain days of celebration. If in doubt, please check with IDOL.

Oil and chip resealing (O&C) means the application of road oils and liquid asphalt to coat an existing road surface, followed by application of aggregate chips or gravel to coated surface, and subsequent rolling of material to seal the surface.

EXPLANATION OF CLASSES

ASBESTOS - GENERAL - removal of asbestos material/mold and hazardous materials from any place in a building, including mechanical systems where those mechanical systems are to be removed. This includes the removal of asbestos materials/mold and hazardous materials from ductwork or pipes in a building when the building is to be demolished at the time or at some close future date.

ASBESTOS - MECHANICAL - removal of asbestos material from mechanical systems, such as pipes, ducts, and boilers, where the mechanical systems are to remain.

CERAMIC TILE FINISHER AND MARBLE FINISHER

The handling, at the building site, of all sand, cement, tile, marble or stone and all other materials that may be used and installed by [a] tile layer or marble mason. In addition, the grouting, cleaning, sealing, and mixing on the job site, and all other work as required in assisting the setter. The term "Ceramic" is used for naming the classification only and is in no way a limitation of the product handled. Ceramic takes into consideration most hard tiles.

ELECTRONIC SYSTEMS ELECTRICIAN

Installation, service and maintenance of low-voltage systems which utilizes the transmission and/or transference of voice, sound, vision, or digital for commercial, education, security and entertainment purposes for the following: TV monitoring and surveillance, background/foreground music, intercom and telephone interconnect, field programming, inventory control systems, microwave transmission, multi-media, multiplex, radio page, school, intercom and sound burglar alarms and low voltage master clock systems.

Excluded from this classification are energy management systems, life safety systems, supervisory controls and data acquisition systems not intrinsic with the above listed systems, fire alarm systems, nurse call systems and raceways exceeding fifteen feet in length.

OPERATING ENGINEER - BUILDING

GROUP I. Cranes, Dragline, Shovels, Skimmer Scoops, Clamshells or Derrick Boats, Pile Drivers, Crane-Type Backhoes, Asphalt Plant Operators, Concrete Plant Operators, Dredges, Asphalt Spreading Machines, All Locomotives, Cable Ways or Tower Machines, Hoists, Hydraulic Backhoes, Ditching Machines or Backfiller, Cherrypickers, Overhead Cranes, Roller - Steam or Gas, Concrete Pavers, Excavators, Concrete Breakers, Concrete Pumps, Bulk Cement Plants, Cement Pumps, Derrick-Type Drills, Boat Operators, Motor Graders or Pushcats, Scoops or Tournapulls, Bulldozers, Endloaders or Fork Lifts, Power Blade or Elevating Graders, Winch Cats, Boom or Winch Trucks or Boom Tractors, Pipe Wrapping or Painting Machines, Asphalt Plant Engineer, Journeyman Lubricating Engineer, Drills (other than Derrick Type), Mud Jacks, or Well Drilling Machines, Boring Machines or Track Jacks, Mixers, Conveyors (Two), Air Compressors (Two), Water Pumps regardless of size (Two), Welding Machines (Two), Siphons or Jets (Two), Winch Heads or Apparatuses (Two), Light Plants (Two), All Tractors regardless of size (straight tractor only), Fireman on Stationary Boilers, Automatic Elevators, Form Grading Machines, Finishing Machines, Power Sub-Grader or Ribbon Machines, Longitudinal Floats, Distributor Operators on Trucks, Winch Heads or Apparatuses (One), Mobil Track air and heaters (two to five), Heavy Equipment Greaser, Relief Operator, Assistant Master Mechanic and Heavy Duty Mechanic, self-propelled concrete saws of all types and sizes with their attachments, gob-hoppers, excavators

all sizes, the repair and greasing of all diesel hammers, the operation and set-up of bidwells, water blasters of all sizes and their clutches, hydraulic jacks where used for hoisting, operation of log skidders, iceolators used on and off of pipeline, condor cranes, bow boats, survey boats, bobcats and all their attachments, skid steer loaders and all their attachments, creter cranes, batch plants, operator (all sizes), self propelled roto mills, operation of conveyor systems of any size and any configuration, operation, repair and service of all vibratory hammers, all power pacs and their controls regardless of location, curtains or brush burning machines, stump cutter machines, Nail launchers when mounted on a machine or self-propelled, operation of con-cover machines, and all Operators except those listed below).

GROUP II. Assistant Operators.

GROUP III. Air Compressors (One), Water Pumps, regardless of Size (One), Waterblasters (one), Welding Machine (One), Mixers (One Bag), Conveyor (One), Siphon or Jet (One), Light Plant (One), Heater (One), Immobile Track Air (One), and Self Propelled Walk-Behind Rollers.

GROUP IV. Asphalt Spreader Oilers, Fireman on Whirlies and Heavy Equipment Oilers, Truck Cranes, Dredges, Monigans, Large Cranes - (Over 65-ton rated capacity) Concrete Plant Oiler, Blacktop Plant Oiler, and Creter Crane Oiler (when required).

GROUP V. Oiler.

GROUP VI. Operators on equipment with Booms, including jibs, 100 feet and over, and less than 150 feet long.

GROUP VII. Operators on equipment with Booms, including jibs, 150 feet and over, and less than 200 feet long.

GROUP VIII. Operators on Equipment with Booms, including jibs, 200 feet and over; Tower Cranes; and Whirlie Cranes.

GROUP IX. Master Mechanic

OPERATING ENGINEERS - Highway

GROUP I. Cranes, Dragline, Shovels, Skimmer Scoops, Clamshells or Derrick Boats, Pile Drivers, Crane-Type Backhoes, Asphalt Plant Operators, Concrete Plant Operators, Dredges, Asphalt Spreading Machines, All Locomotives, Cable Ways or Tower Machines, Hoists, Hydraulic Backhoes, Ditching Machines or Backfiller, Cherrypickers, Overhead Cranes, Roller - Steam or Gas, Concrete Pavers, Excavators, Concrete Breakers, Concrete Pumps, Bulk Cement Plants, Cement Pumps, Derrick-Type Drills, Boat Operators, Motor Graders or Pushcats, Scoops or Tournapulls, Bulldozers, Endloaders or Fork Lifts, Power Blade or Elevating Graders, Winch Cats, Boom or Winch Trucks or Boom Tractors, Pipe Wrapping or Painting Machines, Asphalt Plant Engineer, Journeyman Lubricating Engineer, Drills (other than Derrick Type), Mud Jacks, Well Drilling Machines, Boring Machines, Track Jacks, Mixers, Conveyors (Two), Air Compressors (Two), Water Pumps regardless of size (Two), Welding Machines (Two), Siphons or Jets (Two), Winch Heads or Apparatuses (Two), Light Plants (Two), All Tractors regardless of size (straight tractor only), Fireman on Stationary Boilers, Automatic Elevators, Form Grading Machines, Finishing Machines, Power Sub-Grader or Ribbon Machines, Longitudinal Floats, Distributor Operators on Trucks, Winch Heads or Apparatuses (One), Mobil Track air and heaters (two to five), Heavy Equipment Greaser, Relief Operator, Assistant Master Mechanic and Heavy Duty Mechanic, self-propelled concrete saws of all types and sizes with their attachments, gob-hoppers, excavators all sizes, the repair and greasing of all diesel hammers, the

operation and set-up of bidwells, water blasters of all sizes and their clutches, hydraulic jacks where used for hoisting, operation of log skidders, iceolators used on and off of pipeline, condor cranes, bow boats, survey boats, bobcats and all their attachments, skid steer loaders and all their attachments, creter cranes, batch plants, operator (all sizes), self propelled roto mills, operation of conveyer systems of any size and any configuration, operation, repair and service of all vibratory hammers, all power pacs and their controls regardless of location, curtains or brush burning machines, stump cutter machines, Nail launchers when mounted on a machine or self-propelled, operation of con-cover machines, and all Operators (except those listed below).

GROUP II. Assistant Operators.

GROUP III. Air Compressors (One), Water Pumps, regardless of Size (One), Waterblasters (one), Welding Machine (One), Mixers (One Bag), Conveyor (One), Siphon or Jet (One), Light Plant (One), Heater (One), Immobile Track Air (One), and Self Propelled Walk-Behind Rollers.

GROUP IV. Asphalt Spreader Oilers, Fireman on Whirlies and Heavy Equipment Oilers, Truck Cranes, Dredges, Monigans, Large Cranes - (Over 65-ton rated capacity) Concrete Plant Oiler, Blacktop Plant Oiler, and Creter Crane Oiler (when required).

GROUP V. Oiler.

GROUP VI. Operators on equipment with Booms, including jibs, 100 feet and over, and less than 150 feet long.

GROUP VII. Operators on equipment with Booms, including jibs, 150 feet and over, and less than 200 feet long.

GROUP VIII. Operators on Equipment with Booms, including jibs, 200 feet and over; Tower Cranes; and Whirlie Cranes.

GROUP IX. Mechanic

TRUCK DRIVER - BUILDING, HEAVY AND HIGHWAY CONSTRUCTION

Class 1. Drivers on 2 axle trucks hauling less than 9 ton. Air compressor and welding machines and brooms, including those pulled by separate units, truck driver helpers, warehouse employees, mechanic helpers, greasers and tiremen, pickup trucks when hauling materials, tools, or workers to and from and on-the-job site, and fork lifts up to 6,000 lb. capacity.

Class 2. Two or three axle trucks hauling more than 9 ton but hauling less than 16 ton. A-frame winch trucks, hydrolift trucks, vactor trucks or similar equipment when used for transportation purposes. Fork lifts over 6,000 lb. capacity, winch trucks, four axle combination units, and ticket writers.

Class 3. Two, three or four axle trucks hauling 16 ton or more. Drivers on water pulls, articulated dump trucks, mechanics and working forepersons, and dispatchers. Five axle or more combination units.

Class 4. Low Boy and Oil Distributors.

Class 5. Drivers who require special protective clothing while employed on hazardous waste work.

TRUCK DRIVER - OIL AND CHIP RESEALING ONLY.

This shall encompass laborers, workers and mechanics who drive contractor or subcontractor owned, leased, or hired pickup, dump, service, or oil distributor trucks. The work includes transporting materials and equipment (including but not limited to, oils, aggregate supplies, parts, machinery and tools) to or from the job site; distributing oil or liquid asphalt and aggregate; stock piling material when in connection with the actual oil and chip contract. The Truck Driver (Oil & Chip Resealing) wage classification does not include supplier delivered materials.

TERRAZZO FINISHER

The handling of all materials used for Mosaic and Terrazzo work including preparing, mixing by hand, by mixing machine or transporting of pre-mixed materials and distributing with shovel, rake, hoe, or pail, all kinds of concrete foundations necessary for Mosaic and Terrazzo work, all cement terrazzo, magnesite terrazzo, Do-O-Tex terrazzo, epoxy matrix ter-razzo, exposed aggregate, rustic or rough washed for exterior or interior of buildings placed either by machine or by hand, and any other kind of mixture of plastics composed of chips or granules when mixed with cement, rubber, neoprene, vinyl, magnesium chloride or any other resinous or chemical substances used for seamless flooring systems, and all other building materials, all similar materials and all precast terrazzo work on jobs, all scratch coat used for Mosaic and Terrazzo work and sub-bed, tar paper and wire mesh (2x2 etc.) or lath. The rubbing, grinding, cleaning and finishing of same either by hand or by machine or by terrazzo resurfacing equipment on new or existing floors. When necessary finishers shall be allowed to assist the mechanics to spread sand bed, lay tarpaper and wire mesh (2x2 etc.) or lath. The finishing of cement floors where additional aggregate of stone is added by spreading or sprinkling on top of the finished base, and troweled or rolled into the finish and then the surface is ground by grinding machines.

Other Classifications of Work:

For definitions of classifications not otherwise set out, the Department generally has on file such definitions which are available. If a task to be performed is not subject to one of the classifications of pay set out, the Department will upon being contacted state which neighboring county has such a classification and provide such rate, such rate being deemed to exist by reference in this document. If no neighboring county rate applies to the task, the Department shall undertake a special determination, such special determination being then deemed to have existed under this determination. If a project requires these, or any classification not listed, please contact IDOL at 217-782-1710 for wage rates or clarifications.

LANDSCAPING

Landscaping work falls under the existing classifications for laborer, operating engineer and truck driver. The work performed by landscape plantsman and landscape laborer is covered by the existing classification of laborer. The work performed by landscape operators (regardless of equipment used or its size) is covered by the classifications of operating engineer. The work performed by landscape truck drivers (regardless of size of truck driven) is covered by the classifications of truck driver.

Morgan County Prevailing Wage for May 2013

(See explanation of column headings at bottom of wages)

Trade Name	RG	TYP	C	Base	FRMAN	M-F>8	OSA	OSH	H/W	Pensn	Vac	Trng
=====	==	===	=	=====	=====	=====	===	===	=====	=====	=====	=====
ASBESTOS ABT-GEN		BLD		28.200	29.450	1.5	1.5	2.0	5.750	10.22	0.000	0.900
ASBESTOS ABT-MEC		BLD		29.860	30.860	1.5	1.5	2.0	6.950	3.000	0.000	0.000
BOILERMAKER		BLD		31.500	34.000	1.5	1.5	2.0	7.070	18.73	1.000	0.350
BRICK MASON		BLD		29.250	30.250	1.5	1.5	2.0	8.200	8.330	0.000	0.580
CARPENTER		BLD		27.670	29.920	1.5	1.5	2.0	7.450	14.58	0.000	0.520
CARPENTER		HWY		28.870	30.620	1.5	1.5	2.0	7.450	13.73	0.000	0.520
CEMENT MASON		BLD		29.350	30.350	2.0	2.0	2.0	8.200	8.330	0.000	0.580
CEMENT MASON		HWY		26.870	27.870	1.5	1.5	2.0	8.200	7.530	0.000	0.000
CERAMIC TILE FNSHER		BLD		25.600	0.000	1.5	1.5	2.0	8.200	7.230	0.000	0.000
ELECTRIC PWR EQMT OP		ALL		35.440	0.000	1.5	1.5	2.0	5.000	10.98	0.000	0.270
ELECTRIC PWR GRNDMAN		ALL		24.320	0.000	1.5	1.5	2.0	5.000	7.540	0.000	0.180
ELECTRIC PWR LINEMAN		ALL		39.370	41.910	1.5	1.5	2.0	5.000	12.20	0.000	0.300
ELECTRIC PWR TRK DRV		ALL		25.510	0.000	1.5	1.5	2.0	5.000	7.920	0.000	0.190
ELECTRICIAN		BLD		34.220	36.220	1.5	1.5	2.0	5.860	8.120	0.000	0.400
ELECTRONIC SYS TECH		BLD		30.390	32.140	1.5	1.5	2.0	5.350	7.160	0.000	0.400
ELEVATOR CONSTRUCTOR		BLD		40.520	45.585	2.0	2.0	2.0	11.88	12.71	3.240	0.600
GLAZIER		BLD		30.780	32.780	1.5	2.0	2.0	6.630	8.150	0.000	0.380
HT/FROST INSULATOR		BLD		37.260	38.260	1.5	1.5	2.0	7.850	11.16	0.000	0.500
IRON WORKER		BLD		29.460	31.460	1.5	1.5	2.0	7.740	11.38	0.000	0.660
IRON WORKER		HWY		30.600	32.100	1.5	1.5	2.0	7.740	11.69	0.000	0.660
LABORER		BLD		26.200	27.450	1.5	1.5	2.0	5.750	10.22	0.000	0.800
LABORER		HWY		28.210	28.960	1.5	1.5	2.0	5.750	10.32	0.000	0.800
LATHER		BLD		27.670	29.920	1.5	1.5	2.0	7.450	14.58	0.000	0.520
MACHINIST		BLD		43.550	46.050	1.5	1.5	2.0	6.130	8.950	1.850	0.000
MARBLE FINISHERS		BLD		25.600	0.000	1.5	1.5	2.0	8.200	7.230	0.000	0.000
MARBLE MASON		BLD		27.100	27.850	1.5	1.5	2.0	8.200	7.230	0.000	0.000
MILLWRIGHT		BLD		29.620	31.870	1.5	1.5	2.0	7.450	13.09	0.000	0.520
MILLWRIGHT		HWY		31.690	33.440	1.5	1.5	2.0	7.450	13.54	0.000	0.520
OPERATING ENGINEER		BLD	1	33.900	35.400	1.5	1.5	2.0	10.05	7.600	0.000	1.300
OPERATING ENGINEER		BLD	2	31.550	35.400	1.5	1.5	2.0	10.05	7.600	0.000	1.300
OPERATING ENGINEER		BLD	3	27.950	35.400	1.5	1.5	2.0	10.05	7.600	0.000	1.300
OPERATING ENGINEER		BLD	4	35.400	35.400	1.5	1.5	2.0	10.05	7.600	0.000	1.300
OPERATING ENGINEER		HWY	1	37.600	39.100	1.5	1.5	2.0	10.05	8.100	0.000	1.300
OPERATING ENGINEER		HWY	2	33.660	39.100	1.5	1.5	2.0	10.05	8.100	0.000	1.300
OPERATING ENGINEER		HWY	3	27.630	39.100	1.5	1.5	2.0	10.05	8.100	0.000	1.300
OPERATING ENGINEER		HWY	4	39.100	39.100	1.5	1.5	2.0	10.05	8.100	0.000	1.300
PAINTER		ALL		28.580	30.080	1.5	1.5	2.0	5.000	8.580	0.000	0.550
PAINTER OVER 30FT		ALL		29.580	31.080	1.5	1.5	2.0	5.000	8.580	0.000	0.550
PAINTER PWR EQMT		ALL		29.580	31.080	1.5	1.5	2.0	5.000	8.580	0.000	0.550
PILEDRIVER		BLD		28.170	30.420	1.5	1.5	2.0	7.450	14.58	0.000	0.520
PILEDRIVER		HWY		29.870	31.620	1.5	1.5	2.0	7.450	13.73	0.000	0.520
PIPEFITTER		BLD		40.020	44.020	1.5	1.5	2.0	7.000	7.750	0.000	0.900
PLASTERER		BLD		29.350	30.350	2.0	2.0	2.0	8.200	8.330	0.000	0.580
PLUMBER		BLD		40.020	44.020	1.5	1.5	2.0	7.000	7.750	0.000	0.900
ROOFER		BLD		27.900	30.400	1.5	1.5	2.0	8.600	6.750	0.000	0.500
SHEETMETAL WORKER		BLD		31.680	33.930	1.5	1.5	2.0	8.300	12.35	0.000	0.500
SPRINKLER FITTER		BLD		36.390	39.140	1.5	1.5	2.0	8.420	8.500	0.000	0.450
STONE MASON		BLD		29.250	30.250	1.5	1.5	2.0	8.200	8.330	0.000	0.580
TERRAZZO FINISHER		BLD		25.600	0.000	1.5	1.5	2.0	8.200	7.230	0.000	0.000
TERRAZZO MASON		BLD		27.100	27.850	1.5	1.5	2.0	8.200	7.230	0.000	0.000
TILE MASON		BLD		27.100	27.850	1.5	1.5	2.0	8.200	7.230	0.000	0.000
TRUCK DRIVER		ALL	1	31.340	0.000	1.5	1.5	2.0	10.30	5.010	0.000	0.250
TRUCK DRIVER		ALL	2	31.780	0.000	1.5	1.5	2.0	10.30	5.010	0.000	0.250
TRUCK DRIVER		ALL	3	32.020	0.000	1.5	1.5	2.0	10.30	5.010	0.000	0.250
TRUCK DRIVER		ALL	4	32.280	0.000	1.5	1.5	2.0	10.30	5.010	0.000	0.250
TRUCK DRIVER		ALL	5	33.130	0.000	1.5	1.5	2.0	10.30	5.010	0.000	0.250
TRUCK DRIVER		O&C	1	25.070	0.000	1.5	1.5	2.0	10.30	5.010	0.000	0.250
TRUCK DRIVER		O&C	2	25.420	0.000	1.5	1.5	2.0	10.30	5.010	0.000	0.250
TRUCK DRIVER		O&C	3	25.620	0.000	1.5	1.5	2.0	10.30	5.010	0.000	0.250
TRUCK DRIVER		O&C	4	25.820	0.000	1.5	1.5	2.0	10.30	5.010	0.000	0.250
TRUCK DRIVER		O&C	5	26.500	0.000	1.5	1.5	2.0	10.30	5.010	0.000	0.250
TUCKPOINTER		BLD		29.250	30.250	1.5	1.5	2.0	8.200	8.330	0.000	0.580

Legend :

RG (Region)

TYP (Trade Type - All,Highway,Building,Floating,Oil & Chip,Rivers)

C (Class)

Base (Base Wage Rate)

FRMAN (Foreman Rate)

M-F>8 (OT required for any hour greater than 8 worked each day, Mon through Fri.

OSA (Overtime (OT) is required for every hour worked on Saturday)

OSH (Overtime is required for every hour worked on Sunday and Holidays)

H/W (Health & Welfare Insurance)

Pensn (Pension)

Vac (Vacation)

Trng (Training)

Explanations

MORGAN COUNTY

The following list is considered as those days for which holiday rates of wages for work performed apply: New Years Day, Memorial Day, Fourth of July, Labor Day, Thanksgiving Day, Christmas Day and Veterans Day in some classifications/counties. Generally, any of these holidays which fall on a Sunday is celebrated on the following Monday. This then makes work performed on that Monday payable at the appropriate overtime rate for holiday pay. Common practice in a given local may alter certain days of celebration. If in doubt, please check with IDOL.

Oil and chip resealing (O&C) means the application of road oils and liquid asphalt to coat an existing road surface, followed by application of aggregate chips or gravel to coated surface, and subsequent rolling of material to seal the surface.

EXPLANATION OF CLASSES

ASBESTOS - GENERAL - removal of asbestos material/mold and hazardous materials from any place in a building, including mechanical systems where those mechanical systems are to be removed. This includes the removal of asbestos materials/mold and hazardous materials from ductwork or pipes in a building when the building is to be demolished at the time or at some close future date.

ASBESTOS - MECHANICAL - removal of asbestos material from mechanical systems, such as pipes, ducts, and boilers, where the mechanical systems are to remain.

CERAMIC TILE FINISHER, MARBLE FINISHER, TERRAZZO FINISHER

Assisting, helping or supporting the tile, marble and terrazzo mechanic by performing their historic and traditional work assignments required to complete the proper installation of the work covered by said crafts. The term "Ceramic" is used for naming the classification only and is in no way a limitation of the product handled. Ceramic takes into consideration most hard tiles.

ELECTRONIC SYSTEMS TECHNICIAN

Installation, service and maintenance of low-voltage systems which utilizes the transmission and/or transference of voice, sound, vision, or digital for commercial, education, security and entertainment purposes for the following: TV monitoring and surveillance, background/foreground music, intercom and telephone interconnect, field programming, inventory control systems, microwave transmission, multi-media, multiplex, radio page, school, intercom and sound burglar alarms and low voltage master clock systems.

Excluded from this classification are energy management systems, life safety systems, supervisory controls and data acquisition systems not intrinsic with the above listed systems, fire alarm systems, nurse call systems and raceways exceeding fifteen feet in length.

TRUCK DRIVER - BUILDING, HEAVY AND HIGHWAY CONSTRUCTION

Class 1. Drivers on 2 axle trucks hauling less than 9 ton. Air compressor and welding machines and brooms, including those pulled by separate units, truck driver helpers, warehouse employees, mechanic helpers, greasers and tiremen, pickup trucks when hauling materials, tools, or workers to and from and on-the-job site, and fork lifts up to 6,000 lb. capacity.

Class 2. Two or three axle trucks hauling more than 9 ton but hauling less than 16 ton. A-frame winch trucks, hydrolift trucks, vactor trucks or similar equipment when used for transportation purposes. Fork lifts over 6,000 lb. capacity, winch trucks, four axle combination units, and ticket writers.

Class 3. Two, three or four axle trucks hauling 16 ton or more. Drivers on water pulls, articulated dump trucks, mechanics and working forepersons, and dispatchers. Five axle or more combination units.

Class 4. Low Boy and Oil Distributors.

Class 5. Drivers who require special protective clothing while employed on hazardous waste work.

TRUCK DRIVER - OIL AND CHIP RESEALING ONLY.

This shall encompass laborers, workers and mechanics who drive contractor or subcontractor owned, leased, or hired pickup, dump, service, or oil distributor trucks. The work includes transporting materials and equipment (including but not limited to, oils, aggregate supplies, parts, machinery and tools) to or from the job site; distributing oil or liquid asphalt and aggregate; stock piling material when in connection with the actual oil and chip contract. The Truck Driver (Oil & Chip Resealing) wage classification does not include supplier delivered materials.

OPERATING ENGINEERS - BUILDING

CLASS 1. Asphalt Screed Man; Aspco Concrete Spreaders; Asphalt Pavers; Asphalt Plant Engineer; Asphalt Rollers on Bituminous Concrete; Athey Loaders; Backfillers, Crane Type; Backhoes; Barber Green Loaders; Bulldozers; Cableways; Cherry Pickers; Clam Shells; C.M.I. & similar type autograde formless paver, autograde placer &

finisher; Concrete Breakers; Concrete Pumps; Derricks; Derrick Boats; Draglines; Earth Auger or Boring Machines; Elevating Graders; Engineers on Dredges; Gravel Processing Machines; Head Equipment Greaser; High Lifts or Fork Lifts; Hoists with two or more drums or two or more load lines; Locomotives, All; Mechanics; Motor Graders or Auto Patrols; Operators or Leverman on Dredges; Operators, Power Boat; Operators, Pug Mill (Asphalt Plants); Orange Peels; Overhead Cranes; Paving Mixers; Piledrivers; Pipe Wrapping and Painting Machines; Pushdozers, or Push Cats; Robotic Controlled Equipment in this Classification; Rock Crushers; Ross Carrier or Similar Machines; Rotomill; Scoops, Skimmer, two cu. yd. capacity and under; Scoops, All or Tournapull; Sheep-Foot Roller (Self Propelled); Shovels; Skid Steer; Skimmer Scoops; Temporary Concrete Plant Operators; Test Hole Drilling Machines; Tower Machines; Tower Mixers; Track Type End Loaders; Track Type Fork Lifts or High Lifts; Track Jacks and Tampers; Tractors, Sideboom; Trenching or Ditching Machine; Tunnelluggers; Vermeer Type Saws; Water Blaster Cutting Head; Wheel Type End Loaders; Winch Cat.

CLASS 2. Air Compressors (six to eight)*; Asphalt Boosters and Heaters; Asphalt Distributors; Asphalt Plant Fireman; Oiler on Two Paving Mixers When Used in Tandem; Boom or Winch Trucks; Bull Floats or Flexplanes; Concrete Finishing Machine; Concrete Saws, Self-Propelled; Concrete Spreading Machines; Conveyors (six to eight)*; Generators (six to eight)*; Gravel or Stone Spreader, Power Operated; Hoist (with One Drum and One Load Line); Light Plants (six to eight)*; Mechanical Heaters (six to eight)*; Mud Jacks; Post Hole Digger, Mechanical; Pug Mills when used for other than Asphalt operation; Robotic Controlled Equipment in this Classification; Road or Street Sweeper, Self Propelled; Rollers (except bituminous concrete); Seaman Tiller; Straw Machine; Vibratory Compactor; Water Blaster, Power Unit; Welding Machines (six to eight)*; Well Drill Machines.

CLASS 3. Air Compressors(one to five)*; Air Compressors, Track or Self-Propelled; Automatic Hoist; Building Elevators; Bulk Cement Batching Plants; Conveyors (one to five)*; Concrete Mixers (Except Plant, Paver, or Tower); Firemen; Generators (one to five)*; Greasers; Helper on Single Paving Mixer; Hoist, Automatic; Light Plants (one to five)*; Mechanic Helpers; Mechanical Heaters (one to five)*; Oilers; Power Form Graders; Power Sub-Graders; Robotic Controlled Equipment in this Classification; Scissors Hoist; Tractors without power attachments regardless of size or type; Truck Crane Oiler and Driver (1 man); Vibratory Hammer (power source); Water Pumps (one to five)*; Welding Machines (1/300 Amp. or over)*; Welding machines (one to five)*

CLASS 4. Lattice Boom Crawler Cranes; Lattice Boom Truck Cranes; Telescopic Truck-Mounted Cranes; Tower Cranes.

* Combinations of one to eight of any Air Compressors, Conveyors, Welding Machines, Water Pumps, Light Plants, or Generators shall be in batteries or within 400 feet and shall be paid as per the Classification Schedule contained in this Article.

OPERATING ENGINEERS - HIGHWAY

CLASS 1. Asphalt Screed Man; Asphco Concrete Spreaders; Asphalt Pavers; Asphalt Plant Engineer; Asphalt Rollers on Bituminous Concrete; Athey Loaders; Backhoes; Barber Green Loaders; Bulldozers; Cableways; Carry Deck Pickers; Cherry Pickers (Rough Terrain); C.M.I. & similar type-autograde formless paver, autograde placer & finisher; Concrete Breakers; Concrete Plant Operators; Concrete Pumps; Derricks; Derrick Boats; Dewatering Systems; Earth Auger or Boring Machines; Elevating Graders; Engineers on Dredges; Gravel Processing Machines;

Grout Pump; Head Equipment Greaser; High Lifts or Fork Lifts; Hoists with two or more drums or two or more load lines; Hydro Jet or Hydro Laser; Locomotives, All; Mechanics; Motor Graders or Auto Patrols; Multi-Point Power Lifting Equipment; Operators or Leverman on Dredges; Operators, Power Boat; Operators, Pug Mill (Asphalt Plants); Overhead Cranes; Paving Mixers; Piledrivers; Pipe Wrapping and Painting Machines; Push-dozers, or Push Cats; Robotic Controlled Equipment in this Classification; Rock Crushers; Ross Carrier or Similar Machines; Roto-Mill; Scoops, Skimmer, two cu. yd. capacity and under; Sheep-Foot Roller (Self Pro-pelled); Shovels; Skid Steer; Skimmer Scoops; Test Hole Drilling Machines; Tower Machines; Tower Mixers; Track Type End Loaders; Track Type Fork Lifts or High Lifts; Track Jacks and Tampers; Tractors, Side-boom; Trenching or Ditching Machine; Tunnelluggers; Vermeer-Type Saws; Wheel Type End Loaders; Winch Cat; Scoops, All or Tournapull.

CLASS 2. Air Compressors (six to eight)*; Articulated Dumps; Asphalt Boosters and Heaters; Asphalt Distributors; Asphalt Plant Fireman; Boom or Winch Trucks; Building Elevators; Bull Floats or Flexplanes; Concrete Finishing Machine; Concrete Saws, Self-Propelled; Concrete Spreading Machines; Conveyors (six to eight)*; Generators (six to eight)*; Gravel or Stone Spreader, Power Operated; Hoist, Automatic; Hoist with One Drum and One Load Line; Light Plants (six to eight)*; Mechanical Heaters (six to eight)*; Mud Jacks; Off Road Water Wagons; Oiler on Two Paving Mixers When Used in Tandem; Post Hole Digger, Mechanical; Robotic Controlled Equipment in This Classification; Road or Street Sweeper, Self-Propelled; Rollers (except bituminous concrete); Scissor Hoist; Sea-man Tiller; Straw Machine; Vibratory Compactor; Water Pumps (six to eight)*; Well Drill Machines.

CLASS 3. Air Compressors (one to five)*; Air Compressors, Track or Self-Propelled; Bulk Cement Batching Plants; Conveyors (one to five)*; Concrete Mixers (Except Plant, Paver, or Tower); Firemen; Generators (one to five)*; Greasers; Helper on Single Paving Mixer; Light Plants (one to five)*; Mechanic Helpers; Mechanical Heaters (one to five)*; Oilers; Power Form Graders; Power Sub-Graders; Pug Mills when used for other than Asphalt operation; Robotic Controlled Equipment in This Classification; Tractors without power attachments, regardless of size or type; Truck Crane Oiler and Driver (1 man); Vibratory Hammer (power source); Water Pumps (one to five)*; Welding Machines (one 300 Amp. or over)*; Welding Machines (one to five)*.

CLASS 4. Lattice Boom Crawler Crane; Lattice Boom Truck Crane; Telescopic Truck-Mounted Crane; Tower Crane.

*Combinations of one to eight of any Air Compressors, Conveyors, Welding Machines, Water Pumps, Light Plants or Generators shall be in batteries or within 400 feet and shall be paid as per the Classification Schedule contained in this Article.

Other Classifications of Work:

For definitions of classifications not otherwise set out, the Department generally has on file such definitions which are available. If a task to be performed is not subject to one of the classifications of pay set out, the Department will upon being contacted state which neighboring county has such a classification and provide such rate, such rate being deemed to exist by reference in this document. If no neighboring county rate applies to the task, the Department shall undertake a special determination, such special determination being then deemed to have existed under this determination. If a project requires these, or any classification not listed, please contact IDOL at 217-782-1710 for wage rates or clarifications.

LANDSCAPING

Landscaping work falls under the existing classifications for laborer, operating engineer and truck driver. The work performed by landscape plantsman and landscape laborer is covered by the existing classification of laborer. The work performed by landscape operators (regardless of equipment used or its size) is covered by the classifications of operating engineer. The work performed by landscape truck drivers (regardless of size of truck driven) is covered by the classifications of truck driver.

Moultrie County Prevailing Wage for May 2013

(See explanation of column headings at bottom of wages)

Trade Name	RG	TYP	C	Base	FRMAN	M-F>8	OSA	OSH	H/W	Pensn	Vac	Trng
=====	==	===	=	=====	=====	=====	===	===	=====	=====	=====	=====
ASBESTOS ABT-GEN	N	BLD		29.710	30.960	1.5	1.5	2.0	5.750	9.920	0.000	0.900
ASBESTOS ABT-GEN	S	BLD		30.010	31.260	1.5	1.5	2.0	5.750	9.920	0.000	0.900
ASBESTOS ABT-MEC		BLD		29.860	30.860	1.5	1.5	2.0	6.950	3.000	0.000	0.000
BOILERMAKER		BLD		31.500	34.000	1.5	1.5	2.0	7.070	18.73	1.000	0.350
BRICK MASON		BLD		29.130	30.630	1.5	1.5	2.0	8.200	10.03	0.000	0.580
CARPENTER		BLD		29.600	31.850	1.5	1.5	2.0	7.450	12.65	0.000	0.520
CARPENTER		HWY		29.950	31.700	1.5	1.5	2.0	7.450	12.65	0.000	0.520
CEMENT MASON		BLD		29.800	31.300	1.5	1.5	2.0	6.600	8.360	0.000	0.500
CEMENT MASON		HWY		30.390	31.890	1.5	1.5	2.0	6.600	8.560	0.000	0.500
CERAMIC TILE FNSHER		BLD		25.480	0.000	1.5	1.5	2.0	8.200	8.930	0.000	0.000
ELECTRIC PWR EQMT OP		ALL	1	35.570	0.000	1.5	1.5	2.0	5.000	9.960	0.000	0.360
ELECTRIC PWR EQMT OP		ALL	2	31.740	0.000	1.5	1.5	2.0	5.000	8.880	0.000	0.320
ELECTRIC PWR GRNDMAN		ALL		26.100	0.000	1.5	1.5	2.0	5.000	7.310	0.000	0.260
ELECTRIC PWR LINEMAN		ALL		44.630	47.650	1.5	1.5	2.0	5.000	12.50	0.000	0.450
ELECTRICIAN		BLD		34.200	37.620	1.5	1.5	2.0	5.350	7.610	0.000	0.510
ELECTRONIC SYS TECH		BLD		31.130	32.880	1.5	1.5	2.0	5.350	6.110	0.000	0.400
ELEVATOR CONSTRUCTOR		BLD		40.520	45.585	2.0	2.0	2.0	11.88	12.71	3.240	0.600
FENCE ERECTOR		ALL		30.610	32.510	1.5	1.5	2.0	8.840	8.420	0.000	0.900
GLAZIER		BLD		30.780	32.780	1.5	2.0	2.0	6.630	8.150	0.000	0.380
HT/FROST INSULATOR		BLD		37.260	38.260	1.5	1.5	2.0	7.850	11.16	0.000	0.500
IRON WORKER		ALL		30.610	32.510	1.5	1.5	2.0	8.840	8.420	0.000	0.900
LABORER		HWY		29.120	30.120	1.5	1.5	2.0	5.750	9.920	0.000	0.800
LABORER	N	BLD		27.710	28.960	1.5	1.5	2.0	5.750	9.920	0.000	0.800
LABORER	S	BLD		28.010	29.260	1.5	1.5	2.0	5.750	9.920	0.000	0.800
LATHER		BLD		29.600	31.850	1.5	1.5	2.0	7.450	12.65	0.000	0.520
MACHINIST		BLD		43.550	46.050	1.5	1.5	2.0	6.130	8.950	1.850	0.000
MARBLE FINISHERS		BLD		25.480	0.000	1.5	1.5	2.0	8.200	8.930	0.000	0.000
MARBLE MASON		BLD		26.980	28.230	1.5	1.5	2.0	8.200	8.930	0.000	0.000
MILLWRIGHT		BLD		29.620	31.870	1.5	1.5	2.0	7.450	13.09	0.000	0.520
MILLWRIGHT		HWY		31.400	33.150	1.5	1.5	2.0	7.450	13.54	0.000	0.520
OPERATING ENGINEER		ALL	1	36.950	0.000	1.5	1.5	2.0	7.250	8.700	0.000	0.800
OPERATING ENGINEER		ALL	2	23.900	0.000	1.5	1.5	2.0	7.250	8.700	0.000	0.800
PAINTER		ALL		28.250	29.750	1.5	1.5	2.0	5.750	9.420	0.000	0.650
PAINTER OVER 30FT		ALL		28.500	30.000	1.5	1.5	2.0	5.750	9.420	0.000	0.650
PAINTER PWR EQMT		ALL		29.250	30.750	1.5	1.5	2.0	5.750	9.420	0.000	0.650
PILEDRIVER		BLD		30.100	32.350	1.5	1.5	2.0	7.450	12.65	0.000	0.520
PILEDRIVER		HWY		30.950	32.700	1.5	1.5	2.0	7.450	12.65	0.000	0.520
PIPEFITTER		BLD		36.050	39.050	1.5	1.5	2.0	7.000	7.650	0.000	1.220
PLASTERER		BLD		30.000	32.000	1.5	1.5	2.0	6.600	10.17	0.000	0.500
PLUMBER		BLD		36.050	39.050	1.5	1.5	2.0	7.000	7.650	0.000	1.220
ROOFER		BLD		26.100	28.600	1.5	1.5	2.0	9.600	6.280	0.000	0.550
SHEETMETAL WORKER		BLD		33.640	35.640	1.5	1.5	2.0	8.300	12.00	0.000	0.520
SPRINKLER FITTER		BLD		36.390	39.140	1.5	1.5	2.0	8.420	8.500	0.000	0.450
STONE MASON		BLD		29.130	30.630	1.5	1.5	2.0	8.200	10.03	0.000	0.580
TERRAZZO FINISHER		BLD		25.480	0.000	1.5	1.5	2.0	8.200	8.930	0.000	0.000
TERRAZZO MASON		BLD		26.980	28.230	1.5	1.5	2.0	8.200	8.930	0.000	0.000

TILE LAYER	BLD	29.600	31.850	1.5	1.5	2.0	7.450	12.65	0.000	0.520
TILE MASON	BLD	26.980	28.230	1.5	1.5	2.0	8.200	8.930	0.000	0.000
TRUCK DRIVER	NW ALL 1	31.340	0.000	1.5	1.5	2.0	10.30	5.010	0.000	0.250
TRUCK DRIVER	NW ALL 2	31.780	0.000	1.5	1.5	2.0	10.30	5.010	0.000	0.250
TRUCK DRIVER	NW ALL 3	32.020	0.000	1.5	1.5	2.0	10.30	5.010	0.000	0.250
TRUCK DRIVER	NW ALL 4	32.280	0.000	1.5	1.5	2.0	10.30	5.010	0.000	0.250
TRUCK DRIVER	NW ALL 5	33.130	0.000	1.5	1.5	2.0	10.30	5.010	0.000	0.250
TRUCK DRIVER	NW O&C 1	25.070	0.000	1.5	1.5	2.0	10.30	5.010	0.000	0.250
TRUCK DRIVER	NW O&C 2	25.420	0.000	1.5	1.5	2.0	10.30	5.010	0.000	0.250
TRUCK DRIVER	NW O&C 3	25.620	0.000	1.5	1.5	2.0	10.30	5.010	0.000	0.250
TRUCK DRIVER	NW O&C 4	25.820	0.000	1.5	1.5	2.0	10.30	5.010	0.000	0.250
TRUCK DRIVER	NW O&C 5	26.500	0.000	1.5	1.5	2.0	10.30	5.010	0.000	0.250
TRUCK DRIVER	SE ALL 1	31.230	0.000	1.5	1.5	2.0	10.30	4.840	0.000	0.250
TRUCK DRIVER	SE ALL 2	31.680	0.000	1.5	1.5	2.0	10.30	4.840	0.000	0.250
TRUCK DRIVER	SE ALL 3	31.890	0.000	1.5	1.5	2.0	10.30	4.840	0.000	0.250
TRUCK DRIVER	SE ALL 4	32.180	0.000	1.5	1.5	2.0	10.30	4.840	0.000	0.250
TRUCK DRIVER	SE ALL 5	33.020	0.000	1.5	1.5	2.0	10.30	4.840	0.000	0.250
TRUCK DRIVER	SE O&C 1	24.980	0.000	1.5	1.5	2.0	10.30	4.840	0.000	0.250
TRUCK DRIVER	SE O&C 2	25.340	0.000	1.5	1.5	2.0	10.30	4.840	0.000	0.250
TRUCK DRIVER	SE O&C 3	25.510	0.000	1.5	1.5	2.0	10.30	4.840	0.000	0.250
TRUCK DRIVER	SE O&C 4	25.740	0.000	1.5	1.5	2.0	10.30	4.840	0.000	0.250
TRUCK DRIVER	SE O&C 5	26.420	0.000	1.5	1.5	2.0	10.30	4.840	0.000	0.250
TUCKPOINTER	BLD	29.130	30.630	1.5	1.5	2.0	8.200	10.03	0.000	0.580

Legend :

RG (Region)

TYP (Trade Type - All,Highway,Building,Floating,Oil & Chip,Rivers)

C (Class)

Base (Base Wage Rate)

FRMAN (Foreman Rate)

M-F>8 (OT required for any hour greater than 8 worked each day, Mon through Fri.)

OSA (Overtime (OT) is required for every hour worked on Saturday)

OSH (Overtime is required for every hour worked on Sunday and Holidays)

H/W (Health & Welfare Insurance)

Pensn (Pension)

Vac (Vacation)

Trng (Training)

Explanations

MOULTRIE COUNTY

CARPENTERS (NORTHWEST) - That part of the county North and West from a line between Pierson Station (Piatt County) and Rt. 133, West on 133 to the Okaw River following the river to the Moweaqua Road (Shelby County) to the West county line (Includes PILEDRIVERS, AND LATHERS).

LABORERS (SOUTH) - South of Route 121 including all of the City of Sullivan.

TRUCK DRIVERS (SOUTHEAST) - Southeast of a line from the northeast corner of Moultrie in a southwesterly direction to the point where such line continuing on to Findlay in Shelby County intersects the Moultrie-Shelby Counties line.

The following list is considered as those days for which holiday rates of wages for work performed apply: New Years Day, Memorial Day, Fourth of July, Labor Day, Thanksgiving Day, Christmas Day and Veterans Day in some classifications/counties. Generally, any of these holidays which fall on a Sunday is celebrated on the following Monday. This then makes work performed on that Monday payable at the appropriate overtime rate for holiday pay. Common practice in a given local may alter certain days of celebration. If in doubt, please check with IDOL.

Oil and chip resealing (O&C) means the application of road oils and liquid asphalt to coat an existing road surface, followed by application of aggregate chips or gravel to coated surface, and subsequent rolling of material to seal the surface.

EXPLANATION OF CLASSES

ASBESTOS - GENERAL - removal of asbestos material/mold and hazardous materials from any place in a building, including mechanical systems where those mechanical systems are to be removed. This includes the removal of asbestos materials/mold and hazardous materials from ductwork or pipes in a building when the building is to be demolished at the time or at some close future date.

ASBESTOS - MECHANICAL - removal of asbestos material from mechanical systems, such as pipes, ducts, and boilers, where the mechanical systems are to remain.

CERAMIC TILE FINISHER, MARBLE FINISHER, TERRAZZO FINISHER

Assisting, helping or supporting the tile, marble and terrazzo mechanic by performing their historic and traditional work assignments required to complete the proper installation of the work covered by said crafts. The term "Ceramic" is used for naming the classification only and is in no way a limitation of the product handled. Ceramic takes into consideration most hard tiles.

ELECTRONIC SYSTEMS TECHNICIAN

Installation, service and maintenance of low-voltage systems which utilizes the transmission and/or transference of voice, sound, vision, or digital for commercial, education, security and entertainment purposes for the following: TV monitoring and surveillance, background/foreground music, intercom and telephone interconnect, field programming, inventory control systems, microwave transmission, multi-media, multiplex, radio page, school, intercom and sound burglar alarms and low voltage master clock systems.

Excluded from this classification are energy management systems, life safety systems, supervisory controls and data acquisition systems not intrinsic with the above listed systems, fire alarm systems, nurse call systems and raceways exceeding fifteen feet in length.

TRUCK DRIVER - BUILDING, HEAVY AND HIGHWAY CONSTRUCTION

Class 1. Drivers on 2 axle trucks hauling less than 9 ton. Air compressor and welding machines and brooms, including those pulled by separate units, truck driver helpers, warehouse employees, mechanic helpers, greasers and tiremen, pickup trucks when hauling materials, tools, or workers to and from and on-the-job site, and fork lifts up

to 6,000 lb. capacity.

Class 2. Two or three axle trucks hauling more than 9 ton but hauling less than 16 ton. A-frame winch trucks, hydrolift trucks, vactor trucks or similar equipment when used for transportation purposes. Fork lifts over 6,000 lb. capacity, winch trucks, four axle combination units, and ticket writers.

Class 3. Two, three or four axle trucks hauling 16 ton or more. Drivers on water pulls, articulated dump trucks, mechanics and working forepersons, and dispatchers. Five axle or more combination units.

Class 4. Low Boy and Oil Distributors.

Class 5. Drivers who require special protective clothing while employed on hazardous waste work.

TRUCK DRIVER - OIL AND CHIP RESEALING ONLY.

This shall encompass laborers, workers and mechanics who drive contractor or subcontractor owned, leased, or hired pickup, dump, service, or oil distributor trucks. The work includes transporting materials and equipment (including but not limited to, oils, aggregate supplies, parts, machinery and tools) to or from the job site; distributing oil or liquid asphalt and aggregate; stock piling material when in connection with the actual oil and chip contract. The Truck Driver (Oil & Chip Resealing) wage classification does not include supplier delivered materials.

OPERATING ENGINEERS - BUILDING, HEAVY AND HIGHWAY CONSTRUCTION

Class 1. Power Cranes, Draglines, Derricks, Shovels, Gradalls, Mechanics, Tractor Highlift, Tournadozer, Concrete Mixers with Skip, Tournamixer, Two Drum Machine, One Drum Hoist with Tower or Boom, Cableways, Tower Machines, Motor Patrol, Boom Tractor, Boom or Winch Truck, Winch or Hydraulic Boom Truck, Truck Crane, Tournapull, Tractor Operating Scoops, Bulldozer, Push Tractor, Asphalt Planer, Finishing Machine on Asphalt, Large Rollers on Earth, Rollers on Asphalt Mix, Ross Carrier or similar Machine, Gravel Processing Machine, Asphalt Plant Engineer, Paver Operator, Dredging Equipment, or Dredge Engineer, or Dredge Operator, Central Mix Plant Engineer, CMI or similar type machine, Concrete Pump, Truck or Skid Mounted, Tower Crane, Engineer or Rock Crusher Plant, Concrete Plant Engineer, Ditching Machine with dual attachment, Tractor Mounted Loaders, Cherry Picker, Hydro Crane, Standard or Dinkey Locomotives, Scoopmobiles, Euclid Loader, Soil Cement Machine, Back Filler, Elevating Machine, Power Blade, Drilling Machine, including Well Testing, Caissons, Shaft or any similar type drilling machines, Motor Driven Paint Machine, Pipe Cleaning Machine, Pipe Wrapping Machine, Pipe Bending Machine, Apsco Paver, Boring Machine, (Head Equipment Greaser), Barber-Greene Loaders, Formless Paver, (Well Point System), Concrete Spreader, Hydra Ax, Span Saw, Marine Scoops, Brush Mulcher, Brush Burner, Mesh Placer, Tree Mover, Helicopter Crew (3), Piledriver-Skid or Crawler, Stump Remover, Root Rake, Tug Boat Operator, Refrigerating Machine, Freezing Operator, Chair Cart-Self-Propelled, Hydra Seeder, Straw Blower, Power Sub Grader, Bull Float, Finishing Machine, Self-Propelled Pavement Breaker, Lull (or similar type Machine), Two Air Compressors, Compressors hooked in Manifold, Overhead Crane, Chip Spreader, Mud Cat, Sull-Air, Fork Lifts (except when used for landscaping work), Soil Stabilizer (Seaman Tiller, Bo Mag, Rago Gator, and similar types of equipment), Tube Float, Spray Machine, Curing Machine, Concrete or Asphalt Milling Machine, Snooper Truck-Operator, Backhoe, Farm Tractors (with attachments), 4 Point Lift System (Power Lift or similar type),

Skid-Steer (Bob Cat or similar type), Wrecking Shears, Water Blaster.

Class 2. Concrete Mixers without Skips, Rock Crusher, Ditching Machine under 6', Curbing Machine, One Drum Machines without Tower or Boom, Air Tugger, Self-Propelled Concrete Saw, Machine Mounted Post Hole Digger, two to four Generators, Water Pumps or Welding Machines, within 400 feet, Air Compressor 600 cu. ft. and under, Rollers on Aggregate and Seal Coat Surfaces, Fork Lift (when used for landscaping work), Concrete and Blacktop Curb Machine, One Water Pump, Oilers, Air Valves or Steam Valves, One Welding Machine, Truck Jack, Mud Jack, Gunnite Machine, House Elevators when used for hoisting material, Engine Tenders, Fireman, Wagon Drill, Flex Plane, Conveyor, Siphons and Pulsometer, Switchman, Fireman on Paint Pots, Fireman on Asphalt Plants, Distributor Operator on Trucks, Tampers, Self-Propelled Power Broom, Striping Machine (motor driven), Form Tamper, Bulk Cement Plant, Equipment Greaser, Deck Hands, Truck Crane Oiler-Driver, Cement Blimps, Form Grader, Temporary Heat, Throttle Valve, Super Sucker (and similar type of equipment).

Other Classifications of Work:

For definitions of classifications not otherwise set out, the Department generally has on file such definitions which are available. If a task to be performed is not subject to one of the classifications of pay set out, the Department will upon being contacted state which neighboring county has such a classification and provide such rate, such rate being deemed to exist by reference in this document. If no neighboring county rate applies to the task, the Department shall undertake a special determination, such special determination being then deemed to have existed under this determination. If a project requires these, or any classification not listed, please contact IDOL at 217-782-1710 for wage rates or clarifications.

LANDSCAPING

Landscaping work falls under the existing classifications for laborer, operating engineer and truck driver. The work performed by landscape plantsman and landscape laborer is covered by the existing classification of laborer. The work performed by landscape operators (regardless of equipment used or its size) is covered by the classifications of operating engineer. The work performed by landscape truck drivers (regardless of size of truck driven) is covered by the classifications of truck driver.

Ogle County Prevailing Wage for May 2013

(See explanation of column headings at bottom of wages)

Trade Name	RG	TYP	C	Base	FRMAN	M-F>8	OSA	OSH	H/W	Pensn	Vac	Trng
=====	==	===	=	=====	=====	=====	===	===	=====	=====	=====	=====
ASBESTOS ABT-GEN		BLD		29.550	30.550	1.5	1.5	2.0	8.240	12.42	0.000	0.800
ASBESTOS ABT-MEC		BLD		18.950	0.000	1.5	1.5	2.0	2.700	3.350	0.000	0.000
BOILERMAKER		BLD		35.010	38.010	2.0	2.0	2.0	7.070	13.83	0.000	0.300
BRICK MASON		BLD		35.880	38.630	1.5	1.5	2.0	7.950	11.73	0.000	0.600
CARPENTER		HWY		33.790	35.540	1.5	1.5	2.0	9.750	12.99	0.000	0.490
CARPENTER	N	BLD		36.320	40.320	1.5	1.5	2.0	7.700	11.25	0.000	0.600
CARPENTER	S	BLD		32.040	35.560	1.5	1.5	2.0	8.630	13.87	0.000	0.600
CEMENT MASON		ALL		32.520	35.270	1.5	1.5	2.0	7.700	13.98	0.000	0.500
CERAMIC TILE FNSHER		BLD		32.410	0.000	1.5	1.5	2.0	7.700	4.840	0.000	0.530
COMMUNICATION TECH		BLD		36.000	39.600	1.5	1.5	2.0	10.14	11.20	0.000	0.720
ELECTRIC PWR EQMT OP		ALL		36.610	49.750	1.5	1.5	2.0	5.000	11.35	0.000	0.270
ELECTRIC PWR GRNDMAN		ALL		28.310	49.750	1.5	1.5	2.0	5.000	8.780	0.000	0.210
ELECTRIC PWR LINEMAN		ALL		43.830	49.750	1.5	1.5	2.0	5.000	13.58	0.000	0.330

ELECTRIC PWR TRK DRV		ALL	29.310	49.750	1.5	1.5	2.0	5.000	9.090	0.000	0.220
ELECTRICIAN		BLD	40.000	44.000	1.5	1.5	2.0	10.14	16.93	0.000	0.800
ELEVATOR CONSTRUCTOR		BLD	45.350	51.020	2.0	2.0	2.0	11.88	12.71	3.630	0.600
GLAZIER		BLD	34.730	35.730	1.5	1.5	2.0	9.700	8.200	0.000	1.250
HT/FROST INSULATOR		BLD	33.930	36.470	1.5	1.5	2.0	7.450	14.77	0.000	0.000
IRON WORKER		ALL	35.090	36.840	2.0	2.0	2.0	8.250	20.59	0.000	0.700
LABORER		BLD	29.550	30.550	1.5	1.5	2.0	8.240	12.42	0.000	0.800
LABORER		HWY	32.100	32.850	1.5	1.5	2.0	8.240	12.42	0.000	0.800
LABORER, SKILLED		HWY	34.400	35.150	1.5	1.5	2.0	8.240	12.42	0.000	0.800
LATHER	N	BLD	36.320	40.320	1.5	1.5	2.0	7.700	11.25	0.000	0.600
LATHER	S	BLD	32.040	35.560	1.5	1.5	2.0	8.630	13.87	0.000	0.600
MACHINIST		BLD	43.550	46.050	1.5	1.5	2.0	6.130	8.950	1.850	0.000
MARBLE FINISHERS		BLD	32.410	0.000	1.5	1.5	2.0	7.700	4.840	0.000	0.530
MARBLE MASON		BLD	35.090	35.340	1.5	1.5	2.0	7.700	7.150	0.000	0.560
MATERIAL TESTER I		ALL	21.550	0.000	1.5	1.5	2.0	7.460	4.840	0.000	0.170
MATERIALS TESTER II		ALL	26.550	0.000	1.5	1.5	2.0	7.460	4.840	0.000	0.170
MILLWRIGHT		BLD	35.000	38.500	1.5	1.5	2.0	7.700	13.87	0.000	0.500
OPERATING ENGINEER		BLD 1	40.800	44.850	2.0	2.0	2.0	15.85	9.800	2.350	1.300
OPERATING ENGINEER		BLD 2	40.100	44.850	2.0	2.0	2.0	15.85	9.800	2.350	1.300
OPERATING ENGINEER		BLD 3	37.650	44.850	2.0	2.0	2.0	15.85	9.800	2.350	1.300
OPERATING ENGINEER		BLD 4	35.650	44.850	2.0	2.0	2.0	15.85	9.800	2.350	1.300
OPERATING ENGINEER		BLD 5	44.600	44.850	2.0	2.0	2.0	15.85	9.800	2.350	1.300
OPERATING ENGINEER		BLD 6	43.350	44.850	2.0	2.0	2.0	15.85	9.800	2.350	1.300
OPERATING ENGINEER		BLD 7	40.350	44.850	2.0	2.0	2.0	15.85	9.800	2.350	1.300
OPERATING ENGINEER		HWY 1	40.650	44.700	1.5	1.5	2.0	15.85	9.800	2.350	1.300
OPERATING ENGINEER		HWY 2	40.100	44.700	1.5	1.5	2.0	15.85	9.800	2.350	1.300
OPERATING ENGINEER		HWY 3	38.800	44.700	1.5	1.5	2.0	15.85	9.800	2.350	1.300
OPERATING ENGINEER		HWY 4	37.350	44.700	1.5	1.5	2.0	15.85	9.800	2.350	1.300
OPERATING ENGINEER		HWY 5	35.900	44.700	1.5	1.5	2.0	15.85	9.800	2.350	1.300
OPERATING ENGINEER		HWY 6	43.700	44.700	1.5	1.5	2.0	15.85	9.800	2.350	1.300
OPERATING ENGINEER		HWY 7	41.700	44.700	1.5	1.5	2.0	15.85	9.800	2.350	1.300
PAINTER		ALL	35.700	37.700	1.5	1.5	1.5	9.650	8.460	0.000	1.250
PILEDRIVER		HWY	33.790	35.540	1.5	1.5	2.0	9.750	12.99	0.000	0.490
PILEDRIVER	N	BLD	37.320	41.430	1.5	1.5	2.0	7.700	11.25	0.000	0.600
PILEDRIVER	S	BLD	33.040	36.670	1.5	1.5	2.0	8.630	13.87	0.000	0.600
PIPEFITTER		BLD	40.600	43.440	1.5	1.5	2.0	7.980	10.79	0.000	1.000
PLASTERER		BLD	33.360	36.700	2.0	2.0	2.0	8.150	11.05	0.000	0.500
PLUMBER		BLD	40.600	43.440	1.5	1.5	2.0	7.980	10.79	0.000	1.000
ROOFER		BLD	38.350	41.350	1.5	1.5	2.0	8.280	8.770	0.000	0.430
SHEETMETAL WORKER		BLD	35.780	37.710	1.5	1.5	2.0	5.450	15.44	0.520	0.290
SPRINKLER FITTER		BLD	36.390	39.140	1.5	1.5	2.0	8.420	8.500	0.000	0.450
STONE MASON		BLD	35.880	38.630	1.5	1.5	2.0	7.950	11.73	0.000	0.600
TERRAZZO FINISHER		BLD	32.410	0.000	1.5	1.5	2.0	7.700	4.840	0.000	0.530
TERRAZZO MASON		BLD	35.090	35.340	1.5	1.5	2.0	7.700	7.150	0.000	0.560
TILE LAYER	N	BLD	36.320	40.320	1.5	1.5	2.0	7.700	11.25	0.000	0.600
TILE LAYER	S	BLD	32.040	35.560	1.5	1.5	2.0	8.630	13.87	0.000	0.600
TILE MASON		BLD	35.090	35.340	1.5	1.5	2.0	7.700	7.150	0.000	0.560
TRUCK DRIVER		O&C 1	24.980	0.000	1.5	1.5	2.0	10.30	4.840	0.000	0.250
TRUCK DRIVER		O&C 2	25.340	0.000	1.5	1.5	2.0	10.30	4.840	0.000	0.250
TRUCK DRIVER		O&C 3	25.510	0.000	1.5	1.5	2.0	10.30	4.840	0.000	0.250
TRUCK DRIVER		O&C 4	25.740	0.000	1.5	1.5	2.0	10.30	4.840	0.000	0.250
TRUCK DRIVER		O&C 5	26.420	0.000	1.5	1.5	2.0	10.30	4.840	0.000	0.250
TRUCK DRIVER	E	ALL 1	32.550	33.100	1.5	1.5	2.0	6.500	4.350	0.000	0.000
TRUCK DRIVER	E	ALL 2	32.700	33.100	1.5	1.5	2.0	6.500	4.350	0.000	0.000
TRUCK DRIVER	E	ALL 3	32.900	33.100	1.5	1.5	2.0	6.500	4.350	0.000	0.000
TRUCK DRIVER	E	ALL 4	33.100	33.100	1.5	1.5	2.0	6.500	4.350	0.000	0.000
TRUCK DRIVER	N	ALL 1	32.960	33.420	1.5	1.5	2.0	6.900	8.220	0.000	0.000
TRUCK DRIVER	N	ALL 2	33.110	33.420	1.5	1.5	2.0	6.900	8.220	0.000	0.000
TRUCK DRIVER	N	ALL 3	33.310	33.420	1.5	1.5	2.0	6.900	8.220	0.000	0.000
TRUCK DRIVER	N	ALL 4	33.420	33.420	1.5	1.5	2.0	6.900	8.220	0.000	0.000
TRUCK DRIVER	S	ALL 1	31.230	0.000	1.5	1.5	2.0	10.30	4.840	0.000	0.250
TRUCK DRIVER	S	ALL 2	31.680	0.000	1.5	1.5	2.0	10.30	4.840	0.000	0.250
TRUCK DRIVER	S	ALL 3	31.890	0.000	1.5	1.5	2.0	10.30	4.840	0.000	0.250
TRUCK DRIVER	S	ALL 4	32.180	0.000	1.5	1.5	2.0	10.30	4.840	0.000	0.250
TRUCK DRIVER	S	ALL 5	33.020	0.000	1.5	1.5	2.0	10.30	4.840	0.000	0.250

TUCKPOINTER BLD 35.880 38.630 1.5 1.5 2.0 7.950 11.73 0.000 0.600

Legend :

RG (Region)

TYP (Trade Type - All,Highway,Building,Floating,Oil & Chip,Rivers)

C (Class)

Base (Base Wage Rate)

FRMAN (Foreman Rate)

M-F>8 (OT required for any hour greater than 8 worked each day, Mon through Fri.

OSA (Overtime (OT) is required for every hour worked on Saturday)

OSH (Overtime is required for every hour worked on Sunday and Holidays)

H/W (Health & Welfare Insurance)

Pensn (Pension)

Vac (Vacation)

Trng (Training)

Explanations

OGLE COUNTY

CARPENTER, LATHER, MILLWRIGHT, PILEDRIIVER AND TILE LAYER (NORTH) -
That part of Ogle County East from the Winnebago County western
boundary and North of
an imaginary line running east and west located 4 miles north of the
City of Oregon.

TRUCK DRIVER (EAST) - That part of the county East of Rt. 251,
including all portions of the city of Rochelle, and South of Rt. 72.

TRUCK DRIVER (SOUTH) - That part of the county West of Rt. 251 and
South of Rt. 72.

TRUCK DRIVER (NORTH) - That part of the county North of Route 72.

The following list is considered as those days for which holiday rates
of wages for work performed apply: New Years Day, Memorial Day,
Fourth of July, Labor Day, Thanksgiving Day, Christmas Day and
Veterans Day in some classifications/counties. Generally, any of
these holidays which fall on a Sunday is celebrated on the following
Monday. This then makes work performed on that Monday payable at the
appropriate overtime rate for holiday pay. Common practice in a given
local may alter certain days of celebration. If in doubt, please
check with IDOL.

Oil and chip resealing (O&C) means the application of road oils and
liquid asphalt to coat an existing road surface, followed by
application of aggregate chips or gravel to coated surface, and
subsequent rolling of material to seal the surface.

EXPLANATION OF CLASSES

ASBESTOS - GENERAL - removal of asbestos material/mold and hazardous materials from any place in a building, including mechanical systems where those mechanical systems are to be removed. This includes the removal of asbestos materials/mold and hazardous materials from ductwork or pipes in a building when the building is to be demolished at the time or at some close future date.

ASBESTOS - MECHANICAL - removal of asbestos material from mechanical systems, such as pipes, ducts, and boilers, where the mechanical systems are to remain.

CERAMIC TILE FINISHER, MARBLE FINISHER, TERRAZZO FINISHER

Assisting, helping or supporting the tile, marble and terrazzo mechanic by performing their historic and traditional work assignments required to complete the proper installation of the work covered by said crafts. The term "Ceramic" is used for naming the classification only and is in no way a limitation of the product handled. Ceramic takes into consideration most hard tiles.

COMMUNICATIONS TECHNICIAN

Installing, manufacturing, assembling and maintaining sound and intercom, protection alarm (security), fire alarm, master antenna television, closed circuit television, low voltage control for computers and/or door monitoring, school communications systems, telephones and servicing of nurse and emergency calls, and the installation and maintenance of transmit and receive antennas, transmitters, receivers, and associated apparatus which operates in conjunction with above systems. All work associated with these system installations will be included EXCEPT the installation of protective metallic conduit in new construction projects (excluding less than ten-foot runs strictly for protection of cable) and 120 volt AC (or higher) power wiring and associated hardware.

LABORER, SKILLED - HIGHWAY

Individuals engaged in the following types of work, irrespective of the site of the work: asbestos abatement worker, handling of any materials with any foreign matter harmful to skin or clothing, track laborer, cement handlers, chloride handlers, the unloading and loading with steel workers and re-bars, concrete workers wet, tunnel helpers in free air, batch dumpers, mason tenders, kettle and tar men, tank cleaners, plastic installers, scaffold workers, motorized buggies or motorized unit used for wet concrete or handling of building materials, laborers with de-watering systems, sewer workers plus depth, rod and chainmen with technical engineers, rod and chainmen with land surveyors, rod and chainmen with surveyors, vibrator operators, cement silica, clay, fly ash, lime and plasters, handlers (bulk or bag), cofferdam workers plus depth, on concrete paving, placing, cutting and tying of reinforcing, deck hand, dredge hand, and shore laborers, bankmen on floating plant, grade checker, power tools, front end man on chip spreaders, cession workers plus depth, gunnite nozzle men, lead man on sewer work, welders, cutters, burners and torchmen, chainsaw operators, jackhammer and drill operators, layout man and/or drainage tile layer, steel form setter - street and highway, air tamping hammermen, signal man on crane, concrete saw operator, screedman on asphalt pavers, laborers tending masons with hot material or where foreign materials are used, mortar mixer operators, multiple concrete duct - leadsman, lumen, asphalt raker, curb asphalt machine operator, ready mix scalemen (permanent, portable or temporary plant), laborers handling masterplate or similar materials, laser beam operator, concrete burning machine operator,

coring machine operator, plaster tender, underpinning and shoring of buildings, pump men, manhole and catch basin, dirt and stone tamper, hose men on concrete pumps, hazardous waste worker, lead base paint abatement worker, lining of pipe, refusing machine, assisting on direct boring machine, the work of laying watermain, fire hydrants, all mechanical joints to watermain work, sewer worker, and tapping water service and forced lift station mechanical worker.

MATERIAL TESTER I: Hand coring and drilling for testing of materials; field inspection of uncured concrete and asphalt.

MATERIAL TESTER II: Field inspection of welds, structural steel, fireproofing, masonry, soil, facade, reinforcing steel, formwork, cured concrete, and concrete and asphalt batch plants; adjusting proportions of bituminous mixtures.

OPERATING ENGINEERS - BUILDING

Class 1. Asphalt Plant; Asphalt Spreader; Autograde; Backhoes with Caisson Attachment; Batch Plant; Benoto (requires Two Engineers); Boiler and Throttle Valve; Caisson Rigs; Central Redi-Mix Plant; Combination Back Hoe Front End-loader Machine; Compressor and Throttle Valve; Concrete Breaker (Truck Mounted); Concrete Conveyor; Concrete Paver (over 27E cu. ft.): Concrete Paver (27 cu. ft. and under); Concrete Placer; Concrete Pump (Truck Mounted); Concrete Conveyor (Truck Mounted); Concrete Tower; Cranes, All; GCI and similar types (required two operators only); Cranes, Hammerhead; Creter Crane; Crusher, Stone, etc.; Derricks, All; Derricks, Traveling; Formless Curb and Gutter Machine; Grader, Elevating; Grouting Machines; Highlift Shovels or Front Endloader 2-1/4 yd. and over; Hoists, Elevators, outside type rack and pinion and similar machines; Hoists, one, two and three Drum; Hoists, Two Tugger One Floor; Hydraulic Backhoes; Hydraulic Boom Trucks; Hydro Vac (and similar equipment - excluding hose work and any sewer work); Locomotives, All; Lubrication Technician; Manipulators; Motor Patrol; Pile Drivers and Skid Rig; Post Hole Digger; Pre-Stress Machine; Pump Cretes Dual Ram; Pump Cretes: Squeeze Cretes - Screw Type Pumps, Gypsum Bulker and Pump; Raised and Blind Hole Drill; Rock Drill (self-propelled); Rock Drill - Truck Mounted; Roto Mill Grinder; Scoops - Tractor Drawn; Slipform Paver; Scrapers Prime Movers; Straddle Buggies; Tie Back Machine; Tractor with Boom and Side Boom; Trenching Machines.

Class 2. Bobcat (over 3/4 cu. yd.); Boilers; Brick Forklift; Broom, All Power Propelled; Bulldozers; Concrete Mixer (Two Bag and Over); Conveyor, Portable; Forklift Trucks; Highlift Shovels or Front Endloaders under 2-1/4 yd.; Hoists, Automatic; Hoists, Sewer Dragging Machine; Hoists, Tugger Single Drum; Laser Screed; Rollers, All; Steam Generators; Tractors, All; Tractor Drawn Vibratory Roller; Winch Trucks with "A" Frame.

Class 3. Air Compressor; Asphalt Spreader; Combination - Small Equipment Operator; Generators; Heaters, Mechanical; Hoists, Inside Elevators - (Rheostat Manual Controlled); Hydraulic Power Units (Pile Driving, Extracting, or Drilling - with a seat); Lowboys; Pumps, Over 3" (1 to 3 not to exceed total of 300 ft.); Pumps, Well Points; Welding Machines (2 through 5); Winches, 4 Small Electric Drill Winches; Bobcat (up to and including 3/4 cu. yd.).

Class 4. Elevator push button with automatic doors; Hoists, Inside; Oilers; Brick Forklift.

Class 5. Assistant Craft Foreman

Class 6. Mechanics; Welders.

Class 7. Gradall

OPERATING ENGINEERS - HIGHWAY CONSTRUCTION

Class 1. Asphalt Plant; Asphalt Heater and Planer Combination; Asphalt Heater Scarfire; Asphalt Silo Tender; Asphalt Spreader; Autograder; ABG Paver; Backhoes with Caisson Attachment; Ballast Regulator; Belt Loader; Caisson Rigs; Car Dumper; Central Redi-Mix Plant; Backhoe w/shear attachments; Combination Backhoe Front Endloader Machine, (1 cu. yd. Backhoe Bucket or over or with attachments); Concrete Breaker (Truck Mounted); Concrete Conveyor; Concrete Paver over 27E cu. ft.; Concrete Placer; Concrete Tube Float; Cranes, all attachments; Cranes, Tower of all types; Creter Crane; Crusher, Stone, etc.; Derricks, All; Derrick Boats; Derricks, Traveling; Directional Boring Machine over 12"; Dredges; Formless Curb and Gutter Machine; Grader, Elevating; Grader, Motor Grader, Motor Patrol, Auto Patrol, Form Grader, Pull Grader, Subgrader; Guard Rail Post Driver Mounted; Hoists, One, Two and Three Drum; Hydraulic Backhoes; Hydro Vac, Self Propelled, Truck Mounted (excluding hose work and any sewer work); Lubrication Technician; Manipulators; Pile Drivers and Skid Rig; Pre-Stress Machine; Pump Cretes Dual Ram; Rock Drill - Crawler or Skid Rig; Rock Drill - Truck Mounted; Rock/Track Tamper; Roto Mill Grinder; Slip-Form Paver; Snow Melters; Soil Test Drill Rig (Truck Mounted); Straddle Buggies; GCI Crane; Hydraulic Telescoping Form (Tunnel); Tie Back Machine; Tractor Drawn Belt Loader; Tractor Drawn Belt Loader with attached pusher; Tractor with Boom; Tractaire with Attachments; Traffic Barrier Conveyor Machine; Raised or Blind Hole Drills; Trenching Machine (over 12"); Truck Mounted Concrete Pump with Boom; Truck Mounted Concrete Conveyor; Work Boat (no license required - 90 h.p. or above); Underground Boring and/or Mining Machines; Wheel Excavator; Widener (APSCO).

Class 2. Batch Plant; Bituminous Mixer; Boiler and Throttle Valve; Bulldozers; Car Loader Trailing Conveyors; Combination Backhoe Front Endloader Machine (less than 1 cu. yd. Backhoe Bucket or over or with attachments); Compressor and Throttle Valve; Compressor, Common Receiver (3); Concrete Breaker or Hydro Hammer; Concrete Grinding Machine; Concrete Mixer or Paver 7S Series to and including 27 cu. ft.; Concrete Spreader; Concrete Curing Machine, Burlap Machine, Belting Machine and Sealing Machine; Concrete Wheel Saw (large self-propelled - excluding walk-behinds and hand-held); Conveyor Muck Cars (Haglund or Similar Type); Drills, all; Finishing Machine - Concrete; Highlift Shovels or Front Endloader; Hoist - Sewer Dragging Machine; Hydraulic Boom Trucks (All Attachments); Hydro Blaster; All Locomotives, Dinky; Off-Road Hauling Units; Non-Self Loading Dump; Ejection Dump; Pump Cretes: Squeeze Cretes - Screw Type Pumps, Gypsum Bulker and Pump; Roller, Asphalt; Rotary Snow Plows; Rototiller, Seaman, etc., self-propelled; Scoops - Tractor Drawn; Self-Propelled Compactor; Spreader - Chip - Stone, etc.; Scraper; Scraper - Prime Mover in Tandem (Regardless of Size); Tank Car Heater; Tractors, Push, Pulling Sheeps Foot, Disc, Compactor, etc.; Tug Boats.

Class 3. Boilers; Brooms, All Power Propelled; Cement Supply Tender; Compressor, Common Receiver (2); Concrete Mixer (Two Bag and Over); Conveyor, Portable; Farm-Type Tractors Used for Mowing, Seeding, etc.; Fireman on Boilers; Forklift Trucks; Grouting Machine; Hoists, Automatic; Hoists, All Elevators; Hoists, Tugger Single Drum; Jeep Diggers; Low Boys; Pipe Jacking Machines; Post-Hole Digger; Power Saw, Concrete Power Driven; Pug Mills; Rollers, other than asphalt; Seed and Straw Blower; Steam Generators; Stump Machine; Winch Trucks with "A" Frame; Work Boats; Tamper - Form - Motor Driven.

Class 4. Air Compressor - Small and Large; Asphalt Spreader, Backend Man; Bobcat (Skid Steer) all; Brick Forklift; Combination - Small

Equipment Operator; Directional Boring Machine up to 12"; Generators; Heaters, Mechanical; Hydraulic Power Unit (Pile Driving, Extracting, or Drilling); Hydro-Blaster; Light Plants, All (1 through 5); Pumps, over 3" (1 to 3 not to exceed a total of 300 ft.); Pumps, Well Points; Tractaire; Trencher 12" and under; Welding Machines (2 through 5); Winches, 4 Small Electric Drill Winches.

Class 5. Oilers and Directional Boring Machine Locator.

Class 6. Field Mechanics and Field Welders

Class 7. Gradall and machines of like nature.

TRUCK DRIVER - BUILDING, HEAVY AND HIGHWAY CONSTRUCTION - SOUTH

Class 1. Drivers on 2 axle trucks hauling less than 9 ton. Air compressor and welding machines and brooms, including those pulled by separate units, truck driver helpers, warehouse employees, mechanic helpers, greasers and tiremen, pickup trucks when hauling materials, tools, or workers to and from and on-the-job site, and fork lifts up to 6,000 lb. capacity.

Class 2. Two or three axle trucks hauling more than 9 ton but hauling less than 16 ton. A-frame winch trucks, hydrolift trucks, vector trucks or similar equipment when used for transportation purposes. Fork lifts over 6,000 lb. capacity, winch trucks, four axle combination units, and ticket writers.

Class 3. Two, three or four axle trucks hauling 16 ton or more. Drivers on water pulls, articulated dump trucks, mechanics and working forepersons, and dispatchers. Five axle or more combination units.

Class 4. Low Boy and Oil Distributors.

Class 5. Drivers who require special protective clothing while employed on hazardous waste work.

TRUCK DRIVER - OIL AND CHIP RESEALING ONLY.

This shall encompass laborers, workers and mechanics who drive contractor or subcontractor owned, leased, or hired pickup, dump, service, or oil distributor trucks. The work includes transporting materials and equipment (including but not limited to, oils, aggregate supplies, parts, machinery and tools) to or from the job site; distributing oil or liquid asphalt and aggregate; stock piling material when in connection with the actual oil and chip contract. The Truck Driver (Oil & Chip Resealing) wage classification does not include supplier delivered materials.

TRUCK DRIVER - BUILDING, HEAVY AND HIGHWAY CONSTRUCTION - EAST AND NORTH

Class 1. Two or three Axle Trucks. A-frame Truck when used for transportation purposes; Air Compressors and Welding Machines, including those pulled by cars, pick-up trucks and tractors; Ambulances; Batch Gate Lockers; Batch Hopperman; Car and Truck Washers; Carry-alls; Fork Lifts and Hoisters; Helpers; Mechanics Helpers and Greasers; Oil Distributors 2-man operation; Pavement Breakers; Pole Trailer, up to 40 feet; Power Mower Tractors; Self-propelled Chip Spreader; Skipman; Slurry Trucks, 2-man operation; Slurry Truck Conveyor Operation, 2 or 3 man; Teamsters; Unskilled

dumpman; and Truck Drivers hauling warning lights, barricades, and portable toilets on the job site.

Class 2. Four axle trucks; Dump Crets and Adgetors under 7 yards; Dumpsters, Track Trucks, Euclids, Hug Bottom Dump Turnapulls or Turnatrailers when pulling other than self-loading equipment or similar equipment under 16 cubic yards; Mixer Trucks under 7 yards; Ready-mix Plant Hopper Operator, and Winch Trucks, 2 Axles.

Class 3. Five axle trucks; Dump Crets and Adgetors 7 yards and over; Dumpsters, Track Trucks, Euclids, Hug Bottom Dump Turnatrailers or turnapulls when pulling other than self-loading equipment or similar equipment over 16 cubic yards; Explosives and/or Fission Material Trucks; Mixer Trucks 7 yards or over; Mobile Cranes while in transit; Oil Distributors, 1-man operation; Pole Trailer, over 40 feet; Pole and Expandable Trailers hauling material over 50 feet long; Slurry trucks, 1-man operation; Winch trucks, 3 axles or more; mechanic--Truck Welder and Truck Painter.

Class 4. Six axle trucks; Dual-purpose vehicles, such as mounted crane trucks with hoist and accessories; Foreman; Master Mechanic; Self-loading equipment like P.B. and trucks with scoops on the front.

Other Classifications of Work:

For definitions of classifications not otherwise set out, the Department generally has on file such definitions which are available. If a task to be performed is not subject to one of the classifications of pay set out, the Department will upon being contacted state which neighboring county has such a classification and provide such rate, such rate being deemed to exist by reference in this document. If no neighboring county rate applies to the task, the Department shall undertake a special determination, such special determination being then deemed to have existed under this determination. If a project requires these, or any classification not listed, please contact IDOL at 217-782-1710 for wage rates or clarifications.

LANDSCAPING

Landscaping work falls under the existing classifications for laborer, operating engineer and truck driver. The work performed by landscape plantsman and landscape laborer is covered by the existing classification of laborer. The work performed by landscape operators (regardless of equipment used or its size) is covered by the classifications of operating engineer. The work performed by landscape truck drivers (regardless of size of truck driven) is covered by the classifications of truck driver.

Peoria County Prevailing Wage for May 2013

(See explanation of column headings at bottom of wages)

Trade Name	RG	TYP	C	Base	FRMAN	M-F>8	OSA	OSH	H/W	Pensn	Vac	Trng
=====	==	===	=	=====	=====	=====	===	===	=====	=====	=====	=====
ASBESTOS ABT-GEN		BLD		26.470	27.970	1.5	1.5	2.0	7.700	13.75	0.000	0.800
ASBESTOS ABT-GEN		HWY		28.750	30.000	1.5	1.5	2.0	7.700	13.95	0.000	0.850
ASBESTOS ABT-MEC		BLD		31.840	34.340	1.5	1.5	2.0	10.82	10.66	0.000	0.720
BOILERMAKER		BLD		35.010	38.010	2.0	2.0	2.0	7.070	13.83	0.000	0.300
BRICK MASON		BLD		32.060	33.560	1.5	1.5	2.0	7.700	9.130	0.000	0.560
CARPENTER		BLD		29.330	31.580	1.5	1.5	2.0	7.450	13.66	0.000	0.520
CARPENTER		HWY		30.820	33.070	1.5	1.5	2.0	7.450	13.94	0.000	0.520

CEMENT MASON	BLD		27.090	28.840	1.5	1.5	2.0	8.140	13.55	0.000	0.500
CEMENT MASON	HWY		28.280	29.780	1.5	1.5	2.0	8.140	13.93	0.000	0.500
CERAMIC TILE FNSHER	BLD		29.750	0.000	1.5	1.5	2.0	7.700	9.130	0.000	0.550
ELECTRIC PWR EQMT OP	ALL		35.440	0.000	1.5	1.5	2.0	5.000	10.98	0.000	0.270
ELECTRIC PWR GRNDMAN	ALL		24.320	0.000	1.5	1.5	2.0	5.000	7.540	0.000	0.180
ELECTRIC PWR LINEMAN	ALL		39.370	41.910	1.5	1.5	2.0	5.000	12.20	0.000	0.300
ELECTRIC PWR TRK DRV	ALL		25.510	0.000	1.5	1.5	2.0	5.000	7.920	0.000	0.190
ELECTRICIAN	BLD		34.820	37.320	1.5	1.5	2.0	5.350	10.08	0.000	0.400
ELECTRONIC SYS TECH	BLD		27.430	29.180	1.5	1.5	2.0	5.350	9.320	0.000	0.400
ELEVATOR CONSTRUCTOR	BLD		40.520	45.585	2.0	2.0	2.0	11.88	12.71	3.240	0.600
GLAZIER	BLD		30.770	32.770	1.5	1.5	2.0	9.700	7.700	0.000	1.250
HT/FROST INSULATOR	BLD		42.450	44.950	1.5	1.5	2.0	10.82	11.86	0.000	0.720
IRON WORKER	BLD		30.330	32.230	1.5	1.5	2.0	9.390	11.56	0.000	0.440
IRON WORKER	HWY		34.020	36.020	1.5	1.5	2.0	9.390	11.56	0.000	0.390
LABORER	BLD		25.470	26.970	1.5	1.5	2.0	7.700	13.75	0.000	0.800
LABORER	HWY		28.000	29.250	1.5	1.5	2.0	7.700	13.95	0.000	0.800
LABORER, SKILLED	BLD		25.870	27.370	1.5	1.5	2.0	7.700	13.75	0.000	0.800
LABORER, SKILLED	HWY		28.300	29.550	1.5	1.5	2.0	7.700	13.95	0.000	0.800
LATHER	BLD		29.330	31.580	1.5	1.5	2.0	7.450	13.66	0.000	0.520
MACHINERY MOVER	HWY		34.020	36.020	1.5	1.5	2.0	9.390	11.56	0.000	0.390
MACHINIST	BLD		43.550	46.050	1.5	1.5	2.0	6.130	8.950	1.850	0.000
MARBLE FINISHERS	BLD		29.750	0.000	1.5	1.5	2.0	7.700	9.130	0.000	0.550
MARBLE MASON	BLD		31.510	32.760	1.5	1.5	2.0	7.700	9.130	0.000	0.550
MILLWRIGHT	BLD		30.240	32.490	1.5	1.5	2.0	7.450	13.09	0.000	0.520
MILLWRIGHT	HWY		31.820	34.070	1.5	1.5	2.0	7.450	13.44	0.000	0.520
OPERATING ENGINEER	BLD	1	36.000	39.000	1.5	1.5	2.0	9.750	13.60	0.000	3.000
OPERATING ENGINEER	BLD	2	33.490	39.000	1.5	1.5	2.0	9.750	13.60	0.000	3.000
OPERATING ENGINEER	BLD	3	29.340	39.000	1.5	1.5	2.0	9.750	13.60	0.000	3.000
OPERATING ENGINEER	HWY	1	36.000	39.500	1.5	1.5	2.0	9.750	13.60	0.000	3.000
OPERATING ENGINEER	HWY	2	33.490	39.500	1.5	1.5	2.0	9.750	13.60	0.000	3.000
OPERATING ENGINEER	HWY	3	29.340	39.500	1.5	1.5	2.0	9.750	13.60	0.000	3.000
PAINTER	ALL		32.900	34.900	1.5	1.5	1.5	9.650	8.200	0.000	1.250
PAINTER SIGNS	BLD		33.920	38.090	1.5	1.5	1.5	2.600	2.710	0.000	0.000
PILEDRIVER	BLD		29.830	32.080	1.5	1.5	2.0	7.450	13.66	0.000	0.520
PILEDRIVER	HWY		31.820	34.070	1.5	1.5	2.0	7.450	13.94	0.000	0.520
PIPEFITTER	BLD		37.400	41.510	1.5	1.5	2.0	7.000	11.63	0.000	1.060
PLASTERER	BLD		27.770	28.770	1.5	1.5	2.0	8.140	12.76	0.000	0.600
PLUMBER	BLD		33.570	36.590	1.5	1.5	2.0	7.000	13.31	0.000	0.900
ROOFER	BLD		28.580	30.010	1.5	1.5	2.0	8.450	7.220	0.000	0.250
SHEETMETAL WORKER	BLD		31.920	33.520	1.5	1.5	2.0	7.270	13.08	0.000	0.660
SIGN HANGER	HWY		34.020	36.020	1.5	1.5	2.0	9.390	11.56	0.000	0.390
SPRINKLER FITTER	BLD		36.390	39.140	1.5	1.5	2.0	8.420	8.500	0.000	0.450
STEEL ERECTOR	HWY		34.020	36.020	1.5	1.5	2.0	9.390	11.56	0.000	0.390
STONE MASON	BLD		32.060	33.560	1.5	1.5	2.0	7.700	9.130	0.000	0.560
TERRAZZO FINISHER	BLD		29.750	0.000	1.5	1.5	2.0	7.700	9.130	0.000	0.550
TERRAZZO MASON	BLD		31.510	32.760	1.5	1.5	2.0	7.700	9.130	0.000	0.550
TILE MASON	BLD		31.510	32.760	1.5	1.5	2.0	7.700	9.130	0.000	0.550
TRUCK DRIVER	ALL	1	31.230	0.000	1.5	1.5	2.0	10.30	4.840	0.000	0.250
TRUCK DRIVER	ALL	2	31.680	0.000	1.5	1.5	2.0	10.30	4.840	0.000	0.250
TRUCK DRIVER	ALL	3	31.890	0.000	1.5	1.5	2.0	10.30	4.840	0.000	0.250
TRUCK DRIVER	ALL	4	32.180	0.000	1.5	1.5	2.0	10.30	4.840	0.000	0.250
TRUCK DRIVER	ALL	5	33.020	0.000	1.5	1.5	2.0	10.30	4.840	0.000	0.250
TRUCK DRIVER	O&C	1	24.980	0.000	1.5	1.5	2.0	10.30	4.840	0.000	0.250
TRUCK DRIVER	O&C	2	25.340	0.000	1.5	1.5	2.0	10.30	4.840	0.000	0.250
TRUCK DRIVER	O&C	3	25.510	0.000	1.5	1.5	2.0	10.30	4.840	0.000	0.250
TRUCK DRIVER	O&C	4	25.740	0.000	1.5	1.5	2.0	10.30	4.840	0.000	0.250
TRUCK DRIVER	O&C	5	26.420	0.000	1.5	1.5	2.0	10.30	4.840	0.000	0.250
TUCKPOINTER	BLD		32.060	33.560	1.5	1.5	2.0	7.700	9.130	0.000	0.560

Legend :

RG (Region)

TYP (Trade Type - All,Highway,Building,Floating,Oil & Chip,Rivers)

C (Class)

Base (Base Wage Rate)

FRMAN (Foreman Rate)

M-F>8 (OT required for any hour greater than 8 worked each day, Mon through Fri.)

OSA (Overtime (OT) is required for every hour worked on Saturday)

OSH (Overtime is required for every hour worked on Sunday and Holidays)

H/W (Health & Welfare Insurance)

Pensn (Pension)

Vac (Vacation)

Trng (Training)

Explanations

PEORIA COUNTY

The following list is considered as those days for which holiday rates of wages for work performed apply: New Years Day, Memorial Day, Fourth of July, Labor Day, Thanksgiving Day, Christmas Day and Veterans Day in some classifications/counties. Generally, any of these holidays which fall on a Sunday is celebrated on the following Monday. This then makes work performed on that Monday payable at the appropriate overtime rate for holiday pay. Common practice in a given local may alter certain days of celebration. If in doubt, please check with IDOL.

Oil and chip resealing (O&C) means the application of road oils and liquid asphalt to coat an existing road surface, followed by application of aggregate chips or gravel to coated surface, and subsequent rolling of material to seal the surface.

EXPLANATION OF CLASSES

ASBESTOS - GENERAL - removal of asbestos material/mold and hazardous materials from any place in a building, including mechanical systems where those mechanical systems are to be removed. This includes the removal of asbestos materials/mold and hazardous materials from ductwork or pipes in a building when the building is to be demolished at the time or at some close future date.

ASBESTOS - MECHANICAL - removal of asbestos material from mechanical systems, such as pipes, ducts, and boilers, where the mechanical systems are to remain.

CERAMIC TILE FINISHER, MARBLE FINISHER, TERRAZZO FINISHER

Assisting, helping or supporting the tile, marble and terrazzo mechanic by performing their historic and traditional work assignments required to complete the proper installation of the work covered by said crafts. The term "Ceramic" is used for naming the classification only and is in no way a limitation of the product handled. Ceramic takes into consideration most hard tiles.

ELECTRONIC SYSTEMS TECHNICIAN

Installation, service and maintenance of low-voltage systems which utilizes the transmission and/or transference of voice, sound, vision, or digital for commercial, education, security and entertainment purposes for the following: TV monitoring and surveillance, background/foreground music, intercom and telephone interconnect, field programming, inventory control systems, microwave transmission, multi-media, multiplex, radio page, school, intercom and sound burglar alarms and low voltage master clock systems.

Excluded from this classification are energy management systems, life safety systems, supervisory controls and data acquisition systems not intrinsic with the above listed systems, fire alarm systems, nurse call systems and raceways exceeding fifteen feet in length.

LABORER, SKILLED - BUILDING

The skilled laborer building (BLD) classification shall encompass the following types of work, irrespective of the site of the work: cutting & acetylene torch, gunnite nozzlemen, gunnite pump men & pots, kettlemen & carriers of men handling hot stuff, sandblaster nozzle men, sandblasting pump men & pots, setting up and using concrete burning bars, wood block setters, underpinning & shoring of existing buildings, and the unload-ing and handling of all material coated with creosote.

LABORER, SKILLED - HIGHWAY

The skilled laborer heavy & highway (HWY) classification shall encompass the following types of work,irrespective of the site of the work: jackhammer & drill operator, gunite pump & pot man, puddlers, vibrator men, wire fabric placer, sandblast pump & pot man, strike off concrete, unloading, handling & carrying of all creosoted piles, ties or timber, concrete burning bars, power wheelbarrows or buggies, asphalt raker, brickset-ters, cutting torchman (electric & acetylene), men setting lines to level forms, form setters, gunite nozzle man & sandblasting nozzle man, power man, and rip-rapping by hand.

TRUCK DRIVER - BUILDING, HEAVY AND HIGHWAY CONSTRUCTION

Class 1. Drivers on 2 axle trucks hauling less than 9 ton. Air compressor and welding machines and brooms, including those pulled by separate units, truck driver helpers, warehouse employees, mechanic helpers, greasers and tiremen, pickup trucks when hauling materials, tools, or workers to and from and on-the-job site, and fork lifts up to 6,000 lb. capacity.

Class 2. Two or three axle trucks hauling more than 9 ton but hauling less than 16 ton. A-frame winch trucks, hydrolift trucks, vactor trucks or similar equipment when used for transportation purposes. Fork lifts over 6,000 lb. capacity, winch trucks, four axle combination units, and ticket writers.

Class 3. Two, three or four axle trucks hauling 16 ton or more. Drivers on water pulls, articulated dump trucks, mechanics and working forepersons, and dispatchers. Five axle or more combination units.

Class 4. Low Boy and Oil Distributors.

Class 5. Drivers who require special protective clothing while employed on hazardous waste work.

TRUCK DRIVER - OIL AND CHIP RESEALING ONLY.

This shall encompass laborers, workers and mechanics who drive contractor or subcontractor owned, leased, or hired pickup, dump, service, or oil distributor trucks. The work includes transporting materials and equipment (including but not limited to, oils, aggregate supplies, parts, machinery and tools) to or from the job site; distributing oil or liquid asphalt and aggregate; stock piling material when in connection with the actual oil and chip contract. The Truck Driver (Oil & Chip Resealing) wage classification does not include supplier delivered materials.

OPERATING ENGINEERS - BUILDING

Class 1. Cranes; Overhead Cranes; Gradall; All Cherry Pickers; Mechanics; Central Concrete Mixing Plant Operator; Road Pavers (27E - Dual Drum - Tri Batchers); Blacktop Plant Operators and Plant Engineers; 3 Drum Hoist; Derricks; Hydro Cranes; Shovels; Skimmer Scoops; Koehring Scooper; Drag Lines; Backhoe; Derrick Boats; Pile Drivers and Skid Rigs; Clamshells; Locomotive Cranes; Dredge (all types) Motor Patrol; Power Blades - Dumore - Elevating and similar types; Tower Cranes (Crawler-Mobile) and Stationary; Crane-type Backfiller; Drott Yumbo and similar types considered as Cranes; Caisson Rigs; Dozer; Tournadozer; Work Boats; Ross Carrier; Helicopter; Tournapulls - all and similar types; Scoops (all sizes); Pushcats; Endloaders (all types); Asphalt Surfacing Machine; Slip Form Paver; Rock Crusher; Heavy Equipment Greaser; CMI, CMI Belt Placer, Auto Grade & 3 Track and similar types; Side Booms; Multiple Unit Earth Movers; Creter Crane; Trench Machine; Pump-crete-Belt Crete-Squeeze Cretes-Screw-type Pumps and Gypsum; Bulker & Pump - Operator will clean; Formless Finishing Machine; Flaherty Spreader or similar types; Screed Man on Laydown Machine; Wheel Tractors (industrial or Farm-type w/Dozer-Hoe-Endloader or other attachments); F.W.D. & Similar Types; Vermeer Concrete Saw.

Class 2. Dinkeys; Power Launches; PH One-pass Soil Cement Machine (and similar types); Pugmill with Pump; Backfillers; Euclid Loader; Forklifts; Jeeps w/Ditching Machine or other attachments; Tuneluger; Automatic Cement and Gravel Batching Plants; Mobile Drills (Soil Testing) and similar types; Gurries and Similar Types; (1) and (2) Drum Hoists (Buck Hoist and Similar Types); Chicago Boom; Boring Machine & Pipe Jacking Machine; Hydro Boom; Dewatering System; Straw Blower; Hydro Seeder; Assistant Heavy Equipment Greaser on Spread; Tractors (Track type) without Power Unit pulling Rollers; Rollers on Asphalt -- Brick Macadem; Concrete Breakers; Concrete Spreaders; Mule Pulling Rollers; Center Stripper; Cement Finishing Machines & CMI Texture & Reel Curing Machines; Cement Finishing Machine; Barber Green or similar loaders; Vibro Tamper (All similar types) Self-propelled; Winch or Boom Truck; Mechanical Bull Floats; Mixers over 3 Bag to 27E; Tractor pulling Power Blade or Elevating Grader; Porter Rex Rail; Clary Screed; Truck Type Hoptoe Oilers; Fireman; Spray Machine on Paving; Curb Machines; Truck Crane Oilers; Oil Distributor; Truck-Mounted Saws.

Class 3. Air Compressor; Power Subgrader; Straight Tractor; Trac Air without attachments; Herman Nelson Heater, Dravo, Warner, Silent Glo, and similar types; Roller: Five (5) Ton and under on Earth or Gravel; Form Grader; Crawler Crane & Skid Rig Oilers; Freight Elevators - permanently installed; Pump; Light Plant; Generator; Conveyor (1) or (2) - Operator will clean; Welding Machine; Mixer (3) Bag and Under (Standard Capacity with skip); Bulk Cement Plant; Oiler on Central Concrete Mixing Plant.

OPERATING ENGINEERS - HEAVY AND HIGHWAY CONSTRUCTION

CLASS 1. Cranes; Hydro Cranes; Shovels; Crane Type Backfiller; Tower,

Mobile, Crawler, & Stationary Cranes; Derricks; Hoists (3 Drum); Draglines; Drott Yumbo & Similar Types considered as Cranes; 360 Degree Swing Excavator (Shears, Grapples, Movacs, etc.); Back Hoe; Derrick Boats; Pile Driver and Skid Rigs; Clam Shell; Locomotive - Cranes; Road Pavers - Single Drum - Dual Drum - Tri Batcher; Motor Patrols & Power Blades - Dumore - Elevating & Similar Types; Mechanics; Central Concrete Mixing Plant Operator; Asphalt Batch Plant Operators and Plant Engineers; Gradall; Caisson Rigs; Skimmer Scoop - Koering Scooper; Dredges (all types); Hoptoe; All Cherry Pickers; Work Boat; Ross Carrier; Helicopter; Dozer; Tournadozer; Tournapulls - all and similar types; Operation of Concrete and all Recycle Machines; Multiple Unit Earth Movers; Scoops (all sizes); Pushcats; Endloaders (all types); Asphalt Surfacing Machine; Slip Form Paver; Rock Crusher; Operation of Material Crusher, Screening Plants, and Tunnel Boring Machine; Heavy Equipment Greaser (top greaser on spread); CMI, Auto Grade, CMI Belt Placer & 3 Track and Similar Types; Side Booms; Asphalt Heater & Planer Combination (used to plane streets); Wheel Tractors (with Dozer, Hoe or Endloader Attachments); CAT Earthwork Compactors and Similar Types; Blaw Knox Spreader and Similar Types; Trench Machines; Pump Crete - Belt Crete - Squeeze Crete - Screw Type Pumps and Gypsum (operator will clean); Creter Crane; Operation of Concrete Pump Truck; Formless Finishing Machines; Flaherty Spreader or Similar Types; Screed Man on Laydown Machine; Vermeer Concrete Saw; Operation of Laser Screed; Span Saw; Dredge Leverman; Dredge Engineer; Lull or Similar Type; Hydro-Boom Truck; Operation of Guard Rail Machine; and Starting Engineer on Pipeline or Construction (11 or more pieces) including: Air Compressor (Trailer Mounted), All Forced Air Heaters (regardless of Size), Water Pumps (Greater than 4-1/2" or Total Discharge Over 4-1/2"), Light Plants, Generators (Trailer Mounted - Excluding Decontamination Trailer), Welding Machines (Any Size or Mode of Power), Conveyor, Mixer (any size), Stud Welder, Power Pac, etc, and Ground Heater (Trailer Mounted).

CLASS 2. Bulker & Pump; Power Launches; Boring Machine & Pipe Jacking Machine; Dinkeys; Operation of Carts, Powered Haul Unit for a Boring Machine; P & H One Pass Soil Cement Machines and Similar Types; Wheel Tractors (Industry or Farm Type - Other); Back Fillers; Euclid Loader; Fork Lifts; Jeep w/Ditching Machine or Other Attachments; Tunneluger; Automatic Cement & Gravel Batching Plants; Mobile Drills - Soil Testing and Similar Types; Pugmill with Pump; All (1) and (2) Drum Hoists; Dewatering System; Straw Blower; Hydro-Seeder; Bump Grinders (self-propelled); Assistant Heavy Equipment Greaser; Apsco Spreader; Tractors (Track-Type) without Power Units Pulling Rollers; Rollers on Asphalt - Brick or Macadam; Concrete Breakers; Concrete Spreaders; Cement Strippers; Cement Finishing Machines & CMI Texture & Reel Curing Machines; Vibro-Tampers (All Similar Types Self-Propelled); Mechanical Bull Floats; Self-Propelled Concrete Saws; Truck Mounted Power Saws; Operation of Curb Cutters; Mixers - Over Three (3) Bags; Winch and Boom Trucks; Tractor Pulling Power Blade or Elevating Grader; Porter Rex Rail; Clary Screed; Mule Pulling Rollers; Pugmill without Pump; Barber Greene or Similar Loaders; Track Type Tractor w/Power Unit attached (minimum); Fireman; Spray Machine on Paving; Curb Machines; Paved Ditch Machine; Power Broom; Self-Propelled Sweepers; Self-Propelled Conveyors; Power Subgrader; Oil Distributor; Straight Tractor; Truck Crane Oiler; Truck Type Oilers; Directional Boring Machine; Horizontal Directional Drill; Articulating End Dump Vehicles; Starting Engineer on Pipeline or Construction (6 -10 pieces) including: Air Compressor (Trailer Mounted), All Forced Air Heaters (regardless of Size), Water Pumps (Greater than 4-1/2" or Total Discharge Over 4-1/2"), Light Plants, Generators (Trailer Mounted - Excluding Decontamination Trailer), Welding Machines (Any Size or Mode of Power), Conveyor, Mixer (any size), Stud Welder, Power Pac, etc., and Ground Heater (Trailer Mounted).

CLASS 3. Straight Framed Truck Mounted Vac Unit (separately powered); Trac Air Machine (without attachments); Rollers - Five Ton and Under on Earth and Gravel; Form Graders; Bulk Cement Plant; Oilers; and Starting Engineer on Pipeline or Construction (3 - 5 pieces) including: Air Compressor (Trailer Mounted), All Forced Air Heaters (regardless of Size), Water Pumps (Greater than 4-1/2" or Total Discharge Over 4-1/2"), Light Plants, Generators (Trailer Mounted - Excluding Decontamination Trailer), Welding Machines (Any Size or Mode of Power), Conveyor, Mixer (any size), Stud Welder, Power Pac, etc., and Ground Heater (Trailer Mounted).

Other Classifications of Work:

For definitions of classifications not otherwise set out, the Department generally has on file such definitions which are available. If a task to be performed is not subject to one of the classifications of pay set out, the Department will upon being contacted state which neighboring county has such a classification and provide such rate, such rate being deemed to exist by reference in this document. If no neighboring county rate applies to the task, the Department shall undertake a special determination, such special determination being then deemed to have existed under this determination. If a project requires these, or any classification not listed, please contact IDOL at 217-782-1710 for wage rates or clarifications.

LANDSCAPING

Landscaping work falls under the existing classifications for laborer, operating engineer and truck driver. The work performed by landscape plantsman and landscape laborer is covered by the existing classification of laborer. The work performed by landscape operators (regardless of equipment used or its size) is covered by the classifications of operating engineer. The work performed by landscape truck drivers (regardless of size of truck driven) is covered by the classifications of truck driver.

Perry County Prevailing Wage for May 2013

(See explanation of column headings at bottom of wages)

Trade Name	RG	TYP	C	Base	FRMAN	M-F>8	OSA	OSH	H/W	Pensn	Vac	Trng
ASBESTOS ABT-GEN	ALL			25.300	25.750	1.5	1.5	2.0	5.750	10.35	0.000	0.900
ASBESTOS ABT-MEC	BLD			29.860	30.860	1.5	1.5	2.0	6.950	3.000	0.000	0.000
BOILERMAKER	BLD			31.500	34.000	1.5	1.5	2.0	7.070	18.73	1.000	0.350
BRICK MASON	BLD			28.620	30.120	1.5	1.5	2.0	8.200	7.030	0.000	0.430
CARPENTER	BLD			31.890	33.390	1.5	1.5	2.0	6.550	6.750	0.000	0.400
CARPENTER	HWY			31.840	33.340	1.5	1.5	2.0	6.550	6.750	0.000	0.400
CEMENT MASON	BLD			28.200	29.700	1.5	1.5	2.0	6.600	5.400	0.000	0.500
CEMENT MASON	HWY			27.290	28.290	1.5	1.5	2.0	6.600	5.160	0.000	0.400
CERAMIC TILE FNSHER	BLD			27.120	0.000	1.5	1.5	2.0	8.200	7.030	0.000	0.430
ELECTRIC PWR EQMT OP	ALL	1		35.570	0.000	1.5	1.5	2.0	5.000	9.960	0.000	0.360
ELECTRIC PWR EQMT OP	ALL	2		31.740	0.000	1.5	1.5	2.0	5.000	8.880	0.000	0.320
ELECTRIC PWR GRNDMAN	ALL			26.100	0.000	1.5	1.5	2.0	5.000	7.310	0.000	0.260
ELECTRIC PWR LINEMAN	ALL			44.630	47.650	1.5	1.5	2.0	5.000	12.50	0.000	0.450
ELECTRICIAN	ALL			39.350	41.600	1.5	1.5	2.0	6.140	9.440	0.000	0.790
ELECTRONIC SYS TECH	BLD			32.570	34.320	1.5	1.5	2.0	6.000	4.240	0.000	0.400
ELEVATOR CONSTRUCTOR	BLD			43.715	49.180	2.0	2.0	2.0	11.88	12.71	3.500	0.600
FLOOR LAYER	BLD			29.330	30.080	1.5	1.5	2.0	6.550	6.750	0.000	0.400
GLAZIER	BLD			32.780	0.000	2.0	2.0	2.0	9.020	10.80	2.630	0.310
HT/FROST INSULATOR	BLD			37.260	38.260	1.5	1.5	2.0	7.850	11.16	0.000	0.500
IRON WORKER	ALL			31.500	33.500	1.5	1.5	2.0	7.610	13.33	0.000	0.420
LABORER	BLD			25.300	25.750	1.5	1.5	2.0	5.750	10.35	0.000	0.800

LABORER	HWY	25.300	25.750	1.5	1.5	2.0	5.750	10.35	0.000	0.800
LABORER	O&C	17.740	18.190	1.5	1.5	2.0	5.450	8.450	0.000	0.800
MACHINIST	BLD	43.550	46.050	1.5	1.5	2.0	6.130	8.950	1.850	0.000
MARBLE FINISHERS	BLD	27.120	0.000	1.5	1.5	2.0	8.200	7.030	0.000	0.430
MARBLE MASON	BLD	28.620	30.120	1.5	1.5	2.0	8.200	7.030	0.000	0.430
MILLWRIGHT	BLD	31.890	33.390	1.5	1.5	2.0	6.550	6.750	0.000	0.400
MILLWRIGHT	HWY	31.840	33.340	1.5	1.5	2.0	6.550	6.750	0.000	0.400
OPERATING ENGINEER	BLD 1	34.200	37.200	1.5	1.5	2.0	9.000	17.00	0.000	1.000
OPERATING ENGINEER	BLD 2	33.070	37.200	1.5	1.5	2.0	9.000	17.00	0.000	1.000
OPERATING ENGINEER	BLD 3	28.590	37.200	1.5	1.5	2.0	9.000	17.00	0.000	1.000
OPERATING ENGINEER	BLD 4	28.650	37.200	1.5	1.5	2.0	9.000	17.00	0.000	1.000
OPERATING ENGINEER	BLD 5	28.320	37.200	1.5	1.5	2.0	9.000	17.00	0.000	1.000
OPERATING ENGINEER	BLD 6	35.750	37.200	1.5	1.5	2.0	9.000	17.00	0.000	1.000
OPERATING ENGINEER	BLD 7	36.050	37.200	1.5	1.5	2.0	9.000	17.00	0.000	1.000
OPERATING ENGINEER	BLD 8	36.330	37.200	1.5	1.5	2.0	9.000	17.00	0.000	1.000
OPERATING ENGINEER	BLD 9	35.650	37.200	1.5	1.5	2.0	9.000	17.00	0.000	1.000
OPERATING ENGINEER	HWY 1	32.700	35.700	1.5	1.5	2.0	9.000	17.00	0.000	1.000
OPERATING ENGINEER	HWY 2	31.570	35.700	1.5	1.5	2.0	9.000	17.00	0.000	1.000
OPERATING ENGINEER	HWY 3	27.090	35.700	1.5	1.5	2.0	9.000	17.00	0.000	1.000
OPERATING ENGINEER	HWY 4	27.150	35.700	1.5	1.5	2.0	9.000	17.00	0.000	1.000
OPERATING ENGINEER	HWY 5	26.820	35.700	1.5	1.5	2.0	9.000	17.00	0.000	1.000
OPERATING ENGINEER	HWY 6	34.250	35.700	1.5	1.5	2.0	9.000	17.00	0.000	1.000
OPERATING ENGINEER	HWY 7	34.550	35.700	1.5	1.5	2.0	9.000	17.00	0.000	1.000
OPERATING ENGINEER	HWY 8	34.830	35.700	1.5	1.5	2.0	9.000	17.00	0.000	1.000
OPERATING ENGINEER	HWY 9	34.150	35.700	1.5	1.5	2.0	9.000	17.00	0.000	1.000
OPERATING ENGINEER	O&C 1	25.090	26.090	1.5	1.5	2.0	7.000	8.800	0.000	1.450
OPERATING ENGINEER	O&C 2	23.660	26.090	1.5	1.5	2.0	7.000	8.800	0.000	1.450
OPERATING ENGINEER	O&C 3	18.120	26.090	1.5	1.5	2.0	7.000	8.800	0.000	1.450
OPERATING ENGINEER	O&C 4	16.050	21.100	1.5	1.5	2.0	5.650	6.100	0.000	1.100
PAINTER	BLD	26.260	27.760	1.5	1.5	2.0	6.630	7.070	0.000	0.500
PAINTER	HWY	30.560	32.060	1.5	1.5	2.0	6.630	7.070	0.000	0.500
PAINTER OVER 30FT	BLD	27.260	28.760	1.5	1.5	2.0	6.630	7.070	0.000	0.500
PAINTER PWR EQMT	BLD	27.260	28.760	1.5	1.5	2.0	6.630	7.070	0.000	0.500
PAINTER PWR EQMT	HWY	31.560	33.060	1.5	1.5	2.0	6.630	7.070	0.000	0.500
PILEDRIVER	BLD	31.890	33.390	1.5	1.5	2.0	6.550	6.750	0.000	0.400
PILEDRIVER	HWY	31.840	33.340	1.5	1.5	2.0	6.550	6.750	0.000	0.400
PIPEFITTER	BLD	41.470	45.620	1.5	2.0	2.0	8.450	5.780	0.000	1.250
PLASTERER	BLD	28.200	29.700	1.5	1.5	2.0	6.600	5.400	0.000	0.500
PLUMBER	BLD	41.470	45.620	1.5	2.0	2.0	8.450	5.780	0.000	1.250
ROOFER	BLD	23.900	24.900	1.5	1.5	2.0	8.650	3.800	0.000	0.000
SHEETMETAL WORKER	ALL	31.690	33.190	1.5	1.5	2.0	7.130	6.730	1.910	0.360
SPRINKLER FITTER	BLD	36.390	39.140	1.5	1.5	2.0	8.420	8.500	0.000	0.450
STONE MASON	BLD	28.620	30.120	1.5	1.5	2.0	8.200	7.030	0.000	0.430
TERRAZZO FINISHER	BLD	27.120	0.000	1.5	1.5	2.0	8.200	7.030	0.000	0.430
TERRAZZO MASON	BLD	28.620	30.120	1.5	1.5	2.0	8.200	7.030	0.000	0.430
TRUCK DRIVER	ALL 1	30.070	0.000	1.5	1.5	2.0	10.30	6.100	0.000	0.250
TRUCK DRIVER	ALL 2	30.520	0.000	1.5	1.5	2.0	10.30	6.100	0.000	0.250
TRUCK DRIVER	ALL 3	30.740	0.000	1.5	1.5	2.0	10.30	6.100	0.000	0.250
TRUCK DRIVER	ALL 4	31.030	0.000	1.5	1.5	2.0	10.30	6.100	0.000	0.250
TRUCK DRIVER	ALL 5	31.850	0.000	1.5	1.5	2.0	10.30	6.100	0.000	0.250
TRUCK DRIVER	O&C 1	22.750	0.000	1.5	1.5	2.0	2.920	6.700	0.000	0.250
TRUCK DRIVER	O&C 2	19.150	0.000	1.5	1.5	2.0	2.920	6.700	0.000	0.250
TRUCK DRIVER	O&C 3	19.650	0.000	1.5	1.5	2.0	2.920	6.700	0.000	0.250
TUCKPONTER	BLD	28.620	30.120	1.5	1.5	2.0	8.200	7.030	0.000	0.430

Legend :

RG (Region)

TYP (Trade Type - All,Highway,Building,Floating,Oil & Chip,Rivers)

C (Class)

Base (Base Wage Rate)

FRMAN (Foreman Rate)

M-F>8 (OT required for any hour greater than 8 worked each day, Mon through Fri.)

OSA (Overtime (OT) is required for every hour worked on Saturday)

OSH (Overtime is required for every hour worked on Sunday and Holidays)

H/W (Health & Welfare Insurance)

Pensn (Pension)

Vac (Vacation)

Trng (Training)

Explanations

PERRY COUNTY

The following list is considered as those days for which holiday rates of wages for work performed apply: New Years Day, Memorial Day, Fourth of July, Labor Day, Thanksgiving Day, Christmas Day and Veterans Day in some classifications/counties. Generally, any of these holidays which fall on a Sunday is celebrated on the following Monday. This then makes work performed on that Monday payable at the appropriate overtime rate for holiday pay. Common practice in a given local may alter certain days of celebration. If in doubt, please check with IDOL.

OIL AND CHIP RESEALING means the application of road oils and liquid asphalt to coat an existing road surface, followed by application of aggregate chips or gravel to coated surface, and subsequent rolling of material to seal the surface.

EXPLANATION OF CLASSES

ASBESTOS - GENERAL - removal of asbestos material/mold and hazardous materials from any place in a building, including mechanical systems where those mechanical systems are to be removed. This includes the removal of asbestos materials/mold and hazardous materials from ductwork or pipes in a building when the building is to be demolished at the time or at some close future date.

ASBESTOS - MECHANICAL - removal of asbestos material from mechanical systems, such as pipes, ducts, and boilers, where the mechanical systems are to remain.

LABORER - OIL AND CHIP RESEALING ONLY

Hook and unhook chip box from aggregate truck; distribute material within chip box; perform flagging work related to oil and chip resealing; hand spray oil fluids; handle traffic control, including setting-up and maintaining barricades, drums, cones, delineators, signs and other such items, as well as laying-out and applying or removing temporary roadway markings used to control traffic in job site related to oil and chip resealing; and perform clean-up related to oil and chip resealing.

CERAMIC TILE FINISHER, MARBLE FINISHER, TERRAZZO FINISHER

Assisting, helping or supporting the tile, marble and terrazzo mechanic by performing their historic and traditional work assignments required to complete the proper installation of the work covered by said crafts. The term "Ceramic" is used for naming the classification only, and is in no a limitation of the product handled. Ceramic takes into consideration most hard tiles.

ELECTRIC POWER LINEMAN

Construction, maintenance and dismantling of overhead and underground electric power lines, including high voltage pipe type cable work, and associated structures and equipment.

ELECTRIC POWER EQUIPMENT OPERATOR - CLASS 1

Operation of all crawler type equipment D-4 and larger from the ground to assist the Electric Power Linemen in performing their duties.

ELECTRIC POWER EQUIPMENT OPERATORS - CLASS 2

Operation of all other equipment from the ground to assist the Electric Power Linemen in performing their duties.

ELECTRIC POWER GROUNDMAN

Applies to workers who assist the Electric Power Lineman from the ground. consideration most hard tiles.

ELECTRONIC SYSTEMS TECHNICIAN

Installation, service and maintenance of low-voltage systems which utilizes the transmission and/or transference of voice, sound, vision, or digital for commercial, education, security and entertainment purposes for the following: TV monitoring and surveillance, background/foreground music, intercom and telephone interconnect, field programming, inventory control systems, microwave transmission, multi-media, multiplex, radio page, school, intercom and sound burglar alarms and low voltage master clock systems.

Excluded from this classification are energy management systems, life safety systems, supervisory controls and data acquisition systems not intrinsic with the above listed systems, fire alarm systems, nurse call systems and raceways exceeding fifteen feet in length.

OPERATING ENGINEER - BUILDING

GROUP I. Cranes, Dragline, Shovels, Skimmer Scoops, Clamshells or Derrick Boats, Pile Drivers, Crane-Type Backhoes, Asphalt Plant Operators, Concrete Plant Operators, Dredges, Asphalt Spreading Machines, All Locomotives, Cable Ways or Tower Machines, Hoists, Hydraulic Backhoes, Ditching Machines or Backfiller, Cherrypickers, Overhead Cranes, Roller - Steam or Gas, Concrete Pavers, Excavators, Concrete Breakers, Concrete Pumps, Bulk Cement Plants, Cement Pumps, Derrick-Type Drills, Boat Operators, Motor Graders or Pushcats, Scoops or Tournapulls, Bulldozers, Endloaders or Fork Lifts, Power Blade or Elevating Graders, Winch Cats, Boom or Winch Trucks or Boom Tractors, Pipe Wrapping or Painting Machines, Asphalt Plant Engineer, Journeyman Lubricating Engineer, Drills (other than Derrick Type), Mud Jacks, or Well Drilling Machines, Boring Machines or Track Jacks, Mixers, Conveyors (Two), Air Compressors (Two), Water Pumps regardless of size (Two), Welding Machines (Two), Siphons or Jets (Two), Winch Heads or Apparatuses (Two), Light Plants (Two), All Tractors regardless of size (straight tractor only), Fireman on Stationary Boilers, Automatic Elevators, Form Grading Machines, Finishing Machines, Power Sub-Grader

or Ribbon Machines, Longitudinal Floats, Distributor Operators on Trucks, Winch Heads or Apparatuses (One), Mobil Track air and heaters (two to five), Heavy Equipment Greaser, Relief Operator, Assistant Master Mechanic and Heavy Duty Mechanic, self-propelled concrete saws of all types and sizes with their attachments, gob-hoppers, excavators all sizes, the repair and greasing of all diesel hammers, the operation and set-up of bidwells, water blasters of all sizes and their clutches, hydraulic jacks where used for hoisting, operation of log skidders, iceolators used on and off of pipeline, condor cranes, bow boats, survey boats, bobcats and all their attachments, skid steer loaders and all their attachments, creter cranes, batch plants, operator (all sizes), self propelled roto mills, operation of conveyor systems of any size and any configuration, operation, repair and service of all vibratory hammers, all power pacs and their controls regardless of location, curtains or brush burning machines, stump cutter machines, Nail launchers when mounted on a machine or self-propelled, operation of con-cover machines, and all Operators except those listed below).

GROUP II. Assistant Operators.

GROUP III. Air Compressors (One), Water Pumps, regardless of Size (One), Waterblasters (one), Welding Machine (One), Mixers (One Bag), Conveyor (One), Siphon or Jet (One), Light Plant (One), Heater (One), Immobile Track Air (One), and Self Propelled Walk-Behind Rollers.

GROUP IV. Asphalt Spreader Oilers, Fireman on Whirlies and Heavy Equipment Oilers, Truck Cranes, Dredges, Monigans, Large Cranes - (Over 65-ton rated capacity) Concrete Plant Oiler, Blacktop Plant Oiler, and Creter Crane Oiler (when required).

GROUP V. Oiler.

GROUP VI. Operators on equipment with Booms, including jibs, 100 feet and over, and less than 150 feet long.

GROUP VII. Operators on equipment with Booms, including jibs, 150 feet and over, and less than 200 feet long.

GROUP VIII. Operators on Equipment with Booms, including jibs, 200 feet and over; Tower Cranes; and Whirlie Cranes.

GROUP IX. Master Mechanic

OPERATING ENGINEERS - Highway

GROUP I. Cranes, Dragline, Shovels, Skimmer Scoops, Clamshells or Derrick Boats, Pile Drivers, Crane-Type Backhoes, Asphalt Plant Operators, Concrete Plant Operators, Dredges, Asphalt Spreading Machines, All Locomotives, Cable Ways or Tower Machines, Hoists, Hydraulic Backhoes, Ditching Machines or Backfiller, Cherrypickers, Overhead Cranes, Roller - Steam or Gas, Concrete Pavers, Excavators, Concrete Breakers, Concrete Pumps, Bulk Cement Plants, Cement Pumps, Derrick-Type Drills, Boat Operators, Motor Graders or Pushcats, Scoops or Tournapulls, Bulldozers, Endloaders or Fork Lifts, Power Blade or Elevating Graders, Winch Cats, Boom or Winch Trucks or Boom Tractors, Pipe Wrapping or Painting Machines, Asphalt Plant Engineer, Journeyman Lubricating Engineer, Drills (other than Derrick Type), Mud Jacks, Well Drilling Machines, Boring Machines, Track Jacks, Mixers, Conveyors (Two), Air Compressors (Two), Water Pumps regardless of size (Two), Welding Machines (Two), Siphons or Jets (Two), Winch Heads or Apparatuses (Two), Light Plants (Two), All Tractors regardless of size (straight tractor only), Fireman on Stationary Boilers, Automatic Elevators, Form Grading Machines, Finishing Machines, Power Sub-Grader or Ribbon Machines, Longitudinal Floats, Distributor Operators on

Trucks, Winch Heads or Apparatuses (One), Mobil Track air and heaters (two to five), Heavy Equipment Greaser, Relief Operator, Assistant Master Mechanic and Heavy Duty Mechanic, self-propelled concrete saws of all types and sizes with their attachments, gob-hoppers, excavators all sizes, the repair and greasing of all diesel hammers, the operation and set-up of bidwells, water blasters of all sizes and their clutches, hydraulic jacks where used for hoisting, operation of log skidders, iceolators used on and off of pipeline, condor cranes, bow boats, survey boats, bobcats and all their attachments, skid steer loaders and all their attachments, creter cranes, batch plants, operator (all sizes), self propelled roto mills, operation of conveyor systems of any size and any configuration, operation, repair and service of all vibratory hammers, all power pacs and their controls regardless of location, curtains or brush burning machines, stump cutter machines, Nail launchers when mounted on a machine or self-propelled, operation of con-cover machines, and all Operators (except those listed below).

GROUP II. Assistant Operators.

GROUP III. Air Compressors (One), Water Pumps, regardless of Size (One), Waterblasters (one), Welding Machine (One), Mixers (One Bag), Conveyor (One), Siphon or Jet (One), Light Plant (One), Heater (One), Immobile Track Air (One), and Self Propelled Walk-Behind Rollers.

GROUP IV. Asphalt Spreader Oilers, Fireman on Whirlies and Heavy Equipment Oilers, Truck Cranes, Dredges, Monigans, Large Cranes - (Over 65-ton rated capacity) Concrete Plant Oiler, Blacktop Plant Oiler, and Creter Crane Oiler (when required).

GROUP V. Oiler.

GROUP VI. Operators on equipment with Booms, including jibs, 100 feet and over, and less than 150 feet long.

GROUP VII. Operators on equipment with Booms, including jibs, 150 feet and over, and less than 200 feet long.

GROUP VIII. Operators on Equipment with Booms, including jibs, 200 feet and over; Tower Cranes; and Whirlie Cranes.

GROUP IX. Mechanic

TRUCK DRIVER - BUILDING, HEAVY AND HIGHWAY CONSTRUCTION

Class 1. Drivers on 2 axle trucks hauling less than 9 ton. Air compressor and welding machines and brooms, including those pulled by separate units, truck driver helpers, warehouse employees, mechanic helpers, greasers and tiremen, pickup trucks when hauling materials, tools, or workers to and from and on-the-job site, and fork lifts up to 6,000 lb. capacity.

Class 2. Two or three axle trucks hauling more than 9 ton but hauling less than 16 ton. A-frame winch trucks, hydrolift trucks, vactor trucks or similar equipment when used for transportation purposes. Fork lifts over 6,000 lb. capacity, winch trucks, four axle combination units, and ticket writers.

Class 3. Two, three or four axle trucks hauling 16 ton or more. Drivers on water pulls, articulated dump trucks, mechanics and working forepersons, and dispatchers. Five axle or more combination units.

Class 4. Low Boy and Oil Distributors.

Class 5. Drivers who require special protective clothing while employed on hazardous waste work.

TRUCK DRIVER - O & C (Oil and Chip Resealing ONLY)

It involves driving of contractor or subcontractor owned, leased, or hired pickup, dump, service, or oil distributor trucks. Includes transporting materials and equipment (including, but not limited to oils, aggregate supplies, parts, machinery and tools) to or from the job site; distributing oil or liquid asphalt and aggregate; stock piling material; and maintaining trucks at job site related to oil and chip resealing.

Class 1. Distributors, liquid asphalt hauling and hauling of asphalt rubber-tired rollers.

Class 2. Stockpiling.

Class 3. Tandem hauling to job site.

OPERATING ENGINEER - O & C (Oil and Chip Resealing ONLY). Includes the operation of all motorized heavy equipment used in oil and chip resealing, including but not limited to operating self-propelled chip spreaders, and all types of rollers (both hard and rubber tired); and other duties pertaining to the operation or maintenance of heavy equipment related to oil and chip resealing.

Class 1. See Class 1 above for types of equipment operated.

Class 2. See Class 2 above for types of equipment operated.

Class 3. See Class 3 above for types of equipment operated.

Class 4. See Class 4 above for types of equipment operated.

Class 5. See Class 5 above for types of equipment operated.

Other Classifications of Work:

For definitions of classifications not otherwise set out, the Department generally has on file such definitions which are available. If a task to be performed is not subject to one of the classifications of pay set out, the Department will upon being contacted state which neighboring county has such a classification and provide such rate, such rate being deemed to exist by reference in this document. If no neighboring county rate applies to the task, the Department shall undertake a special determination, such special determination being then deemed to have existed under this determination. If a project requires these, or any classification not listed, please contact IDOL at 217-782-1710 for wage rates or clarifications.

LANDSCAPING

Landscaping work falls under the existing classifications for laborer, operating engineer and truck driver. The work performed by landscape plantsman and landscape laborer is covered by the existing classification of laborer. The work performed by landscape operators (regardless of equipment used or its size) is covered by the classifications of operating engineer. The work performed by landscape truck drivers (regardless of size of truck driven) is covered by the classifications of truck driver.

Piatt County Prevailing Wage for May 2013

(See explanation of column headings at bottom of wages)

Trade Name	RG	TYP	C	Base	FRMAN	M-F>8	OSA	OSH	H/W	Pensn	Vac	Trng
=====	==	===	=	=====	=====	=====	===	===	=====	=====	=====	=====
ASBESTOS ABT-GEN		BLD		30.630	31.880	1.5	1.5	2.0	5.750	9.790	0.000	0.900
ASBESTOS ABT-MEC		BLD		29.860	30.860	1.5	1.5	2.0	6.950	3.000	0.000	0.000
BOILERMAKER		BLD		31.500	34.000	1.5	1.5	2.0	7.070	18.73	1.000	0.350
BRICK MASON		BLD		30.670	32.170	1.5	1.5	2.0	6.600	10.03	0.000	0.630
CARPENTER		BLD		28.940	31.190	1.5	1.5	2.0	7.450	13.31	0.000	0.520
CARPENTER		HWY		29.290	31.040	1.5	1.5	2.0	7.450	13.31	0.000	0.520
CEMENT MASON		BLD		29.800	31.300	1.5	1.5	2.0	6.600	8.360	0.000	0.500
CEMENT MASON		HWY		30.390	31.890	1.5	1.5	2.0	6.600	8.560	0.000	0.500
CERAMIC TILE FNSHER		BLD		28.400	0.000	1.5	1.5	2.0	6.600	7.930	0.000	0.000
ELECTRIC PWR EQMT OP		ALL		35.440	0.000	1.5	1.5	2.0	5.000	10.98	0.000	0.270
ELECTRIC PWR GRNDMAN		ALL		24.320	0.000	1.5	1.5	2.0	5.000	7.540	0.000	0.180
ELECTRIC PWR LINEMAN		ALL		39.370	41.910	1.5	1.5	2.0	5.000	12.20	0.000	0.300
ELECTRIC PWR TRK DRV		ALL		25.510	0.000	1.5	1.5	2.0	5.000	7.920	0.000	0.190
ELECTRICIAN	NE	BLD		37.090	39.090	1.5	1.5	2.0	5.350	7.760	0.000	0.560
ELECTRICIAN	SW	BLD		34.200	37.620	1.5	1.5	2.0	5.350	7.610	0.000	0.510
ELECTRONIC SYS TECH		BLD		31.130	32.880	1.5	1.5	2.0	5.350	6.110	0.000	0.400
ELEVATOR CONSTRUCTOR		BLD		40.520	45.585	2.0	2.0	2.0	11.88	12.71	3.240	0.600
FENCE ERECTOR		ALL		30.610	32.510	1.5	1.5	2.0	8.840	8.420	0.000	0.900
GLAZIER		BLD		30.780	32.780	1.5	2.0	2.0	6.630	8.150	0.000	0.380
HT/FROST INSULATOR		BLD		37.260	38.260	1.5	1.5	2.0	7.850	11.16	0.000	0.500
IRON WORKER		ALL		30.610	32.510	1.5	1.5	2.0	8.840	8.420	0.000	0.900
LABORER		BLD		28.630	29.880	1.5	1.5	2.0	5.750	9.790	0.000	0.800
LABORER		HWY		29.650	30.650	1.5	1.5	2.0	5.750	9.790	0.000	0.800
LATHER		BLD		28.940	31.190	1.5	1.5	2.0	7.450	13.31	0.000	0.520
MACHINIST		BLD		43.550	46.050	1.5	1.5	2.0	6.130	8.950	1.850	0.000
MARBLE FINISHERS		BLD		28.400	0.000	1.5	1.5	2.0	6.600	7.930	0.000	0.000
MARBLE MASON		BLD		29.900	0.000	1.5	1.5	2.0	6.600	7.930	0.000	0.000
MILLWRIGHT		BLD		29.620	31.870	1.5	1.5	2.0	7.450	13.09	0.000	0.520
MILLWRIGHT		HWY		31.400	33.150	1.5	1.5	2.0	7.450	13.54	0.000	0.520
OPERATING ENGINEER		BLD	1	33.900	35.400	1.5	1.5	2.0	10.05	7.600	0.000	1.300
OPERATING ENGINEER		BLD	2	31.550	35.400	1.5	1.5	2.0	10.05	7.600	0.000	1.300
OPERATING ENGINEER		BLD	3	27.950	35.400	1.5	1.5	2.0	10.05	7.600	0.000	1.300
OPERATING ENGINEER		BLD	4	35.400	35.400	1.5	1.5	2.0	10.05	7.600	0.000	1.300
OPERATING ENGINEER		HWY	1	37.600	39.100	1.5	1.5	2.0	10.05	8.100	0.000	1.300
OPERATING ENGINEER		HWY	2	33.660	39.100	1.5	1.5	2.0	10.05	8.100	0.000	1.300
OPERATING ENGINEER		HWY	3	27.630	39.100	1.5	1.5	2.0	10.05	8.100	0.000	1.300
OPERATING ENGINEER		HWY	4	39.100	39.100	1.5	1.5	2.0	10.05	8.100	0.000	1.300
PAINTER		ALL		28.250	29.750	1.5	1.5	2.0	5.750	9.420	0.000	0.650
PAINTER OVER 30FT		ALL		28.500	30.000	1.5	1.5	2.0	5.750	9.420	0.000	0.650
PAINTER PWR EQMT		ALL		29.250	30.750	1.5	1.5	2.0	5.750	9.420	0.000	0.650
PILEDRIIVER		BLD		29.440	31.690	1.5	1.5	2.0	7.450	13.31	0.000	0.520
PILEDRIIVER		HWY		30.290	32.040	1.5	1.5	2.0	7.450	13.31	0.000	0.520
PIPEFITTER	E	BLD		37.680	40.180	1.5	1.5	2.0	7.000	10.61	0.000	0.980
PIPEFITTER	W	BLD		36.050	39.050	1.5	1.5	2.0	7.000	7.650	0.000	1.220
PLASTERER		BLD		30.000	32.000	1.5	1.5	2.0	6.600	10.17	0.000	0.500
PLUMBER	E	BLD		37.680	40.180	1.5	1.5	2.0	7.000	10.61	0.000	0.980
PLUMBER	W	BLD		36.050	39.050	1.5	1.5	2.0	7.000	7.650	0.000	1.220
ROOFER		BLD		28.750	30.250	1.5	1.5	2.0	9.150	8.400	0.000	0.200
SHEETMETAL WORKER		BLD		33.640	35.640	1.5	1.5	2.0	8.300	12.00	0.000	0.520
SPRINKLER FITTER		BLD		36.390	39.140	1.5	1.5	2.0	8.420	8.500	0.000	0.450
STONE MASON		BLD		30.670	32.170	1.5	1.5	2.0	6.600	10.03	0.000	0.630
TERRAZZO FINISHER		BLD		28.400	0.000	1.5	1.5	2.0	6.600	7.930	0.000	0.000
TERRAZZO MASON		BLD		29.900	0.000	1.5	1.5	2.0	6.600	7.930	0.000	0.000
TILE MASON		BLD		29.900	0.000	1.5	1.5	2.0	6.600	7.930	0.000	0.000
TRUCK DRIVER	NE	ALL	1	31.230	0.000	1.5	1.5	2.0	10.30	4.840	0.000	0.250
TRUCK DRIVER	NE	ALL	2	31.680	0.000	1.5	1.5	2.0	10.30	4.840	0.000	0.250
TRUCK DRIVER	NE	ALL	3	31.890	0.000	1.5	1.5	2.0	10.30	4.840	0.000	0.250
TRUCK DRIVER	NE	ALL	4	32.180	0.000	1.5	1.5	2.0	10.30	4.840	0.000	0.250
TRUCK DRIVER	NE	ALL	5	33.020	0.000	1.5	1.5	2.0	10.30	4.840	0.000	0.250

TRUCK DRIVER	NE O&C 1	24.980	0.000	1.5	1.5	2.0	10.30	4.840	0.000	0.250
TRUCK DRIVER	NE O&C 2	25.340	0.000	1.5	1.5	2.0	10.30	4.840	0.000	0.250
TRUCK DRIVER	NE O&C 3	25.510	0.000	1.5	1.5	2.0	10.30	4.840	0.000	0.250
TRUCK DRIVER	NE O&C 4	25.740	0.000	1.5	1.5	2.0	10.30	4.840	0.000	0.250
TRUCK DRIVER	NE O&C 5	26.420	0.000	1.5	1.5	2.0	10.30	4.840	0.000	0.250
TRUCK DRIVER	SW ALL 1	31.340	0.000	1.5	1.5	2.0	10.30	5.010	0.000	0.250
TRUCK DRIVER	SW ALL 2	31.780	0.000	1.5	1.5	2.0	10.30	5.010	0.000	0.250
TRUCK DRIVER	SW ALL 3	32.020	0.000	1.5	1.5	2.0	10.30	5.010	0.000	0.250
TRUCK DRIVER	SW ALL 4	32.280	0.000	1.5	1.5	2.0	10.30	5.010	0.000	0.250
TRUCK DRIVER	SW ALL 5	33.130	0.000	1.5	1.5	2.0	10.30	5.010	0.000	0.250
TRUCK DRIVER	SW O&C 1	25.070	0.000	1.5	1.5	2.0	10.30	5.010	0.000	0.250
TRUCK DRIVER	SW O&C 2	25.420	0.000	1.5	1.5	2.0	10.30	5.010	0.000	0.250
TRUCK DRIVER	SW O&C 3	25.620	0.000	1.5	1.5	2.0	10.30	5.010	0.000	0.250
TRUCK DRIVER	SW O&C 4	25.820	0.000	1.5	1.5	2.0	10.30	5.010	0.000	0.250
TRUCK DRIVER	SW O&C 5	26.500	0.000	1.5	1.5	2.0	10.30	5.010	0.000	0.250
TUCKPOINTER	BLD	30.670	32.170	1.5	1.5	2.0	6.600	10.03	0.000	0.630

Legend :

RG (Region)

TYP (Trade Type - All,Highway,Building,Floating,Oil & Chip,Rivers)

C (Class)

Base (Base Wage Rate)

FRMAN (Foreman Rate)

M-F>8 (OT required for any hour greater than 8 worked each day, Mon through Fri.

OSA (Overtime (OT) is required for every hour worked on Saturday)

OSH (Overtime is required for every hour worked on Sunday and Holidays)

H/W (Health & Welfare Insurance)

Pensn (Pension)

Vac (Vacation)

Trng (Training)

Explanations

PIATT COUNTY

ASBESTOS - SEE LABORERS

CARPENTERS (SOUTHWEST) - Commencing at the southeastern corner where Piatt County line meets the Douglas and Moultrie county lines, proceeding north on Piatt County line to County Road 1475 East, then proceeding north to County Road 500 North, then north to County Road 525 North and then west to County Road 1425 East and then north and west to County Road 1400 East and proceeding north to County Road 1000 North, then proceeding west to County Road 500 East, then north to County Road 1300 North, then west to County Road 300 East, then proceeding north to Old Highway 48 and then west to Old Route 48 to the Piatt County Line.

ELECTRICIANS (NORTHEAST) - Townships of Blue Ridge, Sangamon and Monticello (Northeast quadrant).

PLUMBERS & PIPEFITTERS (EAST) - That part of the county East of an extension of Rt. 105 from the Northern to the Southern boundary of the county.

TRUCK DRIVERS (NORTHEAST) - East of a line starting at the intersection of the DeWitt-Piatt Counties line and Route 10 in a southerasterly direction to the southeast corner of Piatt County.

The following list is considered as those days for which holiday rates of wages for work performed apply: New Years Day, Memorial Day, Fourth of July, Labor Day, Thanksgiving Day, Christmas Day and Veterans Day in some classifications/counties. Generally, any of these holidays which fall on a Sunday is celebrated on the following Monday. This then makes work performed on that Monday payable at the appropriate overtime rate for holiday pay. Common practice in a given local may alter certain days of celebration. If in doubt, please check with IDOL.

Oil and chip resealing (O&C) means the application of road oils and liquid asphalt to coat an existing road surface, followed by application of aggregate chips or gravel to coated surface, and subsequent rolling of material to seal the surface.

EXPLANATION OF CLASSES

ASBESTOS - GENERAL - removal of asbestos material/mold and hazardous materials from any place in a building, including mechanical systems where those mechanical systems are to be removed. This includes the removal of asbestos materials/mold and hazardous materials from ductwork or pipes in a building when the building is to be demolished at the time or at some close future date.

ASBESTOS - MECHANICAL - removal of asbestos material from mechanical systems, such as pipes, ducts, and boilers, where the mechanical systems are to remain.

CERAMIC TILE FINISHER, MARBLE FINISHER, TERRAZZO FINISHER

Assisting, helping or supporting the tile, marble and terrazzo mechanic by performing their historic and traditional work assignments required to complete the proper installation of the work covered by said crafts. The term "Ceramic" is used for naming the classification only and is in no way a limitation of the product handled. Ceramic takes into consideration most hard tiles.

ELECTRONIC SYSTEMS TECHNICIAN

Installation, service and maintenance of low-voltage systems which utilizes the transmission and/or transference of voice, sound, vision, or digital for commercial, education, security and entertainment purposes for the following: TV monitoring and surveillance, background/foreground music, intercom and telephone interconnect, field programming, inventory control systems, microwave transmission, multi-media, multiplex, radio page, school, intercom and sound burglar alarms and low voltage master clock systems.

Excluded from this classification are energy management systems, life safety systems, supervisory controls and data acquisition systems not intrinsic with the above listed systems, fire alarm systems, nurse call systems and raceways exceeding fifteen feet in length.

TRUCK DRIVER - BUILDING, HEAVY AND HIGHWAY CONSTRUCTION

Class 1. Drivers on 2 axle trucks hauling less than 9 ton. Air compressor and welding machines and brooms, including those pulled by

separate units, truck driver helpers, warehouse employees, mechanic helpers, greasers and tiremen, pickup trucks when hauling materials, tools, or workers to and from and on-the-job site, and fork lifts up to 6,000 lb. capacity.

Class 2. Two or three axle trucks hauling more than 9 ton but hauling less than 16 ton. A-frame winch trucks, hydrolift trucks, vactor trucks or similar equipment when used for transportation purposes. Fork lifts over 6,000 lb. capacity, winch trucks, four axle combination units, and ticket writers.

Class 3. Two, three or four axle trucks hauling 16 ton or more. Drivers on water pulls, articulated dump trucks, mechanics and working forepersons, and dispatchers. Five axle or more combination units.

Class 4. Low Boy and Oil Distributors.

Class 5. Drivers who require special protective clothing while employed on hazardous waste work.

TRUCK DRIVER - OIL AND CHIP RESEALING ONLY.

This shall encompass laborers, workers and mechanics who drive contractor or subcontractor owned, leased, or hired pickup, dump, service, or oil distributor trucks. The work includes transporting materials and equipment (including but not limited to, oils, aggregate supplies, parts, machinery and tools) to or from the job site; distributing oil or liquid asphalt and aggregate; stock piling material when in connection with the actual oil and chip contract. The Truck Driver (Oil & Chip Resealing) wage classification does not include supplier delivered materials.

OPERATING ENGINEERS - BUILDING

CLASS 1. Asphalt Screed Man; Aspco Concrete Spreaders; Asphalt Pavers; Asphalt Plant Engineer; Asphalt Rollers on Bituminous Concrete; Athey Loaders; Backfillers, Crane Type; Backhoes; Barber Green Loaders; Bulldozers; Cableways; Cherry Pickers; Clam Shells; C.M.I. & similar type autograde formless paver, autograde placer & finisher; Concrete Breakers; Concrete Pumps; Derricks; Derrick Boats; Draglines; Earth Auger or Boring Machines; Elevating Graders; Engineers on Dredges; Gravel Processing Machines; Head Equipment Greaser; High Lifts or Fork Lifts; Hoists with two or more drums or two or more load lines; Locomotives, All; Mechanics; Motor Graders or Auto Patrols; Operators or Leverman on Dredges; Operators, Power Boat; Operators, Pug Mill (Asphalt Plants); Orange Peels; Overhead Cranes; Paving Mixers; Piledrivers; Pipe Wrapping and Painting Machines; Pushdozers, or Push Cats; Robotic Controlled Equipment in this Classification; Rock Crushers; Ross Carrier or Similar Machines; Rotomill; Scoops, Skimmer, two cu. yd. capacity and under; Scoops, All or Tournapull; Sheep-Foot Roller (Self Propelled); Shovels; Skid Steer; Skimmer Scoops; Temporary Concrete Plant Operators; Test Hole Drilling Machines; Tower Machines; Tower Mixers; Track Type End Loaders; Track Type Fork Lifts or High Lifts; Track Jacks and Tampers; Tractors, Sideboom; Trenching or Ditching Machine; Tunnelluggers; Vermeer Type Saws; Water Blaster Cutting Head; Wheel Type End Loaders; Winch Cat.

CLASS 2. Air Compressors (six to eight)*; Asphalt Boosters and Heaters; Asphalt Distributors; Asphalt Plant Fireman; Oiler on Two Paving Mixers When Used in Tandem; Boom or Winch Trucks; Bull Floats or Flexplanes; Concrete Finishing Machine; Concrete Saws, Self-Propelled; Concrete Spreading Machines; Conveyors (six to eight)*; Generators (six to eight)*; Gravel or Stone Spreader, Power

Operated; Hoist (with One Drum and One Load Line); Light Plants (six to eight)*; Mechanical Heaters (six to eight)*; Mud Jacks; Post Hole Digger, Mechanical; Pug Mills when used for other than Asphalt operation; Robotic Controlled Equipment in this Classification; Road or Street Sweeper, Self Propelled; Rollers (except bituminous concrete); Seaman Tiller; Straw Machine; Vibratory Compactor; Water Blaster, Power Unit; Welding Machines (six to eight)*; Well Drill Machines.

CLASS 3. Air Compressors(one to five)*; Air Compressors, Track or Self-Propelled; Automatic Hoist; Building Elevators; Bulk Cement Batching Plants; Conveyors (one to five)*; Concrete Mixers (Except Plant, Paver, or Tower); Firemen; Generators (one to five)*; Greasers; Helper on Single Paving Mixer; Hoist, Automatic; Light Plants (one to five)*; Mechanic Helpers; Mechanical Heaters (one to five)*; Oilers; Power Form Graders; Power Sub-Graders; Robotic Controlled Equipment in this Classification; Scissors Hoist; Tractors without power attachments regardless of size or type; Truck Crane Oiler and Driver (1 man); Vibratory Hammer (power source); Water Pumps (one to five)*; Welding Machines (1/300 Amp. or over)*; Welding machines (one to five)*

CLASS 4. Lattice Boom Crawler Cranes; Lattice Boom Truck Cranes; Telescopic Truck-Mounted Cranes; Tower Cranes.

* Combinations of one to eight of any Air Compressors, Conveyors, Welding Machines, Water Pumps, Light Plants, or Generators shall be in batteries or within 400 feet and shall be paid as per the Classification Schedule contained in this Article.

OPERATING ENGINEERS - HIGHWAY

CLASS 1. Asphalt Screed Man; Asphco Concrete Spreaders; Asphalt Pavers; Asphalt Plant Engineer; Asphalt Rollers on Bituminous Concrete; Athey Loaders; Backhoes; Barber Green Loaders; Bulldozers; Cableways; Carry Deck Pickers; Cherry Pickers (Rough Terrain); C.M.I. & similar type-autograde formless paver, autograde placer & finisher; Concrete Breakers; Concrete Plant Operators; Concrete Pumps; Derricks; Derrick Boats; Dewatering Systems; Earth Auger or Boring Machines; Elevating Graders; Engineers on Dredges; Gravel Processing Machines; Grout Pump; Head Equipment Greaser; High Lifts or Fork Lifts; Hoists with two or more drums or two or more load lines; Hydro Jet or Hydro Laser; Locomotives, All; Mechanics; Motor Graders or Auto Patrols; Multi-Point Power Lifting Equipment; Operators or Leverman on Dredges; Operators, Power Boat; Operators, Pug Mill (Asphalt Plants); Overhead Cranes; Paving Mixers; Piledrivers; Pipe Wrapping and Painting Machines; Push-dozers, or Push Cats; Robotic Controlled Equipment in this Classification; Rock Crushers; Ross Carrier or Similar Machines; Roto-Mill; Scoops, Skimmer, two cu. yd. capacity and under; Sheep-Foot Roller (Self Pro-pelled); Shovels; Skid Steer; Skimmer Scoops; Test Hole Drilling Machines; Tower Machines; Tower Mixers; Track Type End Loaders; Track Type Fork Lifts or High Lifts; Track Jacks and Tampers; Tractors, Side-boom; Trenching or Ditching Machine; Tunnelluggers; Vermeer-Type Saws; Wheel Type End Loaders; Winch Cat; Scoops, All or Tournapull.

CLASS 2. Air Compressors (six to eight)*; Articulated Dumps; Asphalt Boosters and Heaters; Asphalt Distributors; Asphalt Plant Fireman; Boom or Winch Trucks; Building Elevators; Bull Floats or Flexplanes; Concrete Finishing Machine; Concrete Saws, Self-Propelled; Concrete Spreading Machines; Conveyors (six to eight)*; Generators (six to eight)*; Gravel or Stone Spreader, Power Operated; Hoist, Automatic; Hoist with One Drum and One Load Line; Light Plants (six to eight)*; Mechanical Heaters (six to eight)*; Mud Jacks; Off Road Water Wagons;

Oiler on Two Paving Mixers When Used in Tandem; Post Hole Digger, Mechanical; Robotic Controlled Equipment in This Classification; Road or Street Sweeper, Self-Propelled; Rollers (except bituminous concrete); Scissor Hoist; Sea-man Tiller; Straw Machine; Vibratory Compactor; Water Pumps (six to eight)*; Well Drill Machines.

CLASS 3. Air Compressors (one to five)*; Air Compressors, Track or Self-Propelled; Bulk Cement Batching Plants; Conveyors (one to five)*; Concrete Mixers (Except Plant, Paver, or Tower); Firemen; Generators (one to five)*; Greasers; Helper on Single Paving Mixer; Light Plants (one to five)*; Mechanical Helpers; Mechanical Heaters (one to five)*; Oilers; Power Form Graders; Power Sub-Graders; Pug Mills when used for other than Asphalt operation; Robotic Controlled Equipment in This Classification; Tractors without power attachments, regardless of size or type; Truck Crane Oiler and Driver (1 man); Vibratory Hammer (power source); Water Pumps (one to five)*; Welding Machines (one 300 Amp. or over)*; Welding Machines (one to five)*.

CLASS 4. Lattice Boom Crawler Crane; Lattice Boom Truck Crane; Telescopic Truck-Mounted Crane; Tower Crane.

*Combinations of one to eight of any Air Compressors, Conveyors, Welding Machines, Water Pumps, Light Plants or Generators shall be in batteries or within 400 feet and shall be paid as per the Classification Schedule contained in this Article.

Other Classifications of Work:

For definitions of classifications not otherwise set out, the Department generally has on file such definitions which are available. If a task to be performed is not subject to one of the classifications of pay set out, the Department will upon being contacted state which neighboring county has such a classification and provide such rate, such rate being deemed to exist by reference in this document. If no neighboring county rate applies to the task, the Department shall undertake a special determination, such special determination being then deemed to have existed under this determination. If a project requires these, or any classification not listed, please contact IDOL at 217-782-1710 for wage rates or clarifications.

LANDSCAPING

Landscaping work falls under the existing classifications for laborer, operating engineer and truck driver. The work performed by landscape plantsman and landscape laborer is covered by the existing classification of laborer. The work performed by landscape operators (regardless of equipment used or its size) is covered by the classifications of operating engineer. The work performed by landscape truck drivers (regardless of size of truck driven) is covered by the classifications of truck driver.

Pike County Prevailing Wage for May 2013

(See explanation of column headings at bottom of wages)

Trade Name	RG	TYP	C	Base	FRMAN	M-F>8	OSA	OSH	H/W	Pensn	Vac	Trng
=====	==	===	=	=====	=====	=====	===	===	=====	=====	=====	=====
ASBESTOS ABT-GEN		BLD		25.250	26.250	1.5	1.5	2.0	7.550	10.08	0.000	0.800
ASBESTOS ABT-MEC		BLD		29.860	30.860	1.5	1.5	2.0	6.950	3.000	0.000	0.000
BOILERMAKER		BLD		31.500	34.000	1.5	1.5	2.0	7.070	18.73	1.000	0.350
BRICK MASON		BLD		29.250	30.250	1.5	1.5	2.0	8.200	8.330	0.000	0.580
CARPENTER		BLD		27.670	29.920	1.5	1.5	2.0	7.450	14.58	0.000	0.520
CARPENTER		HWY		28.870	30.620	1.5	1.5	2.0	7.450	13.73	0.000	0.520

CEMENT MASON	BLD	25.200	26.700	1.5	1.5	2.0	6.600	12.10	0.000	0.500
CEMENT MASON	HWY	24.850	25.850	1.5	1.5	2.0	6.600	11.85	0.000	0.500
CERAMIC TILE FNSHER	BLD	25.600	0.000	1.5	1.5	2.0	8.200	7.230	0.000	0.000
ELECTRIC PWR EQMT OP	ALL	35.440	0.000	1.5	1.5	2.0	5.000	10.98	0.000	0.270
ELECTRIC PWR GRNDMAN	ALL	24.320	0.000	1.5	1.5	2.0	5.000	7.540	0.000	0.180
ELECTRIC PWR LINEMAN	ALL	39.370	41.910	1.5	1.5	2.0	5.000	12.20	0.000	0.300
ELECTRIC PWR TRK DRV	ALL	25.510	0.000	1.5	1.5	2.0	5.000	7.920	0.000	0.190
ELECTRICIAN	BLD	28.360	30.860	1.5	1.5	2.0	5.350	8.550	0.000	0.400
ELECTRONIC SYS TECH	BLD	27.430	29.180	1.5	1.5	2.0	5.350	9.320	0.000	0.400
ELEVATOR CONSTRUCTOR	BLD	40.520	45.585	2.0	2.0	2.0	11.88	12.71	3.240	0.600
GLAZIER	BLD	30.780	32.780	1.5	2.0	2.0	6.630	8.150	0.000	0.380
HT/FROST INSULATOR	BLD	37.260	38.260	1.5	1.5	2.0	7.850	11.16	0.000	0.500
IRON WORKER	BLD	29.460	31.460	1.5	1.5	2.0	7.740	11.38	0.000	0.660
IRON WORKER	HWY	30.600	32.100	1.5	1.5	2.0	7.740	11.69	0.000	0.660
LABORER	BLD	23.750	24.750	1.5	1.5	2.0	7.550	10.08	0.000	0.800
LABORER	HWY	24.910	25.910	1.5	1.5	2.0	7.550	10.63	0.000	0.800
LATHER	BLD	27.670	29.920	1.5	1.5	2.0	7.450	14.58	0.000	0.520
MACHINIST	BLD	43.550	46.050	1.5	1.5	2.0	6.130	8.950	1.850	0.000
MARBLE FINISHERS	BLD	25.600	0.000	1.5	1.5	2.0	8.200	7.230	0.000	0.000
MARBLE MASON	BLD	27.100	27.850	1.5	1.5	2.0	8.200	7.230	0.000	0.000
MILLWRIGHT	BLD	29.620	31.870	1.5	1.5	2.0	7.450	13.09	0.000	0.520
MILLWRIGHT	HWY	31.690	33.440	1.5	1.5	2.0	7.450	13.54	0.000	0.520
OPERATING ENGINEER	BLD 1	33.900	35.400	1.5	1.5	2.0	10.05	7.600	0.000	1.300
OPERATING ENGINEER	BLD 2	31.550	35.400	1.5	1.5	2.0	10.05	7.600	0.000	1.300
OPERATING ENGINEER	BLD 3	27.950	35.400	1.5	1.5	2.0	10.05	7.600	0.000	1.300
OPERATING ENGINEER	BLD 4	35.400	35.400	1.5	1.5	2.0	10.05	7.600	0.000	1.300
OPERATING ENGINEER	HWY 1	37.600	39.100	1.5	1.5	2.0	10.05	8.100	0.000	1.300
OPERATING ENGINEER	HWY 2	33.660	39.100	1.5	1.5	2.0	10.05	8.100	0.000	1.300
OPERATING ENGINEER	HWY 3	27.630	39.100	1.5	1.5	2.0	10.05	8.100	0.000	1.300
OPERATING ENGINEER	HWY 4	39.100	39.100	1.5	1.5	2.0	10.05	8.100	0.000	1.300
PAINTER	BLD	29.250	30.750	1.5	1.5	2.0	5.000	7.920	0.000	0.600
PAINTER	HWY	30.450	31.950	1.5	1.5	2.0	5.000	7.920	0.000	0.600
PAINTER OVER 30FT	BLD	30.250	31.750	1.5	1.5	2.0	5.000	7.920	0.000	0.600
PAINTER PWR EQMT	BLD	30.250	31.750	1.5	1.5	2.0	5.000	7.920	0.000	0.600
PAINTER PWR EQMT	HWY	31.450	32.950	1.5	1.5	2.0	5.000	7.920	0.000	0.600
PILEDRIVER	BLD	28.170	30.420	1.5	1.5	2.0	7.450	14.58	0.000	0.520
PILEDRIVER	HWY	29.870	31.620	1.5	1.5	2.0	7.450	13.73	0.000	0.520
PIPEFITTER	BLD	40.020	44.020	1.5	1.5	2.0	7.000	7.750	0.000	0.900
PLASTERER	BLD	28.500	30.250	1.5	1.5	2.0	7.330	11.29	0.000	0.500
PLUMBER	BLD	40.020	44.020	1.5	1.5	2.0	7.000	7.750	0.000	0.900
ROOFER	BLD	28.580	30.010	1.5	1.5	2.0	8.450	7.220	0.000	0.250
SHEETMETAL WORKER	BLD	26.150	27.950	1.5	1.5	2.0	7.140	9.340	0.000	0.540
SPRINKLER FITTER	BLD	36.390	39.140	1.5	1.5	2.0	8.420	8.500	0.000	0.450
STONE MASON	BLD	29.250	30.250	1.5	1.5	2.0	8.200	8.330	0.000	0.580
TERRAZZO FINISHER	BLD	25.600	0.000	1.5	1.5	2.0	8.200	7.230	0.000	0.000
TERRAZZO MASON	BLD	27.100	27.850	1.5	1.5	2.0	8.200	7.230	0.000	0.000
TILE MASON	BLD	27.100	27.850	1.5	1.5	2.0	8.200	7.230	0.000	0.000
TRUCK DRIVER	ALL 1	31.340	0.000	1.5	1.5	2.0	10.30	5.010	0.000	0.250
TRUCK DRIVER	ALL 2	31.780	0.000	1.5	1.5	2.0	10.30	5.010	0.000	0.250
TRUCK DRIVER	ALL 3	32.020	0.000	1.5	1.5	2.0	10.30	5.010	0.000	0.250
TRUCK DRIVER	ALL 4	32.280	0.000	1.5	1.5	2.0	10.30	5.010	0.000	0.250
TRUCK DRIVER	ALL 5	33.130	0.000	1.5	1.5	2.0	10.30	5.010	0.000	0.250
TRUCK DRIVER	O&C 1	25.070	0.000	1.5	1.5	2.0	10.30	5.010	0.000	0.250
TRUCK DRIVER	O&C 2	25.420	0.000	1.5	1.5	2.0	10.30	5.010	0.000	0.250
TRUCK DRIVER	O&C 3	25.620	0.000	1.5	1.5	2.0	10.30	5.010	0.000	0.250
TRUCK DRIVER	O&C 4	25.820	0.000	1.5	1.5	2.0	10.30	5.010	0.000	0.250
TRUCK DRIVER	O&C 5	26.500	0.000	1.5	1.5	2.0	10.30	5.010	0.000	0.250
TUCKPOINTER	BLD	29.250	30.250	1.5	1.5	2.0	8.200	8.330	0.000	0.580

Legend :

RG (Region)

TYP (Trade Type - All,Highway,Building,Floating,Oil & Chip,Rivers)

C (Class)

Base (Base Wage Rate)

FRMAN (Foreman Rate)

M-F>8 (OT required for any hour greater than 8 worked each day, Mon through Fri.)

OSA (Overtime (OT) is required for every hour worked on Saturday)

OSH (Overtime is required for every hour worked on Sunday and Holidays)

H/W (Health & Welfare Insurance)

Pensn (Pension)

Vac (Vacation)

Trng (Training)

Explanations

PIKE COUNTY

GLAZIERS (SOUTHWEST) - That part of the county Southwest of a diagonal line from Hannibal, MO. through Independence to the county line.

The following list is considered as those days for which holiday rates of wages for work performed apply: New Years Day, Memorial Day, Fourth of July, Labor Day, Thanksgiving Day, Christmas Day and Veterans Day in some classifications/counties. Generally, any of these holidays which fall on a Sunday is celebrated on the following Monday. This then makes work performed on that Monday payable at the appropriate overtime rate for holiday pay. Common practice in a given local may alter certain days of celebration. If in doubt, please check with IDOL.

Oil and chip resealing (O&C) means the application of road oils and liquid asphalt to coat an existing road surface, followed by application of aggregate chips or gravel to coated surface, and subsequent rolling of material to seal the surface.

EXPLANATION OF CLASSES

ASBESTOS - GENERAL - removal of asbestos material/mold and hazardous materials from any place in a building, including mechanical systems where those mechanical systems are to be removed. This includes the removal of asbestos materials/mold and hazardous materials from ductwork or pipes in a building when the building is to be demolished at the time or at some close future date.

ASBESTOS - MECHANICAL - removal of asbestos material from mechanical systems, such as pipes, ducts, and boilers, where the mechanical systems are to remain.

CERAMIC TILE FINISHER, MARBLE FINISHER, TERRAZZO FINISHER

Assisting, helping or supporting the tile, marble and terrazzo mechanic by performing their historic and traditional work assignments required to complete the proper installation of the work covered by said crafts. The term "Ceramic" is used for naming the classification only and is in no way a limitation of the product handled. Ceramic

takes into consideration most hard tiles.

ELECTRONIC SYSTEMS TECHNICIAN

Installation, service and maintenance of low-voltage systems which utilizes the transmission and/or transference of voice, sound, vision, or digital for commercial, education, security and entertainment purposes for the following: TV monitoring and surveillance, background/foreground music, intercom and telephone interconnect, field programming, inventory control systems, microwave transmission, multi-media, multiplex, radio page, school, intercom and sound burglar alarms and low voltage master clock systems.

Excluded from this classification are energy management systems, life safety systems, supervisory controls and data acquisition systems not intrinsic with the above listed systems, fire alarm systems, nurse call systems and raceways exceeding fifteen feet in length.

TRUCK DRIVER - BUILDING, HEAVY AND HIGHWAY CONSTRUCTION

Class 1. Drivers on 2 axle trucks hauling less than 9 ton. Air compressor and welding machines and brooms, including those pulled by separate units, truck driver helpers, warehouse employees, mechanic helpers, greasers and tiremen, pickup trucks when hauling materials, tools, or workers to and from and on-the-job site, and fork lifts up to 6,000 lb. capacity.

Class 2. Two or three axle trucks hauling more than 9 ton but hauling less than 16 ton. A-frame winch trucks, hydrolift trucks, vector trucks or similar equipment when used for transportation purposes. Fork lifts over 6,000 lb. capacity, winch trucks, four axle combination units, and ticket writers.

Class 3. Two, three or four axle trucks hauling 16 ton or more. Drivers on water pulls, articulated dump trucks, mechanics and working forepersons, and dispatchers. Five axle or more combination units.

Class 4. Low Boy and Oil Distributors.

Class 5. Drivers who require special protective clothing while employed on hazardous waste work.

TRUCK DRIVER - OIL AND CHIP RESEALING ONLY.

This shall encompass laborers, workers and mechanics who drive contractor or subcontractor owned, leased, or hired pickup, dump, service, or oil distributor trucks. The work includes transporting materials and equipment (including but not limited to, oils, aggregate supplies, parts, machinery and tools) to or from the job site; distributing oil or liquid asphalt and aggregate; stock piling material when in connection with the actual oil and chip contract. The Truck Driver (Oil & Chip Resealing) wage classification does not include supplier delivered materials.

OPERATING ENGINEERS - BUILDING

CLASS 1. Asphalt Screed Man; Aspco Concrete Spreaders; Asphalt Pavers; Asphalt Plant Engineer; Asphalt Rollers on Bituminous Concrete; Athey Loaders; Backfillers, Crane Type; Backhoes; Barber Green Loaders; Bulldozers; Cableways; Cherry Pickers; Clam Shells; C.M.I. & similar type autograde formless paver, autograde placer & finisher; Concrete Breakers; Concrete Pumps; Derricks; Derrick Boats; Draglines; Earth Auger or Boring Machines; Elevating Graders; Engineers on Dredges; Gravel Processing Machines; Head Equipment Greaser; High Lifts or Fork Lifts; Hoists with two or more drums or two or more load lines; Locomotives, All; Mechanics; Motor Graders or

Auto Patrols; Operators or Leverman on Dredges; Operators, Power Boat; Operators, Pug Mill (Asphalt Plants); Orange Peels; Overhead Cranes; Paving Mixers; Piledrivers; Pipe Wrapping and Painting Machines; Pushdozers, or Push Cats; Robotic Controlled Equipment in this Classification; Rock Crushers; Ross Carrier or Similar Machines; Rotomill; Scoops, Skimmer, two cu. yd. capacity and under; Scoops, All or Tournapull; Sheep-Foot Roller (Self Propelled); Shovels; Skid Steer; Skimmer Scoops; Temporary Concrete Plant Operators; Test Hole Drilling Machines; Tower Machines; Tower Mixers; Track Type End Loaders; Track Type Fork Lifts or High Lifts; Track Jacks and Tampers; Tractors, Sideboom; Trenching or Ditching Machine; Tunnelluggers; Vermeer Type Saws; Water Blaster Cutting Head; Wheel Type End Loaders; Winch Cat.

CLASS 2. Air Compressors (six to eight)*; Asphalt Boosters and Heaters; Asphalt Distributors; Asphalt Plant Fireman; Oiler on Two Paving Mixers When Used in Tandem; Boom or Winch Trucks; Bull Floats or Flexplanes; Concrete Finishing Machine; Concrete Saws, Self-Propelled; Concrete Spreading Machines; Conveyors (six to eight)*; Generators (six to eight)*; Gravel or Stone Spreader, Power Operated; Hoist (with One Drum and One Load Line); Light Plants (six to eight)*; Mechanical Heaters (six to eight)*; Mud Jacks; Post Hole Digger, Mechanical; Pug Mills when used for other than Asphalt operation; Robotic Controlled Equipment in this Classification; Road or Street Sweeper, Self Propelled; Rollers (except bituminous concrete); Seaman Tiller; Straw Machine; Vibratory Compactor; Water Blaster, Power Unit; Welding Machines (six to eight)*; Well Drill Machines.

CLASS 3. Air Compressors(one to five)*; Air Compressors, Track or Self-Propelled; Automatic Hoist; Building Elevators; Bulk Cement Batching Plants; Conveyors (one to five)*; Concrete Mixers (Except Plant, Paver, or Tower); Firemen; Generators (one to five)*; Greasers; Helper on Single Paving Mixer; Hoist, Automatic; Light Plants (one to five)*; Mechanic Helpers; Mechanical Heaters (one to five)*; Oilers; Power Form Graders; Power Sub-Graders; Robotic Controlled Equipment in this Classification; Scissors Hoist; Tractors without power attachments regardless of size or type; Truck Crane Oiler and Driver (1 man); Vibratory Hammer (power source); Water Pumps (one to five)*; Welding Machines (1/300 Amp. or over)*; Welding machines (one to five)*

CLASS 4. Lattice Boom Crawler Cranes; Lattice Boom Truck Cranes; Telescopic Truck-Mounted Cranes; Tower Cranes.

* Combinations of one to eight of any Air Compressors, Conveyors, Welding Machines, Water Pumps, Light Plants, or Generators shall be in batteries or within 400 feet and shall be paid as per the Classification Schedule contained in this Article.

OPERATING ENGINEERS - HIGHWAY

CLASS 1. Asphalt Screed Man; Asphco Concrete Spreaders; Asphalt Pavers; Asphalt Plant Engineer; Asphalt Rollers on Bituminous Concrete; Athey Loaders; Backhoes; Barber Green Loaders; Bulldozers; Cableways; Carry Deck Pickers; Cherry Pickers (Rough Terrain); C.M.I. & similar type-autograde formless paver, autograde placer & finisher; Concrete Breakers; Concrete Plant Operators; Concrete Pumps; Derricks; Derrick Boats; Dewatering Systems; Earth Auger or Boring Machines; Elevating Graders; Engineers on Dredges; Gravel Processing Machines; Grout Pump; Head Equipment Greaser; High Lifts or Fork Lifts; Hoists with two or more drums or two or more load lines; Hydro Jet or Hydro Laser; Locomotives, All; Mechanics; Motor Graders or Auto Patrols; Multi-Point Power Lifting Equipment; Operators or Leverman on Dredges;

Operators, Power Boat; Operators, Pug Mill (Asphalt Plants); Overhead Cranes; Paving Mixers; Piledrivers; Pipe Wrapping and Painting Machines; Push-dozers, or Push Cats; Robotic Controlled Equipment in this Classification; Rock Crushers; Ross Carrier or Similar Machines; Roto-Mill; Scoops, Skimmer, two cu. yd. capacity and under; Sheep-Foot Roller (Self Pro-pelled); Shovels; Skid Steer; Skimmer Scoops; Test Hole Drilling Machines; Tower Machines; Tower Mixers; Track Type End Loaders; Track Type Fork Lifts or High Lifts; Track Jacks and Tampers; Tractors, Side-boom; Trenching or Ditching Machine; Tunnelluggers; Vermeer-Type Saws; Wheel Type End Loaders; Winch Cat; Scoops, All or Tournapull.

CLASS 2. Air Compressors (six to eight)*; Articulated Dumps; Asphalt Boosters and Heaters; Asphalt Distributors; Asphalt Plant Fireman; Boom or Winch Trucks; Building Elevators; Bull Floats or Flexplanes; Concrete Finishing Machine; Concrete Saws, Self-Propelled; Concrete Spreading Machines; Conveyors (six to eight)*; Generators (six to eight)*; Gravel or Stone Spreader, Power Operated; Hoist, Automatic; Hoist with One Drum and One Load Line; Light Plants (six to eight)*; Mechanical Heaters (six to eight)*; Mud Jacks; Off Road Water Wagons; Oiler on Two Paving Mixers When Used in Tandem; Post Hole Digger, Mechanical; Robotic Controlled Equipment in This Classification; Road or Street Sweeper, Self-Propelled; Rollers (except bituminous concrete); Scissor Hoist; Sea-man Tiller; Straw Machine; Vibratory Compactor; Water Pumps (six to eight)*; Well Drill Machines.

CLASS 3. Air Compressors (one to five)*; Air Compressors, Track or Self-Propelled; Bulk Cement Batching Plants; Conveyors (one to five)*; Concrete Mixers (Except Plant, Paver, or Tower); Firemen; Generators (one to five)*; Greasers; Helper on Single Paving Mixer; Light Plants (one to five)*; Mechanic Helpers; Mechanical Heaters (one to five)*; Oilers; Power Form Graders; Power Sub-Graders; Pug Mills when used for other than Asphalt operation; Robotic Controlled Equipment in This Classification; Tractors without power attachments, regardless of size or type; Truck Crane Oiler and Driver (1 man); Vibratory Hammer (power source); Water Pumps (one to five)*; Welding Machines (one 300 Amp. or over)*; Welding Machines (one to five)*.

CLASS 4. Lattice Boom Crawler Crane; Lattice Boom Truck Crane; Telescopic Truck-Mounted Crane; Tower Crane.

*Combinations of one to eight of any Air Compressors, Conveyors, Welding Machines, Water Pumps, Light Plants or Generators shall be in batteries or within 400 feet and shall be paid as per the Classification Schedule contained in this Article.

Other Classifications of Work:

For definitions of classifications not otherwise set out, the Department generally has on file such definitions which are available. If a task to be performed is not subject to one of the classifications of pay set out, the Department will upon being contacted state which neighboring county has such a classification and provide such rate, such rate being deemed to exist by reference in this document. If no neighboring county rate applies to the task, the Department shall undertake a special determination, such special determination being then deemed to have existed under this determination. If a project requires these, or any classification not listed, please contact IDOL at 217-782-1710 for wage rates or clarifications.

LANDSCAPING

Landscaping work falls under the existing classifications for laborer,

operating engineer and truck driver. The work performed by landscape plantsman and landscape laborer is covered by the existing classification of laborer. The work performed by landscape operators (regardless of equipment used or its size) is covered by the classifications of operating engineer. The work performed by landscape truck drivers (regardless of size of truck driven) is covered by the classifications of truck driver.

Pope County Prevailing Wage for May 2013

(See explanation of column headings at bottom of wages)

Trade Name	RG	TYP	C	Base	FRMAN	M-F>8	OSA	OSH	H/W	Pensn	Vac	Trng
=====	==	===	=	=====	=====	=====	===	===	=====	=====	=====	=====
ASBESTOS ABT-GEN		ALL		25.300	25.750	1.5	1.5	2.0	5.750	10.35	0.000	0.900
ASBESTOS ABT-MEC		BLD		21.150	22.150	1.5	1.5	2.0	6.400	5.150	0.000	0.650
BOILERMAKER		BLD		31.500	34.000	1.5	1.5	2.0	7.070	18.73	1.000	0.350
BRICK MASON		BLD		28.620	30.120	1.5	1.5	2.0	8.200	7.030	0.000	0.430
CARPENTER		BLD		31.890	33.390	1.5	1.5	2.0	6.550	6.750	0.000	0.400
CARPENTER		HWY		31.840	33.340	1.5	1.5	2.0	6.550	6.750	0.000	0.400
CEMENT MASON		BLD		28.200	29.700	1.5	1.5	2.0	6.600	5.400	0.000	0.500
CEMENT MASON		HWY		27.290	28.290	1.5	1.5	2.0	6.600	5.160	0.000	0.400
CERAMIC TILE FNSHER		BLD		27.120	0.000	1.5	1.5	2.0	8.200	7.030	0.000	0.430
ELECTRIC PWR EQMT OP		ALL	1	35.570	0.000	1.5	1.5	2.0	5.000	9.960	0.000	0.360
ELECTRIC PWR EQMT OP		ALL	2	31.740	0.000	1.5	1.5	2.0	5.000	8.880	0.000	0.320
ELECTRIC PWR GRNDMAN		ALL		26.100	0.000	1.5	1.5	2.0	5.000	7.310	0.000	0.260
ELECTRIC PWR LINEMAN		ALL		44.630	47.650	1.5	1.5	2.0	5.000	12.50	0.000	0.450
ELECTRICIAN		ALL		39.350	41.600	1.5	1.5	2.0	6.140	9.440	0.000	0.790
ELECTRONIC SYS TECH		BLD		32.570	34.320	1.5	1.5	2.0	6.000	4.240	0.000	0.400
FLOOR LAYER		BLD		29.330	30.080	1.5	1.5	2.0	6.550	6.750	0.000	0.400
GLAZIER		BLD		26.780	28.030	1.5	1.5	2.0	6.120	5.200	0.000	0.300
HT/FROST INSULATOR		BLD		29.450	30.450	1.5	1.5	2.0	5.050	9.730	0.000	0.280
IRON WORKER		ALL		27.730	29.730	1.5	1.5	2.0	7.010	11.41	0.000	0.500
LABORER		BLD		25.300	25.750	1.5	1.5	2.0	5.750	10.35	0.000	0.800
LABORER		HWY		25.300	25.750	1.5	1.5	2.0	5.750	10.35	0.000	0.800
LABORER		O&C		17.740	18.190	1.5	1.5	2.0	5.450	8.450	0.000	0.800
MACHINIST		BLD		43.550	46.050	1.5	1.5	2.0	6.130	8.950	1.850	0.000
MARBLE FINISHERS		BLD		27.120	0.000	1.5	1.5	2.0	8.200	7.030	0.000	0.430
MARBLE MASON		BLD		28.620	30.120	1.5	1.5	2.0	8.200	7.030	0.000	0.430
MILLWRIGHT		BLD		31.890	33.390	1.5	1.5	2.0	6.550	6.750	0.000	0.400
MILLWRIGHT		HWY		31.840	33.340	1.5	1.5	2.0	6.550	6.750	0.000	0.400
OE RIVER 1		RIV	1	33.550	34.550	1.5	1.5	2.0	7.000	8.800	0.000	1.450
OE RIVER 2		RIV	2	30.100	34.550	1.5	1.5	2.0	7.000	8.800	0.000	1.450
OPERATING ENGINEER		ALL	1	33.450	34.450	1.5	1.5	2.0	7.000	8.800	0.000	1.450
OPERATING ENGINEER		ALL	2	31.550	34.450	1.5	1.5	2.0	7.000	8.800	0.000	1.450
OPERATING ENGINEER		ALL	3	24.150	34.450	1.5	1.5	2.0	7.000	8.800	0.000	1.450
OPERATING ENGINEER		ALL	4	21.400	27.800	1.5	1.5	2.0	5.650	6.100	0.000	1.100
OPERATING ENGINEER		O&C	1	25.090	26.090	1.5	1.5	2.0	7.000	8.800	0.000	1.450
OPERATING ENGINEER		O&C	2	23.660	26.090	1.5	1.5	2.0	7.000	8.800	0.000	1.450
OPERATING ENGINEER		O&C	3	18.120	26.090	1.5	1.5	2.0	7.000	8.800	0.000	1.450
OPERATING ENGINEER		O&C	4	16.050	21.100	1.5	1.5	2.0	5.650	6.100	0.000	1.100
PAINTER		BLD		26.260	27.760	1.5	1.5	2.0	6.630	7.070	0.000	0.500
PAINTER		HWY		30.560	32.060	1.5	1.5	2.0	6.630	7.070	0.000	0.500
PAINTER OVER 30FT		BLD		27.260	28.760	1.5	1.5	2.0	6.630	7.070	0.000	0.500
PAINTER PWR EQMT		BLD		27.260	28.760	1.5	1.5	2.0	6.630	7.070	0.000	0.500
PAINTER PWR EQMT		HWY		31.560	33.060	1.5	1.5	2.0	6.630	7.070	0.000	0.500
PILEDRIVER		BLD		31.890	33.390	1.5	1.5	2.0	6.550	6.750	0.000	0.400
PILEDRIVER		HWY		31.840	33.340	1.5	1.5	2.0	6.550	6.750	0.000	0.400
PIPEFITTER		BLD		41.470	45.620	1.5	2.0	2.0	8.450	5.780	0.000	1.250
PLASTERER		BLD		28.200	29.700	1.5	1.5	2.0	6.600	5.400	0.000	0.500
PLUMBER		BLD		41.470	45.620	1.5	2.0	2.0	8.450	5.780	0.000	1.250
ROOFER		BLD		23.900	24.900	1.5	1.5	2.0	8.650	3.800	0.000	0.000
SHEETMETAL WORKER		ALL		31.690	33.190	1.5	1.5	2.0	7.130	6.730	1.910	0.360
SPRINKLER FITTER		BLD		36.390	39.140	1.5	1.5	2.0	8.420	8.500	0.000	0.450

STONE MASON	BLD	28.620	30.120	1.5	1.5	2.0	8.200	7.030	0.000	0.430
TERRAZZO FINISHER	BLD	27.120	0.000	1.5	1.5	2.0	8.200	7.030	0.000	0.430
TRUCK DRIVER	ALL 1	30.070	0.000	1.5	1.5	2.0	10.30	6.100	0.000	0.250
TRUCK DRIVER	ALL 2	30.520	0.000	1.5	1.5	2.0	10.30	6.100	0.000	0.250
TRUCK DRIVER	ALL 3	30.740	0.000	1.5	1.5	2.0	10.30	6.100	0.000	0.250
TRUCK DRIVER	ALL 4	31.030	0.000	1.5	1.5	2.0	10.30	6.100	0.000	0.250
TRUCK DRIVER	ALL 5	31.850	0.000	1.5	1.5	2.0	10.30	6.100	0.000	0.250
TRUCK DRIVER	O&C 1	22.750	0.000	1.5	1.5	2.0	2.920	6.700	0.000	0.250
TRUCK DRIVER	O&C 2	19.150	0.000	1.5	1.5	2.0	2.920	6.700	0.000	0.250
TRUCK DRIVER	O&C 3	19.650	0.000	1.5	1.5	2.0	2.920	6.700	0.000	0.250
TUCKPOINTER	BLD	28.620	30.120	1.5	1.5	2.0	8.200	7.030	0.000	0.430

Legend:

RG (Region)

TYP (Trade Type - All,Highway,Building,Floating,Oil & Chip,Rivers)

C (Class)

Base (Base Wage Rate)

FRMAN (Foreman Rate)

M-F>8 (OT required for any hour greater than 8 worked each day, Mon through Fri.

OSA (Overtime (OT) is required for every hour worked on Saturday)

OSH (Overtime is required for every hour worked on Sunday and Holidays)

H/W (Health & Welfare Insurance)

Pensn (Pension)

Vac (Vacation)

Trng (Training)

Explanations

POPE COUNTY

The following list is considered as those days for which holiday rates of wages for work performed apply: New Years Day, Memorial Day, Fourth of July, Labor Day, Thanksgiving Day, Christmas Day and Veterans Day in some classifications/counties. Generally, any of these holidays which fall on a Sunday is celebrated on the following Monday. This then makes work performed on that Monday payable at the appropriate overtime rate for holiday pay. Common practice in a given local may alter certain days of celebration. If in doubt, please check with IDOL.

Oil and chip resealing (O&C) means the application of road oils and liquid asphalt to coat an existing road surface, followed by application of aggregate chips or gravel to coated surface, and subsequent rolling of material to seal the surface.

EXPLANATION OF CLASSES

ASBESTOS - GENERAL - removal of asbestos material/mold and hazardous

materials from any place in a building, including mechanical systems where those mechanical systems are to be removed. This includes the removal of asbestos materials/mold and hazardous materials from ductwork or pipes in a building when the building is to be demolished at the time or at some close future date.

ASBESTOS - MECHANICAL - removal of asbestos material from mechanical systems, such as pipes, ducts, and boilers, where the mechanical systems are to remain.

LABORER - OIL AND CHIP RESEALING ONLY

Hook and unhook chip box from aggregate truck; distribute material within chip box; perform flagging work related to oil and chip resealing; hand spray oil fluids; handle traffic control, including setting-up and maintaining barricades, drums, cones, delineators, signs and other such items, as well as laying-out and applying or removing temporary roadway markings used to control traffic in job site related to oil and chip resealing; and perform clean-up related to oil and chip resealing.

CERAMIC TILE FINISHER, MARBLE FINISHER, TERRAZZO FINISHER

Assisting, helping or supporting the tile, marble and terrazzo mechanic by performing their historic and traditional work assignments required to complete the proper installation of the work covered by said crafts. The term "Ceramic" is used for naming the classification only, and is in no a limitation of the product handled. Ceramic takes into consideration most hard tiles.

ELECTRIC POWER LINEMAN

Construction, maintenance and dismantling of overhead and underground electric power lines, including high voltage pipe type cable work, and associated structures and equipment.

ELECTRIC POWER EQUIPMENT OPERATOR - CLASS 1

Operation of all crawler type equipment D-4 and larger from the ground to assist the Electric Power Linemen in performing their duties.

ELECTRIC POWER EQUIPMENT OPERATORS - CLASS 2

Operation of all other equipment from the ground to assist the Electric Power Linemen in performing their duties.

ELECTRIC POWER GROUNDMAN

Applies to workers who assist the Electric Power Lineman from the ground.

ELECTRONIC SYSTEMS TECHNICIAN

Installation, service and maintenance of low-voltage systems which utilizes the transmission and/or transference of voice, sound, vision, or digital for commercial, education, security and entertainment purposes for the following: TV monitoring and surveillance, background/foreground music, intercom and telephone interconnect, field programming, inventory control systems, microwave transmission, multi-media, multiplex, radio page, school, intercom and sound burglar alarms and low voltage master clock systems.

Excluded from this classification are energy management systems, life safety systems, supervisory controls and data acquisition systems not intrinsic with the above listed systems, fire alarm systems, nurse

call systems and raceways exceeding fifteen feet in length.

TRUCK DRIVER - BUILDING, HEAVY AND HIGHWAY CONSTRUCTION

Class 1. Drivers on 2 axle trucks hauling less than 9 ton. Air compressor and welding machines and brooms, including those pulled by separate units, truck driver helpers, warehouse employees, mechanic helpers, greasers and tiremen, pickup trucks when hauling materials, tools, or workers to and from and on-the-job site, and fork lifts up to 6,000 lb. capacity.

Class 2. Two or three axle trucks hauling more than 9 ton but hauling less than 16 ton. A-frame winch trucks, hydrolift trucks, vactor trucks or similar equipment when used for transportation purposes. Fork lifts over 6,000 lb. capacity, winch trucks, four axle combination units, and ticket writers.

Class 3. Two, three or four axle trucks hauling 16 ton or more. Drivers on water pulls, articulated dump trucks, mechanics and working forepersons, and dispatchers. Five axle or more combination units.

Class 4. Low Boy and Oil Distributors.

Class 5. Drivers who require special protective clothing while employed on hazardous waste work.

TRUCK DRIVER - O & C (Oil and Chip Resealing ONLY)

It involves driving of contractor or subcontractor owned, leased, or hired pickup, dump, service, or oil distributor trucks. Includes transporting materials and equipment (including, but not limited to oils, aggregate supplies, parts, machinery and tools) to or from the job site; distributing oil or liquid asphalt and aggregate; stock piling material; and maintaining trucks at job site related to oil and chip resealing.

Class 1. Distributors, liquid asphalt hauling and hauling of asphalt rubber-tired rollers.

Class 2. Stockpiling.

Class 3. Tandem hauling to job site.

OPERATING ENGINEERS - BUILDING, HEAVY AND HIGHWAY CONSTRUCTION

Class 1. APSCO or Equal Spreading Machine, Backhoe, Backfiller, Boom or Winch Cat, Bituminous Mixplane Machine, Blacksmith, Bituminous Surfacing Machine, Bull-Dozer, Crane, Shovel, Dragline, Truck Crane, Pile Driver, Concrete Breaker, Concrete or Pumpcrete Pumps, Dinky or Standard Locomotives, Well or Caisson Drills, Elevating Grader, Fork Lifts, Flexplane, Gradeall, Hi-Lift Hoists, Guy-Derricks, Hysters, Mechanic Motor Patrol, Mixers-21 cu. ft. or over, Push Cats, Pulls and Scrapers, Two Well Point Pumps, Pulverizer or Tiller, PugMill, Rubber-Tired Farm Type Tractor with Bulldozer/Blade/Auger or hi-lift over 1/2 yd., Jersey Spreader, Tract-Air used with Drill or Hi-Lift, Trenching or Ditching Machines, Wood Chipper w/Tractor, Self-Propelled Roller w/Blade, Equipment Greaser, Self-Propelled Bump Grinder on Concrete pavement, Boat Operator, Skid-Loaders, Tuggers, Lazer Screed, and Self-Propelled Chip Spreader (when others run conveyors).

Class 2. Any type tractor pulling any type roller or disc, Two Air Compressors (220 cu. ft. capacity or over), Two AirTract Drills, Air-Track Drill w/Compressor, Automatic Bins or Scales w/Compressor or Generator, Pipeline Boring Machine, Bulk Cement Plant w/Separate Compressor, Power Operated Bull Float, Hydra-Lift w/Single Motor, Straw Mulcher Blower w/Spout, Self-Propelled Roller/Compactor,

Back-End man on Bituminous Surfacing Machine, oiler on milling machine.

Class 3. Air Compressor w/Valve driving piling, Boom or Winch Type Truck, Two Conveyors, Self-Propelled Concrete Saw, Form Grader, Truck Crane Oiler, Self-Propelled Vibrator, Rubber Tired Farm Type Tractor w/Blade/Bulldozer/Auger/hi-lift - 1/2 yd. or less, Elevator Operator, Man Lift (scissor lift) when lifting materials.

Class 4. Air-Track Drill (one), Belt Drag Machine, Power Broom, Mechanical Plasterer Applicator, Trac-Air, Air Compressor (220 cu. ft. or over) One, Air Compressor (under 220 cu. ft) four, Automatic Bin, Bulk Cement Plant w/Built-in Compressor running off same motor or electric motor, Fireman or Switchman, Self-Propelled Form Tamper, Light Plants (4), Welding Machines (4), Pumps (4), or Combination of four (4) Pumps, Light Plants, Welding Machines, Air-Compressors (under 220 cu. ft.), Mudjacks or Wood Chipper, Mixers - less than 21 cu. ft. Mortar Mixer w/Skip or Pump, Pipeline Tract Jack. One Operating Engineer may operate and maintain any combination of the following pieces of equipment, not to exceed four (4) which shall be within a reasonable distance, such combination may include any equipment in this classification: (Compressors, Light Plants, Generators, Welding Machines, Pumps or Conveyors), One Well- Point Pump, Two Motor Driven Heaters, One Air Compressor (under 220 cu. ft.), One Engine-Driven Conveyor, One Motor Driven Heater, One Light Plant, One Pump, One Welding Machine, One Ulmac or Equal Spreader, Oilers, and one Generator 10 kw or greater.

OPERATING ENGINEER - O & C (Oil and Chip Resealing ONLY). Includes the operation of all motorized heavy equipment used in oil and chip resealing, including but not limited to operating self-propelled chip spreaders, and all types of rollers (both hard and rubber tired); and other duties pertaining to the operation or maintenance of heavy equipment related to oil and chip resealing.

Class 1. See Class 1 above for types of equipment operated.

Class 2. See Class 2 above for types of equipment operated.

Class 3. See Class 3 above for types of equipment operated.

Class 4. See Class 4 above for types of equipment operated.

OPERATING ENGINEER RIVER WORK 1 - operate the following machines when working on River Work and Levee Work on the Mississippi and Ohio Rivers, Lakes and Tributaries: Crane, Shovel, Drageline, Scrapers, Dredge, Derrick, Pile-Driver, Push Boat, all power boat operators, Mechanic, Engineman on Dredge, Leverman on Dredge, All Bituminous Spreader machines, Backhoe, Backfiller, Boom, or Winch Cat, Bituminous Mixplane Machine, Blacksmith, Bituminous Surfacing Machine, Bulldozer, Truck Cranes, Hydraulic Truck Mounted Boom/Crane, Concrete Finishing Machine, or Spreader Machine, Concrete Breaker, Concrete or Pumpcrete Machines, Concrete Plant Operator, All Off Road Material Hauling Equipment, Dinky or Standard Locomotives, Well Drill, Elevating Grader, Fork-Lifts, Flexplane, Gradeall, Hi-Lift, Power Handblade Tugger type Hoist, Hoist Two Drum (or over one), Guyderrick, Hyster, Motor Patrol, Mixers - 21 Cu. Ft. or over, Push Cat, Pulls, & Scrapers, Pumps-Two Well Points, Equipment Greaser, P & H Pulverizer or Pulverizer equal to Pugmill, Pugmill, Rubber-Tired farm type tractor w/Bulldozer/Blade/Auger or Hi-Lift over 1/2 yard, Skimmer Scoops, Seaman Tiller, Jersey Spreader, Tract-Air used with Drill or Hi-Lift, Trenching or Ditching Machine, Wood Chipper w/Tractor, self-propelled roller w/Blade, Concrete Pumps and Small Equipment Operators.

OPERATING ENGINEER RIVER 2 - when working on River Work and Levee Work on the Mississippi and Ohio Rivers, Lakes and Tributaries shall be employed as the Oiler or Fireman on Crane, Dragline, Shovel, Dredge, Truck Crane, Pile Driver, Gradeall, Dinky or Standard Locomotive, Guy Derrick, Trenching Machine or Ditching Machine 80 H.P. and over, All Terrain (cherry-picker) with over 40 ton Lifting Capacity, Deck Oiler and Deckhands.

Other Classifications of Work:

For definitions of classifications not otherwise set out, the Department generally has on file such definitions which are available. If a task to be performed is not subject to one of the classifications of pay set out, the Department will upon being contacted state which neighboring county has such a classification and provide such rate, such rate being deemed to exist by reference in this document. If no neighboring county rate applies to the task, the Department shall undertake a special determination, such special determination being then deemed to have existed under this determination. If a project requires these, or any classification not listed, please contact IDOL at 217-782-1710 for wage rates or clarifications.

LANDSCAPING

Landscaping work falls under the existing classifications for laborer, operating engineer and truck driver. The work performed by landscape plantsman and landscape laborer is covered by the existing classification of laborer. The work performed by landscape operators (regardless of equipment used or its size) is covered by the classifications of operating engineer. The work performed by landscape truck drivers (regardless of size of truck driven) is covered by the classifications of truck driver.

Pulaski County Prevailing Wage for May 2013

(See explanation of column headings at bottom of wages)

Trade Name	RG	TYP	C	Base	FRMAN	M-F>8	OSA	OSH	H/W	Pensn	Vac	Trng
=====	==	===	=	=====	=====	=====	===	===	=====	=====	=====	=====
ASBESTOS ABT-GEN		ALL		25.300	25.750	1.5	1.5	2.0	5.750	10.35	0.000	0.900
ASBESTOS ABT-MEC		BLD		21.150	22.150	1.5	1.5	2.0	6.400	5.150	0.000	0.650
BOILERMAKER		BLD		31.500	34.000	1.5	1.5	2.0	7.070	18.73	1.000	0.350
BRICK MASON		BLD		28.620	30.120	1.5	1.5	2.0	8.200	7.030	0.000	0.430
CARPENTER		BLD		31.890	33.390	1.5	1.5	2.0	6.550	6.750	0.000	0.400
CARPENTER		HWY		31.840	33.340	1.5	1.5	2.0	6.550	6.750	0.000	0.400
CEMENT MASON		BLD		28.200	29.700	1.5	1.5	2.0	6.600	5.400	0.000	0.500
CEMENT MASON		HWY		27.290	28.290	1.5	1.5	2.0	6.600	5.160	0.000	0.400
CERAMIC TILE FNSHER		BLD		27.120	0.000	1.5	1.5	2.0	8.200	7.030	0.000	0.430
ELECTRIC PWR EQMT OP		ALL	1	35.570	0.000	1.5	1.5	2.0	5.000	9.960	0.000	0.360
ELECTRIC PWR EQMT OP		ALL	2	31.740	0.000	1.5	1.5	2.0	5.000	8.880	0.000	0.320
ELECTRIC PWR GRNDMAN		ALL		26.100	0.000	1.5	1.5	2.0	5.000	7.310	0.000	0.260
ELECTRIC PWR LINEMAN		ALL		44.630	47.650	1.5	1.5	2.0	5.000	12.50	0.000	0.450
ELECTRICIAN		ALL		39.350	41.600	1.5	1.5	2.0	6.140	9.440	0.000	0.790
ELECTRONIC SYS TECH		BLD		32.570	34.320	1.5	1.5	2.0	6.000	4.240	0.000	0.400
FLOOR LAYER		BLD		29.330	30.080	1.5	1.5	2.0	6.550	6.750	0.000	0.400
GLAZIER		BLD		26.780	28.030	1.5	1.5	2.0	6.120	5.200	0.000	0.300
HT/FROST INSULATOR		BLD		29.450	30.450	1.5	1.5	2.0	5.050	9.730	0.000	0.280
IRON WORKER		ALL		27.730	29.730	1.5	1.5	2.0	7.010	11.41	0.000	0.500
LABORER		BLD		25.300	25.750	1.5	1.5	2.0	5.750	10.35	0.000	0.800
LABORER		HWY		25.300	25.750	1.5	1.5	2.0	5.750	10.35	0.000	0.800
LABORER		O&C		17.740	18.190	1.5	1.5	2.0	5.450	8.450	0.000	0.800
MACHINIST		BLD		43.550	46.050	1.5	1.5	2.0	6.130	8.950	1.850	0.000

MARBLE FINISHERS	BLD	27.120	0.000	1.5	1.5	2.0	8.200	7.030	0.000	0.430
MARBLE MASON	BLD	28.620	30.120	1.5	1.5	2.0	8.200	7.030	0.000	0.430
MILLWRIGHT	BLD	31.890	33.390	1.5	1.5	2.0	6.550	6.750	0.000	0.400
MILLWRIGHT	HWY	31.840	33.340	1.5	1.5	2.0	6.550	6.750	0.000	0.400
OE RIVER 1	RIV 1	33.550	34.550	1.5	1.5	2.0	7.000	8.800	0.000	1.450
OE RIVER 2	RIV 2	30.100	34.550	1.5	1.5	2.0	7.000	8.800	0.000	1.450
OPERATING ENGINEER	ALL 1	33.450	34.450	1.5	1.5	2.0	7.000	8.800	0.000	1.450
OPERATING ENGINEER	ALL 2	31.550	34.450	1.5	1.5	2.0	7.000	8.800	0.000	1.450
OPERATING ENGINEER	ALL 3	24.150	34.450	1.5	1.5	2.0	7.000	8.800	0.000	1.450
OPERATING ENGINEER	ALL 4	21.400	27.800	1.5	1.5	2.0	5.650	6.100	0.000	1.100
OPERATING ENGINEER	O&C 1	25.090	26.090	1.5	1.5	2.0	7.000	8.800	0.000	1.450
OPERATING ENGINEER	O&C 2	23.660	26.090	1.5	1.5	2.0	7.000	8.800	0.000	1.450
OPERATING ENGINEER	O&C 3	18.120	26.090	1.5	1.5	2.0	7.000	8.800	0.000	1.450
OPERATING ENGINEER	O&C 4	16.050	21.100	1.5	1.5	2.0	5.650	6.100	0.000	1.100
PAINTER	BLD	26.260	27.760	1.5	1.5	2.0	6.630	7.070	0.000	0.500
PAINTER	HWY	30.560	32.060	1.5	1.5	2.0	6.630	7.070	0.000	0.500
PAINTER OVER 30FT	BLD	27.260	28.760	1.5	1.5	2.0	6.630	7.070	0.000	0.500
PAINTER PWR EQMT	BLD	27.260	28.760	1.5	1.5	2.0	6.630	7.070	0.000	0.500
PAINTER PWR EQMT	HWY	31.560	33.060	1.5	1.5	2.0	6.630	7.070	0.000	0.500
PILEDRIVER	BLD	31.890	33.390	1.5	1.5	2.0	6.550	6.750	0.000	0.400
PILEDRIVER	HWY	31.840	33.340	1.5	1.5	2.0	6.550	6.750	0.000	0.400
PIPEFITTER	BLD	41.470	45.620	1.5	2.0	2.0	8.450	5.780	0.000	1.250
PLASTERER	BLD	28.200	29.700	1.5	1.5	2.0	6.600	5.400	0.000	0.500
PLUMBER	BLD	41.470	45.620	1.5	2.0	2.0	8.450	5.780	0.000	1.250
ROOFER	BLD	23.900	24.900	1.5	1.5	2.0	8.650	3.800	0.000	0.000
SHEETMETAL WORKER	ALL	31.690	33.190	1.5	1.5	2.0	7.130	6.730	1.910	0.360
SPRINKLER FITTER	BLD	36.390	39.140	1.5	1.5	2.0	8.420	8.500	0.000	0.450
STONE MASON	BLD	28.620	30.120	1.5	1.5	2.0	8.200	7.030	0.000	0.430
TERRAZZO FINISHER	BLD	27.120	0.000	1.5	1.5	2.0	8.200	7.030	0.000	0.430
TERRAZZO MASON	BLD	28.620	30.120	1.5	1.5	2.0	8.200	7.030	0.000	0.430
TRUCK DRIVER	ALL 1	30.070	0.000	1.5	1.5	2.0	10.30	6.100	0.000	0.250
TRUCK DRIVER	ALL 2	30.520	0.000	1.5	1.5	2.0	10.30	6.100	0.000	0.250
TRUCK DRIVER	ALL 3	30.740	0.000	1.5	1.5	2.0	10.30	6.100	0.000	0.250
TRUCK DRIVER	ALL 4	31.030	0.000	1.5	1.5	2.0	10.30	6.100	0.000	0.250
TRUCK DRIVER	ALL 5	31.850	0.000	1.5	1.5	2.0	10.30	6.100	0.000	0.250
TRUCK DRIVER	O&C 1	22.750	0.000	1.5	1.5	2.0	2.920	6.700	0.000	0.250
TRUCK DRIVER	O&C 2	19.150	0.000	1.5	1.5	2.0	2.920	6.700	0.000	0.250
TRUCK DRIVER	O&C 3	19.650	0.000	1.5	1.5	2.0	2.920	6.700	0.000	0.250
TUCKPOINTER	BLD	28.620	30.120	1.5	1.5	2.0	8.200	7.030	0.000	0.430

Legend :

RG (Region)

TYP (Trade Type - All,Highway,Building,Floating,Oil & Chip,Rivers)

C (Class)

Base (Base Wage Rate)

FRMAN (Foreman Rate)

M-F>8 (OT required for any hour greater than 8 worked each day, Mon through Fri.)

OSA (Overtime (OT) is required for every hour worked on Saturday)

OSH (Overtime is required for every hour worked on Sunday and Holidays)

H/W (Health & Welfare Insurance)

Pensn (Pension)

Vac (Vacation)

Explanations

PULASKI COUNTY

The following list is considered as those days for which holiday rates of wages for work performed apply: New Years Day, Memorial Day, Fourth of July, Labor Day, Thanksgiving Day, Christmas Day and Veterans Day in some classifications/counties. Generally, any of these holidays which fall on a Sunday is celebrated on the following Monday. This then makes work performed on that Monday payable at the appropriate overtime rate for holiday pay. Common practice in a given local may alter certain days of celebration. If in doubt, please check with IDOL.

Oil and chip resealing (O&C) means the application of road oils and liquid asphalt to coat an existing road surface, followed by application of aggregate chips or gravel to coated surface, and subsequent rolling of material to seal the surface.

EXPLANATION OF CLASSES

ASBESTOS - GENERAL - removal of asbestos material/mold and hazardous materials from any place in a building, including mechanical systems where those mechanical systems are to be removed. This includes the removal of asbestos materials/mold and hazardous materials from ductwork or pipes in a building when the building is to be demolished at the time or at some close future date.

ASBESTOS - MECHANICAL - removal of asbestos material from mechanical systems, such as pipes, ducts, and boilers, where the mechanical systems are to remain.

LABORER - OIL AND CHIP RESEALING ONLY

Hook and unhook chip box from aggregate truck; distribute material within chip box; perform flagging work related to oil and chip resealing; hand spray oil fluids; handle traffic control, including setting-up and maintaining barricades, drums, cones, delineators, signs and other such items, as well as laying-out and applying or removing temporary roadway markings used to control traffic in job site related to oil and chip resealing; and perform clean-up related to oil and chip resealing.

CERAMIC TILE FINISHER, MARBLE FINISHER, TERRAZZO FINISHER

Assisting, helping or supporting the tile, marble and terrazzo mechanic by performing their historic and traditional work assignments required to complete the proper installation of the work covered by said crafts. The term "Ceramic" is used for naming the classification only, and is in no a limitation of the product handled. Ceramic takes into consideration most hard tiles.

ELECTRIC POWER LINEMAN

Construction, maintenance and dismantling of overhead and underground electric power lines, including high voltage pipe type cable work, and associated structures and equipment.

ELECTRIC POWER EQUIPMENT OPERATOR - CLASS 1

Operation of all crawler type equipment D-4 and larger from the ground to assist the Electric Power Linemen in performing their duties.

ELECTRIC POWER EQUIPMENT OPERATORS - CLASS 2

Operation of all other equipment from the ground to assist the Electric Power Linemen in performing their duties.

ELECTRIC POWER GROUNDMAN

Applies to workers who assist the Electric Power Lineman from the ground.

ELECTRONIC SYSTEMS TECHNICIAN

Installation, service and maintenance of low-voltage systems which utilizes the transmission and/or transference of voice, sound, vision, or digital for commercial, education, security and entertainment purposes for the following: TV monitoring and surveillance, background/foreground music, intercom and telephone interconnect, field programming, inventory control systems, microwave transmission, multi-media, multiplex, radio page, school, intercom and sound burglar alarms and low voltage master clock systems.

Excluded from this classification are energy management systems, life safety systems, supervisory controls and data acquisition systems not intrinsic with the above listed systems, fire alarm systems, nurse call systems and raceways exceeding fifteen feet in length.

TRUCK DRIVER - BUILDING, HEAVY AND HIGHWAY CONSTRUCTION

Class 1. Drivers on 2 axle trucks hauling less than 9 ton. Air compressor and welding machines and brooms, including those pulled by separate units, truck driver helpers, warehouse employees, mechanic helpers, greasers and tiremen, pickup trucks when hauling materials, tools, or workers to and from and on-the-job site, and fork lifts up to 6,000 lb. capacity.

Class 2. Two or three axle trucks hauling more than 9 ton but hauling less than 16 ton. A-frame winch trucks, hydrolift trucks, vactor trucks or similar equipment when used for transportation purposes. Fork lifts over 6,000 lb. capacity, winch trucks, four axle combination units, and ticket writers.

Class 3. Two, three or four axle trucks hauling 16 ton or more. Drivers on water pulls, articulated dump trucks, mechanics and working forepersons, and dispatchers. Five axle or more combination units.

Class 4. Low Boy and Oil Distributors.

Class 5. Drivers who require special protective clothing while employed on hazardous waste work.

TRUCK DRIVER - O & C (Oil and Chip Resealing ONLY)

It involves driving of contractor or subcontractor owned, leased, or hired pickup, dump, service, or oil distributor trucks. Includes transporting materials and equipment (including, but not limited to oils, aggregate supplies, parts, machinery and tools) to or from the job site; distributing oil or liquid asphalt and aggregate; stock piling material; and maintaining trucks at job site related to oil and chip resealing.

Class 1. Distributors, liquid asphalt hauling and hauling of asphalt rubber-tired rollers.

Class 2. Stockpiling.

Class 3. Tandem hauling to job site.

OPERATING ENGINEERS - BUILDING, HEAVY AND HIGHWAY CONSTRUCTION

Class 1. APSCO or Equal Spreading Machine, Backhoe, Backfiller, Boom or Winch Cat, Bituminous Mixplane Machine, Blacksmith, Bituminous Surfacing Machine, Bull-Dozer, Crane, Shovel, Dragline, Truck Crane, Pile Driver, Concrete Breaker, Concrete or Pumpcrete Pumps, Dinky or Standard Locomotives, Well or Caisson Drills, Elevating Grader, Fork Lifts, Flexplane, Gradeall, Hi-Lift Hoists, Guy-Derricks, Hysters, Mechanic Motor Patrol, Mixers-21 cu. ft. or over, Push Cats, Pulls and Scrapers, Two Well Point Pumps, Pulverizer or Tiller, PugMill, Rubber-Tired Farm Type Tractor with Bulldozer/Blade/Auger or hi-lift over 1/2 yd., Jersey Spreader, Tract-Air used with Drill or Hi-Lift, Trenching or Ditching Machines, Wood Chipper w/Tractor, Self-Propelled Roller w/Blade, Equipment Greaser, Self-Propelled Bump Grinder on Concrete pavement, Boat Operator, Skid-Loaders, Tuggers, Lazer Screed, and Self-Propelled Chip Spreader (when others run conveyors).

Class 2. Any type tractor pulling any type roller or disc, Two Air Compressors (220 cu. ft. capacity or over), Two AirTract Drills, Air-Track Drill w/Compressor, Automatic Bins or Scales w/Compressor or Generator, Pipeline Boring Machine, Bulk Cement Plant w/Separate Compressor, Power Operated Bull Float, Hydra-Lift w/Single Motor, Straw Mulcher Blower w/Spout, Self-Propelled Roller/Compactor, Back-End man on Bituminous Surfacing Machine, oiler on milling machine.

Class 3. Air Compressor w/Valve driving piling, Boom or Winch Type Truck, Two Conveyors, Self-Propelled Concrete Saw, Form Grader, Truck Crane Oiler, Self-Propelled Vibrator, Rubber Tired Farm Type Tractor w/Blade/Bulldozer/Auger/hi-lift - 1/2 yd. or less, Elevator Operator, Man Lift (scissor lift) when lifting materials.

Class 4. Air-Track Drill (one), Belt Drag Machine, Power Broom, Mechanical Plasterer Applicator, Trac-Air, Air Compressor (220 cu. ft. or over) One, Air Compressor (under 220 cu. ft) four, Automatic Bin, Bulk Cement Plant w/Built-in Compressor running off same motor or electric motor, Fireman or Switchman, Self-Propelled Form Tamper, Light Plants (4), Welding Machines (4), Pumps (4), or Combination of four (4) Pumps, Light Plants, Welding Machines, Air-Compressors (under 220 cu. ft.), Mudjacks or Wood Chipper, Mixers - less than 21 cu. ft. Mortar Mixer w/Skip or Pump, Pipeline Tract Jack. One Operating Engineer may operate and maintain any combination of the following pieces of equipment, not to exceed four (4) which shall be within a reasonable distance, such combination may include any equipment in this classification: (Compressors, Light Plants, Generators, Welding Machines, Pumps or Conveyors), One Well- Point Pump, Two Motor Driven Heaters, One Air Compressor (under 220 cu. ft.), One Engine-Driven Conveyor, One Motor Driven Heater, One Light Plant, One Pump, One Welding Machine, One Ulmac or Equal Spreader, Oilers, and one Generator 10 kw or greater.

OPERATING ENGINEER - O & C (Oil and Chip Resealing ONLY). Includes the operation of all motorized heavy equipment used in oil and chip rsealing, including but not limited to operating self-propelled chip spreaders, and all types of rollers (both hard and rubber tired); and other duties pertaining to the operation or maintenance of heavy equipment related to oil and chip resealing.

Class 1. See Class 1 above for types of equipment operated.

Class 2. See Class 2 above for types of equipment operated.

Class 3. See Class 3 above for types of equipment operated.

Class 4. See Class 4 above for types of equipment operated.

OPERATING ENGINEER RIVER WORK 1 - operate the following machines when working on River Work and Levee Work on the Mississippi and Ohio Rivers, Lakes and Tributaries: Crane, Shovel, Drageline, Scrapers, Dredge, Derrick, Pile-Driver, Push Boat, all power boat operators, Mechanic, Engineman on Dredge, Leverman on Dredge, All Bituminous Spreader machines, Backhoe, Backfiller, Boom, or Winch Cat, Bituminous Mixplane Machine, Blacksmith, Bituminous Surfacing Machine, Bulldozer, Truck Cranes, Hydraulic Truck Mounted Boom/Crane, Concrete Finishing Machine, or Spreader Machine, Concrete Breaker, Concrete or Pumpcrete Machines, Concrete Plant Operator, All Off Road Material Hauling Equipment, Dinky or Standard Locomotives, Well Drill, Elevating Grader, Fork-Lifts, Flexplane, Gradeall, Hi-Lift, Power Handblade Tugger type Hoist, Hoist Two Drum (or over one), Gyderrick, Hyster, Motor Patrol, Mixers - 21 Cu. Ft. or over, Push Cat, Pulls, & Scrapers, Pumps-Two Well Points, Equipment Greaser, P & H Pulverizer or Pulverizer equal to Pugmill, Pugmill, Rubber-Tired farm type tractor w/Bulldozer/Blade/Auger or Hi-Lift over ½ yard, Skimmer Scoops, Seaman Tiller, Jersey Spreader, Tract-Air used with Drill or Hi-Lift, Trenching or Ditching Machine, Wood Chipper w/Tractor, self-propelled roller w/Blade, Concrete Pumps and Small Equipment Operators.

OPERATING ENGINEER RIVER 2 - when working on River Work and Levee Work on the Mississippi and Ohio Rivers, Lakes and Tributaries shall be employed as the Oiler or Fireman on Crane, Dragline, Shovel, Dredge, Truck Crane, Pile Driver, Gradeall, Dinky or Standard Locomotive, Guy Derrick, Trenching Machine or Ditching Machine 80 H.P. and over, All Terrain (cherry-picker) with over 40 ton Lifting Capacity, Deck Oiler and Deckhands.

Other Classifications of Work:

For definitions of classifications not otherwise set out, the Department generally has on file such definitions which are available. If a task to be performed is not subject to one of the classifications of pay set out, the Department will upon being contacted state which neighboring county has such a classification and provide such rate, such rate being deemed to exist by reference in this document. If no neighboring county rate applies to the task, the Department shall undertake a special determination, such special determination being then deemed to have existed under this determination. If a project requires these, or any classification not listed, please contact IDOL at 217-782-1710 for wage rates or clarifications.

LANDSCAPING

Landscaping work falls under the existing classifications for laborer, operating engineer and truck driver. The work performed by landscape plantsman and landscape laborer is covered by the existing classification of laborer. The work performed by landscape operators (regardless of equipment used or its size) is covered by the classifications of operating engineer. The work performed by landscape truck drivers (regardless of size of truck driven) is covered by the classifications of truck driver.

Putnam County Prevailing Wage for May 2013

(See explanation of column headings at bottom of wages)

Trade Name	RG	TYP	C	Base	FRMAN	M-F>8	OSA	OSH	H/W	Pensn	Vac	Trng
=====	==	===	=	=====	=====	=====	===	===	=====	=====	=====	=====
ASBESTOS ABT-GEN		ALL		29.530	30.780	1.5	1.5	2.0	8.240	8.630	0.000	0.800
ASBESTOS ABT-MEC		BLD		34.160	36.660	1.5	1.5	2.0	10.82	10.66	0.000	0.720
BOILERMAKER		BLD		35.010	38.010	2.0	2.0	2.0	7.070	13.83	0.000	0.300
BRICK MASON		BLD		36.720	37.720	1.5	1.5	2.0	8.720	7.950	0.000	0.580
CARPENTER		BLD		30.250	32.370	1.5	1.5	2.0	8.900	13.68	0.000	0.570
CARPENTER		HWY		30.250	32.000	1.5	1.5	2.0	8.830	13.34	0.000	0.500
CEMENT MASON		ALL		35.000	36.250	2.0	2.0	2.0	7.700	11.67	0.000	0.500
CERAMIC TILE FNSHER		BLD		32.410	0.000	1.5	1.5	2.0	7.700	4.840	0.000	0.530
COMMUNICATION TECH		BLD		31.200	32.700	1.5	1.5	2.0	12.32	10.77	0.000	0.320
ELECTRIC PWR EQMT OP		ALL		35.440	0.000	1.5	1.5	2.0	5.000	10.98	0.000	0.270
ELECTRIC PWR GRNDMAN		ALL		24.320	0.000	1.5	1.5	2.0	5.000	7.540	0.000	0.180
ELECTRIC PWR LINEMAN		ALL		39.370	41.910	1.5	1.5	2.0	5.000	12.20	0.000	0.300
ELECTRIC PWR TRK DRV		ALL		25.510	0.000	1.5	1.5	2.0	5.000	7.920	0.000	0.190
ELECTRICIAN		BLD		37.950	41.370	1.5	1.5	2.0	13.17	15.06	0.000	1.200
ELEVATOR CONSTRUCTOR		BLD		40.520	45.585	2.0	2.0	2.0	11.88	12.71	3.240	0.600
GLAZIER		BLD		30.770	32.770	1.5	1.5	2.0	9.700	7.700	0.000	1.250
HT/FROST INSULATOR		BLD		45.550	48.050	1.5	1.5	2.0	10.82	11.86	0.000	0.720
IRON WORKER		ALL		38.500	39.500	2.0	2.0	2.0	9.390	18.84	0.000	0.700
LABORER		ALL		28.530	29.780	1.5	1.5	2.0	8.240	8.630	0.000	0.800
LABORER, SKILLED		ALL		28.930	30.180	1.5	1.5	2.0	8.240	8.630	0.000	0.800
LATHER		BLD		30.250	32.370	1.5	1.5	2.0	8.900	13.68	0.000	0.570
MACHINIST		BLD		43.550	46.050	1.5	1.5	2.0	6.130	8.950	1.850	0.000
MARBLE FINISHERS		BLD		32.410	0.000	1.5	1.5	2.0	7.700	4.840	0.000	0.530
MARBLE MASON		BLD		35.090	35.340	1.5	1.5	2.0	7.700	7.150	0.000	0.560
MILLWRIGHT		BLD		34.400	37.840	1.5	1.5	2.0	8.770	13.85	0.000	0.500
MILLWRIGHT		HWY		34.120	37.530	1.5	1.5	2.0	8.770	13.85	0.000	0.500
OPERATING ENGINEER	E	BLD	1	43.300	47.300	2.0	2.0	2.0	15.70	10.55	1.900	1.250
OPERATING ENGINEER	E	BLD	2	42.000	47.300	2.0	2.0	2.0	15.70	10.55	1.900	1.250
OPERATING ENGINEER	E	BLD	3	39.450	47.300	2.0	2.0	2.0	15.70	10.55	1.900	1.250
OPERATING ENGINEER	E	BLD	4	37.700	47.300	2.0	2.0	2.0	15.70	10.55	1.900	1.250
OPERATING ENGINEER	E	BLD	5	46.300	47.300	2.0	2.0	2.0	15.70	10.55	1.900	1.250
OPERATING ENGINEER	E	BLD	6	46.300	47.300	2.0	2.0	2.0	15.70	10.55	1.900	1.250
OPERATING ENGINEER	E	BLD	7	44.300	47.300	2.0	2.0	2.0	15.70	10.55	1.900	1.250
OPERATING ENGINEER	E	HWY	1	43.300	47.300	1.5	1.5	2.0	15.70	10.55	1.900	1.250
OPERATING ENGINEER	E	HWY	2	42.750	47.300	1.5	1.5	2.0	15.70	10.55	1.900	1.250
OPERATING ENGINEER	E	HWY	3	40.700	47.300	1.5	1.5	2.0	15.70	10.55	1.900	1.250
OPERATING ENGINEER	E	HWY	4	39.300	47.300	1.5	1.5	2.0	15.70	10.55	1.900	1.250
OPERATING ENGINEER	E	HWY	5	38.100	47.300	1.5	1.5	2.0	15.70	10.55	1.900	1.250
OPERATING ENGINEER	E	HWY	6	46.300	47.300	1.5	1.5	2.0	15.70	10.55	1.900	1.250
OPERATING ENGINEER	E	HWY	7	44.300	47.300	1.5	1.5	2.0	15.70	10.55	1.900	1.250
OPERATING ENGINEER	W	BLD	1	36.000	39.000	1.5	1.5	2.0	9.750	13.60	0.000	3.000
OPERATING ENGINEER	W	BLD	2	33.490	39.000	1.5	1.5	2.0	9.750	13.60	0.000	3.000
OPERATING ENGINEER	W	BLD	3	29.340	39.000	1.5	1.5	2.0	9.750	13.60	0.000	3.000
OPERATING ENGINEER	W	HWY	1	36.000	39.500	1.5	1.5	2.0	9.750	13.60	0.000	3.000
OPERATING ENGINEER	W	HWY	2	33.490	39.500	1.5	1.5	2.0	9.750	13.60	0.000	3.000
OPERATING ENGINEER	W	HWY	3	29.340	39.500	1.5	1.5	2.0	9.750	13.60	0.000	3.000
PAINTER		ALL		32.900	34.900	1.5	1.5	1.5	9.650	8.200	0.000	1.250
PAINTER SIGNS		BLD		33.920	38.090	1.5	1.5	1.5	2.600	2.710	0.000	0.000
PILEDRIVER		BLD		30.500	33.550	1.5	1.5	2.0	8.900	13.68	0.000	0.570
PILEDRIVER		HWY		30.250	32.000	1.5	1.5	2.0	8.830	13.34	0.000	0.500
PIPEFITTER		BLD		45.050	48.050	1.5	1.5	2.0	8.460	14.85	0.000	1.780
PLASTERER		BLD		35.000	36.250	2.0	2.0	2.0	7.700	11.67	0.000	0.500
PLUMBER		BLD		45.000	47.000	1.5	1.5	2.0	12.53	10.06	0.000	0.880
ROOFER		BLD		30.210	32.210	1.5	1.5	2.0	8.280	8.770	0.000	0.430
SHEETMETAL WORKER		BLD		35.360	37.010	1.5	1.5	2.0	8.020	12.70	0.000	0.650
SPRINKLER FITTER		BLD		36.390	39.140	1.5	1.5	2.0	8.420	8.500	0.000	0.450
STONE MASON		BLD		36.720	37.720	1.5	1.5	2.0	8.720	7.950	0.000	0.580
TERRAZZO FINISHER		BLD		32.410	0.000	1.5	1.5	2.0	7.700	4.840	0.000	0.530
TILE LAYER		BLD		30.250	32.370	1.5	1.5	2.0	8.900	13.68	0.000	0.570
TILE MASON		BLD		35.090	35.340	1.5	1.5	2.0	7.700	7.150	0.000	0.560
TRUCK DRIVER		ALL	1	31.230	0.000	1.5	1.5	2.0	10.30	4.840	0.000	0.250
TRUCK DRIVER		ALL	2	31.680	0.000	1.5	1.5	2.0	10.30	4.840	0.000	0.250

TRUCK DRIVER	ALL	3	31.890	0.000	1.5	1.5	2.0	10.30	4.840	0.000	0.250
TRUCK DRIVER	ALL	4	32.180	0.000	1.5	1.5	2.0	10.30	4.840	0.000	0.250
TRUCK DRIVER	ALL	5	33.020	0.000	1.5	1.5	2.0	10.30	4.840	0.000	0.250
TRUCK DRIVER	O&C	1	24.980	0.000	1.5	1.5	2.0	10.30	4.840	0.000	0.250
TRUCK DRIVER	O&C	2	25.340	0.000	1.5	1.5	2.0	10.30	4.840	0.000	0.250
TRUCK DRIVER	O&C	3	25.510	0.000	1.5	1.5	2.0	10.30	4.840	0.000	0.250
TRUCK DRIVER	O&C	4	25.740	0.000	1.5	1.5	2.0	10.30	4.840	0.000	0.250
TRUCK DRIVER	O&C	5	26.420	0.000	1.5	1.5	2.0	10.30	4.840	0.000	0.250
TUCKPOINTER	BLD		36.720	37.720	1.5	1.5	2.0	8.720	7.950	0.000	0.580

Legend :

RG (Region)

TYP (Trade Type - All,Highway,Building,Floating,Oil & Chip,Rivers)

C (Class)

Base (Base Wage Rate)

FRMAN (Foreman Rate)

M-F>8 (OT required for any hour greater than 8 worked each day, Mon through Fri.

OSA (Overtime (OT) is required for every hour worked on Saturday)

OSH (Overtime is required for every hour worked on Sunday and Holidays)

H/W (Health & Welfare Insurance)

Pensn (Pension)

Vac (Vacation)

Trng (Training)

Explanations

PUTNAM COUNTY

OPERATING ENGINEERS (EAST) - That part of the county east of the Illinois River.

The following list is considered as those days for which holiday rates of wages for work performed apply: New Years Day, Memorial Day, Fourth of July, Labor Day, Thanksgiving Day, Christmas Day and Veterans Day in some classifications/counties. Generally, any of these holidays which fall on a Sunday is celebrated on the following Monday. This then makes work performed on that Monday payable at the appropriate overtime rate for holiday pay. Common practice in a given local may alter certain days of celebration. If in doubt, please check with IDOL.

Oil and chip resealing (O&C) means the application of road oils and liquid asphalt to coat an existing road surface, followed by application of aggregate chips or gravel to coated surface, and subsequent rolling of material to seal the surface.

EXPLANATION OF CLASSES

ASBESTOS - GENERAL - removal of asbestos material/mold and hazardous

materials from any place in a building, including mechanical systems where those mechanical systems are to be removed. This includes the removal of asbestos materials/mold and hazardous materials from ductwork or pipes in a building when the building is to be demolished at the time or at some close future date.

ASBESTOS - MECHANICAL - removal of asbestos material from mechanical systems, such as pipes, ducts, and boilers, where the mechanical systems are to remain.

CERAMIC TILE FINISHER, MARBLE FINISHER, TERRAZO FINISHER

Assisting, helping or supporting the tile, marble and terrazzo mechanic by performing their historic and traditional work assignments required to complete the proper installation of the work covered by said crafts. The term "Ceramic" is used for naming the classification only and is in no way a limitation of the product handled. Ceramic takes into consideration most hard tiles.

COMMUNICATIONS TECHNICIAN

Installation, operation, inspection, maintenance, repair and service of radio, television, recording, voice, sound and vision production and reproduction, telephone and telephone interconnect, facsimile, equipment and appliances used for domestic, commercial, educational and entertainment purposes, pulling of wire through conduit but not the installation of conduit.

LABORER, SKILLED - BUILDING AND HIGHWAY

The skilled laborer building (BLD) and heavy & highway (HWY) classification shall encompass the following types of work, irrespective of the site of the work: flagging, caisson worker plus depth, gunnite nozzle men, lead man on sewer work, welders, cutter burners and torchmen, chain saw operator, paving breaker, jackhammer and drill operators, layout man and/or drainage tile layer, steel form setter - street and highway, air tamping hammerman, signal man on crane, concrete saw operator, concrete saw operator walk behind, screenman on asphalt pavers, front end man on chip spreader, laborers tending masons with hot material or where foreign materials are used, multiple concrete duct - leadman, luteman, asphalt raker, curb asphalt machine operator, ready mix scalemen (permanent, portable or temporary plant), laborers handling masterplate or similar materials, laser beam operator, coring machine operator, plaster tenders, underpinning and shoring of buildings, material selector when working with fire-brick or castable material, fire watch, signaling of all power equipment, tree topper or trimmer when in connection with construction, and diver tender.

OPERATING ENGINEERS - BUILDING (East)

Class 1. Mechanic; Asphalt Plant; Asphalt Spreader; Autograde; Backhoes w/Caisson attachment; Batch Plant; Benoto (require 2 engineers); Boiler and Throttle Valve; Caisson Rigs; Central Redi-Mix Plant; Combination Back Hoe Front End-Loader Machine; Compressor and Throttle Valve; Concrete Breaker (Truck Mounted); Concrete Conveyor; Concrete Paver over 27E cu. ft.; Concrete Paver 27E cu.ft. and under; Concrete Placer; Concrete Pump (Truck Mounted); Concrete Tower; Cranes, All; Cranes Hammerhead; Creter Crane; Spider Crane; Crusher, Stone, etc.; Derricks, All; Derricks, Traveling; Formless Curb and Gutter Machine; Grader, Elevating; Grouting Machines; Heavy Duty Self-Propelled Transporter or Prime Mover; Highlift Shovels or Front Endloader 2-1/4 yd. and over; Hoists, Elevators, outside type rack and pinion and similar machines; Hoists, One, Two and Three Drum; Hoists,

Two Tugger One Floor; Hydraulic Backhoes; Hydraulic Boom Trucks; Hydro Vac (and similar equipment); Locomotives, All; Lubrication Technician; Manipulators; Motor Patrol; Pile Drivers and Skid Rig; Post Hole Digger; Pre-Stress Machine; Pump Cretes Dual Ram; Squeeze Cretes - Screw Type Pumps; Gypsum Bulker and Pump; Roto Mill Grinder; Scoops - Tractor Drawn; Slip-Form Paver; Straddle Buggies; Operation or Tieback Machine; Tournapull; Tractor with Boom and Side Boom; Trenching Machines.

Class 2. Boilers; Brick Forklift servicing seven (7) or more Brick Masons; Broom, All Power Propelled; Bulldozers; Concrete Mixer (Two Bag and Over); Conveyor, Portable; Forklift Trucks; Highlift Shovels or Front Endloaders under 2-1/4 yd; Hoists, Automatic; Hoists, inside Freight Elevators; Hoists, Sewer Dragging Machine; Hoists, Tugger Single Drum; Hydro Excavating (excluding hose work); Laser Screed; Rock Drill (self-propelled); Non Self-Loading Ejection Dump; Rock Drill (Truck Mounted); Rollers, All; Steam Generators; Tractors, All; Tractor Drawn Vibratory Roller; Winch Trucks with "A" Frame.

Class 3. Air Compressors; Combination - Small Equipment Operator; Generators; Heaters, Mechanical; Hoists, Inside Elevators - (Rheostat Manual Controlled); Hoists, Inside Elevators; Hydraulic Power Units (Pile Driving and Extracting); Lowboys; Pumps, over 3" (1 to 3 not to exceed a total of 300 ft.); Pumps, Well Points; Welding Machines (2 through 5); Winches, 4 Small Electric Drill Winches.

Class 4. Brick Forklift; Boom Trucks (Residential); Hoists, Inside Elevators push button with automatic doors; Oilers; Skidsteer Loaders; Vacuum Trucks (excluding hose work).

Class 5. Assistant Craft Foreman

Class 6. Mechanics and Welders

Class 7. Gradall

OPERATING ENGINEERS - HIGHWAY CONSTRUCTION (East)

Class 1. Asphalt Plant; Asphalt Heater and Planer Combination; Asphalt Heater Scarfire; Asphalt Spreader; Autograder/Gomaco or other similar type machines: ABG Paver; Backhoes with Caisson Attachment; Belt Loader; Caisson Rigs; Car Dumper; Central Redi-Mix Plant; Combination Backhoe Front Endloader Machine; Concrete Breaker (Truck Mounted); Concrete Conveyor; Concrete Paver over 27E cu. ft.; Concrete Placer; Concrete Tube Float; Cranes, all attachments; Cranes, Tower of all types; Creter Crane; Spider Crane; Crusher, Stone, etc.; Derricks, All; Derrick Boats; Derricks, Traveling; Dredges; Elevators, Outside Type Rack & Pinion and Similar Machines; Formless Curb and Gutter Machine; Grader, Elevating; Grader, Motor Grader, Motor Patrol, Auto Patrol, Form Grader, Pull Grader, Subgrader; Guard Rail Post Driver Truck Mounted; Heavy Duty Self-Propelled Transporter or Prime Mover; Hoists, One, Two and Three Drum; Hydraulic Backhoes; Locomotives, All; Backhoes with Shear Attachments; Lubrication Technician; Manipulators; Mucking Machine; Pile Drivers and Skid Rig; Pre-Stress Machine; Pump Cretes Dual Ram; Rock Drill-Crawler or Skid Rig; Rock Drill - Truck Mounted; Roto Mill Grinder; Slip-Form Paver; Snow Melters; Soil Test Drill Rig (Truck Mounted); Straddle Buggies; Hydraulic Telescoping Form (Tunnel); Operation of Tieback Machine; Tractor Drawn Belt Loader; Tractor Drawn Belt Loader with attached pusher; Tractor with Boom; Tractaire with Attachments; Transfer Barrier Transfer Machine; Trenching Machine; Truck Mounted Concrete Pump with Boom; Raised or Blind Hole Drills (Tunnel Shaft); Underground Boring and/or Mining Machine; Wheel Excavator; Widener (APSCO).

Class 2. Batch Plant; Bituminous Mixer; Boiler and Throttle Valve; Bulldozers; Car Loader Trailing Conveyors; Combination Backhoe Front Endloader Machine (less than 1 cu. yd. Backhoe Bucket or over or with attachments); Compressor and Throttle Valve; Compressor, Common Receiver (3); Concrete Breaker or Hydro Hammer; Concrete Grinding Machine; Concrete Mixer or Paver 7S Series to and including 27 cu. ft.; Concrete Spreader; Concrete Curing Machine, Burlap Machine, Belting Machine and Sealing Machine; Concrete Wheel Saw; Conveyor Muck Cars (Haglund or Similar Type); Drills, All; Finishing Machine - Concrete; Forklifts; Highlift Shovels or Front Endloader; Hoist - Sewer Dragging Machine; Hydraulic Boom Trucks (All Attachments); Hydro-Blaster (requires 2 operators; one being Class 4); Hydro Excavating (excluding hose work); Laser Screed; Locomotives, Dinky; Oil Distributor; Off-Road Hauling Units (Including Articulating); Non Self-Loading Ejection Dump; Pump Cretes; Squeeze Cretes - Screw Type Pumps, Gypsum Bulker and Pump; Roller, Asphalt; Rotary Snow Plows; Rototiller, Seaman, etc., Self-Propelled; Self-Propelled Compactor; Spreader - Chip - Stone, etc.; Scraper; Scraper - Prime Mover in Tandem; Tractors, Push, Pulling Sheeps Foot, Disc, Compactor, etc.; Tug Boats; Mechanic Welders working in permanent shop.

Class 3. Boilers; Brooms, All Power Propelled; Cement Supply Tender; Compressor, Common Receiver (2); Concrete Mixer (Two Bag and Over); Conveyor, Portable; Farm-Type Tractors Used for Mowing, Seeding, etc.; Grouting Machine; Hoists, Automatic; Hoists, All Elevators; Hoists, Tugger Single Drum; Jeep Diggers; Low Boys; Pipe Jacking Machine; Post-Hole Digger; Power Saw, Concrete Power Driven; Pug Mills; Rollers, other than asphalt; Seed and Straw Blower; Steam Generators; Stump Machine Heaters, Mechanical; Winch Trucks with "A" Frame; Work Boats; Tamper - Form - Motor Driven.

Class 4. Air Compressor; Brick Forklifts (Servicing Seven (7) or more Brick Masons; Combination - Small Equipment Operator; Directional Boring Machine; Generators; Heaters, Mechanical; Hydraulic Power Unit (Pile Driving, Extracting, or Drilling); Hydro-Blaster (requires 2 operators - one being class 2); Light Plants, All (1 through 5); Pumps, over 3" (1 to 3 not to exceed a total of 300 ft.); Pumps, Well Points; Tractaire; Vacuum Trucks (excluding hose work); Welding Machines (2 through 5); Winches, 4 Small Electric Drill Winches.

Class 5. Brick Forklifts; Oilers; Skidsteer Loaders (All).

Class 6. Field Mechanics and Field Welders.

Class 7. Dowell Machine with Air Compressor; Gradall and machines of like nature.

OPERATING ENGINEERS - BUILDING - (West)

Class 1. Cranes; Overhead Cranes; Gradall; All Cherry Pickers; Mechanics; Central Concrete Mixing Plant Operator; Road Pavers (27E - Dual Drum - Tri Batchers); Blacktop Plant Operators and Plant Engineers; 3 Drum Hoist; Derricks; Hydro Cranes; Shovels; Skimmer Scoops; Koehring Scooper; Drag Lines; Backhoe; Derrick Boats; Pile Drivers and Skid Rigs; Clamshells; Locomotive Cranes; Dredge (all types) Motor Patrol; Power Blades - Dumore - Elevating and similar types; Tower Cranes (Crawler-Mobile) and Stationary; Crane-type Backfiller; Drott Yumbo and similar types considered as Cranes; Caisson Rigs; Dozer; Tournadozer; Work Boats; Ross Carrier; Helicopter; Tournapulls - all and similar types; Scoops (all sizes); Pushcats; Endloaders (all types); Asphalt Surfacing Machine; Slip Form Paver; Rock Crusher; Heavy Equipment Greaser; CMI, CMI Belt Placer, Auto Grade & 3 Track and similar types; Side Booms; Multiple Unit

Earth Movers; Creter Crane; Trench Machine; Pump-crete-Belt
Crete-Squeeze Cretes-Screw-type Pumps and Gypsum; Bulker & Pump -
Operator will clean; Formless Finishing Machine; Flaherty Spreader or
similar types; Screed Man on Laydown Machine; Wheel Tractors
(industrial or Farm-type w/Dozer-Hoe-Endloader or other attachments);
F.W.D. & Similar Types; Vermeer Concrete Saw.

Class 2. Dinkeys; Power Launches; PH One-pass Soil Cement Machine
(and similar types); Pugmill with Pump; Backfillers; Euclid Loader;
Forklifts; Jeeps w/Ditching Machine or other attachments; Tuneluger;
Automatic Cement and Gravel Batching Plants; Mobile Drills (Soil
Testing) and similar types; Gurries and Similar Types; (1) and (2)
Drum Hoists (Buck Hoist and Similar Types); Chicago Boom; Boring
Machine & Pipe Jacking Machine; Hydro Boom; Dewatering System; Straw
Blower; Hydro Seeder; Assistant Heavy Equipment Greaser on Spread;
Tractors (Track type) without Power Unit pulling Rollers; Rollers on
Asphalt -- Brick Macadem; Concrete Breakers; Concrete Spreaders; Mule
Pulling Rollers; Center Stripper; Cement Finishing Machines & CMI
Texture & Reel Curing Machines; Cement Finishing Machine; Barber
Green or similar loaders; Vibro Tamper (All similar types)
Self-propelled; Winch or Boom Truck; Mechanical Bull Floats; Mixers
over 3 Bag to 27E; Tractor pulling Power Blade or Elevating Grader;
Porter Rex Rail; Clary Screed; Truck Type Hoptoe Oilers; Fireman;
Spray Machine on Paving; Curb Machines; Truck Crane Oilers; Oil
Distributor; Truck-Mounted Saws.

Class 3. Air Compressor; Power Subgrader; Straight Tractor; Trac Air
without attachments; Herman Nelson Heater, Dravo, Warner, Silent Glo,
and similar types; Roller: Five (5) Ton and under on Earth or
Gravel; Form Grader; Crawler Crane & Skid Rig Oilers; Freight
Elevators - permanently installed; Pump; Light Plant; Generator;
Conveyor (1) or (2) - Operator will clean; Welding Machine; Mixer (3)
Bag and Under (Standard Capacity with skip); Bulk Cement Plant; Oiler
on Central Concrete Mixing Plant.

OPERATING ENGINEERS - HEAVY AND HIGHWAY CONSTRUCTION - (West)

CLASS 1. Cranes; Hydro Cranes; Shovels; Crane Type Backfiller; Tower,
Mobile, Crawler, & Stationary Cranes; Derricks; Hoists (3 Drum);
Draglines; Drott Yumbo & Similar Types considered as Cranes; 360
Degree Swing Excavator (Shears, Grapples, Movacs, etc.); Back Hoe;
Derrick Boats; Pile Driver and Skid Rigs; Clam Shell; Locomotive -
Cranes; Road Pavers - Single Drum - Dual Drum - Tri Batcher; Motor
Patrols & Power Blades - Dumore - Elevating & Similar Types;
Mechanics; Central Concrete Mixing Plant Operator; Asphalt Batch Plant
Operators and Plant Engineers; Gradall; Caisson Rigs; Skimmer Scoop -
Koering Scooper; Dredges (all types); Hoptoe; All Cherry Pickers;
Work Boat; Ross Carrier; Helicopter; Dozer; Tournadozer; Tournapulls -
all and similar types; Operation of Concrete and all Recycle
Machines; Multiple Unit Earth Movers; Scoops (all sizes); Pushcats;
Endloaders (all types); Asphalt Surfacing Machine; Slip Form Paver;
Rock Crusher; Operation of Material Crusher, Screening Plants, and
Tunnel Boring Machine; Heavy Equipment Greaser (top greaser on
spread); CMI, Auto Grade, CMI Belt Placer & 3 Track and Similar Types;
Side Booms; Asphalt Heater & Planer Combination (used to plane
streets); Wheel Tractors (with Dozer, Hoe or Endloader Attachments);
CAT Earthwork Compactors and Similar Types; Blaw Knox Spreader and
Similar Types; Trench Machines; Pump Crete - Belt Crete - Squeeze
Crete - Screw Type Pumps and Gypsum (operator will clean); Creter
Crane; Operation of Concrete Pump Truck; Formless Finishing Machines;
Flaherty Spreader or Similar Types; Screed Man on Laydown Machine;
Vermeer Concrete Saw; Operation of Laser Screed; Span Saw; Dredge
Leverman; Dredge Engineer; Lull or Similar Type; Hydro-Boom Truck;
Operation of Guard Rail Machine; and Starting Engineer on Pipeline or
Construction (11 or more pieces) including: Air Compressor (Trailer

Mounted), All Forced Air Heaters (regardless of Size), Water Pumps (Greater than 4-1/2" or Total Discharge Over 4-1/2"), Light Plants, Generators (Trailer Mounted - Excluding Decontamination Trailer), Welding Machines (Any Size or Mode of Power), Conveyor, Mixer (any size), Stud Welder, Power Pac, etc, and Ground Heater (Trailer Mounted).

CLASS 2. Bulker & Pump; Power Launches; Boring Machine & Pipe Jacking Machine; Dinkeys; Operation of Carts, Powered Haul Unit for a Boring Machine; P & H One Pass Soil Cement Machines and Similar Types; Wheel Tractors (Industry or Farm Type - Other); Back Fillers; Euclid Loader; Fork Lifts; Jeep w/Ditching Machine or Other Attachments; Tunneluger; Automatic Cement & Gravel Batching Plants; Mobile Drills - Soil Testing and Similar Types; Pugmill with Pump; All (1) and (2) Drum Hoists; Dewatering System; Straw Blower; Hydro-Seeder; Bump Grinders (self-propelled); Assistant Heavy Equipment Greaser; Apsco Spreader; Tractors (Track-Type) without Power Units Pulling Rollers; Rollers on Asphalt - Brick or Macadam; Concrete Breakers; Concrete Spreaders; Cement Strippers; Cement Finishing Machines & CMI Texture & Reel Curing Machines; Vibro-Tampers (All Similar Types Self-Propelled); Mechanical Bull Floats; Self-Propelled Concrete Saws; Truck Mounted Power Saws; Operation of Curb Cutters; Mixers - Over Three (3) Bags; Winch and Boom Trucks; Tractor Pulling Power Blade or Elevating Grader; Porter Rex Rail; Clary Screed; Mule Pulling Rollers; Pugmill without Pump; Barber Greene or Similar Loaders; Track Type Tractor w/Power Unit attached (minimum); Fireman; Spray Machine on Paving; Curb Machines; Paved Ditch Machine; Power Broom; Self-Propelled Sweepers; Self-Propelled Conveyors; Power Subgrader; Oil Distributor; Straight Tractor; Truck Crane Oiler; Truck Type Oilers; Directional Boring Machine; Horizontal Directional Drill; Articulating End Dump Vehicles; Starting Engineer on Pipeline or Construction (6 -10 pieces) including: Air Compressor (Trailer Mounted), All Forced Air Heaters (regardless of Size), Water Pumps (Greater than 4-1/2" or Total Discharge Over 4-1/2"), Light Plants, Generators (Trailer Mounted - Excluding Decontamination Trailer), Welding Machines (Any Size or Mode of Power), Conveyor, Mixer (any size), Stud Welder, Power Pac, etc., and Ground Heater (Trailer Mounted).

CLASS 3. Straight Framed Truck Mounted Vac Unit (separately powered); Trac Air Machine (without attachments); Rollers - Five Ton and Under on Earth and Gravel; Form Graders; Bulk Cement Plant; Oilers; and Starting Engineer on Pipeline or Construction (3 - 5 pieces) including: Air Compressor (Trailer Mounted), All Forced Air Heaters (regardless of Size), Water Pumps (Greater than 4-1/2" or Total Discharge Over 4-1/2"), Light Plants, Generators (Trailer Mounted - Excluding Decontamination Trailer), Welding Machines (Any Size or Mode of Power), Conveyor, Mixer (any size), Stud Welder, Power Pac, etc., and Ground Heater (Trailer Mounted).

TRUCK DRIVER - BUILDING, HEAVY AND HIGHWAY CONSTRUCTION

Class 1. Drivers on 2 axle trucks hauling less than 9 ton. Air compressor and welding machines and brooms, including those pulled by separate units, truck driver helpers, warehouse employees, mechanic helpers, greasers and tiremen, pickup trucks when hauling materials, tools, or workers to and from and on-the-job site, and fork lifts up to 6,000 lb. capacity.

Class 2. Two or three axle trucks hauling more than 9 ton but hauling less than 16 ton. A-frame winch trucks, hydrolift trucks, vactor trucks or similar equipment when used for transportation purposes. Fork lifts over 6,000 lb. capacity, winch trucks, four axle combination units, and ticket writers.

Class 3. Two, three or four axle trucks hauling 16 ton or more.

Drivers on water pulls, articulated dump trucks, mechanics and working forepersons, and dispatchers. Five axle or more combination units.

Class 4. Low Boy and Oil Distributors.

Class 5. Drivers who require special protective clothing while employed on hazardous waste work.

TRUCK DRIVER - OIL AND CHIP RESEALING ONLY.

This shall encompass laborers, workers and mechanics who drive contractor or subcontractor owned, leased, or hired pickup, dump, service, or oil distributor trucks. The work includes transporting materials and equipment (including but not limited to, oils, aggregate supplies, parts, machinery and tools) to or from the job site; distributing oil or liquid asphalt and aggregate; stock piling material when in connection with the actual oil and chip contract. The Truck Driver (Oil & Chip Resealing) wage classification does not include supplier delivered materials.

Other Classifications of Work:

For definitions of classifications not otherwise set out, the Department generally has on file such definitions which are available. If a task to be performed is not subject to one of the classifications of pay set out, the Department will upon being contacted state which neighboring county has such a classification and provide such rate, such rate being deemed to exist by reference in this document. If no neighboring county rate applies to the task, the Department shall undertake a special determination, such special determination being then deemed to have existed under this determination. If a project requires these, or any classification not listed, please contact IDOL at 217-782-1710 for wage rates or clarifications.

LANDSCAPING

Landscaping work falls under the existing classifications for laborer, operating engineer and truck driver. The work performed by landscape plantsman and landscape laborer is covered by the existing classification of laborer. The work performed by landscape operators (regardless of equipment used or its size) is covered by the classifications of operating engineer. The work performed by landscape truck drivers (regardless of size of truck driven) is covered by the classifications of truck driver.

Randolph County Prevailing Wage for May 2013

(See explanation of column headings at bottom of wages)

Trade Name	RG	TYP	C	Base	FRMAN	M-F>8	OSA	OSH	H/W	Pensn	Vac	Trng
=====	==	===	=	=====	=====	=====	===	===	=====	=====	=====	=====
ASBESTOS ABT-GEN		ALL		28.120	28.620	1.5	1.5	2.0	5.750	12.58	0.000	0.800
ASBESTOS ABT-MEC		BLD		29.860	30.860	1.5	1.5	2.0	6.950	3.000	0.000	0.000
BOILERMAKER		BLD		31.500	34.000	1.5	1.5	2.0	7.070	18.73	1.000	0.350
BRICK MASON		BLD		28.620	30.120	1.5	1.5	2.0	8.200	7.030	0.000	0.430
CARPENTER		ALL		34.630	36.130	1.5	1.5	2.0	6.550	6.750	0.000	0.400
CEMENT MASON		BLD		28.200	29.700	1.5	1.5	2.0	6.600	5.400	0.000	0.500
CEMENT MASON		HWY		27.290	28.290	1.5	1.5	2.0	6.600	5.160	0.000	0.400

CERAMIC TILE FNSHER	BLD		27.120	0.000	1.5	1.5	2.0	8.200	7.030	0.000	0.430	
ELECTRIC PWR EQMT OP	NW	ALL	36.870	0.000	1.5	1.5	2.0	6.790	10.32	0.000	0.270	
ELECTRIC PWR EQMT OP	SE	ALL	1	35.570	0.000	1.5	1.5	2.0	5.000	9.960	0.000	0.360
ELECTRIC PWR EQMT OP	SE	ALL	2	31.740	0.000	1.5	1.5	2.0	5.000	8.880	0.000	0.320
ELECTRIC PWR GRNDMAN	NW	ALL		27.530	0.000	1.5	1.5	2.0	5.070	7.710	0.000	0.210
ELECTRIC PWR GRNDMAN	SE	ALL		26.100	0.000	1.5	1.5	2.0	5.000	7.310	0.000	0.260
ELECTRIC PWR LINEMAN	NW	ALL		42.400	44.450	1.5	1.5	2.0	7.810	11.87	0.000	0.320
ELECTRIC PWR LINEMAN	SE	ALL		44.630	47.650	1.5	1.5	2.0	5.000	12.50	0.000	0.450
ELECTRIC PWR TRK DRV	NW	ALL		30.100	0.000	1.5	1.5	2.0	5.540	8.430	0.000	0.230
ELECTRICIAN	NW	ALL		36.510	38.700	1.5	1.5	2.0	7.810	7.490	0.000	0.640
ELECTRICIAN	SE	ALL		39.350	41.600	1.5	1.5	2.0	6.140	9.440	0.000	0.790
ELECTRONIC SYS TECH	NW	BLD		30.720	32.470	1.5	1.5	2.0	3.650	7.920	0.000	0.400
ELECTRONIC SYS TECH	SE	BLD		32.570	34.320	1.5	1.5	2.0	6.000	4.240	0.000	0.400
ELEVATOR CONSTRUCTOR		BLD		43.715	49.180	2.0	2.0	2.0	11.88	12.71	3.500	0.600
FLOOR LAYER		BLD		29.330	30.080	1.5	1.5	2.0	6.550	6.750	0.000	0.400
GLAZIER		BLD		32.780	0.000	2.0	2.0	2.0	9.020	10.80	2.630	0.310
HT/FROST INSULATOR		BLD		37.260	38.260	1.5	1.5	2.0	7.850	11.16	0.000	0.500
IRON WORKER		ALL		31.500	33.500	1.5	1.5	2.0	7.610	13.33	0.000	0.420
LABORER		ALL		27.620	28.120	1.5	1.5	2.0	5.750	12.58	0.000	0.800
MACHINIST		BLD		43.550	46.050	1.5	1.5	2.0	6.130	8.950	1.850	0.000
MARBLE FINISHERS		BLD		27.120	0.000	1.5	1.5	2.0	8.200	7.030	0.000	0.430
MARBLE MASON		BLD		28.620	30.120	1.5	1.5	2.0	8.200	7.030	0.000	0.430
MILLWRIGHT		ALL		34.630	36.130	1.5	1.5	2.0	6.550	6.750	0.000	0.400
OPERATING ENGINEER		BLD	1	34.200	37.200	1.5	1.5	2.0	9.000	17.00	0.000	1.000
OPERATING ENGINEER		BLD	2	33.070	37.200	1.5	1.5	2.0	9.000	17.00	0.000	1.000
OPERATING ENGINEER		BLD	3	28.590	37.200	1.5	1.5	2.0	9.000	17.00	0.000	1.000
OPERATING ENGINEER		BLD	4	28.650	37.200	1.5	1.5	2.0	9.000	17.00	0.000	1.000
OPERATING ENGINEER		BLD	5	28.320	37.200	1.5	1.5	2.0	9.000	17.00	0.000	1.000
OPERATING ENGINEER		BLD	6	35.750	37.200	1.5	1.5	2.0	9.000	17.00	0.000	1.000
OPERATING ENGINEER		BLD	7	36.050	37.200	1.5	1.5	2.0	9.000	17.00	0.000	1.000
OPERATING ENGINEER		BLD	8	36.330	37.200	1.5	1.5	2.0	9.000	17.00	0.000	1.000
OPERATING ENGINEER		BLD	9	35.650	37.200	1.5	1.5	2.0	9.000	17.00	0.000	1.000
OPERATING ENGINEER		HWY	1	32.700	35.700	1.5	1.5	2.0	9.000	17.00	0.000	1.000
OPERATING ENGINEER		HWY	2	31.570	35.700	1.5	1.5	2.0	9.000	17.00	0.000	1.000
OPERATING ENGINEER		HWY	3	27.090	35.700	1.5	1.5	2.0	9.000	17.00	0.000	1.000
OPERATING ENGINEER		HWY	4	27.150	35.700	1.5	1.5	2.0	9.000	17.00	0.000	1.000
OPERATING ENGINEER		HWY	5	26.820	35.700	1.5	1.5	2.0	9.000	17.00	0.000	1.000
OPERATING ENGINEER		HWY	6	34.250	35.700	1.5	1.5	2.0	9.000	17.00	0.000	1.000
OPERATING ENGINEER		HWY	7	34.550	35.700	1.5	1.5	2.0	9.000	17.00	0.000	1.000
OPERATING ENGINEER		HWY	8	34.830	35.700	1.5	1.5	2.0	9.000	17.00	0.000	1.000
OPERATING ENGINEER		HWY	9	34.150	35.700	1.5	1.5	2.0	9.000	17.00	0.000	1.000
PAINTER		BLD		26.260	27.760	1.5	1.5	2.0	6.630	7.070	0.000	0.500
PAINTER		HWY		30.560	32.060	1.5	1.5	2.0	6.630	7.070	0.000	0.500
PAINTER OVER 30FT		BLD		27.260	28.760	1.5	1.5	2.0	6.630	7.070	0.000	0.500
PAINTER PWR EQMT		BLD		27.260	28.760	1.5	1.5	2.0	6.630	7.070	0.000	0.500
PAINTER PWR EQMT		HWY		31.560	33.060	1.5	1.5	2.0	6.630	7.070	0.000	0.500
PILEDRIVER		ALL		34.630	36.130	1.5	1.5	2.0	6.550	6.750	0.000	0.400
PIPEFITTER	N	BLD		36.000	38.500	1.5	1.5	2.0	7.750	5.500	0.000	0.575
PIPEFITTER	SE	BLD		41.470	45.620	1.5	2.0	2.0	8.450	5.780	0.000	1.250
PIPEFITTER	W	BLD		37.250	39.250	1.5	1.5	2.0	6.740	8.000	0.000	0.750
PLASTERER		BLD		28.200	29.700	1.5	1.5	2.0	6.600	5.400	0.000	0.500
PLUMBER	N	BLD		36.000	38.500	1.5	1.5	2.0	7.750	5.500	0.000	0.575
PLUMBER	SE	BLD		41.470	45.620	1.5	2.0	2.0	8.450	5.780	0.000	1.250
PLUMBER	W	BLD		36.300	38.800	1.5	1.5	2.0	6.250	6.850	0.000	0.500
ROOFER		BLD		29.500	31.500	1.5	1.5	2.0	8.600	6.850	0.000	0.200
SHEETMETAL WORKER		ALL		31.690	33.190	1.5	1.5	2.0	7.130	6.730	1.910	0.360
SPRINKLER FITTER		BLD		38.780	41.780	2.0	2.0	2.0	8.370	11.18	0.000	1.000
STONE MASON		BLD		28.620	30.120	1.5	1.5	2.0	8.200	7.030	0.000	0.430
TERRAZZO FINISHER		BLD		27.120	0.000	1.5	1.5	2.0	8.200	7.030	0.000	0.430
TERRAZZO MASON		BLD		28.620	30.120	1.5	1.5	2.0	8.200	7.030	0.000	0.430
TRUCK DRIVER		ALL	1	31.340	0.000	1.5	1.5	2.0	10.30	5.010	0.000	0.250
TRUCK DRIVER		ALL	2	31.780	0.000	1.5	1.5	2.0	10.30	5.010	0.000	0.250
TRUCK DRIVER		ALL	3	32.020	0.000	1.5	1.5	2.0	10.30	5.010	0.000	0.250
TRUCK DRIVER		ALL	4	32.280	0.000	1.5	1.5	2.0	10.30	5.010	0.000	0.250
TRUCK DRIVER		ALL	5	33.130	0.000	1.5	1.5	2.0	10.30	5.010	0.000	0.250

TRUCK DRIVER	O&C 1	25.070	0.000	1.5	1.5	2.0	10.30	5.010	0.000	0.250
TRUCK DRIVER	O&C 2	25.420	0.000	1.5	1.5	2.0	10.30	5.010	0.000	0.250
TRUCK DRIVER	O&C 3	25.620	0.000	1.5	1.5	2.0	10.30	5.010	0.000	0.250
TRUCK DRIVER	O&C 4	25.820	0.000	1.5	1.5	2.0	10.30	5.010	0.000	0.250
TRUCK DRIVER	O&C 5	26.500	0.000	1.5	1.5	2.0	10.30	5.010	0.000	0.250
TUCK POINTER	BLD	28.620	30.120	1.5	1.5	2.0	8.200	7.030	0.000	0.430

Legend:

RG (Region)

TYP (Trade Type - All,Highway,Building,Floating,Oil & Chip,Rivers)

C (Class)

Base (Base Wage Rate)

FRMAN (Foreman Rate)

M-F>8 (OT required for any hour greater than 8 worked each day, Mon through Fri.)

OSA (Overtime (OT) is required for every hour worked on Saturday)

OSH (Overtime is required for every hour worked on Sunday and Holidays)

H/W (Health & Welfare Insurance)

Pensn (Pension)

Vac (Vacation)

Trng (Training)

Explanations

RANDOLPH COUNTY

ELECTRICIANS AND ELECTRONIC SYSTEMS TECHNICIAN (NORTHWEST) - Township of Red Bud.

PLUMBERS & PIPEFITTERS (NORTH) - Towns of Red Bud, Prairie, and Ruma.

PLUMBERS & PIPEFITTERS (SOUTHEAST) - That part of the county East of a line between Ste. Genevieve, Mo. and Rt. 155 then south of a diagonal line to the North-East corner of the county.

PLUMBERS & PIPEFITTERS (WEST) - Towns of Roots, Kellog, Modoc and Prairie DuRocher.

The following list is considered as those days for which holiday rates of wages for work performed apply: New Years Day, Memorial Day, Fourth of July, Labor Day, Thanksgiving Day, Christmas Day and Veterans Day in some classifications/counties. Generally, any of these holidays which fall on a Sunday is celebrated on the following Monday. This then makes work performed on that Monday payable at the appropriate overtime rate for holiday pay. Common practice in a given local may alter certain days of celebration. If in doubt, please check with IDOL.

Oil and chip resealing (O&C) means the application of road oils and liquid asphalt to coat an existing road surface, followed by

application of aggregate chips or gravel to coated surface, and subsequent rolling of material to seal the surface.

EXPLANATION OF CLASSES

ASBESTOS - GENERAL - removal of asbestos material/mold and hazardous materials from any place in a building, including mechanical systems where those mechanical systems are to be removed. This includes the removal of asbestos materials/mold and hazardous materials from ductwork or pipes in a building when the building is to be demolished at the time or at some close future date.

ASBESTOS - MECHANICAL - removal of asbestos material from mechanical systems, such as pipes, ducts, and boilers, where the mechanical systems are to remain.

CERAMIC TILE FINISHER, MARBLE FINISHER, TERRAZZO FINISHER

Assisting, helping or supporting the tile, marble and terrazzo mechanic by performing their historic and traditional work assignments required to complete the proper installation of the work covered by said crafts. The term "Ceramic" is used for naming the classification only, and is in no a limitation of the product handled. Ceramic takes into consideration most hard tiles.

ELECTRONIC SYSTEMS TECHNICIAN

Installation, service and maintenance of low-voltage systems which utilizes the transmission and/or transference of voice, sound, vision, or digital for commercial, education, security and entertainment purposes for the following: TV monitoring and surveillance, background/foreground music, intercom and telephone interconnect, field programming, inventory control systems, microwave transmission, multi-media, multiplex, radio page, school, intercom and sound burglar alarms and low voltage master clock systems.

Excluded from this classification are energy management systems, life safety systems, supervisory controls and data acquisition systems not intrinsic with the above listed systems, fire alarm systems, nurse call systems and raceways exceeding fifteen feet in length.

OPERATING ENGINEER - BUILDING

GROUP I. Cranes, Dragline, Shovels, Skimmer Scoops, Clamshells or Derrick Boats, Pile Drivers, Crane-Type Backhoes, Asphalt Plant Operators, Concrete Plant Operators, Dredges, Asphalt Spreading Machines, All Locomotives, Cable Ways or Tower Machines, Hoists, Hydraulic Backhoes, Ditching Machines or Backfiller, Cherrypickers, Overhead Cranes, Roller - Steam or Gas, Concrete Pavers, Excavators, Concrete Breakers, Concrete Pumps, Bulk Cement Plants, Cement Pumps, Derrick-Type Drills, Boat Operators, Motor Graders or Pushcats, Scoops or Tournapulls, Bulldozers, Endloaders or Fork Lifts, Power Blade or Elevating Graders, Winch Cats, Boom or Winch Trucks or Boom Tractors, Pipe Wrapping or Painting Machines, Asphalt Plant Engineer, Journeyman Lubricating Engineer, Drills (other than Derrick Type), Mud Jacks, or Well Drilling Machines, Boring Machines or Track Jacks, Mixers, Conveyors (Two), Air Compressors (Two), Water Pumps regardless of size (Two), Welding Machines (Two), Siphons or Jets (Two), Winch Heads or Apparatuses (Two), Light Plants (Two), All Tractors regardless of size (straight tractor only), Fireman on Stationary Boilers, Automatic Elevators, Form Grading Machines, Finishing Machines, Power Sub-Grader or Ribbon Machines, Longitudinal Floats, Distributor Operators on Trucks, Winch Heads or Apparatuses (One), Mobil Track air and heaters (two to five), Heavy Equipment Greaser, Relief Operator, Assistant Master Mechanic and Heavy Duty Mechanic, self-propelled concrete saws of all types and sizes with their attachments, gob-hoppers, excavators

all sizes, the repair and greasing of all diesel hammers, the operation and set-up of bidwells, water blasters of all sizes and their clutches, hydraulic jacks where used for hoisting, operation of log skidders, iceolators used on and off of pipeline, condor cranes, bow boats, survey boats, bobcats and all their attachments, skid steer loaders and all their attachments, creter cranes, batch plants, operator (all sizes), self propelled roto mills, operation of conveyer systems of any size and any configuration, operation, repair and service of all vibratory hammers, all power pacs and their controls regardless of location, curtains or brush burning machines, stump cutter machines, Nail launchers when mounted on a machine or self-propelled, operation of con-cover machines, and all Operators except those listed below).

GROUP II. Assistant Operators.

GROUP III. Air Compressors (One), Water Pumps, regardless of Size (One), Waterblasters (one), Welding Machine (One), Mixers (One Bag), Conveyor (One), Siphon or Jet (One), Light Plant (One), Heater (One), Immobile Track Air (One), and Self Propelled Walk-Behind Rollers.

GROUP IV. Asphalt Spreader Oilers, Fireman on Whirlies and Heavy Equipment Oilers, Truck Cranes, Dredges, Monigans, Large Cranes - (Over 65-ton rated capacity) Concrete Plant Oiler, Blacktop Plant Oiler, and Creter Crane Oiler (when required).

GROUP V. Oiler.

GROUP VI. Operators on equipment with Booms, including jibs, 100 feet and over, and less than 150 feet long.

GROUP VII. Operators on equipment with Booms, including jibs, 150 feet and over, and less than 200 feet long.

GROUP VIII. Operators on Equipment with Booms, including jibs, 200 feet and over; Tower Cranes; and Whirlie Cranes.

GROUP IX. Master Mechanic

OPERATING ENGINEERS - Highway

GROUP I. Cranes, Dragline, Shovels, Skimmer Scoops, Clamshells or Derrick Boats, Pile Drivers, Crane-Type Backhoes, Asphalt Plant Operators, Concrete Plant Operators, Dredges, Asphalt Spreading Machines, All Locomotives, Cable Ways or Tower Machines, Hoists, Hydraulic Backhoes, Ditching Machines or Backfiller, Cherrypickers, Overhead Cranes, Roller - Steam or Gas, Concrete Pavers, Excavators, Concrete Breakers, Concrete Pumps, Bulk Cement Plants, Cement Pumps, Derrick-Type Drills, Boat Operators, Motor Graders or Pushcats, Scoops or Tournapulls, Bulldozers, Endloaders or Fork Lifts, Power Blade or Elevating Graders, Winch Cats, Boom or Winch Trucks or Boom Tractors, Pipe Wrapping or Painting Machines, Asphalt Plant Engineer, Journeyman Lubricating Engineer, Drills (other than Derrick Type), Mud Jacks, Well Drilling Machines, Boring Machines, Track Jacks, Mixers, Conveyors (Two), Air Compressors (Two), Water Pumps regardless of size (Two), Welding Machines (Two), Siphons or Jets (Two), Winch Heads or Apparatuses (Two), Light Plants (Two), All Tractors regardless of size (straight tractor only), Fireman on Stationary Boilers, Automatic Elevators, Form Grading Machines, Finishing Machines, Power Sub-Grader or Ribbon Machines, Longitudinal Floats, Distributor Operators on Trucks, Winch Heads or Apparatuses (One), Mobil Track air and heaters (two to five), Heavy Equipment Greaser, Relief Operator, Assistant Master Mechanic and Heavy Duty Mechanic, self-propelled concrete saws of all types and sizes with their attachments, gob-hoppers, excavators all sizes, the repair and greasing of all diesel hammers, the

operation and set-up of bidwells, water blasters of all sizes and their clutches, hydraulic jacks where used for hoisting, operation of log skidders, iceolators used on and off of pipeline, condor cranes, bow boats, survey boats, bobcats and all their attachments, skid steer loaders and all their attachments, creter cranes, batch plants, operator (all sizes), self propelled roto mills, operation of conveyer systems of any size and any configuration, operation, repair and service of all vibratory hammers, all power pacs and their controls regardless of location, curtains or brush burning machines, stump cutter machines, Nail launchers when mounted on a machine or self-propelled, operation of con-cover machines, and all Operators (except those listed below).

GROUP II. Assistant Operators.

GROUP III. Air Compressors (One), Water Pumps, regardless of Size (One), Waterblasters (one), Welding Machine (One), Mixers (One Bag), Conveyor (One), Siphon or Jet (One), Light Plant (One), Heater (One), Immobile Track Air (One), and Self Propelled Walk-Behind Rollers.

GROUP IV. Asphalt Spreader Oilers, Fireman on Whirlies and Heavy Equipment Oilers, Truck Cranes, Dredges, Monigans, Large Cranes - (Over 65-ton rated capacity) Concrete Plant Oiler, Blacktop Plant Oiler, and Creter Crane Oiler (when required).

GROUP V. Oiler.

GROUP VI. Operators on equipment with Booms, including jibs, 100 feet and over, and less than 150 feet long.

GROUP VII. Operators on equipment with Booms, including jibs, 150 feet and over, and less than 200 feet long.

GROUP VIII. Operators on Equipment with Booms, including jibs, 200 feet and over; Tower Cranes; and Whirlie Cranes.

GROUP IX. Mechanic

TRUCK DRIVER - BUILDING, HEAVY AND HIGHWAY CONSTRUCTION

Class 1. Drivers on 2 axle trucks hauling less than 9 ton. Air compressor and welding machines and brooms, including those pulled by separate units, truck driver helpers, warehouse employees, mechanic helpers, greasers and tiremen, pickup trucks when hauling materials, tools, or workers to and from and on-the-job site, and fork lifts up to 6,000 lb. capacity.

Class 2. Two or three axle trucks hauling more than 9 ton but hauling less than 16 ton. A-frame winch trucks, hydrolift trucks, vactor trucks or similar equipment when used for transportation purposes. Fork lifts over 6,000 lb. capacity, winch trucks, four axle combination units, and ticket writers.

Class 3. Two, three or four axle trucks hauling 16 ton or more. Drivers on water pulls, articulated dump trucks, mechanics and working forepersons, and dispatchers. Five axle or more combination units.

Class 4. Low Boy and Oil Distributors.

Class 5. Drivers who require special protective clothing while employed on hazardous waste work.

TRUCK DRIVER - OIL AND CHIP RESEALING ONLY.

This shall encompass laborers, workers and mechanics who drive contractor or subcontractor owned, leased, or hired pickup, dump, service, or oil distributor trucks. The work includes transporting materials and equipment (including but not limited to, oils, aggregate supplies, parts, machinery and tools) to or from the job site; distributing oil or liquid asphalt and aggregate; stock piling material when in connection with the actual oil and chip contract. The Truck Driver (Oil & Chip Resealing) wage classification does not include supplier delivered materials.

Other Classifications of Work:

For definitions of classifications not otherwise set out, the Department generally has on file such definitions which are available. If a task to be performed is not subject to one of the classifications of pay set out, the Department will upon being contacted state which neighboring county has such a classification and provide such rate, such rate being deemed to exist by reference in this document. If no neighboring county rate applies to the task, the Department shall undertake a special determination, such special determination being then deemed to have existed under this determination. If a project requires these, or any classification not listed, please contact IDOL at 217-782-1710 for wage rates or clarifications.

LANDSCAPING

Landscaping work falls under the existing classifications for laborer, operating engineer and truck driver. The work performed by landscape plantsman and landscape laborer is covered by the existing classification of laborer. The work performed by landscape operators (regardless of equipment used or its size) is covered by the classifications of operating engineer. The work performed by landscape truck drivers (regardless of size of truck driven) is covered by the classifications of truck driver.

Richland County Prevailing Wage for May 2013

(See explanation of column headings at bottom of wages)

Trade Name	RG	TYP	C	Base	FRMAN	M-F>8	OSA	OSH	H/W	Pensn	Vac	Trng
ASBESTOS ABT-GEN	ALL			25.300	25.750	1.5	1.5	2.0	5.750	10.35	0.000	0.900
ASBESTOS ABT-MEC	BLD			21.150	22.150	1.5	1.5	2.0	6.400	5.150	0.000	0.650
BOILERMAKER	BLD			31.500	34.000	1.5	1.5	2.0	7.070	18.73	1.000	0.350
BRICK MASON	BLD			28.620	30.120	1.5	1.5	2.0	8.200	7.030	0.000	0.430
CARPENTER	BLD			31.890	33.390	1.5	1.5	2.0	6.550	6.750	0.000	0.400
CARPENTER	HWY			31.890	33.640	1.5	1.5	2.0	6.550	6.750	0.000	0.400
CEMENT MASON	BLD			28.200	29.700	1.5	1.5	2.0	6.600	5.400	0.000	0.500
CEMENT MASON	HWY			27.080	28.580	1.5	1.5	2.0	6.600	5.800	0.000	0.300
CERAMIC TILE FNSHER	BLD			27.120	0.000	1.5	1.5	2.0	8.200	7.030	0.000	0.430
COMM SYSTEMS TECH	BLD			26.110	28.700	1.5	1.5	2.0	5.350	5.680	0.000	0.290
ELECTRIC PWR EQMT OP	ALL	1		35.570	0.000	1.5	1.5	2.0	5.000	9.960	0.000	0.360
ELECTRIC PWR EQMT OP	ALL	2		31.740	0.000	1.5	1.5	2.0	5.000	8.880	0.000	0.320
ELECTRIC PWR GRNDMAN	ALL			26.100	0.000	1.5	1.5	2.0	5.000	7.310	0.000	0.260
ELECTRIC PWR LINEMAN	ALL			44.630	47.650	1.5	1.5	2.0	5.000	12.50	0.000	0.450
ELECTRICIAN	BLD			34.920	37.360	1.5	1.5	2.0	5.350	9.030	0.000	0.290
FLOOR LAYER	BLD			29.330	30.080	1.5	1.5	2.0	6.550	6.750	0.000	0.400
GLAZIER	BLD			26.780	28.030	1.5	1.5	2.0	6.120	5.200	0.000	0.300
HT/FROST INSULATOR	BLD			29.450	30.450	1.5	1.5	2.0	5.050	9.730	0.000	0.280
IRON WORKER	ALL			27.020	28.270	1.5	1.5	2.0	7.010	9.200	0.000	0.345
LABORER	BLD			25.300	25.750	1.5	1.5	2.0	5.750	10.35	0.000	0.800
LABORER	HWY			25.300	25.750	1.5	1.5	2.0	5.750	10.35	0.000	0.800

MACHINIST	BLD	43.550	46.050	1.5	1.5	2.0	6.130	8.950	1.850	0.000
MARBLE FINISHERS	BLD	27.120	0.000	1.5	1.5	2.0	8.200	7.030	0.000	0.430
MARBLE MASON	BLD	28.620	30.120	1.5	1.5	2.0	8.200	7.030	0.000	0.430
MILLWRIGHT	BLD	31.890	33.390	1.5	1.5	2.0	6.550	6.750	0.000	0.400
MILLWRIGHT	HWY	32.390	34.140	1.5	1.5	2.0	6.550	6.750	0.000	0.400
OPERATING ENGINEER	ALL 1	36.950	0.000	1.5	1.5	2.0	7.250	8.700	0.000	0.800
OPERATING ENGINEER	ALL 2	23.900	0.000	1.5	1.5	2.0	7.250	8.700	0.000	0.800
PAINTER	ALL	26.000	27.500	1.5	1.5	2.0	7.700	8.230	0.000	0.450
PILEDRIVER	BLD	31.890	33.390	1.5	1.5	2.0	6.550	6.750	0.000	0.400
PILEDRIVER	HWY	32.390	34.140	1.5	1.5	2.0	6.550	6.750	0.000	0.400
PIPEFITTER	ALL	35.820	38.510	1.5	1.5	2.0	6.100	6.630	0.000	0.610
PLASTERER	BLD	28.200	29.700	1.5	1.5	2.0	6.600	5.400	0.000	0.500
PLUMBER	ALL	35.820	38.510	1.5	1.5	2.0	6.100	6.630	0.000	0.610
ROOFER	BLD	26.100	28.600	1.5	1.5	2.0	9.600	6.280	0.000	0.550
SHEETMETAL WORKER	ALL	31.690	33.190	1.5	1.5	2.0	7.130	6.730	1.910	0.360
SPRINKLER FITTER	BLD	36.390	39.140	1.5	1.5	2.0	8.420	8.500	0.000	0.450
STONE MASON	BLD	28.620	30.120	1.5	1.5	2.0	8.200	7.030	0.000	0.430
TERRAZZO FINISHER	BLD	27.120	0.000	1.5	1.5	2.0	8.200	7.030	0.000	0.430
TILE MASON	BLD	28.620	30.120	1.5	1.5	2.0	8.200	7.030	0.000	0.430
TRUCK DRIVER	ALL 1	28.955	0.000	1.5	1.5	2.0	9.300	2.900	0.000	0.250
TRUCK DRIVER	ALL 2	29.355	0.000	1.5	1.5	2.0	9.300	2.900	0.000	0.250
TRUCK DRIVER	ALL 3	29.555	0.000	1.5	1.5	2.0	9.300	2.900	0.000	0.250
TRUCK DRIVER	ALL 4	29.805	0.000	1.5	1.5	2.0	9.300	2.900	0.000	0.250
TRUCK DRIVER	ALL 5	30.555	0.000	1.5	1.5	2.0	9.300	2.900	0.000	0.250
TUCKPOINTER	BLD	28.620	30.120	1.5	1.5	2.0	8.200	7.030	0.000	0.430

Legend :

RG (Region)

TYP (Trade Type - All,Highway,Building,Floating,Oil & Chip,Rivers)

C (Class)

Base (Base Wage Rate)

FRMAN (Foreman Rate)

M-F>8 (OT required for any hour greater than 8 worked each day, Mon through Fri.)

OSA (Overtime (OT) is required for every hour worked on Saturday)

OSH (Overtime is required for every hour worked on Sunday and Holidays)

H/W (Health & Welfare Insurance)

Pensn (Pension)

Vac (Vacation)

Trng (Training)

Explanations

RICHLAND COUNTY

The following list is considered as those days for which holiday rates of wages for work performed apply: New Years Day, Memorial Day, Fourth of July, Labor Day, Thanksgiving Day, Christmas Day and Veterans Day in some classifications/counties. Generally, any of these holidays which fall on a Sunday is celebrated on the following

Monday. This then makes work performed on that Monday payable at the appropriate overtime rate for holiday pay. Common practice in a given local may alter certain days of celebration. If in doubt, please check with IDOL.

EXPLANATION OF CLASSES

ASBESTOS - GENERAL - removal of asbestos material/mold and hazardous materials from any place in a building, including mechanical systems where those mechanical systems are to be removed. This includes the removal of asbestos materials/mold and hazardous materials from ductwork or pipes in a building when the building is to be demolished at the time or at some close future date.

ASBESTOS - MECHANICAL - removal of asbestos material from mechanical systems, such as pipes, ducts, and boilers, where the mechanical systems are to remain.

CERAMIC TILE FINISHER, MARBLE FINISHER, TERRAZZO FINISHER

Assisting, helping or supporting the tile, marble and terrazzo mechanic by performing their historic and traditional work assignments required to complete the proper installation of the work covered by said crafts. The term "Ceramic" is used for naming the classification only, and is in no a limitation of the product handled. Ceramic takes into consideration most hard tiles.

COMMUNICATION SYSTEMS TECHNICIAN

Installation, operation, inspection, maintenance, repair, and service of radio, television, recording, voice sound and vision production and reproduction apparatus, equipment and appliances used for domestic, commercial, education, entertainment and private telephone systems.

ELECTRIC POWER LINEMAN

Construction, maintenance and dismantling of overhead and underground electric power lines, including high voltage pipe type cable work, and associated structures and equipment.

ELECTRIC POWER EQUIPMENT OPERATOR - CLASS 1

Operation of all crawler type equipment D-4 and larger from the ground to assist the Electric Power Linemen in performing their duties.

ELECTRIC POWER EQUIPMENT OPERATORS - CLASS 2

Operation of all other equipment from the ground to assist the Electric Power Linemen in performing their duties.

ELECTRIC POWER GROUNDMAN

Applies to workers who assist the Electric Power Lineman from the ground.

TRUCK DRIVER - BUILDING, HEAVY AND HIGHWAY CONSTRUCTION

Class 1. Drivers on 2 axle trucks hauling less than 9 ton. Air compressor and welding machines and brooms, including those pulled by separate units, truck driver helpers, warehouse employees, mechanic helpers, greasers and tiremen, pickup trucks when hauling materials, tools, or workers to and from and on-the-job site, and fork lifts up to 6,000 lb. capacity.

Class 2. Two or three axle trucks hauling more than 9 ton but hauling

less than 16 ton. A-frame winch trucks, hydrolift trucks, vactor trucks or similar equipment when used for transportation purposes. Fork lifts over 6,000 lb. capacity, winch trucks, four axle combination units, and ticket writers.

Class 3. Two, three or four axle trucks hauling 16 ton or more. Drivers on water pulls, articulated dump trucks, mechanics and working forepersons, and dispatchers. Five axle or more combination units.

Class 4. Low Boy and Oil Distributors.

Class 5. Drivers who require special protective clothing while employed on hazardous waste work.

OPERATING ENGINEERS - BUILDING, HEAVY AND HIGHWAY CONSTRUCTION

Class 1. Power Cranes, Draglines, Derricks, Shovels, Gradalls, Mechanics, Tractor Highlift, Tournadozer, Concrete Mixers with Skip, Tournamixer, Two Drum Machine, One Drum Hoist with Tower or Boom, Cableways, Tower Machines, Motor Patrol, Boom Tractor, Boom or Winch Truck, Winch or Hydraulic Boom Truck, Truck Crane, Tournapull, Tractor Operating Scoops, Bulldozer, Push Tractor, Asphalt Planer, Finishing Machine on Asphalt, Large Rollers on Earth, Rollers on Asphalt Mix, Ross Carrier or similar Machine, Gravel Processing Machine, Asphalt Plant Engineer, Paver Operator, Dredging Equipment, or Dredge Engineer, or Dredge Operator, Central Mix Plant Engineer, CMI or similar type machine, Concrete Pump, Truck or Skid Mounted, Tower Crane, Engineer or Rock Crusher Plant, Concrete Plant Engineer, Ditching Machine with dual attachment, Tractor Mounted Loaders, Cherry Picker, Hydro Crane, Standard or Dinkey Locomotives, Scoopmobiles, Euclid Loader, Soil Cement Machine, Back Filler, Elevating Machine, Power Blade, Drilling Machine, including Well Testing, Caissons, Shaft or any similar type drilling machines, Motor Driven Paint Machine, Pipe Cleaning Machine, Pipe Wrapping Machine, Pipe Bending Machine, Apsco Paver, Boring Machine, (Head Equipment Greaser), Barber-Greene Loaders, Formless Paver, (Well Point System), Concrete Spreader, Hydra Ax, Span Saw, Marine Scoops, Brush Mulcher, Brush Burner, Mesh Placer, Tree Mover, Helicopter Crew (3), Piledriver-Skid or Crawler, Stump Remover, Root Rake, Tug Boat Operator, Refrigerating Machine, Freezing Operator, Chair Cart-Self-Propelled, Hydra Seeder, Straw Blower, Power Sub Grader, Bull Float, Finishing Machine, Self-Propelled Pavement Breaker, Lull (or similar type Machine), Two Air Compressors, Compressors hooked in Manifold, Overhead Crane, Chip Spreader, Mud Cat, Sull-Air, Fork Lifts (except when used for landscaping work), Soil Stabilizer (Seaman Tiller, Bo Mag, Rago Gator, and similar types of equipment), Tube Float, Spray Machine, Curing Machine, Concrete or Asphalt Milling Machine, Snooper Truck-Operator, Backhoe, Farm Tractors (with attachments), 4 Point Lift System (Power Lift or similar type), Skid-Steer (Bob Cat or similar type), Wrecking Shears, Water Blaster.

Class 2. Concrete Mixers without Skips, Rock Crusher, Ditching Machine under 6', Curbing Machine, One Drum Machines without Tower or Boom, Air Tugger, Self-Propelled Concrete Saw, Machine Mounted Post Hole Digger, two to four Generators, Water Pumps or Welding Machines, within 400 feet, Air Compressor 600 cu. ft. and under, Rollers on Aggregate and Seal Coat Surfaces, Fork Lift (when used for landscaping work), Concrete and Blacktop Curb Machine, One Water Pump, Oilers, Air Valves or Steam Valves, One Welding Machine, Truck Jack, Mud Jack, Gunnite Machine, House Elevators when used for hoisting material, Engine Tenders, Fireman, Wagon Drill, Flex Plane, Conveyor, Siphons and Pulsometer, Switchman, Fireman on Paint Pots, Fireman on Asphalt Plants, Distributor Operator on Trucks, Tampers, Self-Propelled Power Broom, Striping Machine (motor driven), Form Tamper, Bulk Cement Plant, Equipment Greaser, Deck Hands, Truck Crane Oiler-Driver,

Cement Blimps, Form Grader, Temporary Heat, Throttle Valve, Super Sucker (and similar type of equipment).

Other Classifications of Work:

For definitions of classifications not otherwise set out, the Department generally has on file such definitions which are available. If a task to be performed is not subject to one of the classifications of pay set out, the Department will upon being contacted state which neighboring county has such a classification and provide such rate, such rate being deemed to exist by reference in this document. If no neighboring county rate applies to the task, the Department shall undertake a special determination, such special determination being then deemed to have existed under this determination. If a project requires these, or any classification not listed, please contact IDOL at 217-782-1710 for wage rates or clarifications.

LANDSCAPING

Landscaping work falls under the existing classifications for laborer, operating engineer and truck driver. The work performed by landscape plantsman and landscape laborer is covered by the existing classification of laborer. The work performed by landscape operators (regardless of equipment used or its size) is covered by the classifications of operating engineer. The work performed by landscape truck drivers (regardless of size of truck driven) is covered by the classifications of truck driver.

Rock Island County Prevailing Wage for May 2013

(See explanation of column headings at bottom of wages)

Trade Name	RG	TYP	C	Base	FRMAN	M-F>8	OSA	OSH	H/W	Pensn	Vac	Trng
=====	==	===	=	=====	=====	=====	===	===	=====	=====	=====	=====
ASBESTOS ABT-GEN		BLD		23.440	24.380	1.5	1.5	2.0	6.450	7.060	0.000	0.800
ASBESTOS ABT-GEN		HWY		25.650	26.650	1.5	1.5	2.0	6.450	7.060	0.000	0.800
ASBESTOS ABT-MEC		BLD		20.500	21.500	1.5	1.5	2.0	6.250	3.500	0.000	0.000
BOILERMAKER		BLD		35.010	38.010	2.0	2.0	2.0	7.070	13.83	0.000	0.300
BRICK MASON		BLD		26.500	28.000	1.5	1.5	2.0	8.050	5.430	0.000	0.500
CARPENTER		BLD		26.380	27.700	1.5	1.5	2.0	7.960	8.660	0.000	0.600
CARPENTER		HWY		27.640	29.390	1.5	1.5	2.0	9.080	11.34	0.000	0.450
CEMENT MASON		BLD		25.100	27.100	1.5	1.5	2.0	6.400	8.840	0.000	0.500
CEMENT MASON		HWY		25.460	26.460	1.5	1.5	2.0	6.750	9.640	0.000	0.500
CERAMIC TILE FNSHER		BLD		18.460	0.000	1.5	1.5	2.0	8.050	5.510	0.000	0.240
ELECTRIC PWR EQMT OP		ALL		29.410	0.000	1.5	1.5	2.0	5.590	8.230	0.000	0.290
ELECTRIC PWR GRNDMAN		ALL		24.580	0.000	1.5	1.5	2.0	5.490	6.890	0.000	0.250
ELECTRIC PWR LINEMAN		ALL		37.090	40.800	1.5	1.5	2.0	5.740	10.38	0.000	0.370
ELECTRICIAN		BLD		31.520	33.520	1.5	1.5	2.0	7.320	10.82	0.000	0.310
ELECTRONIC SYS TECH		BLD		23.750	25.500	1.5	1.5	2.0	7.120	5.260	0.000	0.310
ELEVATOR CONSTRUCTOR		BLD		39.380	44.300	2.0	2.0	2.0	11.88	12.71	3.150	0.600
GLAZIER		BLD		26.360	27.860	1.5	1.5	2.0	6.940	6.520	0.000	0.350
HT/FROST INSULATOR		BLD		29.190	30.390	1.5	1.5	2.0	5.420	12.05	0.000	0.900
IRON WORKER		ALL		28.000	30.240	1.5	1.5	2.0	9.390	10.68	0.000	0.620
LABORER		BLD	1	21.940	22.820	1.5	1.5	2.0	6.450	7.060	0.000	0.800
LABORER		BLD	2	23.440	24.380	1.5	1.5	2.0	6.450	7.060	0.000	0.800
LABORER		BLD	3	24.090	25.050	1.5	1.5	2.0	6.450	7.060	0.000	0.800
LABORER		HWY	1	25.150	26.150	1.5	1.5	2.0	6.450	7.060	0.000	0.800
LABORER		HWY	2	25.650	26.650	1.5	1.5	2.0	6.450	7.060	0.000	0.800
LABORER		HWY	3	26.280	27.280	1.5	1.5	2.0	6.450	7.060	0.000	0.800
LATHER		BLD		26.380	27.700	1.5	1.5	2.0	7.960	8.660	0.000	0.600
MACHINIST		BLD		43.550	46.050	1.5	1.5	2.0	6.130	8.950	1.850	0.000
MARBLE FINISHERS		BLD		18.460	0.000	1.5	1.5	2.0	8.050	5.510	0.000	0.240
MARBLE MASON		BLD		22.800	23.300	1.5	1.5	2.0	8.050	5.510	0.000	0.240

MILLWRIGHT	N	BLD	34.400	37.840	1.5	1.5	2.0	8.770	13.85	0.000	0.500
MILLWRIGHT	S	BLD	27.250	28.950	1.5	1.5	2.0	6.700	12.32	0.000	0.500
OPERATING ENGINEER		BLD 1	29.900	31.900	1.5	1.5	2.0	15.40	6.600	1.500	0.850
OPERATING ENGINEER		BLD 2	28.300	31.900	1.5	1.5	2.0	15.40	6.600	1.500	0.850
OPERATING ENGINEER		BLD 3	27.150	31.900	1.5	1.5	2.0	15.40	6.600	1.500	0.850
OPERATING ENGINEER		BLD 4	30.150	31.900	1.5	1.5	2.0	15.40	6.600	1.500	0.850
OPERATING ENGINEER		BLD 5	30.650	31.900	1.5	1.5	2.0	15.40	6.600	1.500	0.850
OPERATING ENGINEER		BLD 6	31.150	31.900	1.5	1.5	2.0	15.40	6.600	1.500	0.850
OPERATING ENGINEER		BLD 7	30.900	31.900	1.5	1.5	2.0	15.40	6.600	1.500	0.850
OPERATING ENGINEER		HWY 1	29.900	31.900	1.5	1.5	2.0	15.40	6.600	1.500	0.850
OPERATING ENGINEER		HWY 2	28.300	31.900	1.5	1.5	2.0	15.40	6.600	1.500	0.850
OPERATING ENGINEER		HWY 3	27.150	31.900	1.5	1.5	2.0	15.40	6.600	1.500	0.850
OPERATING ENGINEER		HWY 4	30.150	31.900	1.5	1.5	2.0	15.40	6.600	1.500	0.850
OPERATING ENGINEER		HWY 5	30.650	31.900	1.5	1.5	2.0	15.40	6.600	1.500	0.850
OPERATING ENGINEER		HWY 6	31.150	31.900	1.5	1.5	2.0	15.40	6.600	1.500	0.850
OPERATING ENGINEER		HWY 7	30.400	31.900	1.5	1.5	2.0	15.40	6.600	1.500	0.850
OPERATING ENGINEER		HWY 8	30.900	31.900	1.5	1.5	2.0	15.40	6.600	1.500	0.850
PAINTER		ALL	27.320	28.320	1.5	1.5	1.5	5.000	6.100	0.000	0.600
PAINTER OVER 30FT		ALL	28.570	29.570	1.5	1.5	1.5	5.000	6.100	0.000	0.600
PAINTER PWR EQMT		ALL	27.820	28.820	1.5	1.5	1.5	5.000	6.100	0.000	0.600
PILEDRIVER		BLD	26.380	27.700	1.5	1.5	2.0	7.960	8.660	0.000	0.600
PILEDRIVER		HWY	27.640	29.390	1.5	1.5	2.0	9.080	11.34	0.000	0.450
PIPEFITTER		ALL	36.550	40.210	1.5	1.5	2.0	5.650	12.15	0.000	1.000
PLASTERER		BLD	27.800	29.800	1.5	1.5	2.0	6.600	6.500	0.000	0.600
PLUMBER		ALL	36.550	40.210	1.5	1.5	2.0	5.650	12.15	0.000	1.000
ROOFER		BLD	25.130	26.380	1.5	1.5	2.0	8.610	5.620	0.000	0.260
SHEETMETAL WORKER		BLD	30.070	32.070	1.5	1.5	2.0	7.140	10.54	0.000	0.540
SPRINKLER FITTER		BLD	36.390	39.140	1.5	1.5	2.0	8.420	8.500	0.000	0.450
STONE MASON		BLD	26.500	28.000	1.5	1.5	2.0	8.050	5.430	0.000	0.500
TERRAZZO FINISHER		BLD	18.460	0.000	1.5	1.5	2.0	8.050	5.510	0.000	0.240
TERRAZZO MASON		BLD	22.800	23.300	1.5	1.5	2.0	8.050	5.510	0.000	0.240
TILE LAYER		BLD	26.380	27.700	1.5	1.5	2.0	7.960	8.660	0.000	0.600
TILE MASON		BLD	22.800	23.300	1.5	1.5	2.0	8.050	5.510	0.000	0.240
TRUCK DRIVER		ALL 1	31.340	0.000	1.5	1.5	2.0	10.30	5.010	0.000	0.250
TRUCK DRIVER		ALL 2	31.780	0.000	1.5	1.5	2.0	10.30	5.010	0.000	0.250
TRUCK DRIVER		ALL 3	32.020	0.000	1.5	1.5	2.0	10.30	5.010	0.000	0.250
TRUCK DRIVER		ALL 4	32.280	0.000	1.5	1.5	2.0	10.30	5.010	0.000	0.250
TRUCK DRIVER		ALL 5	33.130	0.000	1.5	1.5	2.0	10.30	5.010	0.000	0.250
TRUCK DRIVER		O&C 1	25.070	0.000	1.5	1.5	2.0	10.30	5.010	0.000	0.250
TRUCK DRIVER		O&C 2	25.420	0.000	1.5	1.5	2.0	10.30	5.010	0.000	0.250
TRUCK DRIVER		O&C 3	25.620	0.000	1.5	1.5	2.0	10.30	5.010	0.000	0.250
TRUCK DRIVER		O&C 4	25.820	0.000	1.5	1.5	2.0	10.30	5.010	0.000	0.250
TRUCK DRIVER		O&C 5	26.500	0.000	1.5	1.5	2.0	10.30	5.010	0.000	0.250
TUCKPOINTER		BLD	26.500	28.000	1.5	1.5	2.0	8.050	5.430	0.000	0.500

Legend :

RG (Region)

TYP (Trade Type - All,Highway,Building,Floating,Oil & Chip,Rivers)

C (Class)

Base (Base Wage Rate)

FRMAN (Foreman Rate)

M-F>8 (OT required for any hour greater than 8 worked each day, Mon through Fri.)

OSA (Overtime (OT) is required for every hour worked on Saturday)

OSH (Overtime is required for every hour worked on Sunday and Holidays)

H/W (Health & Welfare Insurance)

Pensn (Pension)

Vac (Vacation)

Trng (Training)

Explanations

ROCK ISLAND COUNTY

MILLWRIGHT (SOUTH) - South of Interstate 80.

The following list is considered as those days for which holiday rates of wages for work performed apply: New Years Day, Memorial Day, Fourth of July, Labor Day, Thanksgiving Day, Christmas Day and Veterans Day in some classifications/counties. Generally, any of these holidays which fall on a Sunday is celebrated on the following Monday. This then makes work performed on that Monday payable at the appropriate overtime rate for holiday pay. Common practice in a given local may alter certain days of celebration. If in doubt, please check with IDOL.

Oil and chip resealing (O&C) means the application of road oils and liquid asphalt to coat an existing road surface, followed by application of aggregate chips or gravel to coated surface, and subsequent rolling of material to seal the surface.

EXPLANATION OF CLASSES

ASBESTOS - GENERAL - removal of asbestos material/mold and hazardous materials from any place in a building, including mechanical systems where those mechanical systems are to be removed. This includes the removal of asbestos materials/mold and hazardous materials from ductwork or pipes in a building when the building is to be demolished at the time or at some close future date.

ASBESTOS - MECHANICAL - removal of asbestos material from mechanical systems, such as pipes, ducts, and boilers, where the mechanical systems are to remain.

CERAMIC TILE FINISHER, MARBLE FINISHER, TERRAZZO FINISHER

Assisting, helping or supporting the tile, marble and terrazzo mechanic by performing their historic and traditional work assignments required to complete the proper installation of the work covered by said crafts. The term "Ceramic" is used for naming the classification only and is in no way a limitation of the product handled. Ceramic takes into consideration most hard tiles.

ELECTRONIC SYSTEMS TECHNICIAN

Installing, assembling and maintaining sound and intercom, protection alarm (security), master antenna television, closed circuit television, computer hardware and software programming and installation to the network's outlet and input (EXCLUDING all cabling, power and cable termination work historically performed by wiremen), door monitoring and control, nurse and emergency call programming and installation to the system's outlet and input (EXCLUDING all cabling, power and cable termination work historically performed by wiremen), clock and timing; and the installation and maintenance of transmit and receive antennas, transmitters, receivers, and

associated apparatus which operates in conjunction with the above systems. All work associated with these system installations will be included EXCEPT (1) installation of protective metallic conduit, excluding less than ten-foot runs strictly for protection of cable, and (2) 120 volt AC (or higher) power wiring and associated hardware.

LABORER - BUILDING

Class 1: General laborer, carpenter tender, tool cribman, salamander tender, flagman, form handler, floor sweeper, material handler, fencing laborer, cleaning lumber, landscaper, unloading explosives, laying of sod, planting/removal of trees, wrecking laborer, unloading of Re-Bars, scaffold worker, signal man on crane.

Class 2: Handling of materials treated with creosote, kettle men, prime mover or motorized unit used for wet concrete or handling of building materials, vibrator operator, mortar mixer, power tools used under the jurisdiction of laborers, sand points, gunnite nozzle men, welders, cutters, burners and torchmen, chain saw operator, jackhammer and drill operators, paving breakers, air tamping hammerman, concrete saw operator, concrete burning machine operator, coring machine operator - hod carrier and plasterer tender.

Class 3: Caisson worker after 6 foot depth, dynamite man, asbestos abatement worker, tunnel miners - mixerman (plaster only), pump man.

LABORER - HEAVY & HIGHWAY

Class 1: Rod or chain man, flagman, dumpman, spotter, broom man, landscaper, planting and removal of trees, fencing laborers, dispatcher, ticket writer, scaleman, cleaning of forms or lumber (in bone yard), laying of sod, moving and/or maintenance of flares and barricades.

Class 2: Operation of all hand, electric, air, hydraulic or mechanically powered tools under the jurisdiction of Laborers' including jackhammers, tempers, air spades, augers, concrete saws, chain saws, utility saws, rock drills, vibrators, mortar mixer, power and hand saw (when clearing timber) general laborer (not elsewhere covered), craft-tender, material checker, material handler, form handler, concrete dumper, puddler, form setter helper, explosives handler, dynamite helper, center strip, reinforcing in concrete, wire mesh handler and installer, prime mover or any mechanical device taking the place of concrete buggy or wheelbarrow, sandpoint setter, asphalt kettleman. Sheeting hammer drivers, laying and jointing of telephone conduit, gas distribution men, pipe setter on laterals, drain tiles, culvert pipe, and storm sewer catch basin leads, catch basins, manholes, batch dumpers, tank cleaners, cofferdam workers, bankman on floating plant, jointman with pipelayers. Back-up man (corker, joint maker) with pipe setter on sewer and water mains, batterboard man or laser operator on sewer and water main, labor in ditch, or tunnel, on sewer or water mains and telephone conduit. Cutters, burners, torchman, gravel box man, asphalt plant laborers, concrete plant laborer, deck hand, unloading of steel and rebar, laser beam operator, wrecking laborers.

Class 3: Asphalt raker or luteman, head form setter, head dynamite man (powderman) head string or wireline man (on paving), pipe setter on sewer or water main, gunnite nozzle man, asphalt or concrete curb machine operator, head grade man, head tunnel miner, concrete burning machine operator, coring machine operator, welder.

OPERATING ENGINEERS - BUILDING

Class 1. Shovel; Concrete Spreader; Dipper Dredge Operator; Dipper Dredge Crane man; Dual Purpose Truck (boom, Boom, Winch, etc.);

Mechanic-Welder; Pile Driver; Boom Tractor or Side Boom; Trenching Machine (40 H.P. and over); Building Hoist (1, 2 or 3 drums); Cleaning and Priming Machine; Backfiller (throw bucket); Locomotive Engineer; Concrete Paver; Slip Form Paver; Caisson Augering Machines; Mucking Machine; Asphalt Heater-Planer Unit; Laser Screed; Pug Mill; Concrete Conveyor or Pump; Mechanical loaded Log Chippers or similar machines; Group Equipment Greaser; Off-Road Haul Units; Pipe Bending; Automatic Curbing Machines; Blastholer; Self-Propelled Rotary Drill or similar machines; Work Boat; Combination Concrete Finishing Machine and Float; Asphalt Paver Screed Operator; Forklift (6,000 lb. cap. or over or working heights 28 ft. and above); Chip Spreader; Straddle Carrier; Asphalt Paver; Asphalt Plant Operator; Boring Machine (Directional, Vertical, or Horizontal); Central Redi-Mix Plant Operator; Combination Backhoe Front End loader; Concrete Breaker or Hydro-Hammer (excluding walk-behinds); Concrete Wheel Saw (Large self-propelled - excluding walk-behinds); Crusher (Stone, Concrete, Asphalt, etc.); Curing-Tinning Machine; Excavator; Farm-type Tractor Operating Scoop or Scraper or with Power Attachment; Grader; Motor Grader; Motor Patrol; Auto Grader; Form Grader; Pull Grader; Sub Grader; Elevating Grader; Guard Rail Post Driver; Hoists; Hydraulic Dredge Leverman or Engineer; Hydro-Vac truck mounted or pull type (excluding hose work), and similar equipment; Loader (Track, Rubber Tire, or Articulated); Milling Machine (excluding walk-behinds); Road Widener-Shoulder Spreader; Scraper (Self-Propelled); Self-Propelled Roller or Tire Roller (on asphalt or Blacktop); Sheep Foot or Pad Foot Compactor (excluding walk-behinds); Steel Track-Type Tractor (Dozer, Push Cat, etc.); Transfer or Shuttle Buggy (excluding motorized wheel barrows and Georgia buggies).

Class 2. Asphalt Booster; Fireman and Pump Operator at Asphalt Plant; Mud Jack; Distributor; Self-propelled Roller (other than provided for in Class I); Pump Operator (more than one well-point pump); Trench Machine (under 40 H.P.); Forklift (less than 6,000 lb. cap. or working heights below 28 ft.); Gypsum Pump; Conveyor over 20 H.P.; Light Plant; Boiler (Engineer or Fireman); Mechanical Broom; Driver on Truck Crane or similar machines; Elevator (Permanent inside or Temporary outside); Farm-Type Tractor (without Power Attachment); Grout Pump (excluding hose work).

Class 3. Skid Loader; Oiler; Mechanic's Helper; Mechanical Heater (other than steam boiler); Small Outboard Motor Boat (Safety Boat and Life Boat); Engine Driven Welding Machine; Water Pumps; Air Compressor (400 c.f.m. or over); Deck Engineers.

Class 4. Leadman - Mechanic or Equipment Greaser.

Class 5. Track Excavator with Bucket (4 cubic yard and up to but not including 6 cubic yard).

Class 6. Track Excavator with Bucket (6 cubic yard and over).

Class 7. Crane (Friction or Hydraulic, regardless of size or attachments); Tow or Push Boat.

OPERATING ENGINEERS- HIGHWAY

Class 1. Shovel; Concrete Spreader; Dipper Dredge Operator; Dipper Dredge Crane man; Dual Purpose Truck (Boom, Winch, etc.); Mechanic-Welder; Pile Driver; Boom Tractor or Side Boom; Building Hoist (1, 2 or 3 drums); Cleaning and Priming Machine; Backfiller (throw bucket); Locomotive Engineer; Concrete Paver; Slip Form Paver; Caisson Augering Machines; Mucking Machine; Asphalt Heater Planer Unit; Laser Screed; Pug Mill; Concrete Conveyor or Pump (excluding truck-mounted); Mechanical loaded Log Chippers or similar machines; Group Equipment Greaser; off-road haul units; Pipe Bending; Automatic

Curbing Machines; Blastholer; Self-propelled Rotary Drill or similar machines; Work Boat; Combination Concrete Finishing Machine and Float; Asphalt Paver Screed Operator; Forklift (6,000 lb. cap. or over or working heights above 28 ft.); Chip Spreader; Asphalt Paver; Asphalt Plant Operator; Boring Machine (Directional, Vertical, or Horizontal); Central Redi-Mix Plant Operator; Combination Backhoe Front End loader; Concrete Breaker or Hydro-Hammer (excluding walk-behinds); Concrete Wheel Saw (Large self-propelled - excluding walk-behinds); Crusher (Stone, Concrete, Asphalt, etc.); Curing-Tinning Machine; Excavator; Farm-Type Tractor Operating Scoop or Scraper with Power Attachment; Grader; Motor Grader; Motor Patrol; Auto Grader; Form Grader; Pull Grader; Sub Grader; Elevating Grader; Guard Rail Post Driver; Hoists; Hydraulic Dredge Leverman or Engineer; Hydro-Vac truck mounted or pull type, and similar equipment; Loader (Track, Rubber Tire, or Articulated); Milling Machine (excluding walk-behinds); Road Widener-Shoulder Spreader; Scraper (self-propelled); Self-propelled Roller or Tire Roller (on asphalt or Blacktop); Sheep Foot or Pad Foot Compactor (excluding walk-behinds); Steel Track-Type Tractor (Dozer, Push Cat, etc.); Transfer or Shuttle Buggy (excluding motorized wheel barrows and Georgia buggies); Trenching Machine (40 H.P. and over).

Class 2. Asphalt Booster; Fireman and Pump Operator at Asphalt Plant; Mud Jack; Farm-Type Tractor without Power attachment; Distributor; Straddle Carrier; Self-propelled Roller or Compactor (other than provided for in Class I); Pump Operator (more than one well-point pump); Trench Machine (under 40 H.P.); Forklift (less than 6,000 lb. capacity or working heights below 28 ft.); Conveyor over 20 H.P.; Air Compressor (400 c.f.m. or over); Light Plant; Boiler (Engineer or Fireman); Mechanical Broom; Driver on Truck Crane or similar machines; Elevator (Permanent inside or Temporary outside); Grout Pump (excluding hose work).

Class 3. Oiler; Mechanic's Helper; Mechanical Heater (other than steam boiler); Small Outboard Motor Boat (Safety Boat and Life Boat); Engine Driven Welding Machine; skid steer.

Class 4. Leadman - Mechanic or Equipment Greaser.

Class 5. Track Excavator with Bucket (4 cubic yard and up to but not including 6 cubic yard).

Class 6. Track Excavator with Bucket (6 cubic yard and over).

Class 7. Truck mounted Concrete Conveyor or Pumps Extending to 90 ft. or more.

Class 8. Crane (Friction or Hydraulic, regardless of size or attachments); Tow or Push Boat.

TRUCK DRIVER - BUILDING, HEAVY AND HIGHWAY CONSTRUCTION

Class 1. Drivers on 2 axle trucks hauling less than 9 ton. Air compressor and welding machines and brooms, including those pulled by separate units, truck driver helpers, warehouse employees, mechanic helpers, greasers and tiremen, pickup trucks when hauling materials, tools, or workers to and from and on-the-job site, and fork lifts up to 6,000 lb. capacity.

Class 2. Two or three axle trucks hauling more than 9 ton but hauling less than 16 ton. A-frame winch trucks, hydrolift trucks, vactor trucks or similar equipment when used for transportation purposes. Fork lifts over 6,000 lb. capacity, winch trucks, four axle combination units, and ticket writers.

Class 3. Two, three or four axle trucks hauling 16 ton or more. Drivers on water pulls, articulated dump trucks, mechanics and working

forepersons, and dispatchers. Five axle or more combination units.

Class 4. Low Boy and Oil Distributors.

Class 5. Drivers who require special protective clothing while employed on hazardous waste work.

TRUCK DRIVER - OIL AND CHIP RESEALING ONLY.

This shall encompass laborers, workers and mechanics who drive contractor or subcontractor owned, leased, or hired pickup, dump, service, or oil distributor trucks. The work includes transporting materials and equipment (including but not limited to, oils, aggregate supplies, parts, machinery and tools) to or from the job site; distributing oil or liquid asphalt and aggregate; stock piling material when in connection with the actual oil and chip contract. The Truck Driver (Oil & Chip Resealing) wage classification does not include supplier delivered materials.

Other Classifications of Work:

For definitions of classifications not otherwise set out, the Department generally has on file such definitions which are available. If a task to be performed is not subject to one of the classifications of pay set out, the Department will upon being contacted state which neighboring county has such a classification and provide such rate, such rate being deemed to exist by reference in this document. If no neighboring county rate applies to the task, the Department shall undertake a special determination, such special determination being then deemed to have existed under this determination. If a project requires these, or any classification not listed, please contact IDOL at 217-782-1710 for wage rates or clarifications.

LANDSCAPING

Landscaping work falls under the existing classifications for laborer, operating engineer and truck driver. The work performed by landscape plantsman and landscape laborer is covered by the existing classification of laborer. The work performed by landscape operators (regardless of equipment used or its size) is covered by the classifications of operating engineer. The work performed by landscape truck drivers (regardless of size of truck driven) is covered by the classifications of truck driver.

Saint Clair County Prevailing Wage for May 2013

(See explanation of column headings at bottom of wages)

Trade Name	RG	TYP	C	Base	FRMAN	M-F>8	OSA	OSH	H/W	Pensn	Vac	Trng
=====	==	===	=	=====	=====	=====	===	===	=====	=====	=====	=====
ASBESTOS ABT-GEN		BLD		29.800	30.300	1.5	1.5	2.0	6.050	10.60	0.000	0.800
ASBESTOS ABT-MEC		BLD		29.860	30.860	1.5	1.5	2.0	6.950	3.000	0.000	0.000
BOILERMAKER		BLD		31.500	34.000	1.5	1.5	2.0	7.070	18.73	1.000	0.350
BRICK MASON		BLD		29.280	33.160	1.5	1.5	2.0	7.750	9.430	2.000	0.400
CARPENTER		ALL		34.630	36.130	1.5	1.5	2.0	6.550	6.750	0.000	0.400
CEMENT MASON		ALL		31.000	32.000	1.5	1.5	2.0	9.250	11.75	0.000	0.200
CERAMIC TILE FNSHER		BLD		25.890	0.000	1.5	1.5	2.0	6.000	5.200	0.000	0.530
ELECTRIC PWR EQMT OP		ALL		36.870	0.000	1.5	1.5	2.0	6.790	10.32	0.000	0.270
ELECTRIC PWR GRNDMAN		ALL		27.530	0.000	1.5	1.5	2.0	5.070	7.710	0.000	0.210
ELECTRIC PWR LINEMAN		ALL		42.400	44.450	1.5	1.5	2.0	7.810	11.87	0.000	0.320
ELECTRIC PWR TRK DRV		ALL		30.100	0.000	1.5	1.5	2.0	5.540	8.430	0.000	0.230
ELECTRICIAN		ALL		36.510	38.700	1.5	1.5	2.0	7.810	7.490	0.000	0.640

ELECTRONIC SYS TECH		BLD	30.720	32.470	1.5	1.5	2.0	3.650	7.920	0.000	0.400
ELEVATOR CONSTRUCTOR		BLD	43.715	49.180	2.0	2.0	2.0	11.88	12.71	3.500	0.600
FLOOR LAYER		BLD	29.330	30.080	1.5	1.5	2.0	6.550	6.750	0.000	0.400
GLAZIER		BLD	32.780	0.000	2.0	2.0	2.0	9.020	10.80	2.630	0.310
HT/FROST INSULATOR		BLD	37.260	38.260	1.5	1.5	2.0	7.850	11.16	0.000	0.500
IRON WORKER		ALL	31.500	33.500	1.5	1.5	2.0	7.610	13.33	0.000	0.420
LABORER	N	ALL	29.300	29.800	1.5	1.5	2.0	6.050	10.60	0.000	0.800
LABORER	S	ALL	27.620	28.120	1.5	1.5	2.0	5.750	12.58	0.000	0.800
MACHINIST		BLD	43.550	46.050	1.5	1.5	2.0	6.130	8.950	1.850	0.000
MARBLE FINISHERS		BLD	25.890	0.000	1.5	1.5	2.0	6.000	5.200	0.000	0.530
MARBLE MASON		BLD	29.280	33.160	1.5	1.5	2.0	7.750	9.430	2.000	0.400
MILLWRIGHT		ALL	34.630	36.130	1.5	1.5	2.0	6.550	6.750	0.000	0.400
OPERATING ENGINEER		BLD 1	34.200	37.200	1.5	1.5	2.0	9.000	17.00	0.000	1.000
OPERATING ENGINEER		BLD 2	33.070	37.200	1.5	1.5	2.0	9.000	17.00	0.000	1.000
OPERATING ENGINEER		BLD 3	28.590	37.200	1.5	1.5	2.0	9.000	17.00	0.000	1.000
OPERATING ENGINEER		BLD 4	28.650	37.200	1.5	1.5	2.0	9.000	17.00	0.000	1.000
OPERATING ENGINEER		BLD 5	28.320	37.200	1.5	1.5	2.0	9.000	17.00	0.000	1.000
OPERATING ENGINEER		BLD 6	35.750	37.200	1.5	1.5	2.0	9.000	17.00	0.000	1.000
OPERATING ENGINEER		BLD 7	36.050	37.200	1.5	1.5	2.0	9.000	17.00	0.000	1.000
OPERATING ENGINEER		BLD 8	36.330	37.200	1.5	1.5	2.0	9.000	17.00	0.000	1.000
OPERATING ENGINEER		BLD 9	35.650	37.200	1.5	1.5	2.0	9.000	17.00	0.000	1.000
OPERATING ENGINEER		HWY 1	32.700	35.700	1.5	1.5	2.0	9.000	17.00	0.000	1.000
OPERATING ENGINEER		HWY 2	31.570	35.700	1.5	1.5	2.0	9.000	17.00	0.000	1.000
OPERATING ENGINEER		HWY 3	27.090	35.700	1.5	1.5	2.0	9.000	17.00	0.000	1.000
OPERATING ENGINEER		HWY 4	27.150	35.700	1.5	1.5	2.0	9.000	17.00	0.000	1.000
OPERATING ENGINEER		HWY 5	26.820	35.700	1.5	1.5	2.0	9.000	17.00	0.000	1.000
OPERATING ENGINEER		HWY 6	34.250	35.700	1.5	1.5	2.0	9.000	17.00	0.000	1.000
OPERATING ENGINEER		HWY 7	34.550	35.700	1.5	1.5	2.0	9.000	17.00	0.000	1.000
OPERATING ENGINEER		HWY 8	34.830	35.700	1.5	1.5	2.0	9.000	17.00	0.000	1.000
OPERATING ENGINEER		HWY 9	34.150	35.700	1.5	1.5	2.0	9.000	17.00	0.000	1.000
PAINTER		BLD	29.250	30.750	1.5	1.5	2.0	5.000	7.920	0.000	0.600
PAINTER		HWY	30.450	31.950	1.5	1.5	2.0	5.000	7.920	0.000	0.600
PAINTER OVER 30FT		BLD	30.250	31.750	1.5	1.5	2.0	5.000	7.920	0.000	0.600
PAINTER PWR EQMT		BLD	30.250	31.750	1.5	1.5	2.0	5.000	7.920	0.000	0.600
PAINTER PWR EQMT		HWY	31.450	32.950	1.5	1.5	2.0	5.000	7.920	0.000	0.600
PILEDRIVER		ALL	34.630	36.130	1.5	1.5	2.0	6.550	6.750	0.000	0.400
PIPEFITTER	NW	BLD	37.250	39.250	1.5	1.5	2.0	6.740	8.000	0.000	0.750
PIPEFITTER	SE	BLD	36.000	38.500	1.5	1.5	2.0	7.750	5.500	0.000	0.575
PLASTERER		BLD	30.250	31.250	1.5	1.5	2.0	9.250	8.600	0.000	0.050
PLUMBER	NW	BLD	36.300	38.800	1.5	1.5	2.0	6.250	6.850	0.000	0.500
PLUMBER	SE	BLD	36.000	38.500	1.5	1.5	2.0	7.750	5.500	0.000	0.575
ROOFER		BLD	29.500	31.500	1.5	1.5	2.0	8.600	6.850	0.000	0.200
SHEETMETAL WORKER		ALL	31.690	33.190	1.5	1.5	2.0	7.130	6.730	1.910	0.360
SPRINKLER FITTER		BLD	38.780	41.780	2.0	2.0	2.0	8.370	11.18	0.000	1.000
TERRAZZO FINISHER		BLD	31.240	0.000	1.5	1.5	2.0	6.000	3.230	0.000	0.200
TERRAZZO MASON		BLD	32.530	32.830	1.5	1.5	2.0	6.000	5.230	0.000	0.210
TRUCK DRIVER		ALL 1	31.340	0.000	1.5	1.5	2.0	10.30	5.010	0.000	0.250
TRUCK DRIVER		ALL 2	31.780	0.000	1.5	1.5	2.0	10.30	5.010	0.000	0.250
TRUCK DRIVER		ALL 3	32.020	0.000	1.5	1.5	2.0	10.30	5.010	0.000	0.250
TRUCK DRIVER		ALL 4	32.280	0.000	1.5	1.5	2.0	10.30	5.010	0.000	0.250
TRUCK DRIVER		ALL 5	33.130	0.000	1.5	1.5	2.0	10.30	5.010	0.000	0.250
TRUCK DRIVER		O&C 1	25.070	0.000	1.5	1.5	2.0	10.30	5.010	0.000	0.250
TRUCK DRIVER		O&C 2	25.420	0.000	1.5	1.5	2.0	10.30	5.010	0.000	0.250
TRUCK DRIVER		O&C 3	25.620	0.000	1.5	1.5	2.0	10.30	5.010	0.000	0.250
TRUCK DRIVER		O&C 4	25.820	0.000	1.5	1.5	2.0	10.30	5.010	0.000	0.250
TRUCK DRIVER		O&C 5	26.500	0.000	1.5	1.5	2.0	10.30	5.010	0.000	0.250

Legend:

RG (Region)

TYP (Trade Type - All,Highway,Building,Floating,Oil & Chip,Rivers)

C (Class)

Base (Base Wage Rate)

FRMAN (Foreman Rate)

M-F>8 (OT required for any hour greater than 8 worked each day, Mon through Fri.)

OSA (Overtime (OT) is required for every hour worked on Saturday)

OSH (Overtime is required for every hour worked on Sunday and Holidays)

H/W (Health & Welfare Insurance)

Pensn (Pension)

Vac (Vacation)

Trng (Training)

Explanations

ST. CLAIR COUNTY

LABORERS (NORTH) - The area bounded by Route 159 to a point south of Fairview Heights and west-southwest to Route 3 at Monroe County line.

PLUMBERS & PIPEFITTERS (SOUTHEAST) - That part of the county bordered by Rt. 50 on the North and West including Belleville.

PLUMBERS (NORTHWEST) - Towns of Aloraton, Brooklyn, Cahokia, Caseyville, Centreville, Dupo, East Carondelet, E. St. Louis, Fairview Heights, French Village, National City, O'Fallon, Sauget, and Washington Park.

The following list is considered as those days for which holiday rates of wages for work performed apply: New Years Day, Memorial Day, Fourth of July, Labor Day, Thanksgiving Day, Christmas Day and Veterans Day in some classifications/counties. Generally, any of these holidays which fall on a Sunday is celebrated on the following Monday. This then makes work performed on that Monday payable at the appropriate overtime rate for holiday pay. Common practice in a given local may alter certain days of celebration. If in doubt, please check with IDOL.

Oil and chip resealing (O&C) means the application of road oils and liquid asphalt to coat an existing road surface, followed by application of aggregate chips or gravel to coated surface, and subsequent rolling of material to seal the surface.

EXPLANATION OF CLASSES

ASBESTOS - GENERAL - removal of asbestos material/mold and hazardous materials from any place in a building, including mechanical systems where those mechanical systems are to be removed. This includes the removal of asbestos materials/mold and hazardous materials from ductwork or pipes in a building when the building is to be demolished at the time or at some close future date.

ASBESTOS - MECHANICAL - removal of asbestos material from mechanical systems, such as pipes, ducts, and boilers, where the mechanical systems are to remain.

CERAMIC TILE FINISHER AND MARBLE FINISHER

The handling, at the building site, of all sand, cement, tile, marble or stone and all other materials that may be used and installed by [a] tile layer or marble mason. In addition, the grouting, cleaning, sealing, and mixing on the job site, and all other work as required in assisting the setter. The term "Ceramic" is used for naming the classification only and is in no way a limitation of the product handled. Ceramic takes into consideration most hard tiles.

ELECTRONIC SYSTEMS TECHNICIAN

Installation, service and maintenance of low-voltage systems which utilizes the transmission and/or transference of voice, sound, vision, or digital for commercial, education, security and entertainment purposes for the following: TV monitoring and surveillance, background/foreground music, intercom and telephone interconnect, field programming, inventory control systems, microwave transmission, multi-media, multiplex, radio page, school, intercom and sound burglar alarms and low voltage master clock systems.

Excluded from this classification are energy management systems, life safety systems, supervisory controls and data acquisition systems not intrinsic with the above listed systems, fire alarm systems, nurse call systems and raceways exceeding fifteen feet in length.

OPERATING ENGINEER - BUILDING

GROUP I. Cranes, Dragline, Shovels, Skimmer Scoops, Clamshells or Derrick Boats, Pile Drivers, Crane-Type Backhoes, Asphalt Plant Operators, Concrete Plant Operators, Dredges, Asphalt Spreading Machines, All Locomotives, Cable Ways or Tower Machines, Hoists, Hydraulic Backhoes, Ditching Machines or Backfiller, Cherrypickers, Overhead Cranes, Roller - Steam or Gas, Concrete Pavers, Excavators, Concrete Breakers, Concrete Pumps, Bulk Cement Plants, Cement Pumps, Derrick-Type Drills, Boat Operators, Motor Graders or Pushcats, Scoops or Tournapulls, Bulldozers, Endloaders or Fork Lifts, Power Blade or Elevating Graders, Winch Cats, Boom or Winch Trucks or Boom Tractors, Pipe Wrapping or Painting Machines, Asphalt Plant Engineer, Journeyman Lubricating Engineer, Drills (other than Derrick Type), Mud Jacks, or Well Drilling Machines, Boring Machines or Track Jacks, Mixers, Conveyors (Two), Air Compressors (Two), Water Pumps regardless of size (Two), Welding Machines (Two), Siphons or Jets (Two), Winch Heads or Apparatuses (Two), Light Plants (Two), All Tractors regardless of size (straight tractor only), Fireman on Stationary Boilers, Automatic Elevators, Form Grading Machines, Finishing Machines, Power Sub-Grader or Ribbon Machines, Longitudinal Floats, Distributor Operators on Trucks, Winch Heads or Apparatuses (One), Mobil Track air and heaters (two to five), Heavy Equipment Greaser, Relief Operator, Assistant Master Mechanic and Heavy Duty Mechanic, self-propelled concrete saws of all types and sizes with their attachments, gob-hoppers, excavators all sizes, the repair and greasing of all diesel hammers, the operation and set-up of bidwells, water blasters of all sizes and their clutches, hydraulic jacks where used for hoisting, operation of log skidders, iceolators used on and off of pipeline, condor cranes, bow boats, survey boats, bobcats and all their attachments, skid steer loaders and all their attachments, creter cranes, batch plants, operator (all sizes), self propelled roto mills, operation of conveyor systems of any size and any configuration, operation, repair and service of all vibratory hammers, all power pacs and their controls regardless of location, curtains or brush burning machines, stump cutter machines, Nail launchers when mounted on a machine or self-propelled, operation of con-cover machines, and all Operators

except those listed below).

GROUP II. Assistant Operators.

GROUP III. Air Compressors (One), Water Pumps, regardless of Size (One), Waterblasters (one), Welding Machine (One), Mixers (One Bag), Conveyor (One), Siphon or Jet (One), Light Plant (One), Heater (One), Immobile Track Air (One), and Self Propelled Walk-Behind Rollers.

GROUP IV. Asphalt Spreader Oilers, Fireman on Whirlies and Heavy Equipment Oilers, Truck Cranes, Dredges, Monigans, Large Cranes - (Over 65-ton rated capacity) Concrete Plant Oiler, Blacktop Plant Oiler, and Creter Crane Oiler (when required).

GROUP V. Oiler.

GROUP VI. Operators on equipment with Booms, including jibs, 100 feet and over, and less than 150 feet long.

GROUP VII. Operators on equipment with Booms, including jibs, 150 feet and over, and less than 200 feet long.

GROUP VIII. Operators on Equipment with Booms, including jibs, 200 feet and over; Tower Cranes; and Whirlie Cranes.

GROUP IX. Master Mechanic

OPERATING ENGINEERS - Highway

GROUP I. Cranes, Dragline, Shovels, Skimmer Scoops, Clamshells or Derrick Boats, Pile Drivers, Crane-Type Backhoes, Asphalt Plant Operators, Concrete Plant Operators, Dredges, Asphalt Spreading Machines, All Locomotives, Cable Ways or Tower Machines, Hoists, Hydraulic Backhoes, Ditching Machines or Backfiller, Cherrypickers, Overhead Cranes, Roller - Steam or Gas, Concrete Pavers, Excavators, Concrete Breakers, Concrete Pumps, Bulk Cement Plants, Cement Pumps, Derrick-Type Drills, Boat Operators, Motor Graders or Pushcats, Scoops or Tournapulls, Bulldozers, Endloaders or Fork Lifts, Power Blade or Elevating Graders, Winch Cats, Boom or Winch Trucks or Boom Tractors, Pipe Wrapping or Painting Machines, Asphalt Plant Engineer, Journeyman Lubricating Engineer, Drills (other than Derrick Type), Mud Jacks, Well Drilling Machines, Boring Machines, Track Jacks, Mixers, Conveyors (Two), Air Compressors (Two), Water Pumps regardless of size (Two), Welding Machines (Two), Siphons or Jets (Two), Winch Heads or Apparatuses (Two), Light Plants (Two), All Tractors regardless of size (straight tractor only), Fireman on Stationary Boilers, Automatic Elevators, Form Grading Machines, Finishing Machines, Power Sub-Grader or Ribbon Machines, Longitudinal Floats, Distributor Operators on Trucks, Winch Heads or Apparatuses (One), Mobil Track air and heaters (two to five), Heavy Equipment Greaser, Relief Operator, Assistant Master Mechanic and Heavy Duty Mechanic, self-propelled concrete saws of all types and sizes with their attachments, gob-hoppers, excavators all sizes, the repair and greasing of all diesel hammers, the operation and set-up of bidwells, water blasters of all sizes and their clutches, hydraulic jacks where used for hoisting, operation of log skidders, iceolators used on and off of pipeline, condor cranes, bow boats, survey boats, bobcats and all their attachments, skid steer loaders and all their attachments, creter cranes, batch plants, operator (all sizes), self propelled roto mills, operation of conveyor systems of any size and any configuration, operation, repair and service of all vibratory hammers, all power pacs and their controls regardless of location, curtains or brush burning machines, stump cutter machines, Nail launchers when mounted on a machine or self-propelled, operation of con-cover machines, and all Operators (except those listed below).

GROUP II. Assistant Operators.

GROUP III. Air Compressors (One), Water Pumps, regardless of Size (One), Waterblasters (one), Welding Machine (One), Mixers (One Bag), Conveyor (One), Siphon or Jet (One), Light Plant (One), Heater (One), Immobile Track Air (One), and Self Propelled Walk-Behind Rollers.

GROUP IV. Asphalt Spreader Oilers, Fireman on Whirlies and Heavy Equipment Oilers, Truck Cranes, Dredges, Monigans, Large Cranes - (Over 65-ton rated capacity) Concrete Plant Oiler, Blacktop Plant Oiler, and Creter Crane Oiler (when required).

GROUP V. Oiler.

GROUP VI. Operators on equipment with Booms, including jibs, 100 feet and over, and less than 150 feet long.

GROUP VII. Operators on equipment with Booms, including jibs, 150 feet and over, and less than 200 feet long.

GROUP VIII. Operators on Equipment with Booms, including jibs, 200 feet and over; Tower Cranes; and Whirlie Cranes.

GROUP IX. Mechanic

TRUCK DRIVER - BUILDING, HEAVY AND HIGHWAY CONSTRUCTION

Class 1. Drivers on 2 axle trucks hauling less than 9 ton. Air compressor and welding machines and brooms, including those pulled by separate units, truck driver helpers, warehouse employees, mechanic helpers, greasers and tiremen, pickup trucks when hauling materials, tools, or workers to and from and on-the-job site, and fork lifts up to 6,000 lb. capacity.

Class 2. Two or three axle trucks hauling more than 9 ton but hauling less than 16 ton. A-frame winch trucks, hydrolift trucks, vector trucks or similar equipment when used for transportation purposes. Fork lifts over 6,000 lb. capacity, winch trucks, four axle combination units, and ticket writers.

Class 3. Two, three or four axle trucks hauling 16 ton or more. Drivers on water pulls, articulated dump trucks, mechanics and working forepersons, and dispatchers. Five axle or more combination units.

Class 4. Low Boy and Oil Distributors.

Class 5. Drivers who require special protective clothing while employed on hazardous waste work.

TRUCK DRIVER - OIL AND CHIP RESEALING ONLY.

This shall encompass laborers, workers and mechanics who drive contractor or subcontractor owned, leased, or hired pickup, dump, service, or oil distributor trucks. The work includes transporting materials and equipment (including but not limited to, oils, aggregate supplies, parts, machinery and tools) to or from the job site; distributing oil or liquid asphalt and aggregate; stock piling material when in connection with the actual oil and chip contract. The Truck Driver (Oil & Chip Resealing) wage classification does not include supplier delivered materials.

TERRAZZO FINISHER

The handling of all materials used for Mosaic and Terrazzo work including preparing, mixing by hand, by mixing machine or transporting of pre-mixed materials and distributing with shovel, rake, hoe, or pail, all kinds of concrete foundations necessary for Mosaic and Terrazzo work, all cement terrazzo, magnesite terrazzo, Do-O-Text terrazzo, epoxy matrix terrazzo, exposed aggregate, rustic or rough washed for exterior or interior of buildings placed either by machine or by hand, and any other kind of mixture of plastics composed of chips or granules when mixed with cement, rubber, neoprene, vinyl, magnesium chloride or any other resinous or chemical substances used for seamless flooring systems, and all other building materials, all similar materials and all precast terrazzo work on jobs, all scratch coat used for Mosaic and Terrazzo work and sub-bed, tar paper and wire mesh (2x2 etc.) or lath. The rubbing, grinding, cleaning and finishing of same either by hand or by machine or by terrazzo resurfacing equipment on new or existing floors. When necessary finishers shall be allowed to assist the mechanics to spread sand bed, lay tarpaper and wire mesh (2x2 etc.) or lath. The finishing of cement floors where additional aggregate of stone is added by spreading or sprinkling on top of the finished base, and troweled or rolled into the finish and then the surface is ground by grinding machines.

Other Classifications of Work:

For definitions of classifications not otherwise set out, the Department generally has on file such definitions which are available. If a task to be performed is not subject to one of the classifications of pay set out, the Department will upon being contacted state which neighboring county has such a classification and provide such rate, such rate being deemed to exist by reference in this document. If no neighboring county rate applies to the task, the Department shall undertake a special determination, such special determination being then deemed to have existed under this determination. If a project requires these, or any classification not listed, please contact IDOL at 217-782-1710 for wage rates or clarifications.

LANDSCAPING

Landscaping work falls under the existing classifications for laborer, operating engineer and truck driver. The work performed by landscape plantsman and landscape laborer is covered by the existing classification of laborer. The work performed by landscape operators (regardless of equipment used or its size) is covered by the classifications of operating engineer. The work performed by landscape truck drivers (regardless of size of truck driven) is covered by the classifications of truck driver.

Saline County Prevailing Wage for May 2013

(See explanation of column headings at bottom of wages)

Trade Name	RG	TYP	C	Base	FRMAN	M-F>8	OSA	OSH	H/W	Pensn	Vac	Trng
=====	==	===	=	=====	=====	=====	===	===	=====	=====	=====	=====
ASBESTOS ABT-GEN		ALL		25.300	25.750	1.5	1.5	2.0	5.750	10.35	0.000	0.900
ASBESTOS ABT-MEC		BLD		21.150	22.150	1.5	1.5	2.0	6.400	5.150	0.000	0.650
BOILERMAKER		BLD		31.500	34.000	1.5	1.5	2.0	7.070	18.73	1.000	0.350
BRICK MASON		BLD		28.620	30.120	1.5	1.5	2.0	8.200	7.030	0.000	0.430
CARPENTER		BLD		31.890	33.390	1.5	1.5	2.0	6.550	6.750	0.000	0.400
CARPENTER		HWY		31.840	33.340	1.5	1.5	2.0	6.550	6.750	0.000	0.400
CEMENT MASON		BLD		28.200	29.700	1.5	1.5	2.0	6.600	5.400	0.000	0.500

CEMENT MASON	HWY		27.290	28.290	1.5	1.5	2.0	6.600	5.160	0.000	0.400
CERAMIC TILE FNSHER	BLD		27.120	0.000	1.5	1.5	2.0	8.200	7.030	0.000	0.430
ELECTRIC PWR EQMT OP	ALL	1	35.570	0.000	1.5	1.5	2.0	5.000	9.960	0.000	0.360
ELECTRIC PWR EQMT OP	ALL	2	31.740	0.000	1.5	1.5	2.0	5.000	8.880	0.000	0.320
ELECTRIC PWR GRNDMAN	ALL		26.100	0.000	1.5	1.5	2.0	5.000	7.310	0.000	0.260
ELECTRIC PWR LINEMAN	ALL		44.630	47.650	1.5	1.5	2.0	5.000	12.50	0.000	0.450
ELECTRICIAN	ALL		39.350	41.600	1.5	1.5	2.0	6.140	9.440	0.000	0.790
ELECTRONIC SYS TECH	BLD		32.570	34.320	1.5	1.5	2.0	6.000	4.240	0.000	0.400
FLOOR LAYER	BLD		29.330	30.080	1.5	1.5	2.0	6.550	6.750	0.000	0.400
GLAZIER	BLD		26.780	28.030	1.5	1.5	2.0	6.120	5.200	0.000	0.300
HT/FROST INSULATOR	BLD		29.450	30.450	1.5	1.5	2.0	5.050	9.730	0.000	0.280
IRON WORKER	ALL		27.020	28.270	1.5	1.5	2.0	7.010	9.200	0.000	0.345
LABORER	BLD		25.300	25.750	1.5	1.5	2.0	5.750	10.35	0.000	0.800
LABORER	HWY		25.300	25.750	1.5	1.5	2.0	5.750	10.35	0.000	0.800
LABORER	O&C		17.740	18.190	1.5	1.5	2.0	5.450	8.450	0.000	0.800
MACHINIST	BLD		43.550	46.050	1.5	1.5	2.0	6.130	8.950	1.850	0.000
MARBLE FINISHERS	BLD		27.120	0.000	1.5	1.5	2.0	8.200	7.030	0.000	0.430
MARBLE MASON	BLD		28.620	30.120	1.5	1.5	2.0	8.200	7.030	0.000	0.430
MILLWRIGHT	BLD		31.890	33.390	1.5	1.5	2.0	6.550	6.750	0.000	0.400
MILLWRIGHT	HWY		31.840	33.340	1.5	1.5	2.0	6.550	6.750	0.000	0.400
OE RIVER 1	RIV	1	33.550	34.550	1.5	1.5	2.0	7.000	8.800	0.000	1.450
OE RIVER 2	RIV	2	30.100	34.550	1.5	1.5	2.0	7.000	8.800	0.000	1.450
OPERATING ENGINEER	ALL	1	33.450	34.450	1.5	1.5	2.0	7.000	8.800	0.000	1.450
OPERATING ENGINEER	ALL	2	31.550	34.450	1.5	1.5	2.0	7.000	8.800	0.000	1.450
OPERATING ENGINEER	ALL	3	24.150	34.450	1.5	1.5	2.0	7.000	8.800	0.000	1.450
OPERATING ENGINEER	ALL	4	21.400	27.800	1.5	1.5	2.0	5.650	6.100	0.000	1.100
OPERATING ENGINEER	O&C	1	25.090	26.090	1.5	1.5	2.0	7.000	8.800	0.000	1.450
OPERATING ENGINEER	O&C	2	23.660	26.090	1.5	1.5	2.0	7.000	8.800	0.000	1.450
OPERATING ENGINEER	O&C	3	18.120	26.090	1.5	1.5	2.0	7.000	8.800	0.000	1.450
OPERATING ENGINEER	O&C	4	16.050	21.100	1.5	1.5	2.0	5.650	6.100	0.000	1.100
PAINTER	BLD		26.260	27.760	1.5	1.5	2.0	6.630	7.070	0.000	0.500
PAINTER	HWY		30.560	32.060	1.5	1.5	2.0	6.630	7.070	0.000	0.500
PAINTER OVER 30FT	BLD		27.260	28.760	1.5	1.5	2.0	6.630	7.070	0.000	0.500
PAINTER PWR EQMT	BLD		27.260	28.760	1.5	1.5	2.0	6.630	7.070	0.000	0.500
PAINTER PWR EQMT	HWY		31.560	33.060	1.5	1.5	2.0	6.630	7.070	0.000	0.500
PILEDRIVER	BLD		31.890	33.390	1.5	1.5	2.0	6.550	6.750	0.000	0.400
PILEDRIVER	HWY		31.840	33.340	1.5	1.5	2.0	6.550	6.750	0.000	0.400
PIPEFITTER	BLD		37.000	40.700	1.5	1.5	2.0	8.500	9.300	0.000	1.350
PLASTERER	BLD		28.200	29.700	1.5	1.5	2.0	6.600	5.400	0.000	0.500
PLUMBER	BLD		37.000	40.700	1.5	1.5	2.0	8.500	9.300	0.000	1.350
ROOFER	BLD		23.900	24.900	1.5	1.5	2.0	8.650	3.800	0.000	0.000
SHEETMETAL WORKER	ALL		31.690	33.190	1.5	1.5	2.0	7.130	6.730	1.910	0.360
SPRINKLER FITTER	BLD		36.390	39.140	1.5	1.5	2.0	8.420	8.500	0.000	0.450
STONE MASON	BLD		28.620	30.120	1.5	1.5	2.0	8.200	7.030	0.000	0.430
TERRAZZO FINISHER	BLD		27.120	0.000	1.5	1.5	2.0	8.200	7.030	0.000	0.430
TERRAZZO MASON	BLD		28.620	30.120	1.5	1.5	2.0	8.200	7.030	0.000	0.430
TRUCK DRIVER	ALL	1	30.070	0.000	1.5	1.5	2.0	10.30	6.100	0.000	0.250
TRUCK DRIVER	ALL	2	30.520	0.000	1.5	1.5	2.0	10.30	6.100	0.000	0.250
TRUCK DRIVER	ALL	3	30.740	0.000	1.5	1.5	2.0	10.30	6.100	0.000	0.250
TRUCK DRIVER	ALL	4	31.030	0.000	1.5	1.5	2.0	10.30	6.100	0.000	0.250
TRUCK DRIVER	ALL	5	31.850	0.000	1.5	1.5	2.0	10.30	6.100	0.000	0.250
TRUCK DRIVER	O&C	1	22.750	0.000	1.5	1.5	2.0	2.920	6.700	0.000	0.250
TRUCK DRIVER	O&C	2	19.150	0.000	1.5	1.5	2.0	2.920	6.700	0.000	0.250
TRUCK DRIVER	O&C	3	19.650	0.000	1.5	1.5	2.0	2.920	6.700	0.000	0.250
TUCKPOINTER	BLD		28.620	30.120	1.5	1.5	2.0	8.200	7.030	0.000	0.430

Legend :

RG (Region)

TYP (Trade Type - All,Highway,Building,Floating,Oil & Chip,Rivers)

C (Class)

Base (Base Wage Rate)

FRMAN (Foreman Rate)

M-F>8 (OT required for any hour greater than 8 worked each day, Mon through Fri.)

OSA (Overtime (OT) is required for every hour worked on Saturday)

OSH (Overtime is required for every hour worked on Sunday and Holidays)

H/W (Health & Welfare Insurance)

Pensn (Pension)

Vac (Vacation)

Trng (Training)

Explanations

SALINE COUNTY

The following list is considered as those days for which holiday rates of wages for work performed apply: New Years Day, Memorial Day, Fourth of July, Labor Day, Thanksgiving Day, Christmas Day and Veterans Day in some classifications/counties. Generally, any of these holidays which fall on a Sunday is celebrated on the following Monday. This then makes work performed on that Monday payable at the appropriate overtime rate for holiday pay. Common practice in a given local may alter certain days of celebration. If in doubt, please check with IDOL.

Oil and chip resealing (O&C) means the application of road oils and liquid asphalt to coat an existing road surface, followed by application of aggregate chips or gravel to coated surface, and subsequent rolling of material to seal the surface.

EXPLANATION OF CLASSES

ASBESTOS - GENERAL - removal of asbestos material/mold and hazardous materials from any place in a building, including mechanical systems where those mechanical systems are to be removed. This includes the removal of asbestos materials/mold and hazardous materials from ductwork or pipes in a building when the building is to be demolished at the time or at some close future date.

ASBESTOS - MECHANICAL - removal of asbestos material from mechanical systems, such as pipes, ducts, and boilers, where the mechanical systems are to remain.

LABORER - OIL AND CHIP RESEALING ONLY

Hook and unhook chip box from aggregate truck; distribute material within chip box; perform flagging work related to oil and chip resealing; hand spray oil fluids; handle traffic control, including setting-up and maintaining barricades, drums, cones, delineators, signs and other such items, as well as laying-out and applying or removing temporary roadway markings used to control traffic in job site related to oil and chip resealing; and perform clean-up related to oil and chip resealing.

CERAMIC TILE FINISHER, MARBLE FINISHER, TERRAZZO FINISHER

Assisting, helping or supporting the tile, marble and terrazzo mechanic by performing their historic and traditional work assignments required to complete the proper installation of the work covered by said crafts. The term "Ceramic" is used for naming the classification only, and is in no a limitation of the product handled. Ceramic takes into consideration most hard tiles.

ELECTRIC POWER LINEMAN

Construction, maintenance and dismantling of overhead and underground electric power lines, including high voltage pipe type cable work, and associated structures and equipment.

ELECTRIC POWER EQUIPMENT OPERATOR - CLASS 1

Operation of all crawler type equipment D-4 and larger from the ground to assist the Electric Power Linemen in performing their duties.

ELECTRIC POWER EQUIPMENT OPERATORS - CLASS 2

Operation of all other equipment from the ground to assist the Electric Power Linemen in performing their duties.

ELECTRIC POWER GROUNDMAN

Applies to workers who assist the Electric Power Lineman from the ground.

ELECTRONIC SYSTEMS TECHNICIAN

Installation, service and maintenance of low-voltage systems which utilizes the transmission and/or transference of voice, sound, vision, or digital for commercial, education, security and entertainment purposes for the following: TV monitoring and surveillance, background/foreground music, intercom and telephone interconnect, field programming, inventory control systems, microwave transmission, multi-media, multiplex, radio page, school, intercom and sound burglar alarms and low voltage master clock systems.

Excluded from this classification are energy management systems, life safety systems, supervisory controls and data acquisition systems not intrinsic with the above listed systems, fire alarm systems, nurse call systems and raceways exceeding fifteen feet in length.

TRUCK DRIVER - BUILDING, HEAVY AND HIGHWAY CONSTRUCTION

Class 1. Drivers on 2 axle trucks hauling less than 9 ton. Air compressor and welding machines and brooms, including those pulled by separate units, truck driver helpers, warehouse employees, mechanic helpers, greasers and tiremen, pickup trucks when hauling materials, tools, or workers to and from and on-the-job site, and fork lifts up to 6,000 lb. capacity.

Class 2. Two or three axle trucks hauling more than 9 ton but hauling less than 16 ton. A-frame winch trucks, hydrolift trucks, vactor trucks or similar equipment when used for transportation purposes. Fork lifts over 6,000 lb. capacity, winch trucks, four axle combination units, and ticket writers.

Class 3. Two, three or four axle trucks hauling 16 ton or more. Drivers on water pulls, articulated dump trucks, mechanics and working forepersons, and dispatchers. Five axle or more combination units.

Class 4. Low Boy and Oil Distributors.

Class 5. Drivers who require special protective clothing while employed on hazardous waste work.

TRUCK DRIVER - O & C (Oil and Chip Resealing ONLY)

It involves driving of contractor or subcontractor owned, leased, or hired pickup, dump, service, or oil distributor trucks. Includes transporting materials and equipment (including, but not limited to oils, aggregate supplies, parts, machinery and tools) to or from the job site; distributing oil or liquid asphalt and aggregate; stock piling material; and maintaining trucks at job site related to oil and chip resealing.

Class 1. Distributors, liquid asphalt hauling and hauling of asphalt rubber-tired rollers.

Class 2. Stockpiling.

Class 3. Tandem hauling to job site.

OPERATING ENGINEERS - BUILDING, HEAVY AND HIGHWAY CONSTRUCTION

Class 1. APSCO or Equal Spreading Machine, Backhoe, Backfiller, Boom or Winch Cat, Bituminous Mixplane Machine, Blacksmith, Bituminous Surfacing Machine, Bull-Dozer, Crane, Shovel, Dragline, Truck Crane, Pile Driver, Concrete Breaker, Concrete or Pumpcrete Pumps, Dinky or Standard Locomotives, Well or Caisson Drills, Elevating Grader, Fork Lifts, Flexplane, Gradeall, Hi-Lift Hoists, Guy-Derricks, Hysters, Mechanic Motor Patrol, Mixers-21 cu. ft. or over, Push Cats, Pulls and Scrapers, Two Well Point Pumps, Pulverizer or Tiller, PugMill, Rubber-Tired Farm Type Tractor with Bulldozer/Blade/Auger or hi-lift over 1/2 yd., Jersey Spreader, Tract-Air used with Drill or Hi-Lift, Trenching or Ditching Machines, Wood Chipper w/Tractor, Self-Propelled Roller w/Blade, Equipment Greaser, Self-Propelled Bump Grinder on Concrete pavement, Boat Operator, Skid-Loaders, Tuggers, Lazer Screed, and Self-Propelled Chip Spreader (when others run conveyors).

Class 2. Any type tractor pulling any type roller or disc, Two Air Compressors (220 cu. ft. capacity or over), Two AirTract Drills, Air-Track Drill w/Compressor, Automatic Bins or Scales w/Compressor or Generator, Pipeline Boring Machine, Bulk Cement Plant w/Separate Compressor, Power Operated Bull Float, Hydra-Lift w/Single Motor, Straw Mulcher Blower w/Spout, Self-Propelled Roller/Compactor, Back-End man on Bituminous Surfacing Machine, oiler on milling machine.

Class 3. Air Compressor w/Valve driving piling, Boom or Winch Type Truck, Two Conveyors, Self-Propelled Concrete Saw, Form Grader, Truck Crane Oiler, Self-Propelled Vibrator, Rubber Tired Farm Type Tractor w/Blade/Bulldozer/Auger/hi-lift - 1/2 yd. or less, Elevator Operator, Man Lift (scissor lift) when lifting materials.

Class 4. Air-Track Drill (one), Belt Drag Machine, Power Broom, Mechanical Plasterer Applicator, Trac-Air, Air Compressor (220 cu. ft. or over) One, Air Compressor (under 220 cu. ft) four, Automatic Bin, Bulk Cement Plant w/Built-in Compressor running off same motor or electric motor, Fireman or Switchman, Self-Propelled Form Tamper, Light Plants (4), Welding Machines (4), Pumps (4), or Combination of four (4) Pumps, Light Plants, Welding Machines, Air-Compressors (under 220 cu. ft.), Mudjacks or Wood Chipper, Mixers - less than 21 cu. ft. Mortar Mixer w/Skip or Pump, Pipeline Tract Jack. One Operating Engineer may operate and maintain any combination of the following pieces of equipment, not to exceed four (4) which shall be within a reasonable distance, such combination may include any equipment in this classification: (Compressors, Light Plants,

Generators, Welding Machines, Pumps or Conveyors), One Well- Point Pump, Two Motor Driven Heaters, One Air Compressor (under 220 cu. ft.), One Engine-Driven Conveyor, One Motor Driven Heater, One Light Plant, One Pump, One Welding Machine, One Ulmac or Equal Spreader, Oilers, and one Generator 10 kw or greater.

OPERATING ENGINEER - O & C (Oil and Chip Resealing ONLY). Includes the operation of all motorized heavy equipment used in oil and chip resealing, including but not limited to operating self-propelled chip spreaders, and all types of rollers (both hard and rubber tired); and other duties pertaining to the operation or maintenance of heavy equipment relatd to oil and chip resealing.

Class 1. See Class 1 above for types of equipment operated.

Class 2. See Class 2 above for types of equipment operated.

Class 3. See Class 3 above for types of equipment operated.

Class 4. See Class 4 above for types of equipment operated.

OPERATING ENGINEER RIVER WORK 1 - operate the following machines when working on River Work and Levee Work on the Mississippi and Ohio Rivers, Lakes and Tributaries: Crane, Shovel, Drageline, Scrapers, Dredge, Derrick, Pile-Driver, Push Boat, all power boat operators, Mechanic, Engineman on Dredge, Leverman on Dredge, All Bituminous Spreader machines, Backhoe, Backfiller, Boom, or Winch Cat, Bituminous Mixplane Machine, Blacksmith, Bituminous Surfacing Machine, Bulldozer, Truck Cranes, Hydraulic Truck Mounted Boom/Crane, Concrete Finishing Machine, or Spreader Machine, Concrete Breaker, Concrete or Pumpcrete Machines, Concrete Plant Operator, All Off Road Material Hauling Equipment, Dinky or Standard Locomotives, Well Drill, Elevating Grader, Fork-Lifts, Flexplane, Gradeall, Hi-Lift, Power Handblade Tugger type Hoist, Hoist Two Drum (or over one), Guyderrick, Hyster, Motor Patrol, Mixers - 21 Cu. Ft. or over, Push Cat, Pulls, & Scrapers, Pumps-Two Well Points, Equipment Greaser, P & H Pulverizer or Pulverizer equal to Pugmill, Pugmill, Rubber-Tired farm type tractor w/Bulldozer/Blade/Auger or Hi-Lift over ½ yard, Skimmer Scoops, Seaman Tiller, Jersey Spreader, Tract-Air used with Drill or Hi-Lift, Trenching or Ditching Machine, Wood Chipper w/Tractor, self-propelled roller w/Blade, Concrete Pumps and Small Equipment Operators.

OPERATING ENGINEER RIVER 2 - when working on River Work and Levee Work on the Mississippi and Ohio Rivers, Lakes and Tributaries shall be employed as the Oiler or Fireman on Crane, Dragline, Shovel, Dredge, Truck Crane, Pile Driver, Gradeall, Dinky or Standard Locomotive, Guy Derrick, Trenching Machine or Ditching Machine 80 H.P. and over, All Terrain (cherry-picker) with over 40 ton Lifting Capacity, Deck Oiler and Deckhands.

Other Classifications of Work:

For definitions of classifications not otherwise set out, the Department generally has on file such definitions which are available. If a task to be performed is not subject to one of the classifications of pay set out, the Department will upon being contacted state which neighboring county has such a classification and provide such rate, such rate being deemed to exist by reference in this document. If no neighboring county rate applies to the task, the Department shall undertake a special determination, such special determination being then deemed to have existed under this determination. If a project requires these, or any classification not

listed, please contact IDOL at 217-782-1710 for wage rates or clarifications.

LANDSCAPING

Landscaping work falls under the existing classifications for laborer, operating engineer and truck driver. The work performed by landscape plantsman and landscape laborer is covered by the existing classification of laborer. The work performed by landscape operators (regardless of equipment used or its size) is covered by the classifications of operating engineer. The work performed by landscape truck drivers (regardless of size of truck driven) is covered by the classifications of truck driver.

Sangamon County Prevailing Wage for May 2013

(See explanation of column headings at bottom of wages)

Trade Name	RG	TYP	C	Base	FRMAN	M-F>8	OSA	OSH	H/W	Pensn	Vac	Trng
=====	==	===	=	=====	=====	=====	===	===	=====	=====	=====	=====
ASBESTOS ABT-GEN		BLD		30.360	31.610	1.5	1.5	2.0	5.750	10.22	0.000	0.900
ASBESTOS ABT-MEC		BLD		29.860	30.860	1.5	1.5	2.0	6.950	3.000	0.000	0.000
BOILERMAKER		BLD		31.500	34.000	1.5	1.5	2.0	7.070	18.73	1.000	0.350
BRICK MASON		BLD		29.130	29.880	2.0	2.0	2.0	8.200	10.03	0.000	0.580
CARPENTER		BLD		29.810	32.060	1.5	1.5	2.0	7.450	12.44	0.000	0.520
CARPENTER		HWY		29.810	31.560	1.5	1.5	2.0	7.450	12.99	0.000	0.520
CEMENT MASON		BLD		25.200	26.700	1.5	1.5	2.0	6.600	12.10	0.000	0.500
CEMENT MASON		HWY		24.850	25.850	1.5	1.5	2.0	6.600	11.85	0.000	0.500
CERAMIC TILE FNSHER		BLD		25.480	0.000	1.5	1.5	2.0	8.200	8.930	0.000	0.000
ELECTRIC PWR EQMT OP		ALL		35.440	0.000	1.5	1.5	2.0	5.000	10.98	0.000	0.270
ELECTRIC PWR GRNDMAN		ALL		24.320	0.000	1.5	1.5	2.0	5.000	7.540	0.000	0.180
ELECTRIC PWR LINEMAN		ALL		39.370	41.910	1.5	1.5	2.0	5.000	12.20	0.000	0.300
ELECTRIC PWR TRK DRV		ALL		25.510	0.000	1.5	1.5	2.0	5.000	7.920	0.000	0.190
ELECTRICIAN		BLD		34.220	36.220	1.5	1.5	2.0	5.860	8.120	0.000	0.400
ELECTRONIC SYS TECH		BLD		30.390	32.140	1.5	1.5	2.0	5.350	7.160	0.000	0.400
ELEVATOR CONSTRUCTOR		BLD		40.520	45.585	2.0	2.0	2.0	11.88	12.71	3.240	0.600
GLAZIER		BLD		30.780	32.780	1.5	2.0	2.0	6.630	8.150	0.000	0.380
HT/FROST INSULATOR		BLD		37.260	38.260	1.5	1.5	2.0	7.850	11.16	0.000	0.500
IRON WORKER		BLD		29.460	31.460	1.5	1.5	2.0	7.740	11.38	0.000	0.660
IRON WORKER		HWY		30.600	32.100	1.5	1.5	2.0	7.740	11.69	0.000	0.660
LABORER		BLD		28.360	29.610	1.5	1.5	2.0	5.750	10.22	0.000	0.800
LABORER		HWY		28.210	28.960	1.5	1.5	2.0	5.750	10.32	0.000	0.800
LATHER		BLD		29.810	32.060	1.5	1.5	2.0	7.450	12.44	0.000	0.520
MACHINIST		BLD		43.550	46.050	1.5	1.5	2.0	6.130	8.950	1.850	0.000
MARBLE FINISHERS		BLD		25.480	0.000	1.5	1.5	2.0	8.200	8.930	0.000	0.000
MARBLE MASON		BLD		26.980	27.730	1.5	1.5	2.0	8.200	8.930	0.000	0.000
MILLWRIGHT		BLD		29.620	31.870	1.5	1.5	2.0	7.450	13.09	0.000	0.520
MILLWRIGHT		HWY		31.690	33.440	1.5	1.5	2.0	7.450	13.54	0.000	0.520
OPERATING ENGINEER		BLD	1	33.900	35.400	1.5	1.5	2.0	10.05	7.600	0.000	1.300
OPERATING ENGINEER		BLD	2	31.550	35.400	1.5	1.5	2.0	10.05	7.600	0.000	1.300
OPERATING ENGINEER		BLD	3	27.950	35.400	1.5	1.5	2.0	10.05	7.600	0.000	1.300
OPERATING ENGINEER		BLD	4	35.400	35.400	1.5	1.5	2.0	10.05	7.600	0.000	1.300
OPERATING ENGINEER		HWY	1	37.600	39.100	1.5	1.5	2.0	10.05	8.100	0.000	1.300
OPERATING ENGINEER		HWY	2	33.660	39.100	1.5	1.5	2.0	10.05	8.100	0.000	1.300
OPERATING ENGINEER		HWY	3	27.630	39.100	1.5	1.5	2.0	10.05	8.100	0.000	1.300
OPERATING ENGINEER		HWY	4	39.100	39.100	1.5	1.5	2.0	10.05	8.100	0.000	1.300
PAINTER		ALL		28.580	30.080	1.5	1.5	2.0	5.000	8.580	0.000	0.550
PAINTER OVER 30FT		ALL		29.580	31.080	1.5	1.5	2.0	5.000	8.580	0.000	0.550
PAINTER PWR EQMT		ALL		29.580	31.080	1.5	1.5	2.0	5.000	8.580	0.000	0.550
PAINTER SIGNS		ALL		16.240	0.000	1.5	1.5	2.0	0.000	0.000	0.000	0.000
PILEDRIIVER		BLD		30.310	32.560	1.5	1.5	2.0	7.450	12.44	0.000	0.520
PILEDRIIVER		HWY		30.810	32.560	1.5	1.5	2.0	7.450	12.99	0.000	0.520
PIPEFITTER		BLD		40.020	44.020	1.5	1.5	2.0	7.000	7.750	0.000	0.900
PLASTERER		BLD		28.500	30.250	1.5	1.5	2.0	7.330	11.29	0.000	0.500

PLUMBER	BLD	40.020	44.020	1.5	1.5	2.0	7.000	7.750	0.000	0.900
ROOFER	BLD	27.900	30.400	1.5	1.5	2.0	8.600	6.750	0.000	0.500
SHEETMETAL WORKER	BLD	31.680	33.930	1.5	1.5	2.0	8.300	12.35	0.000	0.500
SPRINKLER FITTER	BLD	36.390	39.140	1.5	1.5	2.0	8.420	8.500	0.000	0.450
STONE MASON	BLD	29.130	29.880	2.0	2.0	2.0	8.200	10.03	0.000	0.580
TERRAZZO FINISHER	BLD	25.480	0.000	1.5	1.5	2.0	8.200	8.930	0.000	0.000
TERRAZZO MASON	BLD	26.980	27.730	1.5	1.5	2.0	8.200	8.930	0.000	0.000
TILE MASON	BLD	26.980	27.730	1.5	1.5	2.0	8.200	8.930	0.000	0.000
TRUCK DRIVER	ALL 1	31.340	0.000	1.5	1.5	2.0	10.30	5.010	0.000	0.250
TRUCK DRIVER	ALL 2	31.780	0.000	1.5	1.5	2.0	10.30	5.010	0.000	0.250
TRUCK DRIVER	ALL 3	32.020	0.000	1.5	1.5	2.0	10.30	5.010	0.000	0.250
TRUCK DRIVER	ALL 4	32.280	0.000	1.5	1.5	2.0	10.30	5.010	0.000	0.250
TRUCK DRIVER	ALL 5	33.130	0.000	1.5	1.5	2.0	10.30	5.010	0.000	0.250
TRUCK DRIVER	O&C 1	25.070	0.000	1.5	1.5	2.0	10.30	5.010	0.000	0.250
TRUCK DRIVER	O&C 2	25.420	0.000	1.5	1.5	2.0	10.30	5.010	0.000	0.250
TRUCK DRIVER	O&C 3	25.620	0.000	1.5	1.5	2.0	10.30	5.010	0.000	0.250
TRUCK DRIVER	O&C 4	25.820	0.000	1.5	1.5	2.0	10.30	5.010	0.000	0.250
TRUCK DRIVER	O&C 5	26.500	0.000	1.5	1.5	2.0	10.30	5.010	0.000	0.250
TUCKPOINTER	BLD	29.130	29.880	2.0	2.0	2.0	8.200	10.03	0.000	0.580

Legend :

RG (Region)

TYP (Trade Type - All,Highway,Building,Floating,Oil & Chip,Rivers)

C (Class)

Base (Base Wage Rate)

FRMAN (Foreman Rate)

M-F>8 (OT required for any hour greater than 8 worked each day, Mon through Fri.

OSA (Overtime (OT) is required for every hour worked on Saturday)

OSH (Overtime is required for every hour worked on Sunday and Holidays)

H/W (Health & Welfare Insurance)

Pensn (Pension)

Vac (Vacation)

Trng (Training)

Explanations

SANGAMON COUNTY

The following list is considered as those days for which holiday rates of wages for work performed apply: New Years Day, Memorial Day, Fourth of July, Labor Day, Thanksgiving Day, Christmas Day and Veterans Day in some classifications/counties. Generally, any of these holidays which fall on a Sunday is celebrated on the following Monday. This then makes work performed on that Monday payable at the appropriate overtime rate for holiday pay. Common practice in a given local may alter certain days of celebration. If in doubt, please check with IDOL.

Oil and chip resealing (O&C) means the application of road oils and

liquid asphalt to coat an existing road surface, followed by application of aggregate chips or gravel to coated surface, and subsequent rolling of material to seal the surface.

EXPLANATION OF CLASSES

ASBESTOS - GENERAL - removal of asbestos material/mold and hazardous materials from any place in a building, including mechanical systems where those mechanical systems are to be removed. This includes the removal of asbestos materials/mold and hazardous materials from ductwork or pipes in a building when the building is to be demolished at the time or at some close future date.

ASBESTOS - MECHANICAL - removal of asbestos material from mechanical systems, such as pipes, ducts, and boilers, where the mechanical systems are to remain.

CERAMIC TILE FINISHER, MARBLE FINISHER, TERRAZZO FINISHER

Assisting, helping or supporting the tile, marble and terrazzo mechanic by performing their historic and traditional work assignments required to complete the proper installation of the work covered by said crafts. The term "Ceramic" is used for naming the classification only and is in no way a limitation of the product handled. Ceramic takes into consideration most hard tiles.

ELECTRONIC SYSTEMS TECHNICIAN

Installation, service and maintenance of low-voltage systems which utilizes the transmission and/or transference of voice, sound, vision, or digital for commercial, education, security and entertainment purposes for the following: TV monitoring and surveillance, background/foreground music, intercom and telephone interconnect, field programming, inventory control systems, microwave transmission, multi-media, multiplex, radio page, school, intercom and sound burglar alarms and low voltage master clock systems.

Excluded from this classification are energy management systems, life safety systems, supervisory controls and data acquisition systems not intrinsic with the above listed systems, fire alarm systems, nurse call systems and raceways exceeding fifteen feet in length.

TRUCK DRIVER - BUILDING, HEAVY AND HIGHWAY CONSTRUCTION

Class 1. Drivers on 2 axle trucks hauling less than 9 ton. Air compressor and welding machines and brooms, including those pulled by separate units, truck driver helpers, warehouse employees, mechanic helpers, greasers and tiremen, pickup trucks when hauling materials, tools, or workers to and from and on-the-job site, and fork lifts up to 6,000 lb. capacity.

Class 2. Two or three axle trucks hauling more than 9 ton but hauling less than 16 ton. A-frame winch trucks, hydrolift trucks, vector trucks or similar equipment when used for transportation purposes. Fork lifts over 6,000 lb. capacity, winch trucks, four axle combination units, and ticket writers.

Class 3. Two, three or four axle trucks hauling 16 ton or more. Drivers on water pulls, articulated dump trucks, mechanics and working forepersons, and dispatchers. Five axle or more combination units.

Class 4. Low Boy and Oil Distributors.

Class 5. Drivers who require special protective clothing while employed on hazardous waste work.

TRUCK DRIVER - OIL AND CHIP RESEALING ONLY.

This shall encompass laborers, workers and mechanics who drive contractor or subcontractor owned, leased, or hired pickup, dump, service, or oil distributor trucks. The work includes transporting materials and equipment (including but not limited to, oils, aggregate supplies, parts, machinery and tools) to or from the job site; distributing oil or liquid asphalt and aggregate; stock piling material when in connection with the actual oil and chip contract. The Truck Driver (Oil & Chip Resealing) wage classification does not include supplier delivered materials.

OPERATING ENGINEERS - BUILDING

CLASS 1. Asphalt Screed Man; Aspco Concrete Spreaders; Asphalt Pavers; Asphalt Plant Engineer; Asphalt Rollers on Bituminous Concrete; Athey Loaders; Backfillers, Crane Type; Backhoes; Barber Green Loaders; Bulldozers; Cableways; Cherry Pickers; Clam Shells; C.M.I. & similar type autograde formless paver, autograde placer & finisher; Concrete Breakers; Concrete Pumps; Derricks; Derrick Boats; Draglines; Earth Auger or Boring Machines; Elevating Graders; Engineers on Dredges; Gravel Processing Machines; Head Equipment Greaser; High Lifts or Fork Lifts; Hoists with two or more drums or two or more load lines; Locomotives, All; Mechanics; Motor Graders or Auto Patrols; Operators or Leverman on Dredges; Operators, Power Boat; Operators, Pug Mill (Asphalt Plants); Orange Peels; Overhead Cranes; Paving Mixers; Piledrivers; Pipe Wrapping and Painting Machines; Pushdozers, or Push Cats; Robotic Controlled Equipment in this Classification; Rock Crushers; Ross Carrier or Similar Machines; Rotomill; Scoops, Skimmer, two cu. yd. capacity and under; Scoops, All or Tournapull; Sheep-Foot Roller (Self Propelled); Shovels; Skid Steer; Skimmer Scoops; Temporary Concrete Plant Operators; Test Hole Drilling Machines; Tower Machines; Tower Mixers; Track Type End Loaders; Track Type Fork Lifts or High Lifts; Track Jacks and Tampers; Tractors, Sideboom; Trenching or Ditching Machine; Tunnelluggers; Vermeer Type Saws; Water Blaster Cutting Head; Wheel Type End Loaders; Winch Cat.

CLASS 2. Air Compressors (six to eight)*; Asphalt Boosters and Heaters; Asphalt Distributors; Asphalt Plant Fireman; Oiler on Two Paving Mixers When Used in Tandem; Boom or Winch Trucks; Bull Floats or Flexplanes; Concrete Finishing Machine; Concrete Saws, Self-Propelled; Concrete Spreading Machines; Conveyors (six to eight)*; Generators (six to eight)*; Gravel or Stone Spreader, Power Operated; Hoist (with One Drum and One Load Line); Light Plants (six to eight)*; Mechanical Heaters (six to eight)*; Mud Jacks; Post Hole Digger, Mechanical; Pug Mills when used for other than Asphalt operation; Robotic Controlled Equipment in this Classification; Road or Street Sweeper, Self Propelled; Rollers (except bituminous concrete); Seaman Tiller; Straw Machine; Vibratory Compactor; Water Blaster, Power Unit; Welding Machines (six to eight)*; Well Drill Machines.

CLASS 3. Air Compressors(one to five)*; Air Compressors, Track or Self-Propelled; Automatic Hoist; Building Elevators; Bulk Cement Batching Plants; Conveyors (one to five)*; Concrete Mixers (Except Plant, Paver, or Tower); Firemen; Generators (one to five)*; Greasers; Helper on Single Paving Mixer; Hoist, Automatic; Light Plants (one to five)*; Mechanic Helpers; Mechanical Heaters (one to five)*; Oilers; Power Form Graders; Power Sub-Graders; Robotic Controlled Equipment in this Classification; Scissors Hoist; Tractors without power attachments regardless of size or type; Truck Crane Oiler and Driver (1 man); Vibratory Hammer (power source); Water Pumps (one to five)*; Welding Machines (1/300 Amp. or over)*; Welding machines (one to five)*

CLASS 4. Lattice Boom Crawler Cranes; Lattice Boom Truck Cranes; Telescopic Truck-Mounted Cranes; Tower Cranes.

* Combinations of one to eight of any Air Compressors, Conveyors, Welding Machines, Water Pumps, Light Plants, or Generators shall be in batteries or within 400 feet and shall be paid as per the Classification Schedule contained in this Article.

OPERATING ENGINEERS - HIGHWAY

CLASS 1. Asphalt Screed Man; Asphco Concrete Spreaders; Asphalt Pavers; Asphalt Plant Engineer; Asphalt Rollers on Bituminous Concrete; Athey Loaders; Backhoes; Barber Green Loaders; Bulldozers; Cableways; Carry Deck Pickers; Cherry Pickers (Rough Terrain); C.M.I. & similar type-autograde formless paver, autograde placer & finisher; Concrete Breakers; Concrete Plant Operators; Concrete Pumps; Derricks; Derrick Boats; Dewatering Systems; Earth Auger or Boring Machines; Elevating Graders; Engineers on Dredges; Gravel Processing Machines; Grout Pump; Head Equipment Greaser; High Lifts or Fork Lifts; Hoists with two or more drums or two or more load lines; Hydro Jet or Hydro Laser; Locomotives, All; Mechanics; Motor Graders or Auto Patrols; Multi-Point Power Lifting Equipment; Operators or Leverman on Dredges; Operators, Power Boat; Operators, Pug Mill (Asphalt Plants); Overhead Cranes; Paving Mixers; Piledrivers; Pipe Wrapping and Painting Machines; Push-dozers, or Push Cats; Robotic Controlled Equipment in this Classification; Rock Crushers; Ross Carrier or Similar Machines; Roto-Mill; Scoops, Skimmer, two cu. yd. capacity and under; Sheep-Foot Roller (Self Pro-pelled); Shovels; Skid Steer; Skimmer Scoops; Test Hole Drilling Machines; Tower Machines; Tower Mixers; Track Type End Loaders; Track Type Fork Lifts or High Lifts; Track Jacks and Tampers; Tractors, Side-boom; Trenching or Ditching Machine; Tunnelluggers; Vermeer-Type Saws; Wheel Type End Loaders; Winch Cat; Scoops, All or Tournapull.

CLASS 2. Air Compressors (six to eight)*; Articulated Dumps; Asphalt Boosters and Heaters; Asphalt Distributors; Asphalt Plant Fireman; Boom or Winch Trucks; Building Elevators; Bull Floats or Flexplanes; Concrete Finishing Machine; Concrete Saws, Self-Propelled; Concrete Spreading Machines; Conveyors (six to eight)*; Generators (six to eight)*; Gravel or Stone Spreader, Power Operated; Hoist, Automatic; Hoist with One Drum and One Load Line; Light Plants (six to eight)*; Mechanical Heaters (six to eight)*; Mud Jacks; Off Road Water Wagons; Oiler on Two Paving Mixers When Used in Tandem; Post Hole Digger, Mechanical; Robotic Controlled Equipment in This Classification; Road or Street Sweeper, Self-Propelled; Rollers (except bituminous concrete); Scissor Hoist; Sea-man Tiller; Straw Machine; Vibratory Compactor; Water Pumps (six to eight)*; Well Drill Machines.

CLASS 3. Air Compressors (one to five)*; Air Compressors, Track or Self-Propelled; Bulk Cement Batching Plants; Conveyors (one to five)*; Concrete Mixers (Except Plant, Paver, or Tower); Firemen; Generators (one to five)*; Greasers; Helper on Single Paving Mixer; Light Plants (one to five)*; Mechanic Helpers; Mechanical Heaters (one to five)*; Oilers; Power Form Graders; Power Sub-Graders; Pug Mills when used for other than Asphalt operation; Robotic Controlled Equipment in This Classification; Tractors without power attachments, regardless of size or type; Truck Crane Oiler and Driver (1 man); Vibratory Hammer (power source); Water Pumps (one to five)*; Welding Machines (one 300 Amp. or over)*; Welding Machines (one to five)*.

CLASS 4. Lattice Boom Crawler Crane; Lattice Boom Truck Crane; Telescopic Truck-Mounted Crane; Tower Crane.

*Combinations of one to eight of any Air Compressors, Conveyors,

Welding Machines, Water Pumps, Light Plants or Generators shall be in batteries or within 400 feet and shall be paid as per the Classification Schedule contained in this Article.

Other Classifications of Work:

For definitions of classifications not otherwise set out, the Department generally has on file such definitions which are available. If a task to be performed is not subject to one of the classifications of pay set out, the Department will upon being contacted state which neighboring county has such a classification and provide such rate, such rate being deemed to exist by reference in this document. If no neighboring county rate applies to the task, the Department shall undertake a special determination, such special determination being then deemed to have existed under this determination. If a project requires these, or any classification not listed, please contact IDOL at 217-782-1710 for wage rates or clarifications.

LANDSCAPING

Landscaping work falls under the existing classifications for laborer, operating engineer and truck driver. The work performed by landscape plantsman and landscape laborer is covered by the existing classification of laborer. The work performed by landscape operators (regardless of equipment used or its size) is covered by the classifications of operating engineer. The work performed by landscape truck drivers (regardless of size of truck driven) is covered by the classifications of truck driver.

Schuyler County Prevailing Wage for May 2013

(See explanation of column headings at bottom of wages)

Trade Name	RG	TYP	C	Base	FRMAN	M-F>8	OSA	OSH	H/W	Pensn	Vac	Trng
=====	==	===	=	=====	=====	=====	===	===	=====	=====	=====	=====
ASBESTOS ABT-GEN		BLD		25.250	26.250	1.5	1.5	2.0	7.550	10.08	0.000	0.800
ASBESTOS ABT-MEC		BLD		29.860	30.860	1.5	1.5	2.0	6.950	3.000	0.000	0.000
BOILERMAKER		BLD		35.010	38.010	2.0	2.0	2.0	7.070	13.83	0.000	0.300
BRICK MASON		BLD		29.250	30.250	1.5	1.5	2.0	8.200	8.330	0.000	0.580
CARPENTER		BLD		27.670	29.920	1.5	1.5	2.0	7.450	14.58	0.000	0.520
CARPENTER		HWY		28.870	30.620	1.5	1.5	2.0	7.450	13.73	0.000	0.520
CEMENT MASON		BLD		25.200	26.700	1.5	1.5	2.0	6.600	12.10	0.000	0.500
CEMENT MASON		HWY		27.280	28.280	1.5	1.5	2.0	6.600	9.420	0.000	0.500
CERAMIC TILE FNSHER		BLD		25.600	0.000	1.5	1.5	2.0	8.200	7.230	0.000	0.000
ELECTRIC PWR EQMT OP		ALL		35.440	0.000	1.5	1.5	2.0	5.000	10.98	0.000	0.270
ELECTRIC PWR GRNDMAN		ALL		24.320	0.000	1.5	1.5	2.0	5.000	7.540	0.000	0.180
ELECTRIC PWR LINEMAN		ALL		39.370	41.910	1.5	1.5	2.0	5.000	12.20	0.000	0.300
ELECTRIC PWR TRK DRV		ALL		25.510	0.000	1.5	1.5	2.0	5.000	7.920	0.000	0.190
ELECTRICIAN		BLD		28.360	30.860	1.5	1.5	2.0	5.350	8.550	0.000	0.400
ELECTRONIC SYS TECH		BLD		27.430	29.180	1.5	1.5	2.0	5.350	9.320	0.000	0.400
ELEVATOR CONSTRUCTOR		BLD		40.520	45.585	2.0	2.0	2.0	11.88	12.71	3.240	0.600
GLAZIER		BLD		30.780	32.780	1.5	2.0	2.0	6.630	8.150	0.000	0.380
HT/FROST INSULATOR		BLD		37.260	38.260	1.5	1.5	2.0	7.850	11.16	0.000	0.500
IRON WORKER		BLD		29.460	31.460	1.5	1.5	2.0	7.740	11.38	0.000	0.660
IRON WORKER		HWY		30.600	32.100	1.5	1.5	2.0	7.740	11.69	0.000	0.660
LABORER		BLD		23.750	24.750	1.5	1.5	2.0	7.550	10.08	0.000	0.800
LABORER		HWY		24.910	25.910	1.5	1.5	2.0	7.550	10.63	0.000	0.800
LATHER		BLD		27.670	29.920	1.5	1.5	2.0	7.450	14.58	0.000	0.520
MACHINIST		BLD		43.550	46.050	1.5	1.5	2.0	6.130	8.950	1.850	0.000
MARBLE FINISHERS		BLD		25.600	0.000	1.5	1.5	2.0	8.200	7.230	0.000	0.000
MARBLE MASON		BLD		27.100	27.850	1.5	1.5	2.0	8.200	7.230	0.000	0.000
MILLWRIGHT		BLD		29.620	31.870	1.5	1.5	2.0	7.450	13.09	0.000	0.520

MILLWRIGHT		HWY		31.690	33.440	1.5	1.5	2.0	7.450	13.54	0.000	0.520
OPERATING ENGINEER		BLD 1		33.900	35.400	1.5	1.5	2.0	10.05	7.600	0.000	1.300
OPERATING ENGINEER		BLD 2		31.550	35.400	1.5	1.5	2.0	10.05	7.600	0.000	1.300
OPERATING ENGINEER		BLD 3		27.950	35.400	1.5	1.5	2.0	10.05	7.600	0.000	1.300
OPERATING ENGINEER		BLD 4		35.400	35.400	1.5	1.5	2.0	10.05	7.600	0.000	1.300
OPERATING ENGINEER		HWY 1		37.600	39.100	1.5	1.5	2.0	10.05	8.100	0.000	1.300
OPERATING ENGINEER		HWY 2		33.660	39.100	1.5	1.5	2.0	10.05	8.100	0.000	1.300
OPERATING ENGINEER		HWY 3		27.630	39.100	1.5	1.5	2.0	10.05	8.100	0.000	1.300
OPERATING ENGINEER		HWY 4		39.100	39.100	1.5	1.5	2.0	10.05	8.100	0.000	1.300
PAINTER		ALL		32.900	34.900	1.5	1.5	1.5	9.650	8.200	0.000	1.250
PILEDRIVER		BLD		28.170	30.420	1.5	1.5	2.0	7.450	14.58	0.000	0.520
PILEDRIVER		HWY		29.870	31.620	1.5	1.5	2.0	7.450	13.73	0.000	0.520
PIPEFITTER	E	BLD		37.400	41.510	1.5	1.5	2.0	7.000	11.63	0.000	1.060
PIPEFITTER	W	ALL		36.550	40.210	1.5	1.5	2.0	5.650	12.15	0.000	1.000
PLASTERER		BLD		28.500	30.250	1.5	1.5	2.0	7.330	11.29	0.000	0.500
PLUMBER	E	BLD		33.570	36.590	1.5	1.5	2.0	7.000	13.31	0.000	0.900
PLUMBER	W	ALL		36.550	40.210	1.5	1.5	2.0	5.650	12.15	0.000	1.000
ROOFER		BLD		28.580	30.010	1.5	1.5	2.0	8.450	7.220	0.000	0.250
SHEETMETAL WORKER		BLD		31.680	33.930	1.5	1.5	2.0	8.300	12.35	0.000	0.500
SPRINKLER FITTER		BLD		36.390	39.140	1.5	1.5	2.0	8.420	8.500	0.000	0.450
STONE MASON		BLD		29.250	30.250	1.5	1.5	2.0	8.200	8.330	0.000	0.580
TERRAZZO FINISHER		BLD		25.600	0.000	1.5	1.5	2.0	8.200	7.230	0.000	0.000
TERRAZZO MASON		BLD		27.100	27.850	1.5	1.5	2.0	8.200	7.230	0.000	0.000
TILE MASON		BLD		27.100	27.850	1.5	1.5	2.0	8.200	7.230	0.000	0.000
TRUCK DRIVER		ALL 1		31.340	0.000	1.5	1.5	2.0	10.30	5.010	0.000	0.250
TRUCK DRIVER		ALL 2		31.780	0.000	1.5	1.5	2.0	10.30	5.010	0.000	0.250
TRUCK DRIVER		ALL 3		32.020	0.000	1.5	1.5	2.0	10.30	5.010	0.000	0.250
TRUCK DRIVER		ALL 4		32.280	0.000	1.5	1.5	2.0	10.30	5.010	0.000	0.250
TRUCK DRIVER		ALL 5		33.130	0.000	1.5	1.5	2.0	10.30	5.010	0.000	0.250
TRUCK DRIVER		O&C 1		25.070	0.000	1.5	1.5	2.0	10.30	5.010	0.000	0.250
TRUCK DRIVER		O&C 2		25.420	0.000	1.5	1.5	2.0	10.30	5.010	0.000	0.250
TRUCK DRIVER		O&C 3		25.620	0.000	1.5	1.5	2.0	10.30	5.010	0.000	0.250
TRUCK DRIVER		O&C 4		25.820	0.000	1.5	1.5	2.0	10.30	5.010	0.000	0.250
TRUCK DRIVER		O&C 5		26.500	0.000	1.5	1.5	2.0	10.30	5.010	0.000	0.250
TUCKPOINTER		BLD		29.250	30.250	1.5	1.5	2.0	8.200	8.330	0.000	0.580

Legend :

RG (Region)

TYP (Trade Type - All,Highway,Building,Floating,Oil & Chip,Rivers)

C (Class)

Base (Base Wage Rate)

FRMAN (Foreman Rate)

M-F>8 (OT required for any hour greater than 8 worked each day, Mon through Fri.

OSA (Overtime (OT) is required for every hour worked on Saturday)

OSH (Overtime is required for every hour worked on Sunday and Holidays)

H/W (Health & Welfare Insurance)

Pensn (Pension)

Vac (Vacation)

Trng (Training)

Explanations

SCHUYLER COUNTY

PLUMBERS & PIPEFITTERS (EAST) - Townships of Frederick, Browning and Hickory (Eastern extension).

The following list is considered as those days for which holiday rates of wages for work performed apply: New Years Day, Memorial Day, Fourth of July, Labor Day, Thanksgiving Day, Christmas Day and Veterans Day in some classifications/counties. Generally, any of these holidays which fall on a Sunday is celebrated on the following Monday. This then makes work performed on that Monday payable at the appropriate overtime rate for holiday pay. Common practice in a given local may alter certain days of celebration. If in doubt, please check with IDOL.

Oil and chip resealing (O&C) means the application of road oils and liquid asphalt to coat an existing road surface, followed by application of aggregate chips or gravel to coated surface, and subsequent rolling of material to seal the surface.

EXPLANATION OF CLASSES

ASBESTOS - GENERAL - removal of asbestos material/mold and hazardous materials from any place in a building, including mechanical systems where those mechanical systems are to be removed. This includes the removal of asbestos materials/mold and hazardous materials from ductwork or pipes in a building when the building is to be demolished at the time or at some close future date.

ASBESTOS - MECHANICAL - removal of asbestos material from mechanical systems, such as pipes, ducts, and boilers, where the mechanical systems are to remain.

CERAMIC TILE FINISHER, MARBLE FINISHER, TERRAZZO FINISHER

Assisting, helping or supporting the tile, marble and terrazzo mechanic by performing their historic and traditional work assignments required to complete the proper installation of the work covered by said crafts. The term "Ceramic" is used for naming the classification only and is in no way a limitation of the product handled. Ceramic takes into consideration most hard tiles.

ELECTRONIC SYSTEMS TECHNICIAN

Installation, service and maintenance of low-voltage systems which utilizes the transmission and/or transference of voice, sound, vision, or digital for commercial, education, security and entertainment purposes for the following: TV monitoring and surveillance, background/foreground music, intercom and telephone interconnect, field programming, inventory control systems, microwave transmission, multi-media, multiplex, radio page, school, intercom and sound burglar alarms and low voltage master clock systems.

Excluded from this classification are energy management systems, life safety systems, supervisory controls and data acquisition systems not intrinsic with the above listed systems, fire alarm systems, nurse call systems and raceways exceeding fifteen feet in length.

TRUCK DRIVER - BUILDING, HEAVY AND HIGHWAY CONSTRUCTION

Class 1. Drivers on 2 axle trucks hauling less than 9 ton. Air

compressor and welding machines and brooms, including those pulled by separate units, truck driver helpers, warehouse employees, mechanic helpers, greasers and tiremen, pickup trucks when hauling materials, tools, or workers to and from and on-the-job site, and fork lifts up to 6,000 lb. capacity.

Class 2. Two or three axle trucks hauling more than 9 ton but hauling less than 16 ton. A-frame winch trucks, hydrolift trucks, vactor trucks or similar equipment when used for transportation purposes. Fork lifts over 6,000 lb. capacity, winch trucks, four axle combination units, and ticket writers.

Class 3. Two, three or four axle trucks hauling 16 ton or more. Drivers on water pulls, articulated dump trucks, mechanics and working forepersons, and dispatchers. Five axle or more combination units.

Class 4. Low Boy and Oil Distributors.

Class 5. Drivers who require special protective clothing while employed on hazardous waste work.

TRUCK DRIVER - OIL AND CHIP RESEALING ONLY.

This shall encompass laborers, workers and mechanics who drive contractor or subcontractor owned, leased, or hired pickup, dump, service, or oil distributor trucks. The work includes transporting materials and equipment (including but not limited to, oils, aggregate supplies, parts, machinery and tools) to or from the job site; distributing oil or liquid asphalt and aggregate; stock piling material when in connection with the actual oil and chip contract. The Truck Driver (Oil & Chip Resealing) wage classification does not include supplier delivered materials.

OPERATING ENGINEERS - BUILDING

CLASS 1. Asphalt Screed Man; Aspco Concrete Spreaders; Asphalt Pavers; Asphalt Plant Engineer; Asphalt Rollers on Bituminous Concrete; Athey Loaders; Backfillers, Crane Type; Backhoes; Barber Green Loaders; Bulldozers; Cableways; Cherry Pickers; Clam Shells; C.M.I. & similar type autograde formless paver, autograde placer & finisher; Concrete Breakers; Concrete Pumps; Derricks; Derrick Boats; Draglines; Earth Auger or Boring Machines; Elevating Graders; Engineers on Dredges; Gravel Processing Machines; Head Equipment Greaser; High Lifts or Fork Lifts; Hoists with two or more drums or two or more load lines; Locomotives, All; Mechanics; Motor Graders or Auto Patrols; Operators or Leverman on Dredges; Operators, Power Boat; Operators, Pug Mill (Asphalt Plants); Orange Peels; Overhead Cranes; Paving Mixers; Piledrivers; Pipe Wrapping and Painting Machines; Pushdozers, or Push Cats; Robotic Controlled Equipment in this Classification; Rock Crushers; Ross Carrier or Similar Machines; Rotomill; Scoops, Skimmer, two cu. yd. capacity and under; Scoops, All or Tournapull; Sheep-Foot Roller (Self Propelled); Shovels; Skid Steer; Skimmer Scoops; Temporary Concrete Plant Operators; Test Hole Drilling Machines; Tower Machines; Tower Mixers; Track Type End Loaders; Track Type Fork Lifts or High Lifts; Track Jacks and Tampers; Tractors, Sideboom; Trenching or Ditching Machine; Tunnelluggers; Vermeer Type Saws; Water Blaster Cutting Head; Wheel Type End Loaders; Winch Cat.

CLASS 2. Air Compressors (six to eight)*; Asphalt Boosters and Heaters; Asphalt Distributors; Asphalt Plant Fireman; Oiler on Two Paving Mixers When Used in Tandem; Boom or Winch Trucks; Bull Floats or Flexplanes; Concrete Finishing Machine; Concrete Saws, Self-Propelled; Concrete Spreading Machines; Conveyors (six to eight)*; Generators (six to eight)*; Gravel or Stone Spreader, Power Operated; Hoist (with One Drum and One Load Line); Light Plants (six

to eight)*; Mechanical Heaters (six to eight)*; Mud Jacks; Post Hole Digger, Mechanical; Pug Mills when used for other than Asphalt operation; Robotic Controlled Equipment in this Classification; Road or Street Sweeper, Self Propelled; Rollers (except bituminous concrete); Seaman Tiller; Straw Machine; Vibratory Compactor; Water Blaster, Power Unit; Welding Machines (six to eight)*; Well Drill Machines.

CLASS 3. Air Compressors(one to five)*; Air Compressors, Track or Self-Propelled; Automatic Hoist; Building Elevators; Bulk Cement Batching Plants; Conveyors (one to five)*; Concrete Mixers (Except Plant, Paver, or Tower); Firemen; Generators (one to five)*; Greasers; Helper on Single Paving Mixer; Hoist, Automatic; Light Plants (one to five)*; Mechanic Helpers; Mechanical Heaters (one to five)*; Oilers; Power Form Graders; Power Sub-Graders; Robotic Controlled Equipment in this Classification; Scissors Hoist; Tractors without power attachments regardless of size or type; Truck Crane Oiler and Driver (1 man); Vibratory Hammer (power source); Water Pumps (one to five)*; Welding Machines (1/300 Amp. or over)*; Welding machines (one to five)*

CLASS 4. Lattice Boom Crawler Cranes; Lattice Boom Truck Cranes; Telescopic Truck-Mounted Cranes; Tower Cranes.

* Combinations of one to eight of any Air Compressors, Conveyors, Welding Machines, Water Pumps, Light Plants, or Generators shall be in batteries or within 400 feet and shall be paid as per the Classification Schedule contained in this Article.

OPERATING ENGINEERS - HIGHWAY

CLASS 1. Asphalt Screed Man; Asphco Concrete Spreaders; Asphalt Pavers; Asphalt Plant Engineer; Asphalt Rollers on Bituminous Concrete; Athey Loaders; Backhoes; Barber Green Loaders; Bulldozers; Cableways; Carry Deck Pickers; Cherry Pickers (Rough Terrain); C.M.I. & similar type-autograde formless paver, autograde placer & finisher; Concrete Breakers; Concrete Plant Operators; Concrete Pumps; Derricks; Derrick Boats; Dewatering Systems; Earth Auger or Boring Machines; Elevating Graders; Engineers on Dredges; Gravel Processing Machines; Grout Pump; Head Equipment Greaser; High Lifts or Fork Lifts; Hoists with two or more drums or two or more load lines; Hydro Jet or Hydro Laser; Locomotives, All; Mechanics; Motor Graders or Auto Patrols; Multi-Point Power Lifting Equipment; Operators or Leverman on Dredges; Operators, Power Boat; Operators, Pug Mill (Asphalt Plants); Overhead Cranes; Paving Mixers; Piledrivers; Pipe Wrapping and Painting Machines; Push-dozers, or Push Cats; Robotic Controlled Equipment in this Classification; Rock Crushers; Ross Carrier or Similar Machines; Roto-Mill; Scoops, Skimmer, two cu. yd. capacity and under; Sheep-Foot Roller (Self Pro-pelled); Shovels; Skid Steer; Skimmer Scoops; Test Hole Drilling Machines; Tower Machines; Tower Mixers; Track Type End Loaders; Track Type Fork Lifts or High Lifts; Track Jacks and Tampers; Tractors, Side-boom; Trenching or Ditching Machine; Tunnelluggers; Vermeer-Type Saws; Wheel Type End Loaders; Winch Cat; Scoops, All or Tournapull.

CLASS 2. Air Compressors (six to eight)*; Articulated Dumps; Asphalt Boosters and Heaters; Asphalt Distributors; Asphalt Plant Fireman; Boom or Winch Trucks; Building Elevators; Bull Floats or Flexplanes; Concrete Finishing Machine; Concrete Saws, Self-Propelled; Concrete Spreading Machines; Conveyors (six to eight)*; Generators (six to eight)*; Gravel or Stone Spreader, Power Operated; Hoist, Automatic; Hoist with One Drum and One Load Line; Light Plants (six to eight)*; Mechanical Heaters (six to eight)*; Mud Jacks; Off Road Water Wagons; Oiler on Two Paving Mixers When Used in Tandem; Post Hole Digger,

Mechanical; Robotic Controlled Equipment in This Classification; Road or Street Sweeper, Self-Propelled; Rollers (except bituminous concrete); Scissor Hoist; Sea-man Tiller; Straw Machine; Vibratory Compactor; Water Pumps (six to eight)*; Well Drill Machines.

CLASS 3. Air Compressors (one to five)*; Air Compressors, Track or Self-Propelled; Bulk Cement Batching Plants; Conveyors (one to five)*; Concrete Mixers (Except Plant, Paver, or Tower); Firemen; Generators (one to five)*; Greasers; Helper on Single Paving Mixer; Light Plants (one to five)*; Mechanic Helpers; Mechanical Heaters (one to five)*; Oilers; Power Form Graders; Power Sub-Graders; Pug Mills when used for other than Asphalt operation; Robotic Controlled Equipment in This Classification; Tractors without power attachments, regardless of size or type; Truck Crane Oiler and Driver (1 man); Vibratory Hammer (power source); Water Pumps (one to five)*; Welding Machines (one 300 Amp. or over)*; Welding Machines (one to five)*.

CLASS 4. Lattice Boom Crawler Crane; Lattice Boom Truck Crane; Telescopic Truck-Mounted Crane; Tower Crane.

*Combinations of one to eight of any Air Compressors, Conveyors, Welding Machines, Water Pumps, Light Plants or Generators shall be in batteries or within 400 feet and shall be paid as per the Classification Schedule contained in this Article.

Other Classifications of Work:

For definitions of classifications not otherwise set out, the Department generally has on file such definitions which are available. If a task to be performed is not subject to one of the classifications of pay set out, the Department will upon being contacted state which neighboring county has such a classification and provide such rate, such rate being deemed to exist by reference in this document. If no neighboring county rate applies to the task, the Department shall undertake a special determination, such special determination being then deemed to have existed under this determination. If a project requires these, or any classification not listed, please contact IDOL at 217-782-1710 for wage rates or clarifications.

LANDSCAPING

Landscaping work falls under the existing classifications for laborer, operating engineer and truck driver. The work performed by landscape plantsman and landscape laborer is covered by the existing classification of laborer. The work performed by landscape operators (regardless of equipment used or its size) is covered by the classifications of operating engineer. The work performed by landscape truck drivers (regardless of size of truck driven) is covered by the classifications of truck driver.

Scott County Prevailing Wage for May 2013

(See explanation of column headings at bottom of wages)

Trade Name	RG	TYP	C	Base	FRMAN	M-F>8	OSA	OSH	H/W	Pensn	Vac	Trng
=====	==	===	=	=====	=====	=====	===	===	=====	=====	=====	=====
ASBESTOS ABT-GEN		BLD		28.200	29.450	1.5	1.5	2.0	5.750	10.22	0.000	0.900
ASBESTOS ABT-MEC		BLD		29.860	30.860	1.5	1.5	2.0	6.950	3.000	0.000	0.000
BOILERMAKER		BLD		31.500	34.000	1.5	1.5	2.0	7.070	18.73	1.000	0.350
BRICK MASON		BLD		29.250	30.250	1.5	1.5	2.0	8.200	8.330	0.000	0.580
CARPENTER		BLD		27.670	29.920	1.5	1.5	2.0	7.450	14.58	0.000	0.520
CARPENTER		HWY		28.870	30.620	1.5	1.5	2.0	7.450	13.73	0.000	0.520

CEMENT MASON	BLD	29.350	30.350	2.0	2.0	2.0	8.200	8.330	0.000	0.580
CEMENT MASON	HWY	26.870	27.870	1.5	1.5	2.0	8.200	7.530	0.000	0.000
CERAMIC TILE FNSHER	BLD	25.600	0.000	1.5	1.5	2.0	8.200	7.230	0.000	0.000
ELECTRIC PWR EQMT OP	ALL	35.440	0.000	1.5	1.5	2.0	5.000	10.98	0.000	0.270
ELECTRIC PWR GRNDMAN	ALL	24.320	0.000	1.5	1.5	2.0	5.000	7.540	0.000	0.180
ELECTRIC PWR LINEMAN	ALL	39.370	41.910	1.5	1.5	2.0	5.000	12.20	0.000	0.300
ELECTRIC PWR TRK DRV	ALL	25.510	0.000	1.5	1.5	2.0	5.000	7.920	0.000	0.190
ELECTRICIAN	BLD	34.220	36.220	1.5	1.5	2.0	5.860	8.120	0.000	0.400
ELECTRONIC SYS TECH	BLD	30.390	32.140	1.5	1.5	2.0	5.350	7.160	0.000	0.400
ELEVATOR CONSTRUCTOR	BLD	40.520	45.585	2.0	2.0	2.0	11.88	12.71	3.240	0.600
GLAZIER	BLD	30.780	32.780	1.5	2.0	2.0	6.630	8.150	0.000	0.380
HT/FROST INSULATOR	BLD	37.260	38.260	1.5	1.5	2.0	7.850	11.16	0.000	0.500
IRON WORKER	BLD	29.460	31.460	1.5	1.5	2.0	7.740	11.38	0.000	0.660
IRON WORKER	HWY	30.600	32.100	1.5	1.5	2.0	7.740	11.69	0.000	0.660
LABORER	BLD	26.200	27.450	1.5	1.5	2.0	5.750	10.22	0.000	0.800
LABORER	HWY	28.210	28.960	1.5	1.5	2.0	5.750	10.32	0.000	0.800
LATHER	BLD	27.670	29.920	1.5	1.5	2.0	7.450	14.58	0.000	0.520
MACHINIST	BLD	43.550	46.050	1.5	1.5	2.0	6.130	8.950	1.850	0.000
MARBLE FINISHERS	BLD	25.600	0.000	1.5	1.5	2.0	8.200	7.230	0.000	0.000
MARBLE MASON	BLD	27.100	27.850	1.5	1.5	2.0	8.200	7.230	0.000	0.000
MILLWRIGHT	BLD	29.620	31.870	1.5	1.5	2.0	7.450	13.09	0.000	0.520
MILLWRIGHT	HWY	31.690	33.440	1.5	1.5	2.0	7.450	13.54	0.000	0.520
OPERATING ENGINEER	BLD 1	33.900	35.400	1.5	1.5	2.0	10.05	7.600	0.000	1.300
OPERATING ENGINEER	BLD 2	31.550	35.400	1.5	1.5	2.0	10.05	7.600	0.000	1.300
OPERATING ENGINEER	BLD 3	27.950	35.400	1.5	1.5	2.0	10.05	7.600	0.000	1.300
OPERATING ENGINEER	BLD 4	35.400	35.400	1.5	1.5	2.0	10.05	7.600	0.000	1.300
OPERATING ENGINEER	HWY 1	37.600	39.100	1.5	1.5	2.0	10.05	8.100	0.000	1.300
OPERATING ENGINEER	HWY 2	33.660	39.100	1.5	1.5	2.0	10.05	8.100	0.000	1.300
OPERATING ENGINEER	HWY 3	27.630	39.100	1.5	1.5	2.0	10.05	8.100	0.000	1.300
OPERATING ENGINEER	HWY 4	39.100	39.100	1.5	1.5	2.0	10.05	8.100	0.000	1.300
PAINTER	ALL	28.580	30.080	1.5	1.5	2.0	5.000	8.580	0.000	0.550
PAINTER OVER 30FT	ALL	29.580	31.080	1.5	1.5	2.0	5.000	8.580	0.000	0.550
PAINTER PWR EQMT	ALL	29.580	31.080	1.5	1.5	2.0	5.000	8.580	0.000	0.550
PILEDRIVER	BLD	28.170	30.420	1.5	1.5	2.0	7.450	14.58	0.000	0.520
PILEDRIVER	HWY	29.870	31.620	1.5	1.5	2.0	7.450	13.73	0.000	0.520
PIPEFITTER	BLD	40.020	44.020	1.5	1.5	2.0	7.000	7.750	0.000	0.900
PLASTERER	BLD	29.350	30.350	2.0	2.0	2.0	8.200	8.330	0.000	0.580
PLUMBER	BLD	40.020	44.020	1.5	1.5	2.0	7.000	7.750	0.000	0.900
ROOFER	BLD	27.900	30.400	1.5	1.5	2.0	8.600	6.750	0.000	0.500
SHEETMETAL WORKER	BLD	31.680	33.930	1.5	1.5	2.0	8.300	12.35	0.000	0.500
SPRINKLER FITTER	BLD	36.390	39.140	1.5	1.5	2.0	8.420	8.500	0.000	0.450
STONE MASON	BLD	29.250	30.250	1.5	1.5	2.0	8.200	8.330	0.000	0.580
TERRAZZO FINISHER	BLD	25.600	0.000	1.5	1.5	2.0	8.200	7.230	0.000	0.000
TERRAZZO MASON	BLD	27.100	27.850	1.5	1.5	2.0	8.200	7.230	0.000	0.000
TILE MASON	BLD	27.100	27.850	1.5	1.5	2.0	8.200	7.230	0.000	0.000
TRUCK DRIVER	ALL 1	31.340	0.000	1.5	1.5	2.0	10.30	5.010	0.000	0.250
TRUCK DRIVER	ALL 2	31.780	0.000	1.5	1.5	2.0	10.30	5.010	0.000	0.250
TRUCK DRIVER	ALL 3	32.020	0.000	1.5	1.5	2.0	10.30	5.010	0.000	0.250
TRUCK DRIVER	ALL 4	32.280	0.000	1.5	1.5	2.0	10.30	5.010	0.000	0.250
TRUCK DRIVER	ALL 5	33.130	0.000	1.5	1.5	2.0	10.30	5.010	0.000	0.250
TRUCK DRIVER	O&C 1	25.070	0.000	1.5	1.5	2.0	10.30	5.010	0.000	0.250
TRUCK DRIVER	O&C 2	25.420	0.000	1.5	1.5	2.0	10.30	5.010	0.000	0.250
TRUCK DRIVER	O&C 3	25.620	0.000	1.5	1.5	2.0	10.30	5.010	0.000	0.250
TRUCK DRIVER	O&C 4	25.820	0.000	1.5	1.5	2.0	10.30	5.010	0.000	0.250
TRUCK DRIVER	O&C 5	26.500	0.000	1.5	1.5	2.0	10.30	5.010	0.000	0.250
TUCKPOINTER	BLD	29.250	30.250	1.5	1.5	2.0	8.200	8.330	0.000	0.580

Legend:

RG (Region)

TYP (Trade Type - All,Highway,Building,Floating,Oil & Chip,Rivers)

C (Class)

Base (Base Wage Rate)

FRMAN (Foreman Rate)

M-F>8 (OT required for any hour greater than 8 worked each day, Mon through Fri.)

OSA (Overtime (OT) is required for every hour worked on Saturday)

OSH (Overtime is required for every hour worked on Sunday and Holidays)

H/W (Health & Welfare Insurance)

Pensn (Pension)

Vac (Vacation)

Trng (Training)

Explanations

SCOTT COUNTY

The following list is considered as those days for which holiday rates of wages for work performed apply: New Years Day, Memorial Day, Fourth of July, Labor Day, Thanksgiving Day, Christmas Day and Veterans Day in some classifications/counties. Generally, any of these holidays which fall on a Sunday is celebrated on the following Monday. This then makes work performed on that Monday payable at the appropriate overtime rate for holiday pay. Common practice in a given local may alter certain days of celebration. If in doubt, please check with IDOL.

Oil and chip resealing (O&C) means the application of road oils and liquid asphalt to coat an existing road surface, followed by application of aggregate chips or gravel to coated surface, and subsequent rolling of material to seal the surface.

EXPLANATION OF CLASSES

ASBESTOS - GENERAL - removal of asbestos material/mold and hazardous materials from any place in a building, including mechanical systems where those mechanical systems are to be removed. This includes the removal of asbestos materials/mold and hazardous materials from ductwork or pipes in a building when the building is to be demolished at the time or at some close future date.

ASBESTOS - MECHANICAL - removal of asbestos material from mechanical systems, such as pipes, ducts, and boilers, where the mechanical systems are to remain.

CERAMIC TILE FINISHER, MARBLE FINISHER, TERRAZZO FINISHER

Assisting, helping or supporting the tile, marble and terrazzo mechanic by performing their historic and traditional work assignments required to complete the proper installation of the work covered by said crafts. The term "Ceramic" is used for naming the classification only and is in no way a limitation of the product handled. Ceramic takes into consideration most hard tiles.

ELECTRONIC SYSTEMS TECHNICIAN

Installation, service and maintenance of low-voltage systems which utilizes the transmission and/or transference of voice, sound, vision, or digital for commercial, education, security and entertainment purposes for the following: TV monitoring and surveillance, background/foreground music, intercom and telephone interconnect, field programming, inventory control systems, microwave transmission, multi-media, multiplex, radio page, school, intercom and sound burglar alarms and low voltage master clock systems.

Excluded from this classification are energy management systems, life safety systems, supervisory controls and data acquisition systems not intrinsic with the above listed systems, fire alarm systems, nurse call systems and raceways exceeding fifteen feet in length.

TRUCK DRIVER - BUILDING, HEAVY AND HIGHWAY CONSTRUCTION

Class 1. Drivers on 2 axle trucks hauling less than 9 ton. Air compressor and welding machines and brooms, including those pulled by separate units, truck driver helpers, warehouse employees, mechanic helpers, greasers and tiremen, pickup trucks when hauling materials, tools, or workers to and from and on-the-job site, and fork lifts up to 6,000 lb. capacity.

Class 2. Two or three axle trucks hauling more than 9 ton but hauling less than 16 ton. A-frame winch trucks, hydrolift trucks, vector trucks or similar equipment when used for transportation purposes. Fork lifts over 6,000 lb. capacity, winch trucks, four axle combination units, and ticket writers.

Class 3. Two, three or four axle trucks hauling 16 ton or more. Drivers on water pulls, articulated dump trucks, mechanics and working forepersons, and dispatchers. Five axle or more combination units.

Class 4. Low Boy and Oil Distributors.

Class 5. Drivers who require special protective clothing while employed on hazardous waste work.

TRUCK DRIVER - OIL AND CHIP RESEALING ONLY.

This shall encompass laborers, workers and mechanics who drive contractor or subcontractor owned, leased, or hired pickup, dump, service, or oil distributor trucks. The work includes transporting materials and equipment (including but not limited to, oils, aggregate supplies, parts, machinery and tools) to or from the job site; distributing oil or liquid asphalt and aggregate; stock piling material when in connection with the actual oil and chip contract. The Truck Driver (Oil & Chip Resealing) wage classification does not include supplier delivered materials.

OPERATING ENGINEERS - BUILDING

CLASS 1. Asphalt Screed Man; Aspco Concrete Spreaders; Asphalt Pavers; Asphalt Plant Engineer; Asphalt Rollers on Bituminous Concrete; Athey Loaders; Backfillers, Crane Type; Backhoes; Barber Green Loaders; Bulldozers; Cableways; Cherry Pickers; Clam Shells; C.M.I. & similar type autograde formless paver, autograde placer & finisher; Concrete Breakers; Concrete Pumps; Derricks; Derrick Boats; Draglines; Earth Auger or Boring Machines; Elevating Graders; Engineers on Dredges; Gravel Processing Machines; Head Equipment Greaser; High Lifts or Fork Lifts; Hoists with two or more drums or two or more load lines; Locomotives, All; Mechanics; Motor Graders or Auto Patrols; Operators or Leverman on Dredges; Operators, Power Boat; Operators, Pug Mill (Asphalt Plants); Orange Peels; Overhead Cranes; Paving Mixers; Piledrivers; Pipe Wrapping and Painting Machines; Pushdozers, or Push Cats; Robotic Controlled Equipment in this

Classification; Rock Crushers; Ross Carrier or Similar Machines; Rotomill; Scoops, Skimmer, two cu. yd. capacity and under; Scoops, All or Tournapull; Sheep-Foot Roller (Self Propelled); Shovels; Skid Steer; Skimmer Scoops; Temporary Concrete Plant Operators; Test Hole Drilling Machines; Tower Machines; Tower Mixers; Track Type End Loaders; Track Type Fork Lifts or High Lifts; Track Jacks and Tampers; Tractors, Sideboom; Trenching or Ditching Machine; Tunnelluggers; Vermeer Type Saws; Water Blaster Cutting Head; Wheel Type End Loaders; Winch Cat.

CLASS 2. Air Compressors (six to eight)*; Asphalt Boosters and Heaters; Asphalt Distributors; Asphalt Plant Fireman; Oiler on Two Paving Mixers When Used in Tandem; Boom or Winch Trucks; Bull Floats or Flexplanes; Concrete Finishing Machine; Concrete Saws, Self-Propelled; Concrete Spreading Machines; Conveyors (six to eight)*; Generators (six to eight)*; Gravel or Stone Spreader, Power Operated; Hoist (with One Drum and One Load Line); Light Plants (six to eight)*; Mechanical Heaters (six to eight)*; Mud Jacks; Post Hole Digger, Mechanical; Pug Mills when used for other than Asphalt operation; Robotic Controlled Equipment in this Classification; Road or Street Sweeper, Self Propelled; Rollers (except bituminous concrete); Seaman Tiller; Straw Machine; Vibratory Compactor; Water Blaster, Power Unit; Welding Machines (six to eight)*; Well Drill Machines.

CLASS 3. Air Compressors(one to five)*; Air Compressors, Track or Self-Propelled; Automatic Hoist; Building Elevators; Bulk Cement Batching Plants; Conveyors (one to five)*; Concrete Mixers (Except Plant, Paver, or Tower); Firemen; Generators (one to five)*; Greasers; Helper on Single Paving Mixer; Hoist, Automatic; Light Plants (one to five)*; Mechanic Helpers; Mechanical Heaters (one to five)*; Oilers; Power Form Graders; Power Sub-Graders; Robotic Controlled Equipment in this Classification; Scissors Hoist; Tractors without power attachments regardless of size or type; Truck Crane Oiler and Driver (1 man); Vibratory Hammer (power source); Water Pumps (one to five)*; Welding Machines (1/300 Amp. or over)*; Welding machines (one to five)*

CLASS 4. Lattice Boom Crawler Cranes; Lattice Boom Truck Cranes; Telescopic Truck-Mounted Cranes; Tower Cranes.

* Combinations of one to eight of any Air Compressors, Conveyors, Welding Machines, Water Pumps, Light Plants, or Generators shall be in batteries or within 400 feet and shall be paid as per the Classification Schedule contained in this Article.

OPERATING ENGINEERS - HIGHWAY

CLASS 1. Asphalt Screed Man; Asphco Concrete Spreaders; Asphalt Pavers; Asphalt Plant Engineer; Asphalt Rollers on Bituminous Concrete; Athey Loaders; Backhoes; Barber Green Loaders; Bulldozers; Cableways; Carry Deck Pickers; Cherry Pickers (Rough Terrain); C.M.I. & similar type-autograde formless paver, autograde placer & finisher; Concrete Breakers; Concrete Plant Operators; Concrete Pumps; Derricks; Derrick Boats; Dewatering Systems; Earth Auger or Boring Machines; Elevating Graders; Engineers on Dredges; Gravel Processing Machines; Grout Pump; Head Equipment Greaser; High Lifts or Fork Lifts; Hoists with two or more drums or two or more load lines; Hydro Jet or Hydro Laser; Locomotives, All; Mechanics; Motor Graders or Auto Patrols; Multi-Point Power Lifting Equipment; Operators or Leverman on Dredges; Operators, Power Boat; Operators, Pug Mill (Asphalt Plants); Overhead Cranes; Paving Mixers; Piledrivers; Pipe Wrapping and Painting Machines; Push-dozers, or Push Cats; Robotic Controlled Equipment in this Classification; Rock Crushers; Ross Carrier or Similar Machines;

Roto-Mill; Scoops, Skimmer, two cu. yd. capacity and under; Sheep-Foot Roller (Self Pro-pelled); Shovels; Skid Steer; Skimmer Scoops; Test Hole Drilling Machines; Tower Machines; Tower Mixers; Track Type End Loaders; Track Type Fork Lifts or High Lifts; Track Jacks and Tampers; Tractors, Side-boom; Trenching or Ditching Machine; Tunnelluggers; Vermeer-Type Saws; Wheel Type End Loaders; Winch Cat; Scoops, All or Tournapull.

CLASS 2. Air Compressors (six to eight)*; Articulated Dumps; Asphalt Boosters and Heaters; Asphalt Distributors; Asphalt Plant Fireman; Boom or Winch Trucks; Building Elevators; Bull Floats or Flexplanes; Concrete Finishing Machine; Concrete Saws, Self-Propelled; Concrete Spreading Machines; Conveyors (six to eight)*; Generators (six to eight)*; Gravel or Stone Spreader, Power Operated; Hoist, Automatic; Hoist with One Drum and One Load Line; Light Plants (six to eight)*; Mechanical Heaters (six to eight)*; Mud Jacks; Off Road Water Wagons; Oiler on Two Paving Mixers When Used in Tandem; Post Hole Digger, Mechanical; Robotic Controlled Equipment in This Classification; Road or Street Sweeper, Self-Propelled; Rollers (except bituminous concrete); Scissor Hoist; Sea-man Tiller; Straw Machine; Vibratory Compactor; Water Pumps (six to eight)*; Well Drill Machines.

CLASS 3. Air Compressors (one to five)*; Air Compressors, Track or Self-Propelled; Bulk Cement Batching Plants; Conveyors (one to five)*; Concrete Mixers (Except Plant, Paver, or Tower); Firemen; Generators (one to five)*; Greasers; Helper on Single Paving Mixer; Light Plants (one to five)*; Mechanic Helpers; Mechanical Heaters (one to five)*; Oilers; Power Form Graders; Power Sub-Graders; Pug Mills when used for other than Asphalt operation; Robotic Controlled Equipment in This Classification; Tractors without power attachments, regardless of size or type; Truck Crane Oiler and Driver (1 man); Vibratory Hammer (power source); Water Pumps (one to five)*; Welding Machines (one 300 Amp. or over)*; Welding Machines (one to five)*.

CLASS 4. Lattice Boom Crawler Crane; Lattice Boom Truck Crane; Telescopic Truck-Mounted Crane; Tower Crane.

*Combinations of one to eight of any Air Compressors, Conveyors, Welding Machines, Water Pumps, Light Plants or Generators shall be in batteries or within 400 feet and shall be paid as per the Classification Schedule contained in this Article.

Other Classifications of Work:

For definitions of classifications not otherwise set out, the Department generally has on file such definitions which are available. If a task to be performed is not subject to one of the classifications of pay set out, the Department will upon being contacted state which neighboring county has such a classification and provide such rate, such rate being deemed to exist by reference in this document. If no neighboring county rate applies to the task, the Department shall undertake a special determination, such special determination being then deemed to have existed under this determination. If a project requires these, or any classification not listed, please contact IDOL at 217-782-1710 for wage rates or clarifications.

LANDSCAPING

Landscaping work falls under the existing classifications for laborer, operating engineer and truck driver. The work performed by landscape plantsman and landscape laborer is covered by the existing classification of laborer. The work performed by landscape operators (regardless of equipment used or its size) is covered by the

classifications of operating engineer. The work performed by landscape truck drivers (regardless of size of truck driven) is covered by the classifications of truck driver.

Shelby County Prevailing Wage for May 2013

(See explanation of column headings at bottom of wages)

Trade Name	RG	TYP	C	Base	FRMAN	M-F>8	OSA	OSH	H/W	Pensn	Vac	Trng
ASBESTOS ABT-GEN		BLD		29.710	30.960	1.5	1.5	2.0	5.750	9.920	0.000	0.900
ASBESTOS ABT-MEC		BLD		29.860	30.860	1.5	1.5	2.0	6.950	3.000	0.000	0.000
BOILERMAKER		BLD		31.500	34.000	1.5	1.5	2.0	7.070	18.73	1.000	0.350
BRICK MASON		BLD		29.130	30.630	1.5	1.5	2.0	8.200	10.03	0.000	0.580
CARPENTER		BLD		29.600	31.850	1.5	1.5	2.0	7.450	12.65	0.000	0.520
CARPENTER		HWY		29.950	31.700	1.5	1.5	2.0	7.450	12.65	0.000	0.520
CEMENT MASON		BLD		29.800	31.300	1.5	1.5	2.0	6.600	8.360	0.000	0.500
CEMENT MASON		HWY		30.390	31.890	1.5	1.5	2.0	6.600	8.560	0.000	0.500
CERAMIC TILE FNSHER		BLD		25.480	0.000	1.5	1.5	2.0	8.200	8.930	0.000	0.000
ELECTRIC PWR EQMT OP		ALL	1	35.570	0.000	1.5	1.5	2.0	5.000	9.960	0.000	0.360
ELECTRIC PWR EQMT OP		ALL	2	31.740	0.000	1.5	1.5	2.0	5.000	8.880	0.000	0.320
ELECTRIC PWR GRNDMAN		ALL		26.100	0.000	1.5	1.5	2.0	5.000	7.310	0.000	0.260
ELECTRIC PWR LINEMAN		ALL		44.630	47.650	1.5	1.5	2.0	5.000	12.50	0.000	0.450
ELECTRICIAN		BLD		34.200	37.620	1.5	1.5	2.0	5.350	7.610	0.000	0.510
ELECTRONIC SYS TECH		BLD		31.130	32.880	1.5	1.5	2.0	5.350	6.110	0.000	0.400
ELEVATOR CONSTRUCTOR		BLD		40.520	45.585	2.0	2.0	2.0	11.88	12.71	3.240	0.600
GLAZIER		BLD		30.780	32.780	1.5	2.0	2.0	6.630	8.150	0.000	0.380
HT/FROST INSULATOR		BLD		37.260	38.260	1.5	1.5	2.0	7.850	11.16	0.000	0.500
IRON WORKER		BLD		29.460	31.460	1.5	1.5	2.0	7.740	11.38	0.000	0.660
IRON WORKER		HWY		30.600	32.100	1.5	1.5	2.0	7.740	11.69	0.000	0.660
LABORER		BLD		27.710	28.960	1.5	1.5	2.0	5.750	9.920	0.000	0.800
LABORER		HWY		29.120	30.120	1.5	1.5	2.0	5.750	9.920	0.000	0.800
LATHER		BLD		29.600	31.850	1.5	1.5	2.0	7.450	12.65	0.000	0.520
MACHINIST		BLD		43.550	46.050	1.5	1.5	2.0	6.130	8.950	1.850	0.000
MARBLE FINISHERS		BLD		25.480	0.000	1.5	1.5	2.0	8.200	8.930	0.000	0.000
MARBLE MASON		BLD		26.980	28.230	1.5	1.5	2.0	8.200	8.930	0.000	0.000
MILLWRIGHT		BLD		29.620	31.870	1.5	1.5	2.0	7.450	13.09	0.000	0.520
MILLWRIGHT		HWY		31.400	33.150	1.5	1.5	2.0	7.450	13.54	0.000	0.520
OPERATING ENGINEER		BLD	1	33.900	35.400	1.5	1.5	2.0	10.05	7.600	0.000	1.300
OPERATING ENGINEER		BLD	2	31.550	35.400	1.5	1.5	2.0	10.05	7.600	0.000	1.300
OPERATING ENGINEER		BLD	3	27.950	35.400	1.5	1.5	2.0	10.05	7.600	0.000	1.300
OPERATING ENGINEER		BLD	4	35.400	35.400	1.5	1.5	2.0	10.05	7.600	0.000	1.300
OPERATING ENGINEER		HWY	1	37.600	39.100	1.5	1.5	2.0	10.05	8.100	0.000	1.300
OPERATING ENGINEER		HWY	2	33.660	39.100	1.5	1.5	2.0	10.05	8.100	0.000	1.300
OPERATING ENGINEER		HWY	3	27.630	39.100	1.5	1.5	2.0	10.05	8.100	0.000	1.300
OPERATING ENGINEER		HWY	4	39.100	39.100	1.5	1.5	2.0	10.05	8.100	0.000	1.300
PAINTER		ALL		28.250	29.750	1.5	1.5	2.0	5.750	9.420	0.000	0.650
PAINTER OVER 30FT		ALL		28.500	30.000	1.5	1.5	2.0	5.750	9.420	0.000	0.650
PAINTER PWR EQMT		ALL		29.250	30.750	1.5	1.5	2.0	5.750	9.420	0.000	0.650
PILEDRIVER		BLD		30.100	32.350	1.5	1.5	2.0	7.450	12.65	0.000	0.520
PILEDRIVER		HWY		30.950	32.700	1.5	1.5	2.0	7.450	12.65	0.000	0.520
PIPEFITTER		BLD		36.050	39.050	1.5	1.5	2.0	7.000	7.650	0.000	1.220
PLASTERER		BLD		30.000	32.000	1.5	1.5	2.0	6.600	10.17	0.000	0.500
PLUMBER		BLD		36.050	39.050	1.5	1.5	2.0	7.000	7.650	0.000	1.220
ROOFER		BLD		26.100	28.600	1.5	1.5	2.0	9.600	6.280	0.000	0.550
SHEETMETAL WORKER		BLD		33.640	35.640	1.5	1.5	2.0	8.300	12.00	0.000	0.520
SPRINKLER FITTER		BLD		36.390	39.140	1.5	1.5	2.0	8.420	8.500	0.000	0.450
STONE MASON		BLD		29.130	30.630	1.5	1.5	2.0	8.200	10.03	0.000	0.580
TERRAZZO FINISHER		BLD		25.480	0.000	1.5	1.5	2.0	8.200	8.930	0.000	0.000
TERRAZZO MASON		BLD		26.980	28.230	1.5	1.5	2.0	8.200	8.930	0.000	0.000
TILE LAYER		BLD		29.600	31.850	1.5	1.5	2.0	7.450	12.65	0.000	0.520
TILE MASON		BLD		26.980	28.230	1.5	1.5	2.0	8.200	8.930	0.000	0.000
TRUCK DRIVER	E	ALL	1	31.230	0.000	1.5	1.5	2.0	10.30	4.840	0.000	0.250
TRUCK DRIVER	E	ALL	2	31.680	0.000	1.5	1.5	2.0	10.30	4.840	0.000	0.250

TRUCK DRIVER	E	ALL	3	31.890	0.000	1.5	1.5	2.0	10.30	4.840	0.000	0.250
TRUCK DRIVER	E	ALL	4	32.180	0.000	1.5	1.5	2.0	10.30	4.840	0.000	0.250
TRUCK DRIVER	E	ALL	5	33.020	0.000	1.5	1.5	2.0	10.30	4.840	0.000	0.250
TRUCK DRIVER	E	O&C	1	24.980	0.000	1.5	1.5	2.0	10.30	4.840	0.000	0.250
TRUCK DRIVER	E	O&C	2	25.340	0.000	1.5	1.5	2.0	10.30	4.840	0.000	0.250
TRUCK DRIVER	E	O&C	3	25.510	0.000	1.5	1.5	2.0	10.30	4.840	0.000	0.250
TRUCK DRIVER	E	O&C	4	25.740	0.000	1.5	1.5	2.0	10.30	4.840	0.000	0.250
TRUCK DRIVER	E	O&C	5	26.420	0.000	1.5	1.5	2.0	10.30	4.840	0.000	0.250
TRUCK DRIVER	W	ALL	1	31.340	0.000	1.5	1.5	2.0	10.30	5.010	0.000	0.250
TRUCK DRIVER	W	ALL	2	31.780	0.000	1.5	1.5	2.0	10.30	5.010	0.000	0.250
TRUCK DRIVER	W	ALL	3	32.020	0.000	1.5	1.5	2.0	10.30	5.010	0.000	0.250
TRUCK DRIVER	W	ALL	4	32.280	0.000	1.5	1.5	2.0	10.30	5.010	0.000	0.250
TRUCK DRIVER	W	ALL	5	33.130	0.000	1.5	1.5	2.0	10.30	5.010	0.000	0.250
TRUCK DRIVER	W	O&C	1	25.070	0.000	1.5	1.5	2.0	10.30	5.010	0.000	0.250
TRUCK DRIVER	W	O&C	2	25.420	0.000	1.5	1.5	2.0	10.30	5.010	0.000	0.250
TRUCK DRIVER	W	O&C	3	25.620	0.000	1.5	1.5	2.0	10.30	5.010	0.000	0.250
TRUCK DRIVER	W	O&C	4	25.820	0.000	1.5	1.5	2.0	10.30	5.010	0.000	0.250
TRUCK DRIVER	W	O&C	5	26.500	0.000	1.5	1.5	2.0	10.30	5.010	0.000	0.250
TUCKPOINTER		BLD		29.130	30.630	1.5	1.5	2.0	8.200	10.03	0.000	0.580

Legend :

RG (Region)

TYP (Trade Type - All,Highway,Building,Floating,Oil & Chip,Rivers)

C (Class)

Base (Base Wage Rate)

FRMAN (Foreman Rate)

M-F>8 (OT required for any hour greater than 8 worked each day, Mon through Fri.

OSA (Overtime (OT) is required for every hour worked on Saturday)

OSH (Overtime is required for every hour worked on Sunday and Holidays)

H/W (Health & Welfare Insurance)

Pensn (Pension)

Vac (Vacation)

Trng (Training)

Explanations

SHELBY COUNTY

TRUCK DRIVERS (EAST) - East of a line starting where such line from the northeast corner of Moultrie County in a southwesterly direction to Findlay intersects the Moultrie-Shelby Counties line, to Findlay, continuing in a southerly direction to a point approximately 2-1/2 miles south of Middlesworth, continuing to a point on the Shelby-Cumberland Counties line approximately one mile south of the Trowbridge Neoga Road.

The following list is considered as those days for which holiday rates of wages for work performed apply: New Years Day, Memorial Day, Fourth of July, Labor Day, Thanksgiving Day, Christmas Day and

Veterans Day in some classifications/counties. Generally, any of these holidays which fall on a Sunday is celebrated on the following Monday. This then makes work performed on that Monday payable at the appropriate overtime rate for holiday pay. Common practice in a given local may alter certain days of celebration. If in doubt, please check with IDOL.

Oil and chip resealing (O&C) means the application of road oils and liquid asphalt to coat an existing road surface, followed by application of aggregate chips or gravel to coated surface, and subsequent rolling of material to seal the surface.

EXPLANATION OF CLASSES

ASBESTOS - GENERAL - removal of asbestos material/mold and hazardous materials from any place in a building, including mechanical systems where those mechanical systems are to be removed. This includes the removal of asbestos materials/mold and hazardous materials from ductwork or pipes in a building when the building is to be demolished at the time or at some close future date.

ASBESTOS - MECHANICAL - removal of asbestos material from mechanical systems, such as pipes, ducts, and boilers, where the mechanical systems are to remain.

CERAMIC TILE FINISHER, MARBLE FINISHER, TERRAZZO FINISHER

Assisting, helping or supporting the tile, marble and terrazzo mechanic by performing their historic and traditional work assignments required to complete the proper installation of the work covered by said crafts. The term "Ceramic" is used for naming the classification only and is in no way a limitation of the product handled. Ceramic takes into consideration most hard tiles.

ELECTRONIC SYSTEMS TECHNICIAN

Installation, service and maintenance of low-voltage systems which utilizes the transmission and/or transference of voice, sound, vision, or digital for commercial, education, security and entertainment purposes for the following: TV monitoring and surveillance, background/foreground music, intercom and telephone interconnect, field programming, inventory control systems, microwave transmission, multi-media, multiplex, radio page, school, intercom and sound burglar alarms and low voltage master clock systems.

Excluded from this classification are energy management systems, life safety systems, supervisory controls and data acquisition systems not intrinsic with the above listed systems, fire alarm systems, nurse call systems and raceways exceeding fifteen feet in length.

TRUCK DRIVER - BUILDING, HEAVY AND HIGHWAY CONSTRUCTION

Class 1. Drivers on 2 axle trucks hauling less than 9 ton. Air compressor and welding machines and brooms, including those pulled by separate units, truck driver helpers, warehouse employees, mechanic helpers, greasers and tiremen, pickup trucks when hauling materials, tools, or workers to and from and on-the-job site, and fork lifts up to 6,000 lb. capacity.

Class 2. Two or three axle trucks hauling more than 9 ton but hauling less than 16 ton. A-frame winch trucks, hydrolift trucks, vector trucks or similar equipment when used for transportation purposes. Fork lifts over 6,000 lb. capacity, winch trucks, four axle combination units, and ticket writers.

Class 3. Two, three or four axle trucks hauling 16 ton or more.

Drivers on water pulls, articulated dump trucks, mechanics and working forepersons, and dispatchers. Five axle or more combination units.

Class 4. Low Boy and Oil Distributors.

Class 5. Drivers who require special protective clothing while employed on hazardous waste work.

TRUCK DRIVER - OIL AND CHIP RESEALING ONLY.

This shall encompass laborers, workers and mechanics who drive contractor or subcontractor owned, leased, or hired pickup, dump, service, or oil distributor trucks. The work includes transporting materials and equipment (including but not limited to, oils, aggregate supplies, parts, machinery and tools) to or from the job site; distributing oil or liquid asphalt and aggregate; stock piling material when in connection with the actual oil and chip contract. The Truck Driver (Oil & Chip Resealing) wage classification does not include supplier delivered materials.

OPERATING ENGINEERS - BUILDING

CLASS 1. Asphalt Screed Man; Aspco Concrete Spreaders; Asphalt Pavers; Asphalt Plant Engineer; Asphalt Rollers on Bituminous Concrete; Athey Loaders; Backfillers, Crane Type; Backhoes; Barber Green Loaders; Bulldozers; Cableways; Cherry Pickers; Clam Shells; C.M.I. & similar type autograde formless paver, autograde placer & finisher; Concrete Breakers; Concrete Pumps; Derricks; Derrick Boats; Draglines; Earth Auger or Boring Machines; Elevating Graders; Engineers on Dredges; Gravel Processing Machines; Head Equipment Greaser; High Lifts or Fork Lifts; Hoists with two or more drums or two or more load lines; Locomotives, All; Mechanics; Motor Graders or Auto Patrols; Operators or Leverman on Dredges; Operators, Power Boat; Operators, Pug Mill (Asphalt Plants); Orange Peels; Overhead Cranes; Paving Mixers; Piledrivers; Pipe Wrapping and Painting Machines; Pushdozers, or Push Cats; Robotic Controlled Equipment in this Classification; Rock Crushers; Ross Carrier or Similar Machines; Rotomill; Scoops, Skimmer, two cu. yd. capacity and under; Scoops, All or Tournapull; Sheep-Foot Roller (Self Propelled); Shovels; Skid Steer; Skimmer Scoops; Temporary Concrete Plant Operators; Test Hole Drilling Machines; Tower Machines; Tower Mixers; Track Type End Loaders; Track Type Fork Lifts or High Lifts; Track Jacks and Tampers; Tractors, Sideboom; Trenching or Ditching Machine; Tunnelluggers; Vermeer Type Saws; Water Blaster Cutting Head; Wheel Type End Loaders; Winch Cat.

CLASS 2. Air Compressors (six to eight)*; Asphalt Boosters and Heaters; Asphalt Distributors; Asphalt Plant Fireman; Oiler on Two Paving Mixers When Used in Tandem; Boom or Winch Trucks; Bull Floats or Flexplanes; Concrete Finishing Machine; Concrete Saws, Self-Propelled; Concrete Spreading Machines; Conveyors (six to eight)*; Generators (six to eight)*; Gravel or Stone Spreader, Power Operated; Hoist (with One Drum and One Load Line); Light Plants (six to eight)*; Mechanical Heaters (six to eight)*; Mud Jacks; Post Hole Digger, Mechanical; Pug Mills when used for other than Asphalt operation; Robotic Controlled Equipment in this Classification; Road or Street Sweeper, Self Propelled; Rollers (except bituminous concrete); Seaman Tiller; Straw Machine; Vibratory Compactor; Water Blaster, Power Unit; Welding Machines (six to eight)*; Well Drill Machines.

CLASS 3. Air Compressors(one to five)*; Air Compressors, Track or Self-Propelled; Automatic Hoist; Building Elevators; Bulk Cement Batching Plants; Conveyors (one to five)*; Concrete Mixers (Except Plant, Paver, or Tower); Firemen; Generators (one to five)*; Greasers;

Helper on Single Paving Mixer; Hoist, Automatic; Light Plants (one to five)*; Mechanic Helpers; Mechanical Heaters (one to five)*; Oilers; Power Form Graders; Power Sub-Graders; Robotic Controlled Equipment in this Classification; Scissors Hoist; Tractors without power attachments regardless of size or type; Truck Crane Oiler and Driver (1 man); Vibratory Hammer (power source); Water Pumps (one to five)*; Welding Machines (1/300 Amp. or over)*; Welding machines (one to five)*

CLASS 4. Lattice Boom Crawler Cranes; Lattice Boom Truck Cranes; Telescopic Truck-Mounted Cranes; Tower Cranes.

* Combinations of one to eight of any Air Compressors, Conveyors, Welding Machines, Water Pumps, Light Plants, or Generators shall be in batteries or within 400 feet and shall be paid as per the Classification Schedule contained in this Article.

OPERATING ENGINEERS - HIGHWAY

CLASS 1. Asphalt Screed Man; Asphco Concrete Spreaders; Asphalt Pavers; Asphalt Plant Engineer; Asphalt Rollers on Bituminous Concrete; Athey Loaders; Backhoes; Barber Green Loaders; Bulldozers; Cableways; Carry Deck Pickers; Cherry Pickers (Rough Terrain); C.M.I. & similar type-autograde formless paver, autograde placer & finisher; Concrete Breakers; Concrete Plant Operators; Concrete Pumps; Derricks; Derrick Boats; Dewatering Systems; Earth Auger or Boring Machines; Elevating Graders; Engineers on Dredges; Gravel Processing Machines; Grout Pump; Head Equipment Greaser; High Lifts or Fork Lifts; Hoists with two or more drums or two or more load lines; Hydro Jet or Hydro Laser; Locomotives, All; Mechanics; Motor Graders or Auto Patrols; Multi-Point Power Lifting Equipment; Operators or Leverman on Dredges; Operators, Power Boat; Operators, Pug Mill (Asphalt Plants); Overhead Cranes; Paving Mixers; Piledrivers; Pipe Wrapping and Painting Machines; Push-dozers, or Push Cats; Robotic Controlled Equipment in this Classification; Rock Crushers; Ross Carrier or Similar Machines; Roto-Mill; Scoops, Skimmer, two cu. yd. capacity and under; Sheep-Foot Roller (Self Pro-pelled); Shovels; Skid Steer; Skimmer Scoops; Test Hole Drilling Machines; Tower Machines; Tower Mixers; Track Type End Loaders; Track Type Fork Lifts or High Lifts; Track Jacks and Tampers; Tractors, Side-boom; Trenching or Ditching Machine; Tunnelluggers; Vermeer-Type Saws; Wheel Type End Loaders; Winch Cat; Scoops, All or Tournapull.

CLASS 2. Air Compressors (six to eight)*; Articulated Dumps; Asphalt Boosters and Heaters; Asphalt Distributors; Asphalt Plant Fireman; Boom or Winch Trucks; Building Elevators; Bull Floats or Flexplanes; Concrete Finishing Machine; Concrete Saws, Self-Propelled; Concrete Spreading Machines; Conveyors (six to eight)*; Generators (six to eight)*; Gravel or Stone Spreader, Power Operated; Hoist, Automatic; Hoist with One Drum and One Load Line; Light Plants (six to eight)*; Mechanical Heaters (six to eight)*; Mud Jacks; Off Road Water Wagons; Oiler on Two Paving Mixers When Used in Tandem; Post Hole Digger, Mechanical; Robotic Controlled Equipment in This Classification; Road or Street Sweeper, Self-Propelled; Rollers (except bituminous concrete); Scissor Hoist; Sea-man Tiller; Straw Machine; Vibratory Compactor; Water Pumps (six to eight)*; Well Drill Machines.

CLASS 3. Air Compressors (one to five)*; Air Compressors, Track or Self-Propelled; Bulk Cement Batching Plants; Conveyors (one to five)*; Concrete Mixers (Except Plant, Paver, or Tower); Firemen; Generators (one to five)*; Greasers; Helper on Single Paving Mixer; Light Plants (one to five)*; Mechanic Helpers; Mechanical Heaters (one to five)*; Oilers; Power Form Graders; Power Sub-Graders; Pug Mills when used for other than Asphalt operation; Robotic Controlled Equipment in This

Classification; Tractors without power attachments, regardless of size or type; Truck Crane Oiler and Driver (1 man); Vibratory Hammer (power source); Water Pumps (one to five)*; Welding Machines (one 300 Amp. or over)*; Welding Machines (one to five)*.

CLASS 4. Lattice Boom Crawler Crane; Lattice Boom Truck Crane; Telescopic Truck-Mounted Crane; Tower Crane.

*Combinations of one to eight of any Air Compressors, Conveyors, Welding Machines, Water Pumps, Light Plants or Generators shall be in batteries or within 400 feet and shall be paid as per the Classification Schedule contained in this Article.

Other Classifications of Work:

For definitions of classifications not otherwise set out, the Department generally has on file such definitions which are available. If a task to be performed is not subject to one of the classifications of pay set out, the Department will upon being contacted state which neighboring county has such a classification and provide such rate, such rate being deemed to exist by reference in this document. If no neighboring county rate applies to the task, the Department shall undertake a special determination, such special determination being then deemed to have existed under this determination. If a project requires these, or any classification not listed, please contact IDOL at 217-782-1710 for wage rates or clarifications.

LANDSCAPING

Landscaping work falls under the existing classifications for laborer, operating engineer and truck driver. The work performed by landscape plantsman and landscape laborer is covered by the existing classification of laborer. The work performed by landscape operators (regardless of equipment used or its size) is covered by the classifications of operating engineer. The work performed by landscape truck drivers (regardless of size of truck driven) is covered by the classifications of truck driver.

Stark County Prevailing Wage for May 2013

(See explanation of column headings at bottom of wages)

Trade Name	RG	TYP	C	Base	FRMAN	M-F>8	OSA	OSH	H/W	Pensn	Vac	Trng
ASBESTOS ABT-GEN	E	BLD		30.030	31.030	1.5	1.5	2.0	7.700	8.230	0.000	0.800
ASBESTOS ABT-GEN	E	HWY		31.590	32.140	1.5	1.5	2.0	7.700	8.230	0.000	0.800
ASBESTOS ABT-GEN	W	BLD		27.490	28.490	1.5	1.5	2.0	8.240	10.07	0.000	0.800
ASBESTOS ABT-GEN	W	HWY		26.060	26.560	1.5	1.5	2.0	8.240	9.550	0.000	0.800
ASBESTOS ABT-MEC		BLD		31.840	34.340	1.5	1.5	2.0	10.82	10.66	0.000	0.720
BOILERMAKER		BLD		35.010	38.010	2.0	2.0	2.0	7.070	13.83	0.000	0.300
BRICK MASON		BLD		36.720	37.720	1.5	1.5	2.0	8.720	7.950	0.000	0.580
CARPENTER		BLD		30.250	32.370	1.5	1.5	2.0	8.900	13.68	0.000	0.570
CARPENTER		HWY		30.250	32.000	1.5	1.5	2.0	8.830	13.34	0.000	0.500
CEMENT MASON		ALL		35.000	36.000	1.5	1.5	2.0	7.700	11.67	0.000	0.500
CERAMIC TILE FNSHER		BLD		32.410	0.000	1.5	1.5	2.0	7.700	4.840	0.000	0.530
COMMUNICATION TECH	N	BLD		31.200	32.700	1.5	1.5	2.0	12.32	10.77	0.000	0.320
ELECTRIC PWR EQMT OP		ALL		35.440	0.000	1.5	1.5	2.0	5.000	10.98	0.000	0.270
ELECTRIC PWR GRNDMAN		ALL		24.320	0.000	1.5	1.5	2.0	5.000	7.540	0.000	0.180
ELECTRIC PWR LINEMAN		ALL		39.370	41.910	1.5	1.5	2.0	5.000	12.20	0.000	0.300
ELECTRIC PWR TRK DRV		ALL		25.510	0.000	1.5	1.5	2.0	5.000	7.920	0.000	0.190
ELECTRICIAN	N	BLD		37.950	41.370	1.5	1.5	2.0	13.17	15.06	0.000	1.200
ELECTRICIAN	S	BLD		34.820	37.320	1.5	1.5	2.0	5.350	10.08	0.000	0.400

ELECTRONIC SYS TECH	S	BLD	27.430	29.180	1.5	1.5	2.0	5.350	9.320	0.000	0.400
ELEVATOR CONSTRUCTOR		BLD	40.520	45.585	2.0	2.0	2.0	11.88	12.71	3.240	0.600
GLAZIER		BLD	30.770	32.770	1.5	1.5	2.0	9.700	7.700	0.000	1.250
HT/FROST INSULATOR		BLD	42.450	44.950	1.5	1.5	2.0	10.82	11.86	0.000	0.720
IRON WORKER	NE	ALL	38.500	39.500	2.0	2.0	2.0	9.390	18.84	0.000	0.700
IRON WORKER	SW	BLD	30.330	32.230	1.5	1.5	2.0	9.390	11.56	0.000	0.440
IRON WORKER	SW	HWY	34.020	36.020	1.5	1.5	2.0	9.390	11.56	0.000	0.390
LABORER	E	BLD	29.030	30.030	1.5	1.5	2.0	7.700	8.230	0.000	0.800
LABORER	E	HWY	30.590	31.140	1.5	1.5	2.0	7.700	8.230	0.000	0.800
LABORER	W	BLD	26.490	27.490	1.5	1.5	2.0	8.240	10.07	0.000	0.800
LABORER	W	HWY	25.060	25.560	1.5	1.5	2.0	8.240	9.550	0.000	0.800
LABORER, SKILLED		BLD	26.490	27.490	1.5	1.5	2.0	8.240	10.07	0.000	0.800
LABORER, SKILLED		HWY	25.360	25.860	1.5	1.5	2.0	8.240	9.550	0.000	0.800
LATHER		BLD	30.250	32.370	1.5	1.5	2.0	8.900	13.68	0.000	0.570
MACHINERY MOVER	SW	HWY	34.020	36.020	1.5	1.5	2.0	9.390	11.56	0.000	0.390
MACHINIST		BLD	43.550	46.050	1.5	1.5	2.0	6.130	8.950	1.850	0.000
MARBLE FINISHERS		BLD	32.410	0.000	1.5	1.5	2.0	7.700	4.840	0.000	0.530
MARBLE MASON		BLD	35.090	35.340	1.5	1.5	2.0	7.700	7.150	0.000	0.560
MILLWRIGHT		BLD	34.400	37.840	1.5	1.5	2.0	8.770	13.85	0.000	0.500
MILLWRIGHT		HWY	34.120	37.530	1.5	1.5	2.0	8.770	13.85	0.000	0.500
OPERATING ENGINEER		BLD 1	36.000	39.000	1.5	1.5	2.0	9.750	13.60	0.000	3.000
OPERATING ENGINEER		BLD 2	33.490	39.000	1.5	1.5	2.0	9.750	13.60	0.000	3.000
OPERATING ENGINEER		BLD 3	29.340	39.000	1.5	1.5	2.0	9.750	13.60	0.000	3.000
OPERATING ENGINEER		HWY 1	36.000	39.500	1.5	1.5	2.0	9.750	13.60	0.000	3.000
OPERATING ENGINEER		HWY 2	33.490	39.500	1.5	1.5	2.0	9.750	13.60	0.000	3.000
OPERATING ENGINEER		HWY 3	29.340	39.500	1.5	1.5	2.0	9.750	13.60	0.000	3.000
PAINTER		ALL	32.900	34.900	1.5	1.5	1.5	9.650	8.200	0.000	1.250
PAINTER SIGNS		BLD	33.920	38.090	1.5	1.5	1.5	2.600	2.710	0.000	0.000
PILEDRIVER		BLD	30.500	33.550	1.5	1.5	2.0	8.900	13.68	0.000	0.570
PILEDRIVER		HWY	30.250	32.000	1.5	1.5	2.0	8.830	13.34	0.000	0.500
PIPEFITTER		BLD	37.400	41.510	1.5	1.5	2.0	7.000	11.63	0.000	1.060
PLASTERER		BLD	35.000	36.000	1.5	1.5	2.0	7.700	11.67	0.000	0.500
PLUMBER		BLD	33.570	36.590	1.5	1.5	2.0	7.000	13.31	0.000	0.900
ROOFER		BLD	28.580	30.010	1.5	1.5	2.0	8.450	7.220	0.000	0.250
SHEETMETAL WORKER		BLD	35.360	37.010	1.5	1.5	2.0	8.020	12.70	0.000	0.650
SIGN HANGER	SW	HWY	34.020	36.020	1.5	1.5	2.0	9.390	11.56	0.000	0.390
SPRINKLER FITTER		BLD	36.390	39.140	1.5	1.5	2.0	8.420	8.500	0.000	0.450
STEEL ERECTOR	SW	HWY	34.020	36.020	1.5	1.5	2.0	9.390	11.56	0.000	0.390
STONE MASON		BLD	36.720	37.720	1.5	1.5	2.0	8.720	7.950	0.000	0.580
TERRAZZO FINISHER		BLD	32.410	0.000	1.5	1.5	2.0	7.700	4.840	0.000	0.530
TILE LAYER		BLD	30.250	32.370	1.5	1.5	2.0	8.900	13.68	0.000	0.570
TILE MASON		BLD	35.090	35.340	1.5	1.5	2.0	7.700	7.150	0.000	0.560
TRUCK DRIVER		ALL 1	31.230	0.000	1.5	1.5	2.0	10.30	4.840	0.000	0.250
TRUCK DRIVER		ALL 2	31.680	0.000	1.5	1.5	2.0	10.30	4.840	0.000	0.250
TRUCK DRIVER		ALL 3	31.890	0.000	1.5	1.5	2.0	10.30	4.840	0.000	0.250
TRUCK DRIVER		ALL 4	32.180	0.000	1.5	1.5	2.0	10.30	4.840	0.000	0.250
TRUCK DRIVER		ALL 5	33.020	0.000	1.5	1.5	2.0	10.30	4.840	0.000	0.250
TRUCK DRIVER		O&C 1	24.980	0.000	1.5	1.5	2.0	10.30	4.840	0.000	0.250
TRUCK DRIVER		O&C 2	25.340	0.000	1.5	1.5	2.0	10.30	4.840	0.000	0.250
TRUCK DRIVER		O&C 3	25.510	0.000	1.5	1.5	2.0	10.30	4.840	0.000	0.250
TRUCK DRIVER		O&C 4	25.740	0.000	1.5	1.5	2.0	10.30	4.840	0.000	0.250
TRUCK DRIVER		O&C 5	26.420	0.000	1.5	1.5	2.0	10.30	4.840	0.000	0.250
TUCKPOINTER		BLD	36.720	37.720	1.5	1.5	2.0	8.720	7.950	0.000	0.580

Legend :

RG (Region)

TYP (Trade Type - All,Highway,Building,Floating,Oil & Chip,Rivers)

C (Class)

Base (Base Wage Rate)

FRMAN (Foreman Rate)

M-F>8 (OT required for any hour greater than 8 worked each day, Mon through Fri.)

OSA (Overtime (OT) is required for every hour worked on Saturday)

OSH (Overtime is required for every hour worked on Sunday and Holidays)

H/W (Health & Welfare Insurance)

Pensn (Pension)

Vac (Vacation)

Trng (Training)

Explanations

STARK COUNTY

ELECTRICIANS AND ELECTRONIC SYSTEMS TECHNICIAN (SOUTH) - West Jersey, Essex and Valley Townships.

IRONWORKERS (SOUTHWEST) - That part of the county South of a diagonal line through Toulon and Bradford.

LABORERS & ASBESTOS (EAST) - That part east of a north/south line parallel to the east border of Stark County running through the center of Wyoming on Route 91 and continuing north and south through Stark County.

The following list is considered as those days for which holiday rates of wages for work performed apply: New Years Day, Memorial Day, Fourth of July, Labor Day, Thanksgiving Day, Christmas Day and Veterans Day in some classifications/counties. Generally, any of these holidays which fall on a Sunday is celebrated on the following Monday. This then makes work performed on that Monday payable at the appropriate overtime rate for holiday pay. Common practice in a given local may alter certain days of celebration. If in doubt, please check with IDOL.

Oil and chip resealing (O&C) means the application of road oils and liquid asphalt to coat an existing road surface, followed by application of aggregate chips or gravel to coated surface, and subsequent rolling of material to seal the surface.

EXPLANATION OF CLASSES

ASBESTOS - GENERAL - removal of asbestos material/mold and hazardous materials from any place in a building, including mechanical systems where those mechanical systems are to be removed. This includes the removal of asbestos materials/mold and hazardous materials from ductwork or pipes in a building when the building is to be demolished at the time or at some close future date.

ASBESTOS - MECHANICAL - removal of asbestos material from mechanical systems, such as pipes, ducts, and boilers, where the mechanical systems are to remain.

CERAMIC TILE FINISHER, MARBLE FINISHER, TERRAZO FINISHER

Assisting, helping or supporting the tile, marble and terrazzo mechanic by performing their historic and traditional work assignments required to complete the proper installation of the work covered by said crafts. The term "Ceramic" is used for naming the classification only and is in no way a limitation of the product handled. Ceramic takes into consideration most hard tiles.

COMMUNICATIONS TECHNICIAN

Installation, operation, inspection, maintenance, repair and service of radio, television, recording, voice, sound and vision production and reproduction, telephone and telephone interconnect, facsimile, equipment and appliances used for domestic, commercial, educational and entertainment purposes, pulling of wire through conduit but not the installation of conduit.

ELECTRONIC SYSTEMS TECHNICIAN

Installation, service and maintenance of low-voltage systems which utilizes the transmission and/or transference of voice, sound, vision, or digital for commercial, education, security and entertainment purposes for the following: TV monitoring and surveillance, background/foreground music, intercom and telephone interconnect, field programming, inventory control systems, microwave transmission, multi-media, multiplex, radio page, school, intercom and sound burglar alarms and low voltage master clock systems.

Excluded from this classification are energy management systems, life safety systems, supervisory controls and data acquisition systems not intrinsic with the above listed systems, fire alarm systems, nurse call systems and raceways exceeding fifteen feet in length.

LABORER, SKILLED - BUILDING

The skilled laborer building (BLD) classification shall encompass the following types of work, irrespective of the site of the work: tending of carpenters in unloading, handling, stockpiling and distribution operations, also other building crafts, mixing, handling, and conveying of all materials used by masons, plasterers and other building construction crafts, whether done by hand or by any process. The drying of plastering when done by salamander heat, and the cleaning and clearing of all debris. All work pertaining to and in preparation of asbestos abatement and removal. The building of scaffolding and staging for masons and plasterers. The excavations for buildings and all other construction, digging, of trenches, piers, foundations and holes, digging, lagging, sheeting, cribbing, bracing and propping of foundations, holes, caissons, cofferdams, and dikes, the setting of all guidelines for machine or hand excavation and subgrading. The mixing, handling, conveying, pouring, vibrating, gunniting and otherwise applying of concrete, whether by hand or other method of concrete for any walls, foundations, floors, or for other construction concrete sealant men. The wrecking, stripping, dismantling, and handling of concrete forms and false work, and the building of centers for fireproofing purposes. Boring machine, gas, electric or air in preparation for shoving pipe, telephone cable, and so forth, under highways, roads, streets and alleys. All hand and power operating cross cut saws when used for clearing. All work in compressed air construction. All work on acetylene burners in salvaging. The blocking and tamping of concrete. The laying of sewer tile and conduit, and pre-cast materials. The assembling and dismantling of all jacks and sectional scaffolding, including elevator construction and running of slip form jacks. The work of drill running and blasting, including wagon drills. The wrecking, stripping, dismantling, cleaning, moving and oiling of forms. The cutting off of concrete piles. The loading, unloading, handling and

carrying to place of installation of all rods, (and materials for use in reinforcing) concrete and the hoisting of same and all signaling where hoist is used in this type of construction coming under the jurisdiction of the Laborers' Union. And, all other labor work not awarded to any other craft. Mortar mixers, kettlemen and carrier of hot stuff, tool crib men, watchmen (Laborer), firemen or salamander tenders, flagmen, deck hands, installation and maintenance of temporary gas-fired heating units, gravel box men, dumpmen and spotters, fencing Laborers, cleaning lumber, pit men, material checkers, dispatchers, unloading explosives, asphalt plant laborers, writer of scale tickets, fireproofing laborers, janitors, asbestos abatement and removal laborers, handling of materials treated with oil, creosote, chloride, asphalt, and/or foreign material harmful to skin or clothing, Laborers with de-watering systems, gunnite nozzle men, laborers tending masons with hot material or where foreign materials are used, Laborers handling masterplate or similar materials, laser beam operator, concrete burning machine operator, material selector men working with firebrick or combustible material, dynamite men, track laborers, cement handlers, chloride handlers, the unloading and laborers with steel workers and re-bars, concrete workers (wet), luteman, asphalt raker, curb asphalt machine operator, ready mix scalemen, permanent, portable or temporary plant drilling machine operator, plaster tenders, underpinning and shoring of buildings, fire watch, signaling of all power equipment, to include trucks excavating equipment, etc., tree topper or trimmer when in connection to construction, tunnel helpers in free air, batch dumpers, kettle and tar men, tank cleaners, plastic installers, scaffold workers, motorized buggies or motorized unit used for wet concrete or handling of building materials, sewer workers, rod and chain men, vibrator operators, mortar mixer operator, cement silica, clay, fly ash, lime and plasters, handlers (bulk or bag), cofferdam workers, on concrete paving, placing, cutting and tying of reinforcing, deck hand, dredge hand and shore laborers, bankmen on floating plant, asphalt workers with machine & layers, grade checker, power tools, caisson workers, lead man on sewer work, welders, cutters, burners and torch men, chain saw operators, paving breaker, jackhammer and drill operator, layout man and/or drainage tile layer, steel form setters -- street and highway, air tamping hammerman, signal man on crane, concrete saw operator, screen man on asphalt pavers, front end man on chip spreader, multiple concrete duct -- lead man.

LABORER, SKILLED - HIGHWAY

The skilled laborer heavy and highway (HWY) classification shall encompass the following types of work, irrespective of the site of the work: handling of materials treated with oil, creosote, asphalt and/or any foreign materials harmful to skin or clothing, track laborers, chloride handlers, the unloading and loading with steel workers and re-bars, concrete workers (wet), tunnel helpers in free air, batch dumpers, mason tenders, kettle and tar men, plastic installers, scaffold workers, motorized buggies or motorized unit used for wet concrete or handling of building materials, laborers with de-watering systems, sewer workers plus depth, rod and chainmen, vibrator operators, mortar mixer operators, cement silica, clay, fly ash, lime and plasters, handlers (bulk or bag), cofferdam workers plus depth, on concrete paving, placing, cutting and tying or reinforcing, deck hand, dredge hand shore laborers, bankmen on floating plant, asphalt workers with machine, and layers, grade checker, power tools, stripping of all concrete forms excluding paving forms, dumpmen and spotters, when necessary, caisson workers plus depth, gunnite nozzle men, welders, cutters, burners and torchmen, chain saw operators, paving breaker, jackhammer and drill operators, layout man and/or drainage tile layer, steel form setters - street and highway, air tamping hammerman, signal man on crane, concrete saw operator, screedman on asphalt pavers, front end man on chip spreader, multiple

concrete duct, luteman, asphalt raker, curb asphalt machine operator, ready mix scalemen (portable or temporary plant), laser beam operator, concrete burning machine operator, and coring machine operator.

TRUCK DRIVER - BUILDING, HEAVY AND HIGHWAY CONSTRUCTION

Class 1. Drivers on 2 axle trucks hauling less than 9 ton. Air compressor and welding machines and brooms, including those pulled by separate units, truck driver helpers, warehouse employees, mechanic helpers, greasers and tiremen, pickup trucks when hauling materials, tools, or workers to and from and on-the-job site, and fork lifts up to 6,000 lb. capacity.

Class 2. Two or three axle trucks hauling more than 9 ton but hauling less than 16 ton. A-frame winch trucks, hydrolift trucks, vactor trucks or similar equipment when used for transportation purposes. Fork lifts over 6,000 lb. capacity, winch trucks, four axle combination units, and ticket writers.

Class 3. Two, three or four axle trucks hauling 16 ton or more. Drivers on water pulls, articulated dump trucks, mechanics and working forepersons, and dispatchers. Five axle or more combination units.

Class 4. Low Boy and Oil Distributors.

Class 5. Drivers who require special protective clothing while employed on hazardous waste work.

TRUCK DRIVER - OIL AND CHIP RESEALING ONLY.

This shall encompass laborers, workers and mechanics who drive contractor or subcontractor owned, leased, or hired pickup, dump, service, or oil distributor trucks. The work includes transporting materials and equipment (including but not limited to, oils, aggregate supplies, parts, machinery and tools) to or from the job site; distributing oil or liquid asphalt and aggregate; stock piling material when in connection with the actual oil and chip contract. The Truck Driver (Oil & Chip Resealing) wage classification does not include supplier delivered materials.

OPERATING ENGINEERS - BUILDING

Class 1. Cranes; Overhead Cranes; Gradall; All Cherry Pickers; Mechanics; Central Concrete Mixing Plant Operator; Road Pavers (27E - Dual Drum - Tri Batches); Blacktop Plant Operators and Plant Engineers; 3 Drum Hoist; Derricks; Hydro Cranes; Shovels; Skimmer Scoops; Koehring Scooper; Drag Lines; Backhoe; Derrick Boats; Pile Drivers and Skid Rigs; Clamshells; Locomotive Cranes; Dredge (all types) Motor Patrol; Power Blades - Dumore - Elevating and similar types; Tower Cranes (Crawler-Mobile) and Stationary; Crane-type Backfiller; Drott Yumbo and similar types considered as Cranes; Caisson Rigs; Dozer; Tournadozer; Work Boats; Ross Carrier; Helicopter; Tournapulls - all and similar types; Scoops (all sizes); Pushcats; Endloaders (all types); Asphalt Surfacing Machine; Slip Form Paver; Rock Crusher; Heavy Equipment Greaser; CMI, CMI Belt Placer, Auto Grade & 3 Track and similar types; Side Booms; Multiple Unit Earth Movers; Creter Crane; Trench Machine; Pump-crete-Belt Crete-Squeeze Cretes-Screw-type Pumps and Gypsum; Bulker & Pump - Operator will clean; Formless Finishing Machine; Flaherty Spreader or similar types; Screed Man on Laydown Machine; Wheel Tractors (industrial or Farm-type w/Dozer-Hoe-Endloader or other attachments); F.W.D. & Similar Types; Vermeer Concrete Saw.

Class 2. Dinkeys; Power Launches; PH One-pass Soil Cement Machine (and similar types); Pugmill with Pump; Backfillers; Euclid Loader;

Forklifts; Jeeps w/Ditching Machine or other attachments; Tuneluger; Automatic Cement and Gravel Batching Plants; Mobile Drills (Soil Testing) and similar types; Gurries and Similar Types; (1) and (2) Drum Hoists (Buck Hoist and Similar Types); Chicago Boom; Boring Machine & Pipe Jacking Machine; Hydro Boom; Dewatering System; Straw Blower; Hydro Seeder; Assistant Heavy Equipment Greaser on Spread; Tractors (Track type) without Power Unit pulling Rollers; Rollers on Asphalt -- Brick Macadem; Concrete Breakers; Concrete Spreaders; Mule Pulling Rollers; Center Stripper; Cement Finishing Machines & CMI Texture & Reel Curing Machines; Cement Finishing Machine; Barber Green or similar loaders; Vibro Tamper (All similar types) Self-propelled; Winch or Boom Truck; Mechanical Bull Floats; Mixers over 3 Bag to 27E; Tractor pulling Power Blade or Elevating Grader; Porter Rex Rail; Clary Screed; Truck Type Hoptoe Oilers; Fireman; Spray Machine on Paving; Curb Machines; Truck Crane Oilers; Oil Distributor; Truck-Mounted Saws.

Class 3. Air Compressor; Power Subgrader; Straight Tractor; Trac Air without attachments; Herman Nelson Heater, Dravo, Warner, Silent Glo, and similar types; Roller: Five (5) Ton and under on Earth or Gravel; Form Grader; Crawler Crane & Skid Rig Oilers; Freight Elevators - permanently installed; Pump; Light Plant; Generator; Conveyor (1) or (2) - Operator will clean; Welding Machine; Mixer (3) Bag and Under (Standard Capacity with skip); Bulk Cement Plant; Oiler on Central Concrete Mixing Plant.

OPERATING ENGINEERS - HEAVY AND HIGHWAY CONSTRUCTION

CLASS 1. Cranes; Hydro Cranes; Shovels; Crane Type Backfiller; Tower, Mobile, Crawler, & Stationary Cranes; Derricks; Hoists (3 Drum); Draglines; Drott Yumbo & Similar Types considered as Cranes; 360 Degree Swing Excavator (Shears, Grapples, Movacs, etc.); Back Hoe; Derrick Boats; Pile Driver and Skid Rigs; Clam Shell; Locomotive - Cranes; Road Pavers - Single Drum - Dual Drum - Tri Batcher; Motor Patrols & Power Blades - Dumore - Elevating & Similar Types; Mechanics; Central Concrete Mixing Plant Operator; Asphalt Batch Plant Operators and Plant Engineers; Gradall; Caisson Rigs; Skimmer Scoop - Koering Scooper; Dredges (all types); Hoptoe; All Cherry Pickers; Work Boat; Ross Carrier; Helicopter; Dozer; Tournadozer; Tournapulls - all and similar types; Operation of Concrete and all Recycle Machines; Multiple Unit Earth Movers; Scoops (all sizes); Pushcats; Endloaders (all types); Asphalt Surfacing Machine; Slip Form Paver; Rock Crusher; Operation of Material Crusher, Screening Plants, and Tunnel Boring Machine; Heavy Equipment Greaser (top greaser on spread); CMI, Auto Grade, CMI Belt Placer & 3 Track and Similar Types; Side Booms; Asphalt Heater & Planer Combination (used to plane streets); Wheel Tractors (with Dozer, Hoe or Endloader Attachments); CAT Earthwork Compactors and Similar Types; Blaw Knox Spreader and Similar Types; Trench Machines; Pump Crete - Belt Crete - Squeeze Crete - Screw Type Pumps and Gypsum (operator will clean); Creter Crane; Operation of Concrete Pump Truck; Formless Finishing Machines; Flaherty Spreader or Similar Types; Screed Man on Laydown Machine; Vermeer Concrete Saw; Operation of Laser Screed; Span Saw; Dredge Leverman; Dredge Engineer; Lull or Similar Type; Hydro-Boom Truck; Operation of Guard Rail Machine; and Starting Engineer on Pipeline or Construction (11 or more pieces) including: Air Compressor (Trailer Mounted), All Forced Air Heaters (regardless of Size), Water Pumps (Greater than 4-1/2" or Total Discharge Over 4-1/2"), Light Plants, Generators (Trailer Mounted - Excluding Decontamination Trailer), Welding Machines (Any Size or Mode of Power), Conveyor, Mixer (any size), Stud Welder, Power Pac, etc, and Ground Heater (Trailer Mounted).

CLASS 2. Bulker & Pump; Power Launches; Boring Machine & Pipe Jacking Machine; Dinkeys; Operation of Carts, Powered Haul Unit for a Boring

Machine; P & H One Pass Soil Cement Machines and Similar Types; Wheel Tractors (Industry or Farm Type - Other); Back Fillers; Euclid Loader; Fork Lifts; Jeep w/Ditching Machine or Other Attachments; Tunneluger; Automatic Cement & Gravel Batching Plants; Mobile Drills - Soil Testing and Similar Types; Pugmill with Pump; All (1) and (2) Drum Hoists; Dewatering System; Straw Blower; Hydro-Seeder; Bump Grinders (self-propelled); Assistant Heavy Equipment Greaser; Apsco Spreader; Tractors (Track-Type) without Power Units Pulling Rollers; Rollers on Asphalt - Brick or Macadam; Concrete Breakers; Concrete Spreaders; Cement Strippers; Cement Finishing Machines & CMI Texture & Reel Curing Machines; Vibro-Tampers (All Similar Types Self-Propelled); Mechanical Bull Floats; Self-Propelled Concrete Saws; Truck Mounted Power Saws; Operation of Curb Cutters; Mixers - Over Three (3) Bags; Winch and Boom Trucks; Tractor Pulling Power Blade or Elevating Grader; Porter Rex Rail; Clary Screed; Mule Pulling Rollers; Pugmill without Pump; Barber Greene or Similar Loaders; Track Type Tractor w/Power Unit attached (minimum); Fireman; Spray Machine on Paving; Curb Machines; Paved Ditch Machine; Power Broom; Self-Propelled Sweepers; Self-Propelled Conveyors; Power Subgrader; Oil Distributor; Straight Tractor; Truck Crane Oiler; Truck Type Oilers; Directional Boring Machine; Horizontal Directional Drill; Articulating End Dump Vehicles; Starting Engineer on Pipeline or Construction (6 -10 pieces) including: Air Compressor (Trailer Mounted), All Forced Air Heaters (regardless of Size), Water Pumps (Greater than 4-1/2" or Total Discharge Over 4-1/2"), Light Plants, Generators (Trailer Mounted - Excluding Decontamination Trailer), Welding Machines (Any Size or Mode of Power), Conveyor, Mixer (any size), Stud Welder, Power Pac, etc., and Ground Heater (Trailer Mounted).

CLASS 3. Straight Framed Truck Mounted Vac Unit (separately powered); Trac Air Machine (without attachments); Rollers - Five Ton and Under on Earth and Gravel; Form Graders; Bulk Cement Plant; Oilers; and Starting Engineer on Pipeline or Construction (3 - 5 pieces) including: Air Compressor (Trailer Mounted), All Forced Air Heaters (regardless of Size), Water Pumps (Greater than 4-1/2" or Total Discharge Over 4-1/2"), Light Plants, Generators (Trailer Mounted - Excluding Decontamination Trailer), Welding Machines (Any Size or Mode of Power), Conveyor, Mixer (any size), Stud Welder, Power Pac, etc., and Ground Heater (Trailer Mounted).

Other Classifications of Work:

For definitions of classifications not otherwise set out, the Department generally has on file such definitions which are available. If a task to be performed is not subject to one of the classifications of pay set out, the Department will upon being contacted state which neighboring county has such a classification and provide such rate, such rate being deemed to exist by reference in this document. If no neighboring county rate applies to the task, the Department shall undertake a special determination, such special determination being then deemed to have existed under this determination. If a project requires these, or any classification not listed, please contact IDOL at 217-782-1710 for wage rates or clarifications.

LANDSCAPING

Landscaping work falls under the existing classifications for laborer, operating engineer and truck driver. The work performed by landscape plantsman and landscape laborer is covered by the existing classification of laborer. The work performed by landscape operators (regardless of equipment used or its size) is covered by the classifications of operating engineer. The work performed by landscape truck drivers (regardless of size of truck driven) is covered by the classifications of truck driver.

Stephenson County Prevailing Wage for May 2013

(See explanation of column headings at bottom of wages)

Trade Name	RG	TYP	C	Base	FRMAN	M-F>8	OSA	OSH	H/W	Pensn	Vac	Trng
=====	==	===	=	=====	=====	=====	===	===	=====	=====	=====	=====
ASBESTOS ABT-GEN		BLD		29.550	30.550	1.5	1.5	2.0	8.240	12.42	0.000	0.800
ASBESTOS ABT-MEC		BLD		18.950	0.000	1.5	1.5	2.0	2.700	3.350	0.000	0.000
BOILERMAKER		BLD		35.010	38.010	2.0	2.0	2.0	7.070	13.83	0.000	0.300
BRICK MASON		BLD		35.880	38.630	1.5	1.5	2.0	7.950	11.73	0.000	0.600
CARPENTER		BLD		32.040	35.560	1.5	1.5	2.0	8.630	13.87	0.000	0.600
CARPENTER		HWY		33.790	35.540	1.5	1.5	2.0	9.750	12.99	0.000	0.490
CEMENT MASON		ALL		32.520	35.270	1.5	1.5	2.0	7.700	13.98	0.000	0.500
CERAMIC TILE FNSHER		BLD		32.410	0.000	1.5	1.5	2.0	7.700	4.840	0.000	0.530
COMMUNICATION TECH		BLD		36.000	39.600	1.5	1.5	2.0	10.14	11.20	0.000	0.720
ELECTRIC PWR EQMT OP		ALL		36.610	49.750	1.5	1.5	2.0	5.000	11.35	0.000	0.270
ELECTRIC PWR GRNDMAN		ALL		28.310	49.750	1.5	1.5	2.0	5.000	8.780	0.000	0.210
ELECTRIC PWR LINEMAN		ALL		43.830	49.750	1.5	1.5	2.0	5.000	13.58	0.000	0.330
ELECTRIC PWR TRK DRV		ALL		29.310	49.750	1.5	1.5	2.0	5.000	9.090	0.000	0.220
ELECTRICIAN		BLD		40.000	44.000	1.5	1.5	2.0	10.14	16.93	0.000	0.800
ELEVATOR CONSTRUCTOR		BLD		45.350	51.020	2.0	2.0	2.0	11.88	12.71	3.630	0.600
GLAZIER		BLD		34.730	35.730	1.5	1.5	2.0	9.700	8.200	0.000	1.250
HT/FROST INSULATOR		BLD		33.930	36.470	1.5	1.5	2.0	7.450	14.77	0.000	0.000
IRON WORKER		ALL		35.090	36.840	2.0	2.0	2.0	8.250	20.59	0.000	0.700
LABORER		BLD		29.550	30.550	1.5	1.5	2.0	8.240	12.42	0.000	0.800
LABORER		HWY		32.100	32.850	1.5	1.5	2.0	8.240	12.42	0.000	0.800
LABORER, SKILLED		HWY		34.400	35.150	1.5	1.5	2.0	8.240	12.42	0.000	0.800
LATHER		BLD		32.040	35.560	1.5	1.5	2.0	8.630	13.87	0.000	0.600
MACHINIST		BLD		43.550	46.050	1.5	1.5	2.0	6.130	8.950	1.850	0.000
MARBLE FINISHERS		BLD		32.410	0.000	1.5	1.5	2.0	7.700	4.840	0.000	0.530
MARBLE MASON		BLD		35.090	35.340	1.5	1.5	2.0	7.700	7.150	0.000	0.560
MILLWRIGHT		BLD		35.000	38.500	1.5	1.5	2.0	7.700	13.87	0.000	0.500
OPERATING ENGINEER		BLD	1	40.800	44.850	2.0	2.0	2.0	15.85	9.800	2.350	1.300
OPERATING ENGINEER		BLD	2	40.100	44.850	2.0	2.0	2.0	15.85	9.800	2.350	1.300
OPERATING ENGINEER		BLD	3	37.650	44.850	2.0	2.0	2.0	15.85	9.800	2.350	1.300
OPERATING ENGINEER		BLD	4	35.650	44.850	2.0	2.0	2.0	15.85	9.800	2.350	1.300
OPERATING ENGINEER		BLD	5	44.600	44.850	2.0	2.0	2.0	15.85	9.800	2.350	1.300
OPERATING ENGINEER		BLD	6	43.350	44.850	2.0	2.0	2.0	15.85	9.800	2.350	1.300
OPERATING ENGINEER		BLD	7	40.350	44.850	2.0	2.0	2.0	15.85	9.800	2.350	1.300
OPERATING ENGINEER		HWY	1	40.650	44.700	1.5	1.5	2.0	15.85	9.800	2.350	1.300
OPERATING ENGINEER		HWY	2	40.100	44.700	1.5	1.5	2.0	15.85	9.800	2.350	1.300
OPERATING ENGINEER		HWY	3	38.800	44.700	1.5	1.5	2.0	15.85	9.800	2.350	1.300
OPERATING ENGINEER		HWY	4	37.350	44.700	1.5	1.5	2.0	15.85	9.800	2.350	1.300
OPERATING ENGINEER		HWY	5	35.900	44.700	1.5	1.5	2.0	15.85	9.800	2.350	1.300
OPERATING ENGINEER		HWY	6	43.700	44.700	1.5	1.5	2.0	15.85	9.800	2.350	1.300
OPERATING ENGINEER		HWY	7	41.700	44.700	1.5	1.5	2.0	15.85	9.800	2.350	1.300
PAINTER		ALL		35.700	37.700	1.5	1.5	1.5	9.650	8.460	0.000	1.250
PILEDRIVER		BLD		33.040	36.670	1.5	1.5	2.0	8.630	13.87	0.000	0.600
PILEDRIVER		HWY		33.790	35.540	1.5	1.5	2.0	9.750	12.99	0.000	0.490
PIPEFITTER		BLD		40.600	43.440	1.5	1.5	2.0	7.980	10.79	0.000	1.000
PLASTERER		BLD		33.360	36.700	2.0	2.0	2.0	8.150	11.05	0.000	0.500
PLUMBER		BLD		40.600	43.440	1.5	1.5	2.0	7.980	10.79	0.000	1.000
ROOFER		BLD		38.350	41.350	1.5	1.5	2.0	8.280	8.770	0.000	0.430
SHEETMETAL WORKER		BLD		35.780	37.710	1.5	1.5	2.0	5.450	15.44	0.520	0.290
SPRINKLER FITTER		BLD		36.390	39.140	1.5	1.5	2.0	8.420	8.500	0.000	0.450
STONE MASON		BLD		35.880	38.630	1.5	1.5	2.0	7.950	11.73	0.000	0.600
TERRAZZO FINISHER		BLD		32.410	0.000	1.5	1.5	2.0	7.700	4.840	0.000	0.530
TERRAZZO MASON		BLD		35.090	35.340	1.5	1.5	2.0	7.700	7.150	0.000	0.560
TILE LAYER		BLD		32.040	35.560	1.5	1.5	2.0	8.630	13.87	0.000	0.600
TILE MASON		BLD		35.090	35.340	1.5	1.5	2.0	7.700	7.150	0.000	0.560
TRUCK DRIVER		ALL	1	32.960	33.420	1.5	1.5	2.0	6.900	8.220	0.000	0.000
TRUCK DRIVER		ALL	2	33.110	33.420	1.5	1.5	2.0	6.900	8.220	0.000	0.000
TRUCK DRIVER		ALL	3	33.310	33.420	1.5	1.5	2.0	6.900	8.220	0.000	0.000

TRUCK DRIVER	ALL	4	33.420	33.420	1.5	1.5	2.0	6.900	8.220	0.000	0.000
TUCKPOINTER	BLD		35.880	38.630	1.5	1.5	2.0	7.950	11.73	0.000	0.600

Legend:

RG (Region)

TYP (Trade Type - All,Highway,Building,Floating,Oil & Chip,Rivers)

C (Class)

Base (Base Wage Rate)

FRMAN (Foreman Rate)

M-F>8 (OT required for any hour greater than 8 worked each day, Mon through Fri.)

OSA (Overtime (OT) is required for every hour worked on Saturday)

OSH (Overtime is required for every hour worked on Sunday and Holidays)

H/W (Health & Welfare Insurance)

Pensn (Pension)

Vac (Vacation)

Trng (Training)

Explanations

STEPHENSON COUNTY

The following list is considered as those days for which holiday rates of wages for work performed apply: New Years Day, Memorial Day, Fourth of July, Labor Day, Thanksgiving Day, Christmas Day and Veterans Day in some classifications/counties. Generally, any of these holidays which fall on a Sunday is celebrated on the following Monday. This then makes work performed on that Monday payable at the appropriate overtime rate for holiday pay. Common practice in a given local may alter certain days of celebration. If in doubt, please check with IDOL.

EXPLANATION OF CLASSES

ASBESTOS - GENERAL - removal of asbestos material/mold and hazardous materials from any place in a building, including mechanical systems where those mechanical systems are to be removed. This includes the removal of asbestos materials/mold and hazardous materials from ductwork or pipes in a building when the building is to be demolished at the time or at some close future date.

ASBESTOS - MECHANICAL - removal of asbestos material from mechanical systems, such as pipes, ducts, and boilers, where the mechanical systems are to remain.

CERAMIC TILE FINISHER, MARBLE FINISHER, TERRAZZO FINISHER

Assisting, helping or supporting the tile, marble and terrazzo mechanic by performing their historic and traditional work assignments required to complete the proper installation of the work covered by

said crafts. The term "Ceramic" is used for naming the classification only and is in no way a limitation of the product handled. Ceramic takes into consideration most hard tiles.

COMMUNICATIONS TECHNICIAN

Installing, manufacturing, assembling and maintaining sound and intercom, protection alarm (security), fire alarm, master antenna television, closed circuit television, low voltage control for computers and/or door monitoring, school communications systems, telephones and servicing of nurse and emergency calls, and the installation and maintenance of transmit and receive antennas, transmitters, receivers, and associated apparatus which operates in conjunction with above systems. All work associated with these system installations will be included EXCEPT the installation of protective metallic conduit in new construction projects (excluding less than ten-foot, runs strictly for protection of cable) and 120 volt AC (or higher) power wiring and associated hardware.

LABORER, SKILLED - HIGHWAY

Individuals engaged in the following types of work, irrespective of the site of the work: asbestos abatement worker, handling of any materials with any foreign matter harmful to skin or clothing, track laborer, cement handlers, chloride handlers, the unloading and loading with steel workers and re-bars, concrete workers wet, tunnel helpers in free air, batch dumpers, mason tenders, kettle and tar men, tank cleaners, plastic installers, scaffold workers, motorized buggies or motorized unit used for wet concrete or handling of building materials, laborers with de-watering systems, sewer workers plus depth, rod and chainmen with technical engineers, rod and chainmen with land surveyors, rod and chainmen with surveyors, vibrator operators, cement silica, clay, fly ash, lime and plasters, handlers (bulk or bag), cofferdam workers plus depth, on concrete paving, placing, cutting and tying of reinforcing, deck hand, dredge hand, and shore laborers, bankmen on floating plant, grade checker, power tools, front end man on chip spreaders, cassion workers plus depth, gunnite nozzle men, lead man on sewer work, welders, cutters, burners and torchmen, chainsaw operators, jackhammer and drill operators, layout man and/or drainage tile layer, steel form setter - street and highway, air tamping hammermen, signal man on crane, concrete saw operator, screedman on asphalt pavers, laborers tending masons with hot material or where foreign materials are used, mortar mixer operators, multiple concrete duct - leadsman, lumen, asphalt raker, curb asphalt machine operator, ready mix scalemen (permanent, portable or temporary plant), laborers handling masterplate or similar materials, laser beam operator, concrete burning machine operator, coring machine operator, plaster tender, underpinning and shoring of buildings, pump men, manhole and catch basin, dirt and stone tamper, hose men on concrete pumps, hazardous waste worker, lead base paint abatement worker, lining of pipe, refusing machine, assisting on direct boring machine, the work of laying watermain, fire hydrants, all mechanical joints to watermain work, sewer worker, and tapping water service and forced lift station mechanical worker.

OPERATING ENGINEERS - BUILDING

Class 1. Asphalt Plant; Asphalt Spreader; Autograde; Backhoes with Caisson Attachment; Batch Plant; Benoto (requires Two Engineers); Boiler and Throttle Valve; Caisson Rigs; Central Redi-Mix Plant; Combination Back Hoe Front End-loader Machine; Compressor and Throttle Valve; Concrete Breaker (Truck Mounted); Concrete Conveyor; Concrete Paver (over 27E cu. ft.): Concrete Paver (27 cu. ft. and under); Concrete Placer; Concrete Pump (Truck Mounted); Concrete Conveyor (Truck Mounted); Concrete Tower; Cranes, All; GCI and similar types

(required two operators only); Cranes, Hammerhead; Creter Crane; Crusher, Stone, etc.; Derricks, All; Derricks, Traveling; Formless Curb and Gutter Machine; Grader, Elevating; Grouting Machines; Highlift Shovels or Front Endloader 2-1/4 yd. and over; Hoists, Elevators, outside type rack and pinion and similar machines; Hoists, one, two and three Drum; Hoists, Two Tugger One Floor; Hydraulic Backhoes; Hydraulic Boom Trucks; Hydro Vac (and similar equipment - excluding hose work and any sewer work); Locomotives, All; Lubrication Technician; Manipulators; Motor Patrol; Pile Drivers and Skid Rig; Post Hole Digger; Pre-Stress Machine; Pump Cretes Dual Ram; Pump Cretes: Squeeze Cretes - Screw Type Pumps, Gypsum Bulker and Pump; Raised and Blind Hole Drill; Rock Drill (self-propelled); Rock Drill - Truck Mounted; Roto Mill Grinder; Scoops - Tractor Drawn; Slipform Paver; Scrapers Prime Movers; Straddle Buggies; Tie Back Machine; Tractor with Boom and Side Boom; Trenching Machines.

Class 2. Bobcat (over 3/4 cu. yd.); Boilers; Brick Forklift; Broom, All Power Propelled; Bulldozers; Concrete Mixer (Two Bag and Over); Conveyor, Portable; Forklift Trucks; Highlift Shovels or Front Endloaders under 2-1/4 yd.; Hoists, Automatic; Hoists, Sewer Dragging Machine; Hoists, Tugger Single Drum; Laser Screed; Rollers, All; Steam Generators; Tractors, All; Tractor Drawn Vibratory Roller; Winch Trucks with "A" Frame.

Class 3. Air Compressor; Asphalt Spreader; Combination - Small Equipment Operator; Generators; Heaters, Mechanical; Hoists, Inside Elevators - (Rheostat Manual Controlled); Hydraulic Power Units (Pile Driving, Extracting, or Drilling - with a seat); Lowboys; Pumps, Over 3" (1 to 3 not to exceed total of 300 ft.); Pumps, Well Points; Welding Machines (2 through 5); Winches, 4 Small Electric Drill Winches; Bobcat (up to and including 3/4 cu. yd.).

Class 4. Elevator push button with automatic doors; Hoists, Inside; Oilers; Brick Forklift.

Class 5. Assistant Craft Foreman

Class 6. Mechanics; Welders.

Class 7. Gradall

OPERATING ENGINEERS - HIGHWAY CONSTRUCTION

Class 1. Asphalt Plant; Asphalt Heater and Planer Combination; Asphalt Heater Scarfire; Asphalt Silo Tender; Asphalt Spreader; Autograder; ABG Paver; Backhoes with Caisson Attachment; Ballast Regulator; Belt Loader; Caisson Rigs; Car Dumper; Central Redi-Mix Plant; Backhoe w/shear attachments; Combination Backhoe Front Endloader Machine, (1 cu. yd. Backhoe Bucket or over or with attachments); Concrete Breaker (Truck Mounted); Concrete Conveyor; Concrete Paver over 27E cu. ft.; Concrete Placer; Concrete Tube Float; Cranes, all attachments; Cranes, Tower of all types; Creter Crane; Crusher, Stone, etc.; Derricks, All; Derrick Boats; Derricks, Traveling; Directional Boring Machine over 12"; Dredges; Formless Curb and Gutter Machine; Grader, Elevating; Grader, Motor Grader, Motor Patrol, Auto Patrol, Form Grader, Pull Grader, Subgrader; Guard Rail Post Driver Mounted; Hoists, One, Two and Three Drum; Hydraulic Backhoes; Hydro Vac, Self Propelled, Truck Mounted (excluding hose work and any sewer work); Lubrication Technician; Manipulators; Pile Drivers and Skid Rig; Pre-Stress Machine; Pump Cretes Dual Ram; Rock Drill - Crawler or Skid Rig; Rock Drill - Truck Mounted; Rock/Track Tamper; Roto Mill Grinder; Slip-Form Paver; Snow Melters; Soil Test Drill Rig (Truck Mounted); Straddle Buggies; GCI Crane; Hydraulic Telescoping Form (Tunnel); Tie Back Machine; Tractor Drawn Belt Loader; Tractor Drawn

Belt Loader with attached pusher; Tractor with Boom; Tractaire with Attachments; Traffic Barrier Conveyor Machine; Raised or Blind Hole Drills; Trenching Machine (over 12"); Truck Mounted Concrete Pump with Boom; Truck Mounted Concrete Conveyor; Work Boat (no license required - 90 h.p. or above); Underground Boring and/or Mining Machines; Wheel Excavator; Widener (APSCO).

Class 2. Batch Plant; Bituminous Mixer; Boiler and Throttle Valve; Bulldozers; Car Loader Trailing Conveyors; Combination Backhoe Front Endloader Machine (less than 1 cu. yd. Backhoe Bucket or over or with attachments); Compressor and Throttle Valve; Compressor, Common Receiver (3); Concrete Breaker or Hydro Hammer; Concrete Grinding Machine; Concrete Mixer or Paver 7S Series to and including 27 cu. ft.; Concrete Spreader; Concrete Curing Machine, Burlap Machine, Belting Machine and Sealing Machine; Concrete Wheel Saw (large self-propelled - excluding walk-behinds and hand-held); Conveyor Muck Cars (Haglund or Similar Type); Drills, all; Finishing Machine - Concrete; Highlift Shovels or Front Endloader; Hoist - Sewer Dragging Machine; Hydraulic Boom Trucks (All Attachments); Hydro Blaster; All Locomotives, Dinky; Off-Road Hauling Units; Non-Self Loading Dump; Ejection Dump; Pump Cretes: Squeeze Cretes - Screw Type Pumps, Gypsum Bulker and Pump; Roller, Asphalt; Rotary Snow Plows; Rototiller, Seaman, etc., self-propelled; Scoops - Tractor Drawn; Self-Propelled Compactor; Spreader - Chip - Stone, etc.; Scraper; Scraper - Prime Mover in Tandem (Regardless of Size); Tank Car Heater; Tractors, Push, Pulling Sheeps Foot, Disc, Compactor, etc.; Tug Boats.

Class 3. Boilers; Brooms, All Power Propelled; Cement Supply Tender; Compressor, Common Receiver (2); Concrete Mixer (Two Bag and Over); Conveyor, Portable; Farm-Type Tractors Used for Mowing, Seeding, etc.; Fireman on Boilers; Forklift Trucks; Grouting Machine; Hoists, Automatic; Hoists, All Elevators; Hoists, Tugger Single Drum; Jeep Diggers; Low Boys; Pipe Jacking Machines; Post-Hole Digger; Power Saw, Concrete Power Driven; Pug Mills; Rollers, other than asphalt; Seed and Straw Blower; Steam Generators; Stump Machine; Winch Trucks with "A" Frame; Work Boats; Tamper - Form - Motor Driven.

Class 4. Air Compressor - Small and Large; Asphalt Spreader, Backend Man; Bobcat (Skid Steer) all; Brick Forklift; Combination - Small Equipment Operator; Directional Boring Machine up to 12"; Generators; Heaters, Mechanical; Hydraulic Power Unit (Pile Driving, Extracting, or Drilling); Hydro-Blaster; Light Plants, All (1 through 5); Pumps, over 3" (1 to 3 not to exceed a total of 300 ft.); Pumps, Well Points; Tractaire; Trencher 12" and under; Welding Machines (2 through 5); Winches, 4 Small Electric Drill Winches.

Class 5. Oilers and Directional Boring Machine Locator.

Class 6. Field Mechanics and Field Welders

Class 7. Gradall and machines of like nature.

TRUCK DRIVER - BUILDING, HEAVY AND HIGHWAY CONSTRUCTION

Class 1. Two or three Axle Trucks. A-frame Truck when used for transportation purposes; Air Compressors and Welding Machines, including those pulled by cars, pick-up trucks and tractors; Ambulances; Batch Gate Lockers; Batch Hopperman; Car and Truck Washers; Carry-alls; Fork Lifts and Hoisters; Helpers; Mechanics Helpers and Greasers; Oil Distributors 2-man operation; Pavement Breakers; Pole Trailer, up to 40 feet; Power Mower Tractors; Self-propelled Chip Spreader; Skipman; Slurry Trucks, 2-man operation; Slurry Truck Conveyor Operation, 2 or 3 man; Teamsters; Unskilled dumpman; and Truck Drivers hauling warning lights, barricades, and portable toilets on the job site.

Class 2. Four axle trucks; Dump Crets and Adgetors under 7 yards; Dumpsters, Track Trucks, Euclids, Hug Bottom Dump Turnapulls or Turnatrailers when pulling other than self-loading equipment or similar equipment under 16 cubic yards; Mixer Trucks under 7 yards; Ready-mix Plant Hopper Operator, and Winch Trucks, 2 Axles.

Class 3. Five axle trucks; Dump Crets and Adgetors 7 yards and over; Dumpsters, Track Trucks, Euclids, Hug Bottom Dump Turnatrailers or turnapulls when pulling other than self-loading equipment or similar equipment over 16 cubic yards; Explosives and/or Fission Material Trucks; Mixer Trucks 7 yards or over; Mobile Cranes while in transit; Oil Distributors, 1-man operation; Pole Trailer, over 40 feet; Pole and Expandable Trailers hauling material over 50 feet long; Slurry trucks, 1-man operation; Winch trucks, 3 axles or more; Mechanic--Truck Welder and Truck Painter.

Class 4. Six axle trucks; Dual-purpose vehicles, such as mounted crane trucks with hoist and accessories; Foreman; Master Mechanic; Self-loading equipment like P.B. and trucks with scoops on the front.

Other Classifications of Work:

For definitions of classifications not otherwise set out, the Department generally has on file such definitions which are available. If a task to be performed is not subject to one of the classifications of pay set out, the Department will upon being contacted state which neighboring county has such a classification and provide such rate, such rate being deemed to exist by reference in this document. If no neighboring county rate applies to the task, the Department shall undertake a special determination, such special determination being then deemed to have existed under this determination. If a project requires these, or any classification not listed, please contact IDOL at 217-782-1710 for wage rates or clarifications.

LANDSCAPING

Landscaping work falls under the existing classifications for laborer, operating engineer and truck driver. The work performed by landscape plantsman and landscape laborer is covered by the existing classification of laborer. The work performed by landscape operators (regardless of equipment used or its size) is covered by the classifications of operating engineer. The work performed by landscape truck drivers (regardless of size of truck driven) is covered by the classifications of truck driver.

Tazewell County Prevailing Wage for May 2013

(See explanation of column headings at bottom of wages)

Trade Name	RG	TYP	C	Base	FRMAN	M-F>8	OSA	OSH	H/W	Pensn	Vac	Trng
=====	==	===	=	=====	=====	=====	===	===	=====	=====	=====	=====
ASBESTOS ABT-GEN	NW	BLD		26.470	27.970	1.5	1.5	2.0	7.700	13.75	0.000	0.800
ASBESTOS ABT-GEN	NW	HWY		28.750	30.000	1.5	1.5	2.0	7.700	13.95	0.000	0.850
ASBESTOS ABT-GEN	SE	BLD		25.820	26.570	1.5	1.5	2.0	7.550	11.50	0.000	0.800
ASBESTOS ABT-MEC		BLD		31.840	34.340	1.5	1.5	2.0	10.82	10.66	0.000	0.720
BOILERMAKER		BLD		35.010	38.010	2.0	2.0	2.0	7.070	13.83	0.000	0.300
BRICK MASON		BLD		32.060	33.560	1.5	1.5	2.0	7.700	9.130	0.000	0.560
CARPENTER		BLD		29.330	31.580	1.5	1.5	2.0	7.450	13.66	0.000	0.520
CARPENTER		HWY		30.820	33.070	1.5	1.5	2.0	7.450	13.94	0.000	0.520
CEMENT MASON		BLD		27.090	28.840	1.5	1.5	2.0	8.140	13.55	0.000	0.500
CEMENT MASON		HWY		28.280	29.780	1.5	1.5	2.0	8.140	13.93	0.000	0.500

CERAMIC TILE FNSHER	BLD		29.750	0.000	1.5	1.5	2.0	7.700	9.130	0.000	0.550
ELECTRIC PWR EQMT OP	ALL		35.440	0.000	1.5	1.5	2.0	5.000	10.98	0.000	0.270
ELECTRIC PWR GRNDMAN	ALL		24.320	0.000	1.5	1.5	2.0	5.000	7.540	0.000	0.180
ELECTRIC PWR LINEMAN	ALL		39.370	41.910	1.5	1.5	2.0	5.000	12.20	0.000	0.300
ELECTRIC PWR TRK DRV	ALL		25.510	0.000	1.5	1.5	2.0	5.000	7.920	0.000	0.190
ELECTRICIAN	BLD		34.820	37.320	1.5	1.5	2.0	5.350	10.08	0.000	0.400
ELECTRONIC SYS TECH	BLD		27.430	29.180	1.5	1.5	2.0	5.350	9.320	0.000	0.400
ELEVATOR CONSTRUCTOR	BLD		40.520	45.585	2.0	2.0	2.0	11.88	12.71	3.240	0.600
GLAZIER	BLD		30.770	32.770	1.5	1.5	2.0	9.700	7.700	0.000	1.250
HT/FROST INSULATOR	BLD		42.450	44.950	1.5	1.5	2.0	10.82	11.86	0.000	0.720
IRON WORKER	BLD		30.330	32.230	1.5	1.5	2.0	9.390	11.56	0.000	0.440
IRON WORKER	HWY		34.020	36.020	1.5	1.5	2.0	9.390	11.56	0.000	0.390
LABORER	NW BLD		25.470	26.970	1.5	1.5	2.0	7.700	13.75	0.000	0.800
LABORER	NW HWY		28.000	29.250	1.5	1.5	2.0	7.700	13.95	0.000	0.800
LABORER	SE BLD		25.820	26.570	1.5	1.5	2.0	7.550	11.50	0.000	0.800
LABORER	SE HWY		29.010	30.010	1.5	1.5	2.0	7.550	13.04	0.000	0.800
LATHER	BLD		29.330	31.580	1.5	1.5	2.0	7.450	13.66	0.000	0.520
MACHINERY MOVER	HWY		34.020	36.020	1.5	1.5	2.0	9.390	11.56	0.000	0.390
MACHINIST	BLD		43.550	46.050	1.5	1.5	2.0	6.130	8.950	1.850	0.000
MARBLE FINISHERS	BLD		29.750	0.000	1.5	1.5	2.0	7.700	9.130	0.000	0.550
MARBLE MASON	BLD		31.510	32.760	1.5	1.5	2.0	7.700	9.130	0.000	0.550
MILLWRIGHT	BLD		30.240	32.490	1.5	1.5	2.0	7.450	13.09	0.000	0.520
MILLWRIGHT	HWY		31.820	34.070	1.5	1.5	2.0	7.450	13.44	0.000	0.520
OPERATING ENGINEER	BLD 1		36.000	39.000	1.5	1.5	2.0	9.750	13.60	0.000	3.000
OPERATING ENGINEER	BLD 2		33.490	39.000	1.5	1.5	2.0	9.750	13.60	0.000	3.000
OPERATING ENGINEER	BLD 3		29.340	39.000	1.5	1.5	2.0	9.750	13.60	0.000	3.000
OPERATING ENGINEER	HWY 1		36.000	39.500	1.5	1.5	2.0	9.750	13.60	0.000	3.000
OPERATING ENGINEER	HWY 2		33.490	39.500	1.5	1.5	2.0	9.750	13.60	0.000	3.000
OPERATING ENGINEER	HWY 3		29.340	39.500	1.5	1.5	2.0	9.750	13.60	0.000	3.000
PAINTER	ALL		32.900	34.900	1.5	1.5	1.5	9.650	8.200	0.000	1.250
PAINTER SIGNS	BLD		33.920	38.090	1.5	1.5	1.5	2.600	2.710	0.000	0.000
PILEDRIVER	BLD		29.830	32.080	1.5	1.5	2.0	7.450	13.66	0.000	0.520
PILEDRIVER	HWY		31.820	34.070	1.5	1.5	2.0	7.450	13.94	0.000	0.520
PIPEFITTER	BLD		37.400	41.510	1.5	1.5	2.0	7.000	11.63	0.000	1.060
PLASTERER	BLD		27.770	28.770	1.5	1.5	2.0	8.140	12.76	0.000	0.600
PLUMBER	BLD		33.570	36.590	1.5	1.5	2.0	7.000	13.31	0.000	0.900
ROOFER	BLD		28.580	30.010	1.5	1.5	2.0	8.450	7.220	0.000	0.250
SHEETMETAL WORKER	BLD		31.920	33.520	1.5	1.5	2.0	7.270	13.08	0.000	0.660
SIGN HANGER	HWY		34.020	36.020	1.5	1.5	2.0	9.390	11.56	0.000	0.390
SPRINKLER FITTER	BLD		36.390	39.140	1.5	1.5	2.0	8.420	8.500	0.000	0.450
STEEL ERECTOR	HWY		34.020	36.020	1.5	1.5	2.0	9.390	11.56	0.000	0.390
STONE MASON	BLD		32.060	33.560	1.5	1.5	2.0	7.700	9.130	0.000	0.560
TERRAZZO FINISHER	BLD		29.750	0.000	1.5	1.5	2.0	7.700	9.130	0.000	0.550
TERRAZZO MASON	BLD		31.510	32.760	1.5	1.5	2.0	7.700	9.130	0.000	0.550
TILE MASON	BLD		31.510	32.760	1.5	1.5	2.0	7.700	9.130	0.000	0.550
TRUCK DRIVER	ALL 1		31.230	0.000	1.5	1.5	2.0	10.30	4.840	0.000	0.250
TRUCK DRIVER	ALL 2		31.680	0.000	1.5	1.5	2.0	10.30	4.840	0.000	0.250
TRUCK DRIVER	ALL 3		31.890	0.000	1.5	1.5	2.0	10.30	4.840	0.000	0.250
TRUCK DRIVER	ALL 4		32.180	0.000	1.5	1.5	2.0	10.30	4.840	0.000	0.250
TRUCK DRIVER	ALL 5		33.020	0.000	1.5	1.5	2.0	10.30	4.840	0.000	0.250
TRUCK DRIVER	O&C 1		24.980	0.000	1.5	1.5	2.0	10.30	4.840	0.000	0.250
TRUCK DRIVER	O&C 2		25.340	0.000	1.5	1.5	2.0	10.30	4.840	0.000	0.250
TRUCK DRIVER	O&C 3		25.510	0.000	1.5	1.5	2.0	10.30	4.840	0.000	0.250
TRUCK DRIVER	O&C 4		25.740	0.000	1.5	1.5	2.0	10.30	4.840	0.000	0.250
TRUCK DRIVER	O&C 5		26.420	0.000	1.5	1.5	2.0	10.30	4.840	0.000	0.250
TUCKPOINTER	BLD		32.060	33.560	1.5	1.5	2.0	7.700	9.130	0.000	0.560

Legend:

RG (Region)

TYP (Trade Type - All,Highway,Building,Floating,Oil & Chip,Rivers)

C (Class)

Base (Base Wage Rate)

FRMAN (Foreman Rate)

M-F>8 (OT required for any hour greater than 8 worked each day, Mon through Fri.)

OSA (Overtime (OT) is required for every hour worked on Saturday)

OSH (Overtime is required for every hour worked on Sunday and Holidays)

H/W (Health & Welfare Insurance)

Pensn (Pension)

Vac (Vacation)

Trng (Training)

Explanations

TAZEWELL COUNTY

ASBESTOS - See Laborers

CARPENTERS (NORTH) - That part of the county North including the towns of Marquette Hts., Morton, Creve Coeur and Deer Creek.

LABORERS (NORTHWEST) - The area bounded by the old city limits of East Peoria.

MILLWRIGHTS - See Carpenters

PILEDRIVERS - See Carpenters

The following list is considered as those days for which holiday rates of wages for work performed apply: New Years Day, Memorial Day, Fourth of July, Labor Day, Thanksgiving Day, Christmas Day and Veterans Day in some classifications/counties. Generally, any of these holidays which fall on a Sunday is celebrated on the following Monday. This then makes work performed on that Monday payable at the appropriate overtime rate for holiday pay. Common practice in a given local may alter certain days of celebration. If in doubt, please check with IDOL.

Oil and chip resealing (O&C) means the application of road oils and liquid asphalt to coat an existing road surface, followed by application of aggregate chips or gravel to coated surface, and subsequent rolling of material to seal the surface.

EXPLANATION OF CLASSES

ASBESTOS - GENERAL - removal of asbestos material/mold and hazardous materials from any place in a building, including mechanical systems where those mechanical systems are to be removed. This includes the removal of asbestos materials/mold and hazardous materials from ductwork or pipes in a building when the building is to be demolished at the time or at some close future date.

ASBESTOS - MECHANICAL - Removal of asbestos material from mechanical systems, such as pipes, ducts, and boilers, where the mechanical systems are to remain.

CERAMIC TILE FINISHER, MARBLE FINISHER, TERRAZZO FINISHER

Assisting, helping or supporting the tile, marble and terrazzo mechanic by performing their historic and traditional work assignments required to complete the proper installation of the work covered by said crafts. The term "Ceramic" is used for naming the classification only and is in no way a limitation of the product handled. Ceramic takes into consideration most hard tiles.

ELECTRONIC SYSTEMS TECHNICIAN

Installation, service and maintenance of low-voltage systems which utilizes the transmission and/or transference of voice, sound, vision, or digital for commercial, education, security and entertainment purposes for the following: TV monitoring and surveillance, background/foreground music, intercom and telephone interconnect, field programming, inventory control systems, microwave transmission, multi-media, multiplex, radio page, school, intercom and sound burglar alarms and low voltage master clock systems.

Excluded from this classification are energy management systems, life safety systems, supervisory controls and data acquisition systems not intrinsic with the above listed systems, fire alarm systems, nurse call systems and raceways exceeding fifteen feet in length.

TRUCK DRIVER - BUILDING, HEAVY AND HIGHWAY CONSTRUCTION

Class 1. Drivers on 2 axle trucks hauling less than 9 ton. Air compressor and welding machines and brooms, including those pulled by separate units, truck driver helpers, warehouse employees, mechanic helpers, greasers and tiremen, pickup trucks when hauling materials, tools, or workers to and from and on-the-job site, and fork lifts up to 6,000 lb. capacity.

Class 2. Two or three axle trucks hauling more than 9 ton but hauling less than 16 ton. A-frame winch trucks, hydrolift trucks, vector trucks or similar equipment when used for transportation purposes. Fork lifts over 6,000 lb. capacity, winch trucks, four axle combination units, and ticket writers.

Class 3. Two, three or four axle trucks hauling 16 ton or more. Drivers on water pulls, articulated dump trucks, mechanics and working forepersons, and dispatchers. Five axle or more combination units.

Class 4. Low Boy and Oil Distributors.

Class 5. Drivers who require special protective clothing while employed on hazardous waste work.

TRUCK DRIVER - OIL AND CHIP RESEALING ONLY.

This shall encompass laborers, workers and mechanics who drive contractor or subcontractor owned, leased, or hired pickup, dump, service, or oil distributor trucks. The work includes transporting materials and equipment (including but not limited to, oils, aggregate supplies, parts, machinery and tools) to or from the job site; distributing oil or liquid asphalt and aggregate; stock piling material when in connection with the actual oil and chip contract. The Truck Driver (Oil & Chip Resealing) wage classification does not include supplier delivered materials.

OPERATING ENGINEERS - BUILDING

Class 1. Cranes; Overhead Cranes; Gradall; All Cherry Pickers;

Mechanics; Central Concrete Mixing Plant Operator; Road Pavers (27E - Dual Drum - Tri Batchers); Blacktop Plant Operators and Plant Engineers; 3 Drum Hoist; Derricks; Hydro Cranes; Shovels; Skimmer Scoops; Koehring Scooper; Drag Lines; Backhoe; Derrick Boats; Pile Drivers and Skid Rigs; Clamshells; Locomotive Cranes; Dredge (all types) Motor Patrol; Power Blades - Dumore - Elevating and similar types; Tower Cranes (Crawler-Mobile) and Stationary; Crane-type Backfiller; Drott Yumbo and similar types considered as Cranes; Caisson Rigs; Dozer; Tournadozer; Work Boats; Ross Carrier; Helicopter; Tournapulls - all and similar types; Scoops (all sizes); Pushcats; Endloaders (all types); Asphalt Surfacing Machine; Slip Form Paver; Rock Crusher; Heavy Equipment Greaser; CMI, CMI Belt Placer, Auto Grade & 3 Track and similar types; Side Booms; Multiple Unit Earth Movers; Creter Crane; Trench Machine; Pump-crete-Belt Crete-Squeeze Cretes-Screw-type Pumps and Gypsum; Bulker & Pump - Operator will clean; Formless Finishing Machine; Flaherty Spreader or similar types; Screed Man on Laydown Machine; Wheel Tractors (industrial or Farm-type w/Dozer-Hoe-Endloader or other attachments); F.W.D. & Similar Types; Vermeer Concrete Saw.

Class 2. Dinkeys; Power Launches; PH One-pass Soil Cement Machine (and similar types); Pugmill with Pump; Backfillers; Euclid Loader; Forklifts; Jeeps w/Ditching Machine or other attachments; Tuneluger; Automatic Cement and Gravel Batching Plants; Mobile Drills (Soil Testing) and similar types; Gurries and Similar Types; (1) and (2) Drum Hoists (Buck Hoist and Similar Types); Chicago Boom; Boring Machine & Pipe Jacking Machine; Hydro Boom; Dewatering System; Straw Blower; Hydro Seeder; Assistant Heavy Equipment Greaser on Spread; Tractors (Track type) without Power Unit pulling Rollers; Rollers on Asphalt -- Brick Macadem; Concrete Breakers; Concrete Spreaders; Mule Pulling Rollers; Center Stripper; Cement Finishing Machines & CMI Texture & Reel Curing Machines; Cement Finishing Machine; Barber Green or similar loaders; Vibro Tamper (All similar types) Self-propelled; Winch or Boom Truck; Mechanical Bull Floats; Mixers over 3 Bag to 27E; Tractor pulling Power Blade or Elevating Grader; Porter Rex Rail; Clary Screed; Truck Type Hoptoe Oilers; Fireman; Spray Machine on Paving; Curb Machines; Truck Crane Oilers; Oil Distributor; Truck-Mounted Saws.

Class 3. Air Compressor; Power Subgrader; Straight Tractor; Trac Air without attachments; Herman Nelson Heater, Dravo, Warner, Silent Glo, and similar types; Roller: Five (5) Ton and under on Earth or Gravel; Form Grader; Crawler Crane & Skid Rig Oilers; Freight Elevators - permanently installed; Pump; Light Plant; Generator; Conveyor (1) or (2) - Operator will clean; Welding Machine; Mixer (3) Bag and Under (Standard Capacity with skip); Bulk Cement Plant; Oiler on Central Concrete Mixing Plant.

OPERATING ENGINEERS - HEAVY AND HIGHWAY CONSTRUCTION

CLASS 1. Cranes; Hydro Cranes; Shovels; Crane Type Backfiller; Tower, Mobile, Crawler, & Stationary Cranes; Derricks; Hoists (3 Drum); Draglines; Drott Yumbo & Similar Types considered as Cranes; 360 Degree Swing Excavator (Shears, Grapples, Movacs, etc.); Back Hoe; Derrick Boats; Pile Driver and Skid Rigs; Clam Shell; Locomotive - Cranes; Road Pavers - Single Drum - Dual Drum - Tri Batchers; Motor Patrols & Power Blades - Dumore - Elevating & Similar Types; Mechanics; Central Concrete Mixing Plant Operator; Asphalt Batch Plant Operators and Plant Engineers; Gradall; Caisson Rigs; Skimmer Scoop - Koehring Scooper; Dredges (all types); Hoptoe; All Cherry Pickers; Work Boat; Ross Carrier; Helicopter; Dozer; Tournadozer; Tournapulls - all and similar types; Operation of Concrete and all Recycle Machines; Multiple Unit Earth Movers; Scoops (all sizes); Pushcats; Endloaders (all types); Asphalt Surfacing Machine; Slip Form Paver; Rock Crusher; Operation of Material Crusher, Screening Plants, and

Tunnel Boring Machine; Heavy Equipment Greaser (top greaser on spread); CMI, Auto Grade, CMI Belt Placer & 3 Track and Similar Types; Side Booms; Asphalt Heater & Planer Combination (used to plane streets); Wheel Tractors (with Dozer, Hoe or Endloader Attachments); CAT Earthwork Compactors and Similar Types; Blaw Knox Spreader and Similar Types; Trench Machines; Pump Crete - Belt Crete - Squeeze Crete - Screw Type Pumps and Gypsum (operator will clean); Creter Crane; Operation of Concrete Pump Truck; Formless Finishing Machines; Flaherty Spreader or Similar Types; Screed Man on Laydown Machine; Vermeer Concrete Saw; Operation of Laser Screed; Span Saw; Dredge Leverman; Dredge Engineer; Lull or Similar Type; Hydro-Boom Truck; Operation of Guard Rail Machine; and Starting Engineer on Pipeline or Construction (11 or more pieces) including: Air Compressor (Trailer Mounted), All Forced Air Heaters (regardless of Size), Water Pumps (Greater than 4-1/2" or Total Discharge Over 4-1/2"), Light Plants, Generators (Trailer Mounted - Excluding Decontamination Trailer), Welding Machines (Any Size or Mode of Power), Conveyor, Mixer (any size), Stud Welder, Power Pac, etc, and Ground Heater (Trailer Mounted).

CLASS 2. Bulker & Pump; Power Launches; Boring Machine & Pipe Jacking Machine; Dinkeys; Operation of Carts, Powered Haul Unit for a Boring Machine; P & H One Pass Soil Cement Machines and Similar Types; Wheel Tractors (Industry or Farm Type - Other); Back Fillers; Euclid Loader; Fork Lifts; Jeep w/Ditching Machine or Other Attachments; Tunneluger; Automatic Cement & Gravel Batching Plants; Mobile Drills - Soil Testing and Similar Types; Pugmill with Pump; All (1) and (2) Drum Hoists; Dewatering System; Straw Blower; Hydro-Seeder; Bump Grinders (self-propelled); Assistant Heavy Equipment Greaser; Apsco Spreader; Tractors (Track-Type) without Power Units Pulling Rollers; Rollers on Asphalt - Brick or Macadam; Concrete Breakers; Concrete Spreaders; Cement Strippers; Cement Finishing Machines & CMI Texture & Reel Curing Machines; Vibro-Tampers (All Similar Types Self-Propelled); Mechanical Bull Floats; Self-Propelled Concrete Saws; Truck Mounted Power Saws; Operation of Curb Cutters; Mixers - Over Three (3) Bags; Winch and Boom Trucks; Tractor Pulling Power Blade or Elevating Grader; Porter Rex Rail; Clary Screed; Mule Pulling Rollers; Pugmill without Pump; Barber Greene or Similar Loaders; Track Type Tractor w/Power Unit attached (minimum); Fireman; Spray Machine on Paving; Curb Machines; Paved Ditch Machine; Power Broom; Self-Propelled Sweepers; Self-Propelled Conveyors; Power Subgrader; Oil Distributor; Straight Tractor; Truck Crane Oiler; Truck Type Oilers; Directional Boring Machine; Horizontal Directional Drill; Articulating End Dump Vehicles; Starting Engineer on Pipeline or Construction (6 -10 pieces) including: Air Compressor (Trailer Mounted), All Forced Air Heaters (regardless of Size), Water Pumps (Greater than 4-1/2" or Total Discharge Over 4-1/2"), Light Plants, Generators (Trailer Mounted - Excluding Decontamination Trailer), Welding Machines (Any Size or Mode of Power), Conveyor, Mixer (any size), Stud Welder, Power Pac, etc., and Ground Heater (Trailer Mounted).

CLASS 3. Straight Framed Truck Mounted Vac Unit (separately powered); Trac Air Machine (without attachments); Rollers - Five Ton and Under on Earth and Gravel; Form Graders; Bulk Cement Plant; Oilers; and Starting Engineer on Pipeline or Construction (3 - 5 pieces) including: Air Compressor (Trailer Mounted), All Forced Air Heaters (regardless of Size), Water Pumps (Greater than 4-1/2" or Total Discharge Over 4-1/2"), Light Plants, Generators (Trailer Mounted - Excluding Decontamination Trailer), Welding Machines (Any Size or Mode of Power), Conveyor, Mixer (any size), Stud Welder, Power Pac, etc., and Ground Heater (Trailer Mounted).

Other Classifications of Work:

For definitions of classifications not otherwise set out, the

Department generally has on file such definitions which are available. If a task to be performed is not subject to one of the classifications of pay set out, the Department will upon being contacted state which neighboring county has such a classification and provide such rate, such rate being deemed to exist by reference in this document. If no neighboring county rate applies to the task, the Department shall undertake a special determination, such special determination being then deemed to have existed under this determination. If a project requires these, or any classification not listed, please contact IDOL at 217-782-1710 for wage rates or clarifications.

LANDSCAPING

Landscaping work falls under the existing classifications for laborer, operating engineer and truck driver. The work performed by landscape plantsman and landscape laborer is covered by the existing classification of laborer. The work performed by landscape operators (regardless of equipment used or its size) is covered by the classifications of operating engineer. The work performed by landscape truck drivers (regardless of size of truck driven) is covered by the classifications of truck driver.

Union County Prevailing Wage for May 2013

(See explanation of column headings at bottom of wages)

Trade Name	RG	TYP	C	Base	FRMAN	M-F>8	OSA	OSH	H/W	Pensn	Vac	Trng
ASBESTOS ABT-GEN		ALL		25.300	25.750	1.5	1.5	2.0	5.750	10.35	0.000	0.900
ASBESTOS ABT-MEC		BLD		29.860	30.860	1.5	1.5	2.0	6.950	3.000	0.000	0.000
BOILERMAKER		BLD		31.500	34.000	1.5	1.5	2.0	7.070	18.73	1.000	0.350
BRICK MASON		BLD		28.620	30.120	1.5	1.5	2.0	8.200	7.030	0.000	0.430
CARPENTER		BLD		31.890	33.390	1.5	1.5	2.0	6.550	6.750	0.000	0.400
CARPENTER		HWY		31.840	33.340	1.5	1.5	2.0	6.550	6.750	0.000	0.400
CEMENT MASON		BLD		28.200	29.700	1.5	1.5	2.0	6.600	5.400	0.000	0.500
CEMENT MASON		HWY		27.290	28.290	1.5	1.5	2.0	6.600	5.160	0.000	0.400
CERAMIC TILE FNSHER		BLD		27.120	0.000	1.5	1.5	2.0	8.200	7.030	0.000	0.430
ELECTRIC PWR EQMT OP		ALL	1	35.570	0.000	1.5	1.5	2.0	5.000	9.960	0.000	0.360
ELECTRIC PWR EQMT OP		ALL	2	31.740	0.000	1.5	1.5	2.0	5.000	8.880	0.000	0.320
ELECTRIC PWR GRNDMAN		ALL		26.100	0.000	1.5	1.5	2.0	5.000	7.310	0.000	0.260
ELECTRIC PWR LINEMAN		ALL		44.630	47.650	1.5	1.5	2.0	5.000	12.50	0.000	0.450
ELECTRICIAN		ALL		39.350	41.600	1.5	1.5	2.0	6.140	9.440	0.000	0.790
ELECTRONIC SYS TECH		BLD		32.570	34.320	1.5	1.5	2.0	6.000	4.240	0.000	0.400
FLOOR LAYER		BLD		29.330	30.080	1.5	1.5	2.0	6.550	6.750	0.000	0.400
GLAZIER		BLD		26.780	28.030	1.5	1.5	2.0	6.120	5.200	0.000	0.300
HT/FROST INSULATOR		BLD		37.260	38.260	1.5	1.5	2.0	7.850	11.16	0.000	0.500
IRON WORKER		ALL		27.730	29.730	1.5	1.5	2.0	7.010	11.41	0.000	0.500
LABORER		BLD		25.300	25.750	1.5	1.5	2.0	5.750	10.35	0.000	0.800
LABORER		HWY		25.300	25.750	1.5	1.5	2.0	5.750	10.35	0.000	0.800
LABORER		O&C		17.740	18.190	1.5	1.5	2.0	5.450	8.450	0.000	0.800
MACHINIST		BLD		43.550	46.050	1.5	1.5	2.0	6.130	8.950	1.850	0.000
MARBLE FINISHERS		BLD		27.120	0.000	1.5	1.5	2.0	8.200	7.030	0.000	0.430
MARBLE MASON		BLD		28.620	30.120	1.5	1.5	2.0	8.200	7.030	0.000	0.430
MILLWRIGHT		BLD		31.890	33.390	1.5	1.5	2.0	6.550	6.750	0.000	0.400
MILLWRIGHT		HWY		31.840	33.340	1.5	1.5	2.0	6.550	6.750	0.000	0.400
OE RIVER 1		RIV	1	33.550	34.550	1.5	1.5	2.0	7.000	8.800	0.000	1.450
OE RIVER 2		RIV	2	30.100	34.550	1.5	1.5	2.0	7.000	8.800	0.000	1.450
OPERATING ENGINEER		ALL	1	33.450	34.450	1.5	1.5	2.0	7.000	8.800	0.000	1.450
OPERATING ENGINEER		ALL	2	31.550	34.450	1.5	1.5	2.0	7.000	8.800	0.000	1.450
OPERATING ENGINEER		ALL	3	24.150	34.450	1.5	1.5	2.0	7.000	8.800	0.000	1.450
OPERATING ENGINEER		ALL	4	21.400	27.800	1.5	1.5	2.0	5.650	6.100	0.000	1.100
OPERATING ENGINEER		O&C	1	25.090	26.090	1.5	1.5	2.0	7.000	8.800	0.000	1.450
OPERATING ENGINEER		O&C	2	23.660	26.090	1.5	1.5	2.0	7.000	8.800	0.000	1.450

OPERATING ENGINEER	O&C	3	18.120	26.090	1.5	1.5	2.0	7.000	8.800	0.000	1.450
OPERATING ENGINEER	O&C	4	16.050	21.100	1.5	1.5	2.0	5.650	6.100	0.000	1.100
PAINTER	BLD		26.260	27.760	1.5	1.5	2.0	6.630	7.070	0.000	0.500
PAINTER	HWY		30.560	32.060	1.5	1.5	2.0	6.630	7.070	0.000	0.500
PAINTER OVER 30FT	BLD		27.260	28.760	1.5	1.5	2.0	6.630	7.070	0.000	0.500
PAINTER PWR EQMT	BLD		27.260	28.760	1.5	1.5	2.0	6.630	7.070	0.000	0.500
PAINTER PWR EQMT	HWY		31.560	33.060	1.5	1.5	2.0	6.630	7.070	0.000	0.500
PILEDRIIVER	BLD		31.890	33.390	1.5	1.5	2.0	6.550	6.750	0.000	0.400
PILEDRIIVER	HWY		31.840	33.340	1.5	1.5	2.0	6.550	6.750	0.000	0.400
PIPEFITTER	BLD		41.470	45.620	1.5	2.0	2.0	8.450	5.780	0.000	1.250
PLASTERER	BLD		28.200	29.700	1.5	1.5	2.0	6.600	5.400	0.000	0.500
PLUMBER	BLD		41.470	45.620	1.5	2.0	2.0	8.450	5.780	0.000	1.250
ROOFER	BLD		23.900	24.900	1.5	1.5	2.0	8.650	3.800	0.000	0.000
SHEETMETAL WORKER	ALL		31.690	33.190	1.5	1.5	2.0	7.130	6.730	1.910	0.360
SPRINKLER FITTER	BLD		36.390	39.140	1.5	1.5	2.0	8.420	8.500	0.000	0.450
STONE MASON	BLD		28.620	30.120	1.5	1.5	2.0	8.200	7.030	0.000	0.430
TERRAZZO FINISHER	BLD		27.120	0.000	1.5	1.5	2.0	8.200	7.030	0.000	0.430
TERRAZZO MASON	BLD		28.620	30.120	1.5	1.5	2.0	8.200	7.030	0.000	0.430
TRUCK DRIVER	ALL	1	30.070	0.000	1.5	1.5	2.0	10.30	6.100	0.000	0.250
TRUCK DRIVER	ALL	2	30.520	0.000	1.5	1.5	2.0	10.30	6.100	0.000	0.250
TRUCK DRIVER	ALL	3	30.740	0.000	1.5	1.5	2.0	10.30	6.100	0.000	0.250
TRUCK DRIVER	ALL	4	31.030	0.000	1.5	1.5	2.0	10.30	6.100	0.000	0.250
TRUCK DRIVER	ALL	5	31.850	0.000	1.5	1.5	2.0	10.30	6.100	0.000	0.250
TRUCK DRIVER	O&C	1	22.750	0.000	1.5	1.5	2.0	2.920	6.700	0.000	0.250
TRUCK DRIVER	O&C	2	19.150	0.000	1.5	1.5	2.0	2.920	6.700	0.000	0.250
TRUCK DRIVER	O&C	3	19.650	0.000	1.5	1.5	2.0	2.920	6.700	0.000	0.250
TUCKPOINTER	BLD		28.620	30.120	1.5	1.5	2.0	8.200	7.030	0.000	0.430

Legend :

RG (Region)

TYP (Trade Type - All,Highway,Building,Floating,Oil & Chip,Rivers)

C (Class)

Base (Base Wage Rate)

FRMAN (Foreman Rate)

M-F>8 (OT required for any hour greater than 8 worked each day, Mon through Fri.

OSA (Overtime (OT) is required for every hour worked on Saturday)

OSH (Overtime is required for every hour worked on Sunday and Holidays)

H/W (Health & Welfare Insurance)

Pensn (Pension)

Vac (Vacation)

Trng (Training)

Explanations

UNION COUNTY

The following list is considered as those days for which holiday rates of wages for work performed apply: New Years Day, Memorial Day, Fourth of July, Labor Day, Thanksgiving Day, Christmas Day and

Veterans Day in some classifications/counties. Generally, any of these holidays which fall on a Sunday is celebrated on the following Monday. This then makes work performed on that Monday payable at the appropriate overtime rate for holiday pay. Common practice in a given local may alter certain days of celebration. If in doubt, please check with IDOL.

Oil and chip resealing (O&C) means the application of road oils and liquid asphalt to coat an existing road surface, followed by application of aggregate chips or gravel to coated surface, and subsequent rolling of material to seal the surface.

EXPLANATION OF CLASSES

ASBESTOS - GENERAL - removal of asbestos material/mold and hazardous materials from any place in a building, including mechanical systems where those mechanical systems are to be removed. This includes the removal of asbestos materials/mold and hazardous materials from ductwork or pipes in a building when the building is to be demolished at the time or at some close future date.

ASBESTOS - MECHANICAL - removal of asbestos material from mechanical systems, such as pipes, ducts, and boilers, where the mechanical systems are to remain.

LABORER - OIL AND CHIP RESEALING ONLY

Hook and unhook chip box from aggregate truck; distribute material within chip box; perform flagging work related to oil and chip resealing; hand spray oil fluids; handle traffic control, including setting-up and maintaining barricades, drums, cones, delineators, signs and other such items, as well as laying-out and applying or removing temporary roadway markings used to control traffic in job site related to oil and chip resealing; and perform clean-up related to oil and chip resealing.

CERAMIC TILE FINISHER, MARBLE FINISHER, TERRAZZO FINISHER

Assisting, helping or supporting the tile, marble and terrazzo mechanic by performing their historic and traditional work assignments required to complete the proper installation of the work covered by said crafts. The term "Ceramic" is used for naming the classification only, and is in no a limitation of the product handled. Ceramic takes into consideration most hard tiles.

ELECTRIC POWER LINEMAN

Construction, maintenance and dismantling of overhead and underground electric power lines, including high voltage pipe type cable work, and associated structures and equipment.

ELECTRIC POWER EQUIPMENT OPERATOR - CLASS 1

Operation of all crawler type equipment D-4 and larger from the ground to assist the Electric Power Linemen in performing their duties.

ELECTRIC POWER EQUIPMENT OPERATORS - CLASS 2

Operation of all other equipment from the ground to assist the Electric Power Linemen in performing their duties.

ELECTRIC POWER GROUNDMAN

Applies to workers who assist the Electric Power Lineman from the ground.

ELECTRONIC SYSTEMS TECHNICIAN

Installation, service and maintenance of low-voltage systems which utilizes the transmission and/or transference of voice, sound, vision, or digital for commercial, education, security and entertainment purposes for the following: TV monitoring and surveillance, background/foreground music, intercom and telephone interconnect, field programming, inventory control systems, microwave transmission, multi-media, multiplex, radio page, school, intercom and sound burglar alarms and low voltage master clock systems.

Excluded from this classification are energy management systems, life safety systems, supervisory controls and data acquisition systems not intrinsic with the above listed systems, fire alarm systems, nurse call systems and raceways exceeding fifteen feet in length.

TRUCK DRIVER - BUILDING, HEAVY AND HIGHWAY CONSTRUCTION

Class 1. Drivers on 2 axle trucks hauling less than 9 ton. Air compressor and welding machines and brooms, including those pulled by separate units, truck driver helpers, warehouse employees, mechanic helpers, greasers and tiremen, pickup trucks when hauling materials, tools, or workers to and from and on-the-job site, and fork lifts up to 6,000 lb. capacity.

Class 2. Two or three axle trucks hauling more than 9 ton but hauling less than 16 ton. A-frame winch trucks, hydrolift trucks, vector trucks or similar equipment when used for transportation purposes. Fork lifts over 6,000 lb. capacity, winch trucks, four axle combination units, and ticket writers.

Class 3. Two, three or four axle trucks hauling 16 ton or more. Drivers on water pulls, articulated dump trucks, mechanics and working forepersons, and dispatchers. Five axle or more combination units.

Class 4. Low Boy and Oil Distributors.

Class 5. Drivers who require special protective clothing while employed on hazardous waste work.

TRUCK DRIVER - O & C (Oil and Chip Resealing ONLY)

It involves driving of contractor or subcontractor owned, leased, or hired pickup, dump, service, or oil distributor trucks. Includes transporting materials and equipment (including, but not limited to oils, aggregate supplies, parts, machinery and tools) to or from the job site; distributing oil or liquid asphalt and aggregate; stock piling material; and maintaining trucks at job site related to oil and chip resealing.

Class 1. Distributors, liquid asphalt hauling and hauling of asphalt rubber-tired rollers.

Class 2. Stockpiling.

Class 3. Tandem hauling to job site.

OPERATING ENGINEERS - BUILDING, HEAVY AND HIGHWAY CONSTRUCTION

Class 1. APSCO or Equal Spreading Machine, Backhoe, Backfiller, Boom or Winch Cat, Bituminous Mixplane Machine, Blacksmith, Bituminous Surfacing Machine, Bull-Dozer, Crane, Shovel, Dragline, Truck Crane, Pile Driver, Concrete Breaker, Concrete or Pumpcrete Pumps, Dinky or Standard Locomotives, Well or Caisson Drills, Elevating Grader, Fork Lifts, Flexplane, Gradeall, Hi-Lift Hoists, Guy-Derricks, Hysters,

Mechanic Motor Patrol, Mixers-21 cu. ft. or over, Push Cats, Pulls and Scrapers, Two Well Point Pumps, Pulverizer or Tiller, PugMill, Rubber-Tired Farm Type Tractor with Bulldozer/Blade/Auger or hi-lift over 1/2 yd., Jersey Spreader, Tract-Air used with Drill or Hi-Lift, Trenching or Ditching Machines, Wood Chipper w/Tractor, Self-Propelled Roller w/Blade, Equipment Greaser, Self-Propelled Bump Grinder on Concrete pavement, Boat Operator, Skid-Loaders, Tuggers, Lazer Screed, and Self-Propelled Chip Spreader (when others run conveyors).

Class 2. Any type tractor pulling any type roller or disc, Two Air Compressors (220 cu. ft. capacity or over), Two AirTract Drills, Air-Track Drill w/Compressor, Automatic Bins or Scales w/Compressor or Generator, Pipeline Boring Machine, Bulk Cement Plant w/Separate Compressor, Power Operated Bull Float, Hydra-Lift w/Single Motor, Straw Mulcher Blower w/Spout, Self-Propelled Roller/Compactor, Back-End man on Bituminous Surfacing Machine, oiler on milling machine.

Class 3. Air Compressor w/Valve driving piling, Boom or Winch Type Truck, Two Conveyors, Self-Propelled Concrete Saw, Form Grader, Truck Crane Oiler, Self-Propelled Vibrator, Rubber Tired Farm Type Tractor w/Blade/Bulldozer/Auger/hi-lift - 1/2 yd. or less, Elevator Operator, Man Lift (scissor lift) when lifting materials.

Class 4. Air-Track Drill (one), Belt Drag Machine, Power Broom, Mechanical Plasterer Applicator, Trac-Air, Air Compressor (220 cu. ft. or over) One, Air Compressor (under 220 cu. ft) four, Automatic Bin, Bulk Cement Plant w/Built-in Compressor running off same motor or electric motor, Fireman or Switchman, Self-Propelled Form Tamper, Light Plants (4), Welding Machines (4), Pumps (4), or Combination of four (4) Pumps, Light Plants, Welding Machines, Air-Compressors (under 220 cu. ft.), Mudjacks or Wood Chipper, Mixers - less than 21 cu. ft. Mortar Mixer w/Skip or Pump, Pipeline Tract Jack. One Operating Engineer may operate and maintain any combination of the following pieces of equipment, not to exceed four (4) which shall be within a reasonable distance, such combination may include any equipment in this classification: (Compressors, Light Plants, Generators, Welding Machines, Pumps or Conveyors), One Well- Point Pump, Two Motor Driven Heaters, One Air Compressor (under 220 cu. ft.), One Engine-Driven Conveyor, One Motor Driven Heater, One Light Plant, One Pump, One Welding Machine, One Ulmac or Equal Spreader, Oilers, and one Generator 10 kw or greater.

OPERATING ENGINEER - O & C (Oil and Chip Resealing ONLY). Includes the operation of all motorized heavy equipment used in oil and chip rsealing, including but not limited to operating self-propelled chip spreaders, and all types of rollers (both hard and rubber tired); and other duties pertaining to the operation or maintenance of heavy equipment relatd to oil and chip resealing.

Class 1. See Class 1 above for types of equipment operated.

Class 2. See Class 2 above for types of equipment operated.

Class 3. See Class 3 above for types of equipment operated.

Class 4. See Class 4 above for types of equipment operated.

OPERATING ENGINEER RIVER WORK 1 - operate the following machines when working on River Work and Levee Work on the Mississippi and Ohio Rivers, Lakes and Tributaries: Crane, Shovel, Drageline, Scrapers, Dredge, Derrick, Pile-Driver, Push Boat, all power boat operators, Mechanic, Engineman on Dredge, Leverman on Dredge, All Bituminous

Spreader machines, Backhoe, Backfiller, Boom, or Winch Cat, Bituminous Mixplane Machine, Blacksmith, Bituminous Surfacing Machine, Bulldozer, Truck Cranes, Hydraulic Truck Mounted Boom/Crane, Concrete Finishing Machine, or Spreader Machine, Concrete Breaker, Concrete or Pumpcrete Machines, Concrete Plant Operator, All Off Road Material Hauling Equipment, Dinky or Standard Locomotives, Well Drill, Elevating Grader, Fork-Lifts, Flexplane, Gradeall, Hi-Lift, Power Handblade Tugger type Hoist, Hoist Two Drum (or over one), Guyderrick, Hyster, Motor Patrol, Mixers - 21 Cu. Ft. or over, Push Cat, Pulls, & Scrapers, Pumps-Two Well Points, Equipment Greaser, P & H Pulverizer or Pulverizer equal to Pugmill, Pugmill, Rubber-Tired farm type tractor w/Bulldozer/Blade/Auger or Hi-Lift over ½ yard, Skimmer Scoops, Seaman Tiller, Jersey Spreader, Tract-Air used with Drill or Hi-Lift, Trenching or Ditching Machine, Wood Chipper w/Tractor, self-propelled roller w/Blade, Concrete Pumps and Small Equipment Operators.

OPERATING ENGINEER RIVER 2 - when working on River Work and Levee Work on the Mississippi and Ohio Rivers, Lakes and Tributaries shall be employed as the Oiler or Fireman on Crane, Dragline, Shovel, Dredge, Truck Crane, Pile Driver, Gradeall, Dinky or Standard Locomotive, Guy Derrick, Trenching Machine or Ditching Machine 80 H.P. and over, All Terrain (cherry-picker) with over 40 ton Lifting Capacity, Deck Oiler and Deckhands.

Other Classifications of Work:

For definitions of classifications not otherwise set out, the Department generally has on file such definitions which are available. If a task to be performed is not subject to one of the classifications of pay set out, the Department will upon being contacted state which neighboring county has such a classification and provide such rate, such rate being deemed to exist by reference in this document. If no neighboring county rate applies to the task, the Department shall undertake a special determination, such special determination being then deemed to have existed under this determination. If a project requires these, or any classification not listed, please contact IDOL at 217-782-1710 for wage rates or clarifications.

LANDSCAPING

Landscaping work falls under the existing classifications for laborer, operating engineer and truck driver. The work performed by landscape plantsman and landscape laborer is covered by the existing classification of laborer. The work performed by landscape operators (regardless of equipment used or its size) is covered by the classifications of operating engineer. The work performed by landscape truck drivers (regardless of size of truck driven) is covered by the classifications of truck driver.

Vermilion County Prevailing Wage for May 2013

(See explanation of column headings at bottom of wages)

Trade Name	RG	TYP	C	Base	FRMAN	M-F>8	OSA	OSH	H/W	Pensn	Vac	Trng
=====	==	===	=	=====	=====	=====	===	===	=====	=====	=====	=====
ASBESTOS ABT-GEN		BLD		29.610	30.860	1.5	1.5	2.0	5.750	9.790	0.000	0.900
ASBESTOS ABT-MEC		BLD		20.450	21.450	1.5	1.5	2.0	6.250	5.000	0.000	0.000
BOILERMAKER		BLD		35.010	38.010	2.0	2.0	2.0	7.070	13.83	0.000	0.300
BRICK MASON		BLD		30.670	32.170	1.5	1.5	2.0	6.600	10.03	0.000	0.630
CARPENTER		BLD		33.000	35.250	1.5	1.5	2.0	7.450	9.250	0.000	0.520
CARPENTER		HWY		33.350	35.100	1.5	1.5	2.0	7.450	9.250	0.000	0.520

CEMENT MASON	BLD	29.800	31.300	1.5	1.5	2.0	6.600	8.360	0.000	0.500
CEMENT MASON	HWY	30.390	31.890	1.5	1.5	2.0	6.600	8.560	0.000	0.500
CERAMIC TILE FNSHER	BLD	28.400	0.000	1.5	1.5	2.0	6.600	7.930	0.000	0.000
ELECTRIC PWR EQMT OP	ALL	35.440	0.000	1.5	1.5	2.0	5.000	10.98	0.000	0.270
ELECTRIC PWR GRNDMAN	ALL	24.320	0.000	1.5	1.5	2.0	5.000	7.540	0.000	0.180
ELECTRIC PWR LINEMAN	ALL	39.370	41.910	1.5	1.5	2.0	5.000	12.20	0.000	0.300
ELECTRIC PWR TRK DRV	ALL	25.510	0.000	1.5	1.5	2.0	5.000	7.920	0.000	0.190
ELECTRICIAN	ALL	32.340	35.570	1.5	1.5	2.0	5.350	10.47	0.000	0.550
ELECTRONIC SYS TECH	BLD	30.500	32.250	1.5	1.5	2.0	5.350	6.410	0.000	0.400
FENCE ERECTOR	ALL	30.610	32.510	1.5	1.5	2.0	8.840	8.420	0.000	0.900
GLAZIER	BLD	26.580	28.080	1.5	1.5	2.0	6.160	5.310	0.000	0.400
HT/FROST INSULATOR	BLD	31.230	32.230	1.5	1.5	2.0	5.790	8.960	2.000	0.250
IRON WORKER	ALL	30.610	32.510	1.5	1.5	2.0	8.840	8.420	0.000	0.900
LABORER	BLD	27.610	28.860	1.5	1.5	2.0	5.750	9.790	0.000	0.900
LABORER	HWY	29.650	30.650	1.5	1.5	2.0	5.750	9.790	0.000	0.800
LATHER	BLD	33.000	35.250	1.5	1.5	2.0	7.450	9.250	0.000	0.520
MACHINIST	BLD	43.550	46.050	1.5	1.5	2.0	6.130	8.950	1.850	0.000
MARBLE FINISHERS	BLD	28.400	0.000	1.5	1.5	2.0	6.600	7.930	0.000	0.000
MARBLE MASON	BLD	29.900	0.000	1.5	1.5	2.0	6.600	7.930	0.000	0.000
MILLWRIGHT	BLD	29.620	31.870	1.5	1.5	2.0	7.450	13.09	0.000	0.520
MILLWRIGHT	HWY	31.400	33.150	1.5	1.5	2.0	7.450	13.54	0.000	0.520
OPERATING ENGINEER	ALL 1	36.950	0.000	1.5	1.5	2.0	7.250	8.700	0.000	0.800
OPERATING ENGINEER	ALL 2	23.900	0.000	1.5	1.5	2.0	7.250	8.700	0.000	0.800
PAINTER	ALL	33.560	35.060	1.5	1.5	2.0	6.600	4.420	0.000	0.570
PAINTER SIGNS	BLD	33.920	38.090	1.5	1.5	1.5	2.600	2.710	0.000	0.000
PILEDRIIVER	BLD	33.500	35.750	1.5	1.5	2.0	7.450	9.250	0.000	0.520
PILEDRIIVER	HWY	34.350	36.100	1.5	1.5	2.0	7.450	9.250	0.000	0.520
PIPEFITTER	ALL	35.820	38.510	1.5	1.5	2.0	6.100	6.630	0.000	0.610
PLASTERER	BLD	30.000	32.000	1.5	1.5	2.0	6.600	10.17	0.000	0.500
PLUMBER	ALL	35.820	38.510	1.5	1.5	2.0	6.100	6.630	0.000	0.610
ROOFER	BLD	28.750	30.250	1.5	1.5	2.0	9.150	8.400	0.000	0.200
SHEETMETAL WORKER	BLD	33.640	35.640	1.5	1.5	2.0	8.300	12.00	0.000	0.520
SPRINKLER FITTER	BLD	36.390	39.140	1.5	1.5	2.0	8.420	8.500	0.000	0.450
STONE MASON	BLD	30.670	32.170	1.5	1.5	2.0	6.600	10.03	0.000	0.630
TERRAZZO FINISHER	BLD	28.400	0.000	1.5	1.5	2.0	6.600	7.930	0.000	0.000
TERRAZZO MASON	BLD	29.900	0.000	1.5	1.5	2.0	6.600	7.930	0.000	0.000
TILE MASON	BLD	29.900	0.000	1.5	1.5	2.0	6.600	7.930	0.000	0.000
TRUCK DRIVER	ALL 1	31.230	0.000	1.5	1.5	2.0	10.30	4.840	0.000	0.250
TRUCK DRIVER	ALL 2	31.680	0.000	1.5	1.5	2.0	10.30	4.840	0.000	0.250
TRUCK DRIVER	ALL 3	31.890	0.000	1.5	1.5	2.0	10.30	4.840	0.000	0.250
TRUCK DRIVER	ALL 4	32.180	0.000	1.5	1.5	2.0	10.30	4.840	0.000	0.250
TRUCK DRIVER	ALL 5	33.020	0.000	1.5	1.5	2.0	10.30	4.840	0.000	0.250
TRUCK DRIVER	O&C 1	24.980	0.000	1.5	1.5	2.0	10.30	4.840	0.000	0.250
TRUCK DRIVER	O&C 2	25.340	0.000	1.5	1.5	2.0	10.30	4.840	0.000	0.250
TRUCK DRIVER	O&C 3	25.510	0.000	1.5	1.5	2.0	10.30	4.840	0.000	0.250
TRUCK DRIVER	O&C 4	25.740	0.000	1.5	1.5	2.0	10.30	4.840	0.000	0.250
TRUCK DRIVER	O&C 5	26.420	0.000	1.5	1.5	2.0	10.30	4.840	0.000	0.250
TUCKPOINTER	BLD	30.670	32.170	1.5	1.5	2.0	6.600	10.03	0.000	0.630

Legend :

RG (Region)

TYP (Trade Type - All,Highway,Building,Floating,Oil & Chip,Rivers)

C (Class)

Base (Base Wage Rate)

FRMAN (Foreman Rate)

M-F>8 (OT required for any hour greater than 8 worked each day, Mon through Fri.)

OSA (Overtime (OT) is required for every hour worked on Saturday)

OSH (Overtime is required for every hour worked on Sunday and Holidays)

H/W (Health & Welfare Insurance)

Pensn (Pension)

Vac (Vacation)

Trng (Training)

Explanations

VERMILION COUNTY

The following list is considered as those days for which holiday rates of wages for work performed apply: New Years Day, Memorial Day, Fourth of July, Labor Day, Thanksgiving Day, Christmas Day and Veterans Day in some classifications/counties. Generally, any of these holidays which fall on a Sunday is celebrated on the following Monday. This then makes work performed on that Monday payable at the appropriate overtime rate for holiday pay. Common practice in a given local may alter certain days of celebration. If in doubt, please check with IDOL.

Oil and chip resealing (O&C) means the application of road oils and liquid asphalt to coat an existing road surface, followed by application of aggregate chips or gravel to coated surface, and subsequent rolling of material to seal the surface.

EXPLANATION OF CLASSES

ASBESTOS - GENERAL - removal of asbestos material/mold and hazardous materials from any place in a building, including mechanical systems where those mechanical systems are to be removed. This includes the removal of asbestos materials/mold and hazardous materials from ductwork or pipes in a building when the building is to be demolished at the time or at some close future date.

ASBESTOS - MECHANICAL - removal of asbestos material from mechanical systems, such as pipes, ducts, and boilers, where the mechanical systems are to remain.

CERAMIC TILE FINISHER, MARBLE FINISHER, TERRAZZO FINISHER

Assisting, helping or supporting the tile, marble and terrazzo mechanic by performing their historic and traditional work assignments required to complete the proper installation of the work covered by said crafts. The term "Ceramic" is used for naming the classification only and is in no way a limitation of the product handled. Ceramic takes into consideration most hard tiles.

ELECTRONIC SYSTEMS TECHNICIAN

Installation, service and maintenance of low-voltage systems which utilizes the transmission and/or transference of voice, sound, vision, or digital for commercial, education, security and entertainment purposes for the following: TV monitoring and surveillance, background/foreground music, intercom and telephone interconnect, field programming, inventory control systems, microwave transmission, multi-media, multiplex, radio page, school, intercom and sound burglar alarms and low voltage master clock systems.

Excluded from this classification are energy management systems, life safety systems, supervisory controls and data acquisition systems not intrinsic with the above listed systems, fire alarm systems, nurse call systems and raceways exceeding fifteen feet in length.

TRUCK DRIVER - BUILDING, HEAVY AND HIGHWAY CONSTRUCTION

Class 1. Drivers on 2 axle trucks hauling less than 9 ton. Air compressor and welding machines and brooms, including those pulled by separate units, truck driver helpers, warehouse employees, mechanic helpers, greasers and tiremen, pickup trucks when hauling materials, tools, or workers to and from and on-the-job site, and fork lifts up to 6,000 lb. capacity.

Class 2. Two or three axle trucks hauling more than 9 ton but hauling less than 16 ton. A-frame winch trucks, hydrolift trucks, vactor trucks or similar equipment when used for transportation purposes. Fork lifts over 6,000 lb. capacity, winch trucks, four axle combination units, and ticket writers.

Class 3. Two, three or four axle trucks hauling 16 ton or more. Drivers on water pulls, articulated dump trucks, mechanics and working forepersons, and dispatchers. Five axle or more combination units.

Class 4. Low Boy and Oil Distributors.

Class 5. Drivers who require special protective clothing while employed on hazardous waste work.

TRUCK DRIVER - OIL AND CHIP RESEALING ONLY.

This shall encompass laborers, workers and mechanics who drive contractor or subcontractor owned, leased, or hired pickup, dump, service, or oil distributor trucks. The work includes transporting materials and equipment (including but not limited to, oils, aggregate supplies, parts, machinery and tools) to or from the job site; distributing oil or liquid asphalt and aggregate; stock piling material when in connection with the actual oil and chip contract. The Truck Driver (Oil & Chip Resealing) wage classification does not include supplier delivered materials.

OPERATING ENGINEERS - BUILDING, HEAVY AND HIGHWAY CONSTRUCTION

Class 1. Power Cranes, Draglines, Derricks, Shovels, Gradalls, Mechanics, Tractor Highlift, Tournadozer, Concrete Mixers with Skip, Tournamixer, Two Drum Machine, One Drum Hoist with Tower or Boom, Cableways, Tower Machines, Motor Patrol, Boom Tractor, Boom or Winch Truck, Winch or Hydraulic Boom Truck, Truck Crane, Tournapull, Tractor Operating Scoops, Bulldozer, Push Tractor, Asphalt Planer, Finishing Machine on Asphalt, Large Rollers on Earth, Rollers on Asphalt Mix, Ross Carrier or similar Machine, Gravel Processing Machine, Asphalt Plant Engineer, Paver Operator, Dredging Equipment, or Dredge Engineer, or Dredge Operator, Central Mix Plant Engineer, CMI or similar type machine, Concrete Pump, Truck or Skid Mounted, Tower Crane, Engineer or Rock Crusher Plant, Concrete Plant Engineer, Ditching Machine with dual attachment, Tractor Mounted Loaders, Cherry Picker, Hydro Crane, Standard or Dinkey Locomotives, Scoopmobiles, Euclid Loader, Soil Cement Machine, Back Filler, Elevating Machine, Power Blade, Drilling Machine, including Well Testing, Caissons, Shaft or any similar type drilling machines, Motor Driven Paint Machine, Pipe Cleaning Machine, Pipe Wrapping Machine, Pipe Bending Machine, Apsco Paver, Boring Machine, (Head Equipment Greaser), Barber-Greene Loaders, Formless Paver, (Well Point System), Concrete Spreader, Hydra Ax, Span Saw, Marine Scoops, Brush Mulcher, Brush Burner, Mesh Placer, Tree Mover, Helicopter Crew (3), Piledriver-Skid or Crawler, Stump Remover, Root Rake, Tug Boat

Operator, Refrigerating Machine, Freezing Operator, Chair Cart-Self-Propelled, Hydra Seeder, Straw Blower, Power Sub Grader, Bull Float, Finishing Machine, Self-Propelled Pavement Breaker, Lull (or similar type Machine), Two Air Compressors, Compressors hooked in Manifold, Overhead Crane, Chip Spreader, Mud Cat, Sull-Air, Fork Lifts (except when used for landscaping work), Soil Stabilizer (Seaman Tiller, Bo Mag, Rago Gator, and similar types of equipment), Tube Float, Spray Machine, Curing Machine, Concrete or Asphalt Milling Machine, Snooper Truck-Operator, Backhoe, Farm Tractors (with attachments), 4 Point Lift System (Power Lift or similar type), Skid-Steer (Bob Cat or similar type), Wrecking Shears, Water Blaster.

Class 2. Concrete Mixers without Skips, Rock Crusher, Ditching Machine under 6', Curbing Machine, One Drum Machines without Tower or Boom, Air Tugger, Self-Propelled Concrete Saw, Machine Mounted Post Hole Digger, two to four Generators, Water Pumps or Welding Machines, within 400 feet, Air Compressor 600 cu. ft. and under, Rollers on Aggregate and Seal Coat Surfaces, Fork Lift (when used for landscaping work), Concrete and Blacktop Curb Machine, One Water Pump, Oilers, Air Valves or Steam Valves, One Welding Machine, Truck Jack, Mud Jack, Gunnite Machine, House Elevators when used for hoisting material, Engine Tenders, Fireman, Wagon Drill, Flex Plane, Conveyor, Siphons and Pulsometer, Switchman, Fireman on Paint Pots, Fireman on Asphalt Plants, Distributor Operator on Trucks, Tampers, Self-Propelled Power Broom, Striping Machine (motor driven), Form Tamper, Bulk Cement Plant, Equipment Greaser, Deck Hands, Truck Crane Oiler-Driver, Cement Blimps, Form Grader, Temporary Heat, Throttle Valve, Super Sucker (and similar type of equipment).

Other Classifications of Work:

For definitions of classifications not otherwise set out, the Department generally has on file such definitions which are available. If a task to be performed is not subject to one of the classifications of pay set out, the Department will upon being contacted state which neighboring county has such a classification and provide such rate, such rate being deemed to exist by reference in this document. If no neighboring county rate applies to the task, the Department shall undertake a special determination, such special determination being then deemed to have existed under this determination. If a project requires these, or any classification not listed, please contact IDOL at 217-782-1710 for wage rates or clarifications.

LANDSCAPING

Landscaping work falls under the existing classifications for laborer, operating engineer and truck driver. The work performed by landscape plantsman and landscape laborer is covered by the existing classification of laborer. The work performed by landscape operators (regardless of equipment used or its size) is covered by the classifications of operating engineer. The work performed by landscape truck drivers (regardless of size of truck driven) is covered by the classifications of truck driver.

Wabash County Prevailing Wage for May 2013

(See explanation of column headings at bottom of wages)

Trade Name	RG	TYP	C	Base	FRMAN	M-F>8	OSA	OSH	H/W	Pensn	Vac	Trng
ASBESTOS ABT-GEN	ALL			25.300	25.750	1.5	1.5	2.0	5.750	10.35	0.000	0.900
ASBESTOS ABT-MEC	BLD			21.150	22.150	1.5	1.5	2.0	6.400	5.150	0.000	0.650
BOILERMAKER	BLD			31.500	34.000	1.5	1.5	2.0	7.070	18.73	1.000	0.350

BRICK MASON	BLD	28.620	30.120	1.5	1.5	2.0	8.200	7.030	0.000	0.430
CARPENTER	BLD	31.890	33.390	1.5	1.5	2.0	6.550	6.750	0.000	0.400
CARPENTER	HWY	31.890	33.640	1.5	1.5	2.0	6.550	6.750	0.000	0.400
CEMENT MASON	BLD	29.800	31.300	1.5	1.5	2.0	6.600	8.360	0.000	0.500
CEMENT MASON	HWY	27.080	28.580	1.5	1.5	2.0	6.600	5.800	0.000	0.300
CERAMIC TILE FNSHER	BLD	27.120	0.000	1.5	1.5	2.0	8.200	7.030	0.000	0.430
COMMUNICATION TECH	BLD	18.350	19.650	1.5	1.5	2.0	0.000	0.550	0.000	0.000
ELECTRIC PWR EQMT OP	ALL 1	35.570	0.000	1.5	1.5	2.0	5.000	9.960	0.000	0.360
ELECTRIC PWR EQMT OP	ALL 2	31.740	0.000	1.5	1.5	2.0	5.000	8.880	0.000	0.320
ELECTRIC PWR GRNDMAN	ALL	26.100	0.000	1.5	1.5	2.0	5.000	7.310	0.000	0.260
ELECTRIC PWR LINEMAN	ALL	44.630	47.650	1.5	1.5	2.0	5.000	12.50	0.000	0.450
ELECTRICIAN	BLD	34.130	36.130	1.5	1.5	2.0	5.250	7.910	0.000	0.550
FLOOR LAYER	BLD	29.330	30.080	1.5	1.5	2.0	6.550	6.750	0.000	0.400
GLAZIER	BLD	26.780	28.030	1.5	1.5	2.0	6.120	5.200	0.000	0.300
HT/FROST INSULATOR	BLD	29.450	30.450	1.5	1.5	2.0	5.050	9.730	0.000	0.280
IRON WORKER	ALL	27.020	28.270	1.5	1.5	2.0	7.010	9.200	0.000	0.345
LABORER	BLD	25.300	25.750	1.5	1.5	2.0	5.750	10.35	0.000	0.800
LABORER	HWY	25.300	25.750	1.5	1.5	2.0	5.750	10.35	0.000	0.800
MACHINIST	BLD	43.550	46.050	1.5	1.5	2.0	6.130	8.950	1.850	0.000
MARBLE FINISHERS	BLD	27.120	0.000	1.5	1.5	2.0	8.200	7.030	0.000	0.430
MARBLE MASON	BLD	28.620	30.120	1.5	1.5	2.0	8.200	7.030	0.000	0.430
MILLWRIGHT	BLD	31.890	33.390	1.5	1.5	2.0	6.550	6.750	0.000	0.400
MILLWRIGHT	HWY	32.390	34.140	1.5	1.5	2.0	6.550	6.750	0.000	0.400
OPERATING ENGINEER	ALL 1	36.950	0.000	1.5	1.5	2.0	7.250	8.700	0.000	0.800
OPERATING ENGINEER	ALL 2	23.900	0.000	1.5	1.5	2.0	7.250	8.700	0.000	0.800
OPERATING ENGINEER	O&C	14.570	0.000	1.5	1.5	2.0	4.200	2.200	0.000	0.000
PAINTER	BLD	24.450	25.450	1.5	1.5	2.0	6.250	5.550	0.000	0.300
PAINTER	HWY	25.600	26.600	1.5	1.5	2.0	6.250	5.550	0.000	0.300
PAINTER OVER 30FT	BLD	25.200	26.200	1.5	1.5	2.0	6.250	5.550	0.000	0.300
PAINTER PWR EQMT	BLD	25.450	26.450	1.5	1.5	2.0	6.250	5.550	0.000	0.300
PAINTER PWR EQMT	HWY	26.600	27.600	1.5	1.5	2.0	6.250	5.550	0.000	0.300
PILEDRIVER	BLD	31.890	33.390	1.5	1.5	2.0	6.550	6.750	0.000	0.400
PILEDRIVER	HWY	32.390	34.140	1.5	1.5	2.0	6.550	6.750	0.000	0.400
PIPEFITTER	BLD	33.640	35.660	1.5	1.5	2.0	6.100	8.310	0.000	0.800
PLASTERER	BLD	30.000	32.000	1.5	1.5	2.0	6.600	10.17	0.000	0.500
PLUMBER	BLD	33.640	35.660	1.5	1.5	2.0	6.100	8.310	0.000	0.800
ROOFER	BLD	27.240	29.240	1.5	1.5	2.0	7.200	5.250	0.000	0.540
SHEETMETAL WORKER	ALL	31.690	33.190	1.5	1.5	2.0	7.130	6.730	1.910	0.360
SPRINKLER FITTER	BLD	36.390	39.140	1.5	1.5	2.0	8.420	8.500	0.000	0.450
STONE MASON	BLD	28.620	30.120	1.5	1.5	2.0	8.200	7.030	0.000	0.430
TERRAZZO FINISHER	BLD	27.120	0.000	1.5	1.5	2.0	8.200	7.030	0.000	0.430
TERRAZZO MASON	BLD	28.620	30.120	1.5	1.5	2.0	8.200	7.030	0.000	0.430
TILE MASON	BLD	28.620	30.120	1.5	1.5	2.0	8.200	7.030	0.000	0.430
TRUCK DRIVER	ALL 1	28.955	0.000	1.5	1.5	2.0	9.300	2.900	0.000	0.250
TRUCK DRIVER	ALL 2	29.355	0.000	1.5	1.5	2.0	9.300	2.900	0.000	0.250
TRUCK DRIVER	ALL 3	29.555	0.000	1.5	1.5	2.0	9.300	2.900	0.000	0.250
TRUCK DRIVER	ALL 4	29.805	0.000	1.5	1.5	2.0	9.300	2.900	0.000	0.250
TRUCK DRIVER	ALL 5	30.555	0.000	1.5	1.5	2.0	9.300	2.900	0.000	0.250
TRUCK DRIVER	O&C	13.940	0.000	1.5	1.5	2.0	2.550	1.500	0.000	0.000
TUCKPOINTER	BLD	28.620	30.120	1.5	1.5	2.0	8.200	7.030	0.000	0.430

Legend :

RG (Region)

TYP (Trade Type - All,Highway,Building,Floating,Oil & Chip,Rivers)

C (Class)

Base (Base Wage Rate)

FRMAN (Foreman Rate)

M-F>8 (OT required for any hour greater than 8 worked each day, Mon through Fri.)

OSA (Overtime (OT) is required for every hour worked on Saturday)

OSH (Overtime is required for every hour worked on Sunday and Holidays)

H/W (Health & Welfare Insurance)

Pensn (Pension)

Vac (Vacation)

Trng (Training)

Explanations

WABASH COUNTY

The following list is considered as those days for which holiday rates of wages for work performed apply: New Years Day, Memorial Day, Fourth of July, Labor Day, Thanksgiving Day, Christmas Day and Veterans Day in some classifications/counties. Generally, any of these holidays which fall on a Sunday is celebrated on the following Monday. This then makes work performed on that Monday payable at the appropriate overtime rate for holiday pay. Common practice in a given local may alter certain days of celebration. If in doubt, please check with IDOL.

EXPLANATION OF CLASSES

ASBESTOS - GENERAL - removal of asbestos material/mold and hazardous materials from any place in a building, including mechanical systems where those mechanical systems are to be removed. This includes the removal of asbestos materials/mold and hazardous materials from ductwork or pipes in a building when the building is to be demolished at the time or at some close future date.

ASBESTOS - MECHANICAL - removal of asbestos material from mechanical systems, such as pipes, ducts, and boilers, where the mechanical systems are to remain.

CERAMIC TILE FINISHER, MARBLE FINISHER, TERRAZZO FINISHER

Assisting, helping or supporting the tile, marble and terrazzo mechanic by performing their historic and traditional work assignments required to complete the proper installation of the work covered by said crafts. The term "Ceramic" is used for naming the classification only, and is in no a limitation of the product handled. Ceramic takes into consideration most hard tiles.

COMMUNICATIONS TECHNICIAN

Installation, operation, inspection, modification, maintenance and repair of systems used for the transmission and reception of signals of any nature, for any purpose, including but not limited to, sound and voice transmission/transference systems, communication systems that transmit or receive information and/or control systems, television and video systems, micro-processor controlled fire alarm systems, and security systems, and the performance of any task directly related to such installation or service. EXCLUDES installation of electrical power wiring and conduit raceways exceeding fifteen (15) feet in length.

ELECTRIC POWER LINEMAN

Construction, maintenance and dismantling of overhead and underground electric power lines, including high voltage pipe type cable work, and associated structures and equipment.

ELECTRIC POWER EQUIPMENT OPERATOR - CLASS 1

Operation of all crawler type equipment D-4 and larger from the ground to assist the Electric Power Linemen in performing their duties.

ELECTRIC POWER EQUIPMENT OPERATORS - CLASS 2

Operation of all other equipment from the ground to assist the Electric Power Linemen in performing their duties.

ELECTRIC POWER GROUNDMAN

Applies to workers who assist the Electric Power Lineman from the ground.

TRUCK DRIVER - BUILDING, HEAVY AND HIGHWAY CONSTRUCTION

Class 1. Drivers on 2 axle trucks hauling less than 9 ton. Air compressor and welding machines and brooms, including those pulled by separate units, truck driver helpers, warehouse employees, mechanic helpers, greasers and tiremen, pickup trucks when hauling materials, tools, or workers to and from and on-the-job site, and fork lifts up to 6,000 lb. capacity.

Class 2. Two or three axle trucks hauling more than 9 ton but hauling less than 16 ton. A-frame winch trucks, hydrolift trucks, vector trucks or similar equipment when used for transportation purposes. Fork lifts over 6,000 lb. capacity, winch trucks, four axle combination units, and ticket writers.

Class 3. Two, three or four axle trucks hauling 16 ton or more. Drivers on water pulls, articulated dump trucks, mechanics and working forepersons, and dispatchers. Five axle or more combination units.

Class 4. Low Boy and Oil Distributors.

Class 5. Drivers who require special protective clothing while employed on hazardous waste work.

TRUCK DRIVER - OIL AND CHIP

Encompasses following types of work when participating on public works projects involving oil and chip activities: Ready Mix, Gravel Truck Drivers, Asphalt Distributor Truck and Lowboy Drivers.

OPERATING ENGINEERS - BUILDING, HEAVY AND HIGHWAY CONSTRUCTION

Class 1. Power Cranes, Draglines, Derricks, Shovels, Gradalls, Mechanics, Tractor Highlift, Tournadozer, Concrete Mixers with Skip, Tournamixer, Two Drum Machine, One Drum Hoist with Tower or Boom, Cableways, Tower Machines, Motor Patrol, Boom Tractor, Boom or Winch Truck, Winch or Hydraulic Boom Truck, Truck Crane, Tournapull, Tractor Operating Scoops, Bulldozer, Push Tractor, Asphalt Planer, Finishing Machine on Asphalt, Large Rollers on Earth, Rollers on Asphalt Mix, Ross Carrier or similar Machine, Gravel Processing Machine, Asphalt Plant Engineer, Paver Operator, Dredging Equipment, or Dredge Engineer, or Dredge Operator, Central Mix Plant Engineer, CMI or similar type machine, Concrete Pump, Truck or Skid Mounted, Tower Crane, Engineer or Rock Crusher Plant, Concrete Plant Engineer, Ditching Machine with dual attachment, Tractor Mounted Loaders,

Cherry Picker, Hydro Crane, Standard or Dinkey Locomotives, Scoopmobiles, Euclid Loader, Soil Cement Machine, Back Filler, Elevating Machine, Power Blade, Drilling Machine, including Well Testing, Caissons, Shaft or any similar type drilling machines, Motor Driven Paint Machine, Pipe Cleaning Machine, Pipe Wrapping Machine, Pipe Bending Machine, Apsco Paver, Boring Machine, (Head Equipment Greaser), Barber-Greene Loaders, Formless Paver, (Well Point System), Concrete Spreader, Hydra Ax, Span Saw, Marine Scoops, Brush Mulcher, Brush Burner, Mesh Placer, Tree Mover, Helicopter Crew (3), Piledriver-Skid or Crawler, Stump Remover, Root Rake, Tug Boat Operator, Refrigerating Machine, Freezing Operator, Chair Cart-Self-Propelled, Hydra Seeder, Straw Blower, Power Sub Grader, Bull Float, Finishing Machine, Self-Propelled Pavement Breaker, Lull (or similar type Machine), Two Air Compressors, Compressors hooked in Manifold, Overhead Crane, Chip Spreader, Mud Cat, Sull-Air, Fork Lifts (except when used for landscaping work), Soil Stabilizer (Seaman Tiller, Bo Mag, Rago Gator, and similar types of equipment), Tube Float, Spray Machine, Curing Machine, Concrete or Asphalt Milling Machine, Snooper Truck-Operator, Backhoe, Farm Tractors (with attachments), 4 Point Lift System (Power Lift or similar type), Skid-Steer (Bob Cat or similar type), Wrecking Shears, Water Blaster.

Class 2. Concrete Mixers without Skips, Rock Crusher, Ditching Machine under 6', Curbing Machine, One Drum Machines without Tower or Boom, Air Tugger, Self-Propelled Concrete Saw, Machine Mounted Post Hole Digger, two to four Generators, Water Pumps or Welding Machines, within 400 feet, Air Compressor 600 cu. ft. and under, Rollers on Aggregate and Seal Coat Surfaces, Fork Lift (when used for landscaping work), Concrete and Blacktop Curb Machine, One Water Pump, Oilers, Air Valves or Steam Valves, One Welding Machine, Truck Jack, Mud Jack, Gunnite Machine, House Elevators when used for hoisting material, Engine Tenders, Fireman, Wagon Drill, Flex Plane, Conveyor, Siphons and Pulsometer, Switchman, Fireman on Paint Pots, Fireman on Asphalt Plants, Distributor Operator on Trucks, Tampers, Self-Propelled Power Broom, Striping Machine (motor driven), Form Tamper, Bulk Cement Plant, Equipment Greaser, Deck Hands, Truck Crane Oiler-Driver, Cement Blimps, Form Grader, Temporary Heat, Throttle Valve, Super Sucker (and similar type of equipment).

OPERATING ENGINEER - OIL AND CHIP

Encompasses following types of work when participating on public works projects involving oil and chip activities: Spreading and compaction of seal coat aggregate on liquid asphalt or road oil and the preparation for such work for maintenance purposes.

Other Classifications of Work:

For definitions of classifications not otherwise set out, the Department generally has on file such definitions which are available. If a task to be performed is not subject to one of the classifications of pay set out, the Department will upon being contacted state which neighboring county has such a classification and provide such rate, such rate being deemed to exist by reference in this document. If no neighboring county rate applies to the task, the Department shall undertake a special determination, such special determination being then deemed to have existed under this determination. If a project requires these, or any classification not listed, please contact IDOL at 217-782-1710 for wage rates or clarifications.

LANDSCAPING

Landscaping work falls under the existing classifications for laborer, operating engineer and truck driver. The work performed by landscape

plantsman and landscape laborer is covered by the existing classification of laborer. The work performed by landscape operators (regardless of equipment used or its size) is covered by the classifications of operating engineer. The work performed by landscape truck drivers (regardless of size of truck driven) is covered by the classifications of truck driver.

Warren County Prevailing Wage for May 2013

(See explanation of column headings at bottom of wages)

Trade Name	RG	TYP	C	Base	FRMAN	M-F>8	OSA	OSH	H/W	Pensn	Vac	Trng
=====	==	===	=	=====	=====	=====	===	===	=====	=====	=====	=====
ASBESTOS ABT-GEN		BLD		27.490	28.490	1.5	1.5	2.0	8.240	10.07	0.000	0.800
ASBESTOS ABT-GEN		HWY		26.060	26.560	1.5	1.5	2.0	8.240	9.550	0.000	0.800
ASBESTOS ABT-MEC		BLD		20.500	21.500	1.5	1.5	2.0	6.250	3.500	0.000	0.000
BOILERMAKER		BLD		35.010	38.010	2.0	2.0	2.0	7.070	13.83	0.000	0.300
BRICK MASON		BLD		32.060	33.560	1.5	1.5	2.0	7.700	9.130	0.000	0.560
CARPENTER		BLD		29.400	31.650	1.5	1.5	2.0	7.450	13.63	0.000	0.520
CARPENTER		HWY		31.150	33.400	1.5	1.5	2.0	7.450	13.61	0.000	0.520
CEMENT MASON		ALL		25.030	26.530	1.5	1.5	2.0	5.750	11.50	0.000	0.500
CERAMIC TILE FNSHER		BLD		29.750	0.000	1.5	1.5	2.0	7.700	9.130	0.000	0.550
ELECTRIC PWR EQMT OP		ALL		35.440	0.000	1.5	1.5	2.0	5.000	10.98	0.000	0.270
ELECTRIC PWR GRNDMAN		ALL		24.320	0.000	1.5	1.5	2.0	5.000	7.540	0.000	0.180
ELECTRIC PWR LINEMAN		ALL		39.370	41.910	1.5	1.5	2.0	5.000	12.20	0.000	0.300
ELECTRIC PWR TRK DRV		ALL		25.510	0.000	1.5	1.5	2.0	5.000	7.920	0.000	0.190
ELECTRICIAN		BLD		30.190	32.690	1.5	1.5	2.0	5.350	9.390	0.000	0.400
ELECTRONIC SYS TECH		BLD		27.430	29.180	1.5	1.5	2.0	5.350	9.320	0.000	0.400
ELEVATOR CONSTRUCTOR		BLD		40.520	45.585	2.0	2.0	2.0	11.88	12.71	3.240	0.600
GLAZIER		BLD		22.020	23.520	1.5	1.5	2.0	6.940	6.520	0.000	0.350
HT/FROST INSULATOR		BLD		29.190	30.390	1.5	1.5	2.0	5.420	12.05	0.000	0.900
IRON WORKER		ALL		24.440	25.690	1.5	1.5	2.0	7.010	9.890	0.000	0.570
LABORER		BLD		26.490	27.490	1.5	1.5	2.0	8.240	10.07	0.000	0.800
LABORER		HWY		25.060	25.560	1.5	1.5	2.0	8.240	9.550	0.000	0.800
LABORER, SKILLED		BLD		26.490	27.490	1.5	1.5	2.0	8.240	10.07	0.000	0.800
LABORER, SKILLED		HWY		25.360	25.860	1.5	1.5	2.0	8.240	9.550	0.000	0.800
LATHER		BLD		29.400	31.650	1.5	1.5	2.0	7.450	13.63	0.000	0.520
MACHINIST		BLD		43.550	46.050	1.5	1.5	2.0	6.130	8.950	1.850	0.000
MARBLE FINISHERS		BLD		29.750	0.000	1.5	1.5	2.0	7.700	9.130	0.000	0.550
MARBLE MASON		BLD		31.510	32.760	1.5	1.5	2.0	7.700	9.130	0.000	0.550
MILLWRIGHT		BLD		30.240	32.490	1.5	1.5	2.0	7.450	13.09	0.000	0.520
MILLWRIGHT		HWY		31.820	34.070	1.5	1.5	2.0	7.450	13.44	0.000	0.520
OPERATING ENGINEER		BLD	1	36.000	39.000	1.5	1.5	2.0	9.750	13.60	0.000	3.000
OPERATING ENGINEER		BLD	2	33.490	39.000	1.5	1.5	2.0	9.750	13.60	0.000	3.000
OPERATING ENGINEER		BLD	3	29.340	39.000	1.5	1.5	2.0	9.750	13.60	0.000	3.000
OPERATING ENGINEER		HWY	1	36.000	39.500	1.5	1.5	2.0	9.750	13.60	0.000	3.000
OPERATING ENGINEER		HWY	2	33.490	39.500	1.5	1.5	2.0	9.750	13.60	0.000	3.000
OPERATING ENGINEER		HWY	3	29.340	39.500	1.5	1.5	2.0	9.750	13.60	0.000	3.000
PAINTER		ALL		27.320	28.320	1.5	1.5	1.5	5.000	6.100	0.000	0.600
PAINTER OVER 30FT		ALL		28.570	29.570	1.5	1.5	1.5	5.000	6.100	0.000	0.600
PAINTER PWR EQMT		ALL		27.820	28.820	1.5	1.5	1.5	5.000	6.100	0.000	0.600
PILEDRIVER		BLD		29.900	32.150	1.5	1.5	2.0	7.450	13.63	0.000	0.520
PILEDRIVER		HWY		32.150	34.400	1.5	1.5	2.0	7.450	13.61	0.000	0.520
PIPEFITTER		ALL		36.550	40.210	1.5	1.5	2.0	5.650	12.15	0.000	1.000
PLASTERER		BLD		27.770	28.770	1.5	1.5	2.0	8.140	12.76	0.000	0.600
PLUMBER		ALL		36.550	40.210	1.5	1.5	2.0	5.650	12.15	0.000	1.000
ROOFER		BLD		25.130	26.380	1.5	1.5	2.0	8.610	5.620	0.000	0.260
SHEETMETAL WORKER		BLD		30.070	32.070	1.5	1.5	2.0	7.140	10.54	0.000	0.540
SPRINKLER FITTER		BLD		36.390	39.140	1.5	1.5	2.0	8.420	8.500	0.000	0.450
STONE MASON		BLD		32.060	33.560	1.5	1.5	2.0	7.700	9.130	0.000	0.560
TERRAZZO FINISHER		BLD		29.750	0.000	1.5	1.5	2.0	7.700	9.130	0.000	0.550
TERRAZZO MASON		BLD		31.510	32.760	1.5	1.5	2.0	7.700	9.130	0.000	0.550
TILE MASON		BLD		31.510	32.760	1.5	1.5	2.0	7.700	9.130	0.000	0.550
TRUCK DRIVER		ALL	1	31.230	0.000	1.5	1.5	2.0	10.30	4.840	0.000	0.250

TRUCK DRIVER	ALL	2	31.680	0.000	1.5	1.5	2.0	10.30	4.840	0.000	0.250
TRUCK DRIVER	ALL	3	31.890	0.000	1.5	1.5	2.0	10.30	4.840	0.000	0.250
TRUCK DRIVER	ALL	4	32.180	0.000	1.5	1.5	2.0	10.30	4.840	0.000	0.250
TRUCK DRIVER	ALL	5	33.020	0.000	1.5	1.5	2.0	10.30	4.840	0.000	0.250
TRUCK DRIVER	O&C	1	24.980	0.000	1.5	1.5	2.0	10.30	4.840	0.000	0.250
TRUCK DRIVER	O&C	2	25.340	0.000	1.5	1.5	2.0	10.30	4.840	0.000	0.250
TRUCK DRIVER	O&C	3	25.510	0.000	1.5	1.5	2.0	10.30	4.840	0.000	0.250
TRUCK DRIVER	O&C	4	25.740	0.000	1.5	1.5	2.0	10.30	4.840	0.000	0.250
TRUCK DRIVER	O&C	5	26.420	0.000	1.5	1.5	2.0	10.30	4.840	0.000	0.250
TUCKPOINTER	BLD		32.060	33.560	1.5	1.5	2.0	7.700	9.130	0.000	0.560

Legend:

RG (Region)

TYP (Trade Type - All,Highway,Building,Floating,Oil & Chip,Rivers)

C (Class)

Base (Base Wage Rate)

FRMAN (Foreman Rate)

M-F>8 (OT required for any hour greater than 8 worked each day, Mon through Fri.)

OSA (Overtime (OT) is required for every hour worked on Saturday)

OSH (Overtime is required for every hour worked on Sunday and Holidays)

H/W (Health & Welfare Insurance)

Pensn (Pension)

Vac (Vacation)

Trng (Training)

Explanations

WARREN COUNTY

The following list is considered as those days for which holiday rates of wages for work performed apply: New Years Day, Memorial Day, Fourth of July, Labor Day, Thanksgiving Day, Christmas Day and Veterans Day in some classifications/counties. Generally, any of these holidays which fall on a Sunday is celebrated on the following Monday. This then makes work performed on that Monday payable at the appropriate overtime rate for holiday pay. Common practice in a given local may alter certain days of celebration. If in doubt, please check with IDOL.

Oil and chip resealing (O&C) means the application of road oils and liquid asphalt to coat an existing road surface, followed by application of aggregate chips or gravel to coated surface, and subsequent rolling of material to seal the surface.

EXPLANATION OF CLASSES

ASBESTOS - GENERAL - removal of asbestos material/mold and hazardous materials from any place in a building, including mechanical systems where those mechanical systems are to be removed. This includes the

removal of asbestos materials/mold and hazardous materials from ductwork or pipes in a building when the building is to be demolished at the time or at some close future date.

ASBESTOS - MECHANICAL - removal of asbestos material from mechanical systems, such as pipes, ducts, and boilers, where the mechanical systems are to remain.

CERAMIC TILE FINISHER, MARBLE FINISHER, TERRAZZO FINISHER

Assisting, helping or supporting the tile, marble and terrazzo mechanic by performing their historic and traditional work assignments required to complete the proper installation of the work covered by said crafts. The term "Ceramic" is used for naming the classification only and is in no way a limitation of the product handled. Ceramic takes into consideration most hard tiles.

ELECTRONIC SYSTEMS TECHNICIAN

Installation, service and maintenance of low-voltage systems which utilizes the transmission and/or transference of voice, sound, vision, or digital for commercial, education, security and entertainment purposes for the following: TV monitoring and surveillance, background/foreground music, intercom and telephone interconnect, field programming, inventory control systems, microwave transmission, multi-media, multiplex, radio page, school, intercom and sound burglar alarms and low voltage master clock systems.

Excluded from this classification are energy management systems, life safety systems, supervisory controls and data acquisition systems not intrinsic with the above listed systems, fire alarm systems, nurse call systems and raceways exceeding fifteen feet in length.

LABORER, SKILLED - BUILDING

The skilled laborer building (BLD) classification shall encompass the following types of work, irrespective of the site of the work: tending of carpenters in unloading, handling, stockpiling and distribution operations, also other building crafts, mixing, handling, and conveying of all materials used by masons, plasterers and other building construction crafts, whether done by hand or by any process. The drying of plastering when done by salamander heat, and the cleaning and clearing of all debris. All work pertaining to and in preparation of asbestos abatement and removal. The building of scaffolding and staging for masons and plasterers. The excavations for buildings and all other construction, digging, of trenches, piers, foundations and holes, digging, lagging, sheeting, cribbing, bracing and propping of foundations, holes, caissons, cofferdams, and dikes, the setting of all guidelines for machine or hand excavation and subgrading. The mixing, handling, conveying, pouring, vibrating, gunniting and otherwise applying of concrete, whether by hand or other method of concrete for any walls, foundations, floors, or for other construction concrete sealant men. The wrecking, stripping, dismantling, and handling of concrete forms and false work, and the building of centers for fireproofing purposes. Boring machine, gas, electric or air in preparation for shoving pipe, telephone cable, and so forth, under highways, roads, streets and alleys. All hand and power operating cross cut saws when used for clearing. All work in compressed air construction. All work on acetylene burners in salvaging. The blocking and tamping of concrete. The laying of sewer tile and conduit, and pre-cast materials. The assembling and dismantling of all jacks and sectional scaffolding, including elevator construction and running of slip form jacks. The work of drill running and blasting, including wagon drills. The wrecking, stripping, dismantling, cleaning, moving and oiling of forms. The

cutting off of concrete piles. The loading, unloading, handling and carrying to place of installation of all rods, (and materials for use in reinforcing) concrete and the hoisting of same and all signaling where hoist is used in this type of construction coming under the jurisdiction of the Laborers' Union. And, all other labor work not awarded to any other craft. Mortar mixers, kettlemen and carrier of hot stuff, tool crib men, watchmen (Laborer), firemen or salamander tenders, flagmen, deck hands, installation and maintenance of temporary gas-fired heating units, gravel box men, dumpmen and spotters, fencing Laborers, cleaning lumber, pit men, material checkers, dispatchers, unloading explosives, asphalt plant laborers, writer of scale tickets, fireproofing laborers, janitors, asbestos abatement and removal laborers, handling of materials treated with oil, creosote, chloride, asphalt, and/or foreign material harmful to skin or clothing, Laborers with de-watering systems, gunnite nozzle men, laborers tending masons with hot material or where foreign materials are used, Laborers handling masterplate or similar materials, laser beam operator, concrete burning machine operator, material selector men working with firebrick or combustible material, dynamite men, track laborers, cement handlers, chloride handlers, the unloading and laborers with steel workers and re-bars, concrete workers (wet), luteman, asphalt raker, curb asphalt machine operator, ready mix scalemen, permanent, portable or temporary plant drilling machine operator, plaster tenders, underpinning and shoring of buildings, fire watch, signaling of all power equipment, to include trucks excavating equipment, etc., tree topper or trimmer when in connection to construction, tunnel helpers in free air, batch dumpers, kettle and tar men, tank cleaners, plastic installers, scaffold workers, motorized buggies or motorized unit used for wet concrete or handling of building materials, sewer workers, rod and chain men, vibrator operators, mortar mixer operator, cement silica, clay, fly ash, lime and plasters, handlers (bulk or bag), cofferdam workers, on concrete paving, placing, cutting and tying of reinforcing, deck hand, dredge hand and shore laborers, bankmen on floating plant, asphalt workers with machine & layers, grade checker, power tools, caisson workers, lead man on sewer work, welders, cutters, burners and torch men, chain saw operators, paving breaker, jackhammer and drill operator, layout man and/or drainage tile layer, steel form setters -- street and highway, air tamping hammerman, signal man on crane, concrete saw operator, screen man on asphalt pavers, front end man on chip spreader, multiple concrete duct -- lead man.

LABORER, SKILLED - HIGHWAY

The skilled laborer heavy and highway (HWY) classification shall encompass the following types of work, irrespective of the site of the work: handling of materials treated with oil, creosote, asphalt and/or any foreign materials harmful to skin or clothing, track laborers, chloride handlers, the unloading and loading with steel workers and re-bars, concrete workers (wet), tunnel helpers in free air, batch dumpers, mason tenders, kettle and tar men, plastic installers, scaffold workers, motorized buggies or motorized unit used for wet concrete or handling of building materials, laborers with de-watering systems, sewer workers plus depth, rod and chainmen, vibrator operators, mortar mixer operators, cement silica, clay, fly ash, lime and plasters, handlers (bulk or bag), cofferdam workers plus depth, on concrete paving, placing, cutting and tying or reinforcing, deck hand, dredge hand shore laborers, bankmen on floating plant, asphalt workers with machine, and layers, grade checker, power tools, stripping of all concrete forms excluding paving forms, dumpmen and spotters, when necessary, caisson workers plus depth, gunnite nozzle men, welders, cutters, burners and torchmen, chain saw operators, paving breaker, jackhammer and drill operators, layout man and/or drainage tile layer, steel form setters - street and highway, air tamping hammerman, signal man on crane, concrete saw operator,

screedman on asphalt pavers, front end man on chip spreader, multiple concrete duct, luteman, asphalt raker, curb asphalt machine operator, ready mix scalemen (portable or temporary plant), laser beam operator, concrete burning machine operator, and coring machine operator.

TRUCK DRIVER - BUILDING, HEAVY AND HIGHWAY CONSTRUCTION

Class 1. Drivers on 2 axle trucks hauling less than 9 ton. Air compressor and welding machines and brooms, including those pulled by separate units, truck driver helpers, warehouse employees, mechanic helpers, greasers and tiremen, pickup trucks when hauling materials, tools, or workers to and from and on-the-job site, and fork lifts up to 6,000 lb. capacity.

Class 2. Two or three axle trucks hauling more than 9 ton but hauling less than 16 ton. A-frame winch trucks, hydrolift trucks, vactor trucks or similar equipment when used for transportation purposes. Fork lifts over 6,000 lb. capacity, winch trucks, four axle combination units, and ticket writers.

Class 3. Two, three or four axle trucks hauling 16 ton or more. Drivers on water pulls, articulated dump trucks, mechanics and working forepersons, and dispatchers. Five axle or more combination units.

Class 4. Low Boy and Oil Distributors.

Class 5. Drivers who require special protective clothing while employed on hazardous waste work.

TRUCK DRIVER - OIL AND CHIP RESEALING ONLY.

This shall encompass laborers, workers and mechanics who drive contractor or subcontractor owned, leased, or hired pickup, dump, service, or oil distributor trucks. The work includes transporting materials and equipment (including but not limited to, oils, aggregate supplies, parts, machinery and tools) to or from the job site; distributing oil or liquid asphalt and aggregate; stock piling material when in connection with the actual oil and chip contract. The Truck Driver (Oil & Chip Resealing) wage classification does not include supplier delivered materials.

OPERATING ENGINEERS - BUILDING

Class 1. Cranes; Overhead Cranes; Gradall; All Cherry Pickers; Mechanics; Central Concrete Mixing Plant Operator; Road Pavers (27E - Dual Drum - Tri Batchers); Blacktop Plant Operators and Plant Engineers; 3 Drum Hoist; Derricks; Hydro Cranes; Shovels; Skimmer Scoops; Koehring Scooper; Drag Lines; Backhoe; Derrick Boats; Pile Drivers and Skid Rigs; Clamshells; Locomotive Cranes; Dredge (all types) Motor Patrol; Power Blades - Dumore - Elevating and similar types; Tower Cranes (Crawler-Mobile) and Stationary; Crane-type Backfiller; Drott Yumbo and similar types considered as Cranes; Caisson Rigs; Dozer; Tournadozer; Work Boats; Ross Carrier; Helicopter; Tournapulls - all and similar types; Scoops (all sizes); Pushcats; Endloaders (all types); Asphalt Surfacing Machine; Slip Form Paver; Rock Crusher; Heavy Equipment Greaser; CMI, CMI Belt Placer, Auto Grade & 3 Track and similar types; Side Booms; Multiple Unit Earth Movers; Creter Crane; Trench Machine; Pump-crete-Belt Crete-Squeeze Cretes-Screw-type Pumps and Gypsum; Bulker & Pump - Operator will clean; Formless Finishing Machine; Flaherty Spreader or similar types; Screed Man on Laydown Machine; Wheel Tractors (industrial or Farm-type w/Dozer-Hoe-Endloader or other attachments); F.W.D. & Similar Types; Vermeer Concrete Saw.

Class 2. Dinkeys; Power Launches; PH One-pass Soil Cement Machine

(and similar types); Pugmill with Pump; Backfillers; Euclid Loader; Forklifts; Jeeps w/Ditching Machine or other attachments; Tuneluger; Automatic Cement and Gravel Batching Plants; Mobile Drills (Soil Testing) and similar types; Gurries and Similar Types; (1) and (2) Drum Hoists (Buck Hoist and Similar Types); Chicago Boom; Boring Machine & Pipe Jacking Machine; Hydro Boom; Dewatering System; Straw Blower; Hydro Seeder; Assistant Heavy Equipment Greaser on Spread; Tractors (Track type) without Power Unit pulling Rollers; Rollers on Asphalt -- Brick Macadem; Concrete Breakers; Concrete Spreaders; Mule Pulling Rollers; Center Stripper; Cement Finishing Machines & CMI Texture & Reel Curing Machines; Cement Finishing Machine; Barber Green or similar loaders; Vibro Tamper (All similar types) Self-propelled; Winch or Boom Truck; Mechanical Bull Floats; Mixers over 3 Bag to 27E; Tractor pulling Power Blade or Elevating Grader; Porter Rex Rail; Clary Screed; Truck Type Hoptoe Oilers; Fireman; Spray Machine on Paving; Curb Machines; Truck Crane Oilers; Oil Distributor; Truck-Mounted Saws.

Class 3. Air Compressor; Power Subgrader; Straight Tractor; Trac Air without attachments; Herman Nelson Heater, Dravo, Warner, Silent Glo, and similar types; Roller: Five (5) Ton and under on Earth or Gravel; Form Grader; Crawler Crane & Skid Rig Oilers; Freight Elevators - permanently installed; Pump; Light Plant; Generator; Conveyor (1) or (2) - Operator will clean; Welding Machine; Mixer (3) Bag and Under (Standard Capacity with skip); Bulk Cement Plant; Oiler on Central Concrete Mixing Plant.

OPERATING ENGINEERS - HEAVY AND HIGHWAY CONSTRUCTION

CLASS 1. Cranes; Hydro Cranes; Shovels; Crane Type Backfiller; Tower, Mobile, Crawler, & Stationary Cranes; Derricks; Hoists (3 Drum); Draglines; Drott Yumbo & Similar Types considered as Cranes; 360 Degree Swing Excavator (Shears, Grapples, Movacs, etc.); Back Hoe; Derrick Boats; Pile Driver and Skid Rigs; Clam Shell; Locomotive - Cranes; Road Pavers - Single Drum - Dual Drum - Tri Batcher; Motor Patrols & Power Blades - Dumore - Elevating & Similar Types; Mechanics; Central Concrete Mixing Plant Operator; Asphalt Batch Plant Operators and Plant Engineers; Gradall; Caisson Rigs; Skimmer Scoop - Koering Scooper; Dredges (all types); Hoptoe; All Cherry Pickers; Work Boat; Ross Carrier; Helicopter; Dozer; Tournadozer; Tournapulls - all and similar types; Operation of Concrete and all Recycle Machines; Multiple Unit Earth Movers; Scoops (all sizes); Pushcats; Endloaders (all types); Asphalt Surfacing Machine; Slip Form Paver; Rock Crusher; Operation of Material Crusher, Screening Plants, and Tunnel Boring Machine; Heavy Equipment Greaser (top greaser on spread); CMI, Auto Grade, CMI Belt Placer & 3 Track and Similar Types; Side Booms; Asphalt Heater & Planer Combination (used to plane streets); Wheel Tractors (with Dozer, Hoe or Endloader Attachments); CAT Earthwork Compactors and Similar Types; Blaw Knox Spreader and Similar Types; Trench Machines; Pump Crete - Belt Crete - Squeeze Crete - Screw Type Pumps and Gypsum (operator will clean); Creter Crane; Operation of Concrete Pump Truck; Formless Finishing Machines; Flaherty Spreader or Similar Types; Screed Man on Laydown Machine; Vermeer Concrete Saw; Operation of Laser Screed; Span Saw; Dredge Leverman; Dredge Engineer; Lull or Similar Type; Hydro-Boom Truck; Operation of Guard Rail Machine; and Starting Engineer on Pipeline or Construction (11 or more pieces) including: Air Compressor (Trailer Mounted), All Forced Air Heaters (regardless of Size), Water Pumps (Greater than 4-1/2" or Total Discharge Over 4-1/2"), Light Plants, Generators (Trailer Mounted - Excluding Decontamination Trailer), Welding Machines (Any Size or Mode of Power), Conveyor, Mixer (any size), Stud Welder, Power Pac, etc, and Ground Heater (Trailer Mounted).

CLASS 2. Bulker & Pump; Power Launches; Boring Machine & Pipe Jacking

Machine; Dinkeys; Operation of Carts, Powered Haul Unit for a Boring Machine; P & H One Pass Soil Cement Machines and Similar Types; Wheel Tractors (Industry or Farm Type - Other); Back Fillers; Euclid Loader; Fork Lifts; Jeep w/Ditching Machine or Other Attachments; Tunneluger; Automatic Cement & Gravel Batching Plants; Mobile Drills - Soil Testing and Similar Types; Pugmill with Pump; All (1) and (2) Drum Hoists; Dewatering System; Straw Blower; Hydro-Seeder; Bump Grinders (self-propelled); Assistant Heavy Equipment Greaser; Apsco Spreader; Tractors (Track-Type) without Power Units Pulling Rollers; Rollers on Asphalt - Brick or Macadam; Concrete Breakers; Concrete Spreaders; Cement Strippers; Cement Finishing Machines & CMI Texture & Reel Curing Machines; Vibro-Tampers (All Similar Types Self-Propelled); Mechanical Bull Floats; Self-Propelled Concrete Saws; Truck Mounted Power Saws; Operation of Curb Cutters; Mixers - Over Three (3) Bags; Winch and Boom Trucks; Tractor Pulling Power Blade or Elevating Grader; Porter Rex Rail; Clary Screed; Mule Pulling Rollers; Pugmill without Pump; Barber Greene or Similar Loaders; Track Type Tractor w/Power Unit attached (minimum); Fireman; Spray Machine on Paving; Curb Machines; Paved Ditch Machine; Power Broom; Self-Propelled Sweepers; Self-Propelled Conveyors; Power Subgrader; Oil Distributor; Straight Tractor; Truck Crane Oiler; Truck Type Oilers; Directional Boring Machine; Horizontal Directional Drill; Articulating End Dump Vehicles; Starting Engineer on Pipeline or Construction (6 -10 pieces) including: Air Compressor (Trailer Mounted), All Forced Air Heaters (regardless of Size), Water Pumps (Greater than 4-1/2" or Total Discharge Over 4-1/2"), Light Plants, Generators (Trailer Mounted - Excluding Decontamination Trailer), Welding Machines (Any Size or Mode of Power), Conveyor, Mixer (any size), Stud Welder, Power Pac, etc., and Ground Heater (Trailer Mounted).

CLASS 3. Straight Framed Truck Mounted Vac Unit (separately powered); Trac Air Machine (without attachments); Rollers - Five Ton and Under on Earth and Gravel; Form Graders; Bulk Cement Plant; Oilers; and Starting Engineer on Pipeline or Construction (3 - 5 pieces) including: Air Compressor (Trailer Mounted), All Forced Air Heaters (regardless of Size), Water Pumps (Greater than 4-1/2" or Total Discharge Over 4-1/2"), Light Plants, Generators (Trailer Mounted - Excluding Decontamination Trailer), Welding Machines (Any Size or Mode of Power), Conveyor, Mixer (any size), Stud Welder, Power Pac, etc., and Ground Heater (Trailer Mounted).

Other Classifications of Work:

For definitions of classifications not otherwise set out, the Department generally has on file such definitions which are available. If a task to be performed is not subject to one of the classifications of pay set out, the Department will upon being contacted state which neighboring county has such a classification and provide such rate, such rate being deemed to exist by reference in this document. If no neighboring county rate applies to the task, the Department shall undertake a special determination, such special determination being then deemed to have existed under this determination. If a project requires these, or any classification not listed, please contact IDOL at 217-782-1710 for wage rates or clarifications.

LANDSCAPING

Landscaping work falls under the existing classifications for laborer, operating engineer and truck driver. The work performed by landscape plantsman and landscape laborer is covered by the existing classification of laborer. The work performed by landscape operators (regardless of equipment used or its size) is covered by the classifications of operating engineer. The work performed by landscape truck drivers (regardless of size of truck driven) is

covered by the classifications of truck driver.

Washington County Prevailing Wage for May 2013

(See explanation of column headings at bottom of wages)

Trade Name	RG	TYP	C	Base	FRMAN	M-F>8	OSA	OSH	H/W	Pensn	Vac	Trng
ASBESTOS ABT-GEN		ALL		28.120	28.620	1.5	1.5	2.0	5.750	12.58	0.000	0.800
ASBESTOS ABT-MEC		BLD		29.860	30.860	1.5	1.5	2.0	6.950	3.000	0.000	0.000
BOILERMAKER		BLD		31.500	34.000	1.5	1.5	2.0	7.070	18.73	1.000	0.350
BRICK MASON		BLD		29.280	33.160	1.5	1.5	2.0	7.750	9.430	2.000	0.400
CARPENTER		ALL		34.630	36.130	1.5	1.5	2.0	6.550	6.750	0.000	0.400
CEMENT MASON		BLD		28.200	29.700	1.5	1.5	2.0	6.600	5.400	0.000	0.500
CEMENT MASON		HWY		34.100	35.100	1.5	1.5	2.0	6.600	10.55	0.000	0.700
CERAMIC TILE FNSHER		BLD		25.890	0.000	1.5	1.5	2.0	6.000	5.200	0.000	0.530
ELECTRIC PWR EQMT OP		ALL	1	35.570	0.000	1.5	1.5	2.0	5.000	9.960	0.000	0.360
ELECTRIC PWR EQMT OP		ALL	2	31.740	0.000	1.5	1.5	2.0	5.000	8.880	0.000	0.320
ELECTRIC PWR GRNDMAN		ALL		26.100	0.000	1.5	1.5	2.0	5.000	7.310	0.000	0.260
ELECTRIC PWR LINEMAN		ALL		44.630	47.650	1.5	1.5	2.0	5.000	12.50	0.000	0.450
ELECTRICIAN	NW	ALL		36.510	38.700	1.5	1.5	2.0	7.810	7.490	0.000	0.640
ELECTRICIAN	SE	ALL		39.350	41.600	1.5	1.5	2.0	6.140	9.440	0.000	0.790
ELECTRONIC SYS TECH		BLD		32.570	34.320	1.5	1.5	2.0	6.000	4.240	0.000	0.400
ELEVATOR CONSTRUCTOR		BLD		43.715	49.180	2.0	2.0	2.0	11.88	12.71	3.500	0.600
FLOOR LAYER		BLD		29.330	30.080	1.5	1.5	2.0	6.550	6.750	0.000	0.400
GLAZIER		BLD		32.780	0.000	2.0	2.0	2.0	9.020	10.80	2.630	0.310
HT/FROST INSULATOR		BLD		37.260	38.260	1.5	1.5	2.0	7.850	11.16	0.000	0.500
IRON WORKER		ALL		31.000	33.000	1.5	1.5	2.0	7.110	12.35	0.000	0.420
LABORER		ALL		27.620	28.120	1.5	1.5	2.0	5.750	12.58	0.000	0.800
MACHINIST		BLD		43.550	46.050	1.5	1.5	2.0	6.130	8.950	1.850	0.000
MARBLE FINISHERS		BLD		25.890	0.000	1.5	1.5	2.0	6.000	5.200	0.000	0.530
MARBLE MASON		BLD		29.280	33.160	1.5	1.5	2.0	7.750	9.430	2.000	0.400
MILLWRIGHT		ALL		34.630	36.130	1.5	1.5	2.0	6.550	6.750	0.000	0.400
OPERATING ENGINEER		BLD	1	34.200	37.200	1.5	1.5	2.0	9.000	17.00	0.000	1.000
OPERATING ENGINEER		BLD	2	33.070	37.200	1.5	1.5	2.0	9.000	17.00	0.000	1.000
OPERATING ENGINEER		BLD	3	28.590	37.200	1.5	1.5	2.0	9.000	17.00	0.000	1.000
OPERATING ENGINEER		BLD	4	28.650	37.200	1.5	1.5	2.0	9.000	17.00	0.000	1.000
OPERATING ENGINEER		BLD	5	28.320	37.200	1.5	1.5	2.0	9.000	17.00	0.000	1.000
OPERATING ENGINEER		BLD	6	35.750	37.200	1.5	1.5	2.0	9.000	17.00	0.000	1.000
OPERATING ENGINEER		BLD	7	36.050	37.200	1.5	1.5	2.0	9.000	17.00	0.000	1.000
OPERATING ENGINEER		BLD	8	36.330	37.200	1.5	1.5	2.0	9.000	17.00	0.000	1.000
OPERATING ENGINEER		BLD	9	35.650	37.200	1.5	1.5	2.0	9.000	17.00	0.000	1.000
OPERATING ENGINEER		HWY	1	32.700	35.700	1.5	1.5	2.0	9.000	17.00	0.000	1.000
OPERATING ENGINEER		HWY	2	31.570	35.700	1.5	1.5	2.0	9.000	17.00	0.000	1.000
OPERATING ENGINEER		HWY	3	27.090	35.700	1.5	1.5	2.0	9.000	17.00	0.000	1.000
OPERATING ENGINEER		HWY	4	27.150	35.700	1.5	1.5	2.0	9.000	17.00	0.000	1.000
OPERATING ENGINEER		HWY	5	26.820	35.700	1.5	1.5	2.0	9.000	17.00	0.000	1.000
OPERATING ENGINEER		HWY	6	34.250	35.700	1.5	1.5	2.0	9.000	17.00	0.000	1.000
OPERATING ENGINEER		HWY	7	34.550	35.700	1.5	1.5	2.0	9.000	17.00	0.000	1.000
OPERATING ENGINEER		HWY	8	34.830	35.700	1.5	1.5	2.0	9.000	17.00	0.000	1.000
OPERATING ENGINEER		HWY	9	34.150	35.700	1.5	1.5	2.0	9.000	17.00	0.000	1.000
PAINTER		BLD		29.250	30.750	1.5	1.5	2.0	5.000	7.920	0.000	0.600
PAINTER		HWY		30.450	31.950	1.5	1.5	2.0	5.000	7.920	0.000	0.600
PAINTER OVER 30FT		BLD		30.250	31.750	1.5	1.5	2.0	5.000	7.920	0.000	0.600
PAINTER PWR EQMT		BLD		30.250	31.750	1.5	1.5	2.0	5.000	7.920	0.000	0.600
PAINTER PWR EQMT		HWY		31.450	32.950	1.5	1.5	2.0	5.000	7.920	0.000	0.600
PILEDRIVER		ALL		34.630	36.130	1.5	1.5	2.0	6.550	6.750	0.000	0.400
PIPEFITTER	E	BLD		34.450	37.900	1.5	1.5	2.0	6.050	6.550	0.000	0.800
PIPEFITTER	W	BLD		36.000	38.500	1.5	1.5	2.0	7.750	5.500	0.000	0.575
PLASTERER		BLD		28.200	29.700	1.5	1.5	2.0	6.600	5.400	0.000	0.500
PLUMBER	E	BLD		34.450	37.900	1.5	1.5	2.0	6.050	6.550	0.000	0.800
PLUMBER	W	BLD		36.000	38.500	1.5	1.5	2.0	7.750	5.500	0.000	0.575
ROOFER		BLD		29.500	31.500	1.5	1.5	2.0	8.600	6.850	0.000	0.200
SHEETMETAL WORKER		ALL		31.690	33.190	1.5	1.5	2.0	7.130	6.730	1.910	0.360

SPRINKLER FITTER	BLD	38.780	41.780	2.0	2.0	2.0	8.370	11.18	0.000	1.000
TERRAZZO FINISHER	BLD	31.240	0.000	1.5	1.5	2.0	6.000	3.230	0.000	0.200
TERRAZZO MASON	BLD	32.530	32.830	1.5	1.5	2.0	6.000	5.230	0.000	0.210
TRUCK DRIVER	ALL 1	31.340	0.000	1.5	1.5	2.0	10.30	5.010	0.000	0.250
TRUCK DRIVER	ALL 2	31.780	0.000	1.5	1.5	2.0	10.30	5.010	0.000	0.250
TRUCK DRIVER	ALL 3	32.020	0.000	1.5	1.5	2.0	10.30	5.010	0.000	0.250
TRUCK DRIVER	ALL 4	32.280	0.000	1.5	1.5	2.0	10.30	5.010	0.000	0.250
TRUCK DRIVER	ALL 5	33.130	0.000	1.5	1.5	2.0	10.30	5.010	0.000	0.250
TRUCK DRIVER	O&C 1	25.070	0.000	1.5	1.5	2.0	10.30	5.010	0.000	0.250
TRUCK DRIVER	O&C 2	25.420	0.000	1.5	1.5	2.0	10.30	5.010	0.000	0.250
TRUCK DRIVER	O&C 3	25.620	0.000	1.5	1.5	2.0	10.30	5.010	0.000	0.250
TRUCK DRIVER	O&C 4	25.820	0.000	1.5	1.5	2.0	10.30	5.010	0.000	0.250
TRUCK DRIVER	O&C 5	26.500	0.000	1.5	1.5	2.0	10.30	5.010	0.000	0.250

Legend:

RG (Region)

TYP (Trade Type - All,Highway,Building,Floating,Oil & Chip,Rivers)

C (Class)

Base (Base Wage Rate)

FRMAN (Foreman Rate)

M-F>8 (OT required for any hour greater than 8 worked each day, Mon through Fri.

OSA (Overtime (OT) is required for every hour worked on Saturday)

OSH (Overtime is required for every hour worked on Sunday and Holidays)

H/W (Health & Welfare Insurance)

Pensn (Pension)

Vac (Vacation)

Trng (Training)

Explanations

WASHINGTON COUNTY

ELECTRICIANS (NORTHWEST) - Township of Venedy.

PLUMBERS & PIPEFITTERS (WEST) - That part of the county West of a line 2.5 miles East of Rt. 127 including the towns of Posin, Beacoup and New Minden.

PLUMBERS & PIPEFITTERS (EAST) - That part of the county East of a North-South line 2.5 miles East of Rt. 127.

The following list is considered as those days for which holiday rates of wages for work performed apply: New Years Day, Memorial Day, Fourth of July, Labor Day, Thanksgiving Day, Christmas Day and Veterans Day in some classifications/counties. Generally, any of these holidays which fall on a Sunday is celebrated on the following Monday. This then makes work performed on that Monday payable at the appropriate overtime rate for holiday pay. Common practice in a given local may alter certain days of celebration. If in doubt, please

check with IDOL.

Oil and chip resealing (O&C) means the application of road oils and liquid asphalt to coat an existing road surface, followed by application of aggregate chips or gravel to coated surface, and subsequent rolling of material to seal the surface.

EXPLANATION OF CLASSES

ASBESTOS - GENERAL - removal of asbestos material/mold and hazardous materials from any place in a building, including mechanical systems where those mechanical systems are to be removed. This includes the removal of asbestos materials/mold and hazardous materials from ductwork or pipes in a building when the building is to be demolished at the time or at some close future date.

ASBESTOS - MECHANICAL - removal of asbestos material from mechanical systems, such as pipes, ducts, and boilers, where the mechanical systems are to remain.

CERAMIC TILE FINISHER AND MARBLE FINISHER

The handling, at the building site, of all sand, cement, tile, marble or stone and all other materials that may be used and installed by [a] tile layer or marble mason. In addition, the grouting, cleaning, sealing, and mixing on the job site, and all other work as required in assisting the setter. The term "Ceramic" is used for naming the classification only and is in no way a limitation of the product handled. Ceramic takes into consideration most hard tiles.

ELECTRONIC SYSTEMS TECHNICIAN

Installation, service and maintenance of low-voltage systems which utilizes the transmission and/or transference of voice, sound, vision, or digital for commercial, education, security and entertainment purposes for the following: TV monitoring and surveillance, background/foreground music, intercom and telephone interconnect, field programming, inventory control systems, microwave transmission, multi-media, multiplex, radio page, school, intercom and sound burglar alarms and low voltage master clock systems.

Excluded from this classification are energy management systems, life safety systems, supervisory controls and data acquisition systems not intrinsic with the above listed systems, fire alarm systems, nurse call systems and raceways exceeding fifteen feet in length.

OPERATING ENGINEER - BUILDING

GROUP I. Cranes, Dragline, Shovels, Skimmer Scoops, Clamshells or Derrick Boats, Pile Drivers, Crane-Type Backhoes, Asphalt Plant Operators, Concrete Plant Operators, Dredges, Asphalt Spreading Machines, All Locomotives, Cable Ways or Tower Machines, Hoists, Hydraulic Backhoes, Ditching Machines or Backfiller, Cherrypickers, Overhead Cranes, Roller - Steam or Gas, Concrete Pavers, Excavators, Concrete Breakers, Concrete Pumps, Bulk Cement Plants, Cement Pumps, Derrick-Type Drills, Boat Operators, Motor Graders or Pushcats, Scoops or Tournapulls, Bulldozers, Endloaders or Fork Lifts, Power Blade or Elevating Graders, Winch Cats, Boom or Winch Trucks or Boom Tractors, Pipe Wrapping or Painting Machines, Asphalt Plant Engineer, Journeyman Lubricating Engineer, Drills (other than Derrick Type), Mud Jacks, or Well Drilling Machines, Boring Machines or Track Jacks, Mixers, Conveyors (Two), Air Compressors (Two), Water Pumps regardless of size (Two), Welding Machines (Two), Siphons or Jets (Two), Winch Heads or Apparatuses (Two), Light Plants (Two), All Tractors regardless of size (straight tractor only), Fireman on Stationary Boilers, Automatic

Elevators, Form Grading Machines, Finishing Machines, Power Sub-Grader or Ribbon Machines, Longitudinal Floats, Distributor Operators on Trucks, Winch Heads or Apparatuses (One), Mobil Track air and heaters (two to five), Heavy Equipment Greaser, Relief Operator, Assistant Master Mechanic and Heavy Duty Mechanic, self-propelled concrete saws of all types and sizes with their attachments, gob-hoppers, excavators all sizes, the repair and greasing of all diesel hammers, the operation and set-up of bidwells, water blasters of all sizes and their clutches, hydraulic jacks where used for hoisting, operation of log skidders, iceolators used on and off of pipeline, condor cranes, bow boats, survey boats, bobcats and all their attachments, skid steer loaders and all their attachments, creter cranes, batch plants, operator (all sizes), self propelled roto mills, operation of conveyor systems of any size and any configuration, operation, repair and service of all vibratory hammers, all power pacs and their controls regardless of location, curtains or brush burning machines, stump cutter machines, Nail launchers when mounted on a machine or self-propelled, operation of con-cover machines, and all Operators except those listed below).

GROUP II. Assistant Operators.

GROUP III. Air Compressors (One), Water Pumps, regardless of Size (One), Waterblasters (one), Welding Machine (One), Mixers (One Bag), Conveyor (One), Siphon or Jet (One), Light Plant (One), Heater (One), Immobile Track Air (One), and Self Propelled Walk-Behind Rollers.

GROUP IV. Asphalt Spreader Oilers, Fireman on Whirlies and Heavy Equipment Oilers, Truck Cranes, Dredges, Monigans, Large Cranes - (Over 65-ton rated capacity) Concrete Plant Oiler, Blacktop Plant Oiler, and Creter Crane Oiler (when required).

GROUP V. Oiler.

GROUP VI. Operators on equipment with Booms, including jibs, 100 feet and over, and less than 150 feet long.

GROUP VII. Operators on equipment with Booms, including jibs, 150 feet and over, and less than 200 feet long.

GROUP VIII. Operators on Equipment with Booms, including jibs, 200 feet and over; Tower Cranes; and Whirlie Cranes.

GROUP IX. Master Mechanic

OPERATING ENGINEERS - Highway

GROUP I. Cranes, Dragline, Shovels, Skimmer Scoops, Clamshells or Derrick Boats, Pile Drivers, Crane-Type Backhoes, Asphalt Plant Operators, Concrete Plant Operators, Dredges, Asphalt Spreading Machines, All Locomotives, Cable Ways or Tower Machines, Hoists, Hydraulic Backhoes, Ditching Machines or Backfiller, Cherrypickers, Overhead Cranes, Roller - Steam or Gas, Concrete Pavers, Excavators, Concrete Breakers, Concrete Pumps, Bulk Cement Plants, Cement Pumps, Derrick-Type Drills, Boat Operators, Motor Graders or Pushcats, Scoops or Tournapulls, Bulldozers, Endloaders or Fork Lifts, Power Blade or Elevating Graders, Winch Cats, Boom or Winch Trucks or Boom Tractors, Pipe Wrapping or Painting Machines, Asphalt Plant Engineer, Journeyman Lubricating Engineer, Drills (other than Derrick Type), Mud Jacks, Well Drilling Machines, Boring Machines, Track Jacks, Mixers, Conveyors (Two), Air Compressors (Two), Water Pumps regardless of size (Two), Welding Machines (Two), Siphons or Jets (Two), Winch Heads or Apparatuses (Two), Light Plants (Two), All Tractors regardless of size (straight tractor only), Fireman on Stationary Boilers, Automatic Elevators, Form Grading Machines, Finishing Machines, Power Sub-Grader

or Ribbon Machines, Longitudinal Floats, Distributor Operators on Trucks, Winch Heads or Apparatuses (One), Mobil Track air and heaters (two to five), Heavy Equipment Greaser, Relief Operator, Assistant Master Mechanic and Heavy Duty Mechanic, self-propelled concrete saws of all types and sizes with their attachments, gob-hoppers, excavators all sizes, the repair and greasing of all diesel hammers, the operation and set-up of bidwells, water blasters of all sizes and their clutches, hydraulic jacks where used for hoisting, operation of log skidders, iceolators used on and off of pipeline, condor cranes, bow boats, survey boats, bobcats and all their attachments, skid steer loaders and all their attachments, creter cranes, batch plants, operator (all sizes), self propelled roto mills, operation of conveyor systems of any size and any configuration, operation, repair and service of all vibratory hammers, all power pacs and their controls regardless of location, curtains or brush burning machines, stump cutter machines, Nail launchers when mounted on a machine or self-propelled, operation of con-cover machines, and all Operators (except those listed below).

GROUP II. Assistant Operators.

GROUP III. Air Compressors (One), Water Pumps, regardless of Size (One), Waterblasters (one), Welding Machine (One), Mixers (One Bag), Conveyor (One), Siphon or Jet (One), Light Plant (One), Heater (One), Immobile Track Air (One), and Self Propelled Walk-Behind Rollers.

GROUP IV. Asphalt Spreader Oilers, Fireman on Whirlies and Heavy Equipment Oilers, Truck Cranes, Dredges, Monigans, Large Cranes - (Over 65-ton rated capacity) Concrete Plant Oiler, Blacktop Plant Oiler, and Creter Crane Oiler (when required).

GROUP V. Oiler.

GROUP VI. Operators on equipment with Booms, including jibs, 100 feet and over, and less than 150 feet long.

GROUP VII. Operators on equipment with Booms, including jibs, 150 feet and over, and less than 200 feet long.

GROUP VIII. Operators on Equipment with Booms, including jibs, 200 feet and over; Tower Cranes; and Whirlie Cranes.

GROUP IX. Mechanic

TRUCK DRIVER - BUILDING, HEAVY AND HIGHWAY CONSTRUCTION

Class 1. Drivers on 2 axle trucks hauling less than 9 ton. Air compressor and welding machines and brooms, including those pulled by separate units, truck driver helpers, warehouse employees, mechanic helpers, greasers and tiremen, pickup trucks when hauling materials, tools, or workers to and from and on-the-job site, and fork lifts up to 6,000 lb. capacity.

Class 2. Two or three axle trucks hauling more than 9 ton but hauling less than 16 ton. A-frame winch trucks, hydrolift trucks, vactor trucks or similar equipment when used for transportation purposes. Fork lifts over 6,000 lb. capacity, winch trucks, four axle combination units, and ticket writers.

Class 3. Two, three or four axle trucks hauling 16 ton or more. Drivers on water pulls, articulated dump trucks, mechanics and working forepersons, and dispatchers. Five axle or more combination units.

Class 4. Low Boy and Oil Distributors.

Class 5. Drivers who require special protective clothing while employed on hazardous waste work. Jurisdiction in Bond, Calhoun, Clinton, Fayette, Greene, Jefferson, Jersey, Macoupin, Madison, Marion, Monroe, Montgomery, Perry, Randolph, St. Clair, and Washington.

TRUCK DRIVER - OIL AND CHIP RESEALING ONLY.

This shall encompass laborers, workers and mechanics who drive contractor or subcontractor owned, leased, or hired pickup, dump, service, or oil distributor trucks. The work includes transporting materials and equipment (including but not limited to, oils, aggregate supplies, parts, machinery and tools) to or from the job site; distributing oil or liquid asphalt and aggregate; stock piling material when in connection with the actual oil and chip contract. The Truck Driver (Oil & Chip Resealing) wage classification does not include supplier delivered materials.

TERRAZZO FINISHER

The handling of all materials used for Mosaic and Terrazzo work including preparing, mixing by hand, by mixing machine or transporting of pre-mixed materials and distributing with shovel, rake, hoe, or pail, all kinds of concrete foundations necessary for Mosaic and Terrazzo work, all cement terrazzo, magnesite terrazzo, Do-O-Tex terrazzo, epoxy matrix ter-razzo, exposed aggregate, rustic or rough washed for exterior or interior of buildings placed either by machine or by hand, and any other kind of mixture of plastics composed of chips or granules when mixed with cement, rubber, neoprene, vinyl, magnesium chloride or any other resinous or chemical substances used for seamless flooring systems, and all other building materials, all similar materials and all precast terrazzo work on jobs, all scratch coat used for Mosaic and Terrazzo work and sub-bed, tar paper and wire mesh (2x2 etc.) or lath. The rubbing, grinding, cleaning and finishing of same either by hand or by machine or by terrazzo resurfacing equipment on new or existing floors. When necessary finishers shall be allowed to assist the mechanics to spread sand bed, lay tarpaper and wire mesh (2x2 etc.) or lath. The finishing of cement floors where additional aggregate of stone is added by spreading or sprinkling on top of the finished base, and troweled or rolled into the finish and then the surface is ground by grinding machines.

Other Classifications of Work:

For definitions of classifications not otherwise set out, the Department generally has on file such definitions which are available. If a task to be performed is not subject to one of the classifications of pay set out, the Department will upon being contacted state which neighboring county has such a classification and provide such rate, such rate being deemed to exist by reference in this document. If no neighboring county rate applies to the task, the Department shall undertake a special determination, such special determination being then deemed to have existed under this determination. If a project requires these, or any classification not listed, please contact IDOL at 217-782-1710 for wage rates or clarifications.

LANDSCAPING

Landscaping work falls under the existing classifications for laborer, operating engineer and truck driver. The work performed by landscape

plantsman and landscape laborer is covered by the existing classification of laborer. The work performed by landscape operators (regardless of equipment used or its size) is covered by the classifications of operating engineer. The work performed by landscape truck drivers (regardless of size of truck driven) is covered by the classifications of truck driver.

Wayne County Prevailing Wage for May 2013

(See explanation of column headings at bottom of wages)

Trade Name	RG	TYP	C	Base	FRMAN	M-F>8	OSA	OSH	H/W	Pensn	Vac	Trng
=====	==	===	=	=====	=====	=====	===	===	=====	=====	=====	=====
ASBESTOS ABT-GEN		ALL		25.300	25.750	1.5	1.5	2.0	5.750	10.35	0.000	0.900
ASBESTOS ABT-MEC		BLD		21.150	22.150	1.5	1.5	2.0	6.400	5.150	0.000	0.650
BOILERMAKER		BLD		31.500	34.000	1.5	1.5	2.0	7.070	18.73	1.000	0.350
BRICK MASON		BLD		28.620	30.120	1.5	1.5	2.0	8.200	7.030	0.000	0.430
CARPENTER		BLD		31.890	33.390	1.5	1.5	2.0	6.550	6.750	0.000	0.400
CARPENTER		HWY		31.890	33.640	1.5	1.5	2.0	6.550	6.750	0.000	0.400
CEMENT MASON		BLD		28.200	29.700	1.5	1.5	2.0	6.600	5.400	0.000	0.500
CEMENT MASON		HWY		27.080	28.580	1.5	1.5	2.0	6.600	5.800	0.000	0.300
CERAMIC TILE FNSHER		BLD		27.120	0.000	1.5	1.5	2.0	8.200	7.030	0.000	0.430
ELECTRIC PWR EQMT OP		ALL	1	35.570	0.000	1.5	1.5	2.0	5.000	9.960	0.000	0.360
ELECTRIC PWR EQMT OP		ALL	2	31.740	0.000	1.5	1.5	2.0	5.000	8.880	0.000	0.320
ELECTRIC PWR GRNDMAN		ALL		26.100	0.000	1.5	1.5	2.0	5.000	7.310	0.000	0.260
ELECTRIC PWR LINEMAN		ALL		44.630	47.650	1.5	1.5	2.0	5.000	12.50	0.000	0.450
ELECTRICIAN		ALL		39.350	41.600	1.5	1.5	2.0	6.140	9.440	0.000	0.790
ELECTRONIC SYS TECH		BLD		32.570	34.320	1.5	1.5	2.0	6.000	4.240	0.000	0.400
FLOOR LAYER		BLD		29.330	30.080	1.5	1.5	2.0	6.550	6.750	0.000	0.400
GLAZIER		BLD		26.780	28.030	1.5	1.5	2.0	6.120	5.200	0.000	0.300
HT/FROST INSULATOR		BLD		29.450	30.450	1.5	1.5	2.0	5.050	9.730	0.000	0.280
IRON WORKER		ALL		27.020	28.270	1.5	1.5	2.0	7.010	9.200	0.000	0.345
LABORER		BLD		25.300	25.750	1.5	1.5	2.0	5.750	10.35	0.000	0.800
LABORER		HWY		25.300	25.750	1.5	1.5	2.0	5.750	10.35	0.000	0.800
MACHINIST		BLD		43.550	46.050	1.5	1.5	2.0	6.130	8.950	1.850	0.000
MARBLE FINISHERS		BLD		27.120	0.000	1.5	1.5	2.0	8.200	7.030	0.000	0.430
MARBLE MASON		BLD		28.620	30.120	1.5	1.5	2.0	8.200	7.030	0.000	0.430
MILLWRIGHT		BLD		31.890	33.390	1.5	1.5	2.0	6.550	6.750	0.000	0.400
MILLWRIGHT		HWY		32.390	34.140	1.5	1.5	2.0	6.550	6.750	0.000	0.400
OPERATING ENGINEER		ALL	1	36.950	0.000	1.5	1.5	2.0	7.250	8.700	0.000	0.800
OPERATING ENGINEER		ALL	2	23.900	0.000	1.5	1.5	2.0	7.250	8.700	0.000	0.800
PAINTER		ALL		23.190	23.690	1.5	1.5	2.0	5.000	6.840	0.000	0.480
PAINTER OVER 30FT		ALL		26.290	26.790	1.5	1.5	2.0	5.000	6.840	0.000	0.480
PAINTER PWR EQMT		ALL		26.290	26.790	1.5	1.5	2.0	5.000	6.840	0.000	0.480
PILEDRIIVER		BLD		31.890	33.390	1.5	1.5	2.0	6.550	6.750	0.000	0.400
PILEDRIIVER		HWY		32.390	34.140	1.5	1.5	2.0	6.550	6.750	0.000	0.400
PIPEFITTER		BLD		37.000	40.700	1.5	1.5	2.0	8.500	9.300	0.000	1.350
PLASTERER		BLD		28.200	29.700	1.5	1.5	2.0	6.600	5.400	0.000	0.500
PLUMBER		BLD		37.000	40.700	1.5	1.5	2.0	8.500	9.300	0.000	1.350
ROOFER		BLD		23.900	24.900	1.5	1.5	2.0	8.650	3.800	0.000	0.000
SHEETMETAL WORKER		ALL		31.690	33.190	1.5	1.5	2.0	7.130	6.730	1.910	0.360
SPRINKLER FITTER		BLD		36.390	39.140	1.5	1.5	2.0	8.420	8.500	0.000	0.450
STONE MASON		BLD		28.620	30.120	1.5	1.5	2.0	8.200	7.030	0.000	0.430
TERRAZZO FINISHER		BLD		27.120	0.000	1.5	1.5	2.0	8.200	7.030	0.000	0.430
TERRAZZO MASON		BLD		28.620	30.120	1.5	1.5	2.0	8.200	7.030	0.000	0.430
TRUCK DRIVER		ALL	1	31.340	0.000	1.5	1.5	2.0	10.30	5.010	0.000	0.250
TRUCK DRIVER		ALL	2	31.780	0.000	1.5	1.5	2.0	10.30	5.010	0.000	0.250
TRUCK DRIVER		ALL	3	32.020	0.000	1.5	1.5	2.0	10.30	5.010	0.000	0.250
TRUCK DRIVER		ALL	4	32.280	0.000	1.5	1.5	2.0	10.30	5.010	0.000	0.250
TRUCK DRIVER		ALL	5	33.130	0.000	1.5	1.5	2.0	10.30	5.010	0.000	0.250
TUCKPOINTER		BLD		28.620	30.120	1.5	1.5	2.0	8.200	7.030	0.000	0.430

Legend:

RG (Region)

TYP (Trade Type - All,Highway,Building,Floating,Oil & Chip,Rivers)

C (Class)

Base (Base Wage Rate)

FRMAN (Foreman Rate)

M-F>8 (OT required for any hour greater than 8 worked each day, Mon through Fri.

OSA (Overtime (OT) is required for every hour worked on Saturday)

OSH (Overtime is required for every hour worked on Sunday and Holidays)

H/W (Health & Welfare Insurance)

Pensn (Pension)

Vac (Vacation)

Trng (Training)

Explanations

WAYNE COUNTY

The following list is considered as those days for which holiday rates of wages for work performed apply: New Years Day, Memorial Day, Fourth of July, Labor Day, Thanksgiving Day, Christmas Day and Veterans Day in some classifications/counties. Generally, any of these holidays which fall on a Sunday is celebrated on the following Monday. This then makes work performed on that Monday payable at the appropriate overtime rate for holiday pay. Common practice in a given local may alter certain days of celebration. If in doubt, please check with IDOL.

EXPLANATION OF CLASSES

ASBESTOS - GENERAL - removal of asbestos material/mold and hazardous materials from any place in a building, including mechanical systems where those mechanical systems are to be removed. This includes the removal of asbestos materials/mold and hazardous materials from ductwork or pipes in a building when the building is to be demolished at the time or at some close future date.

ASBESTOS - MECHANICAL - removal of asbestos material from mechanical systems, such as pipes, ducts, and boilers, where the mechanical systems are to remain.

CERAMIC TILE FINISHER, MARBLE FINISHER, TERRAZZO FINISHER

Assisting, helping or supporting the tile, marble and terrazzo mechanic by performing their historic and traditional work assignments required to complete the proper installation of the work covered by said crafts. The term "Ceramic" is used for naming the classification only, and is in no a limitation of the product handled. Ceramic takes into consideration most hard tiles.

ELECTRIC POWER LINEMAN

Construction, maintenance and dismantling of overhead and underground electric power lines, including high voltage pipe type cable work, and associated structures and equipment.

ELECTRIC POWER EQUIPMENT OPERATOR - CLASS 1

Operation of all crawler type equipment D-4 and larger from the ground to assist the Electric Power Linemen in performing their duties.

ELECTRIC POWER EQUIPMENT OPERATORS - CLASS 2

Operation of all other equipment from the ground to assist the Electric Power Linemen in performing their duties.

ELECTRIC POWER GROUNDMAN

Applies to workers who assist the Electric Power Lineman from the ground.

ELECTRONIC SYSTEMS TECHNICIAN

Installation, service and maintenance of low-voltage systems which utilizes the transmission and/or transference of voice, sound, vision, or digital for commercial, education, security and entertainment purposes for the following: TV monitoring and surveillance, background/foreground music, intercom and telephone interconnect, field programming, inventory control systems, microwave transmission, multi-media, multiplex, radio page, school, intercom and sound burglar alarms and low voltage master clock systems.

Excluded from this classification are energy management systems, life safety systems, supervisory controls and data acquisition systems not intrinsic with the above listed systems, fire alarm systems, nurse call systems and raceways exceeding fifteen feet in length.

TRUCK DRIVER - BUILDING, HEAVY AND HIGHWAY CONSTRUCTION

Class 1. Drivers on 2 axle trucks hauling less than 9 ton. Air compressor and welding machines and brooms, including those pulled by separate units, truck driver helpers, warehouse employees, mechanic helpers, greasers and tiremen, pickup trucks when hauling materials, tools, or workers to and from and on-the-job site, and fork lifts up to 6,000 lb. capacity.

Class 2. Two or three axle trucks hauling more than 9 ton but hauling less than 16 ton. A-frame winch trucks, hydrolift trucks, vector trucks or similar equipment when used for transportation purposes. Fork lifts over 6,000 lb. capacity, winch trucks, four axle combination units, and ticket writers.

Class 3. Two, three or four axle trucks hauling 16 ton or more. Drivers on water pulls, articulated dump trucks, mechanics and working forepersons, and dispatchers. Five axle or more combination units.

Class 4. Low Boy and Oil Distributors.

Class 5. Drivers who require special protective clothing while employed on hazardous waste work.

OPERATING ENGINEERS - BUILDING, HEAVY AND HIGHWAY CONSTRUCTION

Class 1. Power Cranes, Draglines, Derricks, Shovels, Gradalls, Mechanics, Tractor Highlift, Tornadozer, Concrete Mixers with Skip, Tournamixer, Two Drum Machine, One Drum Hoist with Tower or Boom,

Cableways, Tower Machines, Motor Patrol, Boom Tractor, Boom or Winch Truck, Winch or Hydraulic Boom Truck, Truck Crane, Tournapull, Tractor Operating Scoops, Bulldozer, Push Tractor, Asphalt Planer, Finishing Machine on Asphalt, Large Rollers on Earth, Rollers on Asphalt Mix, Ross Carrier or similar Machine, Gravel Processing Machine, Asphalt Plant Engineer, Paver Operator, Dredging Equipment, or Dredge Engineer, or Dredge Operator, Central Mix Plant Engineer, CMI or similar type machine, Concrete Pump, Truck or Skid Mounted, Tower Crane, Engineer or Rock Crusher Plant, Concrete Plant Engineer, Ditching Machine with dual attachment, Tractor Mounted Loaders, Cherry Picker, Hydro Crane, Standard or Dinkey Locomotives, Scoopmobiles, Euclid Loader, Soil Cement Machine, Back Filler, Elevating Machine, Power Blade, Drilling Machine, including Well Testing, Caissons, Shaft or any similar type drilling machines, Motor Driven Paint Machine, Pipe Cleaning Machine, Pipe Wrapping Machine, Pipe Bending Machine, Apsco Paver, Boring Machine, (Head Equipment Greaser), Barber-Greene Loaders, Formless Paver, (Well Point System), Concrete Spreader, Hydra Ax, Span Saw, Marine Scoops, Brush Mulcher, Brush Burner, Mesh Placer, Tree Mover, Helicopter Crew (3), Piledriver-Skid or Crawler, Stump Remover, Root Rake, Tug Boat Operator, Refrigerating Machine, Freezing Operator, Chair Cart-Self-Propelled, Hydra Seeder, Straw Blower, Power Sub Grader, Bull Float, Finishing Machine, Self-Propelled Pavement Breaker, Lull (or similar type Machine), Two Air Compressors, Compressors hooked in Manifold, Overhead Crane, Chip Spreader, Mud Cat, Sull-Air, Fork Lifts (except when used for landscaping work), Soil Stabilizer (Seaman Tiller, Bo Mag, Rago Gator, and similar types of equipment), Tube Float, Spray Machine, Curing Machine, Concrete or Asphalt Milling Machine, Snooper Truck-Operator, Backhoe, Farm Tractors (with attachments), 4 Point Lift System (Power Lift or similar type), Skid-Steer (Bob Cat or similar type), Wrecking Shears, Water Blaster.

Class 2. Concrete Mixers without Skips, Rock Crusher, Ditching Machine under 6', Curbing Machine, One Drum Machines without Tower or Boom, Air Tugger, Self-Propelled Concrete Saw, Machine Mounted Post Hole Digger, two to four Generators, Water Pumps or Welding Machines, within 400 feet, Air Compressor 600 cu. ft. and under, Rollers on Aggregate and Seal Coat Surfaces, Fork Lift (when used for landscaping work), Concrete and Blacktop Curb Machine, One Water Pump, Oilers, Air Valves or Steam Valves, One Welding Machine, Truck Jack, Mud Jack, Gunnite Machine, House Elevators when used for hoisting material, Engine Tenders, Fireman, Wagon Drill, Flex Plane, Conveyor, Siphons and Pulsometer, Switchman, Fireman on Paint Pots, Fireman on Asphalt Plants, Distributor Operator on Trucks, Tampers, Self-Propelled Power Broom, Striping Machine (motor driven), Form Tamper, Bulk Cement Plant, Equipment Greaser, Deck Hands, Truck Crane Oiler-Driver, Cement Blimps, Form Grader, Temporary Heat, Throttle Valve, Super Sucker (and similar type of equipment).

Other Classifications of Work:

For definitions of classifications not otherwise set out, the Department generally has on file such definitions which are available. If a task to be performed is not subject to one of the classifications of pay set out, the Department will upon being contacted state which neighboring county has such a classification and provide such rate, such rate being deemed to exist by reference in this document. If no neighboring county rate applies to the task, the Department shall undertake a special determination, such special determination being then deemed to have existed under this determination. If a project requires these, or any classification not listed, please contact IDOL at 217-782-1710 for wage rates or clarifications.

LANDSCAPING

Landscaping work falls under the existing classifications for laborer, operating engineer and truck driver. The work performed by landscape plantsman and landscape laborer is covered by the existing classification of laborer. The work performed by landscape operators (regardless of equipment used or its size) is covered by the classifications of operating engineer. The work performed by landscape truck drivers (regardless of size of truck driven) is covered by the classifications of truck driver.

White County Prevailing Wage for May 2013

(See explanation of column headings at bottom of wages)

Trade Name	RG	TYP	C	Base	FRMAN	M-F>8	OSA	OSH	H/W	Pensn	Vac	Trng
=====	==	===	=	=====	=====	=====	===	===	=====	=====	=====	=====
ASBESTOS ABT-GEN		ALL		25.300	25.750	1.5	1.5	2.0	5.750	10.35	0.000	0.900
ASBESTOS ABT-MEC		BLD		21.150	22.150	1.5	1.5	2.0	6.400	5.150	0.000	0.650
BOILERMAKER		BLD		31.500	34.000	1.5	1.5	2.0	7.070	18.73	1.000	0.350
BRICK MASON		BLD		28.620	30.120	1.5	1.5	2.0	8.200	7.030	0.000	0.430
CARPENTER		BLD		31.890	33.390	1.5	1.5	2.0	6.550	6.750	0.000	0.400
CARPENTER		HWY		31.890	33.640	1.5	1.5	2.0	6.550	6.750	0.000	0.400
CEMENT MASON		BLD		28.200	29.700	1.5	1.5	2.0	6.600	5.400	0.000	0.500
CEMENT MASON		HWY		27.080	28.580	1.5	1.5	2.0	6.600	5.800	0.000	0.300
CERAMIC TILE FNSHER		BLD		27.120	0.000	1.5	1.5	2.0	8.200	7.030	0.000	0.430
ELECTRIC PWR EQMT OP		ALL	1	35.570	0.000	1.5	1.5	2.0	5.000	9.960	0.000	0.360
ELECTRIC PWR EQMT OP		ALL	2	31.740	0.000	1.5	1.5	2.0	5.000	8.880	0.000	0.320
ELECTRIC PWR GRNDMAN		ALL		26.100	0.000	1.5	1.5	2.0	5.000	7.310	0.000	0.260
ELECTRIC PWR LINEMAN		ALL		44.630	47.650	1.5	1.5	2.0	5.000	12.50	0.000	0.450
ELECTRICIAN		ALL		39.350	41.600	1.5	1.5	2.0	6.140	9.440	0.000	0.790
ELECTRONIC SYS TECH		BLD		32.570	34.320	1.5	1.5	2.0	6.000	4.240	0.000	0.400
FLOOR LAYER		BLD		29.330	30.080	1.5	1.5	2.0	6.550	6.750	0.000	0.400
GLAZIER		BLD		26.780	28.030	1.5	1.5	2.0	6.120	5.200	0.000	0.300
HT/FROST INSULATOR		BLD		29.450	30.450	1.5	1.5	2.0	5.050	9.730	0.000	0.280
IRON WORKER		ALL		27.020	28.270	1.5	1.5	2.0	7.010	9.200	0.000	0.345
LABORER		BLD		25.300	25.750	1.5	1.5	2.0	5.750	10.35	0.000	0.800
LABORER		HWY		25.300	25.750	1.5	1.5	2.0	5.750	10.35	0.000	0.800
MACHINIST		BLD		43.550	46.050	1.5	1.5	2.0	6.130	8.950	1.850	0.000
MARBLE FINISHERS		BLD		27.120	0.000	1.5	1.5	2.0	8.200	7.030	0.000	0.430
MARBLE MASON		BLD		28.620	30.120	1.5	1.5	2.0	8.200	7.030	0.000	0.430
MILLWRIGHT		BLD		31.890	33.390	1.5	1.5	2.0	6.550	6.750	0.000	0.400
MILLWRIGHT		HWY		32.390	34.140	1.5	1.5	2.0	6.550	6.750	0.000	0.400
OE RIVER 1		RIV	1	33.550	34.550	1.5	1.5	2.0	7.000	8.800	0.000	1.450
OE RIVER 2		RIV	2	30.100	34.550	1.5	1.5	2.0	7.000	8.800	0.000	1.450
OPERATING ENGINEER		ALL	1	33.450	34.450	1.5	1.5	2.0	7.000	8.800	0.000	1.450
OPERATING ENGINEER		ALL	2	31.550	34.450	1.5	1.5	2.0	7.000	8.800	0.000	1.450
OPERATING ENGINEER		ALL	3	24.150	34.450	1.5	1.5	2.0	7.000	8.800	0.000	1.450
OPERATING ENGINEER		ALL	4	21.400	27.800	1.5	1.5	2.0	5.650	6.100	0.000	1.100
OPERATING ENGINEER		O&C	1	25.090	26.090	1.5	1.5	2.0	7.000	8.800	0.000	1.450
OPERATING ENGINEER		O&C	2	23.660	26.090	1.5	1.5	2.0	7.000	8.800	0.000	1.450
OPERATING ENGINEER		O&C	3	18.120	26.090	1.5	1.5	2.0	7.000	8.800	0.000	1.450
OPERATING ENGINEER		O&C	4	16.050	21.100	1.5	1.5	2.0	5.650	6.100	0.000	1.100
PAINTER		BLD		24.450	25.450	1.5	1.5	2.0	6.250	5.550	0.000	0.300
PAINTER		HWY		25.600	26.600	1.5	1.5	2.0	6.250	5.550	0.000	0.300
PAINTER OVER 30FT		BLD		25.200	26.200	1.5	1.5	2.0	6.250	5.550	0.000	0.300
PAINTER PWR EQMT		BLD		25.450	26.450	1.5	1.5	2.0	6.250	5.550	0.000	0.300
PAINTER PWR EQMT		HWY		26.600	27.600	1.5	1.5	2.0	6.250	5.550	0.000	0.300
PILEDRIVER		BLD		31.890	33.390	1.5	1.5	2.0	6.550	6.750	0.000	0.400
PILEDRIVER		HWY		32.390	34.140	1.5	1.5	2.0	6.550	6.750	0.000	0.400
PIPEFITTER		BLD		33.640	35.660	1.5	1.5	2.0	6.100	8.310	0.000	0.800
PLASTERER		BLD		28.200	29.700	1.5	1.5	2.0	6.600	5.400	0.000	0.500
PLUMBER		BLD		33.640	35.660	1.5	1.5	2.0	6.100	8.310	0.000	0.800
ROOFER		BLD		27.240	29.240	1.5	1.5	2.0	7.200	5.250	0.000	0.540
SHEETMETAL WORKER		ALL		31.690	33.190	1.5	1.5	2.0	7.130	6.730	1.910	0.360

SPRINKLER FITTER	BLD	36.390	39.140	1.5	1.5	2.0	8.420	8.500	0.000	0.450
STONE MASON	BLD	28.620	30.120	1.5	1.5	2.0	8.200	7.030	0.000	0.430
TERRAZZO FINISHER	BLD	27.120	0.000	1.5	1.5	2.0	8.200	7.030	0.000	0.430
TRUCK DRIVER	ALL 1	30.070	0.000	1.5	1.5	2.0	10.30	6.100	0.000	0.250
TRUCK DRIVER	ALL 2	30.520	0.000	1.5	1.5	2.0	10.30	6.100	0.000	0.250
TRUCK DRIVER	ALL 3	30.740	0.000	1.5	1.5	2.0	10.30	6.100	0.000	0.250
TRUCK DRIVER	ALL 4	31.030	0.000	1.5	1.5	2.0	10.30	6.100	0.000	0.250
TRUCK DRIVER	ALL 5	31.850	0.000	1.5	1.5	2.0	10.30	6.100	0.000	0.250
TUCK POINTER	BLD	28.620	30.120	1.5	1.5	2.0	8.200	7.030	0.000	0.430

Legend :

RG (Region)

TYP (Trade Type - All,Highway,Building,Floating,Oil & Chip,Rivers)

C (Class)

Base (Base Wage Rate)

FRMAN (Foreman Rate)

M-F>8 (OT required for any hour greater than 8 worked each day, Mon through Fri.)

OSA (Overtime (OT) is required for every hour worked on Saturday)

OSH (Overtime is required for every hour worked on Sunday and Holidays)

H/W (Health & Welfare Insurance)

Pensn (Pension)

Vac (Vacation)

Trng (Training)

Explanations

WHITE COUNTY

The following list is considered as those days for which holiday rates of wages for work performed apply: New Years Day, Memorial Day, Fourth of July, Labor Day, Thanksgiving Day, Christmas Day and Veterans Day in some classifications/counties. Generally, any of these holidays which fall on a Sunday is celebrated on the following Monday. This then makes work performed on that Monday payable at the appropriate overtime rate for holiday pay. Common practice in a given local may alter certain days of celebration. If in doubt, please check with IDOL.

EXPLANATION OF CLASSES

ASBESTOS - GENERAL - removal of asbestos material/mold and hazardous materials from any place in a building, including mechanical systems where those mechanical systems are to be removed. This includes the removal of asbestos materials/mold and hazardous materials from ductwork or pipes in a building when the building is to be demolished at the time or at some close future date.

ASBESTOS - MECHANICAL - removal of asbestos material from mechanical

systems, such as pipes, ducts, and boilers, where the mechanical systems are to remain.

CERAMIC TILE FINISHER, MARBLE FINISHER, TERRAZZO FINISHER

Assisting, helping or supporting the tile, marble and terrazzo mechanic by performing their historic and traditional work assignments required to complete the proper installation of the work covered by said crafts. The term "Ceramic" is used for naming the classification only, and is in no a limitation of the product handled. Ceramic takes into consideration most hard tiles.

ELECTRIC POWER LINEMAN

Construction, maintenance and dismantling of overhead and underground electric power lines, including high voltage pipe type cable work, and associated structures and equipment.

ELECTRIC POWER EQUIPMENT OPERATOR - CLASS 1

Operation of all crawler type equipment D-4 and larger from the ground to assist the Electric Power Linemen in performing their duties.

ELECTRIC POWER EQUIPMENT OPERATORS - CLASS 2

Operation of all other equipment from the ground to assist the Electric Power Linemen in performing their duties.

ELECTRIC POWER GROUNDMAN

Applies to workers who assist the Electric Power Lineman from the ground.

ELECTRONIC SYSTEMS TECHNICIAN

Installation, service and maintenance of low-voltage systems which utilizes the transmission and/or transference of voice, sound, vision, or digital for commercial, education, security and entertainment purposes for the following: TV monitoring and surveillance, background/foreground music, intercom and telephone interconnect, field programming, inventory control systems, microwave transmission, multi-media, multiplex, radio page, school, intercom and sound burglar alarms and low voltage master clock systems.

Excluded from this classification are energy management systems, life safety systems, supervisory controls and data acquisition systems not intrinsic with the above listed systems, fire alarm systems, nurse call systems and raceways exceeding fifteen feet in length.

TRUCK DRIVER - BUILDING, HEAVY AND HIGHWAY CONSTRUCTION

Class 1. Drivers on 2 axle trucks hauling less than 9 ton. Air compressor and welding machines and brooms, including those pulled by separate units, truck driver helpers, warehouse employees, mechanic helpers, greasers and tiremen, pickup trucks when hauling materials, tools, or workers to and from and on-the-job site, and fork lifts up to 6,000 lb. capacity.

Class 2. Two or three axle trucks hauling more than 9 ton but hauling less than 16 ton. A-frame winch trucks, hydrolift trucks, vactor trucks or similar equipment when used for transportation purposes. Fork lifts over 6,000 lb. capacity, winch trucks, four axle combination units, and ticket writers.

Class 3. Two, three or four axle trucks hauling 16 ton or more. Drivers on water pulls, articulated dump trucks, mechanics and working

forepersons, and dispatchers. Five axle or more combination units.

Class 4. Low Boy and Oil Distributors.

Class 5. Drivers who require special protective clothing while employed on hazardous waste work.

OPERATING ENGINEERS - BUILDING, HEAVY AND HIGHWAY CONSTRUCTION

Class 1. APSCO or Equal Spreading Machine, Backhoe, Backfiller, Boom or Winch Cat, Bituminous Mixplane Machine, Blacksmith, Bituminous Surfacing Machine, Bull-Dozer, Crane, Shovel, Dragline, Truck Crane, Pile Driver, Concrete Breaker, Concrete or Pumpcrete Pumps, Dinky or Standard Locomotives, Well or Caisson Drills, Elevating Grader, Fork Lifts, Flexplane, Gradeall, Hi-Lift Hoists, Guy-Derricks, Hysters, Mechanic Motor Patrol, Mixers-21 cu. ft. or over, Push Cats, Pulls and Scrapers, Two Well Point Pumps, Pulverizer or Tiller, PugMill, Rubber-Tired Farm Type Tractor with Bulldozer/Blade/Auger or hi-lift over 1/2 yd., Jersey Spreader, Tract-Air used with Drill or Hi-Lift, Trenching or Ditching Machines, Wood Chipper w/Tractor, Self-Propelled Roller w/Blade, Equipment Greaser, Self-Propelled Bump Grinder on Concrete pavement, Boat Operator, Skid-Loaders, Tuggers, Lazer Screed, and Self-Propelled Chip Spreader (when others run conveyors).

Class 2. Any type tractor pulling any type roller or disc, Two Air Compressors (220 cu. ft. capacity or over), Two AirTract Drills, Air-Track Drill w/Compressor, Automatic Bins or Scales w/Compressor or Generator, Pipeline Boring Machine, Bulk Cement Plant w/Separate Compressor, Power Operated Bull Float, Hydra-Lift w/Single Motor, Straw Mulcher Blower w/Spout, Self-Propelled Roller/Compactor, Back-End man on Bituminous Surfacing Machine, oiler on milling machine.

Class 3. Air Compressor w/Valve driving piling, Boom or Winch Type Truck, Two Conveyors, Self-Propelled Concrete Saw, Form Grader, Truck Crane Oiler, Self-Propelled Vibrator, Rubber Tired Farm Type Tractor w/Blade/Bulldozer/Auger/hi-lift - 1/2 yd. or less, Elevator Operator, Man Lift (scissor lift) when lifting materials.

Class 4. Air-Track Drill (one), Belt Drag Machine, Power Broom, Mechanical Plasterer Applicator, Trac-Air, Air Compressor (220 cu. ft. or over) One, Air Compressor (under 220 cu. ft) four, Automatic Bin, Bulk Cement Plant w/Built-in Compressor running off same motor or electric motor, Fireman or Switchman, Self-Propelled Form Tamper, Light Plants (4), Welding Machines (4), Pumps (4), or Combination of four (4) Pumps, Light Plants, Welding Machines, Air-Compressors (under 220 cu. ft.), Mudjacks or Wood Chipper, Mixers - less than 21 cu. ft. Mortar Mixer w/Skip or Pump, Pipeline Tract Jack. One Operating Engineer may operate and maintain any combination of the following pieces of equipment, not to exceed four (4) which shall be within a reasonable distance, such combination may include any equipment in this classification: (Compressors, Light Plants, Generators, Welding Machines, Pumps or Conveyors), One Well- Point Pump, Two Motor Driven Heaters, One Air Compressor (under 220 cu. ft.), One Engine-Driven Conveyor, One Motor Driven Heater, One Light Plant, One Pump, One Welding Machine, One Ulmac or Equal Spreader, Oilers, and one Generator 10 kw or greater.

OPERATING ENGINEER RIVER WORK 1 - operate the following machines when working on River Work and Levee Work on the Mississippi and Ohio Rivers, Lakes and Tributaries: Crane, Shovel, Drageline, Scrapers, Dredge, Derrick, Pile-Driver, Push Boat, all power boat operators, Mechanic, Engineman on Dredge, Leverman on Dredge, All Bituminous Spreader machines, Backhoe, Backfiller, Boom, or Winch Cat, Bituminous Mixplane Machine, Blacksmith, Bituminous Surfacing Machine, Bulldozer, Truck Cranes, Hydraulic Truck Mounted Boom/Crane, Concrete

Finishing Machine, or Spreader Machine, Concrete Breaker, Concrete or Pumpcrete Machines, Concrete Plant Operator, All Off Road Material Hauling Equipment, Dinky or Standard Locomotives, Well Drill, Elevating Grader, Fork-Lifts, Flexplane, Gradeall, Hi-Lift, Power Handblade Tugger type Hoist, Hoist Two Drum (or over one), Guyderrick, Hyster, Motor Patrol, Mixers - 21 Cu. Ft. or over, Push Cat, Pulls, & Scrapers, Pumps-Two Well Points, Equipment Greaser, P & H Pulverizer or Pulverizer equal to Pugmill, Pugmill, Rubber-Tired farm type tractor w/Bulldozer/Blade/Auger or Hi-Lift over ½ yard, Skimmer Scoops, Seaman Tiller, Jersey Spreader, Tract-Air used with Drill or Hi-Lift, Trenching or Ditching Machine, Wood Chipper w/Tractor, self-propelled roller w/Blade, Concrete Pumps and Small Equipment Operators.

OPERATING ENGINEER RIVER 2 - when working on River Work and Levee Work on the Mississippi and Ohio Rivers, Lakes and Tributaries shall be employed as the Oiler or Fireman on Crane, Dragline, Shovel, Dredge, Truck Crane, Pile Driver, Gradeall, Dinky or Standard Locomotive, Guy Derrick, Trenching Machine or Ditching Machine 80 H.P. and over, All Terrain (cherry-picker) with over 40 ton Lifting Capacity, Deck Oiler and Deckhands.

Other Classifications of Work:

For definitions of classifications not otherwise set out, the Department generally has on file such definitions which are available. If a task to be performed is not subject to one of the classifications of pay set out, the Department will upon being contacted state which neighboring county has such a classification and provide such rate, such rate being deemed to exist by reference in this document. If no neighboring county rate applies to the task, the Department shall undertake a special determination, such special determination being then deemed to have existed under this determination. If a project requires these, or any classification not listed, please contact IDOL at 217-782-1710 for wage rates or clarifications.

LANDSCAPING

Landscaping work falls under the existing classifications for laborer, operating engineer and truck driver. The work performed by landscape plantsman and landscape laborer is covered by the existing classification of laborer. The work performed by landscape operators (regardless of equipment used or its size) is covered by the classifications of operating engineer. The work performed by landscape truck drivers (regardless of size of truck driven) is covered by the classifications of truck driver.

Whiteside County Prevailing Wage for May 2013

(See explanation of column headings at bottom of wages)

Trade Name	RG	TYP	C	Base	FRMAN	M-F>8	OSA	OSH	H/W	Pensn	Vac	Trng
=====	==	===	=	=====	=====	=====	===	===	=====	=====	=====	=====
ASBESTOS ABT-GEN		BLD		29.550	30.550	1.5	1.5	2.0	8.240	12.42	0.000	0.800
ASBESTOS ABT-MEC		BLD		20.500	21.500	1.5	1.5	2.0	6.250	3.500	0.000	0.000
BOILERMAKER		BLD		35.010	38.010	2.0	2.0	2.0	7.070	13.83	0.000	0.300
BRICK MASON		BLD		35.880	38.630	1.5	1.5	2.0	7.950	11.73	0.000	0.600
CARPENTER		BLD		32.040	35.560	1.5	1.5	2.0	8.630	13.87	0.000	0.600
CARPENTER		HWY		33.790	35.540	1.5	1.5	2.0	9.750	12.99	0.000	0.490
CEMENT MASON		ALL		32.520	35.270	1.5	1.5	2.0	7.700	13.98	0.000	0.500
CERAMIC TILE FNSHER		BLD		32.410	0.000	1.5	1.5	2.0	7.700	4.840	0.000	0.530
COMMUNICATION TECH	E	BLD		36.000	39.600	1.5	1.5	2.0	10.14	11.20	0.000	0.720

ELECTRIC PWR EQMT OP		ALL		36.610	49.750	1.5	1.5	2.0	5.000	11.35	0.000	0.270
ELECTRIC PWR GRNDMAN		ALL		28.310	49.750	1.5	1.5	2.0	5.000	8.780	0.000	0.210
ELECTRIC PWR LINEMAN		ALL		43.830	49.750	1.5	1.5	2.0	5.000	13.58	0.000	0.330
ELECTRIC PWR TRK DRV		ALL		29.310	49.750	1.5	1.5	2.0	5.000	9.090	0.000	0.220
ELECTRICIAN	E	BLD		40.000	44.000	1.5	1.5	2.0	10.14	16.93	0.000	0.800
ELECTRICIAN	W	BLD		31.520	33.520	1.5	1.5	2.0	7.320	10.82	0.000	0.310
ELECTRONIC SYS TECH	W	BLD		23.750	25.500	1.5	1.5	2.0	7.120	5.260	0.000	0.310
ELEVATOR CONSTRUCTOR		BLD		39.380	44.300	2.0	2.0	2.0	11.88	12.71	3.150	0.600
GLAZIER		BLD		22.020	23.520	1.5	1.5	2.0	6.940	6.520	0.000	0.350
HT/FROST INSULATOR		BLD		29.190	30.390	1.5	1.5	2.0	5.420	12.05	0.000	0.900
IRON WORKER	E	ALL		35.090	36.840	2.0	2.0	2.0	8.250	20.59	0.000	0.700
IRON WORKER	W	ALL		28.000	30.240	1.5	1.5	2.0	9.390	10.68	0.000	0.620
LABORER		BLD		29.550	30.550	1.5	1.5	2.0	8.240	12.42	0.000	0.800
LABORER		HWY		32.100	32.850	1.5	1.5	2.0	8.240	12.42	0.000	0.800
LABORER, SKILLED		HWY		34.400	35.150	1.5	1.5	2.0	8.240	12.42	0.000	0.800
LATHER		BLD		32.040	35.560	1.5	1.5	2.0	8.630	13.87	0.000	0.600
MACHINIST		BLD		43.550	46.050	1.5	1.5	2.0	6.130	8.950	1.850	0.000
MARBLE FINISHERS		BLD		32.410	0.000	1.5	1.5	2.0	7.700	4.840	0.000	0.530
MARBLE MASON		BLD		35.090	35.340	1.5	1.5	2.0	7.700	7.150	0.000	0.560
MILLWRIGHT		BLD		34.400	37.840	1.5	1.5	2.0	8.770	13.85	0.000	0.500
OPERATING ENGINEER	E	BLD	1	40.800	44.850	2.0	2.0	2.0	15.85	9.800	2.350	1.300
OPERATING ENGINEER	E	BLD	2	40.100	44.850	2.0	2.0	2.0	15.85	9.800	2.350	1.300
OPERATING ENGINEER	E	BLD	3	37.650	44.850	2.0	2.0	2.0	15.85	9.800	2.350	1.300
OPERATING ENGINEER	E	BLD	4	35.650	44.850	2.0	2.0	2.0	15.85	9.800	2.350	1.300
OPERATING ENGINEER	E	BLD	5	44.600	44.850	2.0	2.0	2.0	15.85	9.800	2.350	1.300
OPERATING ENGINEER	E	BLD	6	43.350	44.850	2.0	2.0	2.0	15.85	9.800	2.350	1.300
OPERATING ENGINEER	E	BLD	7	40.350	44.850	2.0	2.0	2.0	15.85	9.800	2.350	1.300
OPERATING ENGINEER	E	HWY	1	40.650	44.700	1.5	1.5	2.0	15.85	9.800	2.350	1.300
OPERATING ENGINEER	E	HWY	2	40.100	44.700	1.5	1.5	2.0	15.85	9.800	2.350	1.300
OPERATING ENGINEER	E	HWY	3	38.800	44.700	1.5	1.5	2.0	15.85	9.800	2.350	1.300
OPERATING ENGINEER	E	HWY	4	37.350	44.700	1.5	1.5	2.0	15.85	9.800	2.350	1.300
OPERATING ENGINEER	E	HWY	5	35.900	44.700	1.5	1.5	2.0	15.85	9.800	2.350	1.300
OPERATING ENGINEER	E	HWY	6	43.700	44.700	1.5	1.5	2.0	15.85	9.800	2.350	1.300
OPERATING ENGINEER	E	HWY	7	41.700	44.700	1.5	1.5	2.0	15.85	9.800	2.350	1.300
OPERATING ENGINEER	W	BLD	1	29.900	31.900	1.5	1.5	2.0	15.40	6.600	1.500	0.850
OPERATING ENGINEER	W	BLD	2	28.300	31.900	1.5	1.5	2.0	15.40	6.600	1.500	0.850
OPERATING ENGINEER	W	BLD	3	27.150	31.900	1.5	1.5	2.0	15.40	6.600	1.500	0.850
OPERATING ENGINEER	W	BLD	4	30.150	31.900	1.5	1.5	2.0	15.40	6.600	1.500	0.850
OPERATING ENGINEER	W	BLD	5	30.650	31.900	1.5	1.5	2.0	15.40	6.600	1.500	0.850
OPERATING ENGINEER	W	BLD	6	31.150	31.900	1.5	1.5	2.0	15.40	6.600	1.500	0.850
OPERATING ENGINEER	W	BLD	7	30.900	31.900	1.5	1.5	2.0	15.40	6.600	1.500	0.850
OPERATING ENGINEER	W	HWY	1	29.900	31.900	1.5	1.5	2.0	15.40	6.600	1.500	0.850
OPERATING ENGINEER	W	HWY	2	28.300	31.900	1.5	1.5	2.0	15.40	6.600	1.500	0.850
OPERATING ENGINEER	W	HWY	3	27.150	31.900	1.5	1.5	2.0	15.40	6.600	1.500	0.850
OPERATING ENGINEER	W	HWY	4	30.150	31.900	1.5	1.5	2.0	15.40	6.600	1.500	0.850
OPERATING ENGINEER	W	HWY	5	30.650	31.900	1.5	1.5	2.0	15.40	6.600	1.500	0.850
OPERATING ENGINEER	W	HWY	6	31.150	31.900	1.5	1.5	2.0	15.40	6.600	1.500	0.850
OPERATING ENGINEER	W	HWY	7	30.400	31.900	1.5	1.5	2.0	15.40	6.600	1.500	0.850
OPERATING ENGINEER	W	HWY	8	30.900	31.900	1.5	1.5	2.0	15.40	6.600	1.500	0.850
PAINTER		ALL		27.320	28.320	1.5	1.5	1.5	5.000	6.100	0.000	0.600
PAINTER OVER 30FT		ALL		28.570	29.570	1.5	1.5	1.5	5.000	6.100	0.000	0.600
PAINTER PWR EQMT		ALL		27.820	28.820	1.5	1.5	1.5	5.000	6.100	0.000	0.600
PILEDRIVER		BLD		33.040	36.670	1.5	1.5	2.0	8.630	13.87	0.000	0.600
PILEDRIVER		HWY		33.790	35.540	1.5	1.5	2.0	9.750	12.99	0.000	0.490
PIPEFITTER		ALL		36.550	40.210	1.5	1.5	2.0	5.650	12.15	0.000	1.000
PLASTERER		BLD		33.360	36.700	2.0	2.0	2.0	8.150	11.05	0.000	0.500
PLUMBER		ALL		36.550	40.210	1.5	1.5	2.0	5.650	12.15	0.000	1.000
ROOFER		BLD		25.130	26.380	1.5	1.5	2.0	8.610	5.620	0.000	0.260
SHEETMETAL WORKER		BLD		35.780	37.710	1.5	1.5	2.0	5.450	15.44	0.520	0.290
SPRINKLER FITTER		BLD		36.390	39.140	1.5	1.5	2.0	8.420	8.500	0.000	0.450
STONE MASON		BLD		35.880	38.630	1.5	1.5	2.0	7.950	11.73	0.000	0.600
TERRAZZO FINISHER		BLD		32.410	0.000	1.5	1.5	2.0	7.700	4.840	0.000	0.530
TERRAZZO MASON		BLD		35.090	35.340	1.5	1.5	2.0	7.700	7.150	0.000	0.560
TILE LAYER		BLD		32.040	35.560	1.5	1.5	2.0	8.630	13.87	0.000	0.600
TILE MASON		BLD		35.090	35.340	1.5	1.5	2.0	7.700	7.150	0.000	0.560

TRUCK DRIVER	ALL	1	31.230	0.000	1.5	1.5	2.0	10.30	4.840	0.000	0.250
TRUCK DRIVER	ALL	2	31.680	0.000	1.5	1.5	2.0	10.30	4.840	0.000	0.250
TRUCK DRIVER	ALL	3	31.890	0.000	1.5	1.5	2.0	10.30	4.840	0.000	0.250
TRUCK DRIVER	ALL	4	32.180	0.000	1.5	1.5	2.0	10.30	4.840	0.000	0.250
TRUCK DRIVER	ALL	5	33.020	0.000	1.5	1.5	2.0	10.30	4.840	0.000	0.250
TRUCK DRIVER	O&C	1	24.980	0.000	1.5	1.5	2.0	10.30	4.840	0.000	0.250
TRUCK DRIVER	O&C	2	25.340	0.000	1.5	1.5	2.0	10.30	4.840	0.000	0.250
TRUCK DRIVER	O&C	3	25.510	0.000	1.5	1.5	2.0	10.30	4.840	0.000	0.250
TRUCK DRIVER	O&C	4	25.740	0.000	1.5	1.5	2.0	10.30	4.840	0.000	0.250
TRUCK DRIVER	O&C	5	26.420	0.000	1.5	1.5	2.0	10.30	4.840	0.000	0.250
TUCKPOINTER	BLD		35.880	38.630	1.5	1.5	2.0	7.950	11.73	0.000	0.600

Legend :

RG (Region)

TYP (Trade Type - All,Highway,Building,Floating,Oil & Chip,Rivers)

C (Class)

Base (Base Wage Rate)

FRMAN (Foreman Rate)

M-F>8 (OT required for any hour greater than 8 worked each day, Mon through Fri.

OSA (Overtime (OT) is required for every hour worked on Saturday)

OSH (Overtime is required for every hour worked on Sunday and Holidays)

H/W (Health & Welfare Insurance)

Pensn (Pension)

Vac (Vacation)

Trng (Training)

Explanations

WHITESIDE COUNTY

ELECTRICIAN AND COMMUNICATION TECHNICIAN(EAST) - Townships of Genessee, Jordan, Hopkins, Sterling, Hume, Montmorency, Tampico, and Hahnaman.

ELECTRONIC SYSTEMS TECHNICIAN (WEST) - Portion west of Genessee, Hume, Mount Pleasant, and Tampico Townships.

IRONWORKERS (EAST) - That part county North and East of a line from Fair Haven (Carroll County) to Rt. 30, then to the East county line.

OPERATING ENGINEERS (WEST) - From the fifth sectional line east of Morrison, running directly north and south.

The following list is considered as those days for which holiday rates of wages for work performed apply: New Years Day, Memorial Day, Fourth of July, Labor Day, Thanksgiving Day, Christmas Day and Veterans Day in some classifications/counties. Generally, any of these holidays which fall on a Sunday is celebrated on the following

Monday. This then makes work performed on that Monday payable at the appropriate overtime rate for holiday pay. Common practice in a given local may alter certain days of celebration. If in doubt, please check with IDOL.

Oil and chip resealing (O&C) means the application of road oils and liquid asphalt to coat an existing road surface, followed by application of aggregate chips or gravel to coated surface, and subsequent rolling of material to seal the surface.

EXPLANATION OF CLASSES

ASBESTOS - GENERAL - removal of asbestos material/mold and hazardous materials from any place in a building, including mechanical systems where those mechanical systems are to be removed. This includes the removal of asbestos materials/mold and hazardous materials from ductwork or pipes in a building when the building is to be demolished at the time or at some close future date.

ASBESTOS - MECHANICAL - removal of asbestos material from mechanical systems, such as pipes, ducts, and boilers, where the mechanical systems are to remain.

CERAMIC TILE FINISHER, MARBLE FINISHER, TERRAZZO FINISHER

Assisting, helping or supporting the tile, marble and terrazzo mechanic by performing their historic and traditional work assignments required to complete the proper installation of the work covered by said crafts. The term "Ceramic" is used for naming the classification only and is in no way a limitation of the product handled. Ceramic takes into consideration most hard tiles.

COMMUNICATIONS TECHNICIAN - East

Installing, manufacturing, assembling and maintaining sound and intercom, protection alarm (security), fire alarm, master antenna television, closed circuit television, low voltage control for computers and/or door monitoring, school communications systems, telephones and servicing of nurse and emergency calls, and the installation and maintenance of transmit and receive antennas, transmitters, receivers, and associated apparatus which operates in conjunction with above systems. All work associated with these system installations will be included EXCEPT the installation of protective metallic conduit in new construction projects (excluding less than ten-foot runs strictly for protection of cable) and 120 volt AC (or higher) power wiring and associated hardware.

ELECTRONIC SYSTEMS TECHNICIAN - West

Installing, assembling and maintaining sound and intercom, protection alarm (security), master antenna television, closed circuit television, computer hardware and software programming and installation to the network's outlet and input (EXCLUDING all cabling, power and cable termination work historically performed by wiremen), door monitoring and control, nurse and emergency call programming and installation to the system's outlet and input (EXCLUDING all cabling, power and cable termination work historically performed by wiremen), clock and timing; and the installation and maintenance of transmit and receive antennas, transmitters, receivers, and associated apparatus which operates in conjunction with the above systems. All work associated with these system installations will be included EXCEPT (1) installation of protective metallic conduit, excluding less than ten-foot runs strictly for protection of cable, and (2) 120 volt AC (or higher) power wiring and associated hardware.

LABORER, SKILLED - HIGHWAY

Individuals engaged in the following types of work, irrespective of the site of the work: asbestos abatement worker, handling of any materials with any foreign matter harmful to skin or clothing, track laborer, cement handlers, chloride handlers, the unloading and loading with steel workers and re-bars, concrete workers wet, tunnel helpers in free air, batch dumpers, mason tenders, kettle and tar men, tank cleaners, plastic installers, scaffold workers, motorized buggies or motorized unit used for wet concrete or handling of building materials, laborers with de-watering systems, sewer workers plus depth, rod and chainmen with technical engineers, rod and chainmen with land surveyors, rod and chainmen with surveyors, vibrator operators, cement silica, clay, fly ash, lime and plasters, handlers (bulk or bag), cofferdam workers plus depth, on concrete paving, placing, cutting and tying of reinforcing, deck hand, dredge hand, and shore laborers, bankmen on floating plant, grade checker, power tools, front end man on chip spreaders, cession workers plus depth, gunnite nozzle men, lead man on sewer work, welders, cutters, burners and torchmen, chainsaw operators, jackhammer and drill operators, layout man and/or drainage tile layer, steel form setter - street and highway, air tamping hammermen, signal man on crane, concrete saw operator, screedman on asphalt pavers, laborers tending masons with hot material or where foreign materials are used, mortar mixer operators, multiple concrete duct - leadsman, lumen, asphalt raker, curb asphalt machine operator, ready mix scalemen (permanent, portable or temporary plant), laborers handling masterplate or similar materials, laser beam operator, concrete burning machine operator, coring machine operator, plaster tender, underpinning and shoring of buildings, pump men, manhole and catch basin, dirt and stone tamper, hose men on concrete pumps, hazardous waste worker, lead base paint abatement worker, lining of pipe, refusing machine, assisting on direct boring machine, the work of laying watermain, fire hydrants, all mechanical joints to watermain work, sewer worker, and tapping water service and forced lift station mechanical worker.

OPERATING ENGINEERS - BUILDING (East)

Class 1. Asphalt Plant; Asphalt Spreader; Autograde; Backhoes with Caisson Attachment; Batch Plant; Benoto (requires Two Engineers); Boiler and Throttle Valve; Caisson Rigs; Central Redi-Mix Plant; Combination Back Hoe Front End-loader Machine; Compressor and Throttle Valve; Concrete Breaker (Truck Mounted); Concrete Conveyor; Concrete Paver (over 27E cu. ft.): Concrete Paver (27 cu. ft. and under); Concrete Placer; Concrete Pump (Truck Mounted); Concrete Conveyor (Truck Mounted); Concrete Tower; Cranes, All; GCI and similar types (required two operators only); Cranes, Hammerhead; Creter Crane; Crusher, Stone, etc.; Derricks, All; Derricks, Traveling; Formless Curb and Gutter Machine; Grader, Elevating; Grouting Machines; Highlift Shovels or Front Endloader 2-1/4 yd. and over; Hoists, Elevators, outside type rack and pinion and similar machines; Hoists, one, two and three Drum; Hoists, Two Tugger One Floor; Hydraulic Backhoes; Hydraulic Boom Trucks; Hydro Vac (and similar equipment - excluding hose work and any sewer work); Locomotives, All; Lubrication Technician; Manipulators; Motor Patrol; Pile Drivers and Skid Rig; Post Hole Digger; Pre-Stress Machine; Pump Cretes Dual Ram; Pump Cretes: Squeeze Cretes - Screw Type Pumps, Gypsum Bulker and Pump; Raised and Blind Hole Drill; Rock Drill (self-propelled); Rock Drill - Truck Mounted; Roto Mill Grinder; Scoops - Tractor Drawn; Slipform Paver; Scrapers Prime Movers; Straddle Buggies; Tie Back Machine; Tractor with Boom and Side Boom; Trenching Machines.

Class 2. Bobcat (over 3/4 cu. yd.); Boilers; Brick Forklift; Broom, All Power Propelled; Bulldozers; Concrete Mixer (Two Bag and Over); Conveyor, Portable; Forklift Trucks; Highlift Shovels or Front

Endloaders under 2-1/4 yd.; Hoists, Automatic; Hoists, Sewer Dragging Machine; Hoists, Tugger Single Drum; Laser Screed; Rollers, All; Steam Generators; Tractors, All; Tractor Drawn Vibratory Roller; Winch Trucks with "A" Frame.

Class 3. Air Compressor; Asphalt Spreader; Combination - Small Equipment Operator; Generators; Heaters, Mechanical; Hoists, Inside Elevators - (Rheostat Manual Controlled); Hydraulic Power Units (Pile Driving, Extracting, or Drilling - with a seat); Lowboys; Pumps, Over 3" (1 to 3 not to exceed total of 300 ft.); Pumps, Well Points; Welding Machines (2 through 5); Winches, 4 Small Electric Drill Winches; Bobcat (up to and including 3/4 cu. yd.).

Class 4. Elevator push button with automatic doors; Hoists, Inside; Oilers; Brick Forklift.

Class 5. Assistant Craft Foreman

Class 6. Mechanics; Welders.

Class 7. Gradall

OPERATING ENGINEERS - HIGHWAY CONSTRUCTION (East)

Class 1. Asphalt Plant; Asphalt Heater and Planer Combination; Asphalt Heater Scarfire; Asphalt Silo Tender; Asphalt Spreader; Autograder; ABG Paver; Backhoes with Caisson Attachment; Ballast Regulator; Belt Loader; Caisson Rigs; Car Dumper; Central Redi-Mix Plant; Backhoe w/shear attachments; Combination Backhoe Front Endloader Machine, (1 cu. yd. Backhoe Bucket or over or with attachments); Concrete Breaker (Truck Mounted); Concrete Conveyor; Concrete Paver over 27E cu. ft.; Concrete Placer; Concrete Tube Float; Cranes, all attachments; Cranes, Tower of all types; Creter Crane; Crusher, Stone, etc.; Derricks, All; Derrick Boats; Derricks, Traveling; Directional Boring Machine over 12"; Dredges; Formless Curb and Gutter Machine; Grader, Elevating; Grader, Motor Grader, Motor Patrol, Auto Patrol, Form Grader, Pull Grader, Subgrader; Guard Rail Post Driver Mounted; Hoists, One, Two and Three Drum; Hydraulic Backhoes; Hydro Vac, Self Propelled, Truck Mounted (excluding hose work and any sewer work); Lubrication Technician; Manipulators; Pile Drivers and Skid Rig; Pre-Stress Machine; Pump Cretes Dual Ram; Rock Drill - Crawler or Skid Rig; Rock Drill - Truck Mounted; Rock/Track Tamper; Roto Mill Grinder; Slip-Form Paver; Snow Melters; Soil Test Drill Rig (Truck Mounted); Straddle Buggies; GCI Crane; Hydraulic Telescoping Form (Tunnel); Tie Back Machine; Tractor Drawn Belt Loader; Tractor Drawn Belt Loader with attached pusher; Tractor with Boom; Tractaire with Attachments; Traffic Barrier Conveyor Machine; Raised or Blind Hole Drills; Trenching Machine (over 12"); Truck Mounted Concrete Pump with Boom; Truck Mounted Concrete Conveyor; Work Boat (no license required - 90 h.p. or above); Underground Boring and/or Mining Machines; Wheel Excavator; Widener (APSCO).

Class 2. Batch Plant; Bituminous Mixer; Boiler and Throttle Valve; Bulldozers; Car Loader Trailing Conveyors; Combination Backhoe Front Endloader Machine (less than 1 cu. yd. Backhoe Bucket or over or with attachments); Compressor and Throttle Valve; Compressor, Common Receiver (3); Concrete Breaker or Hydro Hammer; Concrete Grinding Machine; Concrete Mixer or Paver 7S Series to and including 27 cu. ft.; Concrete Spreader; Concrete Curing Machine, Burlap Machine, Belting Machine and Sealing Machine; Concrete Wheel Saw (large self-propelled - excluding walk-behinds and hand-held); Conveyor Muck Cars (Haglund or Similar Type); Drills, all; Finishing Machine - Concrete; Highlift Shovels or Front Endloader; Hoist - Sewer Dragging Machine; Hydraulic Boom Trucks (All Attachments); Hydro Blaster; All

Locomotives, Dinky; Off-Road Hauling Units; Non-Self Loading Dump; Ejection Dump; Pump Cretes: Squeeze Cretes - Screw Type Pumps, Gypsum Bulker and Pump; Roller, Asphalt; Rotary Snow Plows; Rototiller, Seaman, etc., self-propelled; Scoops - Tractor Drawn; Self-Propelled Compactor; Spreader - Chip - Stone, etc.; Scraper; Scraper - Prime Mover in Tandem (Regardless of Size); Tank Car Heater; Tractors, Push, Pulling Sheep's Foot, Disc, Compactor, etc.; Tug Boats.

Class 3. Boilers; Brooms, All Power Propelled; Cement Supply Tender; Compressor, Common Receiver (2); Concrete Mixer (Two Bag and Over); Conveyor, Portable; Farm-Type Tractors Used for Mowing, Seeding, etc.; Fireman on Boilers; Forklift Trucks; Grouting Machine; Hoists, Automatic; Hoists, All Elevators; Hoists, Tugger Single Drum; Jeep Diggers; Low Boys; Pipe Jacking Machines; Post-Hole Digger; Power Saw, Concrete Power Driven; Pug Mills; Rollers, other than asphalt; Seed and Straw Blower; Steam Generators; Stump Machine; Winch Trucks with "A" Frame; Work Boats; Tamper - Form - Motor Driven.

Class 4. Air Compressor - Small and Large; Asphalt Spreader, Backend Man; Bobcat (Skid Steer) all; Brick Forklift; Combination - Small Equipment Operator; Directional Boring Machine up to 12"; Generators; Heaters, Mechanical; Hydraulic Power Unit (Pile Driving, Extracting, or Drilling); Hydro-Blaster; Light Plants, All (1 through 5); Pumps, over 3" (1 to 3 not to exceed a total of 300 ft.); Pumps, Well Points; Tractaire; Trencher 12" and under; Welding Machines (2 through 5); Winches, 4 Small Electric Drill Winches.

Class 5. Oilers and Directional Boring Machine Locator.

Class 6. Field Mechanics and Field Welders

Class 7. Gradall and machines of like nature.

OPERATING ENGINEERS - BUILDING (West)

Class 1. Shovel; Concrete Spreader; Dipper Dredge Operator; Dipper Dredge Crane man; Dual Purpose Truck (boom, Boom, Winch, etc.); Mechanic-Welder; Pile Driver; Boom Tractor or Side Boom; Trenching Machine (40 H.P. and over); Building Hoist (1, 2 or 3 drums); Cleaning and Priming Machine; Backfiller (throw bucket); Locomotive Engineer; Concrete Paver; Slip Form Paver; Caisson Augering Machines; Mucking Machine; Asphalt Heater-Planer Unit; Laser Screed; Pug Mill; Concrete Conveyor or Pump; Mechanical loaded Log Chippers or similar machines; Group Equipment Greaser; Off-Road Haul Units; Pipe Bending; Automatic Curbing Machines; Blastholer; Self-Propelled Rotary Drill or similar machines; Work Boat; Combination Concrete Finishing Machine and Float; Asphalt Paver Screed Operator; Forklift (6,000 lb. cap. or over or working heights 28 ft. and above); Chip Spreader; Straddle Carrier; Asphalt Paver; Asphalt Plant Operator; Boring Machine (Directional, Vertical, or Horizontal); Central Redi-Mix Plant Operator; Combination Backhoe Front End loader; Concrete Breaker or Hydro-Hammer (excluding walk-behinds); Concrete Wheel Saw (Large self-propelled - excluding walk-behinds); Crusher (Stone, Concrete, Asphalt, etc.); Curing-Tinning Machine; Excavator; Farm-type Tractor Operating Scoop or Scraper or with Power Attachment; Grader; Motor Grader; Motor Patrol; Auto Grader; Form Grader; Pull Grader; Sub Grader; Elevating Grader; Guard Rail Post Driver; Hoists; Hydraulic Dredge Leverman or Engineer; Hydro-Vac truck mounted or pull type (excluding hose work), and similar equipment; Loader (Track, Rubber Tire, or Articulated); Milling Machine (excluding walk-behinds); Road Widener-Shoulder Spreader; Scraper (Self-Propelled); Self-Propelled Roller or Tire Roller (on asphalt or Blacktop); Sheep Foot or Pad Foot Compactor (excluding walk-behinds); Steel Track-Type Tractor (Dozer, Push Cat, etc.); Transfer or Shuttle Buggy (excluding motorized wheel barrows and Georgia buggies).

Class 2. Asphalt Booster; Fireman and Pump Operator at Asphalt Plant; Mud Jack; Distributor; Self-propelled Roller (other than provided for in Class I); Pump Operator (more than one well-point pump); Trench Machine (under 40 H.P.); Forklift (less than 6,000 lb. cap. or working heights below 28 ft.); Gypsum Pump; Conveyor over 20 H.P.; Light Plant; Boiler (Engineer or Fireman); Mechanical Broom; Driver on Truck Crane or similar machines; Elevator (Permanent inside or Temporary outside); Farm-Type Tractor (without Power Attachment); Grout Pump (excluding hose work).

Class 3. Skid Loader; Oiler; Mechanic's Helper; Mechanical Heater (other than steam boiler); Small Outboard Motor Boat (Safety Boat and Life Boat); Engine Driven Welding Machine; Water Pumps; Air Compressor (400 c.f.m. or over); Deck Engineers.

Class 4. Leadman - Mechanic or Equipment Greaser.

Class 5. Track Excavator with Bucket (4 cubic yard and up to but not including 6 cubic yard).

Class 6. Track Excavator with Bucket (6 cubic yard and over).

Class 7. Crane (Friction or Hydraulic, regardless of size or attachments); Tow or Push Boat.

OPERATING ENGINEERS- HIGHWAY (West)

Class 1. Shovel; Concrete Spreader; Dipper Dredge Operator; Dipper Dredge Crane man; Dual Purpose Truck (Boom, Winch, etc.); Mechanic-Welder; Pile Driver; Boom Tractor or Side Boom; Building Hoist (1, 2 or 3 drums); Cleaning and Priming Machine; Backfiller (throw bucket); Locomotive Engineer; Concrete Paver; Slip Form Paver; Caisson Augering Machines; Mucking Machine; Asphalt Heater Planer Unit; Laser Screed; Pug Mill; Concrete Conveyor or Pump (excluding truck-mounted); Mechanical loaded Log Chippers or similar machines; Group Equipment Greaser; off-road haul units; Pipe Bending; Automatic Curbing Machines; Blastholer; Self-propelled Rotary Drill or similar machines; Work Boat; Combination Concrete Finishing Machine and Float; Asphalt Paver Screed Operator; Forklift (6,000 lb. cap. or over or working heights above 28 ft.); Chip Spreader; Asphalt Paver; Asphalt Plant Operator; Boring Machine (Directional, Vertical, or Horizontal); Central Redi-Mix Plant Operator; Combination Backhoe Front End loader; Concrete Breaker or Hydro-Hammer (excluding walk-behinds); Concrete Wheel Saw (Large self-propelled - excluding walk-behinds); Crusher (Stone, Concrete, Asphalt, etc.); Curing-Tinning Machine; Excavator; Farm-Type Tractor Operating Scoop or Scraper with Power Attachment; Grader; Motor Grader; Motor Patrol; Auto Grader; Form Grader; Pull Grader; Sub Grader; Elevating Grader; Guard Rail Post Driver; Hoists; Hydraulic Dredge Leverman or Engineer; Hydro-Vac truck mounted or pull type, and similar equipment; Loader (Track, Rubber Tire, or Articulated); Milling Machine (excluding walk-behinds); Road Widener-Shoulder Spreader; Scraper (self-propelled); Self-propelled Roller or Tire Roller (on asphalt or Blacktop); Sheep Foot or Pad Foot Compactor (excluding walk-behinds); Steel Track-Type Tractor (Dozer, Push Cat, etc.); Transfer or Shuttle Buggy (excluding motorized wheel barrows and Georgia buggies); Trenching Machine (40 H.P. and over).

Class 2. Asphalt Booster; Fireman and Pump Operator at Asphalt Plant; Mud Jack; Farm-Type Tractor without Power attachment; Distributor; Straddle Carrier; Self-propelled Roller or Compactor (other than provided for in Class I); Pump Operator (more than one well-point pump); Trench Machine (under 40 H.P.); Forklift (less than 6,000 lb.

capacity or working heights below 28 ft.); Conveyor over 20 H.P.; Air Compressor (400 c.f.m. or over); Light Plant; Boiler (Engineer or Fireman); Mechanical Broom; Driver on Truck Crane or similar machines; Elevator (Permanent inside or Temporary outside); Grout Pump (excluding hose work).

Class 3. Oiler; Mechanic's Helper; Mechanical Heater (other than steam boiler); Small Outboard Motor Boat (Safety Boat and Life Boat); Engine Driven Welding Machine; skid steer.

Class 4. Leadman - Mechanic or Equipment Greaser.

Class 5. Track Excavator with Bucket (4 cubic yard and up to but not including 6 cubic yard).

Class 6. Track Excavator with Bucket (6 cubic yard and over).

Class 7. Truck mounted Concrete Conveyor or Pumps Extending to 90 ft. or more.

Class 8. Crane (Friction or Hydraulic, regardless of size or attachments); Tow or Push Boat.

TRUCK DRIVER - BUILDING, HEAVY AND HIGHWAY CONSTRUCTION

Class 1. Drivers on 2 axle trucks hauling less than 9 ton. Air compressor and welding machines and brooms, including those pulled by separate units, truck driver helpers, warehouse employees, mechanic helpers, greasers and tiremen, pickup trucks when hauling materials, tools, or workers to and from and on-the-job site, and fork lifts up to 6,000 lb. capacity.

Class 2. Two or three axle trucks hauling more than 9 ton but hauling less than 16 ton. A-frame winch trucks, hydrolift trucks, vactor trucks or similar equipment when used for transportation purposes. Fork lifts over 6,000 lb. capacity, winch trucks, four axle combination units, and ticket writers.

Class 3. Two, three or four axle trucks hauling 16 ton or more. Drivers on water pulls, articulated dump trucks, mechanics and working forepersons, and dispatchers. Five axle or more combination units.

Class 4. Low Boy and Oil Distributors.

Class 5. Drivers who require special protective clothing while employed on hazardous waste work.

TRUCK DRIVER - OIL AND CHIP RESEALING ONLY.

This shall encompass laborers, workers and mechanics who drive contractor or subcontractor owned, leased, or hired pickup, dump, service, or oil distributor trucks. The work includes transporting materials and equipment (including but not limited to, oils, aggregate supplies, parts, machinery and tools) to or from the job site; distributing oil or liquid asphalt and aggregate; stock piling material when in connection with the actual oil and chip contract. The Truck Driver (Oil & Chip Resealing) wage classification does not include supplier delivered materials.

Other Classifications of Work:

For definitions of classifications not otherwise set out, the Department generally has on file such definitions which are available. If a task to be performed is not subject to one of the classifications of pay set out, the Department will upon being contacted state which neighboring county has such a classification and provide such rate, such rate being deemed to exist by reference in this document. If no neighboring county rate applies to the task, the Department shall undertake a special determination, such special determination being then deemed to have existed under this determination. If a project requires these, or any classification not listed, please contact IDOL at 217-782-1710 for wage rates or clarifications.

LANDSCAPING

Landscaping work falls under the existing classifications for laborer, operating engineer and truck driver. The work performed by landscape plantsman and landscape laborer is covered by the existing classification of laborer. The work performed by landscape operators (regardless of equipment used or its size) is covered by the classifications of operating engineer. The work performed by landscape truck drivers (regardless of size of truck driven) is covered by the classifications of truck driver.

Will County Prevailing Wage for May 2013

(See explanation of column headings at bottom of wages)

Trade Name	RG	TYP	C	Base	FRMAN	M-F>8	OSA	OSH	H/W	Pensn	Vac	Trng
=====	==	===	=	=====	=====	=====	===	===	=====	=====	=====	=====
ASBESTOS ABT-GEN		ALL		36.200	36.700	1.5	1.5	2.0	12.78	9.020	0.000	0.500
ASBESTOS ABT-MEC		BLD		34.160	36.660	1.5	1.5	2.0	10.82	10.66	0.000	0.720
BOILERMAKER		BLD		43.450	47.360	2.0	2.0	2.0	6.970	14.66	0.000	0.350
BRICK MASON		BLD		40.680	44.750	1.5	1.5	2.0	9.550	12.00	0.000	0.970
CARPENTER		ALL		41.520	45.670	2.0	2.0	2.0	11.19	16.07	0.000	0.530
CEMENT MASON		ALL		41.000	43.000	2.0	2.0	2.0	9.500	14.43	0.000	0.500
CERAMIC TILE FNSHER		BLD		34.440	0.000	2.0	1.5	2.0	9.700	6.930	0.000	0.610
COMMUNICATION TECH		BLD		32.200	33.700	1.5	1.5	2.0	12.32	10.80	0.000	0.320
ELECTRIC PWR EQMT OP		ALL		43.350	48.350	1.5	1.5	2.0	10.38	13.50	0.000	0.430
ELECTRIC PWR GRNDMAN		ALL		33.810	48.350	1.5	1.5	2.0	8.090	10.53	0.000	0.330
ELECTRIC PWR LINEMAN		ALL		43.350	48.350	1.5	1.5	2.0	10.38	13.50	0.000	0.430
ELECTRICIAN		BLD		39.500	43.060	1.5	1.5	2.0	13.17	15.11	0.000	1.200
ELEVATOR CONSTRUCTOR		BLD		49.080	55.215	2.0	2.0	2.0	11.88	12.71	3.930	0.600
GLAZIER		BLD		39.500	41.000	1.5	2.0	2.0	11.99	14.30	0.000	0.840
HT/FROST INSULATOR		BLD		45.550	48.050	1.5	1.5	2.0	10.82	11.86	0.000	0.720
IRON WORKER		ALL		40.250	41.250	2.0	2.0	2.0	9.390	20.41	0.000	0.700
LABORER		ALL		36.200	36.950	1.5	1.5	2.0	12.78	9.020	0.000	0.500
LATHER		ALL		41.520	45.670	2.0	2.0	2.0	11.19	16.07	0.000	0.530
MACHINIST		BLD		43.550	46.050	1.5	1.5	2.0	6.130	8.950	1.850	0.000
MARBLE FINISHERS		ALL		29.700	0.000	1.5	1.5	2.0	9.550	11.75	0.000	0.620
MARBLE MASON		BLD		39.880	43.870	1.5	1.5	2.0	9.550	11.75	0.000	0.730
MATERIAL TESTER I		ALL		26.200	0.000	1.5	1.5	2.0	12.78	9.020	0.000	0.500
MATERIALS TESTER II		ALL		31.200	0.000	1.5	1.5	2.0	12.78	9.020	0.000	0.500
MILLWRIGHT		ALL		41.520	45.670	2.0	2.0	2.0	11.19	16.07	0.000	0.530
OPERATING ENGINEER		BLD 1		45.100	49.100	2.0	2.0	2.0	15.70	10.55	1.900	1.250
OPERATING ENGINEER		BLD 2		43.800	49.100	2.0	2.0	2.0	15.70	10.55	1.900	1.250
OPERATING ENGINEER		BLD 3		41.250	49.100	2.0	2.0	2.0	15.70	10.55	1.900	1.250
OPERATING ENGINEER		BLD 4		39.500	49.100	2.0	2.0	2.0	15.70	10.55	1.900	1.250
OPERATING ENGINEER		BLD 5		48.850	49.100	2.0	2.0	2.0	15.70	10.55	1.900	1.250

OPERATING ENGINEER	BLD	6	46.100	49.100	2.0	2.0	2.0	15.70	10.55	1.900	1.250
OPERATING ENGINEER	BLD	7	48.100	49.100	2.0	2.0	2.0	15.70	10.55	1.900	1.250
OPERATING ENGINEER	FLT	1	51.300	51.300	1.5	1.5	2.0	14.40	9.550	1.900	1.250
OPERATING ENGINEER	FLT	2	49.800	51.300	1.5	1.5	2.0	14.40	9.550	1.900	1.250
OPERATING ENGINEER	FLT	3	44.350	51.300	1.5	1.5	2.0	14.40	9.550	1.900	1.250
OPERATING ENGINEER	FLT	4	36.850	51.300	1.5	1.5	2.0	14.40	9.550	1.900	1.250
OPERATING ENGINEER	FLT	5	52.800	51.300	1.5	1.5	2.0	14.40	9.550	1.900	1.250
OPERATING ENGINEER	HWY	1	43.300	47.300	1.5	1.5	2.0	15.70	10.55	1.900	1.250
OPERATING ENGINEER	HWY	2	42.750	47.300	1.5	1.5	2.0	15.70	10.55	1.900	1.250
OPERATING ENGINEER	HWY	3	40.700	47.300	1.5	1.5	2.0	15.70	10.55	1.900	1.250
OPERATING ENGINEER	HWY	4	39.300	47.300	1.5	1.5	2.0	15.70	10.55	1.900	1.250
OPERATING ENGINEER	HWY	5	38.100	47.300	1.5	1.5	2.0	15.70	10.55	1.900	1.250
OPERATING ENGINEER	HWY	6	46.300	47.300	1.5	1.5	2.0	15.70	10.55	1.900	1.250
OPERATING ENGINEER	HWY	7	44.300	47.300	1.5	1.5	2.0	15.70	10.55	1.900	1.250
PAINTER	ALL		40.000	44.750	1.5	1.5	1.5	9.750	11.10	0.000	0.770
PAINTER SIGNS	BLD		33.920	38.090	1.5	1.5	1.5	2.600	2.710	0.000	0.000
PILEDRIIVER	ALL		41.520	45.670	2.0	2.0	2.0	11.19	16.07	0.000	0.530
PIPEFITTER	BLD		45.050	48.050	1.5	1.5	2.0	8.460	14.85	0.000	1.780
PLASTERER	BLD		40.250	42.670	1.5	1.5	2.0	10.85	10.94	0.000	0.550
PLUMBER	BLD		45.000	47.000	1.5	1.5	2.0	12.53	10.06	0.000	0.880
ROOFER	BLD		38.350	41.350	1.5	1.5	2.0	8.280	8.770	0.000	0.430
SHEETMETAL WORKER	BLD		42.510	44.510	1.5	1.5	2.0	10.04	12.01	0.000	0.780
SPRINKLER FITTER	BLD		49.200	51.200	1.5	1.5	2.0	10.25	8.350	0.000	0.450
STONE MASON	BLD		40.680	44.750	1.5	1.5	2.0	9.550	12.00	0.000	0.970
TERRAZZO FINISHER	BLD		35.510	0.000	1.5	1.5	2.0	9.700	9.320	0.000	0.400
TERRAZZO MASON	BLD		39.370	42.370	1.5	1.5	2.0	9.700	10.66	0.000	0.550
TILE MASON	BLD		41.430	45.430	2.0	1.5	2.0	9.700	8.640	0.000	0.710
TRAFFIC SAFETY WRKR	HWY		28.250	29.850	1.5	1.5	2.0	4.896	4.175	0.000	0.000
TRUCK DRIVER	ALL	1	35.650	36.200	1.5	1.5	2.0	7.250	6.319	0.000	0.250
TRUCK DRIVER	ALL	2	35.800	36.200	1.5	1.5	2.0	7.250	6.319	0.000	0.250
TRUCK DRIVER	ALL	3	36.000	36.200	1.5	1.5	2.0	7.250	6.319	0.000	0.250
TRUCK DRIVER	ALL	4	36.200	36.200	1.5	1.5	2.0	7.250	6.319	0.000	0.250
TUCKPONTER	BLD		40.950	41.950	1.5	1.5	2.0	8.180	10.82	0.000	0.940

Legend :

RG (Region)

TYP (Trade Type - All,Highway,Building,Floating,Oil & Chip,Rivers)

C (Class)

Base (Base Wage Rate)

FRMAN (Foreman Rate)

M-F>8 (OT required for any hour greater than 8 worked each day, Mon through Fri.

OSA (Overtime (OT) is required for every hour worked on Saturday)

OSH (Overtime is required for every hour worked on Sunday and Holidays)

H/W (Health & Welfare Insurance)

Pensn (Pension)

Vac (Vacation)

Trng (Training)

Explanations

WILL COUNTY

The following list is considered as those days for which holiday rates of wages for work performed apply: New Years Day, Memorial Day, Fourth of July, Labor Day, Thanksgiving Day, Christmas Day and Veterans Day in some classifications/counties. Generally, any of these holidays which fall on a Sunday is celebrated on the following Monday. This then makes work performed on that Monday payable at the appropriate overtime rate for holiday pay. Common practice in a given local may alter certain days of celebration. If in doubt, please check with IDOL.

EXPLANATION OF CLASSES

ASBESTOS - GENERAL - removal of asbestos material/mold and hazardous materials from any place in a building, including mechanical systems where those mechanical systems are to be removed. This includes the removal of asbestos materials/mold and hazardous materials from ductwork or pipes in a building when the building is to be demolished at the time or at some close future date.

ASBESTOS - MECHANICAL - removal of asbestos material from mechanical systems, such as pipes, ducts, and boilers, where the mechanical systems are to remain.

CERAMIC TILE FINISHER

The grouting, cleaning, and polishing of all classes of tile, whether for interior or exterior purposes, all burned, glazed or unglazed products; all composition materials, granite tiles, warning detectable tiles, cement tiles, epoxy composite materials, pavers, glass, mosaics, fiberglass, and all substitute materials, for tile made in tile-like units; all mixtures in tile like form of cement, metals, and other materials that are for and intended for use as a finished floor surface, stair treads, promenade roofs, walks, walls, ceilings, swimming pools, and all other places where tile is to form a finished interior or exterior. The mixing of all setting mortars including but not limited to thin-set mortars, epoxies, wall mud, and any other sand and cement mixtures or adhesives when used in the preparation, installation, repair, or maintenance of tile and/or similar materials. The handling and unloading of all sand, cement, lime, tile, fixtures, equipment, adhesives, or any other materials to be used in the preparation, installation, repair, or maintenance of tile and/or similar materials. Ceramic Tile Finishers shall fill all joints and voids regardless of method on all tile work, particularly and especially after installation of said tile work. Application of any and all protective coverings to all types of tile installations including, but not be limited to, all soap compounds, paper products, tapes, and all polyethylene coverings, plywood, masonite, cardboard, and any new type of products that may be used to protect tile installations, Blastrac equipment, and all floor scarifying equipment used in preparing floors to receive tile. The clean up and removal of all waste and materials. All demolition of existing tile floors and walls to be re-tiled.

COMMUNICATIONS TECHNICIAN

Installation, operation, inspection, maintenance, repair and service of radio, television, recording, voice, sound and vision production and reproduction, telephone and telephone interconnect, facsimile, equipment and appliances used for domestic, commercial, educational and entertainment purposes, pulling of wire through conduit but not the installation of conduit.

MARBLE FINISHER

Loading and unloading trucks, distribution of all materials (all stone, sand, etc.), stocking of floors with material, performing all rigging for heavy work, the handling of all material that may be needed for the installation of such materials, building of scaffolding, polishing if needed, patching, waxing of material if damaged, pointing up, caulking, grouting and cleaning of marble, holding water on diamond or Carborundum blade or saw for setters cutting, use of tub saw or any other saw needed for preparation of material, drilling of holes for wires that anchor material set by setters, mixing up of molding plaster for installation of material, mixing up thin set for the installation of material, mixing up of sand to cement for the installation of material and such other work as may be required in helping a Marble Setter in the handling of all material in the erection or installation of interior marble, slate, travertine, art marble, serpentine, alberene stone, blue stone, granite and other stones (meaning as to stone any foreign or domestic materials as are specified and used in building interiors and exteriors and customarily known as stone in the trade), carrara, sanionyx, vitrolite and similar opaque glass and the laying of all marble tile, terrazzo tile, slate tile and precast tile, steps, risers treads, base, or any other materials that may be used as substitutes for any of the aforementioned materials and which are used on interior and exterior which are installed in a similar manner.

MATERIAL TESTER I: Hand coring and drilling for testing of materials; field inspection of uncured concrete and asphalt.

MATERIAL TESTER II: Field inspection of welds, structural steel, fireproofing, masonry, soil, facade, reinforcing steel, formwork, cured concrete, and concrete and asphalt batch plants; adjusting proportions of bituminous mixtures.

OPERATING ENGINEER - BUILDING

Class 1. Asphalt Plant; Asphalt Spreader; Autograde; Backhoes with Caisson Attachment; Batch Plant; Benoto (requires Two Engineers); Boiler and Throttle Valve; Caisson Rigs; Central Redi-Mix Plant; Combination Back Hoe Front End-loader Machine; Compressor and Throttle Valve; Concrete Breaker (Truck Mounted); Concrete Conveyor; Concrete Conveyor (Truck Mounted); Concrete Paver Over 27E cu. ft; Concrete Paver 27E cu. ft. and Under; Concrete Placer; Concrete Placing Boom; Concrete Pump (Truck Mounted); Concrete Tower; Cranes, All; Cranes, Hammerhead; Cranes, (GCI and similar Type); Creter Crane; Spider Crane; Crusher, Stone, etc.; Derricks, All; Derricks, Traveling; Formless Curb and Gutter Machine; Grader, Elevating; Grouting Machines; Heavy Duty Self-Propelled Transporter or Prime Mover; Highlift Shovels or Front Endloader 2-1/4 yd. and over; Hoists, Elevators, outside type rack and pinion and similar machines; Hoists, One, Two and Three Drum; Hoists, Two Tugger One Floor; Hydraulic Backhoes; Hydraulic Boom Trucks; Hydro Vac (and similar equipment); Locomotives, All; Motor Patrol; Lubrication Technician; Manipulators; Pile Drivers and Skid Rig; Post Hole Digger; Pre-Stress Machine; Pump Cretes Dual Ram; Pump Cretes: Squeeze Cretes-Screw Type Pumps; Gypsum Bulker and Pump; Raised and Blind Hole Drill; Roto Mill Grinder; Scoops - Tractor Drawn; Slip-Form Paver; Straddle Buggies; Operation of Tie Back Machine; Tournapull; Tractor with Boom and Side Boom; Trenching Machines.

Class 2. Boilers; Broom, All Power Propelled; Bulldozers; Concrete Mixer (Two Bag and Over); Conveyor, Portable; Forklift Trucks; Highlift Shovels or Front Endloaders under 2-1/4 yd.; Hoists, Automatic; Hoists, Inside Elevators; Hoists, Sewer Dragging Machine;

Hoists, Tugger Single Drum; Laser Screed; Rock Drill (Self-Propelled); Rock Drill (Truck Mounted); Rollers, All; Steam Generators; Tractors, All; Tractor Drawn Vibratory Roller; Winch Trucks with "A" Frame.

Class 3. Air Compressor; Combination Small Equipment Operator; Generators; Heaters, Mechanical; Hoists, Inside Elevators (remodeling or renovation work); Hydraulic Power Units (Pile Driving, Extracting, and Drilling); Pumps, over 3" (1 to 3 not to exceed a total of 300 ft.); Low Boys; Pumps, Well Points; Welding Machines (2 through 5); Winches, 4 Small Electric Drill Winches.

Class 4. Bobcats and/or other Skid Steer Loaders; Oilers; and Brick Forklift.

Class 5. Assistant Craft Foreman.

Class 6. Gradall.

Class 7. Mechanics; Welders.

OPERATING ENGINEERS - HIGHWAY CONSTRUCTION

Class 1. Asphalt Plant; Asphalt Heater and Planer Combination; Asphalt Heater Scarfire; Asphalt Spreader; Autograder/GOMACO or other similar type machines: ABG Paver; Backhoes with Caisson Attachment; Ballast Regulator; Belt Loader; Caisson Rigs; Car Dumper; Central Redi-Mix Plant; Combination Backhoe Front Endloader Machine, (1 cu. yd. Backhoe Bucket or over or with attachments); Concrete Breaker (Truck Mounted); Concrete Conveyor; Concrete Paver over 27E cu. ft.; Concrete Placer; Concrete Tube Float; Cranes, all attachments; Cranes, Tower Cranes of all types: Creter Crane; Spider Crane; Crusher, Stone, etc.; Derricks, All; Derrick Boats; Derricks, Traveling; Dredges; Elevators, Outside type Rack & Pinion and Similar Machines; Formless Curb and Gutter Machine; Grader, Elevating; Grader, Motor Grader, Motor Patrol, Auto Patrol, Form Grader, Pull Grader, Subgrader; Guard Rail Post Driver Truck Mounted; Hoists, One, Two and Three Drum; Heavy Duty Self-Propelled Transporter or Prime Mover; Hydraulic Backhoes; Backhoes with shear attachments up to 40' of boom reach; Lubrication Technician; Manipulators; Mucking Machine; Pile Drivers and Skid Rig; Pre-Stress Machine; Pump Cretes Dual Ram; Rock Drill - Crawler or Skid Rig; Rock Drill - Truck Mounted; Rock/Track Tamper; Roto Mill Grinder; Slip-Form Paver; Snow Melters; Soil Test Drill Rig (Truck Mounted); Straddle Buggies; Hydraulic Telescoping Form (Tunnel); Operation of Tieback Machine; Tractor Drawn Belt Loader; Tractor Drawn Belt Loader (with attached pusher - two engineers); Tractor with Boom; Tractaire with Attachments; Traffic Barrier Transfer Machine; Trenching; Truck Mounted Concrete Pump with Boom; Raised or Blind Hole Drills (Tunnel Shaft); Underground Boring and/or Mining Machines 5 ft. in diameter and over tunnel, etc; Underground Boring and/or Mining Machines under 5 ft. in diameter; Wheel Excavator; Widener (APSCO).

Class 2. Batch Plant; Bituminous Mixer; Boiler and Throttle Valve; Bulldozers; Car Loader Trailing Conveyors; Combination Backhoe Front Endloader Machine (Less than 1 cu. yd. Backhoe Bucket or over or with attachments); Compressor and Throttle Valve; Compressor, Common Receiver (3); Concrete Breaker or Hydro Hammer; Concrete Grinding Machine; Concrete Mixer or Paver 7S Series to and including 27 cu. ft.; Concrete Spreader; Concrete Curing Machine, Burlap Machine, Belting Machine and Sealing Machine; Concrete Wheel Saw; Conveyor Muck Cars (Haglund or Similar Type); Drills, All; Finishing Machine - Concrete; Highlift Shovels or Front Endloader; Hoist - Sewer Dragging Machine; Hydraulic Boom Trucks (All Attachments); Hydro-Blaster; Hydro Excavating (excluding hose work); Laser Screed; All Locomotives, Dinky; Off-Road Hauling Units (including articulating) Non

Self-Loading Ejection Dump; Pump Cretes: Squeeze Cretes - Screw Type Pumps, Gypsum Bulker and Pump; Roller, Asphalt; Rotary Snow Plows; Rototiller, Seaman, etc., self-propelled; Self-Propelled Compactor; Spreader - Chip - Stone, etc.; Scraper - Single/Twin Engine/Push and Pull; Scraper - Prime Mover in Tandem (Regardless of Size); Tractors pulling attachments, Sheeps Foot, Disc, Compactor, etc.; Tug Boats.

Class 3. Boilers; Brooms, All Power Propelled; Cement Supply Tender; Compressor, Common Receiver (2); Concrete Mixer (Two Bag and Over); Conveyor, Portable; Farm-Type Tractors Used for Mowing, Seeding, etc.; Forklift Trucks; Grouting Machine; Hoists, Automatic; Hoists, All Elevators; Hoists, Tugger Single Drum; Jeep Diggers; Low Boys; Pipe Jacking Machines; Post-Hole Digger; Power Saw, Concrete Power Driven; Pug Mills; Rollers, other than Asphalt; Seed and Straw Blower; Steam Generators; Stump Machine; Winch Trucks with "A" Frame; Work Boats; Tamper-Form-Motor Driven.

Class 4. Air Compressor; Combination - Small Equipment Operator; Directional Boring Machine; Generators; Heaters, Mechanical; Hydraulic Power Unit (Pile Driving, Extracting, or Drilling); Light Plants, All (1 through 5); Pumps, over 3" (1 to 3 not to exceed a total of 300 ft.); Pumps, Well Points; Vacuum Trucks (excluding hose work); Welding Machines (2 through 5); Winches, 4 Small Electric Drill Winches.

Class 5. SkidSteer Loader (all); Brick Forklifts; Oilers.

Class 6. Field Mechanics and Field Welders

Class 7. Dowell Machine with Air Compressor; Gradall and machines of like nature.

OPERATING ENGINEER - FLOATING

Class 1. Craft Foreman; Master Mechanic; Diver/Wet Tender; Engineer; Engineer (Hydraulic Dredge).

Class 2. Crane/Backhoe Operator; Boat Operator with towing endorsement; Mechanic/Welder; Assistant Engineer (Hydraulic Dredge); Leverman (Hydraulic Dredge); Diver Tender.

Class 3. Deck Equipment Operator, Machineryman, Maintenance of Crane (over 50 ton capacity) or Backhoe (115,000 lbs. or more); Tug/Launch Operator; Loader/Dozer and like equipment on Barge, Breakwater Wall, Slip/Dock, or Scow, Deck Machinery, etc.

Class 4. Deck Equipment Operator, Machineryman/Fireman (4 Equipment Units or More); Off Road Trucks; Deck Hand, Tug Engineer, Crane Maintenance (50 Ton Capacity and Under) or Backhoe Weighing (115,000 pounds or less); Assistant Tug Operator.

Class 5. Friction or Lattice Boom Cranes.

TRAFFIC SAFETY - work associated with barricades, horses and drums used to reduce lane usage on highway work, the installation and removal of temporary lane markings, and the installation and removal of temporary road signs.

TRUCK DRIVER - BUILDING, HEAVY AND HIGHWAY CONSTRUCTION

Class 1. Two or three Axle Trucks. A-frame Truck when used for transportation purposes; Air Compressors and Welding Machines, including those pulled by cars, pick-up trucks and tractors; Ambulances; Batch Gate Lockers; Batch Hopperman; Car and Truck Washers; Carry-alls; Fork Lifts and Hoisters; Helpers; Mechanics

Helpers and Greasers; Oil Distributors 2-man operation; Pavement Breakers; Pole Trailer, up to 40 feet; Power Mower Tractors; Self-propelled Chip Spreader; Skipman; Slurry Trucks, 2-man operation; Slurry Truck Conveyor Operation, 2 or 3 man; Teamsters; Unskilled Dumpman; and Truck Drivers hauling warning lights, barricades, and portable toilets on the job site.

Class 2. Four axle trucks; Dump Crets and Adgetors under 7 yards; Dumpsters, Track Trucks, Euclids, Hug Bottom Dump Turnapulls or Turnatrailers when pulling other than self-loading equipment or similar equipment under 16 cubic yards; Mixer Trucks under 7 yards; Ready-mix Plant Hopper Operator, and Winch Trucks, 2 Axles.

Class 3. Five axle trucks; Dump Crets and Adgetors 7 yards and over; Dumpsters, Track Trucks, Euclids, Hug Bottom Dump Turnatrailers or turnapulls when pulling other than self-loading equipment or similar equipment over 16 cubic yards; Explosives and/or Fission Material Trucks; Mixer Trucks 7 yards or over; Mobile Cranes while in transit; Oil Distributors, 1-man operation; Pole Trailer, over 40 feet; Pole and Expandable Trailers hauling material over 50 feet long; Slurry trucks, 1-man operation; Winch trucks, 3 axles or more; Mechanic--Truck Welder and Truck Painter.

Class 4. Six axle trucks; Dual-purpose vehicles, such as mounted crane trucks with hoist and accessories; Foreman; Master Mechanic; Self-loading equipment like P.B. and trucks with scoops on the front.

TERRAZZO FINISHER

The handling of sand, cement, marble chips, and all other materials that may be used by the Mosaic Terrazzo Mechanic, and the mixing, grinding, grouting, cleaning and sealing of all Marble, Mosaic, and Terrazzo work, floors, base, stairs, and wainscoting by hand or machine, and in addition, assisting and aiding Marble, Masonic, and Terrazzo Mechanics.

Other Classifications of Work:

For definitions of classifications not otherwise set out, the Department generally has on file such definitions which are available. If a task to be performed is not subject to one of the classifications of pay set out, the Department will upon being contacted state which neighboring county has such a classification and provide such rate, such rate being deemed to exist by reference in this document. If no neighboring county rate applies to the task, the Department shall undertake a special determination, such special determination being then deemed to have existed under this determination. If a project requires these, or any classification not listed, please contact IDOL at 217-782-1710 for wage rates or clarifications.

LANDSCAPING

Landscaping work falls under the existing classifications for laborer, operating engineer and truck driver. The work performed by landscape plantsman and landscape laborer is covered by the existing classification of laborer. The work performed by landscape operators (regardless of equipment used or its size) is covered by the classifications of operating engineer. The work performed by landscape truck drivers (regardless of size of truck driven) is covered by the classifications of truck driver.

Williamson County Prevailing Wage for May 2013

(See explanation of column headings at bottom of wages)

Trade Name	RG	TYP	C	Base	FRMAN	M-F>8	OSA	OSH	H/W	Pensn	Vac	Trng
=====	==	===	=	=====	=====	=====	===	===	=====	=====	=====	=====
ASBESTOS ABT-GEN		ALL		25.300	25.750	1.5	1.5	2.0	5.750	10.35	0.000	0.900
ASBESTOS ABT-MEC		BLD		21.150	22.150	1.5	1.5	2.0	6.400	5.150	0.000	0.650
BOILERMAKER		BLD		31.500	34.000	1.5	1.5	2.0	7.070	18.73	1.000	0.350
BRICK MASON		BLD		28.620	30.120	1.5	1.5	2.0	8.200	7.030	0.000	0.430
CARPENTER		BLD		31.890	33.390	1.5	1.5	2.0	6.550	6.750	0.000	0.400
CARPENTER		HWY		31.840	33.340	1.5	1.5	2.0	6.550	6.750	0.000	0.400
CEMENT MASON		BLD		28.200	29.700	1.5	1.5	2.0	6.600	5.400	0.000	0.500
CEMENT MASON		HWY		27.290	28.290	1.5	1.5	2.0	6.600	5.160	0.000	0.400
CERAMIC TILE FNSHER		BLD		27.120	0.000	1.5	1.5	2.0	8.200	7.030	0.000	0.430
ELECTRIC PWR EQMT OP		ALL	1	35.570	0.000	1.5	1.5	2.0	5.000	9.960	0.000	0.360
ELECTRIC PWR EQMT OP		ALL	2	31.740	0.000	1.5	1.5	2.0	5.000	8.880	0.000	0.320
ELECTRIC PWR GRNDMAN		ALL		26.100	0.000	1.5	1.5	2.0	5.000	7.310	0.000	0.260
ELECTRIC PWR LINEMAN		ALL		44.630	47.650	1.5	1.5	2.0	5.000	12.50	0.000	0.450
ELECTRICIAN		ALL		39.350	41.600	1.5	1.5	2.0	6.140	9.440	0.000	0.790
ELECTRONIC SYS TECH		BLD		32.570	34.320	1.5	1.5	2.0	6.000	4.240	0.000	0.400
FLOOR LAYER		BLD		29.330	30.080	1.5	1.5	2.0	6.550	6.750	0.000	0.400
GLAZIER		BLD		26.780	28.030	1.5	1.5	2.0	6.120	5.200	0.000	0.300
HT/FROST INSULATOR		BLD		29.450	30.450	1.5	1.5	2.0	5.050	9.730	0.000	0.280
IRON WORKER		ALL		27.730	29.730	1.5	1.5	2.0	7.010	11.41	0.000	0.500
LABORER		BLD		25.300	25.750	1.5	1.5	2.0	5.750	10.35	0.000	0.800
LABORER		HWY		25.300	25.750	1.5	1.5	2.0	5.750	10.35	0.000	0.800
LABORER		O&C		17.740	18.190	1.5	1.5	2.0	5.450	8.450	0.000	0.800
MACHINIST		BLD		43.550	46.050	1.5	1.5	2.0	6.130	8.950	1.850	0.000
MARBLE FINISHERS		BLD		27.120	0.000	1.5	1.5	2.0	8.200	7.030	0.000	0.430
MARBLE MASON		BLD		28.620	30.120	1.5	1.5	2.0	8.200	7.030	0.000	0.430
MILLWRIGHT		BLD		31.890	33.390	1.5	1.5	2.0	6.550	6.750	0.000	0.400
MILLWRIGHT		HWY		31.840	33.340	1.5	1.5	2.0	6.550	6.750	0.000	0.400
OE RIVER 1		RIV	1	33.550	34.550	1.5	1.5	2.0	7.000	8.800	0.000	1.450
OE RIVER 2		RIV	2	30.100	34.550	1.5	1.5	2.0	7.000	8.800	0.000	1.450
OPERATING ENGINEER		ALL	1	33.450	34.450	1.5	1.5	2.0	7.000	8.800	0.000	1.450
OPERATING ENGINEER		ALL	2	31.550	34.450	1.5	1.5	2.0	7.000	8.800	0.000	1.450
OPERATING ENGINEER		ALL	3	24.150	34.450	1.5	1.5	2.0	7.000	8.800	0.000	1.450
OPERATING ENGINEER		ALL	4	21.400	27.800	1.5	1.5	2.0	5.650	6.100	0.000	1.100
OPERATING ENGINEER		O&C	1	25.090	26.090	1.5	1.5	2.0	7.000	8.800	0.000	1.450
OPERATING ENGINEER		O&C	2	23.660	26.090	1.5	1.5	2.0	7.000	8.800	0.000	1.450
OPERATING ENGINEER		O&C	3	18.120	26.090	1.5	1.5	2.0	7.000	8.800	0.000	1.450
OPERATING ENGINEER		O&C	4	16.050	21.100	1.5	1.5	2.0	5.650	6.100	0.000	1.100
PAINTER		BLD		26.260	27.760	1.5	1.5	2.0	6.630	7.070	0.000	0.500
PAINTER		HWY		30.560	32.060	1.5	1.5	2.0	6.630	7.070	0.000	0.500
PAINTER OVER 30FT		BLD		27.260	28.760	1.5	1.5	2.0	6.630	7.070	0.000	0.500
PAINTER PWR EQMT		BLD		27.260	28.760	1.5	1.5	2.0	6.630	7.070	0.000	0.500
PAINTER PWR EQMT		HWY		31.560	33.060	1.5	1.5	2.0	6.630	7.070	0.000	0.500
PILEDRIIVER		BLD		31.890	33.390	1.5	1.5	2.0	6.550	6.750	0.000	0.400
PILEDRIIVER		HWY		31.840	33.340	1.5	1.5	2.0	6.550	6.750	0.000	0.400
PIPEFITTER		BLD		37.000	40.700	1.5	1.5	2.0	8.500	9.300	0.000	1.350
PLASTERER		BLD		28.200	29.700	1.5	1.5	2.0	6.600	5.400	0.000	0.500
PLUMBER		BLD		37.000	40.700	1.5	1.5	2.0	8.500	9.300	0.000	1.350
ROOFER		BLD		23.900	24.900	1.5	1.5	2.0	8.650	3.800	0.000	0.000
SHEETMETAL WORKER		ALL		31.690	33.190	1.5	1.5	2.0	7.130	6.730	1.910	0.360
SPRINKLER FITTER		BLD		36.390	39.140	1.5	1.5	2.0	8.420	8.500	0.000	0.450
STONE MASON		BLD		28.620	30.120	1.5	1.5	2.0	8.200	7.030	0.000	0.430
TERRAZZO FINISHER		BLD		27.120	0.000	1.5	1.5	2.0	8.200	7.030	0.000	0.430
TERRAZZO MASON		BLD		28.620	30.120	1.5	1.5	2.0	8.200	7.030	0.000	0.430
TRUCK DRIVER		ALL	1	30.070	0.000	1.5	1.5	2.0	10.30	6.100	0.000	0.250
TRUCK DRIVER		ALL	2	30.520	0.000	1.5	1.5	2.0	10.30	6.100	0.000	0.250
TRUCK DRIVER		ALL	3	30.740	0.000	1.5	1.5	2.0	10.30	6.100	0.000	0.250
TRUCK DRIVER		ALL	4	31.030	0.000	1.5	1.5	2.0	10.30	6.100	0.000	0.250
TRUCK DRIVER		ALL	5	31.850	0.000	1.5	1.5	2.0	10.30	6.100	0.000	0.250
TRUCK DRIVER		O&C	1	22.750	0.000	1.5	1.5	2.0	2.920	6.700	0.000	0.250
TRUCK DRIVER		O&C	2	19.150	0.000	1.5	1.5	2.0	2.920	6.700	0.000	0.250
TRUCK DRIVER		O&C	3	19.650	0.000	1.5	1.5	2.0	2.920	6.700	0.000	0.250
TUCKPOINTER		BLD		28.620	30.120	1.5	1.5	2.0	8.200	7.030	0.000	0.430

Legend :

RG (Region)

TYP (Trade Type - All,Highway,Building,Floating,Oil & Chip,Rivers)

C (Class)

Base (Base Wage Rate)

FRMAN (Foreman Rate)

M-F>8 (OT required for any hour greater than 8 worked each day, Mon through Fri.

OSA (Overtime (OT) is required for every hour worked on Saturday)

OSH (Overtime is required for every hour worked on Sunday and Holidays)

H/W (Health & Welfare Insurance)

Pensn (Pension)

Vac (Vacation)

Trng (Training)

Explanations

WILLIAMSON COUNTY

The following list is considered as those days for which holiday rates of wages for work performed apply: New Years Day, Memorial Day, Fourth of July, Labor Day, Thanksgiving Day, Christmas Day and Veterans Day in some classifications/counties. Generally, any of these holidays which fall on a Sunday is celebrated on the following Monday. This then makes work performed on that Monday payable at the appropriate overtime rate for holiday pay. Common practice in a given local may alter certain days of celebration. If in doubt, please check with IDOL.

Oil and chip resealing (O&C) means the application of road oils and liquid asphalt to coat an existing road surface, followed by application of aggregate chips or gravel to coated surface, and subsequent rolling of material to seal the surface.

EXPLANATION OF CLASSES

ASBESTOS - GENERAL - removal of asbestos material/mold and hazardous materials from any place in a building, including mechanical systems where those mechanical systems are to be removed. This includes the removal of asbestos materials/mold and hazardous materials from ductwork or pipes in a building when the building is to be demolished at the time or at some close future date.

ASBESTOS - MECHANICAL - removal of asbestos material from mechanical systems, such as pipes, ducts, and boilers, where the mechanical systems are to remain.

LABORER - OIL AND CHIP RESEALING ONLY

Hook and unhook chip box from aggregate truck; distribute material within chip box; perform flagging work related to oil and chip resealing; hand spray oil fluids; handle traffic control, including setting-up and maintaining barricades, drums, cones, delineators, signs and other such items, as well as laying-out and applying or removing temporary roadway markings used to control traffic in job site related to oil and chip resealing; and perform clean-up related to oil and chip resealing.

CERAMIC TILE FINISHER, MARBLE FINISHER, TERRAZZO FINISHER

Assisting, helping or supporting the tile, marble and terrazzo mechanic by performing their historic and traditional work assignments required to complete the proper installation of the work covered by said crafts. The term "Ceramic" is used for naming the classification only, and is in no a limitation of the product handled. Ceramic takes into consideration most hard tiles.

ELECTRIC POWER LINEMAN

Construction, maintenance and dismantling of overhead and underground electric power lines, including high voltage pipe type cable work, and associated structures and equipment.

ELECTRIC POWER EQUIPMENT OPERATOR - CLASS 1

Operation of all crawler type equipment D-4 and larger from the ground to assist the Electric Power Linemen in performing their duties.

ELECTRIC POWER EQUIPMENT OPERATORS - CLASS 2

Operation of all other equipment from the ground to assist the Electric Power Linemen in performing their duties.

ELECTRIC POWER GROUNDMAN

Applies to workers who assist the Electric Power Lineman from the ground.

ELECTRONIC SYSTEMS TECHNICIAN

Installation, service and maintenance of low-voltage systems which utilizes the transmission and/or transference of voice, sound, vision, or digital for commercial, education, security and entertainment purposes for the following: TV monitoring and surveillance, background/foreground music, intercom and telephone interconnect, field programming, inventory control systems, microwave transmission, multi-media, multiplex, radio page, school, intercom and sound burglar alarms and low voltage master clock systems.

Excluded from this classification are energy management systems, life safety systems, supervisory controls and data acquisition systems not intrinsic with the above listed systems, fire alarm systems, nurse call systems and raceways exceeding fifteen feet in length.

TRUCK DRIVER - BUILDING, HEAVY AND HIGHWAY CONSTRUCTION

Class 1. Drivers on 2 axle trucks hauling less than 9 ton. Air compressor and welding machines and brooms, including those pulled by separate units, truck driver helpers, warehouse employees, mechanic helpers, greasers and tiremen, pickup trucks when hauling materials, tools, or workers to and from and on-the-job site, and fork lifts up to 6,000 lb. capacity.

Class 2. Two or three axle trucks hauling more than 9 ton but hauling less than 16 ton. A-frame winch trucks, hydrolift trucks, vactor trucks or similar equipment when used for transportation purposes. Fork lifts over 6,000 lb. capacity, winch trucks, four axle combination units, and ticket writers.

Class 3. Two, three or four axle trucks hauling 16 ton or more. Drivers on water pulls, articulated dump trucks, mechanics and working forepersons, and dispatchers. Five axle or more combination units.

Class 4. Low Boy and Oil Distributors.

Class 5. Drivers who require special protective clothing while employed on hazardous waste work.

TRUCK DRIVER - O & C (Oil and Chip Resealing ONLY)

It involves driving of contractor or subcontractor owned, leased, or hired pickup, dump, service, or oil distributor trucks. Includes transporting materials and equipment (including, but not limited to oils, aggregate supplies, parts, machinery and tools) to or from the job site; distributing oil or liquid asphalt and aggregate; stock piling material; and maintaining trucks at job site related to oil and chip resealing.

Class 1. Distributors, liquid asphalt hauling and hauling of asphalt rubber-tired rollers.

Class 2. Stockpiling.

Class 3. Tandem hauling to job site.

OPERATING ENGINEERS - BUILDING, HEAVY AND HIGHWAY CONSTRUCTION

Class 1. APSCO or Equal Spreading Machine, Backhoe, Backfiller, Boom or Winch Cat, Bituminous Mixplane Machine, Blacksmith, Bituminous Surfacing Machine, Bull-Dozer, Crane, Shovel, Dragline, Truck Crane, Pile Driver, Concrete Breaker, Concrete or Pumpcrete Pumps, Dinky or Standard Locomotives, Well or Caisson Drills, Elevating Grader, Fork Lifts, Flexplane, Gradeall, Hi-Lift Hoists, Guy-Derricks, Hysters, Mechanic Motor Patrol, Mixers-21 cu. ft. or over, Push Cats, Pulls and Scrapers, Two Well Point Pumps, Pulverizer or Tiller, PugMill, Rubber-Tired Farm Type Tractor with Bulldozer/Blade/Auger or hi-lift over 1/2 yd., Jersey Spreader, Tract-Air used with Drill or Hi-Lift, Trenching or Ditching Machines, Wood Chipper w/Tractor, Self-Propelled Roller w/Blade, Equipment Greaser, Self-Propelled Bump Grinder on Concrete pavement, Boat Operator, Skid-Loaders, Tuggers, Lazer Screed, and Self-Propelled Chip Spreader (when others run conveyors).

Class 2. Any type tractor pulling any type roller or disc, Two Air Compressors (220 cu. ft. capacity or over), Two AirTract Drills, Air-Track Drill w/Compressor, Automatic Bins or Scales w/Compressor or Generator, Pipeline Boring Machine, Bulk Cement Plant w/Separate Compressor, Power Operated Bull Float, Hydra-Lift w/Single Motor, Straw Mulcher Blower w/Spout, Self-Propelled Roller/Compactor, Back-End man on Bituminous Surfacing Machine, oiler on milling machine.

Class 3. Air Compressor w/Valve driving piling, Boom or Winch Type Truck, Two Conveyors, Self-Propelled Concrete Saw, Form Grader, Truck Crane Oiler, Self-Propelled Vibrator, Rubber Tired Farm Type Tractor w/Blade/Bulldozer/Auger/hi-lift - 1/2 yd. or less, Elevator Operator, Man Lift (scissor lift) when lifting materials.

Class 4. Air-Track Drill (one), Belt Drag Machine, Power Broom, Mechanical Plasterer Applicator, Trac-Air, Air Compressor (220 cu. ft.

or over) One, Air Compressor (under 220 cu. ft) four, Automatic Bin, Bulk Cement Plant w/Built-in Compressor running off same motor or electric motor, Fireman or Switchman, Self-Propelled Form Tamper, Light Plants (4), Welding Machines (4), Pumps (4), or Combination of four (4) Pumps, Light Plants, Welding Machines, Air-Compressors (under 220 cu. ft.), Mudjacks or Wood Chipper, Mixers - less than 21 cu. ft. Mortar Mixer w/Skip or Pump, Pipeline Tract Jack. One Operating Engineer may operate and maintain any combination of the following pieces of equipment, not to exceed four (4) which shall be within a reasonable distance, such combination may include any equipment in this classification: (Compressors, Light Plants, Generators, Welding Machines, Pumps or Conveyors), One Well- Point Pump, Two Motor Driven Heaters, One Air Compressor (under 220 cu. ft.), One Engine-Driven Conveyor, One Motor Driven Heater, One Light Plant, One Pump, One Welding Machine, One Ulmac or Equal Spreader, Oilers, and one Generator 10 kw or greater.

OPERATING ENGINEER - O & C (Oil and Chip Resealing ONLY). Includes the operation of all motorized heavy equipment used in oil and chip rsealing, including but not limited to operating self-propelled chip spreaders, and all types of rollers (both hard and rubber tired); and other duties pertaining to the operation or maintenance of heavy equipment related to oil and chip resealing.

- Class 1. See Class 1 above for types of equipment operated.
- Class 2. See Class 2 above for types of equipment operated.
- Class 3. See Class 3 above for types of equipment operated.
- Class 4. See Class 4 above for types of equipment operated.

OPERATING ENGINEER RIVER WORK 1 - operate the following machines when working on River Work and Levee Work on the Mississippi and Ohio Rivers, Lakes and Tributaries: Crane, Shovel, Drageline, Scrapers, Dredge, Derrick, Pile-Driver, Push Boat, all power boat operators, Mechanic, Engineman on Dredge, Leverman on Dredge, All Bituminous Spreader machines, Backhoe, Backfiller, Boom, or Winch Cat, Bituminous Mixplane Machine, Blacksmith, Bituminous Surfacing Machine, Bulldozer, Truck Cranes, Hydraulic Truck Mounted Boom/Crane, Concrete Finishing Machine, or Spreader Machine, Concrete Breaker, Concrete or Pumpcrete Machines, Concrete Plant Operator, All Off Road Material Hauling Equipment, Dinky or Standard Locomotives, Well Drill, Elevating Grader, Fork-Lifts, Flexplane, Gradeall, Hi-Lift, Power Handblade Tugger type Hoist, Hoist Two Drum (or over one), Guyderrick, Hyster, Motor Patrol, Mixers - 21 Cu. Ft. or over, Push Cat, Pulls, & Scrapers, Pumps-Two Well Points, Equipment Greaser, P & H Pulverizer or Pulverizer equal to Pugmill, Pugmill, Rubber-Tired farm type tractor w/Bulldozer/Blade/Auger or Hi-Lift over ½ yard, Skimmer Scoops, Seaman Tiller, Jersey Spreader, Tract-Air used with Drill or Hi-Lift, Trenching or Ditching Machine, Wood Chipper w/Tractor, self-propelled roller w/Blade, Concrete Pumps and Small Equipment Operators.

OPERATING ENGINEER RIVER 2 - when working on River Work and Levee Work on the Mississippi and Ohio Rivers, Lakes and Tributaries shall be employed as the Oiler or Fireman on Crane, Dragline, Shovel, Dredge, Truck Crane, Pile Driver, Gradeall, Dinky or Standard Locomotive, Guy Derrick, Trenching Machine or Ditching Machine 80 H.P. and over, All Terrain (cherry-picker) with over 40 ton Lifting Capacity, Deck Oiler and Deckhands.

Other Classifications of Work:

For definitions of classifications not otherwise set out, the Department generally has on file such definitions which are available. If a task to be performed is not subject to one of the

classifications of pay set out, the Department will upon being contacted state which neighboring county has such a classification and provide such rate, such rate being deemed to exist by reference in this document. If no neighboring county rate applies to the task, the Department shall undertake a special determination, such special determination being then deemed to have existed under this determination. If a project requires these, or any classification not listed, please contact IDOL at 217-782-1710 for wage rates or clarifications.

LANDSCAPING

Landscaping work falls under the existing classifications for laborer, operating engineer and truck driver. The work performed by landscape plantsman and landscape laborer is covered by the existing classification of laborer. The work performed by landscape operators (regardless of equipment used or its size) is covered by the classifications of operating engineer. The work performed by landscape truck drivers (regardless of size of truck driven) is covered by the classifications of truck driver.

Winnebago County Prevailing Wage for May 2013

(See explanation of column headings at bottom of wages)

Trade Name	RG	TYP	C	Base	FRMAN	M-F>8	OSA	OSH	H/W	Pensn	Vac	Trng
ASBESTOS ABT-GEN		BLD		29.580	30.580	1.5	1.5	2.0	8.240	12.32	0.000	0.800
ASBESTOS ABT-MEC		BLD		18.950	0.000	1.5	1.5	2.0	2.700	3.350	0.000	0.000
BOILERMAKER		BLD		43.450	47.360	2.0	2.0	2.0	6.970	14.66	0.000	0.350
BRICK MASON		BLD		35.880	38.630	1.5	1.5	2.0	7.950	11.73	0.000	0.600
CARPENTER		BLD		36.320	40.320	1.5	1.5	2.0	7.700	11.25	0.000	0.600
CARPENTER		HWY		39.830	41.580	1.5	1.5	2.0	7.700	9.000	0.000	0.490
CEMENT MASON		ALL		34.820	37.570	1.5	1.5	2.0	8.150	11.45	0.000	0.500
CERAMIC TILE FNSHER		BLD		32.410	0.000	1.5	1.5	2.0	7.700	4.840	0.000	0.530
COMMUNICATION TECH		BLD		36.000	39.600	1.5	1.5	2.0	10.14	11.20	0.000	0.720
ELECTRIC PWR EQMT OP		ALL		36.610	49.750	1.5	1.5	2.0	5.000	11.35	0.000	0.270
ELECTRIC PWR GRNDMAN		ALL		28.310	49.750	1.5	1.5	2.0	5.000	8.780	0.000	0.210
ELECTRIC PWR LINEMAN		ALL		43.830	49.750	1.5	1.5	2.0	5.000	13.58	0.000	0.330
ELECTRIC PWR TRK DRV		ALL		29.310	49.750	1.5	1.5	2.0	5.000	9.090	0.000	0.220
ELECTRICIAN		BLD		40.000	44.000	1.5	1.5	2.0	10.14	16.93	0.000	0.800
ELEVATOR CONSTRUCTOR		BLD		45.350	51.020	2.0	2.0	2.0	11.88	12.71	3.630	0.600
GLAZIER		BLD		34.730	35.730	1.5	1.5	2.0	9.700	8.200	0.000	1.250
HT/FROST INSULATOR		BLD		33.930	36.470	1.5	1.5	2.0	7.450	14.77	0.000	0.000
IRON WORKER		ALL		35.090	36.840	2.0	2.0	2.0	8.250	20.59	0.000	0.700
LABORER		BLD		29.580	30.580	1.5	1.5	2.0	8.240	12.32	0.000	0.800
LABORER		HWY		31.950	32.700	1.5	1.5	2.0	8.240	12.50	0.000	0.800
LABORER, SKILLED		HWY		34.250	35.000	1.5	1.5	2.0	8.240	12.50	0.000	0.800
LATHER		BLD		36.320	40.320	1.5	1.5	2.0	7.700	11.25	0.000	0.600
MACHINIST		BLD		43.550	46.050	1.5	1.5	2.0	6.130	8.950	1.850	0.000
MARBLE FINISHERS		BLD		32.410	0.000	1.5	1.5	2.0	7.700	4.840	0.000	0.530
MARBLE MASON		BLD		35.090	35.340	1.5	1.5	2.0	7.700	7.150	0.000	0.560
MATERIAL TESTER I		ALL		21.550	0.000	1.5	1.5	2.0	7.460	4.840	0.000	0.170
MATERIALS TESTER II		ALL		26.550	0.000	1.5	1.5	2.0	7.460	4.840	0.000	0.170
MILLWRIGHT		BLD		35.000	38.500	1.5	1.5	2.0	7.700	13.87	0.000	0.500
OPERATING ENGINEER		BLD	1	40.800	44.850	2.0	2.0	2.0	15.85	9.800	2.350	1.300
OPERATING ENGINEER		BLD	2	40.100	44.850	2.0	2.0	2.0	15.85	9.800	2.350	1.300
OPERATING ENGINEER		BLD	3	37.650	44.850	2.0	2.0	2.0	15.85	9.800	2.350	1.300
OPERATING ENGINEER		BLD	4	35.650	44.850	2.0	2.0	2.0	15.85	9.800	2.350	1.300
OPERATING ENGINEER		BLD	5	44.600	44.850	2.0	2.0	2.0	15.85	9.800	2.350	1.300
OPERATING ENGINEER		BLD	6	43.350	44.850	2.0	2.0	2.0	15.85	9.800	2.350	1.300
OPERATING ENGINEER		BLD	7	40.350	44.850	2.0	2.0	2.0	15.85	9.800	2.350	1.300
OPERATING ENGINEER		HWY	1	40.650	44.700	1.5	1.5	2.0	15.85	9.800	2.350	1.300
OPERATING ENGINEER		HWY	2	40.100	44.700	1.5	1.5	2.0	15.85	9.800	2.350	1.300

OPERATING ENGINEER	HWY	3	38.800	44.700	1.5	1.5	2.0	15.85	9.800	2.350	1.300
OPERATING ENGINEER	HWY	4	37.350	44.700	1.5	1.5	2.0	15.85	9.800	2.350	1.300
OPERATING ENGINEER	HWY	5	35.900	44.700	1.5	1.5	2.0	15.85	9.800	2.350	1.300
OPERATING ENGINEER	HWY	6	43.700	44.700	1.5	1.5	2.0	15.85	9.800	2.350	1.300
OPERATING ENGINEER	HWY	7	41.700	44.700	1.5	1.5	2.0	15.85	9.800	2.350	1.300
PAINTER	ALL		35.700	37.700	1.5	1.5	1.5	9.650	8.460	0.000	1.250
PILEDRIVER	BLD		37.320	41.430	1.5	1.5	2.0	7.700	11.25	0.000	0.600
PILEDRIVER	HWY		39.830	41.580	1.5	1.5	2.0	7.700	9.000	0.000	0.490
PIPEFITTER	BLD		40.600	43.440	1.5	1.5	2.0	7.980	10.79	0.000	1.000
PLASTERER	BLD		33.360	36.700	1.5	1.5	2.0	8.150	11.05	0.000	0.500
PLUMBER	BLD		40.600	43.440	1.5	1.5	2.0	7.980	10.79	0.000	1.000
ROOFER	BLD		38.350	41.350	1.5	1.5	2.0	8.280	8.770	0.000	0.430
SHEETMETAL WORKER	BLD		35.780	37.710	1.5	1.5	2.0	5.450	15.44	0.520	0.290
SPRINKLER FITTER	BLD		36.390	39.140	1.5	1.5	2.0	8.420	8.500	0.000	0.450
STONE MASON	BLD		35.880	38.630	1.5	1.5	2.0	7.950	11.73	0.000	0.600
TERRAZZO FINISHER	BLD		32.410	0.000	1.5	1.5	2.0	7.700	4.840	0.000	0.530
TERRAZZO MASON	BLD		35.090	35.340	1.5	1.5	2.0	7.700	7.150	0.000	0.560
TILE LAYER	BLD		36.320	40.320	1.5	1.5	2.0	7.700	11.25	0.000	0.600
TILE MASON	BLD		35.090	35.340	1.5	1.5	2.0	7.700	7.150	0.000	0.560
TRUCK DRIVER	ALL	1	32.960	33.420	1.5	1.5	2.0	6.900	8.220	0.000	0.000
TRUCK DRIVER	ALL	2	33.110	33.420	1.5	1.5	2.0	6.900	8.220	0.000	0.000
TRUCK DRIVER	ALL	3	33.310	33.420	1.5	1.5	2.0	6.900	8.220	0.000	0.000
TRUCK DRIVER	ALL	4	33.420	33.420	1.5	1.5	2.0	6.900	8.220	0.000	0.000
TUCKPOINTER	BLD		35.880	38.630	1.5	1.5	2.0	7.950	11.73	0.000	0.600

Legend :

RG (Region)

TYP (Trade Type - All,Highway,Building,Floating,Oil & Chip,Rivers)

C (Class)

Base (Base Wage Rate)

FRMAN (Foreman Rate)

M-F>8 (OT required for any hour greater than 8 worked each day, Mon through Fri.)

OSA (Overtime (OT) is required for every hour worked on Saturday)

OSH (Overtime is required for every hour worked on Sunday and Holidays)

H/W (Health & Welfare Insurance)

Pensn (Pension)

Vac (Vacation)

Trng (Training)

Explanations

WINNEBAGO COUNTY

The following list is considered as those days for which holiday rates of wages for work performed apply: New Years Day, Memorial Day, Fourth of July, Labor Day, Thanksgiving Day, Christmas Day and Veterans Day in some classifications/counties. Generally, any of these holidays which fall on a Sunday is celebrated on the following Monday. This then makes work performed on that Monday payable at the

appropriate overtime rate for holiday pay. Common practice in a given local may alter certain days of celebration. If in doubt, please check with IDOL.

EXPLANATION OF CLASSES

ASBESTOS - GENERAL - removal of asbestos material/mold and hazardous materials from any place in a building, including mechanical systems where those mechanical systems are to be removed. This includes the removal of asbestos materials/mold and hazardous materials from ductwork or pipes in a building when the building is to be demolished at the time or at some close future date.

ASBESTOS - MECHANICAL - removal of asbestos material from mechanical systems, such as pipes, ducts, and boilers, where the mechanical systems are to remain.

CERAMIC TILE FINISHER, MARBLE FINISHER, TERRAZZO FINISHER

Assisting, helping or supporting the tile, marble and terrazzo mechanic by performing their historic and traditional work assignments required to complete the proper installation of the work covered by said crafts. The term "Ceramic" is used for naming the classification only and is in no way a limitation of the product handled. Ceramic takes into consideration most hard tiles.

COMMUNICATIONS TECHNICIAN

Installing, manufacturing, assembling and maintaining sound and intercom, protection alarm (security), fire alarm, master antenna television, closed circuit television, low voltage control for computers and/or door monitoring, school communications systems, telephones and servicing of nurse and emergency calls, and the installation and maintenance of transmit and receive antennas, transmitters, receivers, and associated apparatus which operates in conjunction with above systems. All work associated with these system installations will be included EXCEPT the installation of protective metallic conduit in new construction projects (excluding less than ten-foot, runs strictly for protection of cable) and 120 volt AC (or higher) power wiring and associated hardware.

LABORER, SKILLED - HIGHWAY

Individuals engaged in the following types of work, irrespective of the site of the work: asbestos abatement worker, handling of any materials with any foreign matter harmful to skin or clothing, track laborer, cement handlers, chloride handlers, the unloading and loading with steel workers and re-bars, concrete workers wet, tunnel helpers in free air, batch dumpers, mason tenders, kettle and tar men, tank cleaners, plastic installers, scaffold workers, motorized buggies or motorized unit used for wet concrete or handling of building materials, laborers with de-watering systems, sewer workers plus depth, rod and chainmen with technical engineers, rod and chainmen with land surveyors, rod and chainmen with surveyors, vibrator operators, cement silica, clay, fly ash, lime and plasters, handlers (bulk or bag), cofferdam workers plus depth, on concrete paving, placing, cutting and tying of reinforcing, deck hand, dredge hand, and shore laborers, bankmen on floating plant, grade checker, power tools, front end man on chip spreaders, cession workers plus depth, gunnite nozzle men, lead man on sewer work, welders, cutters, burners and torchmen, chainsaw operators, jackhammer and drill operators, layout man and/or drainage tile layer, steel form setter - street and highway, air tamping hammermen, signal man on crane, concrete saw operator, screedman on asphalt pavers, laborers tending masons with

hot material or where foreign materials are used, mortar mixer operators, multiple concrete duct - leadsman, lumen, asphalt raker, curb asphalt machine operator, ready mix scalemen (permanent, portable or temporary plant), laborers handling masterplate or similar materials, laser beam operator, concrete burning machine operator, coring machine operator, plaster tender, underpinning and shoring of buildings, pump men, manhole and catch basin, dirt and stone tamper, hose men on concrete pumps, hazardous waste worker, lead base paint abatement worker, lining of pipe, refusing machine, assisting on direct boring machine, the work of laying watermain, fire hydrants, all mechanical joints to watermain work, sewer worker, and tapping water service and forced lift station mechanical worker.

MATERIAL TESTER I: Hand coring and drilling for testing of materials; field inspection of uncured concrete and asphalt.

MATERIAL TESTER II: Field inspection of welds, structural steel, fireproofing, masonry, soil, facade, reinforcing steel, formwork, cured concrete, and concrete and asphalt batch plants; adjusting proportions of bituminous mixtures.

OPERATING ENGINEERS - BUILDING

Class 1. Asphalt Plant; Asphalt Spreader; Autograde; Backhoes with Caisson Attachment; Batch Plant; Benoto (requires Two Engineers); Boiler and Throttle Valve; Caisson Rigs; Central Redi-Mix Plant; Combination Back Hoe Front End-loader Machine; Compressor and Throttle Valve; Concrete Breaker (Truck Mounted); Concrete Conveyor; Concrete Paver (over 27E cu. ft.): Concrete Paver (27 cu. ft. and under); Concrete Placer; Concrete Pump (Truck Mounted); Concrete Conveyor (Truck Mounted); Concrete Tower; Cranes, All; GCI and similar types (required two operators only); Cranes, Hammerhead; Creter Crane; Crusher, Stone, etc.; Derricks, All; Derricks, Traveling; Formless Curb and Gutter Machine; Grader, Elevating; Grouting Machines; Highlift Shovels or Front Endloader 2-1/4 yd. and over; Hoists, Elevators, outside type rack and pinion and similar machines; Hoists, one, two and three Drum; Hoists, Two Tugger One Floor; Hydraulic Backhoes; Hydraulic Boom Trucks; Hydro Vac (and similar equipment - excluding hose work and any sewer work); Locomotives, All; Lubrication Technician; Manipulators; Motor Patrol; Pile Drivers and Skid Rig; Post Hole Digger; Pre-Stress Machine; Pump Cretes Dual Ram; Pump Cretes: Squeeze Cretes - Screw Type Pumps, Gypsum Bulker and Pump; Raised and Blind Hole Drill; Rock Drill (self-propelled); Rock Drill - Truck Mounted; Roto Mill Grinder; Scoops - Tractor Drawn; Slipform Paver; Scrapers Prime Movers; Straddle Buggies; Tie Back Machine; Tractor with Boom and Side Boom; Trenching Machines.

Class 2. Bobcat (over 3/4 cu. yd.); Boilers; Brick Forklift; Broom, All Power Propelled; Bulldozers; Concrete Mixer (Two Bag and Over); Conveyor, Portable; Forklift Trucks; Highlift Shovels or Front Endloaders under 2-1/4 yd.; Hoists, Automatic; Hoists, Sewer Dragging Machine; Hoists, Tugger Single Drum; Laser Screed; Rollers, All; Steam Generators; Tractors, All; Tractor Drawn Vibratory Roller; Winch Trucks with "A" Frame.

Class 3. Air Compressor; Asphalt Spreader; Combination - Small Equipment Operator; Generators; Heaters, Mechanical; Hoists, Inside Elevators - (Rheostat Manual Controlled); Hydraulic Power Units (Pile Driving, Extracting, or Drilling - with a seat); Lowboys; Pumps, Over 3" (1 to 3 not to exceed total of 300 ft.); Pumps, Well Points; Welding Machines (2 through 5); Winches, 4 Small Electric Drill Winches; Bobcat (up to and including 3/4 cu. yd.).

Class 4. Elevator push button with automatic doors; Hoists, Inside; Oilers; Brick Forklift.

Class 5. Assistant Craft Foreman

Class 6. Mechanics; Welders.

Class 7. Gradall

OPERATING ENGINEERS - HIGHWAY CONSTRUCTION

Class 1. Asphalt Plant; Asphalt Heater and Planer Combination; Asphalt Heater Scarfire; Asphalt Silo Tender; Asphalt Spreader; Autograder; ABG Paver; Backhoes with Caisson Attachment; Ballast Regulator; Belt Loader; Caisson Rigs; Car Dumper; Central Redi-Mix Plant; Backhoe w/shear attachments; Combination Backhoe Front Endloader Machine, (1 cu. yd. Backhoe Bucket or over or with attachments); Concrete Breaker (Truck Mounted); Concrete Conveyor; Concrete Paver over 27E cu. ft.; Concrete Placer; Concrete Tube Float; Cranes, all attachments; Cranes, Tower of all types; Creter Crane; Crusher, Stone, etc.; Derricks, All; Derrick Boats; Derricks, Traveling; Directional Boring Machine over 12"; Dredges; Formless Curb and Gutter Machine; Grader, Elevating; Grader, Motor Grader, Motor Patrol, Auto Patrol, Form Grader, Pull Grader, Subgrader; Guard Rail Post Driver Mounted; Hoists, One, Two and Three Drum; Hydraulic Backhoes; Hydro Vac, Self Propelled, Truck Mounted (excluding hose work and any sewer work); Lubrication Technician; Manipulators; Pile Drivers and Skid Rig; Pre-Stress Machine; Pump Cretes Dual Ram; Rock Drill - Crawler or Skid Rig; Rock Drill - Truck Mounted; Rock/Track Tamper; Roto Mill Grinder; Slip-Form Paver; Snow Melters; Soil Test Drill Rig (Truck Mounted); Straddle Buggies; GCI Crane; Hydraulic Telescoping Form (Tunnel); Tie Back Machine; Tractor Drawn Belt Loader; Tractor Drawn Belt Loader with attached pusher; Tractor with Boom; Tractaire with Attachments; Traffic Barrier Conveyor Machine; Raised or Blind Hole Drills; Trenching Machine (over 12"); Truck Mounted Concrete Pump with Boom; Truck Mounted Concrete Conveyor; Work Boat (no license required - 90 h.p. or above); Underground Boring and/or Mining Machines; Wheel Excavator; Widener (APSCO).

Class 2. Batch Plant; Bituminous Mixer; Boiler and Throttle Valve; Bulldozers; Car Loader Trailing Conveyors; Combination Backhoe Front Endloader Machine (less than 1 cu. yd. Backhoe Bucket or over or with attachments); Compressor and Throttle Valve; Compressor, Common Receiver (3); Concrete Breaker or Hydro Hammer; Concrete Grinding Machine; Concrete Mixer or Paver 7S Series to and including 27 cu. ft.; Concrete Spreader; Concrete Curing Machine, Burlap Machine, Belting Machine and Sealing Machine; Concrete Wheel Saw (large self-propelled - excluding walk-behinds and hand-held); Conveyor Muck Cars (Haglund or Similar Type); Drills, all; Finishing Machine - Concrete; Highlift Shovels or Front Endloader; Hoist - Sewer Dragging Machine; Hydraulic Boom Trucks (All Attachments); Hydro Blaster; All Locomotives, Dinky; Off-Road Hauling Units; Non-Self Loading Dump; Ejection Dump; Pump Cretes: Squeeze Cretes - Screw Type Pumps, Gypsum Bulker and Pump; Roller, Asphalt; Rotary Snow Plows; Rototiller, Seaman, etc., self-propelled; Scoops - Tractor Drawn; Self-Propelled Compactor; Spreader - Chip - Stone, etc.; Scraper; Scraper - Prime Mover in Tandem (Regardless of Size); Tank Car Heater; Tractors, Push, Pulling Sheeps Foot, Disc, Compactor, etc.; Tug Boats.

Class 3. Boilers; Brooms, All Power Propelled; Cement Supply Tender; Compressor, Common Receiver (2); Concrete Mixer (Two Bag and Over); Conveyor, Portable; Farm-Type Tractors Used for Mowing, Seeding, etc.; Fireman on Boilers; Forklift Trucks; Grouting Machine; Hoists, Automatic; Hoists, All Elevators; Hoists, Tugger Single Drum; Jeep

Diggers; Low Boys; Pipe Jacking Machines; Post-Hole Digger; Power Saw, Concrete Power Driven; Pug Mills; Rollers, other than asphalt; Seed and Straw Blower; Steam Generators; Stump Machine; Winch Trucks with "A" Frame; Work Boats; Tamper - Form - Motor Driven.

Class 4. Air Compressor - Small and Large; Asphalt Spreader, Backend Man; Bobcat (Skid Steer) all; Brick Forklift; Combination - Small Equipment Operator; Directional Boring Machine up to 12"; Generators; Heaters, Mechanical; Hydraulic Power Unit (Pile Driving, Extracting, or Drilling); Hydro-Blaster; Light Plants, All (1 through 5); Pumps, over 3" (1 to 3 not to exceed a total of 300 ft.); Pumps, Well Points; Tractaire; Trencher 12" and under; Welding Machines (2 through 5); Winches, 4 Small Electric Drill Winches.

Class 5. Oilers and Directional Boring Machine Locator.

Class 6. Field Mechanics and Field Welders

Class 7. Gradall and machines of like nature.

TRUCK DRIVER - BUILDING, HEAVY AND HIGHWAY CONSTRUCTION

Class 1. Two or three Axle Trucks. A-frame Truck when used for transportation purposes; Air Compressors and Welding Machines, including those pulled by cars, pick-up trucks and tractors; Ambulances; Batch Gate Lockers; Batch Hopperman; Car and Truck Washers; Carry-alls; Fork Lifts and Hoisters; Helpers; Mechanics Helpers and Greasers; Oil Distributors 2-man operation; Pavement Breakers; Pole Trailer, up to 40 feet; Power Mower Tractors; Self-propelled Chip Spreader; Skipman; Slurry Trucks, 2-man operation; Slurry Truck Conveyor Operation, 2 or 3 man; TTeamsters Unskilled dumpman; and Truck Drivers hauling warning lights, barricades, and portable toilets on the job site.

Class 2. Four axle trucks; Dump Crets and Adgetors under 7 yards; Dumpsters, Track Trucks, Euclids, Hug Bottom Dump Turnapulls or Turnatrailers when pulling other than self-loading equipment or similar equipment under 16 cubic yards; Mixer Trucks under 7 yards; Ready-mix Plant Hopper Operator, and Winch Trucks, 2 Axles.

Class 3. Five axle trucks; Dump Crets and Adgetors 7 yards and over; Dumpsters, Track Trucks, Euclids, Hug Bottom Dump Turnatrailers or turnapulls when pulling other than self-loading equipment or similar equipment over 16 cubic yards; Explosives and/or Fission Material Trucks; Mixer Trucks 7 yards or over; Mobile Cranes while in transit; Oil Distributors, 1-man operation; Pole Trailer, over 40 feet; Pole and Expandable Trailers hauling material over 50 feet long; Slurry trucks, 1-man operation; Winch trucks, 3 axles or more; Mechanic--Truck Welder and Truck Painter.

Class 4. Six axle trucks; Dual-purpose vehicles, such as mounted crane trucks with hoist and accessories; Foreman; Master Mechanic; Self-loading equipment like P.B. and trucks with scoops on the front.

Other Classifications of Work:

For definitions of classifications not otherwise set out, the Department generally has on file such definitions which are available. If a task to be performed is not subject to one of the classifications of pay set out, the Department will upon being contacted state which neighboring county has such a classification and provide such rate, such rate being deemed to exist by reference in this document. If no neighboring county rate applies to the task, the Department shall undertake a special determination, such special

determination being then deemed to have existed under this determination. If a project requires these, or any classification not listed, please contact IDOL at 217-782-1710 for wage rates or clarifications.

LANDSCAPING

Landscaping work falls under the existing classifications for laborer, operating engineer and truck driver. The work performed by landscape plantsman and landscape laborer is covered by the existing classification of laborer. The work performed by landscape operators (regardless of equipment used or its size) is covered by the classifications of operating engineer. The work performed by landscape truck drivers (regardless of size of truck driven) is covered by the classifications of truck driver.

Woodford County Prevailing Wage for May 2013

(See explanation of column headings at bottom of wages)

Trade Name	RG	TYP	C	Base	FRMAN	M-F>8	OSA	OSH	H/W	Pensn	Vac	Trng
=====	==	===	=	=====	=====	=====	===	===	=====	=====	=====	=====
ASBESTOS ABT-GEN		BLD		30.030	31.030	1.5	1.5	2.0	7.700	8.230	0.000	0.800
ASBESTOS ABT-GEN		HWY		31.590	32.140	1.5	1.5	2.0	7.700	8.230	0.000	0.800
ASBESTOS ABT-MEC		BLD		31.840	34.340	1.5	1.5	2.0	10.82	10.66	0.000	0.720
BOILERMAKER		BLD		35.010	38.010	2.0	2.0	2.0	7.070	13.83	0.000	0.300
BRICK MASON		BLD		32.060	33.560	1.5	1.5	2.0	7.700	9.130	0.000	0.560
CARPENTER		BLD		29.330	31.580	1.5	1.5	2.0	7.450	13.66	0.000	0.520
CARPENTER		HWY		30.820	33.070	1.5	1.5	2.0	7.450	13.94	0.000	0.520
CEMENT MASON	NE	ALL		35.000	36.000	1.5	1.5	2.0	7.700	11.67	0.000	0.500
CEMENT MASON	SE	ALL		30.590	31.590	1.5	1.5	2.0	5.750	11.23	0.000	0.500
CEMENT MASON	W	BLD		27.090	28.840	1.5	1.5	2.0	8.140	13.55	0.000	0.500
CEMENT MASON	W	HWY		28.280	29.780	1.5	1.5	2.0	8.140	13.93	0.000	0.500
CERAMIC TILE FNSHER		BLD		29.750	0.000	1.5	1.5	2.0	7.700	9.130	0.000	0.550
ELECTRIC PWR EQMT OP		ALL		35.440	0.000	1.5	1.5	2.0	5.000	10.98	0.000	0.270
ELECTRIC PWR GRNDMAN		ALL		24.320	0.000	1.5	1.5	2.0	5.000	7.540	0.000	0.180
ELECTRIC PWR LINEMAN		ALL		39.370	41.910	1.5	1.5	2.0	5.000	12.20	0.000	0.300
ELECTRIC PWR TRK DRV		ALL		25.510	0.000	1.5	1.5	2.0	5.000	7.920	0.000	0.190
ELECTRICIAN	NE	BLD		37.090	39.090	1.5	1.5	2.0	5.350	7.760	0.000	0.560
ELECTRICIAN	SE	BLD		34.950	38.340	1.5	1.5	2.0	5.350	9.500	0.000	0.870
ELECTRICIAN	W	BLD		34.820	37.320	1.5	1.5	2.0	5.350	10.08	0.000	0.400
ELECTRONIC SYS TECH		BLD		27.430	29.180	1.5	1.5	2.0	5.350	9.320	0.000	0.400
ELEVATOR CONSTRUCTOR		BLD		40.520	45.585	2.0	2.0	2.0	11.88	12.71	3.240	0.600
GLAZIER		BLD		30.770	32.770	1.5	1.5	2.0	9.700	7.700	0.000	1.250
HT/FROST INSULATOR		BLD		42.450	44.950	1.5	1.5	2.0	10.82	11.86	0.000	0.720
IRON WORKER		BLD		30.330	32.230	1.5	1.5	2.0	9.390	11.56	0.000	0.440
IRON WORKER		HWY		34.020	36.020	1.5	1.5	2.0	9.390	11.56	0.000	0.390
LABORER		BLD		29.030	30.030	1.5	1.5	2.0	7.700	8.230	0.000	0.800
LABORER		HWY		30.590	31.140	1.5	1.5	2.0	7.700	8.230	0.000	0.800
LABORER, SKILLED		BLD		29.030	30.030	1.5	1.5	2.0	7.700	8.230	0.000	0.800
LABORER, SKILLED		HWY		30.590	31.140	1.5	1.5	2.0	7.700	8.230	0.000	0.800
LATHER		BLD		29.330	31.580	1.5	1.5	2.0	7.450	13.66	0.000	0.520
MACHINERY MOVER		HWY		34.020	36.020	1.5	1.5	2.0	9.390	11.56	0.000	0.390
MACHINIST		BLD		43.550	46.050	1.5	1.5	2.0	6.130	8.950	1.850	0.000
MARBLE FINISHERS		BLD		29.750	0.000	1.5	1.5	2.0	7.700	9.130	0.000	0.550
MARBLE MASON		BLD		31.510	32.760	1.5	1.5	2.0	7.700	9.130	0.000	0.550
MILLWRIGHT		BLD		30.240	32.490	1.5	1.5	2.0	7.450	13.09	0.000	0.520
MILLWRIGHT		HWY		31.820	34.070	1.5	1.5	2.0	7.450	13.44	0.000	0.520
OPERATING ENGINEER		BLD	1	36.000	39.000	1.5	1.5	2.0	9.750	13.60	0.000	3.000
OPERATING ENGINEER		BLD	2	33.490	39.000	1.5	1.5	2.0	9.750	13.60	0.000	3.000
OPERATING ENGINEER		BLD	3	29.340	39.000	1.5	1.5	2.0	9.750	13.60	0.000	3.000
OPERATING ENGINEER		HWY	1	36.000	39.500	1.5	1.5	2.0	9.750	13.60	0.000	3.000
OPERATING ENGINEER		HWY	2	33.490	39.500	1.5	1.5	2.0	9.750	13.60	0.000	3.000
OPERATING ENGINEER		HWY	3	29.340	39.500	1.5	1.5	2.0	9.750	13.60	0.000	3.000

PAINTER	ALL	32.900	34.900	1.5	1.5	1.5	9.650	8.200	0.000	1.250
PAINTER SIGNS	BLD	33.920	38.090	1.5	1.5	1.5	2.600	2.710	0.000	0.000
PILEDRIVER	BLD	29.830	32.080	1.5	1.5	2.0	7.450	13.66	0.000	0.520
PILEDRIVER	HWY	31.820	34.070	1.5	1.5	2.0	7.450	13.94	0.000	0.520
PIPEFITTER	NW BLD	37.400	41.510	1.5	1.5	2.0	7.000	11.63	0.000	1.060
PIPEFITTER	SE BLD	39.000	42.120	1.5	1.5	2.0	7.000	9.500	0.000	1.850
PLASTERER	SE BLD	29.500	31.500	1.5	1.5	2.0	6.300	13.83	0.000	0.500
PLASTERER	W BLD	27.770	28.770	1.5	1.5	2.0	8.140	12.76	0.000	0.600
PLUMBER	NW BLD	33.570	36.590	1.5	1.5	2.0	7.000	13.31	0.000	0.900
PLUMBER	SE BLD	39.000	42.120	1.5	1.5	2.0	7.000	9.500	0.000	1.850
ROOFER	BLD	28.580	30.010	1.5	1.5	2.0	8.450	7.220	0.000	0.250
SHEETMETAL WORKER	BLD	31.920	33.520	1.5	1.5	2.0	7.270	13.08	0.000	0.660
SIGN HANGER	HWY	34.020	36.020	1.5	1.5	2.0	9.390	11.56	0.000	0.390
SPRINKLER FITTER	BLD	36.390	39.140	1.5	1.5	2.0	8.420	8.500	0.000	0.450
STEEL ERECTOR	HWY	34.020	36.020	1.5	1.5	2.0	9.390	11.56	0.000	0.390
STONE MASON	BLD	32.060	33.560	1.5	1.5	2.0	7.700	9.130	0.000	0.560
TERRAZZO FINISHER	BLD	29.750	0.000	1.5	1.5	2.0	7.700	9.130	0.000	0.550
TERRAZZO MASON	BLD	31.510	32.760	1.5	1.5	2.0	7.700	9.130	0.000	0.550
TILE MASON	BLD	31.510	32.760	1.5	1.5	2.0	7.700	9.130	0.000	0.550
TRUCK DRIVER	O&C 1	24.980	0.000	1.5	1.5	2.0	10.30	4.840	0.000	0.250
TRUCK DRIVER	O&C 2	25.340	0.000	1.5	1.5	2.0	10.30	4.840	0.000	0.250
TRUCK DRIVER	O&C 3	25.510	0.000	1.5	1.5	2.0	10.30	4.840	0.000	0.250
TRUCK DRIVER	O&C 4	25.740	0.000	1.5	1.5	2.0	10.30	4.840	0.000	0.250
TRUCK DRIVER	O&C 5	26.420	0.000	1.5	1.5	2.0	10.30	4.840	0.000	0.250
TRUCK DRIVER	E ALL 1	35.650	36.200	1.5	1.5	2.0	7.250	6.319	0.000	0.250
TRUCK DRIVER	E ALL 2	35.800	36.200	1.5	1.5	2.0	7.250	6.319	0.000	0.250
TRUCK DRIVER	E ALL 3	36.000	36.200	1.5	1.5	2.0	7.250	6.319	0.000	0.250
TRUCK DRIVER	E ALL 4	36.200	36.200	1.5	1.5	2.0	7.250	6.319	0.000	0.250
TRUCK DRIVER	W ALL 1	31.230	0.000	1.5	1.5	2.0	10.30	4.840	0.000	0.250
TRUCK DRIVER	W ALL 2	31.680	0.000	1.5	1.5	2.0	10.30	4.840	0.000	0.250
TRUCK DRIVER	W ALL 3	31.890	0.000	1.5	1.5	2.0	10.30	4.840	0.000	0.250
TRUCK DRIVER	W ALL 4	32.180	0.000	1.5	1.5	2.0	10.30	4.840	0.000	0.250
TRUCK DRIVER	W ALL 5	33.020	0.000	1.5	1.5	2.0	10.30	4.840	0.000	0.250
TUCKPOINTER	BLD	32.060	33.560	1.5	1.5	2.0	7.700	9.130	0.000	0.560

Legend :

RG (Region)

TYP (Trade Type - All,Highway,Building,Floating,Oil & Chip,Rivers)

C (Class)

Base (Base Wage Rate)

FRMAN (Foreman Rate)

M-F>8 (OT required for any hour greater than 8 worked each day, Mon through Fri.)

OSA (Overtime (OT) is required for every hour worked on Saturday)

OSH (Overtime is required for every hour worked on Sunday and Holidays)

H/W (Health & Welfare Insurance)

Pensn (Pension)

Vac (Vacation)

Trng (Training)

Explanations

†WOODFORD COUNTY

CEMENT MASONS AND PLASTERERS (NORTHEAST) - That part of the county including the town of Minonk.

CEMENT MASONS AND PLASTERERS (SOUTHEAST) - Eastern part North to and including Benson and West to, but not including Roanoke.

CEMENT MASONS AND PLASTERERS (WEST) - That part of the county West of Rt. 116 and 116A including the towns of Benson, Roanoke and Congerville.

ELECTRICIANS (NORTHEAST) - Townships of Linn, Clayton, Minonk, Roanoke, Green and Panola.

ELECTRICIANS (SOUTHEAST) - Townships of Palestine, El Paso and Kansas.

ELECTRICIANS (WEST) - Townships of Partridge, Cazenovia, Spring Bay, Worth, Metamora, Cruger, Olio, and Montgomery.

PLUMBERS & PIPEFITTERS (SOUTHEAST) - That part of the county South of Rt. 116 and East of Rte. 116A including Goodfield.

TRUCK DRIVERS (EAST) - That part of the county East of Route 51 and north of Route 24.

The following list is considered as those days for which holiday rates of wages for work performed apply: New Years Day, Memorial Day, Fourth of July, Labor Day, Thanksgiving Day, Christmas Day and Veterans Day in some classifications/counties. Generally, any of these holidays which fall on a Sunday is celebrated on the following Monday. This then makes work performed on that Monday payable at the appropriate overtime rate for holiday pay. Common practice in a given local may alter certain days of celebration. If in doubt, please check with IDOL.

Oil and chip resealing (O&C) means the application of road oils and liquid asphalt to coat an existing road surface, followed by application of aggregate chips or gravel to coated surface, and subsequent rolling of material to seal the surface.

EXPLANATION OF CLASSES

ASBESTOS - GENERAL - removal of asbestos material/mold and hazardous materials from any place in a building, including mechanical systems where those mechanical systems are to be removed. This includes the removal of asbestos materials/mold and hazardous materials from ductwork or pipes in a building when the building is to be demolished at the time or at some close future date.

ASBESTOS - MECHANICAL - removal of asbestos material from mechanical systems, such as pipes, ducts, and boilers, where the mechanical systems are to remain.

CERAMIC TILE FINISHER, MARBLE FINISHER, TERRAZZO FINISHER

Assisting, helping or supporting the tile, marble and terrazzo mechanic by performing their historic and traditional work assignments required to complete the proper installation of the work covered by said crafts. The term "Ceramic" is used for naming the classification only and is in no way a limitation of the product handled. Ceramic

takes into consideration most hard tiles.

ELECTRONIC SYSTEMS TECHNICIAN

Installation, service and maintenance of low-voltage systems which utilizes the transmission and/or transference of voice, sound, vision, or digital for commercial, education, security and entertainment purposes for the following: TV monitoring and surveillance, background/foreground music, intercom and telephone interconnect, field programming, inventory control systems, microwave transmission, multi-media, multiplex, radio page, school, intercom and sound burglar alarms and low voltage master clock systems.

Excluded from this classification are energy management systems, life safety systems, supervisory controls and data acquisition systems not intrinsic with the above listed systems, fire alarm systems, nurse call systems and raceways exceeding fifteen feet in length.

LABORER, SKILLED - BUILDING

The skilled laborer building (BLD) classification shall encompass the following types of work, irrespective of the site of the work: tending of carpenters in unloading, handling, stockpiling and distribution operations, also other building crafts, mixing, handling, and conveying of all materials used by masons, plasterers and other building construction crafts, whether done by hand or by any process. The drying of plastering when done by salamander heat, and the cleaning and clearing of all debris. All work pertaining to and in preparation of asbestos abatement and removal. The building of scaffolding and staging for masons and plasterers. The excavations for buildings and all other construction, digging, of trenches, piers, foundations and holes, digging, lagging, sheeting, cribbing, bracing and propping of foundations, holes, caissons, cofferdams, and dikes, the setting of all guidelines for machine or hand excavation and subgrading. The mixing, handling, conveying, pouring, vibrating, gunniting and otherwise applying of concrete, whether by hand or other method of concrete for any walls, foundations, floors, or for other construction concrete sealant men. The wrecking, stripping, dismantling, and handling of concrete forms and false work, and the building of centers for fireproofing purposes. Boring machine, gas, electric or air in preparation for shoving pipe, telephone cable, and so forth, under highways, roads, streets and alleys. All hand and power operating cross cut saws when used for clearing. All work in compressed air construction. All work on acetylene burners in salvaging. The blocking and tamping of concrete. The laying of sewer tile and conduit, and pre-cast materials. The assembling and dismantling of all jacks and sectional scaffolding, including elevator construction and running of slip form jacks. The work of drill running and blasting, including wagon drills. The wrecking, stripping, dismantling, cleaning, moving and oiling of forms. The cutting off of concrete piles. The loading, unloading, handling and carrying to place of installation of all rods, (and materials for use in reinforcing) concrete and the hoisting of same and all signaling where hoist is used in this type of construction coming under the jurisdiction of the Laborers' Union. And, all other labor work not awarded to any other craft. Mortar mixers, kettlemen and carrier of hot stuff, tool crib men, watchmen (Laborer), firemen or salamander tenders, flagmen, deck hands, installation and maintenance of temporary gas-fired heating units, gravel box men, dumpmen and spotters, fencing Laborers, cleaning lumber, pit men, material checkers, dispatchers, unloading explosives, asphalt plant laborers, writer of scale tickets, fireproofing laborers, janitors, asbestos abatement and removal laborers, handling of materials treated with oil, creosote, chloride, asphalt, and/or foreign material harmful to skin or clothing, Laborers with de-watering systems, gunnite nozzle

men, laborers tending masons with hot material or where foreign materials are used, Laborers handling masterplate or similar materials, laser beam operator, concrete burning machine operator, material selector men working with firebrick or combustible material, dynamite men, track laborers, cement handlers, chloride handlers, the unloading and laborers with steel workers and re-bars, concrete workers (wet), luteman, asphalt raker, curb asphalt machine operator, ready mix scalemen, permanent, portable or temporary plant drilling machine operator, plaster tenders, underpinning and shoring of buildings, fire watch, signaling of all power equipment, to include trucks excavating equipment, etc., tree topper or trimmer when in connection to construction, tunnel helpers in free air, batch dumpers, kettle and tar men, tank cleaners, plastic installers, scaffold workers, motorized buggies or motorized unit used for wet concrete or handling of building materials, sewer workers, rod and chain men, vibrator operators, mortar mixer operator, cement silica, clay, fly ash, lime and plasters, handlers (bulk or bag), cofferdam workers, on concrete paving, placing, cutting and tying of reinforcing, deck hand, dredge hand and shore laborers, bankmen on floating plant, asphalt workers with machine & layers, grade checker, power tools, caisson workers, lead man on sewer work, welders, cutters, burners and torch men, chain saw operators, paving breaker, jackhammer and drill operator, layout man and/or drainage tile layer, steel form setters -- street and highway, air tamping hammerman, signal man on crane, concrete saw operator, screen man on asphalt pavers, front end man on chip spreader, multiple concrete duct -- lead man.

LABORER, SKILLED - HIGHWAY

The skilled laborer heavy and highway (HWY) classification shall encompass the following types of work, irrespective of the site of the work: handling of materials treated with oil, creosote, asphalt and/or any foreign materials harmful to skin or clothing, track laborers, chloride handlers, the unloading and loading with steel workers and re-bars, concrete workers (wet), tunnel helpers in free air, batch dumpers, mason tenders, kettle and tar men, plastic installers, scaffold workers, motorized buggies or motorized unit used for wet concrete or handling of building materials, laborers with de-watering systems, sewer workers plus depth, rod and chainmen, vibrator operators, mortar mixer operators, cement silica, clay, fly ash, lime and plasters, handlers (bulk or bag), cofferdam workers plus depth, on concrete paving, placing, cutting and tying or reinforcing, deck hand, dredge hand shore laborers, bankmen on floating plant, asphalt workers with machine, and layers, grade checker, power tools, stripping of all concrete forms excluding paving forms, dumpmen and spotters, when necessary, caisson workers plus depth, gunnite nozzle men, welders, cutters, burners and torchmen, chain saw operators, paving breaker, jackhammer and drill operators, layout man and/or drainage tile layer, steel form setters - street and highway, air tamping hammerman, signal man on crane, concrete saw operator, screedman on asphalt pavers, front end man on chip spreader, multiple concrete duct, luteman, asphalt raker, curb asphalt machine operator, ready mix scalemen (portable or temporary plant), laser beam operator, concrete burning machine operator, and coring machine operator.

TRUCK DRIVER - BUILDING, HEAVY AND HIGHWAY CONSTRUCTION - WEST

Class 1. Drivers on 2 axle trucks hauling less than 9 ton. Air compressor and welding machines and brooms, including those pulled by separate units, truck driver helpers, warehouse employees, mechanic helpers, greasers and tiremen, pickup trucks when hauling materials, tools, or workers to and from and on-the-job site, and fork lifts up to 6,000 lb. capacity.

Class 2. Two or three axle trucks hauling more than 9 ton but hauling

less than 16 ton. A-frame winch trucks, hydrolift trucks, vactor trucks or similar equipment when used for transportation purposes. Fork lifts over 6,000 lb. capacity, winch trucks, four axle combination units, and ticket writers.

Class 3. Two, three or four axle trucks hauling 16 ton or more. Drivers on water pulls, articulated dump trucks, mechanics and working forepersons, and dispatchers. Five axle or more combination units.

Class 4. Low Boy and Oil Distributors.

Class 5. Drivers who require special protective clothing while employed on hazardous waste work.

TRUCK DRIVER - BUILDING, HEAVY AND HIGHWAY CONSTRUCTION - EAST

Class 1. Two or three Axle Trucks. A-frame Truck when used for transportation purposes; Air Compressors and Welding Machines, including those pulled by cars, pick-up trucks and tractors; Ambulances; Batch Gate Lockers; Batch Hopperman; Car and Truck Washers; Carry-alls; Fork Lifts and Hoisters; Helpers; Mechanics Helpers and Greasers; Oil Distributors 2-man operation; Pavement Breakers; Pole Trailer, up to 40 feet; Power Mower Tractors; Self-propelled Chip Spreader; Skipman; Slurry Trucks, 2-man operation; Slurry Truck Conveyor Operation, 2 or 3 man; Teamsters Unskilled dumpman; and Truck Drivers hauling warning lights, barricades, and portable toilets on the job site.

Class 2. Four axle trucks; Dump Crets and Adgetors under 7 yards; Dumpsters, Track Trucks, Euclids, Hug Bottom Dump Turnapulls or Turnatrailers when pulling other than self-loading equipment or similar equipment under 16 cubic yards; Mixer Trucks under 7 yards; Ready-mix Plant Hopper Operator, and Winch Trucks, 2 Axles.

Class 3. Five axle trucks; Dump Crets and Adgetors 7 yards and over; Dumpsters, Track Trucks, Euclids, Hug Bottom Dump Turnatrailers or turnapulls when pulling other than self-loading equipment or similar equipment over 16 cubic yards; Explosives and/or Fission Material Trucks; Mixer Trucks 7 yards or over; Mobile Cranes while in transit; Oil Distributors, 1-man operation; Pole Trailer, over 40 feet; Pole and Expandable Trailers hauling material over 50 feet long; Slurry trucks, 1-man operation; Winch trucks, 3 axles or more; Mechanic--Truck Welder and Truck Painter.

Class 4. Six axle trucks; Dual-purpose vehicles, such as mounted crane trucks with hoist and accessories; Foreman; Master Mechanic; Self-loading equipment like P.B. and trucks with scoops on the front.

TRUCK DRIVER - OIL AND CHIP RESEALING ONLY.

This shall encompass laborers, workers and mechanics who drive contractor or subcontractor owned, leased, or hired pickup, dump, service, or oil distributor trucks. The work includes transporting materials and equipment (including but not limited to, oils, aggregate supplies, parts, machinery and tools) to or from the job site; distributing oil or liquid asphalt and aggregate; stock piling material when in connection with the actual oil and chip contract. The Truck Driver (Oil & Chip Resealing) wage classification does not include supplier delivered materials.

OPERATING ENGINEERS - BUILDING

Class 1. Cranes; Overhead Cranes; Gradall; All Cherry Pickers; Mechanics; Central Concrete Mixing Plant Operator; Road Pavers (27E - Dual Drum - Tri Batchers); Blacktop Plant Operators and Plant Engineers; 3 Drum Hoist; Derricks; Hydro Cranes; Shovels; Skimmer

Scoops; Koehring Scooper; Drag Lines; Backhoe; Derrick Boats; Pile Drivers and Skid Rigs; Clamshells; Locomotive Cranes; Dredge (all types) Motor Patrol; Power Blades - Dumore - Elevating and similar types; Tower Cranes (Crawler-Mobile) and Stationary; Crane-type Backfiller; Drott Yumbo and similar types considered as Cranes; Caisson Rigs; Dozer; Tournadozer; Work Boats; Ross Carrier; Helicopter; Tournapulls - all and similar types; Scoops (all sizes); Pushcats; Endloaders (all types); Asphalt Surfacing Machine; Slip Form Paver; Rock Crusher; Heavy Equipment Greaser; CMI, CMI Belt Placer, Auto Grade & 3 Track and similar types; Side Booms; Multiple Unit Earth Movers; Creter Crane; Trench Machine; Pump-crete-Belt Crete-Squeeze Cretes-Screw-type Pumps and Gypsum; Bulker & Pump - Operator will clean; Formless Finishing Machine; Flaherty Spreader or similar types; Screed Man on Laydown Machine; Wheel Tractors (industrial or Farm-type w/Dozer-Hoe-Endloader or other attachments); F.W.D. & Similar Types; Vermeer Concrete Saw.

Class 2. Dinkeys; Power Launches; PH One-pass Soil Cement Machine (and similar types); Pugmill with Pump; Backfillers; Euclid Loader; Forklifts; Jeeps w/Ditching Machine or other attachments; Tuneluger; Automatic Cement and Gravel Batching Plants; Mobile Drills (Soil Testing) and similar types; Gurries and Similar Types; (1) and (2) Drum Hoists (Buck Hoist and Similar Types); Chicago Boom; Boring Machine & Pipe Jacking Machine; Hydro Boom; Dewatering System; Straw Blower; Hydro Seeder; Assistant Heavy Equipment Greaser on Spread; Tractors (Track type) without Power Unit pulling Rollers; Rollers on Asphalt -- Brick Macadem; Concrete Breakers; Concrete Spreaders; Mule Pulling Rollers; Center Stripper; Cement Finishing Machines & CMI Texture & Reel Curing Machines; Cement Finishing Machine; Barber Green or similar loaders; Vibro Tamper (All similar types) Self-propelled; Winch or Boom Truck; Mechanical Bull Floats; Mixers over 3 Bag to 27E; Tractor pulling Power Blade or Elevating Grader; Porter Rex Rail; Clary Screed; Truck Type Hoptoe Oilers; Fireman; Spray Machine on Paving; Curb Machines; Truck Crane Oilers; Oil Distributor; Truck-Mounted Saws.

Class 3. Air Compressor; Power Subgrader; Straight Tractor; Trac Air without attachments; Herman Nelson Heater, Dravo, Warner, Silent Glo, and similar types; Roller: Five (5) Ton and under on Earth or Gravel; Form Grader; Crawler Crane & Skid Rig Oilers; Freight Elevators - permanently installed; Pump; Light Plant; Generator; Conveyor (1) or (2) - Operator will clean; Welding Machine; Mixer (3) Bag and Under (Standard Capacity with skip); Bulk Cement Plant; Oiler on Central Concrete Mixing Plant.

OPERATING ENGINEERS - HEAVY AND HIGHWAY CONSTRUCTION

CLASS 1. Cranes; Hydro Cranes; Shovels; Crane Type Backfiller; Tower, Mobile, Crawler, & Stationary Cranes; Derricks; Hoists (3 Drum); Draglines; Drott Yumbo & Similar Types considered as Cranes; 360 Degree Swing Excavator (Shears, Grapples, Movacs, etc.); Back Hoe; Derrick Boats; Pile Driver and Skid Rigs; Clam Shell; Locomotive - Cranes; Road Pavers - Single Drum - Dual Drum - Tri Batcher; Motor Patrols & Power Blades - Dumore - Elevating & Similar Types; Mechanics; Central Concrete Mixing Plant Operator; Asphalt Batch Plant Operators and Plant Engineers; Gradall; Caisson Rigs; Skimmer Scoop - Koering Scooper; Dredges (all types); Hoptoe; All Cherry Pickers; Work Boat; Ross Carrier; Helicopter; Dozer; Tournadozer; Tournapulls - all and similar types; Operation of Concrete and all Recycle Machines; Multiple Unit Earth Movers; Scoops (all sizes); Pushcats; Endloaders (all types); Asphalt Surfacing Machine; Slip Form Paver; Rock Crusher; Operation of Material Crusher, Screening Plants, and Tunnel Boring Machine; Heavy Equipment Greaser (top greaser on spread); CMI, Auto Grade, CMI Belt Placer & 3 Track and Similar Types; Side Booms; Asphalt Heater & Planer Combination (used to plane

streets); Wheel Tractors (with Dozer, Hoe or Endloader Attachments); CAT Earthwork Compactors and Similar Types; Blaw Knox Spreader and Similar Types; Trench Machines; Pump Crete - Belt Crete - Squeeze Crete - Screw Type Pumps and Gypsum (operator will clean); Creter Crane; Operation of Concrete Pump Truck; Formless Finishing Machines; Flaherty Spreader or Similar Types; Screed Man on Laydown Machine; Vermeer Concrete Saw; Operation of Laser Screed; Span Saw; Dredge Leverman; Dredge Engineer; Lull or Similar Type; Hydro-Boom Truck; Operation of Guard Rail Machine; and Starting Engineer on Pipeline or Construction (11 or more pieces) including: Air Compressor (Trailer Mounted), All Forced Air Heaters (regardless of Size), Water Pumps (Greater than 4-1/2" or Total Discharge Over 4-1/2"), Light Plants, Generators (Trailer Mounted - Excluding Decontamination Trailer), Welding Machines (Any Size or Mode of Power), Conveyor, Mixer (any size), Stud Welder, Power Pac, etc, and Ground Heater (Trailer Mounted).

CLASS 2. Bulker & Pump; Power Launches; Boring Machine & Pipe Jacking Machine; Dinkeys; Operation of Carts, Powered Haul Unit for a Boring Machine; P & H One Pass Soil Cement Machines and Similar Types; Wheel Tractors (Industry or Farm Type - Other); Back Fillers; Euclid Loader; Fork Lifts; Jeep w/Ditching Machine or Other Attachments; Tunneluger; Automatic Cement & Gravel Batching Plants; Mobile Drills - Soil Testing and Similar Types; Pugmill with Pump; All (1) and (2) Drum Hoists; Dewatering System; Straw Blower; Hydro-Seeder; Bump Grinders (self-propelled); Assistant Heavy Equipment Greaser; Apsco Spreader; Tractors (Track-Type) without Power Units Pulling Rollers; Rollers on Asphalt - Brick or Macadam; Concrete Breakers; Concrete Spreaders; Cement Strippers; Cement Finishing Machines & CMI Texture & Reel Curing Machines; Vibro-Tampers (All Similar Types Self-Propelled); Mechanical Bull Floats; Self-Propelled Concrete Saws; Truck Mounted Power Saws; Operation of Curb Cutters; Mixers - Over Three (3) Bags; Winch and Boom Trucks; Tractor Pulling Power Blade or Elevating Grader; Porter Rex Rail; Clary Screed; Mule Pulling Rollers; Pugmill without Pump; Barber Greene or Similar Loaders; Track Type Tractor w/Power Unit attached (minimum); Fireman; Spray Machine on Paving; Curb Machines; Paved Ditch Machine; Power Broom; Self-Propelled Sweepers; Self-Propelled Conveyors; Power Subgrader; Oil Distributor; Straight Tractor; Truck Crane Oiler; Truck Type Oilers; Directional Boring Machine; Horizontal Directional Drill; Articulating End Dump Vehicles; Starting Engineer on Pipeline or Construction (6 -10 pieces) including: Air Compressor (Trailer Mounted), All Forced Air Heaters (regardless of Size), Water Pumps (Greater than 4-1/2" or Total Discharge Over 4-1/2"), Light Plants, Generators (Trailer Mounted - Excluding Decontamination Trailer), Welding Machines (Any Size or Mode of Power), Conveyor, Mixer (any size), Stud Welder, Power Pac, etc., and Ground Heater (Trailer Mounted).

CLASS 3. Straight Framed Truck Mounted Vac Unit (separately powered); Trac Air Machine (without attachments); Rollers - Five Ton and Under on Earth and Gravel; Form Graders; Bulk Cement Plant; Oilers; and Starting Engineer on Pipeline or Construction (3 - 5 pieces) including: Air Compressor (Trailer Mounted), All Forced Air Heaters (regardless of Size), Water Pumps (Greater than 4-1/2" or Total Discharge Over 4-1/2"), Light Plants, Generators (Trailer Mounted - Excluding Decontamination Trailer), Welding Machines (Any Size or Mode of Power), Conveyor, Mixer (any size), Stud Welder, Power Pac, etc., and Ground Heater (Trailer Mounted).

Other Classifications of Work:

For definitions of classifications not otherwise set out, the Department generally has on file such definitions which are available. If a task to be performed is not subject to one of the classifications of pay set out, the Department will upon being

contacted state which neighboring county has such a classification and provide such rate, such rate being deemed to exist by reference in this document. If no neighboring county rate applies to the task, the Department shall undertake a special determination, such special determination being then deemed to have existed under this determination. If a project requires these, or any classification not listed, please contact IDOL at 217-782-1710 for wage rates or clarifications.

LANDSCAPING

Landscaping work falls under the existing classifications for laborer, operating engineer and truck driver. The work performed by landscape plantsman and landscape laborer is covered by the existing classification of laborer. The work performed by landscape operators (regardless of equipment used or its size) is covered by the classifications of operating engineer. The work performed by landscape truck drivers (regardless of size of truck driven) is covered by the classifications of truck driver.