

PLAN

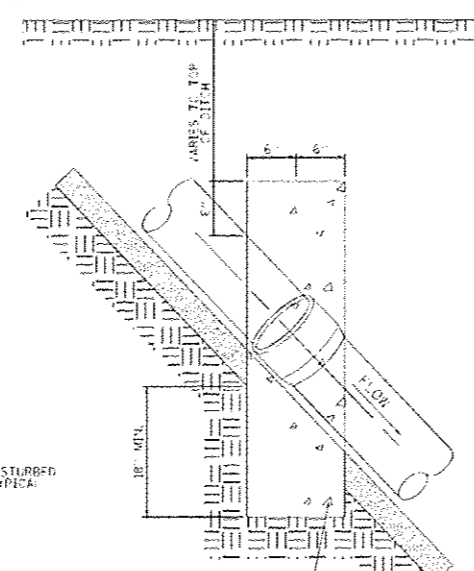

SECTION A-A

CAST-IN-PLACE CONCRETE DETAIL FOR PIPES ON STEEP SLOPES NOT TO SCALE

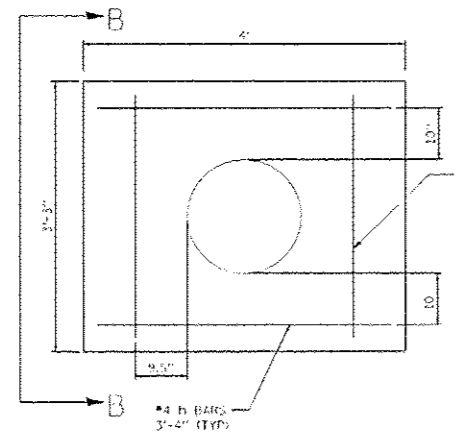

CAST-IN-PLACE CONCRETE WALL DETAIL NOT TO SCALE

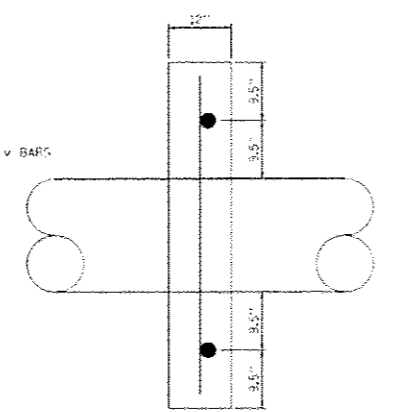

SECTION B-B NOT TO SCALE

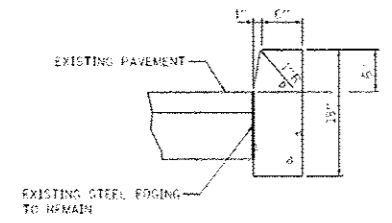

CONCRETE CURB, TYPE B NOT TO SCALE

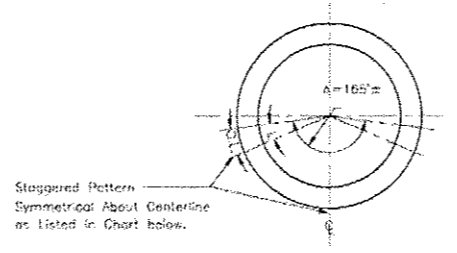

Staggered Pattern Symmetrical About Centerline as Listed in Chart below.

No. of Holes Vary Depending on Diameter; See Chart Below.

Area of Opening Per Foot Comparable to Design Criteria of ASTM C644 Using 1" Holes.

Alternate Design Patterns and/or Openings Available.

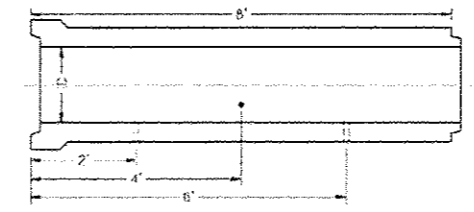

Pipe Dia.	# of Rows	# of 1" Holes Per 8' Length	Sym. Stagger Pattern	Opening ² /FT	L	D.L.
27"	8	12	1/2" / 1/2"	1.2	52"	6 1/2"
30"	8	12	1/2" / 1/2"	1.2	64"	7 1/2"
36"	8	12	1/2" / 1/2"	1.2	72"	9"
42"	10	14	1/2" / 1/2" / 1/2"	1.4	64"	6 1/2"
48"	12	18	2/3" / 2/3" / 2/3"	1.8	64"	7 1/2"
54"	14	20	1/2" / 1/2" / 1/2" / 1/2"	2.0	6"	7 1/2"
60"	14	20	1/2" / 1/2" / 1/2" / 1/2"	2.0	64"	8 1/2"
66"	16	24	2/3" / 2/3" / 2/3" / 2/3"	2.4	64"	7 1/2"
72"	16	24	2/3" / 2/3" / 2/3" / 2/3"	2.4	64"	8 1/2"

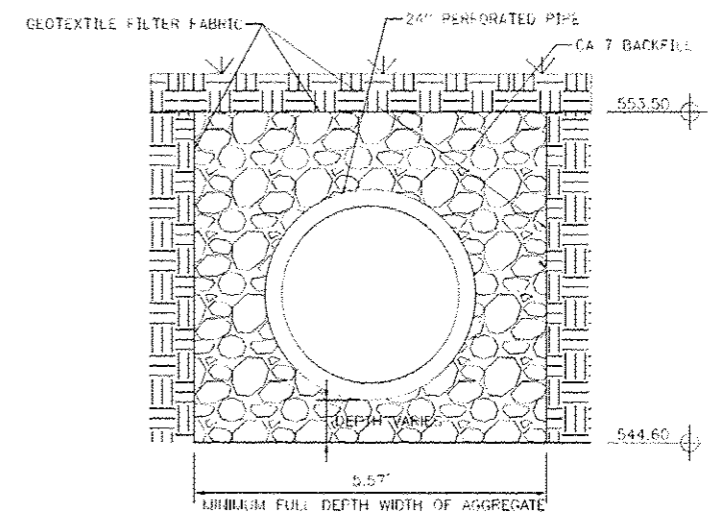

AGGREGATE BACKFILL FOR PERFORATED PIPE NOT TO SCALE

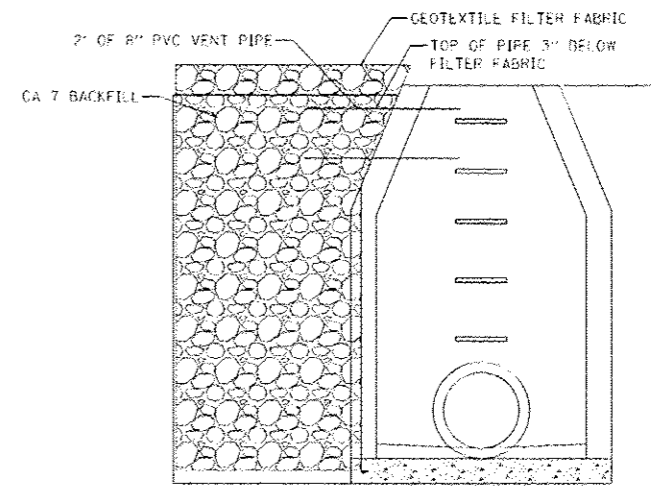

VENT FOR PERFORATED PIPE & AGGREGATE NOT TO SCALE

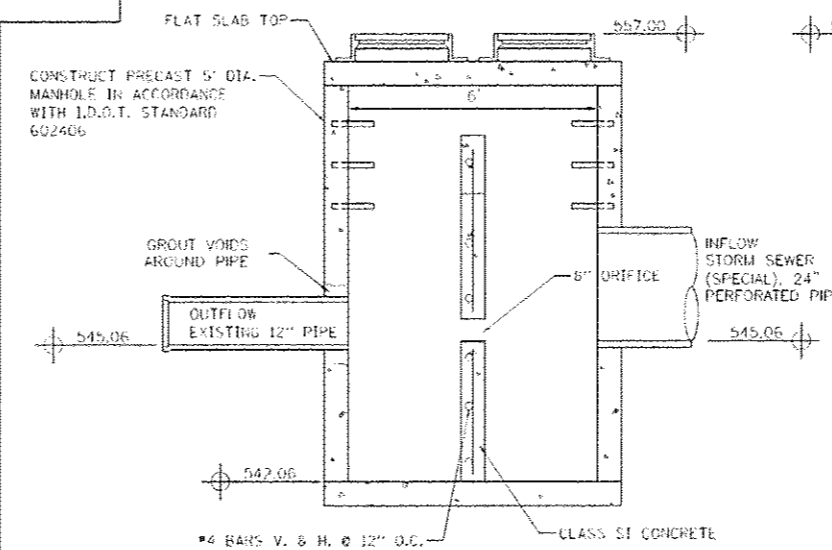

MANHOLE TYPE A, 6' DIA. TYPE I FRAME AND OPEN LID. SPECIAL DETAIL NOT TO SCALE

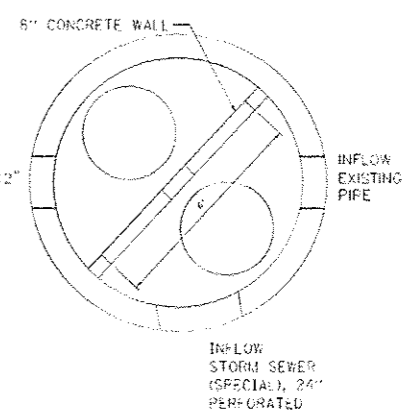
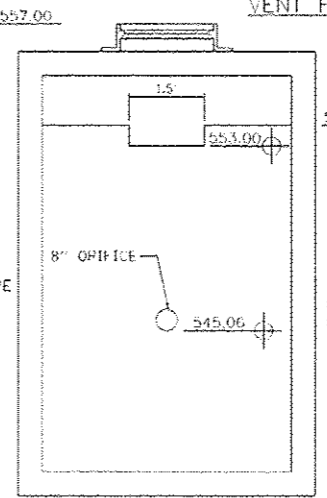

FILE NAME: 0846261-shs24-construction details.dwg	USER NAME: k.vanval	DESIGNED - R.H.D.	REVISED -
Default	Default	DRAWN - S.D.K.	REVISED -
Default	Default	CHECKED - R.H.D.	REVISED -
Default	Default	DATE - 4/25/13	REVISED -

STATE OF ILLINOIS
DEPARTMENT OF TRANSPORTATION

CONSTRUCTION DETAILS		F.A. RTE.	SECTION	COUNTY	TOTAL SHEETS	SHEET NO.
LINCOLN'S TOMB SITE RENOVATIONS			PARK ROADS	SANGAMON	6	4
SCALE:	SHEET 4 OF 6 SHEETS	STA.	TO STA.			

F.A. RTE.	SECTION	COUNTY	TOTAL SHEETS	SHEET NO.
	PARK ROADS	SANGAMON	6	4
CONTRACT NO. 46289				
ILLINOIS FED. AID PROJECT				

JOB NO. 250-081-X VASCONCELLOS ENGINEERING CORP. DESIGN FIRM REGISTRATION NUMBER 184-0020107