

STANDARD DESIGN FOR MILE POST

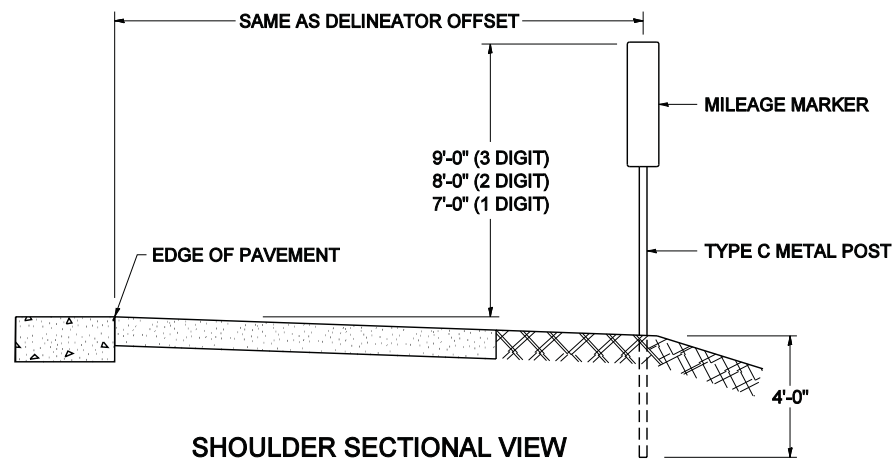

SHOULDER SECTIONAL VIEW

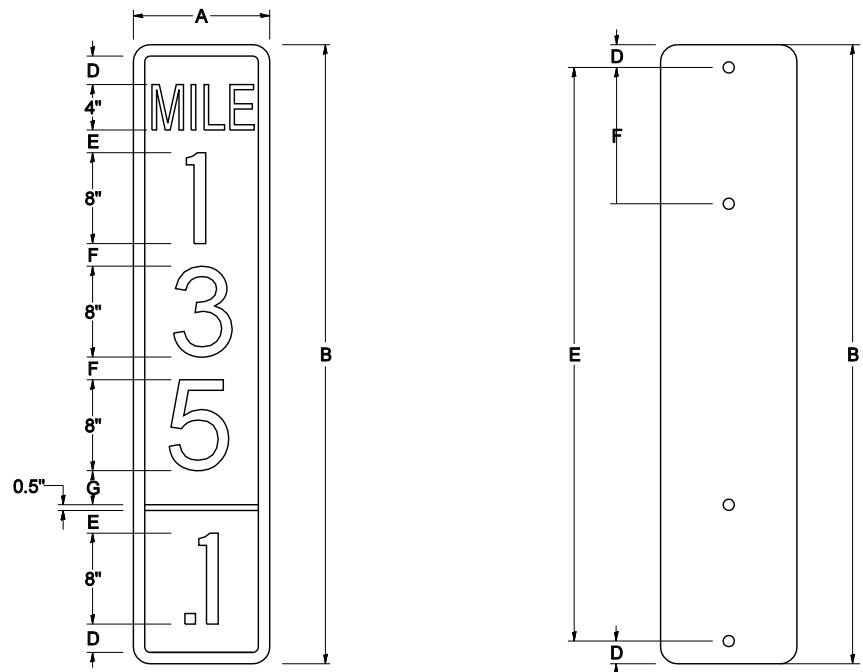

SIGN SIZE	DIMENSIONS							
	A	B	C	D	E	F	G	DIGIT
12 x 24	12.0	24.0	1.5	1.5	1.5	N/A	1.5	1
12 x 36	12.0	36.0	1.5	2.0	2.0	2.0	1.5	2
12 x 48	12.0	48.0	1.5	2.5	2.0	2.0	2.5	3

BLANK	A	B	C	D	E	F
B9-1224	12.0	24.0	1.5	2.0	20.0	N/A
B9-1236	12.0	36.0	1.5	2.0	32.0	12.0
B9-1248	12.0	48.0	1.5	2.0	44.0	12.0

SIGN SIZE	SERIES					BLANK STD.	
	LINES						
	1	2	3	4	5	BORDER	
12 x 24	4C	8D	4C	N/A	N/A	0.5	B9-1224
12 x 36	4C	8D	8D	4C	N/A	0.5	B9-1236
12 x 48	4C	8D	8D	8D	4C	0.5	B9-1248

BORDER AND RADIUS LAYOUT

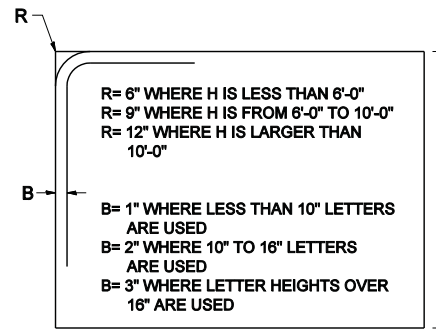

MAJOR GUIDE SIGN LAYOUT

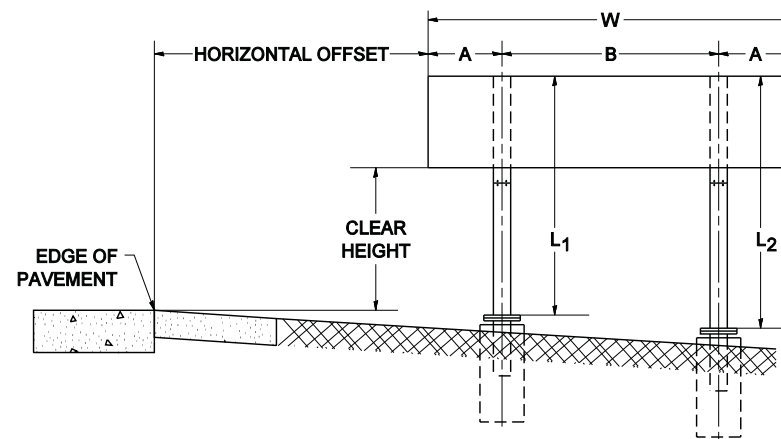

NUMBER OF STEEL SUPPORTS	A	B
2	.2 W	.6 W
3	.15 W	.35 W
4	.125 W	.25 W
5	.1 W	.2 W

"L1" IS THE LENGTH OF SUPPORT, NOT INCLUDING THE STUB PROJECTION, CLOSEST TO THE EDGE OF THE PAVEMENT.

"A" IS THE DISTANCE FROM THE SIGN EDGE TO THE CENTERLINE OF THE NEAREST SUPPORT. "B" IS THE DISTANCE BETWEEN CENTERLINES OF SUPPORTS.

GORE SIGNS

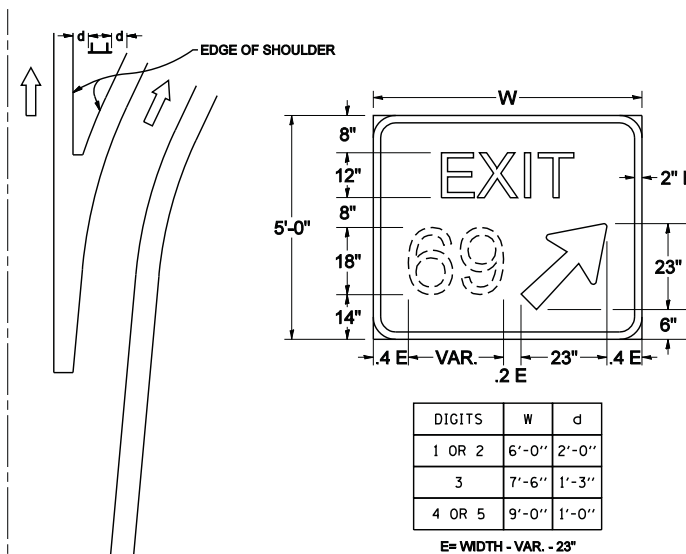

STANDARD ARROWS FOR INTERSTATE GUIDE SIGNS

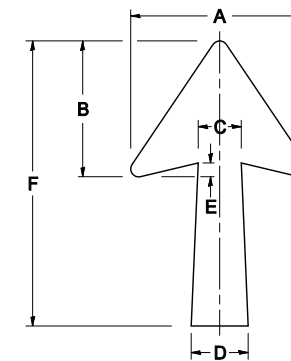

ARROW SYMBOL	A	B	C	D	E	F	R
24 1/4 x 15 1/8	15 1/8	11 1/8	3 3/4	5	1 5/8	2 1/4	1/8
29 1/4 x 18 1/4	18 1/4	14	4 1/2	6	1 1/2	2 9/4	3/4
35 5/8 x 22 1/4	22 1/4	17	5 3/8	7 1/8	1 3/4	35 5/8	1
18 1/4 x 11 1/4	11 1/4	8 3/4	3 1/8	3 3/8		18 1/4	

NOTE: D & F ARE RECOMMENDED DIMENSIONS. TAPER SHOULD BE HELD CONSTANT FOR LONGER OR SHORTER SHAFT LENGTHS

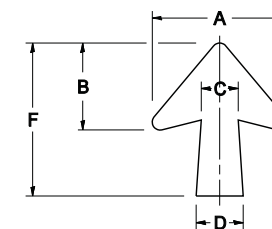

ARROW SYMBOL	A	B	C	D	E	F	R
17 1/4 x 14 1/4	14 1/4	9 3/8	3 3/8	4 1/2	1 5/8	17 1/4	3/4
20 1/4 x 17 1/4	17 1/4	11 3/4	4 3/8	5 5/8	1 1/2	20 1/4	
25 x 21 1/8	21 1/8	14 1/4	5	6 3/4	1 3/4	25	1
9 5/8 x 8 1/8	8 1/8	5 5/8	2 3/8	2 3/8		9 5/8	1/2

DOWN ARROWS

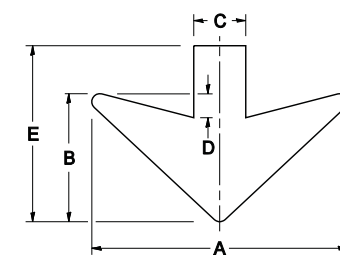

ARROW SYMBOL	A	B	C	D	E	R
16 1/2 x 24	24	12	5	1 1/2	16 1/2	3/4
22 x 32	32	16	6 1/2	3	22	1