

# DIXON MUNICIPAL AIRPORT CHARLES R. WALGREEN FIELD DIXON, ILLINOIS

## CONSTRUCTION PLANS FOR DIXON MUNICIPAL AIRPORT REHABILITATE ELECTRICAL SYSTEM FOR RUNWAY 12/30 AND AIRFIELD SIGNS

### SUMMARY OF QUANTITIES

ITEM NO.	DESCRIPTION	UNIT	ESTIMATED QUANTITY	RECORD QUANTITY
AR108158	1/C #8 5 KV UG CABLE IN UD	L.F.	10,160	
AR110014	4" DIRECTIONAL BORE	L.F.	410	
AR110610	ELECTRICAL HANDHOLE	EACH	1	
AR125100	ELEVATED RETROREFLECTIVE MARKER	EACH	26	
AR125410	MITL - STAKE MOUNTED	EACH	16	
AR125442	TAXI GUIDANCE SIGN, 2 CHARACTER	EACH	1	
AR125443	TAXI GUIDANCE SIGN, 3 CHARACTER	EACH	3	
AR125444	TAXI GUIDANCE SIGN, 4 CHARACTER	EACH	2	
AR125445	TAXI GUIDANCE SIGN, 5 CHARACTER	EACH	4	
AR125446	TAXI GUIDANCE SIGN, 6 CHARACTER	EACH	5	
AR125505	MIRL, STAKE MOUNTED	EACH	17	
AR125510	MIRL, BASE MOUNTED	EACH	8	
AR125512	MIRL, INPAVEMENT	EACH	1	
AR125540	MI THRESHOLD LIGHT STAKE MTD	EACH	12	
AR125555	SPLICE CAN	EACH	4	
AR125901	REMOVE STAKE MOUNTED LIGHT	EACH	57	
AR125902	REMOVE BASE MOUNTED LIGHT	EACH	6	
AR125904	REMOVE TAXI GUIDANCE SIGN	EACH	11	
AR125912	REMOVE RETROREFLECTIVE MARKER	EACH	20	
AR150520	MOBILIZATION	L.S.	1	

### INDEX TO SHEETS

- COVER SHEET
- SITE PLAN / PROJECT CONTROL PLAN
- SEQUENCE OF CONSTRUCTION - PHASE 1  
PER AC 150/5370-2G (LATEST EDITION)
- SEQUENCE OF CONSTRUCTION - PHASE 2  
PER AC 150/5370-2G (LATEST EDITION)
- SEQUENCE OF CONSTRUCTION - PHASE 3  
PER AC 150/5370-2G (LATEST EDITION)
- SEQUENCE OF CONSTRUCTION - GENERAL NOTES
- SEQUENCE OF CONSTRUCTION - GENERAL DETAILS
- EXISTING CONDITIONS AND PROPOSED REMOVALS - SHEET 1
- EXISTING CONDITIONS AND PROPOSED REMOVALS - SHEET 2
- EXISTING CONDITIONS AND PROPOSED REMOVALS - SHEET 3
- EXISTING CONDITIONS AND PROPOSED REMOVALS - SHEET 4
- AIRFIELD LIGHTING PLAN - SHEET 1
- AIRFIELD LIGHTING PLAN - SHEET 2
- AIRFIELD LIGHTING PLAN - SHEET 3
- AIRFIELD LIGHTING PLAN - SHEET 4
- ELECTRICAL DETAILS - SHEET 1
- ELECTRICAL DETAILS - SHEET 2
- ELECTRICAL DETAILS - SHEET 3
- ELECTRICAL DETAILS - SHEET 4
- EROSION CONTROL PLAN



Know what's below.  
Call before you dig.

J.U.L.I.E.  
JOINT UTILITY LOCATING  
INFORMATION FOR EXCAVATORS  
www.illinois1call.com

THE LOCATION, SIZE AND TYPE OF MATERIAL OF EXISTING UNDERGROUND UTILITIES INDICATED ON THE PLANS IS NOT REPRESENTED AS BEING ACCURATE, SUFFICIENT OR COMPLETE IT SHALL BE THE CONTRACTOR'S RESPONSIBILITY TO DETERMINE ACTUAL LOCATIONS OF ALL SUCH FACILITIES, INCLUDING SERVICE CONNECTIONS TO UNDERGROUND UTILITIES. PRIOR TO CONSTRUCTION, THE CONTRACTOR SHALL NOTIFY UTILITY COMPANIES OF HIS OPERATIONAL PLANS, OBTAIN FROM RESPECTIVE UTILITY COMPANIES DETAILED INFORMATION AND ASSISTANCE RELATIVE TO THE LOCATION OF THEIR FACILITIES AND THE WORKING SCHEDULE OF THE COMPANIES FOR REMOVAL OR ADJUSTMENT WHERE REQUIRED. IN THE EVENT AN UNEXPECTED UTILITY INTERFERENCE IS ENCOUNTERED DURING CONSTRUCTION, THE CONTRACTOR SHALL IMMEDIATELY NOTIFY THE UTILITY COMPANY OF JURISDICTION AND THE ONE-CALL NOTICE SYSTEM. THE ENGINEER SHALL ALSO BE IMMEDIATELY NOTIFIED. ANY SUCH UTILITY OR SERVICES SHALL BE RESTORED TO SERVICE AT ONCE AND PAID FOR BY THE CONTRACTOR AT NO ADDITIONAL COST TO THE CONTRACT.

CALL J.U.L.I.E. FOR UTILITY INFORMATION AT 811.

ILLINOIS PROJECT: C73-4258  
 SBG PROJECT: 3-17-SBGP-105/111/120

APRIL 19, 2019



D. Kyle Peabody  
 4-19-19  
 EXP: 11-30-19

DIXON MUNICIPAL AIRPORT

PROJECT LOCATION

©Copyright CMT, Inc. 180244-02-00

**CMT**  
 CRAWFORD, MURPHY & TILLY, INC.  
 CONSULTING ENGINEERS  
 License No. 184-000613

SUBMITTED BY D. Kyle Peabody  
 D. KYLE PEABODY, P.E.

DATE 4-19-19

DIXON MUNICIPAL AIRPORT  
 CHARLES R. WALGREEN FIELD  
 DIXON, ILLINOIS

Matthew S. Heckman  
 MATTHEW S. HECKMAN  
 PUBLIC WORKS DIRECTOR/ASSISTANT CITY MANAGER

DATE 4/18/19

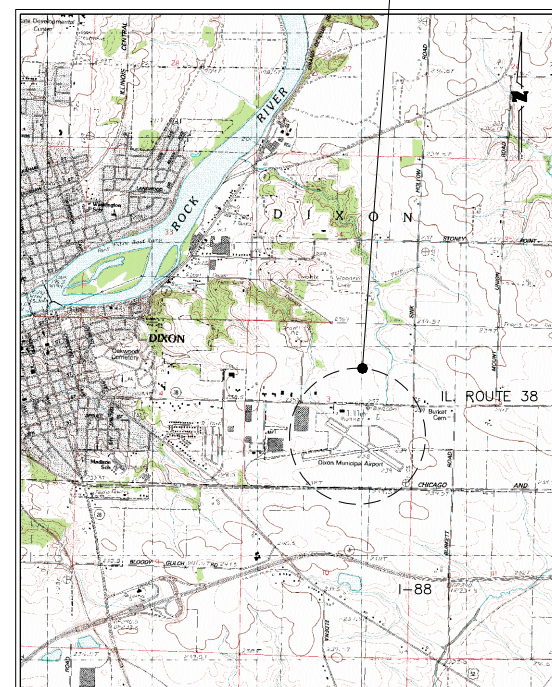

LOCATION MAP

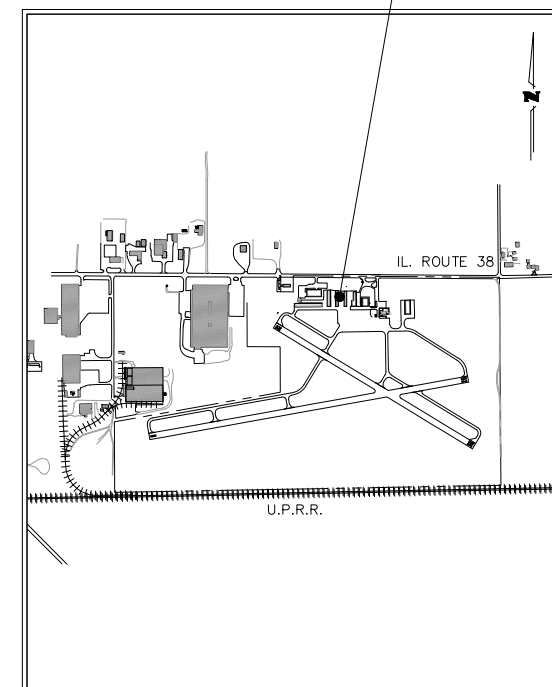

SITE PLAN

DESIGN INFORMATION

APPROACH CATEGORY B  
 DESIGN GROUP I

DIXON MUNICIPAL AIRPORT

TOWNSHIP: 21 NORTH  
 RANGE: 9 EAST  
 LEE COUNTY

DIXON TOWNSHIP  
 (SECTION: 3)  
 OPPOSITE LINCOLN HIGHWAY 38  
 (FRANKLIN GROVE ROAD)

UNICOM RADIO FREQUENCY - 123.05

DATE: Friday, April 19, 2019 9:41:48 AM  
 FILE: K:\Dixon\18094402-00\_Highway12-30\Draw\_Sheets\Site Plan And Project Control Plan.dwg  
 UPDATE BY: Robert Heinz  
 LAYOUT: Layout1  
 REF DWG: Dixon-base.dwg  
 BENCH: 18094402-00.dwg

**LEGEND**

- EXISTING BUILDING
- EXISTING PAVEMENT
- EXISTING RUNWAY 8/26 CIRCUIT 1/C #8 5KV IN 3/4" UNIT DUCT
- NEW RUNWAY 12/30 CIRCUIT 1/C #8 5KV IN 3/4" UNIT DUCT
- AIRPORT PROPERTY LINE
- NEW 4" CONDUIT (BORED & JACKED)
- EXISTING CONDUIT
- NEW STAKE MOUNTED MEDIUM INTENSITY RUNWAY LIGHT
- NEW BASE MOUNTED MEDIUM INTENSITY RUNWAY LIGHT
- NEW STAKE MOUNTED MEDIUM INTENSITY THRESHOLD LIGHT
- NEW HANDHOLE
- NEW AIRFIELD GUIDANCE SIGN



IL. CONTRACT: **D1029**  
 IL. LETTING ITEM: **01A**  
 IL. PROJECT: **C73-4258**  
 S.B.G. PROJECT: **3-17-SBGP-105/11/120**

SURVEY BOOK #

REVISIONS		
NUMBER	BY	DATE

0 1 2  
 THIS BAR IS EQUAL TO 2" AT FULL SCALE (34X22).

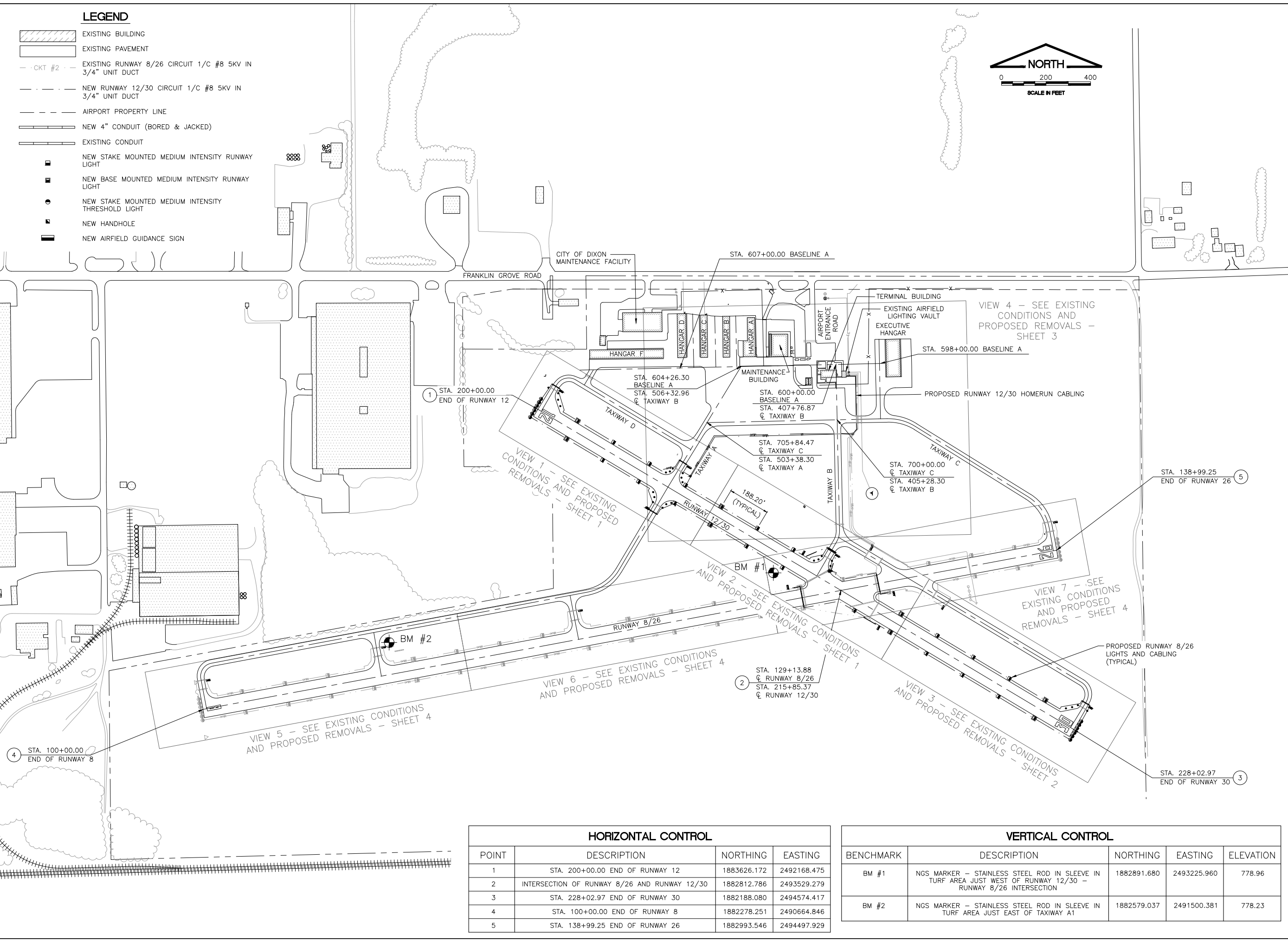

**DIXON MUNICIPAL AIRPORT**  
**DIXON, ILLINOIS**  
**REHABILITATE ELECTRICAL SYSTEM FOR RUNWAY 12/30**  
**SITE PLAN / PROJECT CONTROL PLAN**

© Copyright, CMT, Inc.

CRAWFORD, MURPHY & TILLY, INC.  
 CONSULTING ENGINEERS  
 License No. 184-000613

DESIGN BY:	RMH
DRAWN BY:	RMH
CHECKED BY:	DKP
APPROVED BY:	DKP
DATE:	4/19/19
JOB No:	180244-02

FINAL

**HORIZONTAL CONTROL**

POINT	DESCRIPTION	NORTHING	EASTING
1	STA. 200+00.00 END OF RUNWAY 12	1883626.172	2492168.475
2	INTERSECTION OF RUNWAY 8/26 AND RUNWAY 12/30	1882812.786	2493529.279
3	STA. 228+02.97 END OF RUNWAY 30	1882188.080	2494574.417
4	STA. 100+00.00 END OF RUNWAY 8	1882278.251	2490664.846
5	STA. 138+99.25 END OF RUNWAY 26	1882993.546	2494497.929

**VERTICAL CONTROL**

BENCHMARK	DESCRIPTION	NORTHING	EASTING	ELEVATION
BM #1	NGS MARKER - STAINLESS STEEL ROD IN SLEEVE IN TURF AREA JUST WEST OF RUNWAY 12/30 - RUNWAY 8/26 INTERSECTION	1882891.680	2493225.960	778.96
BM #2	NGS MARKER - STAINLESS STEEL ROD IN SLEEVE IN TURF AREA JUST EAST OF TAXIWAY A1	1882579.037	2491500.381	778.23



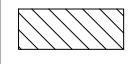









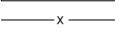

DATE: Friday, April 19, 2019 9:42:27 AM  
 FILE: K:\Dixon\18024402-00 Lighting\12-30\Draw Sheets\Sequence of Construction - Sheet 1.dwg  
 UPDATE BY: Robert Heinz  
 LAYOUT: Layout1  
 IMAGE FILES:  
 KREF DWG: Dixon-base.dwg  
 BENCH: 180244-00-00

WORK AREA	ALLOWABLE WORK PERIOD	OPERATION STATUS/RESTRICTIONS
1 	NO RESTRICTIONS	RUNWAY 8/26 OPEN RUNWAY 12/30 CLOSED TAXIWAY A CLOSED NORTH OF TAXIWAY A2 TAXIWAY C OPEN ALL OTHER TAXIWAYS CLOSED

**NOTES**

- WHEN HAUL ROUTE IS IN USE ON ACTIVE AIRFIELD PAVEMENTS, THE CONTRACTOR WILL BE REQUIRED TO HAVE A CROSSING GUARD FOR CONSTRUCTION PERSONNEL, CONSTRUCTION TRAFFIC, CONTRACTORS VEHICLES AND EQUIPMENT CROSSING BY, TO OR FROM WORK ZONE. STOP SIGNS SHALL BE IN PLACE AT ALL TIMES IN THIS AREA. THIS WORK SHALL BE INCIDENTAL TO THE CONTRACT.
- RUNWAY 12/30 SHALL STAY CLOSED FOR THE DURATION OF PHASE 1.
- SEE CONSTRUCTION POINT TABLE ON SHEET 6.

**LEGEND**

-  CONTRACTOR'S STAGING AND STORAGE AREA
-  EXISTING BUILDING
-  EXISTING PAVEMENT
-  EXISTING FENCE
-  RIGHT OF WAY (R.O.W.)
-  AIRPORT PROPERTY LINE
-  TAXIWAY OBJECT FREE AREA (TOFA)
-  RUNWAY OBSTACLE FREE ZONE (ROFZ)
-  AIRCRAFT MOVEMENT AREA
-  CONTRACTOR'S ACCESS/HAUL ROAD
-  TEMPORARY CLOSED TAXIWAY MARKER
-  TEMPORARY CLOSED RUNWAY MARKER
-  WORK AREA NUMBER
-  TEMPORARY TYPE II BARRICADES WITH RED FLASHING LIGHT
-  CROSSING GUARD STOP-A.O.A. SIGN (SEE NOTE 1) OR CONTRACTOR'S ESCORT WITH RADIO



IL. CONTRACT: **D1029**  
 IL. LETTING ITEM: **01A**  
 IL. PROJECT: **C73-4258**  
 S.B.G. PROJECT: **3-17-SBGP-105/11/120**

SURVEY BOOK #

REVISIONS		
NUMBER	BY	DATE

0 1 2  
 THIS BAR IS EQUAL TO 2" AT FULL SCALE (34X22).

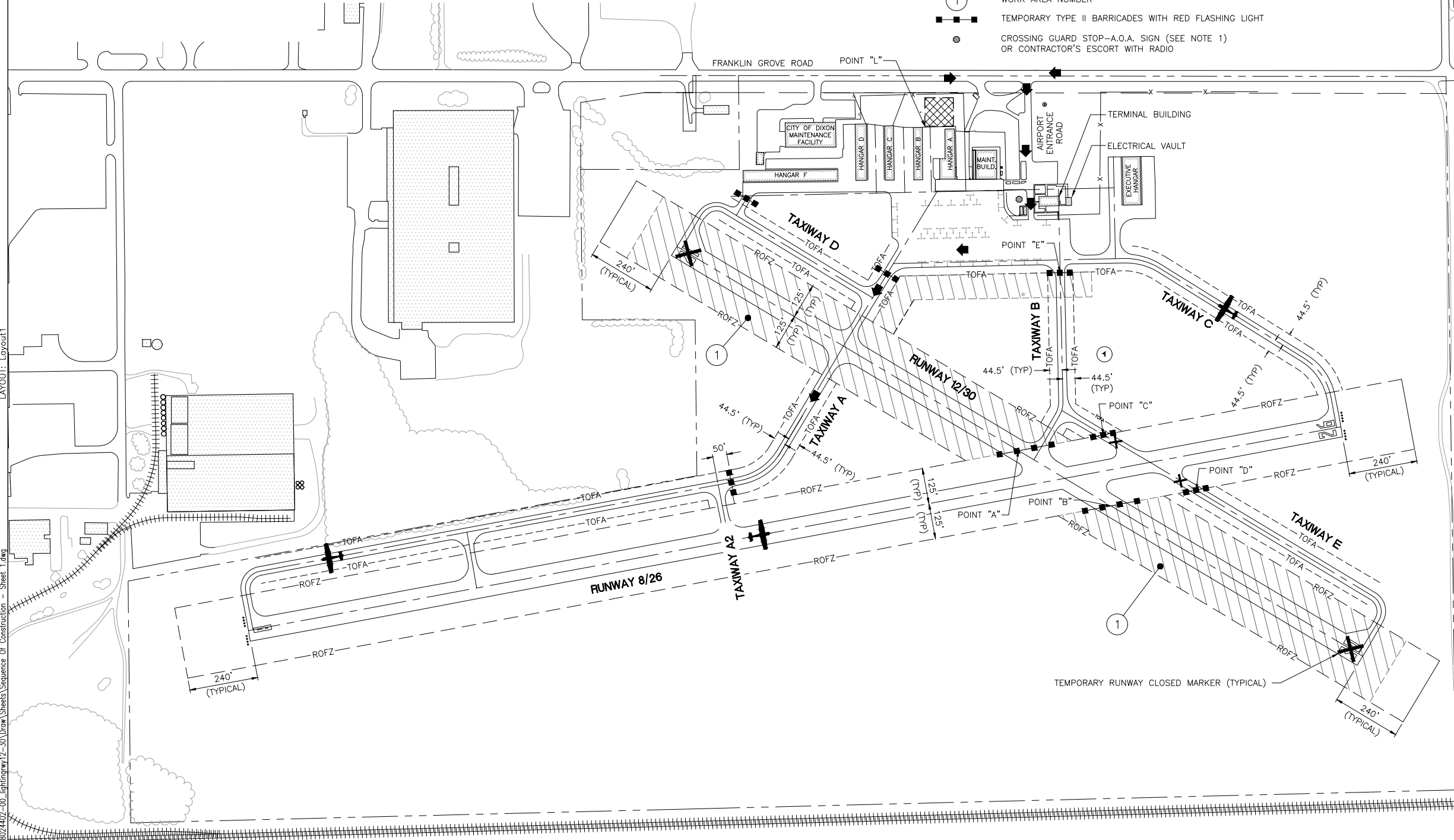

**DIXON MUNICIPAL AIRPORT**  
**DIXON, ILLINOIS**  
**REHABILITATE ELECTRICAL SYSTEM FOR RUNWAY 12/30**  
**SEQUENCE OF CONSTRUCTION - PHASE 1**  
**PER AC 150/5370-2G (LATEST EDITION)**

© Copyright, CMT, Inc.



**CMT**  
 CRAWFORD, MURPHY & TILLY, INC.  
 CONSULTING ENGINEERS  
 License No. 184-000613

DESIGN BY:	RMH
DRAWN BY:	RMH
CHECKED BY:	DKP
APPROVED BY:	DKP
DATE:	4/19/19
JOB No:	180244-02

**FINAL**



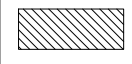







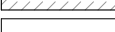
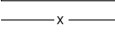

DATE: Friday, April 19, 2019 9:43:07 AM  
 FILE: K:\Dixon\18024402-00 Lighting\12-30\Draw Sheets\Sequence of Construction - Sheet 2.dwg  
 UPDATE BY: Robert Heinz  
 LAYOUT: Layout1  
 IMAGE FILES:  
 KREF DWG: Dixon-base.dwg  
 BENCH: 180244-00.dwg

WORK AREA	ALLOWABLE WORK PERIOD	OPERATION STATUS/RESTRICTIONS
2 	WORK WITHIN AREA WILL BE EXPEDITED, ONLY 3 CALENDAR DAYS ALLOWED TO COMPLETE WORK	RUNWAY 12/30 CLOSED RUNWAY 8/26 CLOSED ALL TAXIWAYS CLOSED

**NOTES**

- WHEN HAUL ROUTE IS IN USE ON ACTIVE AIRFIELD PAVEMENTS, THE CONTRACTOR WILL BE REQUIRED TO HAVE A CROSSING GUARD FOR CONSTRUCTION PERSONNEL, CONSTRUCTION TRAFFIC, CONTRACTORS VEHICLES AND EQUIPMENT CROSSING BY, TO OR FROM WORK ZONE. STOP SIGNS SHALL BE IN PLACE AT ALL TIMES IN THIS AREA. THIS WORK SHALL BE INCIDENTAL TO THE CONTRACT.
- BOTH RUNWAYS ARE TO STAY CLOSED FOR THE DURATION OF PHASE 2.
- SEE CONSTRUCTION POINT TABLE ON SHEET 6.

**LEGEND**

-  CONTRACTOR'S STAGING AND STORAGE AREA
-  EXISTING BUILDING
-  EXISTING PAVEMENT
-  EXISTING FENCE
-  RIGHT OF WAY (R.O.W.)
-  AIRPORT PROPERTY LINE
-  TAXIWAY OBJECT FREE AREA (TOFA)
-  RUNWAY OBSTACLE FREE ZONE (ROFZ)
-  AIRCRAFT MOVEMENT AREA
-  CONTRACTOR'S ACCESS/HAUL ROAD
-  TEMPORARY CLOSED TAXIWAY MARKER
-  TEMPORARY CLOSED RUNWAY MARKER
-  WORK AREA NUMBER
-  TEMPORARY TYPE II BARRICADES WITH RED FLASHING LIGHT
-  CROSSING GUARD STOP-A.O.A. SIGN (SEE NOTE 1) OR CONTRACTOR'S ESCORT WITH RADIO



IL. CONTRACT: **D1029**  
 IL. LETTING ITEM: **01A**  
 IL. PROJECT: **C73-4258**  
 S.B.G. PROJECT: **3-17-SBGP-105/11/120**

SURVEY BOOK #

REVISIONS		
NUMBER	BY	DATE

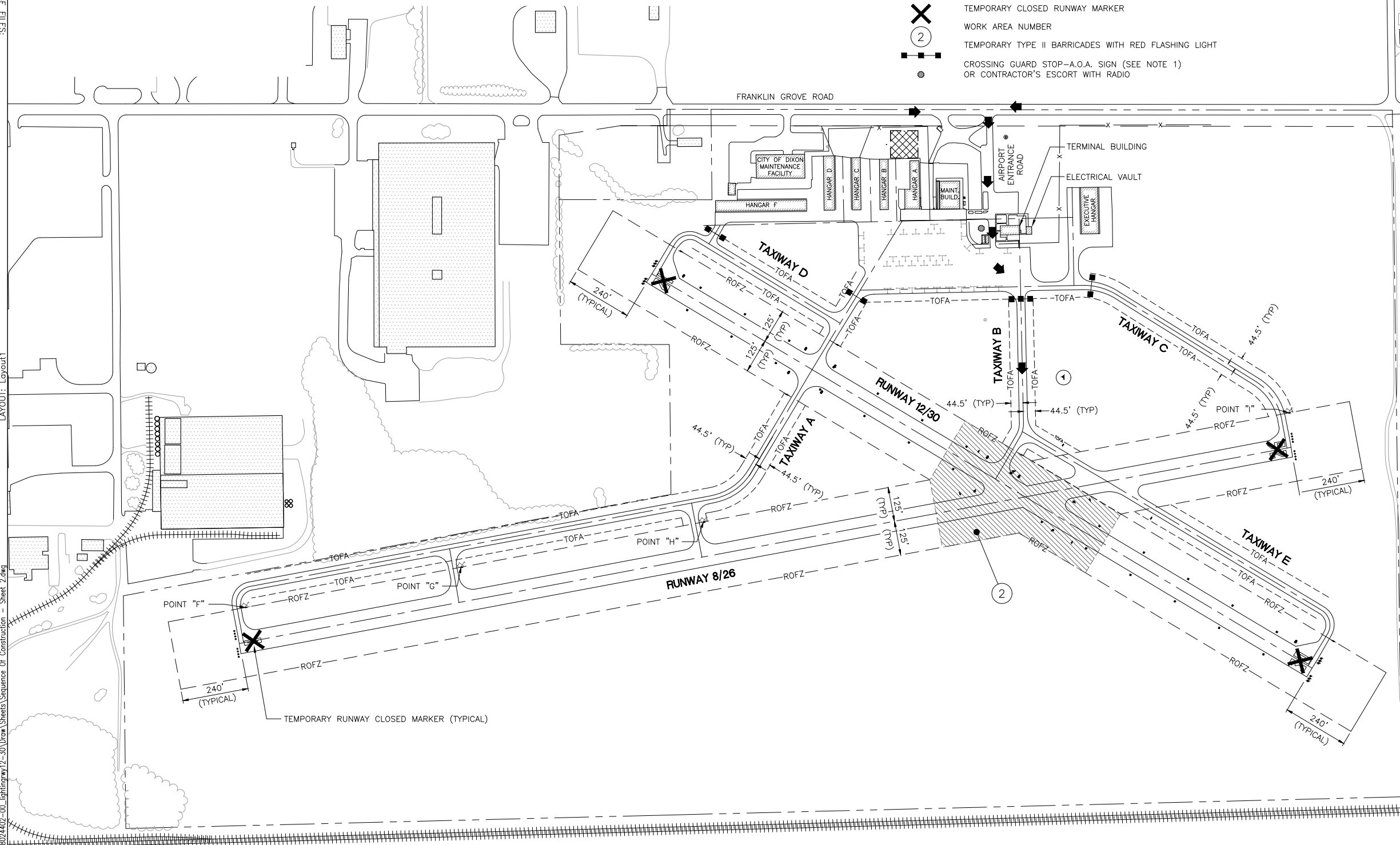
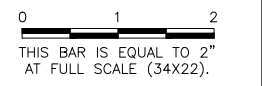

**DIXON MUNICIPAL AIRPORT**  
**DIXON, ILLINOIS**  
**REHABILITATE ELECTRICAL SYSTEM FOR RUNWAY 12/30**  
**SEQUENCE OF CONSTRUCTION - PHASE 2**  
**PER AC 150/5370-2G (LATEST EDITION)**

© Copyright, CMT, Inc.



**CMT**  
 CRAWFORD, MURPHY & TILLY, INC.  
 CONSULTING ENGINEERS  
 License No. 184-000613

DESIGN BY:	RMH
DRAWN BY:	RMH
CHECKED BY:	DKP
APPROVED BY:	DKP
DATE:	4/19/19
JOB No:	180244-02

**FINAL**





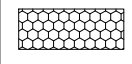









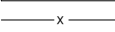

DATE: Friday, April 19, 2019 9:43:48 AM  
 FILE: K:\Dixon\18024402-00 Lighting\12-30\Draw Sheets\Sequence Of Construction - Sheet 3.dwg  
 UPDATE BY: Robert Heinz  
 LAYOUT: Layout1  
 IMAGE FILES:  
 KREF DWG: Dixon-180244-00.dwg

WORK AREA	ALLOWABLE WORK PERIOD	OPERATION STATUS/RESTRICTIONS
3 	WORK WITHIN AREA WILL BE EXPEDITED. ONLY 2 CALENDAR DAYS ALLOWED TO COMPLETE WORK.	RUNWAY 8/26 OPEN RUNWAY 12/30 OPEN TAXIWAY C CLOSED ALL OTHER TAXIWAYS OPEN

**NOTES**

- WHEN HAUL ROUTE IS IN USE ON ACTIVE AIRFIELD PAVEMENTS, THE CONTRACTOR WILL BE REQUIRED TO HAVE A CROSSING GUARD FOR CONSTRUCTION PERSONNEL, CONSTRUCTION TRAFFIC, CONTRACTORS VEHICLES AND EQUIPMENT CROSSING BY, TO OR FROM WORK ZONE. STOP SIGNS SHALL BE IN PLACE AT ALL TIMES IN THIS AREA. THIS WORK SHALL BE INCIDENTAL TO THE CONTRACT.
- SEE CONSTRUCTION POINT TABLE ON SHEET 6.

**LEGEND**

-  CONTRACTOR'S STAGING AND STORAGE AREA
-  EXISTING BUILDING
-  EXISTING PAVEMENT
-  EXISTING FENCE
-  RIGHT OF WAY (R.O.W.)
-  AIRPORT PROPERTY LINE
-  TAXIWAY OBJECT FREE AREA (TOFA)
-  RUNWAY OBSTACLE FREE ZONE (ROFZ)
-  AIRCRAFT MOVEMENT AREA
-  CONTRACTOR'S ACCESS/HAUL ROAD
-  TEMPORARY CLOSED TAXIWAY MARKER
-  TEMPORARY CLOSED RUNWAY MARKER
-  WORK AREA NUMBER
-  TEMPORARY TYPE II BARRICADES WITH RED FLASHING LIGHT
-  CROSSING GUARD STOP-A.O.A. SIGN (SEE NOTE 1) OR CONTRACTOR'S ESCORT WITH RADIO

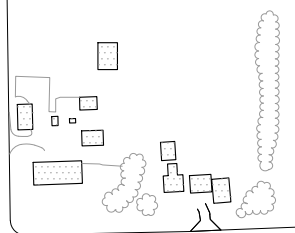

IL. CONTRACT: **D1029**  
 IL. LETTING ITEM: **01A**  
 IL. PROJECT: **C73-4258**  
 S.B.G. PROJECT: **3-17-SBGP-105/11/120**

SURVEY BOOK #

REVISIONS		
NUMBER	BY	DATE

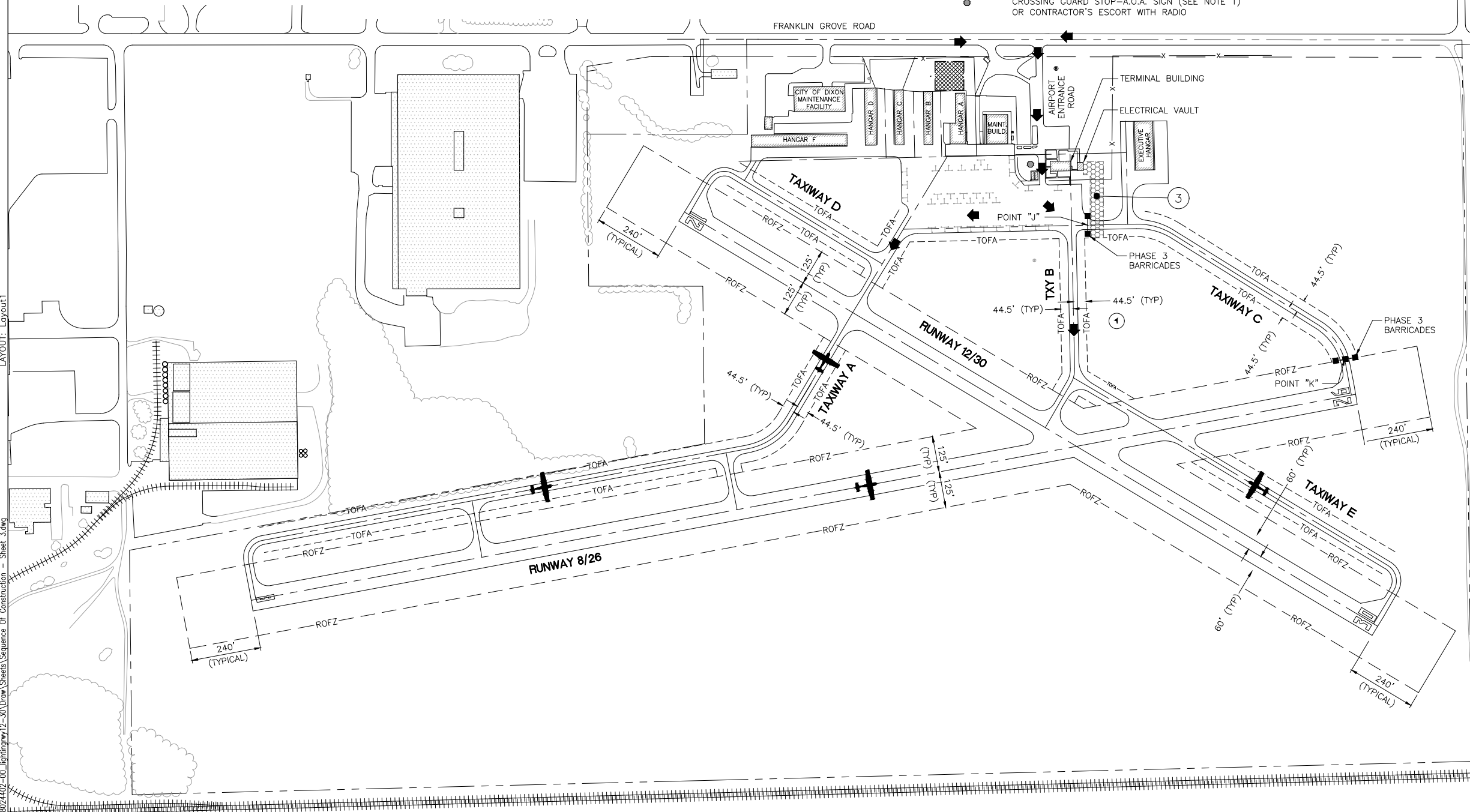
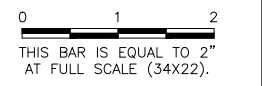

**DIXON MUNICIPAL AIRPORT**  
**DIXON, ILLINOIS**  
**REHABILITATE ELECTRICAL SYSTEM FOR RUNWAY 12/30**  
**SEQUENCE OF CONSTRUCTION - PHASE 3**  
**PER AC 150/5370-2G (LATEST EDITION)**

© Copyright, CMT, Inc.



**CMT**  
 CRAWFORD, MURPHY & TILLY, INC.  
 CONSULTING ENGINEERS  
 License No. 184-000613

DESIGN BY:	RMH
DRAWN BY:	RMH
CHECKED BY:	DKP
APPROVED BY:	DKP
DATE:	4/19/19
JOB No:	180244-02

**FINAL**

DATE: Friday, April 19, 2019 9:44:27 AM  
FILE: K:\Dixon\180244-00 Lighting\12-30\Draw Sheets\Sequence of Construction General Notes And Details.dwg  
UPDATE BY: Robert Heinz  
LAYOUT: Layout1  
IMAGE FILES:  
REF DWG: bchm\_180244-02.dwg

### GENERAL NOTES

- THE SUGGESTED SEQUENCE OF CONSTRUCTION SHOWN IS INTENDED TO ALLOW FOR THE ORDERLY CONSTRUCTION OF THE PROPOSED IMPROVEMENTS WHILE MAINTAINING AIRCRAFT ACCESS AT ALL TIMES. THE PHASING SHOWN IS A SUGGESTED SEQUENCE OF CONSTRUCTION ONLY. THIS SEQUENCE MAY BE MODIFIED HOWEVER, ALTERNATE STAGING PLANS MUST MAINTAIN AIRPORT OPERATIONS TO THE SATISFACTION OF THE AIRPORT MANAGER AND RESIDENT ENGINEER AND BE APPROVED BY THE DIVISION OF AERONAUTICS AND FEDERAL AVIATION ADMINISTRATION.
- THE CONTRACTOR SHALL SUBMIT A SAFETY PLAN COMPLIANCE DOCUMENT (SPCD) CONFIRMING COMPLIANCE WITH THE CONSTRUCTION SAFETY PHASING PLAN (CSPP) PRIOR TO THE ISSUANCE OF THE NOTICE TO PROCEED AS SPECIFIED IN FAA AX 150/5370-2 (LATEST EDITION).
- ALL OPERATIONS SHALL BE IN CONFORMANCE WITH AC 150/5370-2G (LATEST EDITION) OPERATIONAL SAFETY ON AIRPORTS DURING CONSTRUCTION.
- CONTRACTOR'S EQUIPMENT SHALL BE STORED IN THE EQUIPMENT AND MATERIAL STORAGE AREA WHEN CONSTRUCTION IS NOT IN PROGRESS.
- THE AIRPORT MANAGER IN CONSULTATION WITH THE RESIDENT ENGINEER SHALL HAVE FINAL SAY IN THE APPROVAL OF THE CONSTRUCTION OPERATING SEQUENCE AS IT RELATES TO PEDESTRIAN, VEHICULAR AND AIRCRAFT SAFETY.
- ALL EXISTING PAVEMENTS, DRIVES OR ANY OTHER AREAS USED AS A HAUL ROAD OR STORAGE AREA BY THE CONTRACTOR SHALL BE RESTORED IN KIND TO THEIR PRE-CONSTRUCTION CONDITION OR TO THE SATISFACTION OF THE RESIDENT ENGINEER AND AIRPORT MANAGER. THE COST OF MAINTAINING, REPAIRING OR CONSTRUCTING THESE PAVEMENTS AND AREAS SHALL BE INCIDENTAL TO THE CONTRACT. EXISTING AREAS OUTSIDE THE PROJECT LIMITS WHICH ARE DISTURBED BY THE CONTRACTOR'S OPERATIONS SHALL BE RESTORED BY HIM AT HIS EXPENSE TO THE SATISFACTION OF THE RESIDENT ENGINEER AND THE AIRPORT MANAGER.
- THE CONTRACTOR SHALL KEEP ALL TRUCKS, EQUIPMENT AND MATERIALS OFF OF THE EXISTING TAXIWAYS, APRONS AND RUNWAYS OUTSIDE OF THE PROJECT LIMITS EXCEPT AS SHOWN OR WITH THE PRIOR PERMISSION OF THE ENGINEER.
- WORK PERFORMED BY THE CONTRACTOR OUTSIDE OF DAYLIGHT HOURS SHALL BE DONE UNDER SUFFICIENT ARTIFICIAL LIGHTING TO ALLOW FOR PROPER CONSTRUCTION METHODS AND INSPECTIONS. LIGHT SHALL CONSIST OF MOVABLE POLE MOUNTED FLOODLIGHTS AND/OR SPOTLIGHTS OF SUFFICIENT NUMBER TO ILLUMINATE THE WORK AREA. VEHICLE HEADLIGHTS WILL BE ALLOWED ONLY IN ADDITION TO OTHER LIGHTS MENTIONED ABOVE. LIGHTING SHALL BE AS APPROVED BY THE ENGINEER AND SHALL NOT BE USED IF THEY AFFECT FLIGHT SAFETY. CONTRACTOR'S WORK HOURS SHALL BE IN ACCORDANCE WITH LOCAL ORDINANCES.
- THE CONTRACTOR SHALL PROVIDE PORTABLE FLOOD LIGHTING FOR NIGHTTIME CONSTRUCTION. SUFFICIENT UNITS SHALL BE PROVIDED SO THAT WORK AREAS ARE ILLUMINATED TO A LEVEL OF FIVE HORIZONTAL FOOT CANDLES. THE LIGHTING LEVELS SHALL BE CALCULATED AND MEASURED IN ACCORDANCE WITH THE CURRENT STANDARDS OF THE ILLUMINATION ENGINEERING SOCIETY. LIGHTS SHALL BE POSITIONED SO AS NOT TO INTERFERE WITH AIRPORT OPERATIONS.
- THE CONTRACTOR WILL BE REQUIRED TO HAVE A SWEEPER AVAILABLE FOR USE AT ALL TIMES. WHEN ACTIVE AIRFIELD PAVEMENTS ARE UTILIZED AS HAUL ROADS BY THE CONTRACTOR, MATERIAL TRACKED ON TO THE PAVEMENT SHALL BE CONTINUALLY REMOVED WITH SAID SWEEPER. THIS SWEEPING SHALL NOT BE PAID FOR SEPARATELY BUT SHALL BE CONSIDERED INCIDENTAL TO AR150520 MOBILIZATION.
- MATERIALS REMOVED FROM THE PROJECT WILL BE DISPOSED OF OFF AIRPORT PROPERTY, UNLESS NOTED OTHERWISE.
- PAYMENT FOR TRAFFIC CONTROL INCLUDING, BUT NOT LIMITED TO BARRICADES, SIGNING, TAXIWAY AND RUNWAY CLOSED MARKERS, AIR OPERATIONS AREA (A.O.A.) LATHE AND RIBBON, ETC. SHALL NOT BE PAID SEPARATELY, BUT SHALL BE CONSIDERED INCIDENTAL TO THE CONTRACT. BARRICADES SHALL BE PLACED AT THE LOCATIONS SHOWN ON THE PLANS OR AS DIRECTED BY THE ENGINEER. BARRICADES SHALL BE WEIGHTED TO PREVENT BLOWING OVER. BARRICADES SHALL HAVE A STEADY BURN OR FLASHING RED LIGHT. BARRICADE INSTALLATION WILL BE REQUIRED PRIOR TO ACCESS TO THE A.O.A. BY CONTRACTOR'S WORKERS, EQUIPMENT OR MATERIAL. SIGNS SHALL BE PLACED AT EACH TAXIWAY/RUNWAY CLOSURE LOCATION AND SHALL BE ATTACHED TO THE BARRICADES. EACH BARRICADE LOCATION SHALL CONSIST OF ONE "DO NOT ENTER" SIGN AND ONE "AIRCRAFT MOVEMENT AREA" SIGN. SIGNS SHALL BE CONSIDERED INCIDENTAL TO THE CONTRACT.
- THE CONTRACTOR SHALL CONTACT THE AIRPORT MANAGER (5) WORKING DAYS IN ADVANCE OF THE START OF CONSTRUCTION SO THAT THE APPROPRIATE NOTAMS MAY BE ISSUED.
- THE CONTRACTOR SHALL BE RESPONSIBLE FOR KEEPING ALL CONSTRUCTION ACCESS GATES CLOSED DURING NON WORKING HOURS. THE CONTRACTOR SHALL PROVIDE A SIGN AT THE ACCESS GATE SAYING "AUTHORIZED PERSONNEL ONLY". THE CONTRACTOR SHALL CLOSE AND LOCK THE ACCESS GATE UPON LEAVING THE SITE. THROUGHOUT THE DURATION OF THE CONTRACT, ANY DAMAGES TO THE ACCESS ROAD, ACCESS GATE OR FENCING ADJACENT TO THE PROJECT SHALL BE REPAIRED BY THE CONTRACTOR TO THE SATISFACTION OF THE RESIDENT ENGINEER. ALL COST RELATING TO CONTRACTOR'S ACCESS AND SECURITY SHALL BE THE RESPONSIBILITY OF THE CONTRACTOR.
- CONTRACTOR WILL BE REQUIRED TO PUT AIRPORT FLAGS AND HAVE BEACON LIGHTS ON ALL EQUIPMENT AT ALL TIMES DURING CONSTRUCTION. SEE FLAG DETAIL ON SHEET 7.
- IN THE CASE OF AN EMERGENCY, CONTRACTOR SHALL NOTIFY AIRPORT MANAGER AND THE ENGINEER IMMEDIATELY.
- DURING ADVERSE WEATHER, THE CONTRACTOR SHALL MAKE PROVISIONS FOR ACCESS TO THE WORK AT NO ADDITIONAL COST TO THE CONTRACT. NO EXTENSION OF CONTRACT TIME WILL BE CONSIDERED FOR DELAYS DUE TO LACK OF ADEQUATE ACCESS TO THE WORK.
- THE TALLEST PIECE OF CONSTRUCTION EQUIPMENT IS ANTICIPATED TO BE AN EXCAVATOR TRUCK WHICH HAS A MAXIMUM HEIGHT OF 25 FEET.
- IF RUNWAY NUMERALS ARE PRESENT DURING CONSTRUCTION THEN CONTRACTOR SHALL PLACE CLOSED RUNWAY MARKER OVER NUMERALS AS DETAILED, OTHERWISE PLACE RUNWAY CLOSED MARKER IN TURF AT ENDS OF RUNWAY AS DETAILED.
- DIXON MUNICIPAL AIRPORT WILL BE IN OPERATION DURING THE CONSTRUCTION OF THIS PROJECT. COORDINATION OF WORK WITH THE AIRPORT IS MANDATORY SO AS TO MINIMIZE IMPACTS ON AIRPORT OPERATIONS.
- APPROXIMATE LOCATION OF HAUL ROUTES ON THE AIRPORT SITE ARE SHOWN ON THE GENERAL PROJECT LAYOUT AND THE PHASING PLANS. IT SHALL BE THE CONTRACTOR'S RESPONSIBILITY TO COORDINATE OFF-SITE HAUL ROUTES (STATE HIGHWAYS, COUNTY ROADS OR CITY STREETS) WITH THE APPROPRIATE OWNER WHO HAS JURISDICTION OVER THE AFFECTED ROUTE. ON-SITE ROADS USED AS HAUL ROUTES SHALL BE MAINTAINED BY THE CONTRACTOR AND SHALL BE RESTORED AT THE CONTRACTOR'S EXPENSE TO THEIR ORIGINAL CONDITION UPON COMPLETION OF BEING USED AS A HAUL ROUTE. THE BEFORE AND AFTER CONDITION OF ON-SITE HAUL ROUTES SHALL BE JOINTLY INSPECTED AND DETERMINED BY THE CONTRACTOR AND THE ENGINEER. FENCING, DRAINAGE, GRADING AND OTHER MISCELLANEOUS CONSTRUCTION REQUIRED TO CONSTRUCT TEMPORARY HAUL ROUTES OR ACCESS POINTS ON THE AIRPORT WILL BE THE CONTRACTOR'S TOTAL RESPONSIBILITY AND SHALL BE APPROVED BY THE ENGINEER PRIOR TO THE WORK. ALL ON-SITE ACCESS ROADS TO AIRPORT FACILITIES SHALL REMAIN OPEN AND MAINTAINED AT ALL TIMES.

- MOBILIZATION/EQUIPMENT STORAGE AREA WILL BE MADE AVAILABLE FOR CONTRACTOR'S MOBILIZATION AND STORAGE AS SHOWN ON THE PLANS. THIS AREA SHALL BE RESTORED TO THE ORIGINAL CONDITION UPON COMPLETION OF THE PROJECT. THE RESTORATION SHALL NOT BE PAID FOR SEPARATELY BUT SHALL BE CONSIDERED INCIDENTAL TO THE CONTRACT.
- LOCATION OF KNOWN EXISTING AIRPORT UNDERGROUND CABLES ARE SHOWN ON THE PLANS AND MUST BE VERIFIED BY THE CONTRACTOR. REPAIR OF DAMAGED CABLE MUST BE STARTED IMMEDIATELY AND CONTINUED UNTIL COMPLETED. ALL SUCH REPAIRS SHALL BE IN ACCORDANCE WITH THE SPECIFICATIONS, OR AS DIRECTED BY THE OWNER OF THE CABLE, AND SHALL BE AT THE CONTRACTOR'S EXPENSE. IF FAA CABLES ARE DAMAGED, REPAIRS SHALL BE DONE FROM POINT TO POINT IN ACCORDANCE WITH FAA REQUIREMENTS AND IN THE PRESENCE OF A FAA REPRESENTATIVE. THE OWNER MAY ELECT TO HAVE THE REPAIR PERFORMED BY OTHERS IN WHICH CASE THE CONTRACTOR SHALL BE RESPONSIBLE FOR PAYING THE INCURRED COSTS OF REPAIRS.
- COORDINATION MEETINGS – THE CONTRACTOR SHALL CONDUCT WEEKLY COORDINATION MEETINGS TO DISCUSS WORK AREAS AND SCHEDULING, ETC. WITH THE ENGINEER, AIRPORT OPERATIONS, FAA, AND OTHER APPROPRIATE OFFICIALS. MINUTES FROM THE WEEKLY MEETINGS SHALL BE PREPARED BY THE CONTRACTOR, FURNISHED TO ALL ATTENDEES PRIOR TO THE SUBSEQUENT MEETING, AND KEPT ON FILE AT THE FIELD OFFICE. THE COORDINATION MEETING COSTS SHALL BE CONSIDERED INCIDENTAL TO THE PROJECT.
- THE CONTRACTOR SHALL PROVIDE THE PHONE NUMBERS OF THREE PERSONNEL, INCLUDING THE PROJECT SUPERINTENDENT, WHO MAY BE CONTACTED IN AN EMERGENCY. PERSONNEL SHALL BE ON CALL 24 HOURS PER DAY FOR MAINTAINING AIRPORT HAZARD LIGHTING AND BARRICADES.
- DRAINAGE MODIFICATIONS SHALL BE SEQUENCED TO PROVIDE POSITIVE DRAINAGE AT ALL TIMES AT NO ADDITIONAL COST TO THE CONTRACT.
- VEHICLES AND EQUIPMENT SHALL NOT BE ALLOWED WITHIN 45' FROM ACTIVE TAXIWAYS AND 125' FROM ACTIVE RUNWAYS UNLESS OTHERWISE APPROVED BY THE AIRPORT MANAGER.
- CONTRACTOR SHALL STORE EQUIPMENT AND MATERIALS IN SUCH A MANNER AS NOT TO VIOLATE FEDERAL AVIATION ADMINISTRATION PART 77 SURFACES OR RUNWAY SAFETY AREAS, TAXIWAY OBJECT FREE AREA AND RUNWAY OBSTACLE FREE ZONE.
- ALL EXISTING TAXIWAY AND RUNWAY AIRFIELD LIGHTING CIRCUITS, FAA CABLES AND OTHER ELECTRICAL CABLES SHALL REMAIN IN SERVICE AT ALL TIMES. ALL EXISTING LIGHTING AND VAULT EQUIPMENT SHALL REMAIN IN SERVICE UNTIL PROPOSED IMPROVEMENTS ARE INSTALLED AND OPERATIONAL, UNLESS OTHERWISE APPROVED BY THE ENGINEER. ANY CABLES DAMAGED BY THE CONTRACTOR SHALL BE IMMEDIATELY REPAIRED AT HIS EXPENSE.
- COORDINATION BY THE CONTRACTOR WITH THE EXISTING UTILITIES SHALL BE COMPLETED BEFORE CONSTRUCTION IS STARTED. CONTRACTOR IS REFERRED TO SECTION 50-17 OF THE SPECIAL PROVISIONS FOR SPECIFIC REQUIREMENTS. THE LOCATION OF UNDERGROUND UTILITIES AS INDICATED ON THE PLANS HAS BEEN OBTAINED FROM EXISTING RECORDS. NEITHER THE OWNER OR THE DESIGN ENGINEER ASSUME ANY RESPONSIBILITY WHATEVER IN RESPECT TO THE ACCURACY, COMPLETENESS OR SUFFICIENCY OF THE INFORMATION. THERE IS NO GUARANTEE, EITHER EXPRESSED OR IMPLIED THAT THE LOCATIONS, SIZE AND TYPE MATERIAL OF EXISTING UNDERGROUND UTILITIES AS INDICATED ARE REPRESENTATIVE OF THOSE TO BE ENCOUNTERED DURING CONSTRUCTION. IT SHALL BE THE CONTRACTOR'S RESPONSIBILITY TO DETERMINE THE ACTUAL LOCATION OF ALL SUCH FACILITIES, INCLUDING SERVICE CONNECTIONS TO UNDERGROUND UTILITIES. PRIOR TO CONSTRUCTION, THE CONTRACTOR SHALL NOTIFY THE UTILITY COMPANY OF HIS OPERATIONAL PLANS. THE CONTRACTOR SHALL MAKE ARRANGEMENTS FOR DETAILED INFORMATION AND ASSISTANCE IN LOCATING UTILITIES. IN THE EVENT AN UNEXPECTED UTILITY INTERFERENCE IS ENCOUNTERED DURING CONSTRUCTION, THE CONTRACTOR SHALL IMMEDIATELY NOTIFY THE UTILITY COMPANY, THE RESIDENT ENGINEER AND THE AIRPORT MANAGER. ANY SUCH MAINS AND/OR SERVICES DISTURBED BY THE CONTRACTOR'S OPERATIONS SHALL BE RESTORED IMMEDIATELY AT HIS EXPENSE TO THE SATISFACTION OF THE RESIDENT ENGINEER AND AIRPORT MANAGER.
- ALL AIRFIELD LIGHTING AND LIGHTING GUIDANCE SYSTEMS (NAVAIDS) LOCATED WITHIN AND IMMEDIATELY ADJACENT TO THE CONTRACTOR'S WORK ZONE SHALL BE CHECKED FOR OPERATIONAL CONDITION PRIOR TO THE DEPARTURE FROM THE AIRPORT WITH THE AIRPORT MANAGER AND/OR AIRPORT MAINTENANCE. ANY DEFICIENCIES IN THESE SYSTEMS DUE TO THE ACTS OF CONTRACTOR OR HIS SUBCONTRACTORS, SUPPLIERS OR CONSULTANTS SHALL BE REPAIRED IMMEDIATELY.

### CONTRACTOR CROSSING RUNWAY AND TAXIWAY AIR OPERATIONS AREA (A.O.A.)

ANYTIME THE CONTRACTOR IS REQUIRED TO UTILIZE OR CROSS ACTIVE AIRFIELD PAVEMENTS FOR ACCESS TO AND FROM THE WORK ZONE, A FULL TIME CROSSING GUARD IN RADIO CONTACT WITH THE AIR TRAFFIC SHALL BE FURNISHED BY THE CONTRACTOR FOR MOVEMENTS OF VEHICLES OR EQUIPMENT TO AND FROM THE WORK ZONE. THE RADIO OPERATOR SHALL BE FAMILIAR WITH AIRPORT GROUND CONTROL PROCEDURES AND DEMONSTRATE KNOWLEDGE OF SAME TO THE AIRPORT. THE AIRPORT RESERVES THE RIGHT TO APPROVE THE CROSSING GUARDS. THE CONTRACTOR SHALL PROVIDE THEIR OWN RADIOS. THIS COST SHALL BE CONSIDERED INCIDENTAL TO THE CONTRACT. THE CONTRACTOR SHALL BE RESPONSIBLE FOR PAYMENT OF MUNICIPAL FINES (\$500 PER OCCURENCE) DUE TO AIRFIELD INCURSIONS BY HIS EMPLOYEES, SUBCONTRACTORS, SUPPLIERS, CONSULTANTS AND/OR AGENTS.

ANY PAVEMENT DAMAGED BY CONTRACTOR'S OPERATIONS SHALL BE REPAIRED IMMEDIATELY BY HIM TO THE SATISFACTION OF THE RESIDENT ENGINEER AND AIRPORT MANAGER AT NO ADDITIONAL COST TO THE OWNER. PAVEMENT SHALL BE CONTINUALLY SWPT TO PROVIDE DEBRIS FREE SURFACE DURING ALL HAUL ROAD OPERATIONS. THIS COST SHALL NOT BE PAID SEPARATELY BUT SHALL BE CONSIDERED INCIDENTAL TO THE CONTRACT.

WORK WITHIN THE A.O.A. SHALL BE EXPEDITED. ANY DROP OFF SHALL BE ADEQUATELY LIGHTED, SIGNED AND BARRICADED. NO MATERIAL SHALL BE STOCKPILED WITHIN THE A.O.A. SHOULD IT BE NECESSARY FOR THE CONTRACTOR TO TEMPORARILY RELOCATE EQUIPMENT TO ALLOW AIRCRAFT TO PASS, THEY SHALL DO SO AT NO EXTRA COST TO THE PROJECT. THE CONTRACTOR SHALL NOTIFY THE RESIDENT ENGINEER AND AIRPORT MANAGER TEN (10) WORKING DAYS IN ADVANCE OF ANY PLANNED CONSTRUCTION WITHIN THESE LIMITS.

### LIMITATIONS ON CONSTRUCTION WITHIN RUNWAY OBSTACLE FREE ZONE (ROFZ) AND TAXIWAY/TAXILANE OBJECT FREE AREA (TOFA)

#### RUNWAYS:

THE CONTRACTOR SHALL NOTIFY THE RESIDENT ENGINEER AND AIRPORT MANAGER TEN (10) WORKING DAYS IN ADVANCE OF ANY PLANNED CONSTRUCTION WITHIN THESE LIMITS. WORK SHALL BE EXPEDITED IN THESE AREAS AND AT THE END OF EACH WORKING DAY THESE AREAS SHALL BE SMOOTHLY GRADED TO ALLOW THE RUNWAY TO BE REOPENED UNLESS OTHERWISE SHOWN ON THE PLANS. AT LEAST ONE OF THE RUNWAYS SHALL REMAIN IN OPERATION AT ALL TIMES. IF NECESSARY STEEL PLATES SHALL BE FURNISHED AND INSTALLED BY THE CONTRACTOR TO COVER ANY OPEN TRENCHES OR EXCAVATION WITHIN THE RSA IF DURING RUNWAY CLOSURE AN EMERGENCY IS DECLARED, THE CONTRACTOR SHALL IMMEDIATELY CLEAR THE RUNWAY OF ALL VEHICLES, MEN AND EQUIPMENT. REFERENCE TABLE ON THIS SHEET FOR SAFETY AREA WIDTHS.

#### TAXIWAYS / TAXILANES:

ANY WORK WITHIN TAXIWAY / TAXILANE OBJECT FREE AREA (TOFA) WILL REQUIRE A TAXIWAY / TAXILANE CLOSURE. WORK WITHIN THE TOFA SHALL BE EXPEDITED. ANY DROP OFF SHALL BE ADEQUATELY LIGHTED, SIGNED AND BARRICADED. NO MATERIAL SHALL BE STOCKPILED WITHIN THE TOFA. SHOULD IT BE NECESSARY FOR THE CONTRACTOR TO TEMPORARILY RELOCATE EQUIPMENT TO ALLOW AIRCRAFT TO PASS, THEY SHALL DO SO AT NO EXTRA COST TO THE PROJECT. THE CONTRACTOR SHALL NOTIFY THE RESIDENT ENGINEER AND AIRPORT MANAGER FIVE (5) WORKING DAYS IN ADVANCE OF ANY PLANNED CONSTRUCTION WITHIN THESE LIMITS. REFERENCE TABLE ON THIS SHEET FOR OBJECT FREE AREA WIDTHS. NO DROP-OFFS OR OPEN EXCAVATIONS WILL BE ALLOWED WITHIN THE TAXIWAY / TAXILANE SAFETY AREAS OF OPEN TAXIWAYS / TAXILANES.

DESIGN AIRCRAFT APPROACH CATEGORY: B  
DESIGN AIRPORT GROUP: I  
RUNWAY 12/30 OBSTACLE FREE ZONE TOTAL WIDTH = 250'  
RUNWAY 8/26 OBSTACLE FREE ZONE TOTAL WIDTH= 250'  
TAXIWAY CENTERLINE TO OBJECT SEPARATION = 44.5'  
TAXILANE CENTERLINE TO OBJECT SEPARATION = 39.5'

CONTRACTOR SHALL PLAN AND PERFORM HIS WORK SO AS NOT TO INTERFERE OR HINDER THE PROGRESS, WORK OR HAUL ROAD ACCESS OF OTHER CONTRACTORS (SEE SPECIAL PROVISIONS SECTION 30-05). THE PRIME CONTRACTOR WILL BE RESPONSIBLE TO COORDINATE CONSTRUCTION ACTIVITIES AND ACCESS BETWEEN ALL ON-SITE CONTRACTORS SUBCONTRACTORS.

### SUGGESTED SEQUENCE OF CONSTRUCTION

- NOTIFY RESIDENT ENGINEER/AIRPORT MANAGER 10 DAYS PRIOR TO THE START OF CONSTRUCTION TO ISSUE APPROPRIATE NOTAMS.
- WORK AREAS 1 THRU 3
  - COORDINATE WITH RESIDENT ENGINEER AND AIRPORT MANAGER FOR REQUIRED PAVEMENT CLOSURES FOR WORK AREA.
  - PLACE REQUIRED BARRICADES AND PAVEMENT CLOSURE MARKERS.
  - MEGGER AIRFIELD CIRCUITS.
  - DE-ENERGIZE CIRCUITS FOR CLOSED RUNWAYS.
  - INSTALL TEMPORARY CABLING/DE-ENERGIZE TAXIWAY CIRCUIT OR COVER LIGHT FIXTURE IN SUCH A WAY TO PREVENT LIGHT LEAKAGE WITHIN WORK AREA LIMITS.
  - COMPLETE NEW LIGHTING, CABLING AND SIGN IMPROVEMENTS.
  - COMPLETE TOPSOILING AND SEEDING AROUND TO MEET RSA/TSA GRADING.
  - REMOVE TEMPORARY CABLING AND RE-ENERGIZE CIRCUITS WITHIN WORK AREA LIMITS AND RE-MEGGER AIRFIELD CIRCUITS.
  - COORDINATE WITH RESIDENT ENGINEER AND AIRPORT MANAGER PAVEMENT CLOSURES FOR NEXT WORK AREA.
  - CLEAN PAVEMENTS, RESTORE DISTURBED WORK AREAS AND REMOVE MISCELLANEOUS DEBRIS FROM WORK AREA.
  - RELOCATE BARRICADES AND PAVEMENT CLOSURE MARKERS FOR NEXT WORK AREA.
- RESTORE STAGING AREAS.

POINT	NEAREST ACTIVE RUNWAY	LATITUDE	LONGITUDE	GROUND ELEVATION	TOP ELEVATION
A	RUNWAY 8/26	41°50'02.86"	89°26'40.38"	781.7	806.7
B	RUNWAY 8/26	41°50'00.91"	89°26'36.09"	781.6	806.6
C	RUNWAY 8/26	41°50'03.38"	89°26'36.44"	783.0	808.0
D	RUNWAY 8/26	41°50'01.44"	89°26'32.16"	783.0	808.0
E	RUNWAY 12/30	41°50'09.02"	89°26'38.38"	782.0	807.0
F	RUNWAY 8/26	41°49'58.14"	89°27'15.84"	780.0	805.0
G	RUNWAY 8/26	41°49'59.52"	89°27'05.43"	779.0	804.0
H	RUNWAY 8/26	41°50'01.08"	89°26'53.75"	777.0	802.0
I	RUNWAY 8/26	41°50'04.83"	89°26'25.53"	782.0	807.0
J	RUNWAY 12/30	41°50'09.47"	89°26'37.65"	782.0	807.0
K	RUNWAY 8/26	41°50'04.78"	89°26'25.92"	783.0	808.0
L	RUNWAY 12/30	41°50'14.13"	89°26'44.59"	778.0	803.0

MAXIMUM ANTICIPATED HEIGHT OF CONSTRUCTION EQUIPMENT 25'

NOTE – ALL PHASES  
ALL EXISTING TAXIWAY AND RUNWAY AIRFIELD LIGHTING CIRCUITS, FAA CABLES AND OTHER AIRPORT ELECTRICAL CABLES SHALL REMAIN IN SERVICE UNTIL REPLACED AS ACCEPTABLE TO THE RESIDENT ENGINEER. ALL TEMPORARY CABLING AND SPLICING NECESSARY TO KEEP THE CIRCUITS IN OPERATION SHALL BE CONSIDERED INCIDENTAL TO CONTRACT.

IL. CONTRACT: **DI029**  
IL. LETTING ITEM: **01A**  
IL. PROJECT: **C73-4258**  
S.B.G. PROJECT: **3-17-SBGP-105/11/120**

SURVEY BOOK #

REVISIONS		
NUMBER	BY	DATE

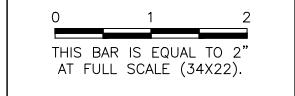

**DIXON MUNICIPAL AIRPORT  
DIXON, ILLINOIS  
REHABILITATE ELECTRICAL SYSTEM FOR RUNWAY 12/30**

**SEQUENCE OF CONSTRUCTION - GENERAL NOTES**

© Copyright CMT, Inc.  
**CMT**  
CRAWFORD, MURPHY & TILLY, INC.  
CONSULTING ENGINEERS  
License No. 184-000613

DESIGN BY: RMH  
DRAWN BY: RMH  
CHECKED BY: DKP  
APPROVED BY: DKP  
DATE: 4/19/19  
JOB No: 180244-02

**FINAL**  
SHEET 6 OF 28 SHEETS

DATE: Friday, April 19, 2019 9:45:06 AM  
 FILE: K:\Browns\180244-00-lighting\12-30\Draw\_Sheets\Sequence Of Construction\_General\_Details.dwg  
 UPDATE BY: Robert Heinz  
 LAYOUT: Layout1  
 XREF DWG: brch1\_180244-00.dwg  
 IMAGE FILES:

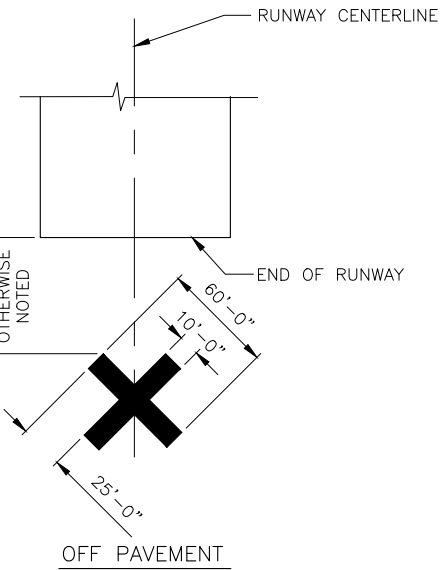
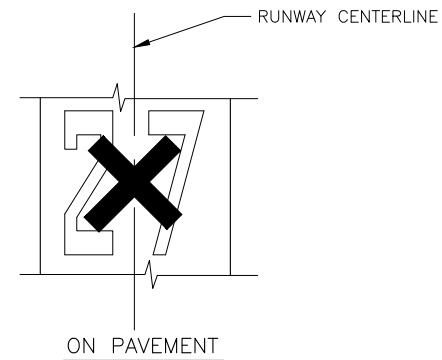

**CLOSED RUNWAY MARKER DETAIL**  
N.T.S.

**NOTES**

- MARKERS SHALL BE SOLID YELLOW.
- MARKERS SHALL BE MATERIAL APPROVED BY THE ENGINEER.
- CONTRACTOR SHALL MAINTAIN AND RELOCATE MARKERS AS SHOWN ON THE PLANS OR AS NEEDED TO FACILITATE CONSTRUCTION.
- MARKERS ON PAVEMENT SHALL BE PLACED OVER EXISTING RUNWAY NUMERALS AS SHOWN. HOWEVER, WHEN WORK IS NECESSARY FOR THAT AREA OR PAVEMENT IS OPEN TO TAXIING AIRCRAFT, THE MARKERS SHALL BE RELOCATED OFF THE PAVEMENT AS SHOWN ON THE DETAIL.
- COST OF FURNISHING, INSTALLING, MAINTAINING, RELOCATING AND REMOVING MARKERS SHALL BE CONSIDERED INCIDENTAL TO THE CONTRACT.
- DURING VARIOUS PHASES OF WORK, IT WILL BE NECESSARY TO CLOSE RUNWAYS TO AIR TRAFFIC ON A TEMPORARY BASIS AS COORDINATED WITH THE AIRPORT AND TOWER, WHERE APPLICABLE, PERSONNEL. THE CONTRACTOR SHALL MARK THE RUNWAYS TO BE CLOSED BY PLACING A YELLOW CROSS AT THE LOCATION AND DIMENSIONS DETAILED ON THIS SHEET. THE CROSSES ARE SHOWN ON THE RESPECTIVE RUNWAYS ACCORDING TO THE VARIOUS PHASES OF WORK AS DELINEATED IN THE CONSTRUCTION ACTIVITY PLANS.

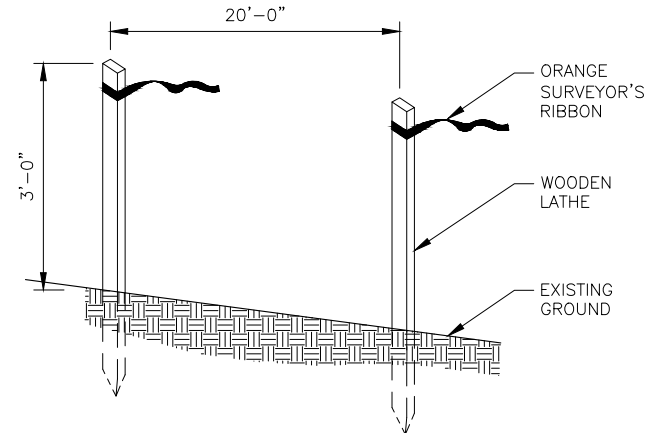

**CONSTRUCTION SETBACK LINE DETAIL**  
N.T.S.

**NOTES**

- PLACE CONSTRUCTION SETBACK LINES AT LOCATIONS OF CONSTRUCTION OPERATIONS NEAR RUNWAY OBSTACLE FREE ZONES AND TAXIWAY OBJECT FREE AREAS WHEN RUNWAYS/TAXIWAYS ARE OPEN.

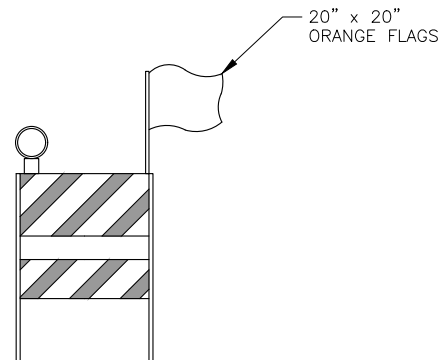

**FLASHER BARRICADE DETAIL**  
N.T.S.

**NOTES**

- FLASHERS TO BE BATTERY OPERATED. LENS TO BE RED AND BE ABLE TO ROTATE 90 DEGREES. ALTERNATE FLASHER LENSES SO THAT EVERY OTHER LENS IS ROTATED 90°.
- SANDBAGS TO BE PLACED ON EACH SUPPORT BRACE AS REQUIRED TO PREVENT DISPLACEMENT BY WIND, JET OR PROP BLAST.
- NO SEPARATE PAYMENT WILL BE MADE FOR THIS ITEM. COSTS SHALL BE CONSIDERED INCIDENTAL TO THE PROJECT.
- PLACE AT TEN (10') INTERVALS.
- ONE 20"x20" ORANGE FLAG TO BE INSTALLED ON EACH BARRICADE.
- CONTRACTOR SHALL BE RESPONSIBLE FOR MAINTAINING BARRICADES AT ALL TIMES TO THE SATISFACTION OF THE AIRPORT MANAGER.

**CONTRACTOR ACCESS ROUTE NOTES**

- ALL PAVEMENTS OR TURF AREAS UTILIZED BY THE CONTRACTOR FOR AN ACCESS ROUTE, STAGING, OR STORAGE SHALL BE REPAIRED AND RESTORED TO THEIR ORIGINAL CONDITION TO THE SATISFACTION OF THE AIRPORT. NO ADDITIONAL COMPENSATION TO PROTECT, REPAIR, OR RESTORE THESE AREAS SHALL BE MADE.

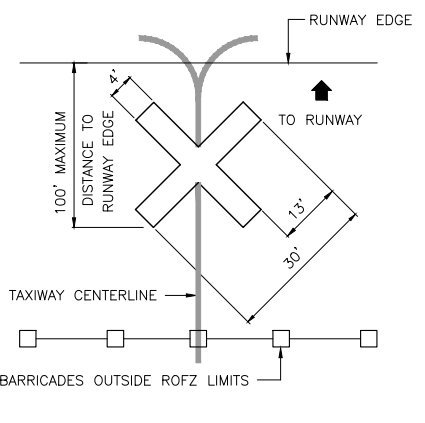

**CLOSED TAXIWAY MARKER DETAIL**  
N.T.S.

**CLOSED TAXIWAY MARKER DETAIL NOTES**

- CLOSED TAXIWAY MARKERS SHALL BE PAINTED WITH TEMPORARY MARKING CAPABLE OF BEING REMOVED WITH LOW PRESSURE WATER BLASTING OR OTHER MATERIAL THAT DOES NOT VIOLATE THE OBJECT FREE AREA CRITERIA AND RUNWAY SAFETY AREA CRITERIA PER ADVISORY CIRCULAR 150/5300-13A (LATEST EDITION) AND ARE APPROVED BY THE AIRPORT.
- CONTRACTOR SHALL MAINTAIN AND RELOCATE MARKERS AS SHOWN ON THE PLANS OR AS NEEDED TO FACILITATE CONSTRUCTION.
- COST OF FURNISHING, INSTALLING, MAINTAINING AND REMOVING MARKERS SHALL BE CONSIDERED INCIDENTAL TO THE CONTRACT.
- PLACE MARKERS OVER TAXIWAY CENTERLINE.
- MARKERS SHALL BE ADEQUATELY SECURED TO PREVENT MOVEMENT BY PROPELLER WASH, JET BLAST OR OTHER WIND CURRENTS.
- MARKERS ARE ONLY REQUIRED FOR TAXIWAYS CLOSED THREE (3) CONSECUTIVE DAYS OR MORE.

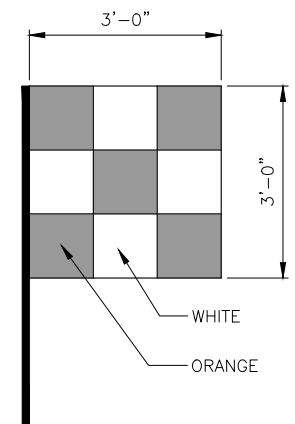

**CONSTRUCTION EQUIPMENT AND TRUCK/VEHICLE SIGNAL FLAG**  
N.T.S.

IL. CONTRACT: **D1029**  
 IL. LETTING ITEM: **01A**  
 IL. PROJECT: **C73-4258**  
 S.B.G. PROJECT: **3-17-SBGP-105/111/120**

SURVEY BOOK #

REVISIONS		
NUMBER	BY	DATE

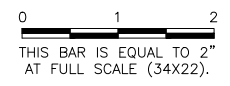

**DIXON MUNICIPAL AIRPORT**  
**DIXON, ILLINOIS**  
**REHABILITATE ELECTRICAL SYSTEM FOR RUNWAY 12/30**  
**SEQUENCE OF CONSTRUCTION - GENERAL DETAILS**

© Copyright, CMT, Inc.  
**CMT**  
 CRAWFORD, MURPHY & TILLY, INC.  
 CONSULTING ENGINEERS  
 License No. 184-000613

DESIGN BY:	RMH
DRAWN BY:	RMH
CHECKED BY:	DKP
APPROVED BY:	DKP
DATE:	4/19/19
JOB No:	180244-02

**FINAL**

KREF DWG: Dixon-base.dwg  
BMAP: 3-17-SBGP-105/11/120

IMAGE FILES:

UPDATE BY: Robert Heinz  
LAYOUT: Layout1

DATE: Friday, April 19, 2019 9:45:45 AM  
FILE: K:\Browns\18024402-00\_lighting\12-30\Draw\_Sheets\Existing Conditions - Sheet 1.dwg

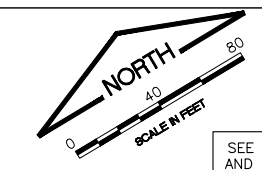

SEE EXISTING CONDITIONS AND PROPOSED REMOVALS SHEET 2 FOR NOTES AND LEGEND

IL. CONTRACT: **DI029**  
IL. LETTING ITEM: **01A**  
IL. PROJECT: **C73-4258**  
S.B.G. PROJECT: **3-17-SBGP-105/11/120**

SURVEY BOOK #

REVISIONS		
NUMBER	BY	DATE

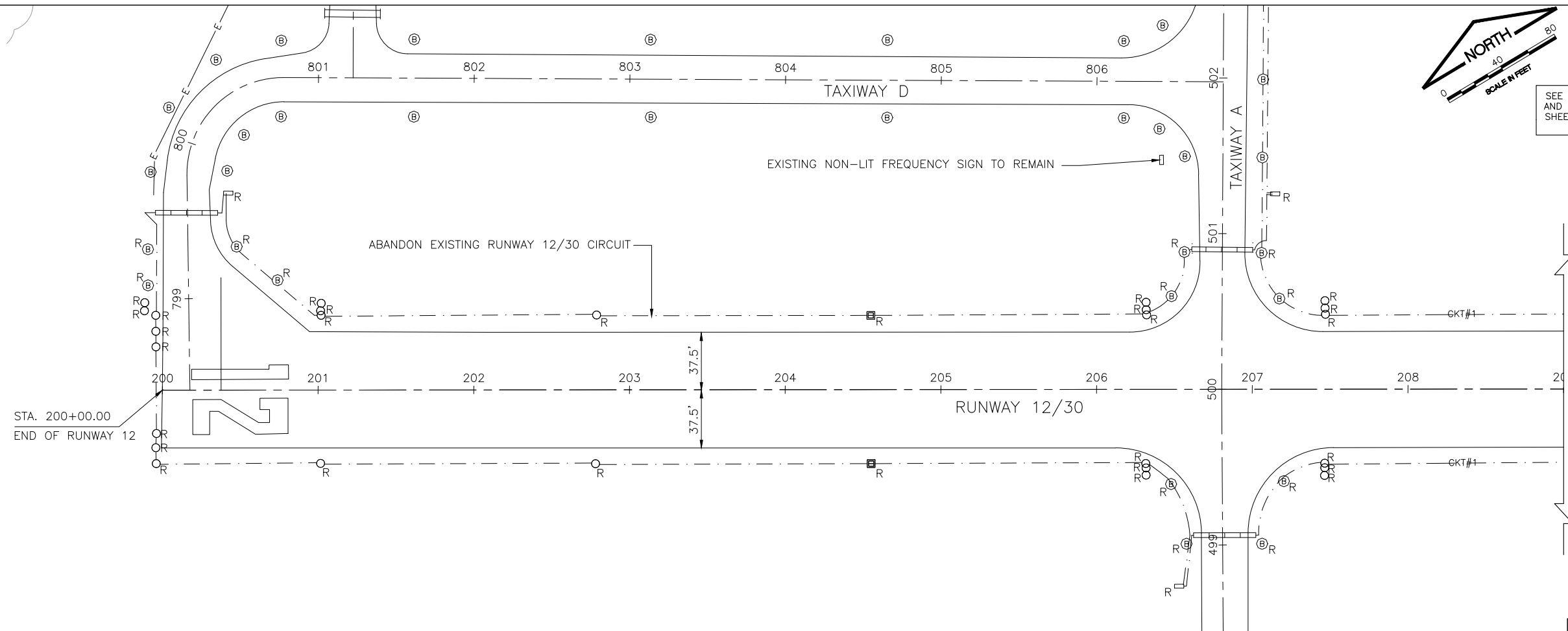
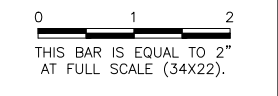

VIEW 1

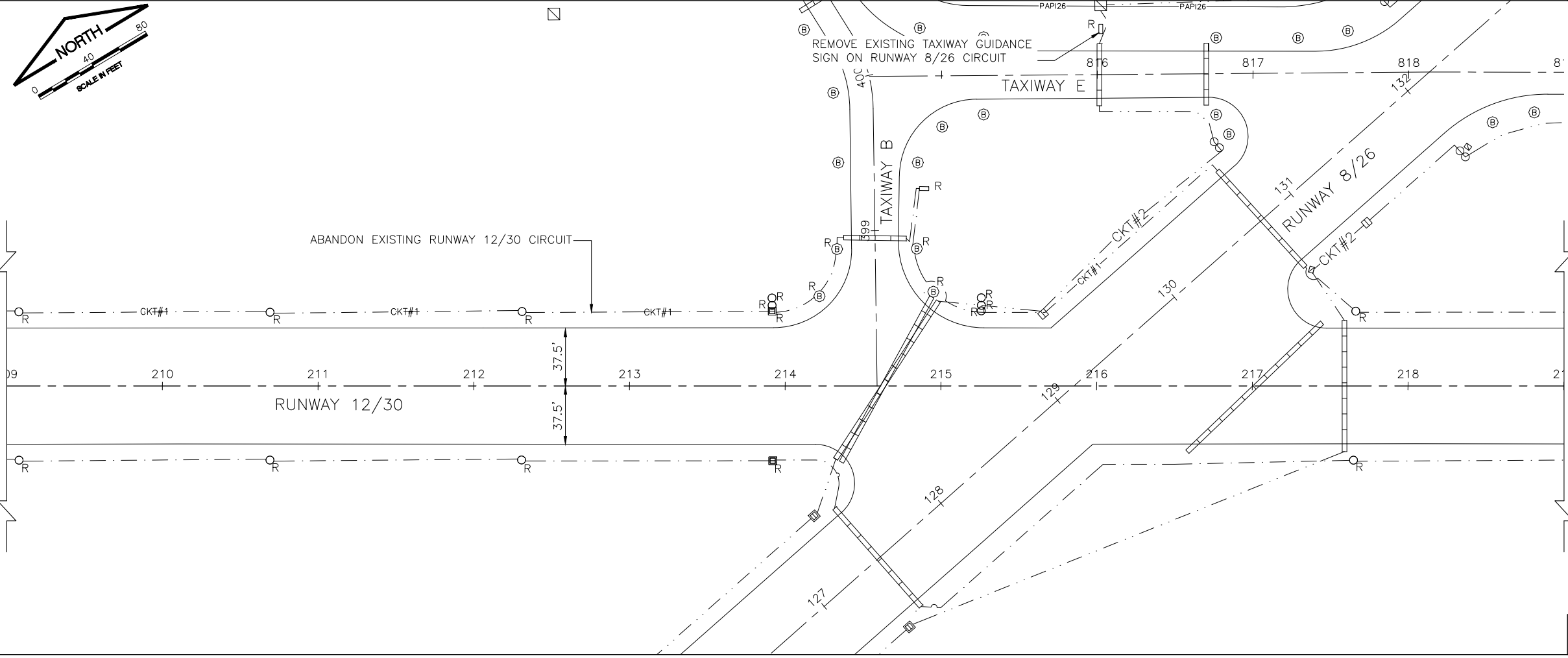

VIEW 2

**DIXON MUNICIPAL AIRPORT  
DIXON, ILLINOIS**

**REHABILITATE ELECTRICAL SYSTEM FOR RUNWAY 12/30**

**EXISTING CONDITIONS AND PROPOSED REMOVALS  
SHEET 1**

© Copyright, CMT, Inc.

**CMT**  
CRAWFORD, MURPHY & TILLY, INC.  
CONSULTING ENGINEERS  
License No. 184-000613

DESIGN BY:	RMH
DRAWN BY:	RMH
CHECKED BY:	DKP
APPROVED BY:	DKP
DATE:	4/19/19
JOB No:	180244-02

**FINAL**

SHEET 8 OF 20 SHEETS



DATE: Friday, April 19, 2019 9:46:24 AM  
 FILE: K:\Drawings\1802402-00\_Lighting\12-30\Drawn\_Sheets\Existing\_Conditions - Sheet 2.dwg  
 UPDATE BY: Robert Heinz  
 LAYOUT: Layout1  
 REF DWG: Dixon-base.dwg  
 IMAGE FILES:

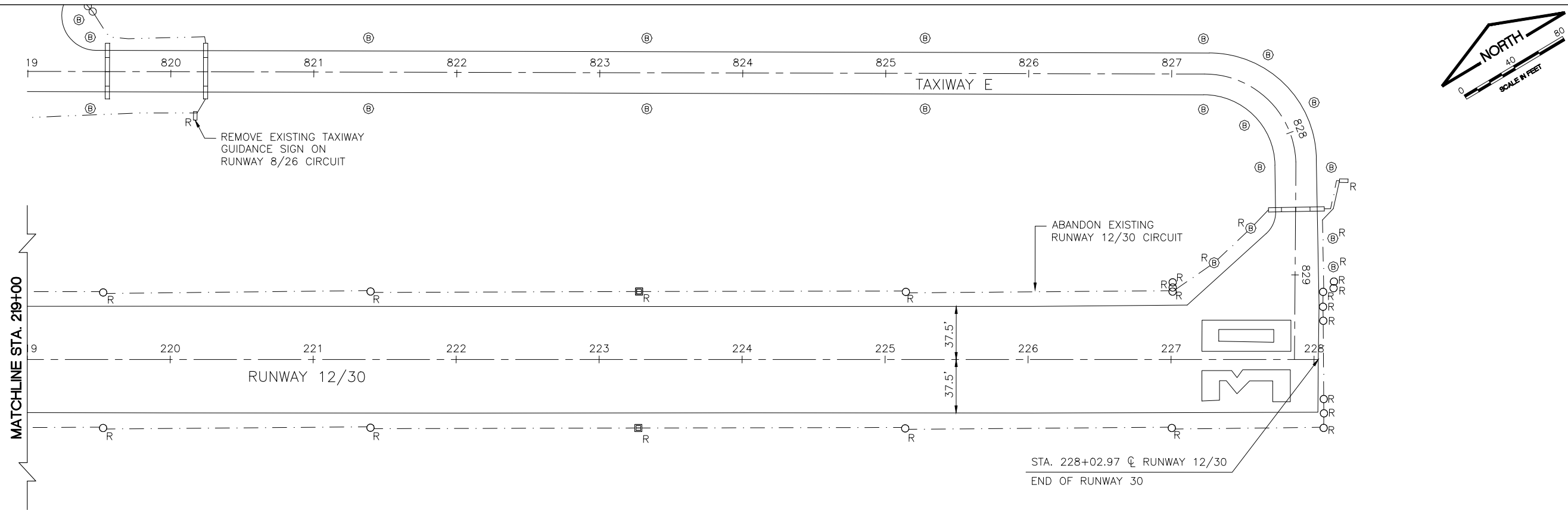

IL. CONTRACT: **DI029**  
 IL. LETTING ITEM: **01A**  
 IL. PROJECT: **C73-4258**  
 S.B.G. PROJECT: **3-17-SBGP-105/11/120**

SURVEY BOOK #

REVISIONS		
NUMBER	BY	DATE

0 1 2  
 THIS BAR IS EQUAL TO 2"  
 AT FULL SCALE (34X22).

VIEW 3

**NOTES**

- CONTRACTOR SHALL VERIFY THAT ALL EXISTING RUNWAYS AND TAXIWAYS TO REMAIN OPEN HAVE THEIR LIGHTING OPERATIONAL AT THE END OF EACH WORKING DAY.
- ANY TEMPORARY CABLING REQUIRED FOR THIS PROJECT SHALL BE CONSIDERED INCIDENTAL TO THE CONTRACT.
- EXISTING CABLES BEING REPLACED WITH NEW CABLES IN EXISTING CONDUITS/UNIT DUCTS SHALL BE REMOVED AND DISPOSED OFF AIRPORT PROPERTY (COST INCIDENTAL).
- EXISTING CIRCUIT TO BE ABANDONED SHALL HAVE THE CABLE REMOVED FROM THE CONDUIT/UNIT DUCT AND DISPOSED OF OFF AIRPORT PROPERTY. THE CONDUIT/UNIT DUCT SHALL BE ABANDONED IN PLACE (COST INCIDENTAL TO LIGHT REMOVAL)
- AIRFIELD SIGNS TO BE REMOVED SHALL INCLUDE THE THE REMOVAL THE EXISTING AIRFIELD SIGN, SIGN BASE AND ASSOCIATED CABLES.

**LEGEND**

- EXISTING BUILDING
- EXISTING PAVEMENT
- AIRPORT PROPERTY LINE
- EXISTING CONDUIT/DUCT BANK
- EXISTING RUNWAY 26 PAPI CIRCUIT
- EXISTING RUNWAY 12/30 CIRCUIT 1/C #8 5KV TO BE ABANDONED
- EXISTING RETROREFLECTIVE MARKER
- EXISTING BASE MOUNTED MEDIUM INTENSITY RUNWAY LIGHT
- EXISTING STAKE MOUNTED MEDIUM INTENSITY RUNWAY/TAXIWAY/THRESHOLD LIGHT
- EXISTING HANDHOLE
- EXISTING RUNWAY END IDENTIFIER LIGHT (REIL)
- EXISTING AIRFIELD GUIDANCE SIGN
- EXISTING WIND CONE
- EXISTING WIND CONE CIRCUIT
- PRECISION APPROACH PATH INDICATOR (PAPI)
- EXISTING AUTOMATED WEATHER OBSERVING SYSTEM (AWOS)
- REMOVE BASE MOUNTED RUNWAY LIGHT
- REMOVE STAKE MOUNTED RUNWAY/TAXIWAY LIGHT
- REMOVE AIRFIELD GUIDANCE SIGN
- REMOVE RETROREFLECTIVE MARKER

**DIXON MUNICIPAL AIRPORT**  
**DIXON, ILLINOIS**  
**REHABILITATE ELECTRICAL SYSTEM FOR RUNWAY 12/30**  
**EXISTING CONDITIONS AND PROPOSED REMOVALS**  
**SHEET 2**

© Copyright, CMT, Inc.  
  
 CRAWFORD, MURPHY & TILLY, INC.  
 CONSULTING ENGINEERS  
 License No. 184-000613

DESIGN BY:	RMH
DRAWN BY:	RMH
CHECKED BY:	DKP
APPROVED BY:	DKP
DATE:	4/19/19
JOB No:	180244-02

**FINAL**

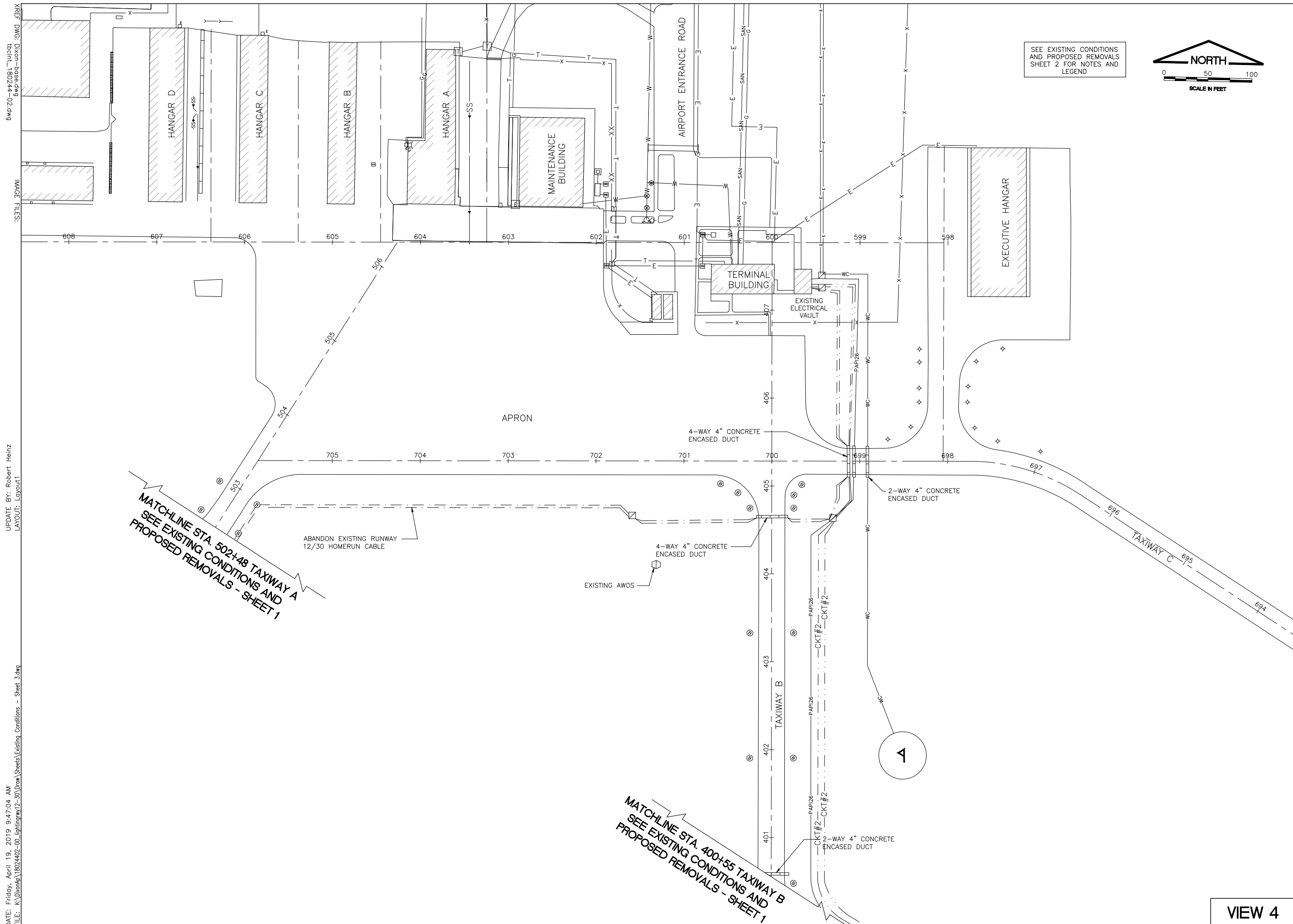

SEE EXISTING CONDITIONS AND PROPOSED REMOVALS SHEET 2 FOR NOTES AND LEGEND



IL. CONTRACT: **DI029**  
 IL. LETTING ITEM: **01A**  
 IL. PROJECT: **C73-4258**  
 S.B.G. PROJECT: **3-17-SBGP-105/111/120**

SURVEY BOOK #

REVISIONS		
NUMBER	BY	DATE

0 1 2  
 THIS BAR IS EQUAL TO 2"  
 AT FULL SCALE (34X22).

**DIXON MUNICIPAL AIRPORT  
 DIXON, ILLINOIS  
 REHABILITATE ELECTRICAL SYSTEM FOR RUNWAY 12/30  
 EXISTING CONDITIONS AND PROPOSED REMOVALS  
 SHEET 3**

© Copyright, CMT, Inc.  
**CMT**  
 CRAWFORD, MURPHY & TILLY, INC.  
 CONSULTING ENGINEERS  
 License No. 184-000613

DESIGN BY: RMH  
 DRAWN BY: RMH  
 CHECKED BY: DKP  
 APPROVED BY: DKP  
 DATE: 4/19/19  
 JOB No: 180244-02

**FINAL**  
 SHEET 10 OF 20 SHEETS

MATCHLINE STA. 502+48 TAXIWAY A  
 SEE EXISTING CONDITIONS AND  
 PROPOSED REMOVALS - SHEET 1

MATCHLINE STA. 400+55 TAXIWAY B  
 SEE EXISTING CONDITIONS AND  
 PROPOSED REMOVALS - SHEET 1

DATE: Friday, April 19, 2019 9:47:04 AM  
 FILE: K:\Dixon\18024402-00\_lighting\12-30\Draw\Sheet\Existing Conditions - Sheet 3.dwg  
 UPDATE BY: Robert Heinz  
 LAYOUT: Layout1  
 XREF DWG: Dixon\_base.dwg  
 IMAGE FILES:

**VIEW 4**

KREF DWG: Dixon-base.dwg  
BMP: 7/20/20

IMAGE FILES:

UPDATE BY: Robert Heinz  
LAYOUT: Layout1

DATE: Friday, April 19, 2019 9:47:47 AM  
FILE: K:\Dixon\1802402-00\_Lighting\12-30\Draw\_Sheets\Existing Conditions - Sheet 4.dwg

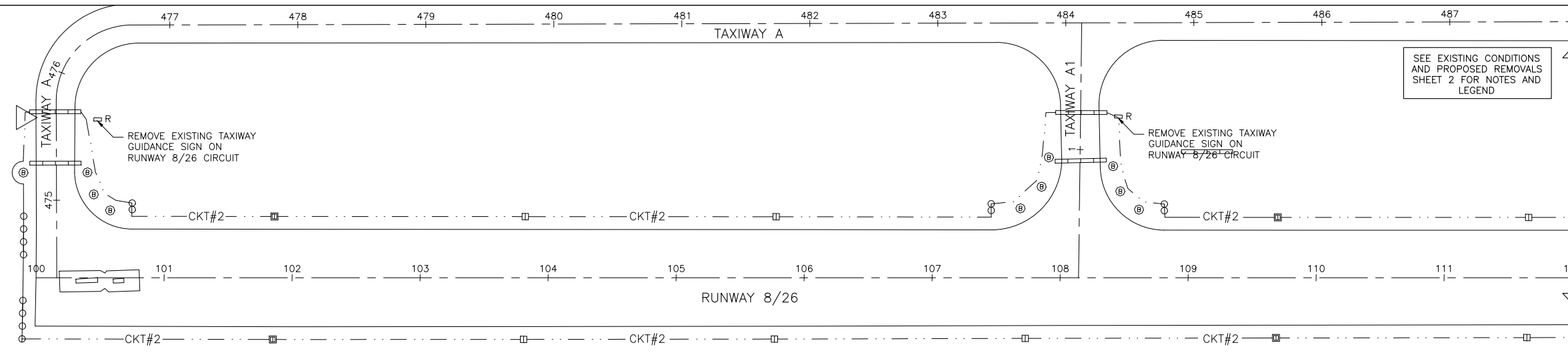
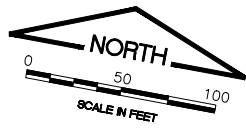

IL. CONTRACT: **DI029**  
IL. LETTING ITEM: **01A**  
IL. PROJECT: **C73-4258**  
S.B.G. PROJECT: **3-17-SBGP-105/111/120**

SURVEY BOOK #

REVISIONS		
NUMBER	BY	DATE

0 1 2  
THIS BAR IS EQUAL TO 2"  
AT FULL SCALE (34X22).

VIEW 5

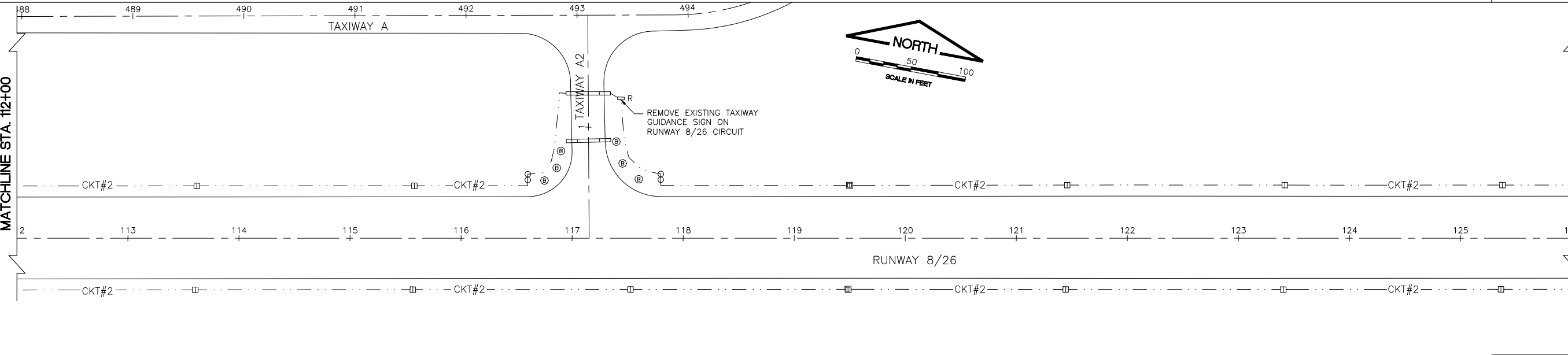

VIEW 6

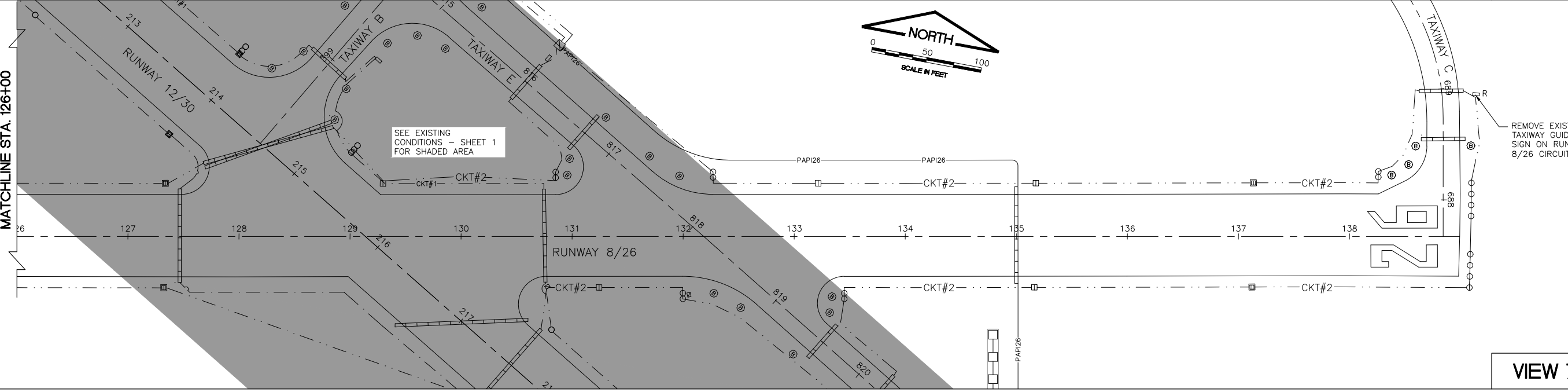

VIEW 7

**DIXON MUNICIPAL AIRPORT  
DIXON, ILLINOIS**

**REHABILITATE ELECTRICAL SYSTEM FOR RUNWAY 12/30**

**EXISTING CONDITIONS AND PROPOSED REMOVALS  
SHEET 4**

© Copyright, CMT, Inc.

**CMT**  
CRAWFORD, MURPHY & TILLY, INC.  
CONSULTING ENGINEERS  
License No. 184-000613

DESIGN BY:	RMH
DRAWN BY:	RMH
CHECKED BY:	DKP
APPROVED BY:	DKP
DATE:	4/19/19
JOB No:	180244-02



DATE: Friday, April 19, 2019 9:49:09 AM  
 FILE: K:\Browns\1802402-00\_Lighting\Lighting Plan - Sheet 2.dwg  
 UPDATE BY: Robert Heinz  
 LAYOUT: Layout1  
 REF DWG: Dixon-base.dwg  
 IMAGE FILES:

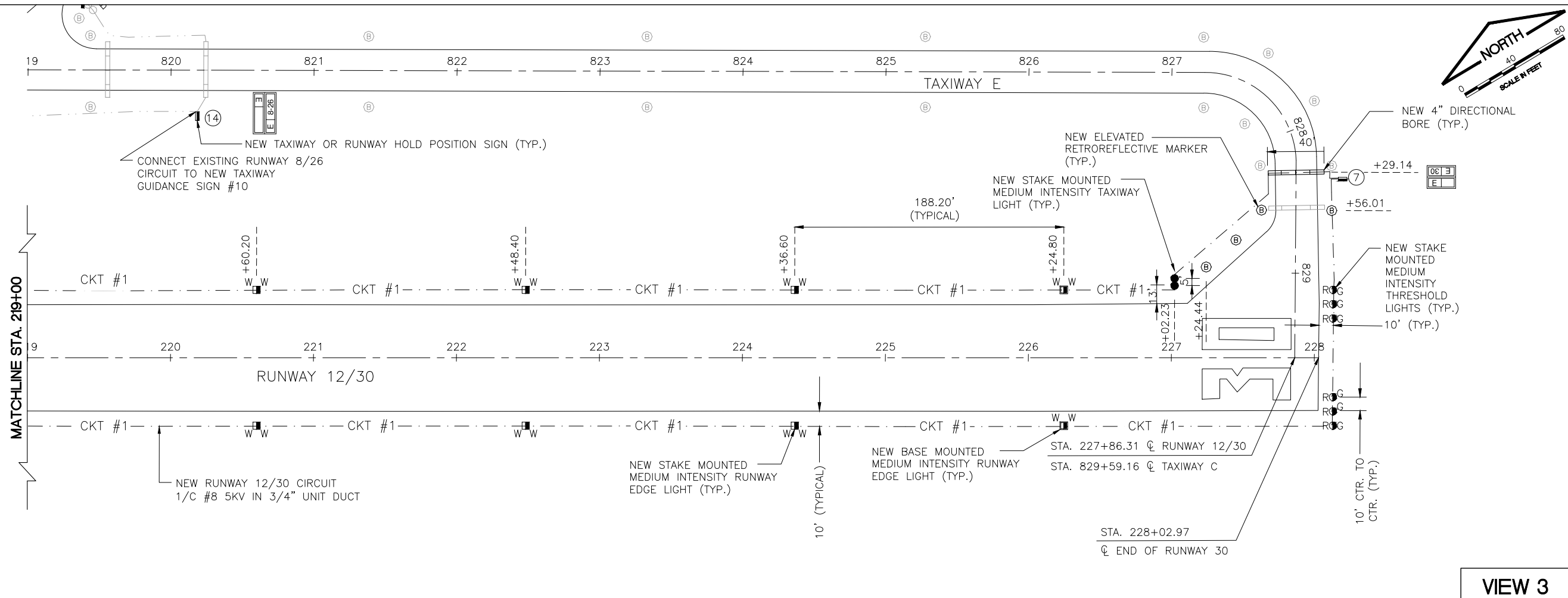

IL. CONTRACT: **DI029**  
 IL. LETTING ITEM: **01A**  
 IL. PROJECT: **C73-4258**  
 S.B.G. PROJECT: **3-17-SBGP-105/11/120**

SURVEY BOOK #

REVISIONS		
NUMBER	BY	DATE

0 1 2  
 THIS BAR IS EQUAL TO 2" AT FULL SCALE (34X22).

**DIXON MUNICIPAL AIRPORT  
 DIXON, ILLINOIS  
 REHABILITATE ELECTRICAL SYSTEM FOR RUNWAY 12/30  
 AIRFIELD LIGHTING PLAN - SHEET 2**

© Copyright, CMT, Inc.

**CMT**  
 CRAWFORD, MURPHY & TILLY, INC.  
 CONSULTING ENGINEERS  
 License No. 184-000613

DESIGN BY: RMH  
 DRAWN BY: RMH  
 CHECKED BY: DKP  
 APPROVED BY: DKP  
 DATE: 4/19/19  
 JOB No: 180244-02

FINAL

SHEET 13 OF 20 SHEETS

AIRFIELD SIGNAGE SCHEDULE					
SIGN NUMBER	NEW NUMBER OF CHARACTERS	SIGN SIDE	NEW SIGN LEGEND	SIGN TYPE	SIGN LOCATION
1	3	NE SW		1,2 2,0	STA 799+65.87, 30°RT CL TAXIWAY D
2	6	NE SW		1,2 2,0	STA 501+25.19, 30°RT CL TAXIWAY A
3	6	NE SW		0,2 2,1	STA 498+75.14, 30°LT CL TAXIWAY A
4	4	NW SE		1 0	STA 213+54.03, 52.5°LT CL RUNWAY 12/30
5	6	NE SW		1,2 2,0	STA 399+24.79, 30°RT CL TAXIWAY B
6	4	NW SE		0 1	STA 218+16.23, 52.5°RT CL RUNWAY 12/30
7	3	NE SW		1,2 2,0	STA 828+33.94, 30°LT CL TAXIWAY E
8	2	N S		1,2 2,0	STA 475+64.42, 30°RT CL TAXIWAY A
9	6	N S		1,2 2,0	STA 1+25.00, 30°RT CL TAXIWAY A1
10	6	N S		1,2 2,0	STA 1+25.00, 30°RT CL TAXIWAY A2
11	5	E W		0 1	STA 126+82.08, 52.5°LT CL RUNWAY 8/26
12	5	E W		1 0	STA 131+43.34, 52.5°RT CL RUNWAY 8/26
13	5	NW SE		1,2 2,0	STA 816+05.68, 30°LT CL TAXIWAY E
14	5	NW SE		0,2 2,1	STA 820+18.35, 30°RT CL TAXIWAY E
15	3	N S		1,2 2,0	STA 688+89.73, 30°RT CL TAXIWAY C

- NOTES**
- THE CONTRACTOR SHALL VERIFY THE EXISTING RUNWAY/TAXIWAY LIGHTING CIRCUITS ARE OPERATIONAL AT THE END OF EACH WORKING DAY FOR TAXIWAYS AND RUNWAYS TO REMAIN OPEN.
  - THE ROUTING OF PROPOSED AND EXISTING CABLE SHOWN IS FOR INFORMATION ONLY. THE EXACT ROUTING SHALL BE FIELD COORDINATED WITH THE RESIDENT ENGINEER.
  - ANY EXISTING CABLE MARKERS THAT ARE DISTURBED SHALL BE REMOVED AND REINSTALLED AT THE SAME LOCATION. COST SHALL BE INCIDENTAL TO CONTRACT.
  - THE EXISTING TAXIWAY AND RUNWAY AIRFIELD LIGHTING CIRCUITS, FAA CABLES AND OTHER AIRPORT ELECTRICAL CABLES SHALL REMAIN IN SERVICE UNTIL REPLACED AS DIRECTED BY THE ENGINEER. ALL TEMPORARY CABLING AND SPLICING SHALL BE CONSIDERED INCIDENTAL TO CONTRACT.
  - AT ANY LOCATION WHERE THE PROPOSED DUCT OR CABLE ROUTE CROSSES AN EXISTING UTILITY, THE CONTRACTOR SHALL HAND DIG AND LOCATE THE EXISTING UTILITY PRIOR TO TRENCHING. COST OF LOCATING ALL EXISTING UTILITIES SHALL BE INCIDENTAL TO THE CONTRACT.
  - CONTRACTOR SHALL PROVIDE PULL WIRE FOR ALL DUCT BANKS AND CAP THE UNUSED DUCT BANKS FOR FUTURE USE.
  - ALL SPLICES OF PROPOSED AND EXISTING CABLES IN ELECTRICAL MANHOLES, HANDHOLES AND LIGHT BASES SHALL BE CONSIDERED INCIDENTAL TO THE CONTRACT.
  - PROPOSED DUCT MARKERS SHALL BE INSTALLED AT ALL EXISTING AND PROPOSED CONDUIT AND DUCT BANK LOCATIONS AS SHOWN ON THE PLANS (SEE DUCT MARKER DETAIL).
  - ALL EXISTING CIRCUITS TO BE ABANDONED SHALL BE REMOVED FROM ALL CONDUITS/DUCT BANKS/UNIT DUCT (COST INCIDENTAL).
  - NEW 2-1/C #8 5KV, L-824 TYPE C CABLES (CIRCUIT #1) IN EXISTING DUCTBANK TO VAULT.
  - CONTRACTOR SHALL INSTALL NEW 2-1/C #8 5KV, L-824 TYPE C CABLES, CIRCUIT #1 IN EXISTING CONDUITS TO EXISTING AIRFIELD LIGHTING REGULATOR. REMOVAL OF EXISTING CABLES AND INSTALLATION/CONNECTION OF NEW CIRCUITS SHALL BE INCIDENTAL TO THE CONTRACT.
  - CONTRACTOR SHALL REMOVE AIRFIELD LIGHTING CABLES FOR CIRCUIT #1 AND INSTALL NEW CIRCUIT IN EXISTING CONDUITS FROM HANDHOLE TO HIGH VOLTAGE WIREWAY INSIDE VAULT. INSTALL NEW L-823 CONNECTORS. COST OF REMOVAL AND INSTALLATION OF NEW L-823 CONNECTORS SHALL BE INCIDENTAL TO THE INSTALLATION OF NEW AIRFIELD LIGHTING CABLE.
  - ALL NEW 4" DIRECTIONAL BORE SHALL BE INSTALLED 5' FROM EDGE OF EXISTING PAVEMENT ON BOTH SIDES OF THE CROSSING TAXIWAY/RUNWAY.
- NEW SIGN TYPE LEGEND**
- SIGN SIZE 1
- 0 — BLANK PANEL — BLACK
  - 1 — RUNWAY/TAXIWAY HOLDLINE — WHITE LEGEND WITH BLACK TEXT BORDER ON RED BACKGROUND
  - 2 — LOCATION SIGN — YELLOW LEGEND ON BLACK BACKGROUND WITH YELLOW BOX AROUND TEXT

**LEGEND**

- EXISTING BUILDING
- EXISTING PAVEMENT
- NEW RUNWAY 12/30 HOMERUN CIRCUIT 1/C #8 5KV (ADDITIVE ALTERNATE #1)
- EXISTING RUNWAY 12/30 CIRCUIT 1/C #8 5KV
- AIRPORT PROPERTY LINE
- NEW 4" DIRECTIONAL BORE
- EXISTING CONDUIT
- NEW STAKE MOUNTED MEDIUM INTENSITY RUNWAY LIGHT
- NEW BASE MOUNTED MEDIUM INTENSITY RUNWAY LIGHT
- NEW INPAVEMENT MEDIUM INTENSITY RUNWAY LIGHT
- NEW STAKE MOUNTED MEDIUM INTENSITY THRESHOLD LIGHT
- NEW STAKE MOUNTED MEDIUM INTENSITY TAXIWAY LIGHT
- NEW ELECTRICAL HANDHOLE
- NEW ELEVATED RETROREFLECTIVE MARKER
- NEW AIRFIELD GUIDANCE SIGN
- NEW SPLICE CAN
- EXISTING RETROREFLECTIVE MARKER
- EXISTING RUNWAY END IDENTIFIER LIGHT (REIL)
- EXISTING PRECISION APPROACH PATH INDICATOR (PAPI)
- EXISTING STAKE MOUNTED MEDIUM INTENSITY RUNWAY/TAXIWAY/THRESHOLD LIGHT
- EXISTING BASE MOUNTED MEDIUM INTENSITY RUNWAY LIGHT
- EXISTING HANDHOLE
- EXISTING AIRFIELD GUIDANCE SIGN
- EXISTING WINDCONE CIRCUIT
- EXISTING WINDCONE
- EXISTING RUNWAY 26 PAPI CIRCUIT
- EXISTING AUTOMATED WEATHER OBSERVING SYSTEM (AWOS)

VIEW 3



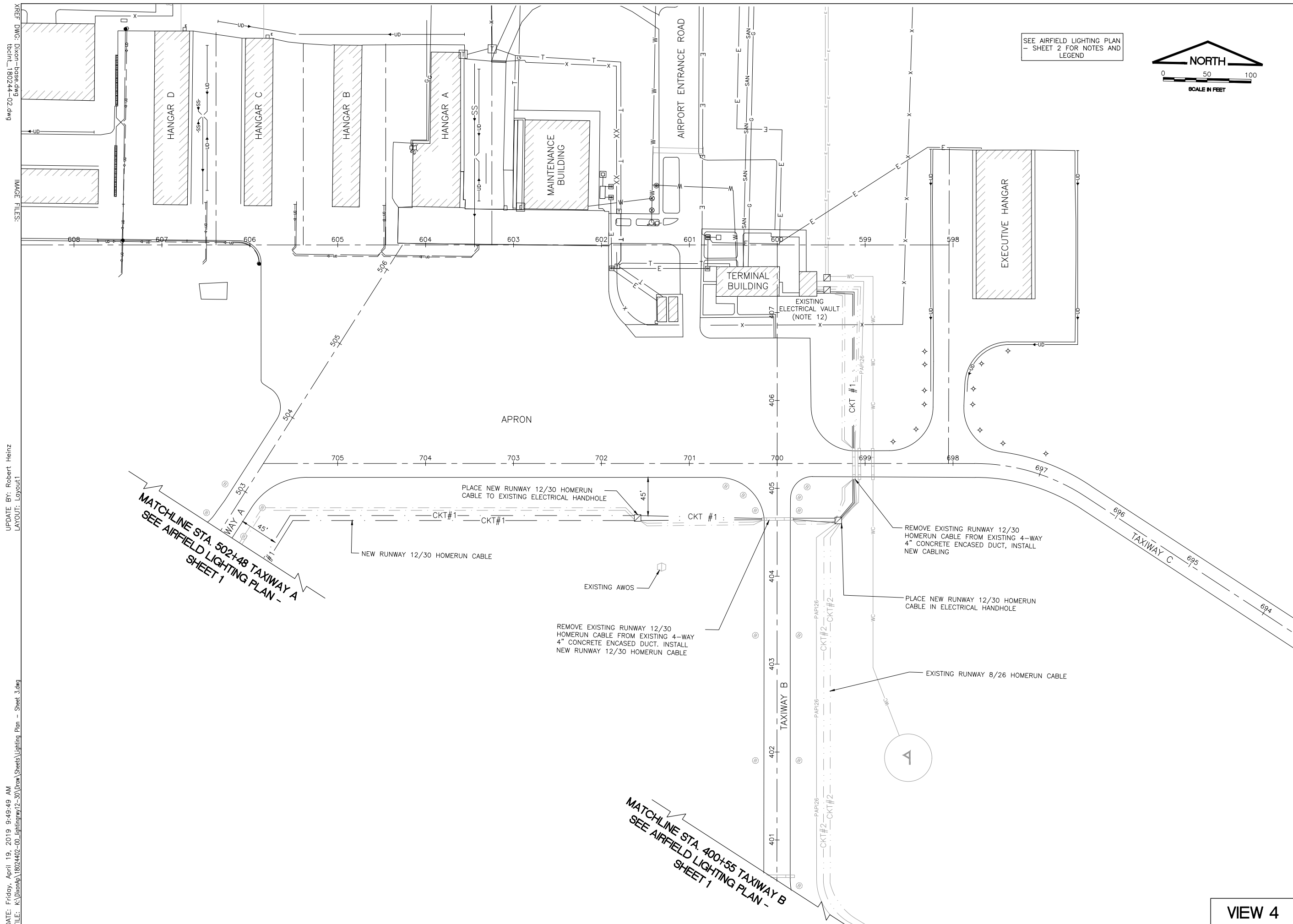

SEE AIRFIELD LIGHTING PLAN - SHEET 2 FOR NOTES AND LEGEND



IL. CONTRACT: **DI029**  
 IL. LETTING ITEM: **01A**  
 IL. PROJECT: **C73-4258**  
 S.B.G. PROJECT: **3-17-SBGP-105/11/120**

SURVEY BOOK #

REVISIONS		
NUMBER	BY	DATE

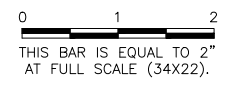

**DIXON MUNICIPAL AIRPORT  
 DIXON, ILLINOIS  
 REHABILITATE ELECTRICAL SYSTEM FOR RUNWAY 12/30  
 AIRFIELD LIGHTING PLAN - SHEET 3**

© Copyright, CMT, Inc.

**CMT**  
 CRAWFORD, MURPHY & TILLY, INC.  
 CONSULTING ENGINEERS  
 License No. 184-000613

DESIGN BY:	RMH
DRAWN BY:	RMH
CHECKED BY:	DKP
APPROVED BY:	DKP
DATE:	4/19/19
JOB No:	180244-02

**FINAL**

SHEET 14 OF 20 SHEETS

MATCHLINE STA. 502+48 TAXIWAY A  
 SEE AIRFIELD LIGHTING PLAN - SHEET 1

MATCHLINE STA. 400+55 TAXIWAY B  
 SEE AIRFIELD LIGHTING PLAN - SHEET 1

**VIEW 4**

DATE: Friday, April 19, 2019 9:49:49 AM  
 FILE: K:\Dixon\18024402-00\_Lighting\12-30\Draw\_Sheets\Lighting Plan - Sheet 3.dwg  
 UPDATE BY: Robert Heinz  
 LAYOUT: Layout1  
 XREF DWG: Dixon\_Base.dwg  
 IMAGE FILES:



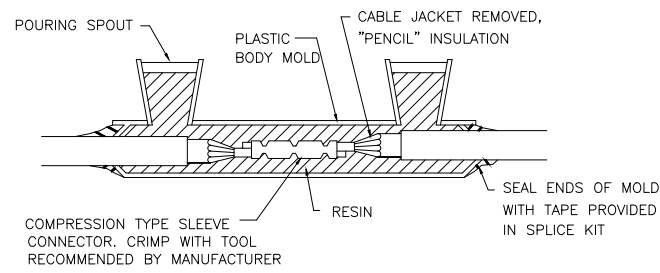

**TYPE A - CABLE SPLICE**

FOR SPLICES IN HOMERUNS AND FOR EXTENSIONS TO EXISTING CABLES ONLY  
N.T.S.

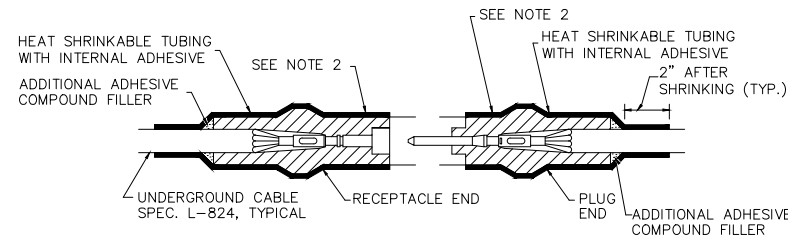

**TYPE B - CABLE SPLICE**

FOR SPLICES FOR USE AT JUNCTION OF HOMERUN WITH LOOP CIRCUIT  
NOT TO SCALE

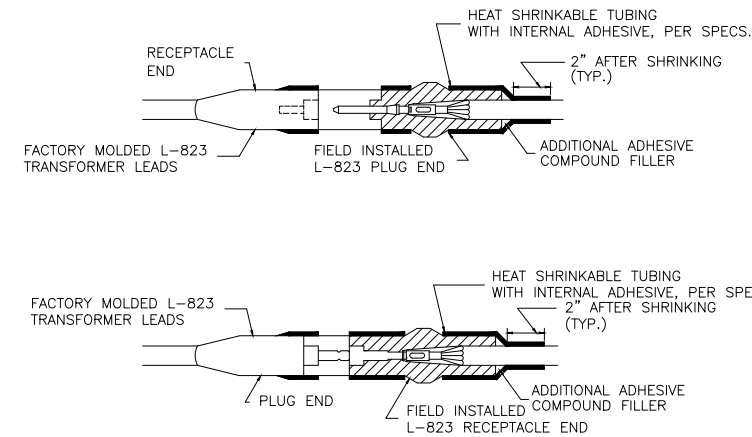

**TYPE C AND D - CABLE SPLICE**

FOR SPLICES AT RUNWAY/TAXIWAY LIGHTS AND SIGNS  
NOT TO SCALE

**CABLE SPLICE NOTES**

- INSIDE DIAMETER OF CONNECTOR SHALL PROPERLY MATCH THE OUTSIDE DIAMETER OF CABLE.
- WRAP WITH AT LEAST ONE LAYER OF RUBBER OR SYNTHETIC RUBBER TAPE AND ONE LAYER OF PLASTIC TAPE, ONE-HALF LAPPED, EXTENDING AT LEAST 1-1/2 INCHES ON EACH SIDE OF JOINT.
- THE COST OF FURNISHING AND INSTALLING ALL SPLICE MATERIALS SHALL BE INCIDENTAL TO THE ASSOCIATED CABLE ITEMS.
- THE CONTRACTOR SHALL HAVE A MINIMUM OF TWO (2) TYPE A SPLICE KITS ON THE JOB SITE AT ALL TIMES FOR EMERGENCY REPAIRS.

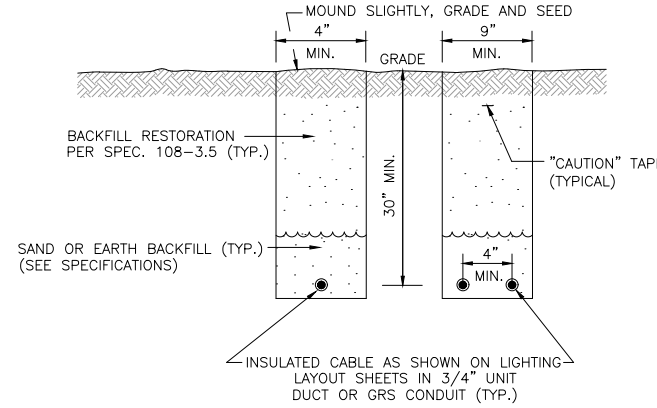

**TURF AREA CABLE TRENCH DETAIL**

NOT TO SCALE

**NOTES**

- TRENCHES WITH MORE THAN 2 CABLES SHALL BE INCREASED 4" IN WIDTH FOR EACH ADDITIONAL CABLE. IF SPECIFIED ON PLANS, TWO PARALLEL TRENCHES MAY BE CONSTRUCTED.
- DEPTH OF TRENCHES SHALL BE AS SHOWN UNLESS OTHERWISE SPECIFIED ON THE PLANS.
- SAND BACKFILL SHALL BE USED IF THE EXISTING SOIL DOES NOT MEET THE BACKFILL REQUIREMENTS.
- ALL DISTURBED SURFACES SHALL BE RESTORED TO THEIR ORIGINAL CONDITION. COST IS INCIDENTAL.

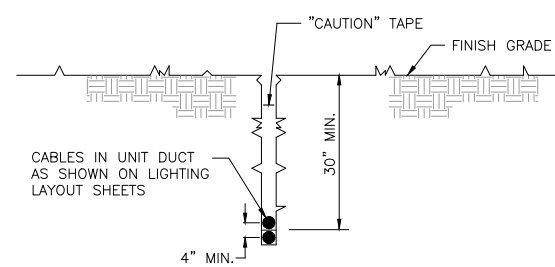

**CABLE IN UNIT DUCT - PLOWED**

NOT TO SCALE

NOTE: CONTRACTOR SHALL HAVE THE OPTION TO TRENCH OR PLOW UNIT DUCT. NO ADDITIONAL PAYMENT SHALL BE MADE FOR TRENCHING.

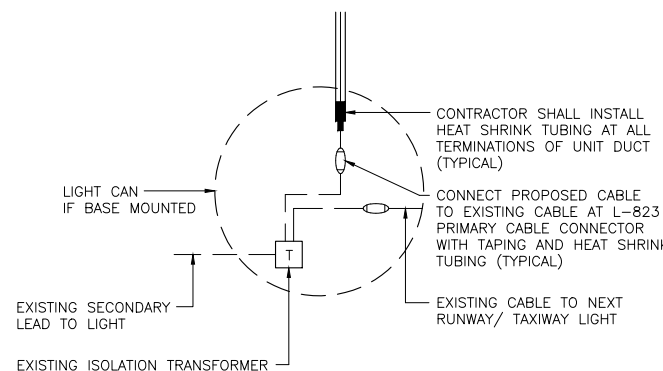

**RUNWAY/TAXIWAY LIGHTING CIRCUIT CONNECTION DETAIL**

NOT TO SCALE

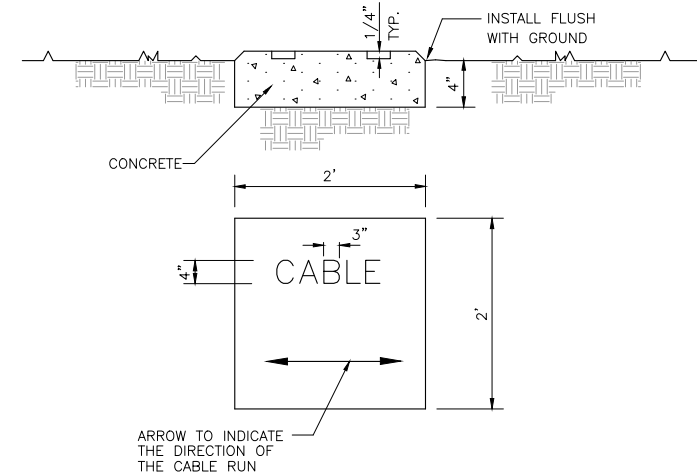

**TURF CABLE MARKER DETAIL**

NO SCALE

**NOTES**

- CABLE MARKERS SHALL BE INSTALLED AT ALL BENDS AND EVERY 200' ALONG THE CABLE RUN.
- ITEM 610 CONCRETE SHALL BE USED.
- ALL EXPOSED EDGES SHALL BE EDGED WITH A 1/4" RADIUS TOOL.
- THE COST OF FURNISHING AND INSTALLING NEW MARKERS SHALL BE INCIDENTAL TO THE ASSOCIATED CABLE ITEMS.
- 0.049 CU. YD. CONCRETE PER MARKER.

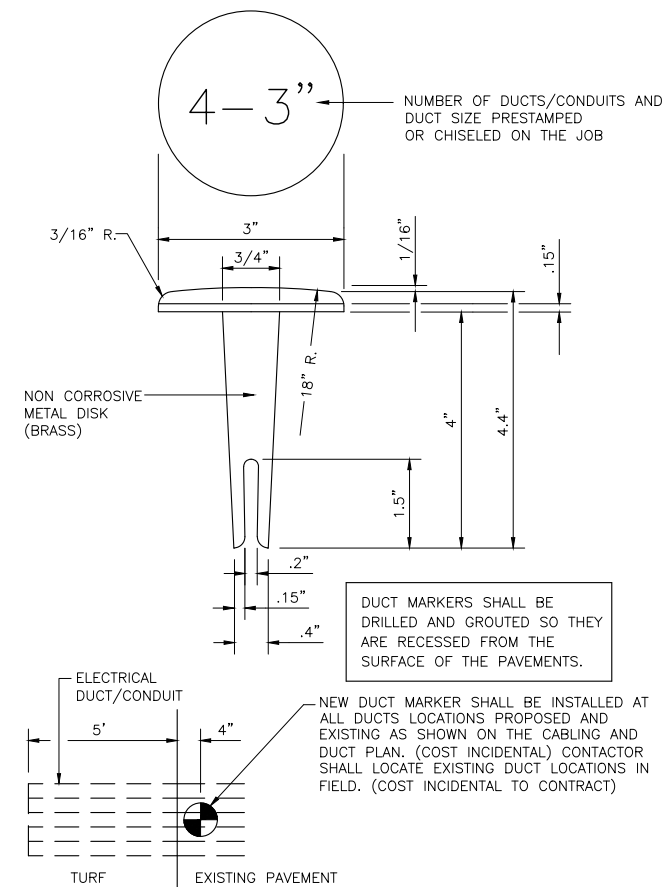

**DUCT MARKER DETAIL**

NOT TO SCALE

IL. CONTRACT: **DI029**  
IL. LETTING ITEM: **01A**  
IL. PROJECT: **C73-4258**  
S.B.G. PROJECT: **3-17-SBGP-105/111/120**

SURVEY BOOK #

**REVISIONS**

NUMBER	BY	DATE

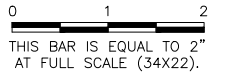

THIS BAR IS EQUAL TO 2" AT FULL SCALE (34X22).

**DIXON MUNICIPAL AIRPORT  
DIXON, ILLINOIS  
REHABILITATE ELECTRICAL SYSTEM FOR RUNWAY 12/30**

**ELECTRICAL DETAILS - SHEET 1**

© Copyright, CMT, Inc.

**CMT**  
CRAWFORD, MURPHY & TILLY, INC.  
CONSULTING ENGINEERS  
License No. 184-000613

DESIGN BY:	RMH
DRAWN BY:	RMH
CHECKED BY:	DKP
APPROVED BY:	DKP
DATE:	4/19/19
JOB No:	180244-02

**FINAL**

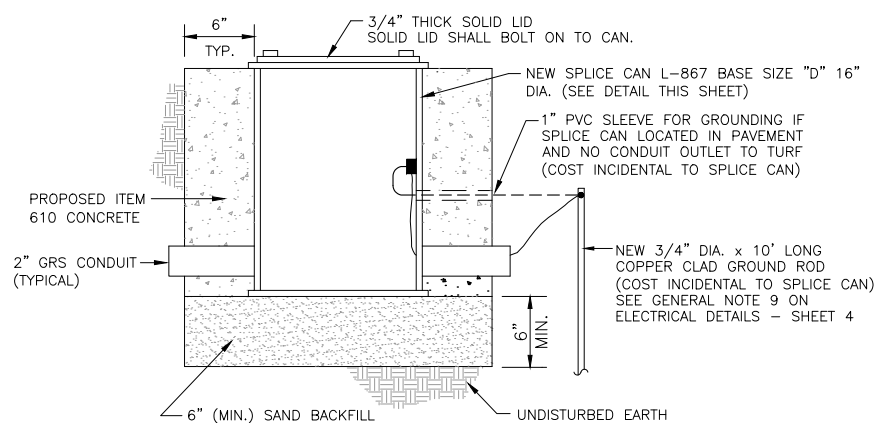

**NEW SPLICE CAN DETAIL**  
 NOT TO SCALE

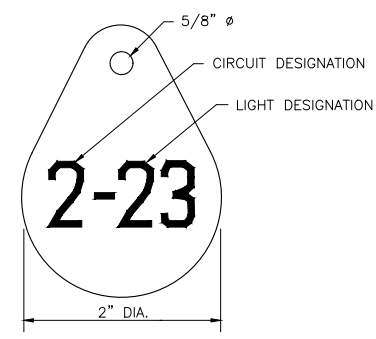

**LIGHT IDENTIFICATION DETAIL**  
 NOT TO SCALE

- NOTES:**
1. INSTALL A NONCORROSIVE DISC OF 2" MINIMUM DIAMETER WITH THE NUMBER PERMANENTLY STAMPED, CUT OUT, OR ENGRAVED UNDER THE HEAD OF THE BASE PLATE BOLT OR ATTACHED TO LIGHT FLANGE WITH A SET SCREW.
  2. NUMERALS SHOWN ARE FOR ILLUSTRATIVE PURPOSES ONLY. ALL EXISTING AND PROPOSED TAXIWAY AND RUNWAY LIGHTS SHALL BE TAGGED AS DIRECTED BY THE RESIDENT ENGINEER. ALL LIGHTS ON EXISTING CIRCUITS THAT HAVE LIGHTING IMPROVEMENTS (PROPOSED OR RELOCATED LIGHTS) SHALL BE RETAGGED.
  3. COST OF TAGGING LIGHTS SHALL NOT BE PAID FOR SEPARATELY BUT SHALL BE CONSIDERED INCIDENTAL TO THE CONTRACT.

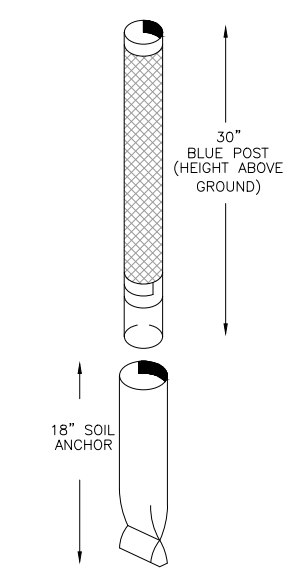

**ELEVATED RETROFLECTIVE MARKER (SOIL ANCHOR MOUNT)**  
 NOT TO SCALE

NOTE: RETROFLECTIVE MARKER SHALL BE L-853 CERTIFIED.

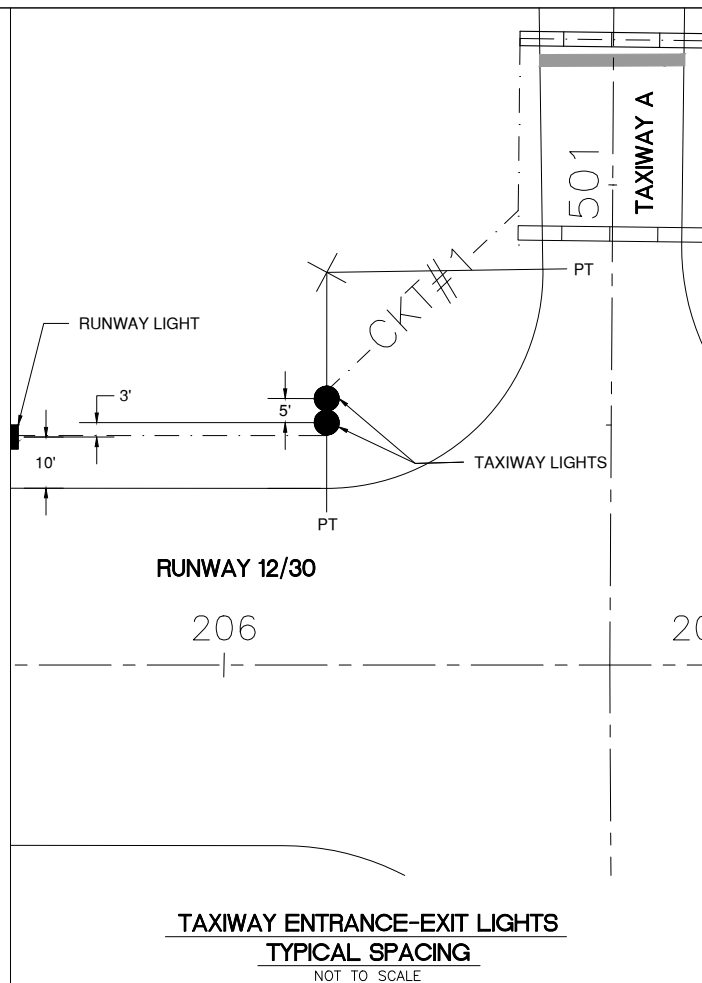

**TAXIWAY ENTRANCE-EXIT LIGHTS TYPICAL SPACING**  
 NOT TO SCALE

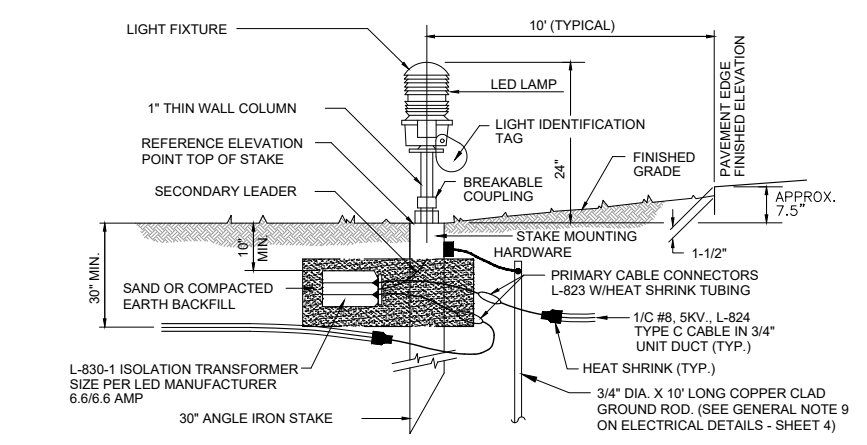

**STAKE MOUNTED MEDIUM INTENSITY RUNWAY EDGE LIGHT (LED), RUNWAY THRESHOLD LIGHT (LED), TAXIWAY EDGE LIGHT (LED) DETAIL**  
 NOT TO SCALE

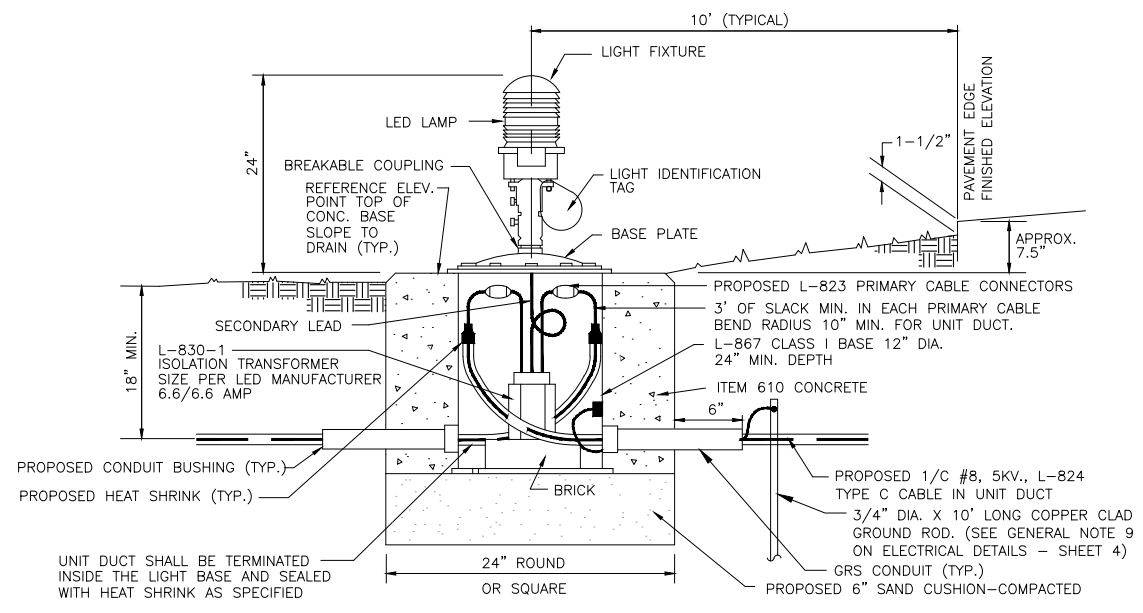

**BASE MOUNTED MEDIUM INTENSITY RUNWAY EDGE LIGHT (LED) DETAIL**  
 NOT TO SCALE

IL. CONTRACT: **D1029**  
 IL. LETTING ITEM: **01A**  
 IL. PROJECT: **C73-4258**  
 S.B.G. PROJECT: **3-17-SBGP-105/11/120**

SURVEY BOOK #

REVISIONS		
NUMBER	BY	DATE

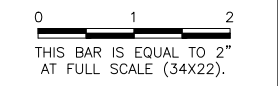

**DIXON MUNICIPAL AIRPORT**  
**DIXON, ILLINOIS**  
**REHABILITATE ELECTRICAL SYSTEM FOR RUNWAY 12/30**

**ELECTRICAL DETAILS - SHEET 2**

© Copyright, CMT, Inc.

**CMT**  
 CRAWFORD, MURPHY & TILLY, INC.  
 CONSULTING ENGINEERS  
 License No. 184-000613

DESIGN BY:	RMH
DRAWN BY:	RMH
CHECKED BY:	DKP
APPROVED BY:	DKP
DATE:	4/19/19
JOB No:	180244-02

**FINAL**

REVISIONS		
NUMBER	BY	DATE

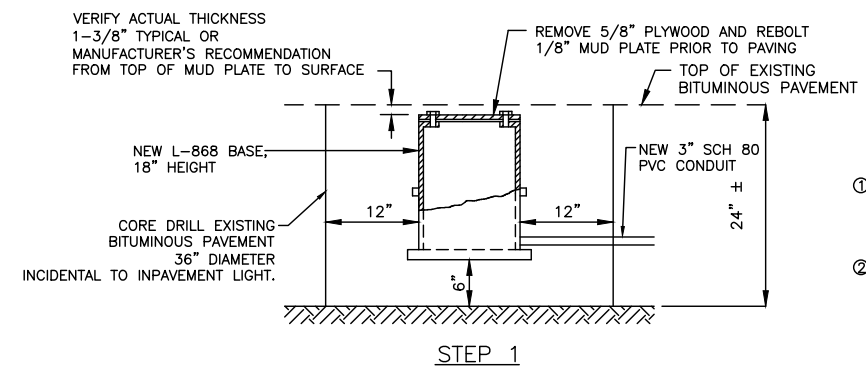
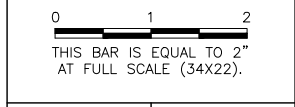

- ① REMOVE WET CONCRETE INSIDE HOOP, REMOVE MUD PLATE AND CLEAN TOP FLANGE OF LIGHT BASE. REINSTALL MUD PLATE.
- ② FINISH EDGE AROUND HOOP TOOL WITH A CURVED TROWEL TO PROVIDE A RADIUS AROUND THE EDGE.

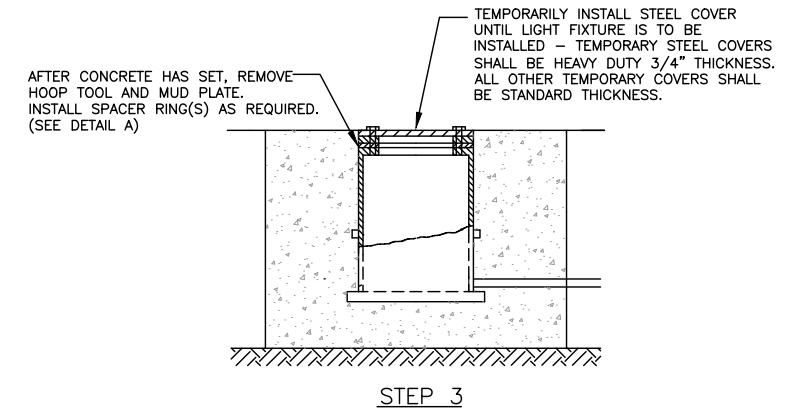
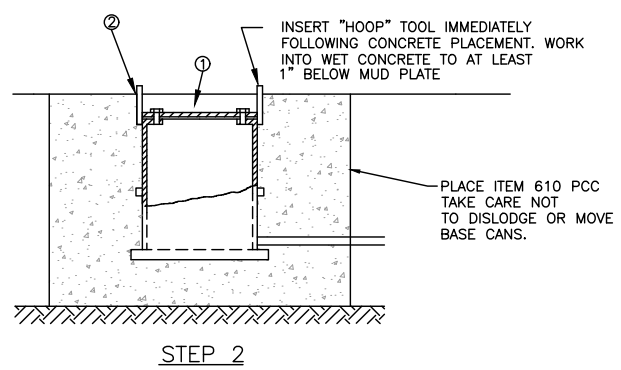

**NEW IN-PAVEMENT LIGHT  
INSTALLATION IN NEW PCC PAVEMENT**  
NO SCALE

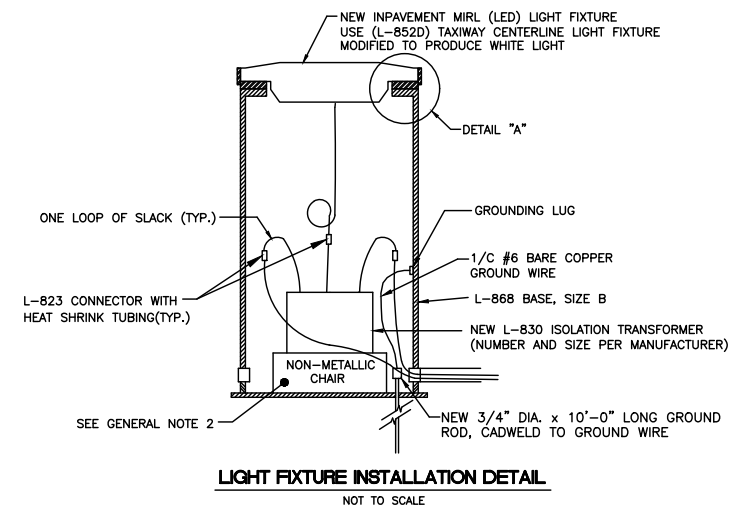
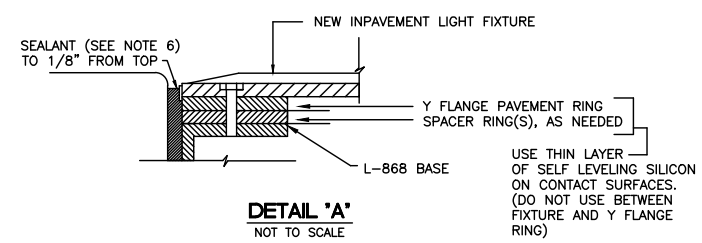

**INSTALLATION IN PCC PAVEMENT NOTES**

1. EXCAVATE TO PROPER DEPTH TO ALLOW 6" CONCRETE ENCASEMENT UNDER NEW BASES AND 6" UNDER NEW CONDUIT. CLEAN CUT EDGES AND COMPACT BOTTOM OF EXCAVATION.
2. USE MANUFACTURERS SETTING JIG (OR OTHER DEVICE APPROVED BY THE ENGINEER FOR PROPERLY ALIGNING NEW L-868 BASES. SECURE SETTING JIG TO PREVENT MOVEMENT DURING CONCRETE ENCASEMENT. ALL CONDUITS TO BE SUPPORTED DURING CONSTRUCTION AS REQUIRED.
3. ALL LIGHT BASES SHALL BE PROPERLY POSITIONED AND ALIGNED AND CONDUIT CONNECTING THE BASES PROPERLY SECURED IN PLACE BEFORE POURING CONCRETE. ENSURE PROPER ALIGNMENT AFTER CONCRETE ENCASEMENT OF NEW BASE BEFORE CONCRETE SETS. TIGHT CONNECTIONS MUST BE ASSURED TO PREVENT CONCRETE FROM ENTERING BASE OR CONDUIT.
4. AFTER INSTALLATION OF THE L-868 BASE AND WHILE PCC AT THE FIXTURE LOCATION IS WET, INSERT "HOOP" TOOL TO AT LEAST 1" BELOW MUD PLATE. REMOVE WET CONCRETE FROM INSIDE HOOP AND CLEAN TOP FLANGE SURFACE. FINISH THE CONCRETE AROUND THE HOOP TOOL WITH A CURVED RADIUS TROWEL. USE CAUTION TO AVOID AGGREGATE SEGREGATION DURING THIS PROCEDURE.
5. AFTER CONCRETE HAS SET, REMOVE HOOP TOOL AND MUD PLATE. INSTALL FLANGE AND SPACER RINGS AS REQUIRED AND LIGHT ASSEMBLY. A TEMPORARY STEEL COVER MAY BE INSTALLED IF LIGHT FIXTURE IS TO BE INSTALLED LATER.
6. AFTER FIXTURE INSTALLATION, FILL THE ANNULAR SPACE BETWEEN THE FIXTURE BASE AND SURROUNDING PAVEMENT WITH TWO COMPONENT ADHESIVE COMPOUND SEALANT AS RECOMMENDED BY FIXTURE MANUFACTURER. ANNULAR SPACE SHALL BE NO MORE THAN 3/4" WIDE.
7. INSTALL BASE AND RINGS SO THAT OUTER EDGE OF LIGHT FIXTURE WILL BE AT SAME ELEVATION AS THE FINISHED PAVEMENT SURFACE TO (+) 0" (-) 1/16" TOLERANCE. THE TOTAL THICKNESS OF THE SPACER/FLANGE RINGS SHALL BE NO LARGER THAN 3/4" MAX. NO MORE THAN 3 RINGS SHALL BE USED.
8. CONCRETE FOR NEW FOUNDATION SHALL BE IN ACCORDANCE WITH THE REQUIREMENTS OF ITEM 610 PCC.
9. COSTS FOR CONCRETE FOUNDATION PAD, WIRE MESH AND SAND SHALL BE CONSIDERED INCIDENTAL TO AR125512 MRL, INPAVEMENT.

**DIXON MUNICIPAL AIRPORT  
DIXON, ILLINOIS  
REHABILITATE ELECTRICAL SYSTEM FOR RUNWAY 12/30**

**ELECTRICAL DETAILS - SHEET 3**

© Copyright CMT, Inc.  
**CMT**  
CRAWFORD, MURPHY & TILLY, INC.  
CONSULTING ENGINEERS  
License No. 184-000613

DESIGN BY:	RMH
DRAWN BY:	RMH
CHECKED BY:	DKP
APPROVED BY:	DKP
DATE:	4/19/19
JOB No:	180244-02

**FINAL**



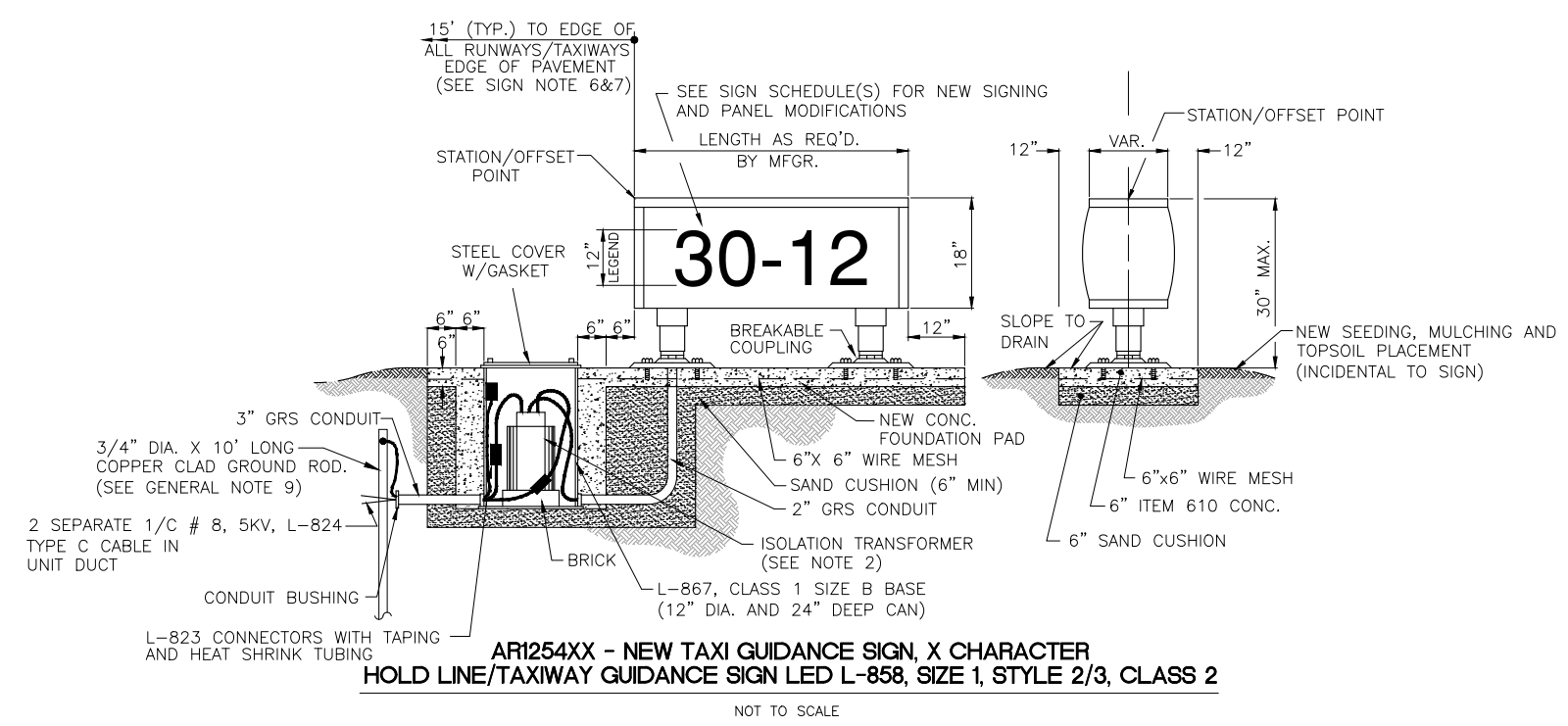

CONTRACTOR SHALL SUBMIT DETAILED SHOP DRAWING INCLUDING SIGN, COLOR, SIZE, PROPOSED LEGEND, IN ENOUGH DETAIL AND DETERMINE NEW SPACING AND OTHER INFORMATION REQUIRED BY SPECIAL PROVISIONS. CONTRACTOR TO VERIFY NEW SIGN LOCATIONS AND ORIENTATIONS WITH RESIDENT ENGINEER PRIOR TO INSTALLATION. SIGN SHALL BE FAA APPROVED LED TYPE SIGN.

**GUIDANCE SIGN NOTES:**

- ALL SIGNS ARE 2 - SIDED SIGNS
- TRANSFORMER WATTAGE AS RECOMMENDED BY MANUFACTURER OF LED SIGNS
- LIGHTED SIGNS SHALL BE BASE MOUNTED ONLY
- UNIT DUCT SHALL BE TERMINATED IN THE CAN AND SEALED TO THE CABLE WITH HEAT SHRINK AS SPECIFIED
- ALL NEW SIGNS SHALL BE LED TYPE, L-858 APPROVED BY FAA
- TYPICAL DISTANCES FOR RUNWAY HOLD SHORT SIGNS FROM RUNWAY CENTERLINE ARE AS FOLLOWS:  
12/30 = 125'  
8/26 = 125'
- ALL TAXIWAY HOLD SIGNS CONNECTED TO MEDIUM INTENSITY RUNWAY CIRCUIT 12/30 OR 8/26 SHALL BE STYLE 2 (3-STEP)

**GENERAL NOTES:**

- THE CONCRETE BASE FOR BASE MOUNTED LIGHTS SHALL BE TROWEL FINISHED WITH A 45° BEVELED EDGE. SLOPE TO DRAIN (610).
- TRANSFORMER SIZE SHALL BE PER SIGN MANUFACTURER. TRANSFORMER HOLDER SHALL BE ANY COMMERCIALY AVAILABLE BRICK.
- BREAKING GROOVE COUPLINGS SHALL NOT BE OVER 1" ABOVE GROUND LINE.
- ISOLATION TRANSFORMERS COME WITH A FACTORY INSTALLED PLUG (TYPE 1, CLASS A, STYLE 2) AND RECEPTACLE (TYPE 1, CLASS A, STYLE 9). A TYPE 1, CLASS B, STYLE 3 PLUG AND TYPE 1, CLASS B, STYLE 10 RECEPTACLE SHALL BE INSTALLED ON THE 1/C, No. 8, 5000 V., L-824 TYPE C CABLES FOR CONNECTION TO EACH TRANSFORMER.
- TO FURTHER REDUCE THE POSSIBILITY OF WATER/MOISTURE ENTRANCE INTO THE CONNECTOR BETWEEN THE CABLE AND THE FIELD ATTACHED CONNECTOR, IT IS REQUIRED THAT A HEAT SHRINKABLE TUBING WITH INTERNAL ADHESIVE BE APPLIED OVER THE ENTIRE CABLE CONNECTOR.
- ALL SIGNS, LIGHTS, CABLES AND TRANSFORMERS TO BE REMOVED SHALL REMAIN THE PROPERTY OF THE AIRPORT. AT THE DISCRETION OF THE AIRPORT MANAGER, THE CONTRACTOR MAY BE REQUIRED TO DISPOSE OF THESE MATERIALS OFFSITE AT NO ADDITIONAL COST TO THE CONTRACT.
- CONTRACTOR SHALL HAVE THE OPTION TO TRENCH OR PLOW UNIT DUCT. NO ADDITIONAL PAYMENT SHALL BE MADE FOR TRENCHING.
- TAXIWAY ELEVATED RETROREFLECTIVE MARKERS SHALL REFLECT BLUE, TAXIWAY LIGHTS SHALL BE BLUE, RUNWAY LIGHTS SHALL HAVE A CLEAR OR 180° CLEAR/CLEAR LENS AND THRESHOLD LIGHTS SHALL HAVE GREEN/RED LENS AS DESIGNATED ON PLANS.
- INSTALL 1/C #6 AWG BARE COPPER GROUND JUMPER CONNECTED TO GROUND LUG INSIDE BASE CAN OR STAKE AND EXOTHERMICALLY WELDED TO GROUND ROD. GROUND ROD AND GROUND WIRE SHALL BE INCIDENTAL TO CONTRACT.

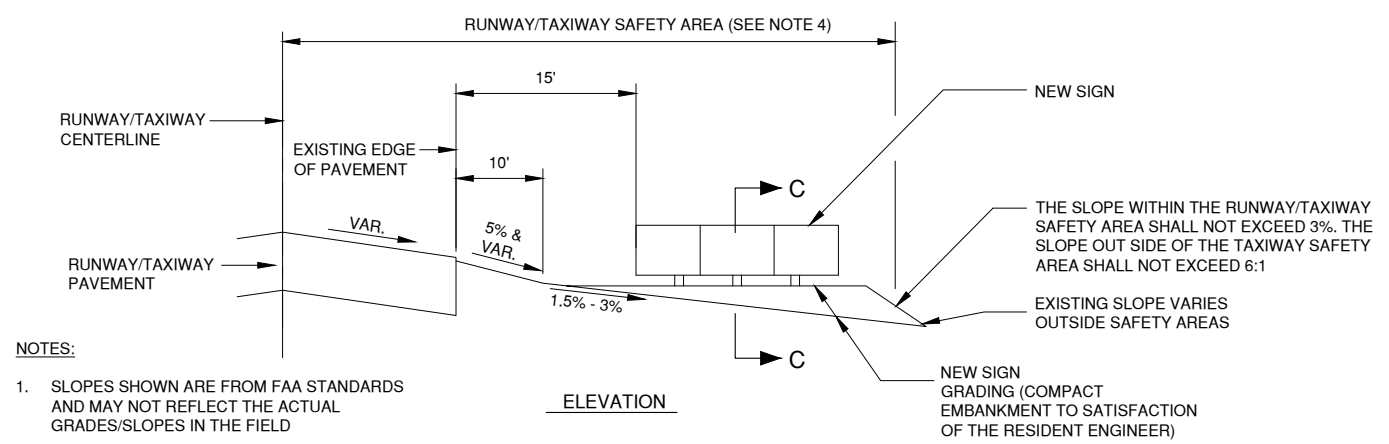

- NOTES:**
- SLOPES SHOWN ARE FROM FAA STANDARDS AND MAY NOT REFLECT THE ACTUAL GRADES/SLOPES IN THE FIELD
  - ESTIMATED 2 C.Y. OF EMBANKMENT MAY BE REQUIRED TO CONSTRUCT SIGN BASE FOUNDATION. ALL OFFSITE MATERIAL SHALL BE IN ACCORDANCE WITH ITEM 905-1.2 CLEAN CONSTRUCTION OR DEMOLITION DEBRIS FOR OFFSITE BORROW MATERIAL. COSTS TO CONSTRUCT SHALL BE INCIDENTAL TO SIGN PAY ITEM. ESTIMATED QUANTITY OF EMBANKMENT IS FOR INFORMATION ONLY. NO ADDITIONAL COST FOR ANY ADDITIONAL EMBANKMENT NEEDED.
  - ACTUAL LOCATION OF THE SIGN WITHIN THE TAXIWAY SAFETY AREA WILL VARY DUE TO PAVEMENT WIDTHS AND VARIANCES IN SIGN FOUNDATION LENGTHS.
  - DIMENSIONS FROM PAVEMENT CENTERLINE:  
RUNWAY 12/30 = 60'  
RUNWAY 8/26 = 60'  
ALL TAXIWAYS = 24.5'

**GRADING AIRFIELD SIGN DETAILS**

NOT TO SCALE

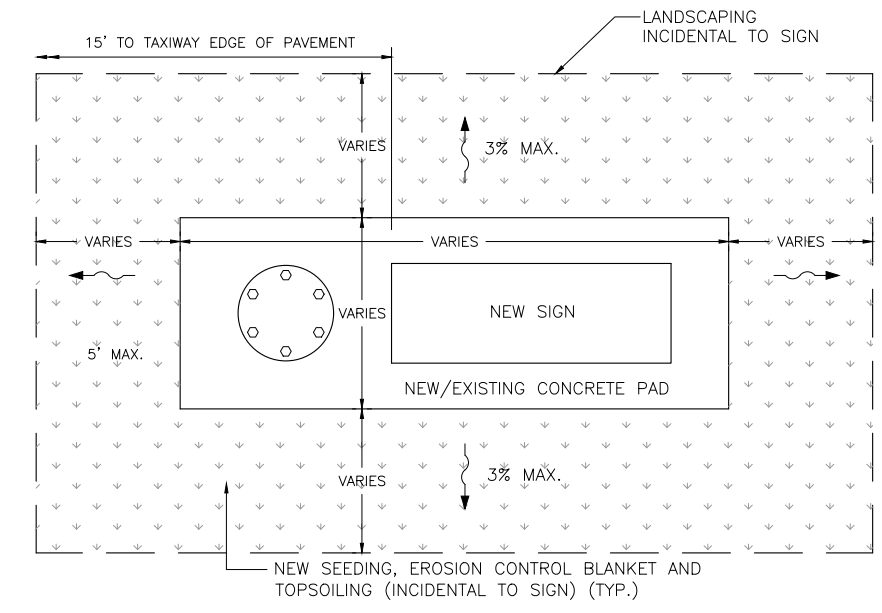
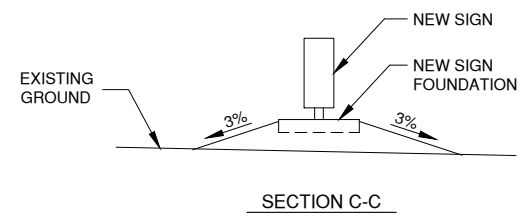

**TYPICAL LANDSCAPING FOR AR1254XX NEW TAXIWAY GUIDANCE SIGN**

NOT TO SCALE

IL. CONTRACT: **DI029**  
IL. LETTING ITEM: **01A**  
IL. PROJECT: **C73-4258**  
S.B.G. PROJECT: **3-17-SBGP-105/111/120**

SURVEY BOOK #

REVISIONS		
NUMBER	BY	DATE

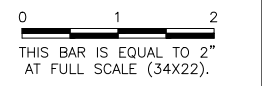

**DIXON MUNICIPAL AIRPORT  
DIXON, ILLINOIS  
REHABILITATE ELECTRICAL SYSTEM FOR RUNWAY 12/30**

**ELECTRICAL DETAILS - SHEET 4**

© Copyright CMT, Inc.

**CMT**  
CRAWFORD, MURPHY & TILLY, INC.  
CONSULTING ENGINEERS  
License No. 184-000613

DESIGN BY:	RMH
DRAWN BY:	RMH
CHECKED BY:	DKP
APPROVED BY:	DKP
DATE:	4/19/19
JOB No:	180244-02

**FINAL**

DATE: Friday, April 19, 2019 9:53:44 AM  
 FILE: K:\Browns\18024402-00\_Restroom\12-30\Drawn Sheets\Erosion Control Plan.dwg  
 UPDATE BY: Robert Heinz  
 LAYOUT: Layout1  
 IMAGE FILES:  
 REF DWG: Dixon-Base.dwg  
 6/16/2017 10:07:00 AM

**LEGEND**

- EXISTING BUILDING
- EXISTING PAVEMENT
- NEW RUNWAY 8/26 CIRCUIT 1/C #8 5KV IN 3/4" UNIT DUCT
- NEW RUNWAY 12/30 HOMERUN CIRCUIT 1/C #8 5KV IN 3/4" UNIT DUCT
- AIRPORT PROPERTY LINE
- NEW 4" CONDUIT (BORED & JACKED)
- EXISTING CONDUIT
- NEW STAKE MOUNTED MEDIUM INTENSITY RUNWAY LIGHT
- NEW BASE MOUNTED MEDIUM INTENSITY RUNWAY LIGHT
- NEW STAKE MOUNTED MEDIUM INTENSITY THRESHOLD LIGHT
- NEW HANDHOLE
- NEW AIRFIELD GUIDANCE SIGN
- NEW EROSION CONTROL BLANKET (156) AND SEEDING (901)

**NOTES**

1. THE SITE DISTURBANCE IS LESS THAN 1 ACRE. THE PROJECT DOES NOT REQUIRE NPDES GENERAL PERMIT NO. 2. THE CONTRACTOR WILL STILL BE REQUIRED TO USE BEST CONSTRUCTION PRACTICES TO COMPLY WITH THE REQUIREMENTS OF THE NATIONAL POLLUTANT DISCHARGE ELIMINATION SYSTEM (NPDES) REQUIREMENTS FOR CONSTRUCTION SITE ACTIVITIES.
2. ALL PROJECT AREAS, INCLUDING STOCKPILES, ABANDONED HAUL ROADS AND STAGING AREAS, AS SHOWN ON THE PLANS OR COORDINATED IN THE FIELD, SHALL HAVE 4 INCHES OF TOPSOIL PLACED, BE SEEDED AND MULCHED IN ACCORDANCE WITH THE SPECIFICATIONS. AREAS DISTURBED WITHIN THE PROJECT LIMITS AND OUTSIDE THE PROJECT LIMITS WILL BE SEEDED AND MULCHED BY THE CONTRACTOR AT HIS COST AND RESTORED TO ORIGINAL CONDITIONS.
3. FOR DETAILS SEE THIS SHEET.
4. FOR LANDSCAPING LIMITS FOR JACKING PITS SEE THIS SHEET.
5. IN AREAS WHERE WORK IS COMPLETE, PERMANENT STABILIZATION SHALL OCCUR WITHIN 7 DAYS OF COMPLETION, AND IN AREAS WHERE WORK WILL BE TEMPORARILY CEASED FOR 14 DAYS OR MORE, TEMPORARY STABILIZATION SHALL OCCUR BY THE 14TH DAY AFTER WORK HAS CEASED. TEMPORARY STABILIZATION SHALL BE CONSIDERED INCIDENTAL TO THE CONTRACT.
6. IF REQUIRED TEMPORARY EROSION CONTROL SEED SHALL CONSIST OF SPRING OATS FROM MARCH 1ST TO JUNE 30TH AND WINTER WHEAT OR CEREAL RYE FROM JULY 1ST THRU NOVEMBER 15TH. THE SEED SHALL BE APPLIED BY HAND BROADCASTING TO ACHIEVE A REASONABLE UNIFORM COVERAGE AT A RATE OF 100 LB/ACRE. NO DIRECT PAYMENT WILL BE MADE FOR TEMPORARY EROSION CONTROL SEEDING. IT SHALL BE CONSIDERED INCIDENTAL TO THE CONTRACT.
7. CONTRACTOR SHALL PROVIDE CONCRETE WASHOUT BOX FOR ALL CONCRETE READY MIX TRUCKS OR EACH READY MIX TRUCK SHALL BE EQUIPPED WITH A WASH OUT SYSTEM.
8. EROSION CONTROL BLANKET AND SEEDING ARE TO BE INCIDENTAL TO CONTRACT.

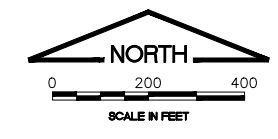

IL. CONTRACT: **D1029**  
 IL. LETTING ITEM: **01A**  
 IL. PROJECT: **C73-4258**  
 S.B.G. PROJECT: **3-17-SBGP-105/11/120**

SURVEY BOOK #

REVISIONS		
NUMBER	BY	DATE

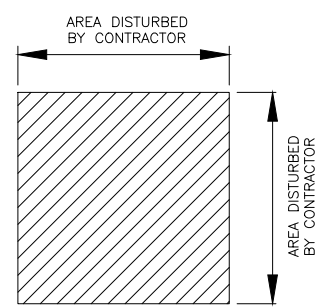
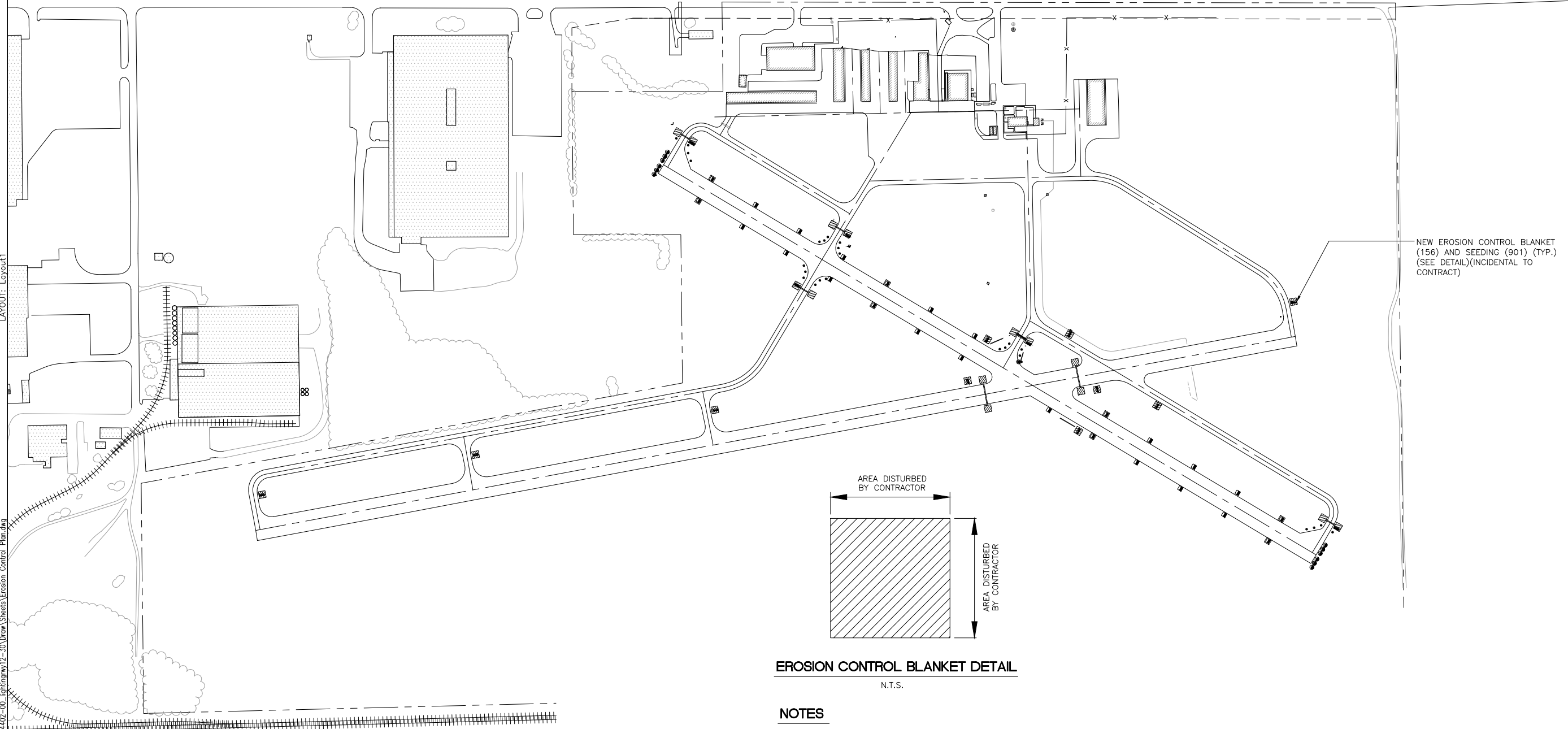
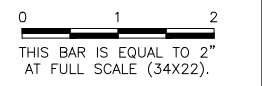

**EROSION CONTROL BLANKET DETAIL**

N.T.S.

**NOTES**

1. EROSION CONTROL MATERIAL SHALL BE PLACED LOOSELY OVER GROUND SURFACE. DO NOT STRETCH.

**DIXON MUNICIPAL AIRPORT**  
**DIXON, ILLINOIS**  
**REHABILITATE ELECTRICAL SYSTEM FOR RUNWAY 12/30**  
**EROSION CONTROL PLAN**

© Copyright, CMT, Inc.

**CMT**  
 CRAWFORD, MURPHY & TILLY, INC.  
 CONSULTING ENGINEERS  
 License No. 184-000613

DESIGN BY:	RMH
DRAWN BY:	RMH
CHECKED BY:	DKP
APPROVED BY:	DKP
DATE:	4/19/19
JOB No:	180244-02

**FINAL**