

"Install and orient arm bracket over pole tenon and firmly hand tighten the two set screws. Use third hole in arm bracket as a guide to drill a 8.3 (3/4) diameter hole through tenon. Install and tighten self-tapping screw. Tighten set screws an additional (1/4 to 3/8) turn with hex key (not provided). Install locknuts on set screws if threaded projection allows."

Pole shall meet AASHTO Standard Specifications for 128.72 km (80 mph) wind loading and 40.82 kg (90 lb.), 3.7 m² (4.0 sq. ft.) E.P.A. luminaire.

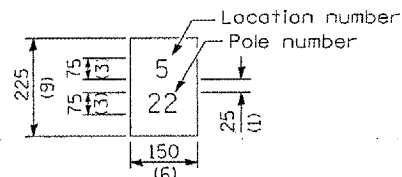

The contractor shall furnish and install a light pole identification of each new light pole, as shown above, incidental to the respective light pole pay item. The numerals shall be 75 (3) series "D", black, screened on silver-white type B pressure sensitive reflective sheeting conforming to the requirements of section T602.01 of the Standard Specifications for Traffic Control Items. The numerals shall conform to the FHWA "Standard Alphabets for Highway Signs".

The light pole identification shall be applied to sign base material as specified in section 1085.05 of the Standard Specifications, approximately 180 (7) above the adjacent pavement grade visible to approaching traffic in accordance with Highway Standard 2319.

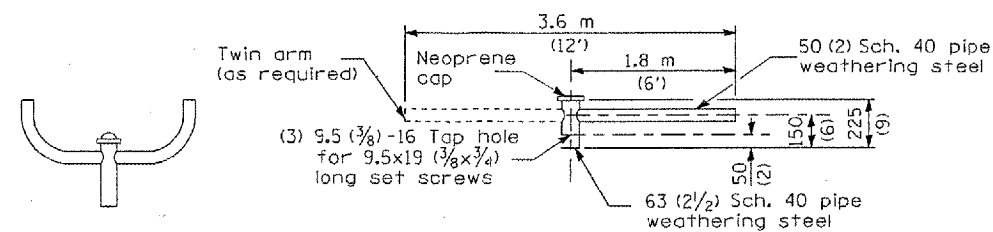

TWIN TENON TENON MOUNT BRACKET ARM

NOTE: Single or twin arm assembly shall be tilted 3° above horizontal.

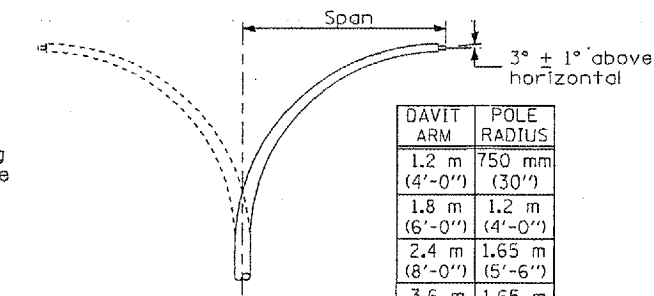

DAVIT ARM DAVIT ARM-TWIN

DAVIT ARM	POLE RADIUS
1.2 m (4'-0")	750 mm (30")
1.8 m (6'-0")	1.2 m (4'-0")
2.4 m (8'-0")	1.65 m (5'-6")
3.6 m (12'-0")	1.65 m (5'-6")

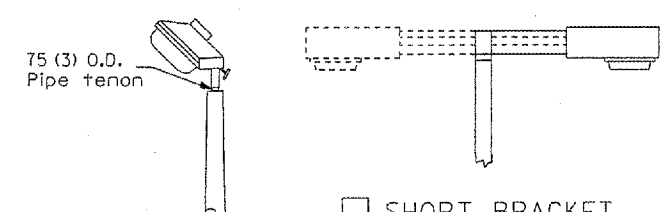

TENON SHORT BRACKET
 SHORT BRACKET - TWIN

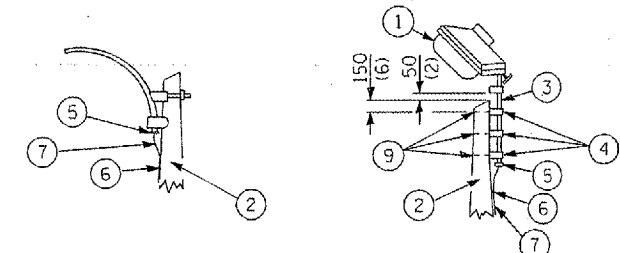

- ① Luminaire
- ② Wood pole, class 3 or better
- ③ 63 (2 1/2) Galv. steel conduit
- ④ Single offset pole band
- ⑤ Conduit bushing
- ⑥ Cable clamps on 600 (24) centers
- ⑦ 2/c #12 Type use cable
- ⑧ 25 (1) Galv. steel conduit 3.0 m (10') in length
- ⑨ 16 (5/8) Ø hot dipped galvanized bolt with flat washer & locknut (3 req'd)
- ⑩ Conduit clamps on 900 (36) centers
- ⑪ Unit duct
- ⑫ Threaded reducer
- ⑬ "C" Condulet, threaded
- ⑭ 40 (1 1/2) Galv. steel conduit for 1 unit duct or 75 (3) galv. steel conduit for 2 or 3 unit ducts.

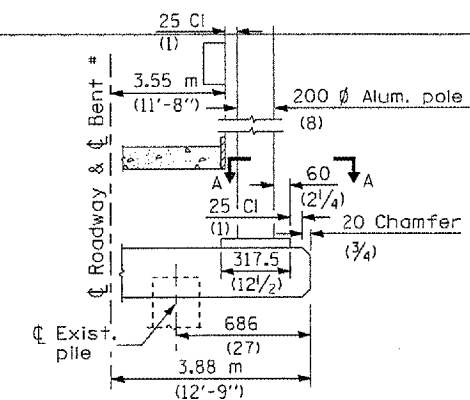

BENT # (Looking)

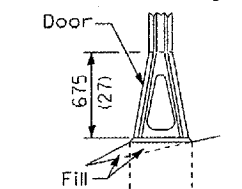

STAINLESS STEEL FLAIR BASE

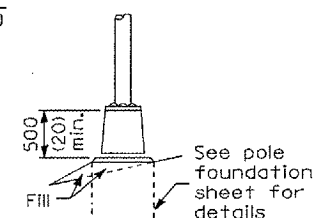

TRANSFORMER BASE

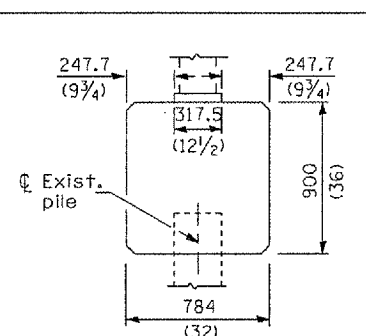

BRIDGE PIER MOUNT

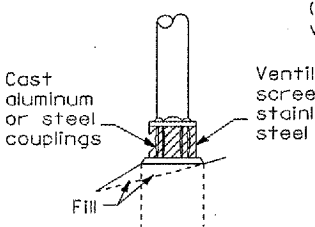

BREAKAWAY COUPLING

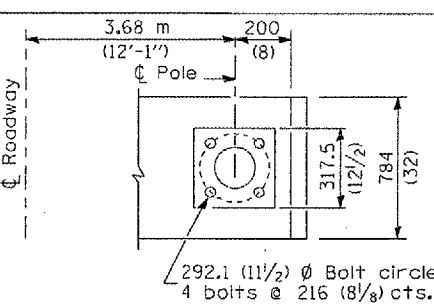

SECTION A-A

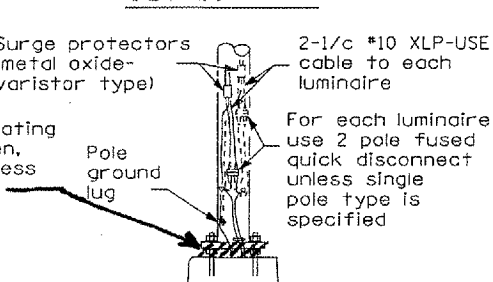

ANCHOR

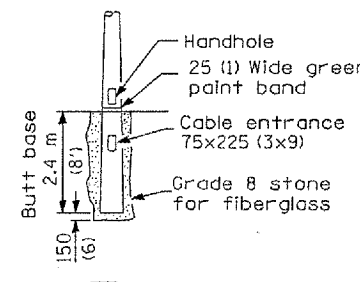

BUTT BASE

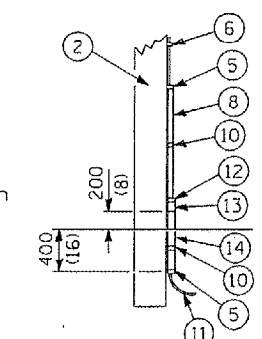

POLE, WOOD

POLE LENGTH	DEPTH IN GROUND
19.8 m (65')	3.6 m (12')
18.0 m (60')	3.0 m (10')
16.8 m (55')	2.7 m (9')
16.0 m (50')	2.4 m (8')
13.7 m (45')	2.1 m (7')
12.0 m (40')	2.0 m (6.5')
10.7 m (35')	1.8 m (6')
9.0 m (30')	1.7 m (5.5')

All dimensions are in millimeters (inches) unless otherwise shown.

POLE STANDARDS

LGT008.M32

DATE	REVISIONS	POLE STANDARDS

LGT008.M32

PLOT DATE = 3/24/2007
 PLOT SCALE = 0.5000
 USER NAME = Engined