

**If you plan to submit a bid directly to the Department of Transportation**

**PREQUALIFICATION**

Any contractor who desires to become pre-qualified to bid on work advertised by IDOT must submit the properly completed pre-qualification forms to the Bureau of Construction no later than 4:30 p.m. prevailing time twenty-one days prior to the letting of interest. This pre-qualification requirement applies to first time contractors, contractors renewing expired ratings, contractors maintaining continuous pre-qualification or contractors requesting revised ratings. To be eligible to bid, existing pre-qualification ratings must be effective through the date of letting.

**REQUESTS FOR AUTHORIZATION TO BID**

Contractors downloading and/or ordering CD-ROM's and are wanting to bid on items included in a particular letting must submit the properly completed "Request for Authorization to Bid/or Not For Bid Status" (BDE 124INT) and the ORIGINAL, signed and notarized, "Affidavit of Availability" (BC 57) to the proper office no later than 4:30 p.m. prevailing time, three (3) days prior to the letting date.

**WHO CAN BID ?**

Bids will be accepted from only those companies that request and receive written **Authorization to Bid** from IDOT's Central Bureau of Construction.

**WHAT CONSTITUTES WRITTEN AUTHORIZATION TO BID?** When a prospective prime bidder submits a "Request for Authorization to Bid/or Not For Bid Status" (BDE 124INT) he/she must indicate at that time which items are being requested For Bidding purposes. Only those items requested For Bidding will be analyzed. After the request has been analyzed, the bidder will be issued a **Proposal Denial and/or Authorization Form**, approved by the Central Bureau of Construction, that indicates which items have been approved For Bidding. If **Authorization to Bid** cannot be approved, the **Proposal Denial and/or Authorization Form** will indicate the reason for denial.

**ABOUT AUTHORIZATION TO BID:** Firms that have not received an authorization form within a reasonable time of complete and correct original document submittal should contact the department as to status. This is critical in the week before the letting. These documents must be received three days before the letting date. Firms unsure as to authorization status should call the Prequalification Section of the Bureau of Construction at the number listed at the end of these instructions.

**ADDENDA AND REVISIONS:** It is the contractor's responsibility to determine which, if any, addenda or revisions pertain to any project they may be bidding. Failure to incorporate all relevant addenda or revisions may cause the bid to be declared unacceptable.

Each addendum will be placed with the contract number. Addenda and revisions will also be placed on the Addendum/Revision Checklist and each subscription service subscriber will be notified by e-mail of each addendum and revision issued.

The Internet is the Department's primary way of doing business. The subscription server e-mails are an added courtesy the Department provides. It is suggested that bidder check IDOT's website <http://www.dot.il.gov/desenv/delett.html> before submitting final bid information.

**IDOT is not responsible for any e-mail related failures.**

Addenda Questions may be directed to the Contracts Office at (217)782-7806 or [D&Econtracts@dot.il.gov](mailto:D&Econtracts@dot.il.gov)

Technical Questions about downloading these files may be directed to Tim Garman (217)524-1642 or [garmantr@dot.il.gov](mailto:garmantr@dot.il.gov).

**WHAT MUST BE INCLUDED WHEN BIDS ARE SUBMITTED?:** Bidders need not return the entire proposal when bids are submitted. That portion of the proposal that must be returned includes the following:

1. All documents from the Proposal Cover Sheet through the Proposal Bid Bond
2. Other special documentation and/or information that may be required by the contract special provisions

All proposal documents, including Proposal Guaranty Checks or Proposal Bid Bonds, should be stapled together to prevent loss when bids are processed by IDOT personnel.

**ABOUT SUBMITTING BIDS:** It is recommended that bidders deliver bids in person to insure they arrive at the proper location prior to the time specified for the receipt of bids. Any bid received at the place of letting after the time specified will not be accepted.

**WHO SHOULD BE CALLED IF ASSISTANCE IS NEEDED?**

<b>Questions Regarding</b>	<b>Call</b>
Prequalification and/or Authorization to Bid	(217)782-3413
Preparation and submittal of bids	(217)782-7806
Mailing of plans and proposals	(217)782-7806
Electronic plans and proposals	(217)524-1642

**ADDENDUMS AND REVISIONS TO THE PROPOSAL FORMS**

Planholders should verify that they have received and incorporated the addendum and/or revision prior to submitting their bid. Failure by the bidder to include an addendum could result in a bid being rejected as irregular.

# 56

RETURN WITH BID

Proposal Submitted By
Name
Address
City

## Letting June 15, 2007

BIDDERS NEED NOT RETURN THE ENTIRE PROPOSAL  
(See instructions inside front cover)

### NOTICE TO PROSPECTIVE BIDDERS

This proposal can be used for bidding purposes by only those companies that request and receive written AUTHORIZATION TO BID from IDOT's Central Bureau of Construction.

(SEE INSTRUCTIONS ON THE INSIDE OF COVER)

# Notice To Bidders, Specifications, Proposal, Contract and Contract Bond



Illinois Department  
of Transportation

Springfield, Illinois 62764

Contract No. 76A80  
MARION County  
Section (16,16NRM-Z,16Z)RS-5  
Route FAP 327  
Project F-327(39)  
District 8 Construction Funds

PLEASE MARK THE APPROPRIATE BOX BELOW:

- A Bid Bond is included.
- A Cashier's Check or a Certified Check is included

Plans Included  
Herein

Prepared by

F

Checked by

(Printed by authority of the State of Illinois)

---

---

## INSTRUCTIONS

**ABOUT IDOT PROPOSALS:** All proposals issued by IDOT are potential bidding proposals. Each proposal contains all Certifications and Affidavits, a Proposal Signature Sheet and a Proposal Bid Bond required for Prime Contractors to submit a bid after written **Authorization to Bid** has been issued by IDOT's Central Bureau of Construction.

**WHO CAN BID?:** Bids will be accepted from only those companies that request and receive written **Authorization to Bid** from IDOT's Central Bureau of Construction. To request authorization, a potential bidder must complete and submit Part B of the Request for Authorization to Bid/or Not For Bid Status form (BDE 124 INT) and submit an original Affidavit of Availability (BC 57).

**WHAT CONSTITUTES WRITTEN AUTHORIZATION TO BID?:** When a prospective prime bidder submits a "Request for Proposal Forms and Plans" he/she must indicate at that time which items are being requested For Bidding purposes. Only those items requested For Bidding will be analyzed. After the request has been analyzed, the bidder will be issued a **Proposal Denial and/or Authorization Form**, approved by the Central Bureau of Construction, that indicates which items have been approved For Bidding. If **Authorization to Bid** cannot be approved, the **Proposal Denial and/or Authorization Form** will indicate the reason for denial. If a contractor has requested to bid but has not received a **Proposal Denial and/or Authorization Form**, they should contact the Central Bureau of Construction in advance of the letting date.

**WHAT MUST BE INCLUDED WHEN BIDS ARE SUBMITTED?:** Bidders need not return the entire proposal when bids are submitted. That portion of the proposal that must be returned includes the following:

1. All documents from the Proposal Cover Sheet through the Proposal Bid Bond
2. Other special documentation and/or information that may be required by the contract special provisions

All proposal documents, including Proposal Guaranty Checks or Proposal Bid Bonds, should be stapled together to prevent loss when bids are processed by IDOT personnel.

**ABOUT SUBMITTING BIDS:** It is recommended that bidders deliver bids in person to insure they arrive at the proper location prior to the time specified for the receipt of bids. Any bid received at the place of letting after the time specified will not be accepted.

### WHO SHOULD BE CALLED IF ASSISTANCE IS NEEDED?

Questions Regarding	Call
Prequalification and/or Authorization to Bid	217/782-3413
Preparation and submittal of bids	217/782-7806
Mailing of CD-ROMS	217/782-7806

RETURN WITH BID



PROPOSAL

TO THE DEPARTMENT OF TRANSPORTATION

1. Proposal of \_\_\_\_\_  
\_\_\_\_\_

Taxpayer Identification Number (Mandatory) \_\_\_\_\_

for the improvement identified and advertised for bids in the Invitation for Bids as:

**Contract No. 76A80  
MARION County  
Section (16,16NRM-Z,16Z)RS-5  
Project F-327(39)  
Route FAP 327  
District 8 Construction Funds**

**1.98 miles of milling and HMA surface on U.S. Route 50 from west of I-57 to Weymeyer Avenue in Salem.**

2. The undersigned bidder will furnish all labor, material and equipment to complete the above described project in a good and workmanlike manner as provided in the contract documents provided by the Department of Transportation. This proposal will become part of the contract and the terms and conditions contained in the contract documents shall govern performance and payments.

**RETURN WITH BID**

3. **ASSURANCE OF EXAMINATION AND INSPECTION/WAIVER.** The undersigned further declares that he/she has carefully examined the proposal, plans, specifications, form of contract and contract bond, and special provisions, and that he/she has inspected in detail the site of the proposed work, and that he/she has familiarized themselves with all of the local conditions affecting the contract and the detailed requirements of construction, and understands that in making this proposal he/she waives all right to plead any misunderstanding regarding the same.
  
4. **EXECUTION OF CONTRACT AND CONTRACT BOND.** The undersigned further agrees to execute a contract for this work and present the same to the department within fifteen (15) days after the contract has been mailed to him/her. The undersigned further agrees that he/she and his/her surety will execute and present within fifteen (15) days after the contract has been mailed to him/her contract bond satisfactory to and in the form prescribed by the Department of Transportation, in the penal sum of the full amount of the contract, guaranteeing the faithful performance of the work in accordance with the terms of the contract.
  
5. **PROPOSAL GUARANTY.** Accompanying this proposal is either a bid bond on the department form, executed by a corporate surety company satisfactory to the department, or a proposal guaranty check consisting of a bank cashier's check or a properly certified check for not less than 5 per cent of the amount bid or for the amount specified in the following schedule:

<u>Amount of Bid</u>		<u>Proposal Guaranty</u>		<u>Amount of Bid</u>		<u>Proposal Guaranty</u>	
Up to	\$5,000 .....	\$150		\$2,000,000	to	\$3,000,000 .....	\$100,000
\$5,000	to \$10,000 .....	\$300		\$3,000,000	to	\$5,000,000 .....	\$150,000
\$10,000	to \$50,000 .....	\$1,000		\$5,000,000	to	\$7,500,000 .....	\$250,000
\$50,000	to \$100,000 .....	\$3,000		\$7,500,000	to	\$10,000,000 .....	\$400,000
\$100,000	to \$150,000 .....	\$5,000		\$10,000,000	to	\$15,000,000 .....	\$500,000
\$150,000	to \$250,000 .....	\$7,500		\$15,000,000	to	\$20,000,000 .....	\$600,000
\$250,000	to \$500,000 .....	\$12,500		\$20,000,000	to	\$25,000,000 .....	\$700,000
\$500,000	to \$1,000,000 .....	\$25,000		\$25,000,000	to	\$30,000,000 .....	\$800,000
\$1,000,000	to \$1,500,000 .....	\$50,000		\$30,000,000	to	\$35,000,000 .....	\$900,000
\$1,500,000	to \$2,000,000 .....	\$75,000		over		\$35,000,000 .....	\$1,000,000

Bank cashier's checks or properly certified checks accompanying proposals shall be made payable to the Treasurer, State of Illinois, when the state is awarding authority; the county treasurer, when a county is the awarding authority; or the city, village, or town treasurer, when a city, village, or town is the awarding authority.

If a combination bid is submitted, the proposal guaranties which accompany the individual proposals making up the combination will be considered as also covering the combination bid.

The amount of the proposal guaranty check is \_\_\_\_\_ \$( \_\_\_\_\_ ). If this proposal is accepted and the undersigned shall fail to execute a contract bond as required herein, it is hereby agreed that the amount of the proposal guaranty shall become the property of the State of Illinois, and shall be considered as payment of damages due to delay and other causes suffered by the State because of the failure to execute said contract and contract bond; otherwise, the bid bond shall become void or the proposal guaranty check shall be returned to the undersigned.

**Attach Cashier's Check or Certified Check Here**

In the event that one proposal guaranty check is intended to cover two or more proposals, the amount must be equal to the sum of the proposal guaranties which would be required for each individual proposal. If the guaranty check is placed in another proposal, state below where it may be found.

The proposal guaranty check will be found in the proposal for:

Item \_\_\_\_\_

Section No. \_\_\_\_\_

County \_\_\_\_\_

**Mark the proposal cover sheet as to the type of proposal guaranty submitted.**

BD 354 (Rev. 11/2001)

**RETURN WITH BID**

6. **COMBINATION BIDS.** The undersigned further agrees that if awarded the contract for the sections contained in the following combination, he/she will perform the work in accordance with the requirements of each individual proposal comprising the combination bid specified in the schedule below, and that the combination bid shall be prorated against each section in proportion to the bid submitted for the same. If an error is found to exist in the gross sum bid for one or more of the individual sections included in a combination, the combination bid shall be corrected as provided in the specifications.

**When a combination bid is submitted, the schedule below must be completed in each proposal comprising the combination.**

**If alternate bids are submitted for one or more of the sections comprising the combination, a combination bid must be submitted for each alternate.**

**Schedule of Combination Bids**

Combination No.	Sections Included in Combination	Combination Bid	
		Dollars	Cents

7. **SCHEDULE OF PRICES.** The undersigned bidder submits herewith, in accordance with the rules and instructions, a schedule of prices for the items of work for which bids are sought. The unit prices bid are in U.S. dollars and cents, and all extensions and summations have been made. The bidder understands that the quantities appearing in the bid schedule are approximate and are provided for the purpose of obtaining a gross sum for the comparison of bids. If there is an error in the extension of the unit prices, the unit prices shall govern. Payment to the contractor awarded the contract will be made only for actual quantities of work performed and accepted or materials furnished according to the contract. The scheduled quantities of work to be done and materials to be furnished may be increased, decreased or omitted as provided elsewhere in the contract.
8. **CERTIFICATE OF AUTHORITY.** The undersigned bidder, if a business organized under the laws of another State, assures the Department that it will furnish a copy of its certificate of authority to do business in the State of Illinois with the return of the executed contract and bond. Failure to furnish the certificate within the time provided for execution of an awarded contract may be cause for cancellation of the award and forfeiture of the proposal guaranty to the State.

ILLINOIS DEPARTMENT OF TRANSPORTATION  
 SCHEDULE OF PRICES  
 CONTRACT  
 NUMBER -

76A80

State Job # - C-98-057-07  
 PPS NBR - 8-82600-0000  
 County Name - MARION - -  
 Code - 121 - -  
 District - 8 - -  
 Section Number - (16,16NRM-Z,16Z)RS-5

Project Number  
 F-0327/039/

Route  
 FAP 327

Item Number	Pay Item Description	Unit of Measure	Quantity	x	Unit Price	=	Total Price
X4421000	PARTIAL DEPTH PATCH	TON	238.000				
X4422030	PARTIAL DEPTH REM 3	SQ YD	1,418.000				
Z0076600	TRAINEES	HOUR	500.000				
40600200	BIT MATLS PR CT	TON	22.400				
40600300	AGG PR CT	TON	118.100				
40600645	LEV BIND MM N90	TON	2,630.000				
40600895	CONSTRUC TEST STRIP	EACH	1.000				
40600990	TEMPORARY RAMP	SQ YD	66.000				
40603545	P HMA SC "D" N90	TON	5,009.000				
44000158	HMA SURF REM 2 1/4	SQ YD	51,517.000				
44000500	COMB CURB GUTTER REM	FOOT	135.000				
44002020	CONC MEDIAN SURF REM	SQ FT	1,909.000				
44200140	PAVT PATCH T1 12	SQ YD	56.000				
44200144	PAVT PATCH T2 12	SQ YD	745.000				
44200148	PAVT PATCH T3 12	SQ YD	112.000				



ILLINOIS DEPARTMENT OF TRANSPORTATION  
 SCHEDULE OF PRICES  
 CONTRACT  
 NUMBER - 76A80

State Job # - C-98-057-07  
 PPS NBR - 8-82600-0000  
 County Name - MARION - -  
 Code - 121 - -  
 District - 8 - -  
 Section Number - (16,16NRM-Z,16Z)RS-5

Project Number  
 F-0327/039/

Route  
 FAP 327

Item Number	Pay Item Description	Unit of Measure	Quantity	x	Unit Price	=	Total Price
44200150	PAVT PATCH T4 12	SQ YD	140.000				
44300200	STRIP REF CR CON TR	FOOT	1,399.000				
48203100	HMA SHOULDERS	TON	392.000				
60618300	CONC MEDIAN SURF 4	SQ FT	1,909.000				
63301210	REM RE-E SPBGR TY A	FOOT	420.000				
67000400	ENGR FIELD OFFICE A	CAL MO	4.000				
67100100	MOBILIZATION	L SUM	1.000				
70100310	TRAF CONT-PROT 701421	L SUM	1.000				
70100420	TRAF CONT-PROT 701411	EACH	4.000				
70102620	TR CONT & PROT 701501	L SUM	1.000				
70102622	TR CONT & PROT 701502	L SUM	1.000				
70102632	TR CONT & PROT 701602	L SUM	1.000				
70102635	TR CONT & PROT 701701	L SUM	1.000				
70300100	SHORT-TERM PAVT MKING	FOOT	5,403.000				
70300220	TEMP PVT MK LINE 4	FOOT	59,525.000				

ILLINOIS DEPARTMENT OF TRANSPORTATION  
 SCHEDULE OF PRICES  
 CONTRACT  
 NUMBER - 76A80

State Job # - C-98-057-07  
 PPS NBR - 8-82600-0000  
 County Name - MARION - -  
 Code - 121 - -  
 District - 8 - -  
 Section Number - (16,16NRM-Z,16Z)RS-5

Project Number  
 F-0327/039/

Route  
 FAP 327

Item Number	Pay Item Description	Unit of Measure	Quantity	x	Unit Price	=	Total Price
70301000	WORK ZONE PAVT MK REM	SQ FT	1,927.000				
78000100	THPL PVT MK LTR & SYM	SQ FT	1,949.000				
78000200	THPL PVT MK LINE 4	FOOT	29,762.000				
78000600	THPL PVT MK LINE 12	FOOT	1,247.000				
78000650	THPL PVT MK LINE 24	FOOT	434.000				
78100100	RAISED REFL PAVT MKR	EACH	425.000				
78300200	RAISED REF PVT MK REM	EACH	176.000				
88600600	DET LOOP REPL	FOOT	2,954.000				

**CONTRACT NUMBER**

**76A80**

**THIS IS THE TOTAL BID**

**\$ \_\_\_\_\_**

**NOTES:**

1. Each PAY ITEM should have a UNIT PRICE and a TOTAL PRICE.
2. The UNIT PRICE shall govern if no TOTAL PRICE is shown or if there is a discrepancy between the product of the UNIT PRICE multiplied by the QUANTITY.
3. If a UNIT PRICE is omitted, the TOTAL PRICE will be divided by the QUANTITY in order to establish a UNIT PRICE.
4. A bid may be declared UNACCEPTABLE if neither a unit price nor a total price is shown.

## RETURN WITH BID

### STATE REQUIRED ETHICAL STANDARDS GOVERNING CONTRACT PROCUREMENT: ASSURANCES, CERTIFICATIONS AND DISCLOSURES

#### I. GENERAL

A. Article 50 of the Illinois Procurement Code establishes the duty of all State chief procurement officers, State purchasing officers, and their designees to maximize the value of the expenditure of public moneys in procuring goods, services, and contracts for the State of Illinois and to act in a manner that maintains the integrity and public trust of State government. In discharging this duty, they are charged by law to use all available information, reasonable efforts, and reasonable actions to protect, safeguard, and maintain the procurement process of the State of Illinois.

B. In order to comply with the provisions of Article 50 and to carry out the duty established therein, all bidders are to adhere to ethical standards established for the procurement process, and to make such assurances, disclosures and certifications required by law. By execution of the Proposal Signature Sheet, the bidder indicates that each of the mandated assurances has been read and understood, that each certification is made and understood, and that each disclosure requirement has been understood and completed.

C. In addition to all other remedies provided by law, failure to comply with any assurance, failure to make any disclosure or the making of a false certification shall be grounds for termination of the contract and the suspension or debarment of the bidder.

#### II. ASSURANCES

A. The assurances hereinafter made by the bidder are each a material representation of fact upon which reliance is placed should the Department enter into the contract with the bidder. The Department may terminate the contract if it is later determined that the bidder rendered a false or erroneous assurance, and the surety providing the performance bond shall be responsible for the completion of the contract.

##### B. Felons

1. The Illinois Procurement Code provides:

Section 50-10. Felons. Unless otherwise provided, no person or business convicted of a felony shall do business with the State of Illinois or any state agency from the date of conviction until 5 years after the date of completion of the sentence for that felony, unless no person held responsible by a prosecutorial office for the facts upon which the conviction was based continues to have any involvement with the business.

2. The bidder assures the Department that the award and execution of the contract would not cause a violation of Section 50-10.

##### C. Conflicts of Interest

1. The Illinois Procurement Code provides in pertinent part:

Section 50-13. Conflicts of Interest.

(a) Prohibition. It is unlawful for any person holding an elective office in this State, holding a seat in the General Assembly, or appointed to or employed in any of the offices or agencies of state government and who receives compensation for such employment in excess of 60% of the salary of the Governor of the State of Illinois, or who is an officer or employee of the Capital Development Board or the Illinois Toll Highway Authority, or who is the spouse or minor child of any such person to have or acquire any contract, or any direct pecuniary interest in any contract therein, whether for stationery, printing, paper, or any services, materials, or supplies, that will be wholly or partially satisfied by the payment of funds appropriated by the General Assembly of the State of Illinois or in any contract of the Capital Development Board or the Illinois Toll Highway authority.

(b) Interests. It is unlawful for any firm, partnership, association or corporation, in which any person listed in subsection (a) is entitled to receive (i) more than 7 1/2% of the total distributable income or (ii) an amount in excess of the salary of the Governor, to have or acquire any such contract or direct pecuniary interest therein.

(c) Combined interests. It is unlawful for any firm, partnership, association, or corporation, in which any person listed in subsection (a) together with his or her spouse or minor children is entitled to receive (i) more than 15%, in the aggregate, of the total distributable income or (ii) an amount in excess of 2 times the salary of the Governor, to have or acquire any such contract or direct pecuniary interest therein.

(d) Securities. Nothing in this Section invalidates the provisions of any bond or other security previously offered or to be offered for sale or sold by or for the State of Illinois.

(e) Prior interests. This Section does not affect the validity of any contract made between the State and an officer or employee of the State or member of the General Assembly, his or her spouse, minor child or any combination of those persons if that contract was in existence before his or her election or employment as an officer, member, or employee. The contract is voidable, however, if it cannot be completed within 365 days after the officer, member, or employee takes office or is employed.

The current salary of the Governor is \$150,700.00. Sixty percent of the salary is \$90,420.00.

## RETURN WITH BID

2. The bidder assures the Department that the award and execution of the contract would not cause a violation of Section 50-13, or that an effective exemption has been issued by the Board of Ethics to any individual subject to the Section 50-13 prohibitions pursuant to the provisions of Section 50-20 of the Code and Executive Order Number 3 (1998). Information concerning the exemption process is available from the Department upon request.

### **D. Negotiations**

1. The Illinois Procurement Code provides in pertinent part:

Section 50-15. Negotiations.

(a) It is unlawful for any person employed in or on a continual contractual relationship with any of the offices or agencies of State government to participate in contract negotiations on behalf of that office or agency with any firm, partnership, association, or corporation with whom that person has a contract for future employment or is negotiating concerning possible future employment.

2. The bidder assures the Department that the award and execution of the contract would not cause a violation of Section 50-15, and that the bidder has no knowledge of any facts relevant to the kinds of acts prohibited therein.

### **E. Inducements**

1. The Illinois Procurement Code provides:

Section 50-25. Inducement. Any person who offers or pays any money or other valuable thing to any person to induce him or her not to bid for a State contract or as recompense for not having bid on a State contract is guilty of a Class 4 felony. Any person who accepts any money or other valuable thing for not bidding for a State contract or who withholds a bid in consideration of the promise for the payment of money or other valuable thing is guilty of a Class 4 felony.

2. The bidder assures the Department that the award and execution of the contract would not cause a violation of Section 50-25, and that the bidder has no knowledge of any facts relevant to the kinds of acts prohibited therein.

### **F. Revolving Door Prohibition**

1. The Illinois Procurement Code provides:

Section 50-30. Revolving door prohibition. Chief procurement officers, associate procurement officers, State purchasing officers, their designees whose principal duties are directly related to State procurement, and executive officers confirmed by the Senate are expressly prohibited for a period of 2 years after terminating an affected position from engaging in any procurement activity relating to the State agency most recently employing them in an affected position for a period of at least 6 months. The prohibition includes, but is not limited to: lobbying the procurement process; specifying; bidding; proposing bid, proposal, or contract documents; on their own behalf or on behalf of any firm, partnership, association, or corporation. This Section applies only to persons who terminate an affected position on or after January 15, 1999.

2. The bidder assures the Department that the award and execution of the contract would not cause a violation of Section 50-30, and that the bidder has no knowledge of any facts relevant to the kinds of acts prohibited therein.

### **G. Reporting Anticompetitive Practices**

1. The Illinois Procurement Code provides:

Section 50-40. Reporting anticompetitive practices. When, for any reason, any vendor, bidder, contractor, chief procurement officer, State purchasing officer, designee, elected official, or State employee suspects collusion or other anticompetitive practice among any bidders, offerors, contractors, proposers, or employees of the State, a notice of the relevant facts shall be transmitted to the Attorney General and the chief procurement officer.

2. The bidder assures the Department that it has not failed to report any relevant facts concerning the practices addressed in Section 50-40 which may involve the contract for which the bid is submitted.

### **H. Confidentiality**

1. The Illinois Procurement Code provides:

Section 50-45. Confidentiality. Any chief procurement officer, State purchasing officer, designee, or executive officer who willfully uses or allows the use of specifications, competitive bid documents, proprietary competitive information, proposals, contracts, or selection information to compromise the fairness or integrity of the procurement, bidding, or contract process shall be subject to immediate dismissal, regardless of the Personnel code, any contract, or any collective bargaining agreement, and may in addition be subject to criminal prosecution.

2. The bidder assures the Department that it has no knowledge of any fact relevant to the practices addressed in Section 50-45 which may involve the contract for which the bid is submitted.

## RETURN WITH BID

### **I. Insider Information**

1. The Illinois Procurement Act provides:

Section 50-50. Insider information. It is unlawful for any current or former elected or appointed State official or State employee to knowingly use confidential information available only by virtue of that office or employment for actual or anticipated gain for themselves or another person.

2. The bidder assures the Department that it has no knowledge of any facts relevant to the practices addressed in Section 50-50 which may involve the contract for which the bid is submitted.

### **III. CERTIFICATIONS**

**A.** The certifications hereinafter made by the bidder are each a material representation of fact upon which reliance is placed should the Department enter into the contract with the bidder. The Department may terminate the contract if it is later determined that the bidder rendered a false or erroneous certification, and the surety providing the performance bond shall be responsible for completion of the contract.

#### **B. Bribery**

1. The Illinois Procurement Code provides:

Section 50-5. Bribery.

(a) Prohibition. No person or business shall be awarded a contract or subcontract under this Code who:

(1) has been convicted under the laws of Illinois or any other state of bribery or attempting to bribe an officer or employee of the State of Illinois or any other state in that officer's or employee's official capacity; or

(2) has made an admission of guilt of that conduct that is a matter of record but has not been prosecuted for that conduct.

(b) Businesses. No business shall be barred from contracting with any unit of State or local government as a result of a conviction under this Section of any employee or agent of the business if the employee or agent is no longer employed by the business and:

(1) the business has been finally adjudicated not guilty; or

(2) the business demonstrates to the governmental entity with which it seeks to contract, and that entity finds that the commission of the offense was not authorized, requested, commanded, or performed by a director, officer, or high managerial agent on behalf of the business as provided in paragraph (2) of subsection (a) of Section 5-4 of the Criminal Code of 1961.

(c) Conduct on behalf of business. For purposes of this Section, when an official, agent, or employee of a business committed the bribery or attempted bribery on behalf of the business and in accordance with the direction or authorization of a responsible official of the business, the business shall be chargeable with the conduct.

(d) Certification. Every bid submitted to and contract executed by the State shall contain a certification by the contractor that the contractor is not barred from being awarded a contract or subcontract under this Section. A contractor who makes a false statement, material to the certification, commits a Class 3 felony.

2. The bidder certifies that it is not barred from being awarded a contract under Section 50.5.

#### **C. Educational Loan**

1. Section 3 of the Educational Loan Default Act provides:

§ 3. No State agency shall contract with an individual for goods or services if that individual is in default, as defined in Section 2 of this Act, on an educational loan. Any contract used by any State agency shall include a statement certifying that the individual is not in default on an educational loan as provided in this Section.

2. The bidder, if an individual as opposed to a corporation, partnership or other form of business organization, certifies that the bidder is not in default on an educational loan as provided in Section 3 of the Act.

#### **D. Bid-Rigging/Bid Rotating**

1. Section 33E-11 of the Criminal Code of 1961 provides:

§ 33E-11. (a) Every bid submitted to and public contract executed pursuant to such bid by the State or a unit of local government shall contain a certification by the prime contractor that the prime contractor is not barred from contracting with any unit of State or local government as a result of a violation of either Section 33E-3 or 33E-4 of this Article. The State and units of local government shall provide the appropriate forms for such certification.

## RETURN WITH BID

(b) A contractor who makes a false statement, material to the certification, commits a Class 3 felony.

A violation of Section 33E-3 would be represented by a conviction of the crime of bid-rigging which, in addition to Class 3 felony sentencing, provides that any person convicted of this offense or any similar offense of any state or the United States which contains the same elements as this offense shall be barred for 5 years from the date of conviction from contracting with any unit of State or local government. No corporation shall be barred from contracting with any unit of State or local government as a result of a conviction under this Section of any employee or agent of such corporation if the employee so convicted is no longer employed by the corporation and: (1) it has been finally adjudicated not guilty or (2) if it demonstrates to the governmental entity with which it seeks to contract and that entity finds that the commission of the offense was neither authorized, requested, commanded, nor performed by a director, officer or a high managerial agent in behalf of the corporation.

A violation of Section 33E-4 would be represented by a conviction of the crime of bid-rotating which, in addition to Class 2 felony sentencing, provides that any person convicted of this offense or any similar offense of any state or the United States which contains the same elements as this offense shall be permanently barred from contracting with any unit of State or local government. No corporation shall be barred from contracting with any unit of State or local government as a result of a conviction under this Section of any employee or agent of such corporation if the employee so convicted is no longer employed by the corporation and: (1) it has been finally adjudicated not guilty or (2) if it demonstrates to the governmental entity with which it seeks to contract and that entity finds that the commission of the offense was neither authorized, requested, commanded, nor performed by a director, officer or a high managerial agent in behalf of the corporation.

2. The bidder certifies that it is not barred from contracting with the Department by reason of a violation of either Section 33E-3 or Section 33E-4.

### **E. International Anti-Boycott**

1. Section 5 of the International Anti-Boycott Certification Act provides:

§ 5. State contracts. Every contract entered into by the State of Illinois for the manufacture, furnishing, or purchasing of supplies, material, or equipment or for the furnishing of work, labor, or services, in an amount exceeding the threshold for small purchases according to the purchasing laws of this State or \$10,000.00, whichever is less, shall contain certification, as a material condition of the contract, by which the contractor agrees that neither the contractor nor any substantially-owned affiliated company is participating or shall participate in an international boycott in violation of the provisions of the U.S. Export Administration Act of 1979 or the regulations of the U.S. Department of Commerce promulgated under that Act.

2. The bidder makes the certification set forth in Section 5 of the Act.

### **F. Drug Free Workplace**

1. The Illinois "Drug Free Workplace Act" applies to this contract and it is necessary to comply with the provisions of the "Act" if the contractor is a corporation, partnership, or other entity (including a sole proprietorship) which has 25 or more employees.

2. The bidder certifies that if awarded a contract in excess of \$5,000 it will provide a drug free workplace by:

(a) Publishing a statement notifying employees that the unlawful manufacture, distribution, dispensation, possession or use of a controlled substance, including cannabis, is prohibited in the contractor's workplace; specifying the actions that will be taken against employees for violations of such prohibition; and notifying the employee that, as a condition of employment on such contract, the employee shall abide by the terms of the statement, and notify the employer of any criminal drug statute conviction for a violation occurring in the workplace no later than five (5) days after such conviction.

(b) Establishing a drug free awareness program to inform employees about the dangers of drug abuse in the workplace; the contractor's policy of maintaining a drug free workplace; any available drug counseling, rehabilitation, and employee assistance programs; and the penalties that may be imposed upon employees for drug violations.

(c) Providing a copy of the statement required by subparagraph (1) to each employee engaged in the performance of the contract and to post the statement in a prominent place in the workplace.

(d) Notifying the Department within ten (10) days after receiving notice from an employee or otherwise receiving actual notice of the conviction of an employee for a violation of any criminal drug statute occurring in the workplace.

(e) Imposing or requiring, within 30 days after receiving notice from an employee of a conviction or actual notice of such a conviction, an appropriate personnel action, up to and including termination, or the satisfactory participation in a drug abuse assistance or rehabilitation program approved by a federal, state or local health, law enforcement or other appropriate agency.

(f) Assisting employees in selecting a course of action in the event drug counseling, treatment, and rehabilitation is required and indicating that a trained referral team is in place.

(g) Making a good faith effort to continue to maintain a drug free workplace through implementation of the actions and efforts stated in this certification.

**G. Debt Delinquency**

1. The Illinois Procurement Code provides:

Section 50-11 and 50-12. Debt Delinquency.

The contractor or bidder certifies that it, or any affiliate, is not barred from being awarded a contract under 30 ILCS 500. Section 50-11 prohibits a person from entering into a contract with a State agency if it knows or should know that it, or any affiliate, is delinquent in the payment of any debt to the State as defined by the Debt Collection Board. Section 50-12 prohibits a person from entering into a contract with a State agency if it, or any affiliate, has failed to collect and remit Illinois Use Tax on all sales of tangible personal property into the State of Illinois in accordance with the provisions of the Illinois Use Tax Act. The contractor further acknowledges that the contracting State agency may declare the contract void if this certification is false or if the contractor, or any affiliate, is determined to be delinquent in the payment of any debt to the State during the term of the contract.

**H. Sarbanes-Oxley Act of 2002**

1. The Illinois Procurement Code provides:

Section 50-60(c).

The contractor certifies in accordance with 30 ILCS 500/50-10.5 that no officer, director, partner or other managerial agent of the contracting business has been convicted of a felony under the Sarbanes-Oxley Act of 2002 or a Class 3 or Class 2 felony under the Illinois Securities Law of 1953 for a period of five years prior to the date of the bid or contract. The contractor acknowledges that the contracting agency shall declare the contract void if this certification is false.

**I. Addenda**

The contractor or bidder certifies that all relevant addenda have been incorporated in to this contract. Failure to do so may cause the bid to be declared unacceptable.

**J. Section 42 of the Environmental Protection Act**

The contractor certifies in accordance with 30 ILCS 500/50-12 that the bidder or contractor is not barred from being awarded a contract under this Section which prohibits the bidding on or entering into contracts with the State of Illinois or a State agency by a person or business found by a court or the Pollution Control Board to have committed a willful or knowing violation of Section 42 of the Environmental Protection Act for a period of five years from the date of the order. The contractor acknowledges that the contracting agency may declare the contract void if this certification is false.

**K. Apprenticeship and Training Certification (Does not apply to federal aid projects)**

In accordance with the provisions of Section 30-22 (6) of the Illinois Procurement Code, the bidder certifies that it is a participant, either as an individual or as part of a group program, in the approved apprenticeship and training programs applicable to each type of work or craft that the bidder will perform with its own forces. The bidder further certifies for work that will be performed by subcontract that each of its subcontractors submitted for approval either (a) is, at the time of such bid, participating in an approved, applicable apprenticeship and training program; or (b) will, prior to commencement of performance of work pursuant to this contract, begin participation in an approved apprenticeship and training program applicable to the work of the subcontract. The Department, at any time before or after award, may require the production of a copy of each applicable Certificate of Registration issued by the United States Department of Labor evidencing such participation by the contractor and any or all of its subcontractors. Applicable apprenticeship and training programs are those that have been approved and registered with the United States Department of Labor. The bidder shall list in the space below, the official name of the program sponsor holding the Certificate of Registration for all of the types of work or crafts in which the bidder is a participant and that will be performed with the bidder's forces. Types of work or craft work that will be subcontracted shall be included and listed as subcontract work. The list shall also indicate any type of work or craft job category that does not have an applicable apprenticeship or training program. **The bidder is responsible for making a complete report and shall make certain that each type of work or craft job category that will be utilized on the project as reported on the Construction Employee Workforce Projection (Form BC-1256) and returned with the bid is accounted for and listed.**

**NA - FEDERAL**

---

---

---

The requirements of this certification and disclosure are a material part of the contract, and the contractor shall require this certification provision to be included in all approved subcontracts. In order to fulfill this requirement, it shall not be necessary that an applicable program sponsor be currently taking or that it will take applications for apprenticeship, training or employment during the performance of the work of this contract.

**L. Executive Order Number 1 (2007) Regarding Lobbying on Government Procurements**

The bidder hereby warrants and certifies that they have complied and will comply with the requirements set forth in this Order. The requirements of this warrant and certification are a material part of the contract, and the contractor shall require this warrant and certification provision to be included in all approved subcontracts.



**TO BE RETURNED WITH BID**

**IV. DISCLOSURES**

**A.** The disclosures hereinafter made by the bidder are each a material representation of fact upon which reliance is placed should the Department enter into the contract with the bidder. The Department may terminate the contract if it is later determined that the bidder rendered a false or erroneous disclosure, and the surety providing the performance bond shall be responsible for completion of the contract.

**B. Financial Interests and Conflicts of Interest**

1. Section 50-35 of the Illinois Procurement Code provides that all bids of more than \$10,000 shall be accompanied by disclosure of the financial interests of the bidder. This disclosed information for the successful bidder, will be maintained as public information subject to release by request pursuant to the Freedom of Information Act.

The financial interests to be disclosed shall include ownership or distributive income share that is in excess of 5%, or an amount greater than 60% of the annual salary of the Governor, of the bidding entity or its parent entity, whichever is less, unless the contractor or bidder is a publicly traded entity subject to Federal 10K reporting, in which case it may submit its 10K disclosure in place of the prescribed disclosure. If a bidder is a privately held entity that is exempt from Federal 10K reporting, but has more than 400 shareholders, it may submit the information that Federal 10K companies are required to report, and list the names of any person or entity holding any ownership share that is in excess of 5%. The disclosure shall include the names, addresses, and dollar or proportionate share of ownership of each person making the disclosure, their instrument of ownership or beneficial relationship, and notice of any potential conflict of interest resulting from the current ownership or beneficial interest of each person making the disclosure having any of the relationships identified in Section 50-35 and on the disclosure form.

In addition, all disclosures shall indicate any other current or pending contracts, proposals, leases, or other ongoing procurement relationships the bidding entity has with any other unit of state government and shall clearly identify the unit and the contract, proposal, lease, or other relationship.

2. Disclosure Forms. Disclosure Form A is attached for use concerning the individuals meeting the above ownership or distributive share requirements. Subject individuals should be covered each by one form. In addition, a second form (Disclosure Form B) provides for the disclosure of current or pending procurement relationships with other (non-IDOT) state agencies. **The forms must be included with each bid or incorporated by reference.**

**C. Disclosure Form Instructions**

**Form A: For bidders that have previously submitted the information requested in Form A**

The Department has retained the Form A disclosures submitted by all bidders responding to these requirements for the April 24, 1998 or any subsequent letting conducted by the Department. The bidder has the option of submitting the information again or the bidder may sign the following certification statement indicating that the information previously submitted by the bidder is, as of the date of signature, current and accurate. The Certification must be signed and dated by a person who is authorized to execute contracts for the bidding company. Before signing this certification, the bidder should carefully review its prior submissions to ensure the Certification is correct. If the Bidder signs the Certification, the Bidder should proceed to Form B instructions.

**CERTIFICATION STATEMENT**

**I have determined that the Form A disclosure information previously submitted is current and accurate, and all forms are hereby incorporated by reference in this bid. Any necessary additional forms or amendments to previously submitted forms are attached to this bid.**

\_\_\_\_\_  
(Bidding Company)

\_\_\_\_\_  
Name of Authorized Representative (type or print)

\_\_\_\_\_  
Title of Authorized Representative (type or print)

\_\_\_\_\_  
Signature of Authorized Representative

\_\_\_\_\_  
Date

**Form A: For bidders who have NOT previously submitted the information requested in Form A**

If the bidder is a publicly traded entity subject to Federal 10K reporting, the 10K Report may be submitted to meet the requirements of Form A. If a bidder is a privately held entity that is exempt from Federal 10K reporting, but has more than 400 shareholders, it may submit the information that Federal 10K companies are required to report, and list the names of any person or entity holding any ownership share that is in excess of 5%. If a bidder is not subject to Federal 10K reporting, the bidder must determine if any individuals are required by law to complete a financial disclosure form. To do this, the bidder should answer each of the following questions. A "YES" answer indicates Form A must be completed. If the answer to each of the following questions is "NO", then the NOT APPLICABLE STATEMENT on the second page of Form A must be signed and dated by a person that is authorized to execute contracts for the bidding company. Note: These questions are for assistance only and are not required to be completed.

1. Does anyone in your organization have a direct or beneficial ownership share of greater than 5% of the bidding entity or parent entity? YES \_\_\_ NO \_\_\_
2. Does anyone in your organization have a direct or beneficial ownership share of less than 5%, but which has a value greater than \$90,420.00? YES \_\_\_ NO \_\_\_
3. Does anyone in your organization receive more than \$90,420.00 of the bidding entity's or parent entity's distributive income? (Note: Distributive income is, for these purposes, any type of distribution of profits. An annual salary is not distributive income.) YES \_\_\_ NO \_\_\_
4. Does anyone in your organization receive greater than 5% of the bidding entity's or parent entity's total distributive income, but which is less than \$90,420.00? YES \_\_\_ NO \_\_\_  
(Note: Only one set of forms needs to be completed per person per bid even if a specific individual would require a yes answer to more than one question.)

A "YES" answer to any of these questions requires the completion of Form A. The bidder must determine each individual in the bidding entity or the bidding entity's parent company that would cause the questions to be answered "Yes". Each form must be signed and dated by a person that is authorized to execute contracts for your organization. **Photocopied or stamped signatures are not acceptable.** The person signing can be, but does not have to be, the person for which the form is being completed. The bidder is responsible for the accuracy of any information provided.

If the answer to each of the above questions is "NO", then the NOT APPLICABLE STATEMENT on page 2 of Form A must be signed and dated by a person that is authorized to execute contracts for your company.

**Form B: Identifying Other Contracts & Procurement Related Information** Disclosure Form B must be completed for each bid submitted by the bidding entity. It must be signed by an individual who is authorized to execute contracts for the bidding entity. *Note: Signing the NOT APPLICABLE STATEMENT on Form A does not allow the bidder to ignore Form B. Form B must be completed, signed and dated or the bidder may be considered nonresponsive and the bid will not be accepted.*

The Bidder shall identify, by checking Yes or No on Form B, whether it has any pending contracts (including leases), bids, proposals, or other ongoing procurement relationship with any other (non-IDOT) State of Illinois agency. If "No" is checked, the bidder only needs to complete the signature box on the bottom of Form B. If "Yes" is checked, the bidder must do one of the following:

Option I: If the bidder did not submit an Affidavit of Availability to obtain authorization to bid, the bidder must list all non-IDOT State of Illinois agency pending contracts, leases, bids, proposals, and other ongoing procurement relationships. These items may be listed on Form B or on an attached sheet(s). Do not include IDOT contracts. Contracts with cities, counties, villages, etc. are not considered State of Illinois agency contracts and are not to be included. Contracts with other State of Illinois agencies such as the Department of Natural Resources or the Capital Development Board must be included. Bidders who submit Affidavits of Availability are suggested to use Option II.

Option II: If the bidder is required and has submitted an Affidavit of Availability in order to obtain authorization to bid, the bidder may write or type "See Affidavit of Availability" which indicates that the Affidavit of Availability is incorporated by reference and includes all non-IDOT State of Illinois agency pending contracts, leases, bids, proposals, and other ongoing procurement relationships. For any contracts that are not covered by the Affidavit of Availability, the bidder must identify them on Form B or on an attached sheet(s). These might be such things as leases.

**D. Bidders Submitting More Than One Bid**

Bidders submitting multiple bids may submit one set of forms consisting of all required Form A disclosures and one Form B for use with all bids. Please indicate in the space provided below the bid item that contains the original disclosure forms and the bid items which incorporate the forms by reference.

- The bid submitted for letting item \_\_\_\_\_ contains the Form A disclosures or Certification Statement and the Form B disclosures. The following letting items incorporate the said forms by reference:

---



---

RETURN WITH BID/OFFER

ILLINOIS DEPARTMENT OF TRANSPORTATION

Form A Financial Information & Potential Conflicts of Interest Disclosure

Contractor Name
Legal Address
City, State, Zip
Telephone Number Email Address Fax Number (if available)

Disclosure of the information contained in this Form is required by the Section 50-35 of the Illinois Procurement Code (30 ILCS 500). Vendors desiring to enter into a contract with the State of Illinois must disclose the financial information and potential conflict of interest information as specified in this Disclosure Form. This information shall become part of the publicly available contract file. This Form A must be completed for bids in excess of \$10,000, and for all open-ended contracts. A publicly traded company may submit a 10K disclosure (or equivalent if applicable) in satisfaction of the requirements set forth in Form A. See Disclosure Form Instructions.

DISCLOSURE OF FINANCIAL INFORMATION

1. Disclosure of Financial Information. The individual named below has an interest in the BIDDER (or its parent) in terms of ownership or distributive income share in excess of 5%, or an interest which has a value of more than \$90,420.00 (60% of the Governor's salary as of 7/1/01). (Make copies of this form as necessary and attach a separate Disclosure Form A for each individual meeting these requirements)

FOR INDIVIDUAL (type or print information)

NAME:

ADDRESS

Type of ownership/distributable income share:

stock sole proprietorship Partnership other: (explain on separate sheet):
% or \$ value of ownership/distributable income share:

2. Disclosure of Potential Conflicts of Interest. Check "Yes" or "No" to indicate which, if any, of the following potential conflict of interest relationships apply. If the answer to any question is "Yes", please attach additional pages and describe.

(a) State employment, currently or in the previous 3 years, including contractual employment of services.

Yes \_\_\_ No \_\_\_

If your answer is yes, please answer each of the following questions.

- 1. Are you currently an officer or employee of either the Capitol Development Board or the Illinois Toll Highway Authority? Yes \_\_\_ No \_\_\_
2. Are you currently appointed to or employed by any agency of the State of Illinois? If you are currently appointed to or employed by any agency of the State of Illinois, and your annual salary exceeds \$90,420.00, (60% of the Governor's salary as of 7/1/01) provide the name the State agency for which you are employed and your annual salary.

## RETURN WITH BID/OFFER

3. If you are currently appointed to or employed by any agency of the State of Illinois, and your annual salary exceeds \$90,420.00, (60% of the Governor's salary as of 7/1/01) are you entitled to receive (i) more than 7 1/2% of the total distributable income of your firm, partnership, association or corporation, or (ii) an amount in excess of the salary of the Governor? Yes \_\_\_ No \_\_\_
4. If you are currently appointed to or employed by any agency of the State of Illinois, and your annual salary exceeds \$90,420.00, (60% of the Governor's salary as of 7/1/01) are you and your spouse or minor children entitled to receive (i) more than 15% in aggregate of the total distributable income of your firm, partnership, association or corporation, or (ii) an amount in excess of 2 times the salary of the Governor? Yes \_\_\_ No \_\_\_

---

(b) State employment of spouse, father, mother, son, or daughter, including contractual employment for services in the previous 2 years.

Yes \_\_\_ No \_\_\_

If your answer is yes, please answer each of the following questions.

1. Is your spouse or any minor children currently an officer or employee of the Capitol Development Board or the Illinois Toll Highway Authority? Yes \_\_\_ No \_\_\_
2. Is your spouse or any minor children currently appointed to or employed by any agency of the State of Illinois? If your spouse or minor children is/are currently appointed to or employed by any agency of the State of Illinois, and his/her annual salary exceeds \$90,420.00, (60% of the Governor's salary as of 7/1/01) provide the name of the spouse and/or minor children, the name of the State agency for which he/she is employed and his/her annual salary. \_\_\_\_\_
- 
3. If your spouse or any minor children is/are currently appointed to or employed by any agency of the State of Illinois, and his/her annual salary exceeds \$90,420.00, (60% of the salary of the Governor as of 7/1/01) are you entitled to receive (i) more than 7 1/2% of the total distributable income of your firm, partnership, association or corporation, or (ii) an amount in excess of the salary of the Governor? Yes \_\_\_ No \_\_\_
4. If your spouse or any minor children are currently appointed to or employed by any agency of the State of Illinois, and his/her annual salary exceeds \$90,420.00, (60% of the Governor's salary as of 7/1/01) are you and your spouse or any minor children entitled to receive (i) more than 15% in the aggregate of the total distributable income from your firm, partnership, association or corporation, or (ii) an amount in excess of 2 times the salary of the Governor? Yes \_\_\_ No \_\_\_

---

(c) Elective status; the holding of elective office of the State of Illinois, the government of the United States, any unit of local government authorized by the Constitution of the State of Illinois or the statutes of the State of Illinois currently or in the previous 3 years. Yes \_\_\_ No \_\_\_

---

(d) Relationship to anyone holding elective office currently or in the previous 2 years; spouse, father, mother, son, or daughter. Yes \_\_\_ No \_\_\_

---

(e) Appointive office; the holding of any appointive government office of the State of Illinois, the United State of America, or any unit of local government authorized by the Constitution of the State of Illinois or the statutes of the State of Illinois, which office entitles the holder to compensation in excess of the expenses incurred in the discharge of that office currently or in the previous 3 years. Yes \_\_\_ No \_\_\_

---

(f) Relationship to anyone holding appointive office currently or in the previous 2 years; spouse, father, mother, son, or daughter. Yes \_\_\_ No \_\_\_

---

(g) Employment, currently or in the previous 3 years, as or by any registered lobbyist of the State government. Yes \_\_\_ No \_\_\_

---

**RETURN WITH BID/OFFER**

(h) Relationship to anyone who is or was a registered lobbyist in the previous 2 years; spouse, father, mother, son, or daughter. Yes \_\_\_ No \_\_\_

(i) Compensated employment, currently or in the previous 3 years, by any registered election or reelection committee registered with the Secretary of State or any county clerk of the State of Illinois, or any political action committee registered with either the Secretary of State or the Federal Board of Elections. Yes \_\_\_ No \_\_\_

(j) Relationship to anyone; spouse, father, mother, son, or daughter; who was a compensated employee in the last 2 years by any registered election or re-election committee registered with the Secretary of State or any county clerk of the State of Illinois, or any political action committee registered with either the Secretary of State or the Federal Board of Elections. Yes \_\_\_ No \_\_\_

**APPLICABLE STATEMENT**

**This Disclosure Form A is submitted on behalf of the INDIVIDUAL named on previous page.**

Completed by: \_\_\_\_\_  
Name of Authorized Representative (type or print)

Completed by: \_\_\_\_\_  
Title of Authorized Representative (type or print)

Completed by: \_\_\_\_\_ Date \_\_\_\_\_  
Signature of Individual or Authorized Representative

**NOT APPLICABLE STATEMENT**

**I have determined that no individuals associated with this organization meet the criteria that would require the completion of this Form A.**

**This Disclosure Form A is submitted on behalf of the CONTRACTOR listed on the previous page.**

\_\_\_\_\_  
Name of Authorized Representative (type or print)

\_\_\_\_\_  
Title of Authorized Representative (type or print)

\_\_\_\_\_  
Signature of Authorized Representative Date \_\_\_\_\_

RETURN WITH BID/OFFER

**ILLINOIS DEPARTMENT  
OF TRANSPORTATION**

**Form B  
Other Contracts &  
Procurement Related Information  
Disclosure**

Contractor Name		
Legal Address		
City, State, Zip		
Telephone Number	Email Address	Fax Number (if available)

Disclosure of the information contained in this Form is required by the Section 50-35 of the Illinois Procurement Act (30 ILCS 500). This information shall become part of the publicly available contract file. This Form B must be completed for bids in excess of \$10,000, and for all open-ended contracts.

**DISCLOSURE OF OTHER CONTRACTS AND PROCUREMENT RELATED INFORMATION**

**1. Identifying Other Contracts & Procurement Related Information.** The BIDDER shall identify whether it has any pending contracts (including leases), bids, proposals, or other ongoing procurement relationship with any other State of Illinois agency: Yes \_\_\_ No \_\_\_

If "No" is checked, the bidder only needs to complete the signature box on the bottom of this page.

**2. If "Yes" is checked.** Identify each such relationship by showing State of Illinois agency name and other descriptive information such as bid or project number (attach additional pages as necessary). SEE DISCLOSURE FORM INSTRUCTIONS:

**THE FOLLOWING STATEMENT MUST BE SIGNED**

_____	
Name of Authorized Representative (type or print)	
_____	
Title of Authorized Representative (type or print)	
_____	_____
Signature of Authorized Representative	Date

## **RETURN WITH BID**

### **SPECIAL NOTICE TO CONTRACTORS**

The following requirements of the Illinois Department of Human Rights' Rules and Regulations are applicable to bidders on all construction contracts advertised by the Illinois Department of Transportation:

#### **CONSTRUCTION EMPLOYEE UTILIZATION PROJECTION**

- (a) All bidders on construction contracts shall complete and submit, along with and as part of their bids, a Bidder's Employee Utilization Form (Form BC-1256) setting forth a projection and breakdown of the total workforce intended to be hired and/or allocated to such contract work by the bidder including a projection of minority and female employee utilization in all job classifications on the contract project.
- (b) The Department of Transportation shall review the Employee Utilization Form, and workforce projections contained therein, of the contract awardee to determine if such projections reflect an underutilization of minority persons and/or women in any job classification in accordance with the Equal Employment Opportunity Clause and Section 7.2 of the Illinois Department of Human Rights' Rules and Regulations for Public Contracts adopted as amended on September 17, 1980. If it is determined that the contract awardee's projections reflect an underutilization of minority persons and/or women in any job classification, it shall be advised in writing of the manner in which it is underutilizing and such awardee shall be considered to be in breach of the contract unless, prior to commencement of work on the contract project, it submits revised satisfactory projections or an acceptable written affirmative action plan to correct such underutilization including a specific timetable geared to the completion stages of the contract.
- (c) The Department of Transportation shall provide to the Department of Human Rights a copy of the contract awardee's Employee Utilization Form, a copy of any required written affirmative action plan, and any written correspondence related thereto. The Department of Human Rights may review and revise any action taken by the Department of Transportation with respect to these requirements.





**RETURN WITH BID**

**Contract No. 76A80  
MARION County  
Section (16,16NRM-Z,16Z)RS-5  
Project F-327(39)  
Route FAP 327  
District 8 Construction Funds**

**PART II. WORKFORCE PROJECTION - continued**

- B. Included in "Total Employees" under Table A is the total number of **new hires** that would be employed in the event the undersigned bidder is awarded this contract.

The undersigned bidder projects that: (number) \_\_\_\_\_ new hires would be recruited from the area in which the contract project is located; and/or (number) \_\_\_\_\_ new hires would be recruited from the area in which the bidder's principal office or base of operation is located.

- C. Included in "Total Employees" under Table A is a projection of numbers of persons to be employed directly by the undersigned bidder as well as a projection of numbers of persons to be employed by subcontractors.

The undersigned bidder estimates that (number) \_\_\_\_\_ persons will be directly employed by the prime contractor and that (number) \_\_\_\_\_ persons will be employed by subcontractors.

**PART III. AFFIRMATIVE ACTION PLAN**

- A. The undersigned bidder understands and agrees that in the event the foregoing minority and female employee utilization projection included under **PART II** is determined to be an underutilization of minority persons or women in any job category, and in the event that the undersigned bidder is awarded this contract, he/she will, prior to commencement of work, develop and submit a written Affirmative Action Plan including a specific timetable (geared to the completion stages of the contract) whereby deficiencies in minority and/or female employee utilization are corrected. Such Affirmative Action Plan will be subject to approval by the contracting agency and the **Department of Human Rights**.
- B. The undersigned bidder understands and agrees that the minority and female employee utilization projection submitted herein, and the goals and timetable included under an Affirmative Action Plan if required, are deemed to be part of the contract specifications.

Company \_\_\_\_\_ Telephone Number \_\_\_\_\_  
\_\_\_\_\_  
Address \_\_\_\_\_

**NOTICE REGARDING SIGNATURE**

The Bidder's signature on the Proposal Signature Sheet will constitute the signing of this form. The following signature block needs to be completed only if revisions are required.

Signature: \_\_\_\_\_ Title: \_\_\_\_\_ Date: \_\_\_\_\_

- Instructions: All tables must include subcontractor personnel in addition to prime contractor personnel.
- Table A - Include both the number of employees that would be hired to perform the contract work and the total number currently employed (Table B) that will be allocated to contract work, and include all apprentices and on-the-job trainees. The "Total Employees" column should include all employees including all minorities, apprentices and on-the-job trainees to be employed on the contract work.
  - Table B - Include all employees currently employed that will be allocated to the contract work including any apprentices and on-the-job trainees currently employed.
  - Table C - Indicate the racial breakdown of the total apprentices and on-the-job trainees shown in Table A.

**RETURN WITH BID**

**ADDITIONAL FEDERAL REQUIREMENTS**

In addition to the Required Contract Provisions for Federal-Aid Construction Contracts (FHWA 1273), all bidders make the following certifications.

- A. By the execution of this proposal, the signing bidder certifies that the bidding entity has not, either directly or indirectly, entered into any agreement, participated in any collusion, or otherwise taken any action, in restraint of free competitive bidding in connection with the submitted bid. This statement made by the undersigned bidder is true and correct under penalty of perjury under the laws of the United States.
- B. CERTIFICATION, EQUAL EMPLOYMENT OPPORTUNITY:
1. Have you participated in any previous contracts or subcontracts subject to the equal opportunity clause. YES \_\_\_\_\_ NO \_\_\_\_\_
  2. If answer to #1 is yes, have you filed with the Joint Reporting Committee, the Director of OFCC, any Federal agency, or the former President's Committee on Equal Employment Opportunity, all reports due under the applicable filing requirements of those organizations? YES \_\_\_\_\_ NO \_\_\_\_\_

**RETURN WITH BID**

**Contract No. 76A80  
MARION County  
Section (16,16NRM-Z,16Z)RS-5  
Project F-327(39)  
Route FAP 327  
District 8 Construction Funds**

PROPOSAL SIGNATURE SHEET

The undersigned bidder hereby makes and submits this bid on the subject Proposal, thereby assuring the Department that all requirements of the Invitation for Bids and rules of the Department have been met, that there is no misunderstanding of the requirements of paragraph 3 of this Proposal, and that the contract will be executed in accordance with the rules of the Department if an award is made on this bid.

(IF AN INDIVIDUAL) Firm Name \_\_\_\_\_  
Signature of Owner \_\_\_\_\_  
Business Address \_\_\_\_\_  
\_\_\_\_\_

(IF A CO-PARTNERSHIP) Firm Name \_\_\_\_\_  
By \_\_\_\_\_  
Business Address \_\_\_\_\_  
Name and Address of All Members of the Firm: \_\_\_\_\_  
\_\_\_\_\_

(IF A CORPORATION) Corporate Name \_\_\_\_\_  
By \_\_\_\_\_  
Signature of Authorized Representative \_\_\_\_\_  
Typed or printed name and title of Authorized Representative \_\_\_\_\_

(IF A JOINT VENTURE, USE THIS SECTION FOR THE MANAGING PARTY AND THE SECOND PARTY SHOULD SIGN BELOW) Attest \_\_\_\_\_  
Signature \_\_\_\_\_  
Business Address \_\_\_\_\_

(IF A JOINT VENTURE) Corporate Name \_\_\_\_\_  
By \_\_\_\_\_  
Signature of Authorized Representative \_\_\_\_\_  
Typed or printed name and title of Authorized Representative \_\_\_\_\_

Attest \_\_\_\_\_  
Signature \_\_\_\_\_  
Business Address \_\_\_\_\_

If more than two parties are in the joint venture, please attach an additional signature sheet.

RETURN WITH BID



Division of Highways
Proposal Bid Bond
(Effective November 1, 1992)

Item No.
Letting Date

KNOW ALL MEN BY THESE PRESENTS, That We

as PRINCIPAL, and

held jointly, severally and firmly bound unto the STATE OF ILLINOIS in the penal sum of 5 percent of the total bid price, or for the amount specified in Article 102.09 of the "Standard Specifications for Road and Bridge Construction" in effect on the date of invitation for bids, whichever is the lesser sum, well and truly to be paid unto said STATE OF ILLINOIS, for the payment of which we bind ourselves, our heirs, executors, administrators, successors and assigns.

THE CONDITION OF THE FOREGOING OBLIGATION IS SUCH, That Whereas, the PRINCIPAL has submitted a bid proposal to the STATE OF ILLINOIS, acting through the Department of Transportation, for the improvement designated by the Transportation Bulletin Item Number and Letting Date indicated above.

NOW, THEREFORE, if the Department shall accept the bid proposal of the PRINCIPAL; and if the PRINCIPAL shall, within the time and as specified in the bidding and contract documents, submit a DBE Utilization Plan that is accepted and approved by the Department; and if, after award by the Department, the PRINCIPAL shall enter into a contract in accordance with the terms of the bidding and contract documents including evidence of the required insurance coverages and providing such bond as specified with good and sufficient surety for the faithful performance of such contract and for the prompt payment of labor and material furnished in the prosecution thereof; or if, in the event of the failure of the PRINCIPAL to make the required DBE submission or to enter into such contract and to give the specified bond, the PRINCIPAL pays to the Department the difference not to exceed the penalty hereof between the amount specified in the bid proposal and such larger amount for which the Department may contract with another party to perform the work covered by said bid proposal, then this obligation shall be null and void, otherwise, it shall remain in full force and effect.

IN THE EVENT the Department determines the PRINCIPAL has failed to comply with any requirement as set forth in the preceding paragraph, then Surety shall pay the penal sum to the Department within fifteen (15) days of written demand therefor. If Surety does not make full payment within such period of time, the Department may bring an action to collect the amount owed. Surety is liable to the Department for all its expenses, including attorney's fees, incurred in any litigation in which it prevails either in whole or in part.

In TESTIMONY WHEREOF, the said PRINCIPAL and the said SURETY have caused this instrument to be signed by their respective officers this day of A.D.,

PRINCIPAL SURETY
(Company Name)
By: (Signature & Title) By: (Signature of Attorney-in-Fact)

Notary Certification for Principal and Surety

STATE OF ILLINOIS,
COUNTY OF

I, a Notary Public in and for said County, do hereby certify that and

(Insert names of individuals signing on behalf of PRINCIPAL & SURETY)

who are each personally known to me to be the same persons whose names are subscribed to the foregoing instrument on behalf of PRINCIPAL and SURETY, appeared before me this day in person and acknowledged respectively, that they signed and delivered said instrument as their free and voluntary act for the uses and purposes therein set forth.

Given under my hand and notarial seal this day of, A.D.

My commission expires Notary Public

In lieu of completing the above section of the Proposal Bid Form, the Principal may file an Electronic Bid Bond. By signing below the Principal is ensuring the identified electronic bid bond has been executed and the Principal and Surety are firmly bound unto the State of Illinois under the conditions of the bid bond as shown above.

Electronic Bid Bond ID# Company/Bidder Name Signature and Title

# PROPOSAL ENVELOPE



## PROPOSALS

for construction work advertised for bids by the Illinois Department of Transportation

Item No.	Item No.	Item No.

Submitted By:

Name:
Address:
Phone No.

Bidders should use an IDOT proposal envelope or affix this form to the front of a 10" x 13" envelope for the submittal of bids. If proposals are mailed, they should be enclosed in a second or outer envelope addressed to:

Engineer of Design and Environment - Room 326  
Illinois Department of Transportation  
2300 South Dirksen Parkway  
Springfield, Illinois 62764

### **NOTICE**

**Individual bids, including Bid Bond and/or supplemental information if required, should be securely stapled.**

# CONTRACTOR OFFICE COPY OF CONTRACT SPECIFICATIONS

## NOTICE

None of the following material needs to be returned with the bid package unless the special provisions require documentation and/or other information to be submitted.

**Contract No. 76A80  
MARION County  
Section (16,16NRM-Z,16Z)RS-5  
Project F-327(39)  
Route FAP 327  
District 8 Construction Funds**



**Illinois Department of Transportation**



## NOTICE TO BIDDERS

- 1. TIME AND PLACE OF OPENING BIDS.** Sealed proposals for the improvement described herein will be received by the Department of Transportation at the Harry R. Hanley Building, 2300 South Dirksen Parkway, in Springfield, Illinois until 10:00 o'clock a.m., June 15, 2007. All bids will be gathered, sorted, publicly opened and read in the auditorium at the Department of Transportation's Harry R. Hanley Building shortly after the 10:00 a.m. cut off time.
- 2. DESCRIPTION OF WORK.** The proposed improvement is identified and advertised for bids in the Invitation for Bids as:

**Contract No. 76A80  
MARION County  
Section (16,16NRM-Z,16Z)RS-5  
Project F-327(39)  
Route FAP 327  
District 8 Construction Funds**

**1.98 miles of milling and HMA surface on U.S. Route 50 from west of I-57 to Weymeyer Avenue in Salem.**

- 3. INSTRUCTIONS TO BIDDERS.** (a) This Notice, the invitation for bids, proposal and letter of award shall, together with all other documents in accordance with Article 101.09 of the Standard Specifications for Road and Bridge Construction, become part of the contract. Bidders are cautioned to read and examine carefully all documents, to make all required inspections, and to inquire or seek explanation of the same prior to submission of a bid.  
  
(b) State law, and, if the work is to be paid wholly or in part with Federal-aid funds, Federal law requires the bidder to make various certifications as a part of the proposal and contract. By execution and submission of the proposal, the bidder makes the certification contained therein. A false or fraudulent certification shall, in addition to all other remedies provided by law, be a breach of contract and may result in termination of the contract.
- 4. AWARD CRITERIA AND REJECTION OF BIDS.** This contract will be awarded to the lowest responsive and responsible bidder considering conformity with the terms and conditions established by the Department in the rules, Invitation for Bids and contract documents. The issuance of plans and proposal forms for bidding based upon a prequalification rating shall not be the sole determinant of responsibility. The Department reserves the right to determine responsibility at the time of award, to reject any or all proposals, to readvertise the proposed improvement, and to waive technicalities.

By Order of the  
Illinois Department of Transportation

Milton R. Sees, Acting Secretary

BD 351 (Rev. 01/2003)

INDEX  
FOR  
SUPPLEMENTAL SPECIFICATIONS  
AND RECURRING SPECIAL PROVISIONS

Adopted January 1, 2007

This index contains a listing of SUPPLEMENTAL SPECIFICATIONS and frequently used RECURRING SPECIAL PROVISIONS.

SUPPLEMENTAL SPECIFICATIONS

Std. Spec. Sec.

Page No.

No Supplemental Specifications this year.



RECURRING SPECIAL PROVISIONS

The following RECURRING SPECIAL PROVISIONS indicated by an "X" are applicable to this contract and are included by reference:

<u>CHECK SHEET #</u>	<u>PAGE NO.</u>
1 X Additional State Requirements For Federal-Aid Construction Contracts (Eff. 2-1-69) (Rev. 1-1-07).....	1
2 X Subletting of Contracts (Federal-Aid Contracts) (Eff. 1-1-88) (Rev. 5-1-93) .....	3
3 X EEO (Eff. 7-21-78) (Rev. 11-18-80) .....	4
4 Specific Equal Employment Opportunity Responsibilities Non Federal-Aid Contracts (Eff. 3-20-69) (Rev. 1-1-94) .....	14
5 Required Provisions - State Contracts (Eff. 4-1-65) (Rev. 1-1-07) .....	19
6 Reserved .....	24
7 National Pollutant Discharge Elimination System Permit (Eff. 7-1-94) (Rev. 1-1-03).....	25
8 Haul Road Stream Crossings, Other Temporary Stream Crossings, and In-Stream Work Pads (Eff. 1-2-92) (Rev. 1-1-98).....	26
9 Construction Layout Stakes Except for Bridges (Eff. 1-1-99) (Rev. 1-1-07).....	27
10 Construction Layout Stakes (Eff. 5-1-93) (Rev. 1-1-07) .....	30
11 Use of Geotextile Fabric for Railroad Crossing (Eff. 1-1-95) (Rev. 1-1-07).....	33
12 Subsealing of Concrete Pavements (Eff. 11-1-84) (Rev. 1-1-07).....	35
13 Hot-Mix Asphalt Surface Removal (Cold Milling) (Eff. 11-1-87) (Rev. 1-1-07) .....	39
14 Pavement and Shoulder Resurfacing (Eff. 2-1-00) (Rev. 1-1-07) .....	41
15 PCC Partial Depth Hot-Mix Asphalt Patching (Eff. 1-1-98) (Rev. 1-1-07) .....	42
16 Patching with Hot-Mix Asphalt Overlay Removal (Eff. 10-1-95) (Rev. 1-1-07).....	44
17 Polymer Concrete (Eff. 8-1-95) (Rev. 3-1-05) .....	45
18 PVC Pipeliner (Eff. 4-1-04) (Rev. 1-1-07) .....	47
19 Pipe Underdrains (Eff. 9-9-87) (Rev. 1-1-07) .....	48
20 X Guardrail and Barrier Wall Delineation (Eff. 12-15-93) (Rev. 1-1-97) .....	49
21 Bicycle Racks (Eff. 4-1-94) (Rev. 1-1-07) .....	53
22 Temporary Modular Glare Screen System (Eff. 1-1-00) (Rev. 1-1-07) .....	55
23 Temporary Portable Bridge Traffic Signals (Eff. 8-1-03) (Rev. 1-1-07) .....	57
24 Work Zone Public Information Signs (Eff. 9-1-02) (Rev. 1-1-07).....	59
25 Night Time Inspection of Roadway Lighting (Eff. 5-1-96).....	60
26 English Substitution of Metric Bolts (Eff. 7-1-96).....	61
27 English Substitution of Metric Reinforcement Bars (Eff. 4-1-96) (Rev. 1-1-03).....	62
28 X Calcium Chloride Accelerator for Portland Cement Concrete (Eff. 1-1-01) .....	63
29 Quality Control of Concrete Mixtures at the Plant-Single A (Eff. 8-1-00) (Rev. 1-1-04) .....	64
30 Quality Control of Concrete Mixtures at the Plant-Double A (Eff. 8-1-00) (Rev. 1-1-04) .....	70
31 Quality Control/Quality Assurance of Concrete Mixtures (Eff. 4-1-92) (Rev. 1-1-07).....	78

## TABLE OF CONTENTS

LOCATION OF PROJECT .....	1
DESCRIPTION OF PROJECT .....	1
COMPLETION DATE PLUS WORKING DAYS.....	1
MONTHLY LABOR SUMMARY AND ACTIVITY REPORTING SYSTEM .....	2
HOT-MIX ASPHALT SURFACE REMOVAL W/SKETCH OF ILLINOIS STANDARD W8-I106 (SPECIAL) 4	
OFFICE COPY MACHINE .....	7
TELEPHONE ANSWERING MACHINE .....	7
TRAFFIC CONTROL PLAN.....	8
CONSTRUCTION AND MAINTENANCE SIGN SUPPORTS .....	8
STATUS OF UTILITIES TO BE ADJUSTED .....	8
HOT MIX ASPHALT (HMA) LONGITUDINAL JOINT DENSITY MODIFIED (BMPR).....	9
PARTIAL DEPTH PATCHING .....	10
CEMENT (BDE) .....	11
DISADVANTAGED BUSINESS ENTERPRISE PARTICIPATION (BDE) .....	14
ERRATA FOR THE 2007 STANDARD SPECIFICATIONS (BDE).....	21
HOT-MIX ASPHALT EQUIPMENT, SPREADING AND FINISHING MACHINE (BDE) .....	23
HOT-MIX ASPHALT - FIELD VOIDS IN THE MINERAL AGGREGATE (BDE).....	23
PAYMENTS TO SUBCONTRACTORS (BDE) .....	25
PLASTIC BLOCKOUTS FOR GUARDRAIL (BDE) .....	26
RECLAIMED ASPHALT PAVEMENT (RAP) (BDE) .....	26
REFLECTIVE CRACK CONTROL TREATMENT (BDE).....	32
REFLECTIVE SHEETING ON CHANNELIZING DEVICES (BDE) .....	34
STEEL PLATE BEAM GUARDRAIL (BDE) .....	35
SUBCONTRACTOR MOBILIZATION PAYMENTS (BDE) .....	36
THERMOPLASTIC PAVEMENT MARKINGS (BDE) .....	36
TRAINING SPECIAL PROVISIONS .....	37
BITUMINOUS MATERIALS COST ADJUSTMENTS (BDE) (RETURN FORM WITH BID).....	39

## STATE OF ILLINOIS

---

### SPECIAL PROVISIONS

The following Special Provisions supplement the "Standard Specifications for Road and Bridge Construction," adopted January 1, 2007, the latest edition of the "Manual on Uniform Traffic Control Devices for Streets and Highways," and the "Manual of Test Procedures for Materials" in effect on the date of invitation for bids, and the Supplemental Specifications and Recurring Special Provisions indicated on the Check Sheet included herein which apply to and govern the construction of FAP Route 327 (US 50); Section (16, 16NRM-Z) RS-5; Marion County; Contract No. 76A80 and in case of conflict with any part or parts of said Specifications, the said Special Provisions shall take precedence and shall govern.

#### LOCATION OF PROJECT

US 50 from west of I-57 to Weymer in Salem.

#### DESCRIPTION OF PROJECT

This project consists of patching, milling and resurfacing. Items of work include: Pavement Patching 12", Leveling Binder (MM), Polymerized Hot-Mix Asphalt Surface Course, Hot-Mix Asphalt Surface Removal, Curb and Gutter Removal and Replacement, Concrete Median Surface Removal and Replacement, Strip Reflective Crack Control Treatment, Hot-Mix Asphalt Shoulders, Remove and Re-Erect Steel Plate Beam Guardrail, Partial Depth Patching, Raised Reflective Pavement Marking, Traffic Control and all necessary and collateral work required to complete the project.

#### COMPLETION DATE PLUS WORKING DAYS

The Contractor for this project is advised that the construction activities for this improvement will be governed by a completion date of November 30, 2007, with an additional five working days as specified in Article 108.05 of the Standard Specifications.

The Contractor shall conduct and coordinate the construction activities in such a manner so as to complete all work required for this improvement except as herein specified on or before the specified date. The Contractor will be allowed five working days for the purpose of seeding and clean-up after the specified completion date.

In the event that all work except as herein specified is not completed by the specified completion date, liquidated damages for each calendar day will be deducted based upon the total contract amount using the schedule in Article 108.09 of the Standard Specifications. In the event that seeding and the project clean-up is not completed within the allowed five working

days past the specified completion date, then liquidated damages for each working day will be deducted based on the total contract amount using the schedule in Article 108.09 of the Standards Specifications.

## **MONTHLY LABOR SUMMARY AND ACTIVITY REPORTING SYSTEM**

Effective: 1-1-1995

Revised June 2001

### **I. Monthly Labor Summary Report, Form SBE 148**

The prime contractor and each first and second tier sub-contractor, (hereinafter referred to as "subcontractor") shall submit a certified Monthly Labor Summary Report directly to the District Engineer.

This report is in lieu of submittal of the Monthly Workforce Analysis Report, Form SBE 956.

This report must be received in District Eight no later than the tenth day of the next month.

This Report shall be submitted by the prime contractor and each subcontractor, for each consecutive month, from the start, to the completion of their work on the contract.

The data source for this Report will be a summation of all personnel and hours worked on each subject contract for the month based on weekly payrolls for that month.

The Monthly Labor Summary Report is required to be submitted in one of the following formats:

- a.) For contractors having IDOT contracts valued in the aggregate at \$250,000 or less, the report may be typed or clearly handwritten using Form SBE 148 for submittal to the District Engineer for District Eight.
- b.) For contractors having IDOT contracts valued in the aggregate at more than \$250,000, the report must be submitted in a specific "Fixed Length Comma Delimited ASCII Text File Format". The subject file format is detailed on the next page. Submittal of this file may be by 3.5 inch disk, modem, or by e-mail.

### **II. Monthly Contract Activity Report, Form SBE 248**

The prime contractor and each subcontractor shall submit a monthly report directly to the District Engineer reflecting their contract activity on all Illinois Department of Transportation contracts they have in force in District Eight.

This report shall be submitted for each consecutive month, from the start, to the completion of all contracts in District Eight.

The report must be received in the District Office no later than the tenth day of the next month.

Monthly Labor Summary and Activity Reporting System Codes and Formats



Failure to comply with this special provision may result in the withholding of payments to the contractor, and/or cancellation, termination, or suspension of the contract in whole or part.

Compliance with this Special Provision shall be considered incidental to the cost of the contract and no additional compensation will be allowed for any costs incurred.

All prime and subcontractors having contracts in the aggregate exceeding \$250,000 must provide a "Fixed Length Comma Delimited ASCII File" for approval prior to the start of construction.

This Special Provision must be included in each subcontract agreement.

The Department of Transportation is requesting disclosure of information necessary to accomplish the statutory purpose as outlined under 23CFR part 230 and 41CFR part 60.4 and the Illinois Human Rights Act. Disclosure of this information is REQUIRED. Failure to comply with this special provision may result in the withholding of payments to the contractor, and/or cancellation, termination, or suspension of the contract in whole or part.

Compliance with this Special Provision shall be considered incidental to the cost of the contract and no additional compensation will be allowed for any costs incurred.

This Special Provision must be included in each subcontract agreement.

## **HOT-MIX ASPHALT SURFACE REMOVAL W/SKETCH OF ILLINOIS STANDARD W8-I106 (SPECIAL)**

*Effective: October 1, 1985*

*Revised: March 30, 2007*

This work shall consist of removing hot-mix asphalt surface to the limits specified on the plans according to Section 440 of the Standard Specifications except as herein modified.

The cuttings from the hot-mix asphalt surface removal shall become the property of IDOT Operations and the cost for transporting the cuttings to an IDOT Operations Yard will be included in the cost for HOT-MIX ASPHALT SURFACE REMOVAL.

Concrete patches which have to be partially removed will be paid for as HOT-MIX ASPHALT SURFACE REMOVAL.

Manholes and valve vaults which are exposed by the hot-mix asphalt surface removal and transverse cuts at the end of the day which are more than 1/2 inch (12 mm) deep shall be tamped with a bituminous cold mix. The cost of this temporary taper shall be included in HOT-MIX ASPHALT SURFACE REMOVAL.

When the removal width of the machine is less than the width of the lane, the operations shall be planned such that after the hot-mix asphalt surface for a portion of the lane has been removed the remaining portion shall have been removed by the end of the day so that the two passes begin and terminate even with each other.

If the depth of removal is greater than 1/2 inch (12 mm), the removal shall be tapered at the terminating point at the end of each day's operation when the lane is open to traffic.

All materials, equipment, and labor necessary to complete the work and maintenance of the tapers as specified above will be included in the contract unit bid price for HOT-MIX ASPHALT SURFACE REMOVAL.

Where hot-mix asphalt surface removal has been performed and water would be pocketed on the pavement prior to resurfacing, the Contractor shall construct temporary ditches through the shoulder to permit drainage as directed by the Engineer. Where the existing shoulders are hot-mix asphalt, narrow strips of surface removal to permit drainage will be done only on the specific instructions from the Engineer. The Contractor shall repair the shoulder to its original condition after the resurfacing is completed.

After any hot-mix asphalt removal operation has been performed, the Contractor shall erect special "ROUGH GROOVED SURFACE" signs, as shown on the attached sheet, in advance of the construction zone in both directions, if applicable. In addition, these signs shall also be erected along major side streets in advance of the construction zone.

These signs shall remain in place until they are no longer applicable as determined by the Engineer. They shall then be removed by the Contractor and become his property.

The cost of furnishing, erecting, maintaining, and removing these signs will not be paid for separately, but shall be considered in the cost of the HOT-MIX ASPHALT SURFACE REMOVAL.

At the end of each day's work, temporary pavement marking line shall be in place on the planed surface in accordance with Section 703 of the Standard Specifications.

# ILLINOIS STANDARD W8-I106



COLOR: LEGEND AND BORDER — BLACK NON-REFLECTORIZED  
 BACKGROUND — ORANGE REFLECTORIZED

SIGN SIZE	DIMENSIONS							
	A	B	C	D	E	F	G	H
36X36	36.0	17.2	2.2	24.3	23.5	5.5	10.5	2.5
48X48	48.0	24.1	3.0	34.0	33.0	6.0	13.0	3.5

SIGN SIZE	SERIES			MAR- GIN	BOR- DER	BLANK STD.
	LINES					
	1	2	3			
36X36	5C	5C	5C	0.6	0.8	B4-36D
48X48	7C	7C	7C	0.8	1.2	B4-48D

All dimensions in inches.



**OFFICE COPY MACHINE**

*Effective: January 1, 1987*

*Revised: November 1, 2006*

The copier specified in Article 670.02 shall meet the following specifications:

- (1) Edge-to-edge copying.
- (2) Up to 11 in x 17 in (275 mm x 425 mm) size for copy-size capabilities.
- (3) A detachable platen cover in order to copy portions of large-bound documents.
- (4) A cabinet stand for the copier.

**TELEPHONE ANSWERING MACHINE**

*Effective: January 11, 1990*

*Revised: November 1, 2006*

The telephone answering machine specified in Article 670.02 shall meet the following minimum specifications:

- (1) Time/Day Indication - A computerized voice records the date and time that each message is received.
- (2) Beeperless Remote - Any remote touch-tone phone can be used to review all messages by the use of an access code.
- (3) Digital System - Pre-recorded and received messages are managed on separate cassettes.
- (4) Conversation Record - The operator can record any phone call.
- (5) Remote Turn-On - Any remote touch-tone phone can be used to turn on the answering machine by the use of an access code.
- (6) Full Message - The Caller is advised if the memory is insufficient to record the call.
- (7) Battery Back-Up - The settings and messages are protected from power failures.
- (8) Two-Line Capacity - Projects that have a second phone line through the provision of a 670.05 Engineer's Field Laboratory shall provide a single phone answering machine that services both lines.

Prior to the purchase of this item, the Contractor shall submit specifications for the proposed machine to the Engineer for his approval.

**TRAFFIC CONTROL PLAN**

*Effective: July 12, 1993*

*Revised: May 12, 1997*

Traffic control shall be in accordance with the applicable sections of the "Standard Specifications for Road and Bridge Construction", the applicable guidelines contained in the "National Manual on Uniform Traffic Control Devices for Streets and Highways", Illinois Supplement to the National Manual of Uniform Traffic Control Devices, these Special Provisions, and any special details and Highway Standards contained herein and in the plans.

Special attention is called to Articles 107.09 and 107.14 of the "Standard Specifications for Road and Bridge Construction and the following Highway Standards relating to traffic control:

701411, 701421, 701426, 701501, 701502, 701602, 701701, 702001

In addition, the following Special Provision(s) will also govern traffic control for this project:

Construction and Maintenance Sign Supports

**CONSTRUCTION AND MAINTENANCE SIGN SUPPORTS**

*Effective: April 21, 1981*

*Revised: November 1, 2006*

This work shall be done according to Section 1106 of the Standard Specifications and Highway Standard 702001 except as herein modified.

All construction signs mounted on permanent support for use in temporary traffic control having an area of 10 square feet (1 square meter) or more shall be mounted on two 4 in x 4 in (100 mm x 100 mm) or two 4 in x 6 in (100 mm x 150 mm) wood posts.

Type A metal post (two for each sign) conforming to Article 1006.29 of the Standard Specifications may be used in lieu of wood posts. Type A metal posts used for these signs may be unfinished.

This work shall not be paid for separately; but shall be considered included in the cost of the traffic control items in this contract.

**STATUS OF UTILITIES TO BE ADJUSTED**

NAME AND ADDRESS OF UTILITY	TYPE	LOCATION	ESTIMATED DATE RELOCATION COMPLETED
SBC 210 N. Locust Street Floor 2 Centralia, IL 62801 Contact: Mr. Joe Moore Phone: (618) 533-3418	Communications	If necessary, manholes to be adjusted in coordination with Construction	N/A

Charter Communications, Inc. 941 Charter Commons Town & Country, MO 63017 Contact: Mr. Larry Saafir Phone: (636) 220-2174	Cable T.V.	No relocation anticipated.	N/A
AmerenIP 2610 Broadway P. O. Box 868 Mt. Vernon, IL 62864-0868 Contact: Mr. Michael Tatlock Phone: (618) 244-8271	Electric	No relocation anticipated.	N/A
City of Salem 101 South Broadway Salem, IL 62881 Contact: Mr. John Pruden Phone: (618) 548-2222	Water, Sewer	Gas, If necessary, valves, meters, and manholes to be adjusted in coordination with Construction.	N/A
Tri-County Electric Cooperative, Inc. 3906 West Broadway P. O. Box 309 Mt. Vernon, IL 62864-0309 Contact: Mr. Lynn Hawkins Phone: (618) 244-5151	Electric	No relocation anticipated.	N/A
Atmos Energy 224 S. 6 <sup>th</sup> Street P. O. Box 160 Vandalia, IL 62471 Contact: Mr. Les Smith Phone: (618) 283-3190	Gas	No relocation anticipated.	N/A
US Sonet 123 East Main Street Salem, IL 62281 Contact: Mr. Chris Young Phone: (618) 548-6909	Communications	No relocation anticipated.	N/A

The above represents the best information of the Department and is only included for the convenience of the bidder. The applicable provisions of Section 102 and Articles 105.07 and 107.20 of the Standard Specifications for Road and Bridge Construction shall apply.

If any utility adjustment or removal has not been completed when required by the Contractor's operation, the Contractor should notify the Engineer in writing. A request for an extension of time will be considered to the extent the Contractor's operations were affected.

**HOT MIX ASPHALT (HMA) LONGITUDINAL JOINT DENSITY MODIFIED (BMPR)**  
 Effective: January 1, 2007

Description: This work shall consist of testing HMA longitudinal joints for density acceptance criteria. This work shall be according to Sections 406, 407, and 1030 of the Standard Specifications except as follows.

Definitions:

Density Test Location: The station location used for density testing.

Density Test Site: Individual test site where a single joint density value is determined.

Joint Density Value: The density determined at a given density test site from the average of two or potentially three readings.

Quality Control / Quality Assurance (QC/QA)

1030.05(d)(3) Add the following paragraphs: Longitudinal joint density testing shall be performed at each quality control density test location. Longitudinal joint testing shall be located at two inches off each pavement edge. It shall be documented as to whether the joint was confined or unconfined.

The joint density value shall be determined using either a correlated nuclear gauge or cores. When using a correlated nuclear gauge, two one-minute density readings shall be taken at the given density test site. The gauge shall be rotated 180 degrees between readings. If the two readings are not within 1.5 lb/cu ft (23 kg/cu m) then one additional reading shall be taken. Additional density readings taken at a given site shall not be allowed to replace the original density readings unless an obvious error has occurred (i.e. the nuclear gauge was sitting on a rock).

1030.05(d) (4) Add following to density control limits:

Mixture / Parameter	Joint Density Value
All HMA Mixtures	≥ 90.0%

**PARTIAL DEPTH PATCHING**

Description. This work shall consist of partial depth removal of the existing pavement structure and replacement with hot-mix asphalt at the locations shown on the plans or as directed by the Engineer.

Materials. The bituminous prime coat and hot-mix asphalt mixture shall be according to Section 406 of the Standard Specifications.

Equipment. The machine used for milling shall be a self-propelled milling machine capable of milling a 12ft lane to the specified depth without damaging the adjacent pavement that is to remain in place. Rollers used to compact the hot-mix asphalt mixture shall be according to Article 442.03 of the Standard Specifications. Cleaning equipment shall be a mechanical sweeper according to Article 1101.03 of the Standard Specifications or air equipment capable of applying compressed air, at a minimum 690 kPa(100psi), and shall have sufficient flow rate to remove all disturbed pavement debris. Air equipment shall meet the requirements of ASTM D 4285.

## CONSTRUCTION REQUIREMENTS

General. Disposal of waste materials shall be according to Article 202.03 of the Standard Specifications.

Partial depth removal of the pavement shall be accomplished by the use of a milling machine. Debris from the milling operation shall be removed from the patch area by air equipment or mechanical sweeper and shall remove all disturbed pavement debris and any loose and/or unsound hot-mix asphalt.

When the Engineer determines the exposed pavement will be suitable for a partial depth patch, a bituminous prime coat shall be applied according to Article 406.05(b) of the Standard Specifications.

The prepared patch shall be filled with hot-mix asphalt with a maximum lift thickness of 3 inches. Where more than one lift is needed, the top lift shall be a minimum of 2 inches thick. At the option of the Contractor, the 2 inch top layer may be constructed using hot-mix asphalt surface course. The hot-mix asphalt shall be compacted to the satisfaction of the Engineer.

Patches opened to traffic which are high or become rough by rutting, shoving, or heaving shall be corrected by trimming off high areas and/or filling depressions. Filled areas shall be rolled again. Trimming high patches or filling in depressions on rough patches shall be at the Contractor's expense.

Method of Measurement. Partial depth removal of the pavement will be measured in square yards of the thickness specified.

Hot-mix asphalt mixtures for partial depth patching of pavement will be measured in tons.

Basis of Payment. Partial depth removal of the pavement will be paid for at the contract unit price per square yard for PARTIAL DEPTH REMOVAL, of the thickness specified or as directed by the Engineer, depth patching will be paid for at the contract unit price per metric tons (tons) for PARTIAL DEPTH PATCHING.

### **CEMENT (BDE)**

Effective: January 1, 2007

Revise Section 1001 of the Standard Specifications to read:

#### **"SECTION 1001. CEMENT**

**1001.01 Cement Types.** Cement shall be according to the following.

- (a) Portland Cement. Acceptance of portland cement shall be according to the current Bureau of Materials and Physical Research's Policy Memorandum, "Portland or Blended Cement Acceptance Procedure for Qualified and Non-Qualified Plants".

Portland cement shall be according to ASTM C 150, and shall meet the standard physical and chemical requirements. Type I or Type II may be used for cast-in-place, precast, and precast prestressed concrete. Type III may be used according to Article 1020.04, or when approved by the Engineer. All other cements referenced in ASTM C 150 may be used when approved by the Engineer.

The total of all organic processing additions shall be a maximum of 1.0 percent by weight (mass) of the cement and the total of all inorganic processing additions shall be a maximum of 4.0 percent by weight (mass) of the cement. Organic processing additions shall be limited to grinding aids that improve the flowability of cement, reduce pack set, and improve grinding efficiency. Inorganic processing additions shall be limited to granulated blast-furnace slag according to the chemical requirements of AASHTO M 302 and Class C fly ash according to the chemical requirements of AASHTO M 295.

- (b) Portland-Pozzolan Cement. Acceptance of portland-pozzolan cement shall be according to the current Bureau of Materials and Physical Research's Policy Memorandum, "Portland or Blended Cement Acceptance Procedure for Qualified and Non-Qualified Plants".

Portland-pozzolan cement shall be according to ASTM C 595 and shall meet the standard physical and chemical requirements. Type IP or I(PM) may be used for cast-in-place, precast, and precast prestressed concrete, except when Class PP concrete is used. The pozzolan constituent for Type IP shall be a maximum of 21 percent of the weight (mass) of the portland-pozzolan cement. All other cements referenced in ASTM C 595 may be used when approved by the Engineer.

For cast-in-place construction, portland-pozzolan cements shall only be used from April 1 to October 15.

The total of all organic processing additions shall be a maximum of 1.0 percent by weight (mass) of the cement. Organic processing additions shall be limited to grinding aids as defined in (a) above. Inorganic processing additions shall not be used.

- (c) Portland Blast-Furnace Slag Cement. Acceptance of portland blast-furnace slag cement shall be according to the current Bureau of Materials and Physical Research's Policy Memorandum, "Portland or Blended Cement Acceptance Procedure for Qualified and Non-Qualified Plants".

Portland blast-furnace slag cement shall be according to ASTM C 595 and shall meet the standard physical and chemical requirements. Type I(SM) slag-modified portland cement may be used for cast-in-place, precast, and precast prestressed concrete, except when Class PP concrete is used. All other cements referenced in ASTM C 595 may be used when approved by the Engineer.

For cast-in-place construction, portland blast-furnace slag cements shall only be used from April 1 to October 15.

The total of all organic processing additions shall be a maximum of 1.0 percent by weight (mass) of the cement. Organic processing additions shall be limited to grinding aids as defined in (a) above. Inorganic processing additions shall not be used.

(d) Rapid Hardening Cement. Rapid hardening cement shall be used according to Article 1020.04 or when approved by the Engineer. The cement shall be on the Department's current "Approved List of Packaged, Dry, Rapid Hardening Cementitious Materials for Concrete Repairs", and shall be according to the following.

- (1) The cement shall have a maximum final set of 25 minutes, according to Illinois Modified ASTM C 191.
- (2) The cement shall have a minimum compressive strength of 2000 psi (13,800 kPa) at 3.0 hours, and 4000 psi (27,600 kPa) at 24.0 hours, according to Illinois Modified ASTM C 109.
- (3) The cement shall have a maximum drying shrinkage of 0.050 percent at seven days, according to Illinois Modified ASTM C 596.
- (4) The cement shall have a maximum expansion of 0.020 percent at 14 days, according to Illinois Modified ASTM C 1038.
- (5) The cement shall have a minimum 80 percent relative dynamic modulus of elasticity; and shall not have a weight (mass) gain in excess of 0.15 percent or a weight (mass) loss in excess of 1.0 percent, after 100 cycles, according to Illinois Modified AASHTO T 161, Procedure B. At 100 cycles, the specimens are measured and weighed at 73 °F (23 °C).

(e) Calcium Aluminate Cement. Calcium aluminate cement shall be used when specified by the Engineer. The cement shall meet the standard physical requirements for Type I cement according to ASTM C 150, except the time of setting shall not apply. The chemical requirements shall be determined according to ASTM C 114 and shall be as follows: minimum 38 percent aluminum oxide ( $Al_2O_3$ ), maximum 42 percent calcium oxide (CaO), maximum 1 percent magnesium oxide (MgO), maximum 0.4 percent sulfur trioxide ( $SO_3$ ), maximum 1 percent loss on ignition, and maximum 3.5 percent insoluble residue.

**1001.02 Uniformity of Color.** Cement contained in single loads or in shipments of several loads to the same project shall not have visible differences in color.

**1001.03 Mixing Brands and Types.** Different brands or different types of cement from the same manufacturing plant, or the same brand or type from different plants shall not be mixed or used alternately in the same item of construction unless approved by the Engineer.

**1001.04 Storage.** Cement shall be stored and protected against damage, such as dampness which may cause partial set or hardened lumps. Different brands or different types of cement from the same manufacturing plant, or the same brand or type from different plants shall be kept separate."

**DISADVANTAGED BUSINESS ENTERPRISE PARTICIPATION (BDE)**

Effective: September 1, 2000

Revised: January 1, 2007

FEDERAL OBLIGATION. The Department of Transportation, as a recipient of federal financial assistance, is required to take all necessary and reasonable steps to ensure nondiscrimination in the award and administration of contracts. Consequently, the federal regulatory provisions of 49 CFR part 26 apply to this contract concerning the utilization of disadvantaged business enterprises. For the purposes of this Special Provision, a disadvantaged business enterprise (DBE) means a business certified by the Department in accordance with the requirements of 49 CFR part 26 and listed in the DBE Directory or most recent addendum.

STATE OBLIGATION. This Special Provision will also be used by the Department to satisfy the requirements of the Business Enterprise for Minorities, Females, and Persons with Disabilities Act, 30 ILCS 575. When this Special Provision is used to satisfy state law requirements on 100 percent state-funded contracts, the federal government has no involvement in such contracts (not a federal-aid contract) and no responsibility to oversee the implementation of this Special Provision by the Department on those contracts. DBE participation on 100 percent state-funded contracts will not be credited toward fulfilling the Department's annual overall DBE goal required by the US Department of Transportation to comply with the federal DBE program requirements.

CONTRACTOR ASSURANCE. The Contractor makes the following assurance and agrees to include the assurance in each subcontract that the Contractor signs with a subcontractor:

The Contractor, subrecipient, or subcontractor shall not discriminate on the basis of race, color, national origin, or sex in the performance of this contract. The Contractor shall carry out applicable requirements of 49 CFR part 26 in the award and administration of contracts funded in whole or in part with federal or state funds. Failure by the Contractor to carry out these requirements is a material breach of this contract, which may result in the termination of this contract or such other remedy as the recipient deems appropriate.

OVERALL GOAL SET FOR THE DEPARTMENT. As a requirement of compliance with 49 CFR part 26, the Department has set an overall goal for DBE participation in its federally assisted contracts. That goal applies to all federal-aid funds the Department will expend in its federally assisted contracts for the subject reporting fiscal year. The Department is required to make a good faith effort to achieve the overall goal. The dollar amount paid to all approved DBE firms performing work called for in this contract is eligible to be credited toward fulfillment of the Department's overall goal.

CONTRACT GOAL TO BE ACHIEVED BY THE CONTRACTOR. This contract includes a specific DBE utilization goal established by the Department. The goal has been included because the Department has determined that the work of this contract has subcontracting opportunities that may be suitable for performance by DBE companies. This determination is based on an assessment of the type of work, the location of the work, and the availability of DBE companies to do a part of the work. The assessment indicates that, in the absence of unlawful discrimination, and in an arena of fair and open competition, DBE companies can be expected to perform 11.0% of the work. This percentage is set as the DBE participation goal for this contract. Consequently, in addition to the other award criteria established for this contract,



the Department will award this contract to a bidder who makes a good faith effort to meet this goal of DBE participation in the performance of the work. A bidder makes a good faith effort for award consideration if either of the following is done in accordance with the procedures set forth in this Special Provision:

- (a) The bidder documents that firmly committed DBE participation has been obtained to meet the goal; or
- (b) The bidder documents that a good faith effort has been made to meet the goal, even though the effort did not succeed in obtaining enough DBE participation to meet the goal.

**DBE LOCATOR REFERENCES.** Bidders may consult the DBE Directory as a reference source for DBE companies certified by the Department. In addition, the Department maintains a letting and item specific DBE locator information system whereby DBE companies can register their interest in providing quotes on particular bid items advertised for letting. Information concerning DBE companies willing to quote work for particular contracts may be obtained by contacting the Department's Bureau of Small Business Enterprises at telephone number (217)785-4611, or by visiting the Department's web site at [www.dot.il.gov](http://www.dot.il.gov).

**BIDDING PROCEDURES.** Compliance with the bidding procedures of this Special Provision is required prior to the award of the contract and the failure of the as-read low bidder to comply will render the bid not responsive.

- (a) In order to assure the timely award of the contract, the as-read low bidder shall submit a Disadvantaged Business Utilization Plan on Department form SBE 2026 within seven working days after the date of letting. To meet the seven day requirement, the bidder may send the Plan by certified mail or delivery service within the seven working day period. If a question arises concerning the mailing date of a Plan, the mailing date will be established by the U.S. Postal Service postmark on the original certified mail receipt from the U.S. Postal Service or the receipt issued by a delivery service. It is the responsibility of the bidder to ensure that the postmark or receipt date is affixed within the seven working days if the bidder intends to rely upon mailing or delivery to satisfy the submission day requirement. The Plan is to be submitted to the Department of Transportation, Bureau of Small Business Enterprises, Contract Compliance Section, 2300 South Dirksen Parkway, Room 319, Springfield, Illinois 62764 (Telefax: (217)785-1524). It is the responsibility of the bidder to obtain confirmation of telefax delivery. The Department will not accept a Utilization Plan if it does not meet the seven day submittal requirement and the bid will be declared not responsive. In the event the bid is declared not responsive due to a failure to submit a Plan or failure to comply with the bidding procedures set forth herein, the Department may elect to cause the forfeiture of the penal sum of the bidder's proposal guaranty, and may deny authorization to bid the project if re-advertised for bids. The Department reserves the right to invite any other bidder to submit a Utilization Plan at any time for award consideration or to extend the time for award.
- (b) The Utilization Plan shall indicate that the bidder either has obtained sufficient DBE participation commitments to meet the contract goal or has not obtained enough DBE

participation commitments in spite of a good faith effort to meet the goal. The Utilization Plan shall further provide the name, telephone number, and telefax number of a responsible official of the bidder designated for purposes of notification of plan approval or disapproval under the procedures of this Special Provision.

- (c) The Utilization Plan shall include a DBE Participation Commitment Statement, Department form SBE 2025, for each DBE proposed for the performance of work to achieve the contract goal. The signatures on these forms must be original signatures. All elements of information indicated on the said form shall be provided, including but not limited to the following:
- (1) The name and address of each DBE to be used;
  - (2) A description, including pay item numbers, of the commercially useful work to be done by each DBE;
  - (3) The price to be paid to each DBE for the identified work specifically stating the quantity, unit price, and total subcontract price for the work to be completed by the DBE. If partial pay items are to be performed by the DBE, indicate the portion of each item, a unit price where appropriate and the subcontract price amount;
  - (4) A commitment statement signed by the bidder and each DBE evidencing availability and intent to perform commercially useful work on the project; and
  - (5) If the bidder is a joint venture comprised of DBE firms and non-DBE firms, the plan must also include a clear identification of the portion of the work to be performed by the DBE partner(s).
- (d) The contract will not be awarded until the Utilization Plan submitted by the bidder is approved. The Utilization Plan will be approved by the Department if the Plan commits sufficient commercially useful DBE work performance to meet the contract goal. The Utilization Plan will not be approved by the Department if the Plan does not commit sufficient DBE performance to meet the contract goal unless the bidder documents that it made a good faith effort to meet the goal. The good faith procedures of Section VIII of this special provision apply. If the Utilization Plan is not approved because it is deficient in a technical matter, unless waived by the Department, the bidder will be notified and will be allowed no less than a five working day period in order to cure the deficiency.

CALCULATING DBE PARTICIPATION. The Utilization Plan values represent work anticipated to be performed and paid for upon satisfactory completion. The Department is only able to count toward the achievement of the overall goal and the contract goal the value of payments made for the work actually performed by DBE companies. In addition, a DBE must perform a commercially useful function on the contract to be counted. A commercially useful function is generally performed when the DBE is responsible for the work and is carrying out its responsibilities by actually performing, managing, and supervising the work involved. The Department and Contractor are governed by the provisions of 49 CFR part 26.55(c) on questions of commercially useful functions as it affects the work. Specific counting guidelines are provided in 49 CFR part 26.55, the provisions of which govern over the summary contained herein.

- (a) DBE as the Contractor: 100 percent goal credit for that portion of the work performed by the DBE's own forces, including the cost of materials and supplies. Work that a DBE subcontracts to a non-DBE firm does not count toward the DBE goals.
- (b) DBE as a joint venture Contractor: 100 percent goal credit for that portion of the total dollar value of the contract equal to the distinct, clearly defined portion of the work performed by the DBE's own forces.
- (c) DBE as a subcontractor: 100 percent goal credit for the work of the subcontract performed by the DBE's own forces, including the cost of materials and supplies, excluding the purchase of materials and supplies or the lease of equipment by the DBE subcontractor from the prime Contractor or its affiliates. Work that a DBE subcontractor in turn subcontracts to a non-DBE firm does not count toward the DBE goal.
- (d) DBE as a trucker: 100 percent goal credit for trucking participation provided the DBE is responsible for the management and supervision of the entire trucking operation for which it is responsible. At least one truck owned, operated, licensed, and insured by the DBE must be used on the contact. Credit will be given for the full value of all such DBE trucks operated using DBE employed drivers. Goal credit will be limited to the value of the reasonable fee or commission received by the DBE if trucks are leased from a non-DBE company.
- (e) DBE as a material supplier:
  - (1) 60 percent goal credit for the cost of the materials or supplies purchased from a DBE regular dealer.
  - (2) 100 percent goal credit for the cost of materials or supplies obtained from a DBE manufacturer.
  - (3) 100 percent credit for the value of reasonable fees and commissions for the procurement of materials and supplies if not a regular dealer or manufacturer.

GOOD FAITH EFFORT PROCEDURES. If the bidder cannot obtain sufficient DBE commitments to meet the contract goal, the bidder must document in the Utilization Plan the good faith efforts made in the attempt to meet the goal. This means that the bidder must show that all necessary and reasonable steps were taken to achieve the contract goal. Necessary and reasonable steps are those which could reasonably be expected to obtain sufficient DBE participation. The Department will consider the quality, quantity, and intensity of the kinds of efforts that the bidder has made. Mere *pro forma* efforts are not good faith efforts; rather, the bidder is expected to have taken those efforts that would be reasonably expected of a bidder actively and aggressively trying to obtain DBE participation sufficient to meet the contract goal.

- (a) The following is a list of types of action that the Department will consider as part of the evaluation of the bidder's good faith efforts to obtain participation. These listed factors are not intended to be a mandatory checklist and are not intended to be exhaustive. Other factors or efforts brought to the attention of the Department may be relevant in appropriate cases, and will be considered by the Department.

- (1) Soliciting through all reasonable and available means (e.g. attendance at pre-bid meetings, advertising and/or written notices) the interest of all certified DBE companies that have the capability to perform the work of the contract. The bidder must solicit this interest within sufficient time to allow the DBE companies to respond to the solicitation. The bidder must determine with certainty if the DBE companies are interested by taking appropriate steps to follow up initial solicitations.
- (2) Selecting portions of the work to be performed by DBE companies in order to increase the likelihood that the DBE goals will be achieved. This includes, where appropriate, breaking out contract work items into economically feasible units to facilitate DBE participation, even when the prime Contractor might otherwise prefer to perform these work items with its own forces.
- (3) Providing interested DBE companies with adequate information about the plans, specifications, and requirements of the contract in a timely manner to assist them in responding to a solicitation.
- (4) a. Negotiating in good faith with interested DBE companies. It is the bidder's responsibility to make a portion of the work available to DBE subcontractors and suppliers and to select those portions of the work or material needs consistent with the available DBE subcontractors and suppliers, so as to facilitate DBE participation. Evidence of such negotiation includes the names, addresses, and telephone numbers of DBE companies that were considered; a description of the information provided regarding the plans and specifications for the work selected for subcontracting; and evidence as to why additional agreements could not be reached for DBE companies to perform the work.  
  
b. A bidder using good business judgment would consider a number of factors in negotiating with subcontractors, including DBE subcontractors, and would take a firm's price and capabilities as well as contract goals into consideration. However, the fact that there may be some additional costs involved in finding and using DBE companies is not in itself sufficient reason for a bidder's failure to meet the contract DBE goal, as long as such costs are reasonable. Also, the ability or desire of a bidder to perform the work of a contract with its own organization does not relieve the bidder of the responsibility to make good faith efforts. Bidders are not, however, required to accept higher quotes from DBE companies if the price difference is excessive or unreasonable.
- (5) Not rejecting DBE companies as being unqualified without sound reasons based on a thorough investigation of their capabilities. The bidder's standing within its industry, membership in specific groups, organizations, or associations and political or social affiliations (for example union vs. non-union employee status) are not legitimate causes for the rejection or non-solicitation of bids in the bidder's efforts to meet the project goal.
- (6) Making efforts to assist interested DBE companies in obtaining bonding, lines of credit, or insurance as required by the recipient or Contractor.

- (7) Making efforts to assist interested DBE companies in obtaining necessary equipment, supplies, materials, or related assistance or services.
- (8) Effectively using the services of available minority/women community organizations; minority/women contractors' groups; local, state, and federal minority/women business assistance offices; and other organizations as allowed on a case-by-case basis to provide assistance in the recruitment and placement of DBE companies.
- (b) If the Department determines that the bidder has made a good faith effort to secure the work commitment of DBE companies to meet the contract goal, the Department will award the contract provided that it is otherwise eligible for award. If the Department determines that a good faith effort has not been made, the Department will notify the bidder of that preliminary determination by contacting the responsible company official designated in the Utilization Plan. The preliminary determination shall include a statement of reasons why good faith efforts have not been found, and may include additional good faith efforts that the bidder could take. The notification will designate a five working day period during which the bidder shall take additional efforts. The bidder is not limited by a statement of additional efforts, but may take other action beyond any stated additional efforts in order to obtain additional DBE commitments. The bidder shall submit an amended Utilization Plan if additional DBE commitments to meet the contract goal are secured. If additional DBE commitments sufficient to meet the contract goal are not secured, the bidder shall report the final good faith efforts made in the time allotted. All additional efforts taken by the bidder will be considered as part of the bidder's good faith efforts. If the bidder is not able to meet the goal after taking additional efforts, the Department will make a pre-final determination of the good faith efforts of the bidder and will notify the designated responsible company official of the reasons for an adverse determination.
- (c) The bidder may request administrative reconsideration of a pre-final determination adverse to the bidder within the five working days after the notification date of the determination by delivering the request to the Department of Transportation, Bureau of Small Business Enterprises, Contract Compliance Section, 2300 South Dirksen Parkway, Room 319, Springfield, Illinois 62764 (Telefax: (217)785-1524). Deposit of the request in the United States mail on or before the fifth business day shall not be deemed delivery. The pre-final determination shall become final if a request is not made and delivered. A request may provide additional written documentation and/or argument concerning the issue of whether an adequate good faith effort was made to meet the contract goal. In addition, the request shall be considered a consent by the bidder to extend the time for award. The request will be forwarded to the Department's Reconsideration Officer. The Reconsideration Officer will extend an opportunity to the bidder to meet in person in order to consider all issues of whether the bidder made a good faith effort to meet the goal. After the review by the Reconsideration Officer, the bidder will be sent a written decision within ten working days after receipt of the request for reconsideration, explaining the basis for finding that the bidder did or did not meet the goal or make adequate good faith efforts to do so. A final decision by the Reconsideration Officer that a good faith effort was made shall approve the Utilization Plan submitted by the bidder and shall clear the contract for award. A final decision that a good faith effort was not made shall render the bid not responsive.

CONTRACT COMPLIANCE. Compliance with this Special Provision is an essential part of the contract. The Department is prohibited by federal regulations from crediting the participation of a DBE included in the Utilization Plan toward either the contract goal or the Department's overall goal until the amount to be applied toward the goals has been paid to the DBE. The following administrative procedures and remedies govern the compliance by the Contractor with the contractual obligations established by the Utilization Plan. After approval of the Plan and award of the contract, the Utilization Plan and individual DBE Participation Statements become part of the contract. If the Contractor did not succeed in obtaining enough DBE participation to achieve the advertised contract goal, and the Utilization Plan was approved and contract awarded based upon a determination of good faith, the total dollar value of DBE work calculated in the approved Utilization Plan as a percentage of the awarded contract value shall become the amended contract goal.

- (a) No amendment to the Utilization Plan may be made without prior written approval from the Department's Bureau of Small Business Enterprises. All requests for amendment to the Utilization Plan shall be submitted to the Department of Transportation, Bureau of Small Business Enterprises, Contract Compliance Section, 2300 South Dirksen Parkway, Room 319, Springfield, Illinois 62764. Telephone number (217) 785-4611. Telefax number (217) 785-1524.
- (b) All work indicated for performance by an approved DBE shall be performed, managed, and supervised by the DBE executing the Participation Statement. The Contractor shall not terminate for convenience a DBE listed in the Utilization Plan and then perform the work of the terminated DBE with its own forces, those of an affiliate or those of another subcontractor, whether DBE or not, without first obtaining the written consent of the Bureau of Small Business Enterprises to amend the Utilization Plan. If a DBE listed in the Utilization Plan is terminated for reasons other than convenience, or fails to complete its work on the contract for any reason, the Contractor shall make good faith efforts to find another DBE to substitute for the terminated DBE. The good faith efforts shall be directed at finding another DBE to perform at least the same amount of work under the contract as the DBE that was terminated, but only to the extent needed to meet the contract goal or the amended contract goal. The Contractor shall notify the Bureau of Small Business Enterprises of any termination for reasons other than convenience, and shall obtain approval for inclusion of the substitute DBE in the Utilization Plan. If good faith efforts following a termination of a DBE for cause are not successful, the Contractor shall contact the Bureau and provide a full accounting of the efforts undertaken to obtain substitute DBE participation. The Bureau will evaluate the good faith efforts in light of all circumstances surrounding the performance status of the contract, and determine whether the contract goal should be amended.
- (c) The Contractor shall maintain a record of payments for work performed to the DBE participants. The records shall be made available to the Department for inspection upon request. After the performance of the final item of work or delivery of material by a DBE and final payment therefor to the DBE by the Contractor, but not later than thirty calendar days after payment has been made by the Department to the Contractor for such work or material, the Contractor shall submit a DBE Payment Report on Department form SBE 2115 to the Regional Engineer. If full and final payment has not been made to the DBE, the Report shall indicate whether a disagreement as to the

payment required exists between the Contractor and the DBE or if the Contractor believes that the work has not been satisfactorily completed. If the Contractor does not have the full amount of work indicated in the Utilization Plan performed by the DBE companies indicated in the Plan, the Department will deduct from contract payments to the Contractor the amount of the goal not achieved as liquidated and ascertained damages.

- (d) The Department reserves the right to withhold payment to the Contractor to enforce the provisions of this Special Provision. Final payment shall not be made on the contract until such time as the Contractor submits sufficient documentation demonstrating achievement of the goal in accordance with this Special Provision or after liquidated damages have been determined and collected.
- (e) Notwithstanding any other provision of the contract, including but not limited to Article 109.09 of the Standard Specifications, the Contractor may request administrative reconsideration of a decision to deduct the amount of the goal not achieved as liquidated damages. A request to reconsider shall be delivered to the Contract Compliance Section and shall be handled and considered in the same manner as set forth in paragraph (c) of "Good Faith Effort Procedures" of this Special Provision, except a final decision that a good faith effort was not made during contract performance to achieve the goal agreed to in the Utilization Plan shall be the final administrative decision of the Department.

#### **ERRATA FOR THE 2007 STANDARD SPECIFICATIONS (BDE)**

Effective: January 1, 2007

Revised: April 1, 2007

- Page 60 Article 109.07(a). In the second line of the first paragraph change "amount" to "quantity".
- Page 207 Article 406.14. In the second line of the second paragraph change "MIXTURE FOR CRACKS, JOINTS, AND FLANGEWAYS, of the mixture composition specified;" to "MIXTURE FOR CRACKS, JOINTS, AND FLANGEWAYS;".
- Page 345 Article 505.08(l). In the third line of the first paragraph change "1/8 mm" to "1/8 in.".
- Page 345 Article 505.08(l). In the nineteenth line of the first paragraph change "is" to "in".
- Page 383 Article 516.04(b)(1). In the fifth line of the first paragraph change "drillingpouring" to "pouring".
- Page 390 Article 520.02(h). Change "1027.021" to "1027.01".
- Page 398 Article 540.07(b). Add the following two paragraphs after the third paragraph:  
"Excavation in rock will be measured for payment according to Article 502.12.

Removal and disposal of unstable and/or unsuitable material below plan bedding grade will be measured for payment according to Article 202.07.”

Page 398 Article 540.08. Add the following two paragraphs after the fifth paragraph:

“Excavation in rock will be paid for according to Article 502.13.

Removal and disposal of unstable and/or unsuitable material below plan bedding grade will be paid for according to Article 202.08.”

Page 435 Article 542.04(b). Delete the last sentence of the last paragraph.

Page 465 Article 551.06. In the second line of the first paragraph change “or” to “and/or”.

Page 585 Article 701.19(a). Add “701400” to the second line of the first paragraph.

Page 586 Article 701.19(c). Delete “701400” from the second line of the first paragraph.

Page 586 Article 701.19. Add the following subparagraph to this Article:

“(f) Removal of existing pavement markings and raised reflective pavement markers will be measured for payment according to Article 783.05.”

Page 587 Article 701.20(b). Delete “TRAFFIC CONTROL AND PROTECTION 701400;” from the first paragraph.

Page 588 Article 701.20. Add the following subparagraph to this Article.

“(j) Removal of existing pavement markings and raised reflective pavement markers will be paid for according to Article 783.06.”

Page 762 Article 1020.04. In Table 1 Classes of Portland Cement Concrete and Mix Design Criteria, add to the minimum cement factor for Class PC Concrete “5.65 (TY III)”, and add to the maximum cement factor for Class PC Concrete “7.05 (TY III)”.

Page 765 Article 1020.04. In Table 1 Classes of Portland Cement Concrete and Mix Design Criteria (metric), add to the minimum cement factor for Class PC Concrete “335 (TY III)”, and add to the maximum cement factor for Class PC Concrete “418 (TY III)”.

Page 800 Article 1030.05(a)(12). Revise “Dust Collection Factor” to “Dust Correction Factor”.

Page 800 Article 1030.05(a)(14). Revise the first occurrence of Article 1030.05(a)(14) to Article 1030.05(a)(13).

Page 809 Article 1030.05. Revise the subparagraph “(a) Quality Assurance by the Engineer.” to read “(e) Quality Assurance by the Engineer.”.



Page 946 Article 1080.03(a)(1). In the third line of the first paragraph revise “(300 µm)” to “(600 µm)”.

Page 963 Article 1083.02(b). In the second line of the first paragraph revise “ASTM D 4894” to “ASTM D 4895”.

Page 1076 In the Index of Pay Items delete the pay item “BITUMINOUS SURFACE REMOVAL – BUTT JOINT”.

**HOT-MIX ASPHALT EQUIPMENT, SPREADING AND FINISHING MACHINE (BDE)**

Effective: January 1, 2005

Revised: January 1, 2007

Revise the fourth paragraph of Article 1102.03 of the Standard Specifications to read:

“The paver shall be equipped with a receiving hopper having sufficient capacity for a uniform spreading operation. The hopper shall be equipped with a distribution system to uniformly place a non-segregated mixture in front of the screed. The distribution system shall have chain curtains, deflector plates, and /or other devices designed and built by the paver manufacturer to prevent segregation during distribution of the mixture from the hopper to the paver screed. The Contractor shall submit a written certification that the devices recommended by the paver manufacturer to prevent segregation have been installed and are operational. Prior to paving, the Contractor, in the presence of the Engineer, shall visually inspect paver parts specifically identified by the manufacturer for excessive wear and the need for replacement. The Contractor shall supply a completed check list to the Engineer noting the condition of the parts. Worn parts shall be replaced. The Engineer may require an additional inspection prior to placement of the surface course or at other times throughout the work.”

**HOT-MIX ASPHALT - FIELD VOIDS IN THE MINERAL AGGREGATE (BDE)**

Effective: April 1, 2007

Add the following to the table in Article 1030.05(d)(2)a. of the Standard Specifications:

“Parameter	Frequency of Tests	Frequency of Tests	Test Method See Manual of Test Procedures for Materials
	High ESAL Mixture Low ESAL Mixture	All Other Mixtures	
VMA  Note 5.	1 per half day of production for first 2 days and 1 per day thereafter (first sample of the day)	1 per day	Illinois-Modified AASHTO R 35

Note 5. The  $G_{sb}$  used in the voids in the mineral aggregate (VMA) calculation shall be the same average  $G_{sb}$  value listed in the mix design.”

Add the following to the Control Limits table in Article 1030.05(d)(4) of the Standard Specifications:

"CONTROL LIMITS			
Parameter	High ESAL Low ESAL	High ESAL Low ESAL	All Other
	Individual Test	Moving Avg. of 4	Individual Test
VMA	-0.7 % <sup>2/</sup>	-0.5 % <sup>2/</sup>	N/A

2/ Allowable limit below minimum design VMA requirement"

Add the following to the table in Article 1030.05(d)(5) of the Standard Specifications:

"CONTROL CHART REQUIREMENTS	High ESAL Low ESAL	All Other
	VMA"	

Revise the heading of Article 1030.05(d)(6)a.1. of the Standard Specifications to read:

"1. Voids, VMA, and Asphalt Binder Content."

Revise the first sentence of the first paragraph of Article 1030.05(d)(6)a.1.(a.) of the Standard Specifications to read:

"If the retest for voids, VMA, or asphalt binder content exceeds control limits, HMA production shall cease and immediate corrective action shall be instituted by the Contractor."

Revise the table in Article 1030.05(e) of the Standard Specifications to read:

"Test Parameter	Acceptable Limits of Precision
% Passing: <sup>1/</sup>	
1/2 in. (12.5 mm)	5.0 %
No. 4 (4.75 mm)	5.0 %
No. 8 (2.36 mm)	3.0 %
No. 30 (600 μm)	2.0 %
Total Dust Content No. 200 (75 μm) <sup>1/</sup>	2.2 %
Asphalt Binder Content	0.3 %
Maximum Specific Gravity of Mixture	0.026
Bulk Specific Gravity	0.030
VMA	1.4 %
Density (% Compaction)	1.0 % (Correlated)

1/ Based on washed ignition.”

## **PAYMENTS TO SUBCONTRACTORS (BDE)**

Effective: June 1, 2000

Revised: January 1, 2006

Federal regulations found at 49 CFR §26.29 mandate the Department to establish a contract clause to require Contractors to pay subcontractors for satisfactory performance of their subcontracts and to set the time for such payments.

State law also addresses the timing of payments to be made to subcontractors and material suppliers. Section 7 of the Prompt Payment Act, 30 ILCS 540/7, requires that when a Contractor receives any payment from the Department, the Contractor shall make corresponding, proportional payments to each subcontractor and material supplier performing work or supplying material within 15 calendar days after receipt of the Department payment. Section 7 of the Act further provides that interest in the amount of two percent per month, in addition to the payment due, shall be paid to any subcontractor or material supplier by the Contractor if the payment required by the Act is withheld or delayed without reasonable cause. The Act also provides that the time for payment required and the calculation of any interest due applies to transactions between subcontractors and lower-tier subcontractors and material suppliers throughout the contracting chain.

This Special Provision establishes the required federal contract clause, and adopts the 15 calendar day requirement of the State Prompt Payment Act for purposes of compliance with the federal regulation regarding payments to subcontractors. This contract is subject to the following payment obligations.

When progress payments are made to the Contractor according to Article 109.07 of the Standard Specifications, the Contractor shall make a corresponding payment to each subcontractor and material supplier in proportion to the work satisfactorily completed by each subcontractor and for the material supplied to perform any work of the contract. The proportionate amount of partial payment due to each subcontractor and material supplier throughout the contracting chain shall be determined by the quantities measured or otherwise determined as eligible for payment by the Department and included in the progress payment to the Contractor. Subcontractors and material suppliers shall be paid by the Contractor within 15 calendar days after the receipt of payment from the Department. The Contractor shall not hold retainage from the subcontractors. These obligations shall also apply to any payments made by subcontractors and material suppliers to their subcontractors and material suppliers; and to all payments made to lower tier subcontractors and material suppliers throughout the contracting chain. Any payment or portion of a payment subject to this provision may only be withheld from the subcontractor or material supplier to whom it is due for reasonable cause.

This Special Provision does not create any rights in favor of any subcontractor or material supplier against the State or authorize any cause of action against the State on account of any payment, nonpayment, delayed payment, or interest claimed by application of the State Prompt Payment Act. The Department will not approve any delay or postponement of the 15 day requirement except for reasonable cause shown after notice and hearing pursuant to Section 7(b) of the State Prompt Payment Act. State law creates other and additional remedies

available to any subcontractor or material supplier, regardless of tier, who has not been paid for work properly performed or material furnished. These remedies are a lien against public funds set forth in Section 23(c) of the Mechanics Lien Act, 770 ILCS 60/23(c), and a recovery on the Contractor's payment bond according to the Public Construction Bond Act, 30 ILCS 550.

### **PLASTIC BLOCKOUTS FOR GUARDRAIL (BDE)**

Effective: November 1, 2004

Revised: January 1, 2007

Add the following to Article 630.02 of the Standard Specifications:

“(g) Plastic Blockouts (Note 1.)

Note 1. Plastic blockouts may be used in lieu of wood blockouts for steel plate beam guardrail. The plastic blockouts shall be the minimum dimensions shown on the plans and shall be on the Department's approved list.”

### **RECLAIMED ASPHALT PAVEMENT (RAP) (BDE)**

Effective: January 1, 2007

Revised: April 1, 2007

In Article 1030.02(g), delete the last sentence of the first paragraph in (Note 2).

Revise Section 1031 of the Standard Specifications to read:

#### **“SECTION 1031. RECLAIMED ASPHALT PAVEMENT**

**1031.01 Description.** Reclaimed asphalt pavement (RAP) is reclaimed asphalt pavement resulting from cold milling or crushing of an existing dense graded hot-mix asphalt (HMA) pavement. The Contractor shall supply written documentation that the RAP originated from routes or airfields under federal, state, or local agency jurisdiction.

**1031.02 Stockpiles.** The Contractor shall construct individual, sealed RAP stockpiles meeting one of the following definitions. No additional RAP shall be added to the pile after the pile has been sealed. Stockpiles shall be sufficiently separated to prevent intermingling at the base. Stockpiles shall be identified by signs indicating the type as listed below (i.e. “Homogeneous Surface”).

Prior to milling, the Contractor shall request the District to provide verification of the quality of the RAP to clarify appropriate stockpile.

- (a) Homogeneous. Homogeneous RAP stockpiles shall consist of RAP from Class I, Superpave (High ESAL), HMA (High ESAL), or equivalent mixtures and represent: 1) the same aggregate quality, but shall be at least C quality; 2) the same type of crushed aggregate (either crushed natural aggregate, ACBF slag, or steel slag); 3) similar gradation; and 4) similar asphalt binder content. If approved by the Engineer, combined single pass surface/binder millings may be considered “homogenous” with a quality rating dictated by the lowest coarse aggregate quality present in the mixture.

- (b) Conglomerate 5/8. Conglomerate 5/8 RAP stockpiles shall consist of RAP from Class I, Superpave (High ESAL), HMA (High ESAL), or equivalent mixtures. The coarse aggregate in this RAP shall be crushed aggregate and may represent more than one aggregate type and/or quality but shall be at least C quality. This RAP may have an inconsistent gradation and/or asphalt binder content prior to processing. All conglomerate 5/8 RAP shall be processed prior to testing by crushing to where all RAP shall pass the 5/8 in. (16 mm) or smaller screen. Conglomerate 5/8 RAP stockpiles shall not contain steel slag or other expansive material as determined by the Department.
- (c) Conglomerate 3/8. Conglomerate 3/8 RAP stockpiles shall consist of RAP from Class I, Superpave (High ESAL), HMA (High ESAL), or equivalent mixtures. The coarse aggregate in this RAP shall be crushed aggregate and may represent more than one aggregate type and/or quality but shall be at least B quality. This RAP may have an inconsistent gradation and/or asphalt binder content prior to processing. All conglomerate 3/8 RAP shall be processed prior to testing by crushing to where all RAP shall pass the 3/8 in. (9.5 mm) or smaller screen. Conglomerate 3/8 RAP stockpiles shall not contain steel slag or other expansive material as determined by the Department.
- (d) Conglomerate "D" Quality (DQ). Conglomerate DQ RAP stockpiles shall consist of RAP from Class I, Superpave (High or Low ESAL), HMA (High or Low ESAL), or equivalent mixtures. The coarse aggregate in this RAP may be crushed or round but shall be at least D quality. This RAP may have an inconsistent gradation and/or asphalt binder content. Conglomerate DQ RAP stockpiles shall not contain steel slag or other expansive material as determined by the Department.
- (e) Non-Quality. RAP stockpiles that do not meet the requirements of the stockpile categories listed above shall be classified as "Non-Quality".

RAP containing contaminants, such as earth, brick, sand, concrete, sheet asphalt, bituminous surface treatment (i.e. chip seal), pavement fabric, joint sealants, etc., will be unacceptable unless the contaminants are removed to the satisfaction of the Engineer. Sheet asphalt shall be stockpiled separately.

**1031.03 Testing.** When used in HMA, the RAP shall be sampled and tested either during or after stockpiling.

For testing during stockpiling, washed extraction samples shall be run at the minimum frequency of one sample per 500 tons (450 metric tons) for the first 2000 tons (1800 metric tons) and one sample per 2000 tons (1800 metric tons) thereafter. A minimum of five tests shall be required for stockpiles less than 4000 tons (3600 metric tons).

For testing after stockpiling, the Contractor shall submit a plan for approval to the District proposing a satisfactory method of sampling and testing the RAP pile either in-situ or by restockpiling. The sampling plan shall meet the minimum frequency required above and detail the procedure used to obtain representative samples throughout the pile for testing.

Before extraction, each field sample shall be split to obtain two samples of test sample size. One of the two test samples from the final split shall be labeled and stored for Department use. The Contractor shall extract the other test sample according to Department procedure. The Engineer reserves the right to test any sample (split or Department-taken) to verify Contractor test results.

- (a) Testing Conglomerate 3/8. In addition to the requirements above, conglomerate 3/8 RAP shall be tested for maximum theoretical specific gravity ( $G_{mm}$ ) at a frequency of one sample per 500 tons (450 metric tons) for the first 2000 tons (1800 metric tons) and one sample per 2000 tons (1800 metric tons) thereafter. A minimum of five tests shall be required for stockpiles less than 4000 tons (3600 metric tons).
- (b) Evaluation of Test Results. All of the extraction results shall be compiled and averaged for asphalt binder content and gradation and, when applicable  $G_{mm}$ . Individual extraction test results, when compared to the averages, will be accepted if within the tolerances listed below.

Parameter	Homogeneous / Conglomerate	Conglomerate "D" Quality
1 in. (25 mm)		± 5 %
1/2 in. (12.5 mm)	± 8 %	± 15 %
No. 4 (4.75 mm)	± 6 %	± 13 %
No. 8 (2.36 mm)	± 5 %	
No. 16 (1.18 mm)		± 15 %
No. 30 (600 μm)	± 5 %	
No. 200 (75 μm)	± 2.0 %	± 4.0 %
Asphalt Binder	± 0.4 % <sup>1/</sup>	± 0.5 %
$G_{mm}$	± 0.02 <sup>2/</sup>	

1/ The tolerance for conglomerate 3/8 shall be ± 0.3 %.

2/ Applies only to conglomerate 3/8. When variation of the  $G_{mm}$  exceeds the ± 0.02 % tolerance, a new conglomerate 3/8 stockpile shall be created which will also require an additional mix design.

If more than 20 percent of the individual sieves are out of the gradation tolerances, or if more than 20 percent of the asphalt binder content test results fall outside the appropriate tolerances, the RAP shall not be used in HMA unless the RAP representing the failing tests is removed from the stockpile. All test data and acceptance ranges shall be sent to the District for evaluation.

With the approval of the Engineer, the ignition oven may be substituted for extractions according to the Illinois Test Procedure, "Calibration of the Ignition Oven for the Purpose of Characterizing Reclaimed Asphalt Pavement (RAP)".

**1031.04 Quality Designation of Aggregate in RAP.** The quality of the RAP shall be set by the lowest quality of coarse aggregate in the RAP stockpile and are designated as follows.

- (a) RAP from Class I, Superpave (High ESAL), or HMA (High ESAL) surface mixtures are designated as containing Class B quality coarse aggregate.
- (b) RAP from Superpave (Low ESAL)/HMA (Low ESAL) IL-19.0L binder and IL-9.5L surface mixtures are designated as Class D quality coarse aggregate.
- (c) RAP from Class I, Superpave (High ESAL), or HMA (High ESAL) binder mixtures, bituminous base course mixtures, and bituminous base course widening mixtures are designated as containing Class C quality coarse aggregate.
- (d) RAP from bituminous stabilized subbase and BAM shoulders are designated as containing Class D quality coarse aggregate.

**1031.05 Use of RAP in HMA.** The use of RAP in HMA shall be as follows.

- (a) Coarse Aggregate Size. The coarse aggregate in all RAP shall be equal to or less than the nominal maximum size requirement for the HMA mixture to be produced.
- (b) Steel Slag Stockpiles. RAP stockpiles containing steel slag or other expansive material, as determined by the Department, shall be homogeneous and will be approved for use in HMA (High ESAL and Low ESAL) surface mixtures only.
- (c) Use in HMA Surface Mixtures (High and Low ESAL). RAP stockpiles for use in HMA surface mixtures (High and Low ESAL) shall be either homogeneous or conglomerate 3/8, in which the coarse aggregate is Class B quality or better.
- (d) Use in HMA Binder Mixtures (High and Low ESAL), HMA Base Course, and HMA Base Course Widening. RAP stockpiles for use in HMA binder mixtures (High and Low ESAL), HMA base course, and HMA base course widening shall be homogeneous, conglomerate 5/8, or conglomerate 3/8, in which the coarse aggregate is Class C quality or better.
- (e) Use in Shoulders and Subbase. RAP stockpiles for use in HMA shoulders and stabilized subbase (HMA) shall be homogeneous, conglomerate 5/8, conglomerate 3/8, or conglomerate DQ.
- (f) The use of RAP shall be a contractor's option when constructing HMA in all contracts. When the contractor chooses the RAP option, the percentage of RAP shall not exceed the amounts indicated in the table for a given N Design.

Max RAP Percentage

HMA MIXTURES <sup>1/, 3/</sup>	MAXIMUM % RAP		
	Ndesign	Binder/Leveling Binder	Surface
30	30	30	10
50	25	15	10
70	15 / 25 <sup>2/</sup>	10 / 15 <sup>2/</sup>	10
90	10	10	10
105	10	10	10

1/ For HMA Shoulder and Stabilized Sub-Base (HMA) N-30, the amount of RAP shall not exceed 50% of the mixture.

2/ Value of Max % RAP if 3/8 RAP is utilized.

3/ When RAP exceeds 20%, the high & low virgin asphalt binder grades shall each be reduced by one grade (i.e. 25% RAP would require a virgin asphalt binder grade of PG64-22 to be reduced to a PG58-28).

**1031.06 HMA Mix Designs.** At the Contractor's option, HMA mixtures may be constructed utilizing RAP material meeting the above detailed requirements.

RAP designs shall be submitted for volumetric verification. If additional RAP stockpiles are tested and found that no more than 20 percent of the results, as defined under "Testing" herein, are outside of the control tolerances set for the original RAP stockpile and HMA mix design, and meets all of the requirements herein, the additional RAP stockpiles may be used in the original mix design at the percent previously verified.

**1031.07 HMA Production.** The coarse aggregate in all RAP used shall be equal to or less than the nominal maximum size requirement for the HMA mixture being produced.

To remove or reduce agglomerated material, a scalping screen, crushing unit, or comparable sizing device approved by the Engineer shall be used in the RAP feed system to remove or reduce oversized material. If material passing the sizing device adversely affects the mix production or quality of the mix, the sizing device shall be set at a size specified by the Engineer.

If the RAP control tolerances or QC/QA test results require corrective action, the Contractor shall cease production of the mixture containing RAP and either switch to the virgin aggregate design or submit a new RAP design. When producing mixtures containing conglomerate 3/8 RAP, a positive dust control system shall be utilized.

HMA plants utilizing RAP shall be capable of automatically recording and printing the following information.



(a) Dryer Drum Plants.

- (1) Date, month, year, and time to the nearest minute for each print.
- (2) HMA mix number assigned by the Department.
- (3) Accumulated weight of dry aggregate (combined or individual) in tons (metric tons) to the nearest 0.1 ton (0.1 metric ton).
- (4) Accumulated dry weight of RAP in tons (metric tons) to the nearest 0.1 ton (0.1 metric ton).
- (5) Accumulated mineral filler in revolutions, tons (metric tons), etc. to the nearest 0.1 unit.
- (6) Accumulated asphalt binder in gallons (liters), tons (metric tons), etc. to the nearest 0.1 unit.
- (7) Residual asphalt binder in the RAP material as a percent of the total mix to the nearest 0.1 percent.
- (8) Aggregate and RAP moisture compensators in percent as set on the control panel. (Required when accumulated or individual aggregate and RAP are printed in wet condition.)

(b) Batch Plants.

- (1) Date, month, year, and time to the nearest minute for each print.
- (2) HMA mix number assigned by the Department.
- (3) Individual virgin aggregate hot bin batch weights to the nearest pound (kilogram).
- (4) Mineral filler weight to the nearest pound (kilogram).
- (5) RAP weight to the nearest pound (kilogram).
- (6) Virgin asphalt binder weight to the nearest pound (kilogram).
- (7) Residual asphalt binder in the RAP material as a percent of the total mix to the nearest 0.1 percent.

The printouts shall be maintained in a file at the plant for a minimum of one year or as directed by the Engineer and shall be made available upon request. The printing system will be inspected by the Engineer prior to production and verified at the beginning of each construction season thereafter.

**1031.08 RAP in Aggregate Surface Course and Aggregate Shoulders.** The use of RAP in aggregate surface course and aggregate shoulders shall be as follows.

- (a) Stockpiles and Testing. RAP stockpiles may be any of those listed in Article 1031.02, except "Other". The testing requirements of Article 1031.03 shall not apply.
- (b) Gradation. One hundred percent of the RAP material shall pass the 1 1/2 in. (37.5 mm) sieve. The RAP material shall be reasonably well graded from coarse to fine. RAP material that is gap-graded or single sized will not be accepted."

**REFLECTIVE CRACK CONTROL TREATMENT (BDE)**

Effective: April 1, 2006

Revised: January 1, 2007

Revise the third sentence of the first paragraph of Article 443.01 of the Standard Specifications to read:

"Strip reflective crack control treatment shall be either System A, B, C, or D at the option of the Contractor."

Add the following to Article 443.02 of the Standard Specifications:

"(c) Hot-Poured Joint Sealer ..... 1050.02"

Revise Article 443.09 of the Standard Specifications to Article 443.10.

Revise Article 443.10 of the Standard Specifications to Article 443.11.

Add the following Article to the Standard Specifications:

**"Article 443.09 Reflective Crack Control System D.** The stress relief membrane shall be applied when the surface temperature is a minimum of 50 °F (10 °C) and rising.

- (a) Tack Coat Placement for Membrane. The tack coat shall be applied to the existing surface using one of the following methods.
  - (1) A hand held wand with a nozzle that produces a fan shaped spray to apply the tack coat evenly according to the rate specified by the manufacturer.
  - (2) A hand held wand without a spray nozzle. The tack coat shall be spread with a squeegee according to the rate specified by the manufacturer.
  - (3) A distributor bar attached to a distributor truck, for longitudinal applications only. The distributor bar nozzles shall be set at 20 degrees to the axis of the bar and the tack coat shall be applied according to the rate specified by the manufacturer. Application of the tack coat directly from a distributor bar attached to a distributor truck will not be permitted for transverse applications.

The maximum width of the tack coat application shall be such that the tack coat extends a maximum 1 1/2 in. (40 mm) on both sides of the stress relief membrane strip.

The use of emulsified asphalts and/or cutbacks is prohibited for use as a tack to bond the stress relief membrane to the existing pavement surface.

- (b) **Stress Relief Membrane Placement.** The open grid woven polyester side of the material shall be placed up with the nonwoven side placed into the tack. The stress relief membrane shall be centered over the crack or joint on the existing surface and with a minimum of 6 in. (150 mm) of the membrane extending beyond the edges of the joint.

The material shall be laid smooth with no uplifted edges. The stress relief membrane shall be placed and rolled immediately with a riding static drum roller or a rubber tire roller. A maximum of three minutes shall pass between the first and second rolling efforts.

The stress relief membrane shall be butted where transverse and longitudinal joints meet or where two rolls must be joined. When required, the stress relief membrane shall be cut with a razor knife from the woven polyester side.

The stress relief membrane shall be placed at least two hours in advance of paving operations. If application must immediately precede the paving operation, hot-poured joint sealer may be required as a tack coat to bond the stress relief membrane to the existing surface.

- (c) **Traffic Exposure.** Exposing the membrane to traffic shall be minimized. Small amounts of washed sand may be used to blot excess asphalt cement tack coat when necessary to facilitate movement of traffic or construction equipment over the membrane prior to placement of the overlay. Damaged membranes shall be removed and replaced.
- (d) **Paving Tack Coat/Paving.** Paving operations shall only begin when the membrane is thoroughly bonded to the existing surface. The membrane may be exposed to moisture and rain prior to the application of the overlay, however, the stress relief membrane must be dry at the time the overlay is placed.

A slow-set emulsified asphalt paving tack coat (such as SS-1, SS-1h, CSS-1, or CSS-1h) shall be applied prior to paving over the membrane. Cutback asphalts shall not be used. Hot-mix asphalt or dry washed sand may be placed ahead of the paver if the membrane is sticking to the tires of the paving equipment. The minimum asphalt overlay thickness (total) shall be 2 in. (50 mm) compacted.

When using a vibratory roller for compaction, it shall be set to the lowest amplitude and highest frequency settings.”

Add the following Article to the Standard Specifications:

**“1062.04 Reflective Crack Control System D.** The stress relief membrane shall be 36 in. (900 mm) wide and 0.15 in. (4 mm) thick and shall be a system of materials manufactured in a composite three layer fashion with the following properties.

Stress Relief Membrane		
Property	Value	Test Method
Cold Flex	No cracking or separation of fabric	ASTM D 146 (modified)
Tensile Strength (Peak)	4,000 psi (700 N/mm) min.	ASTM D 412 (modified)
Elongation (at Peak Tensile)	10% min.	ASTM D 412 (modified)
Weight	0.76 lbs/sq ft (3.7 kg/sq m)	
Density (mastic)	69 lbs/cu ft (1100 kg/cu m) min.	ASTM D 70
Thickness	0.15 in. (4 mm)	ASTM E 154-93 Subsection 10.0 ASTM D 1790
Absorption (mastic)	1 % max.	ASTM D 517
Brittleness	Passes	ASTM D 517
Softening Point (mastic)	220 °F (104 °C)	ASTM D 36

The bottom layer of the composite shall be a low strength, nonwoven, geotextile and shall be according to AASHTO M 288-92. The bottom geotextile shall be designed to fully bond with the existing pavement with the help of a tack coat. It shall be capable of accommodating sufficiently large stresses at the joint/crack without breaking its bond with the slab. The middle layer of the composite shall be a viscoelastic membrane designed to prevent water entry into the pavement through the cracks and/or joints in the pavement. It also acts as a stress absorbing member interlayer between the overlay and the underlying pavement. The top layer shall be a high strength woven geotextile with a tensile strength of 4,000 psi (700 N/mm) at five percent strain according to ASTM D 4595. The top geotextile shall be designed to fully bond with the overlay and provide high stiffness and reinforcement to the overlay.

The stress relief membrane shall be stored in an inside enclosure with temperatures not exceeding 120 °F (49 °C). Any material that becomes wet prior to installation shall be removed from the jobsite and discarded.

The grade of asphalt binder tack coat shall be PG 64-22, PG 58-28, or PG 52-28 and shall meet the requirements of Article 1032.05.

Emulsified asphalt for tack coat shall be SS-1, SS-1h, CSS-1, CSS-1h, CSS1hP, or SS-1hP and shall meet the requirements of Article 1032.06.

The manufacturer shall furnish a certification with each shipment of stress relief membrane, stating the amount of product furnished, and that the material complies with these requirements.”

**REFLECTIVE SHEETING ON CHANNELIZING DEVICES (BDE)**

Effective: April 1, 2007

Revise the seventh paragraph of Article 1106.02 of the Standard Specifications to read:

“At the time of manufacturing, the retroreflective prismatic sheeting used on channelizing devices shall meet or exceed the initial minimum coefficient of retroreflection as specified in the following table. Measurements shall be conducted according to ASTM E 810, without averaging. Sheeting used on cones, drums and flexible delineators shall be reboundable as tested according to ASTM D 4956. Prestriped sheeting for rigid substrates on barricades shall be white and orange.

Initial Minimum Coefficient of Retroreflection candelas/foot candle/sq ft (candelas/lux/sq m) of material				
Observation Angle (deg.)	Entrance Angle (deg.)	White	Orange	Fluorescent Orange
0.2	-4	365	160	150
0.2	+30	175	80	70
0.5	-4	245	100	95
0.5	+30	100	50	40”

Revise the first sentence of the first paragraph of Article 1106.02(c) of the Standard Specifications to read:

“Barricades and vertical panels shall have alternating white and orange stripes sloping downward at 45 degrees toward the side on which traffic will pass.”

Revise the third sentence of the first paragraph of Article 1106.02(d) of the Standard Specifications to read:

“The bottom panels shall be 8 x 24 in. (200 x 600 mm) with alternating white and orange stripes sloping downward at 45 degrees toward the side on which traffic will pass.”

**STEEL PLATE BEAM GUARDRAIL (BDE)**

Effective: November 1, 2005

Revised: January 1, 2007

Revise the first paragraph of Article 1006.25 of the Standard Specifications to read:

**"1006.25 Steel Plate Beam Guardrail.** Steel plate beam guardrail, including bolts, nuts, and washers, shall be according to AASHTO M 180. Guardrails shall be Class A, with Type II coatings. The weight (mass) of the galvanized coating for each side of the guardrail shall be at least 2.00 oz/sq ft (610 g/sq m). The overall combined weight (mass) of the coating on both sides shall meet or exceed 4.00 oz/sq ft (1220 g/sq m). The thickness of the zinc or zinc alloy will be determined for each side using the average of at least three non-destructive test readings taken on that side of the guardrail. The minimum average thickness for each side shall be 3.1 mils (79 µm).”

### **SUBCONTRACTOR MOBILIZATION PAYMENTS (BDE)**

Effective: April 2, 2005

To account for the preparatory work and operations necessary for the movement of subcontractor personnel, equipment, supplies, and incidentals to the project site and for all other work or operations that must be performed or costs incurred when beginning work approved for subcontracting in accordance with Article 108.01 of the Standard Specifications, the Contractor shall make a mobilization payment to each subcontractor.

This mobilization payment shall be made at least 14 days prior to the subcontractor starting work. The amount paid shall be equal to 3 percent of the amount of the subcontract reported on form BC 260A submitted for the approval of the subcontractor's work.

This provision shall be incorporated directly or by reference into each subcontract approved by the Department.

### **THERMOPLASTIC PAVEMENT MARKINGS (BDE)**

Effective: January 1, 2007

Revise Article 1095.01(a)(2) of the Standard Specifications to read:

“(2) Pigment. The pigment used for the white thermoplastic compound shall be a high-grade pure (minimum 93 percent) titanium dioxide (TiO<sub>2</sub>). The white pigment content shall be a minimum of ten percent by weight and shall be uniformly distributed throughout the thermoplastic compound.

The pigments used for the yellow thermoplastic compound shall not contain any hazardous materials listed in the Environmental Protection Agency Code of Federal Regulations (CFR) 40, Section 261.24, Table 1. The combined total of RCRA listed heavy metals shall not exceed 100 ppm when tested by X-ray fluorescence spectroscopy. The pigments shall also be heat resistant, UV stable and color-fast yellows, golds, and oranges, which shall produce a compound which shall match Federal Standard 595 Color No. 33538. The pigment shall be uniformly distributed throughout the thermoplastic compound.”

Revise Article 1095.01(b)(1)e. of the Standard Specifications to read:

“e. Daylight Reflectance and Color. The thermoplastic compound after heating for four hours ± five minutes at 425 ± 3 °F (218.3 ± 2 °C) and cooled at 77 °F (25 °C) shall meet the following requirements for daylight reflectance and color, when tested, using a color spectrophotometer with 45 degree circumferential/zero degree geometry, illuminant C, and two degree observer angle. The color instrument shall measure the visible spectrum from 380 to 720 nm with a wavelength measurement interval and spectral bandpass of 10 nm.

White: Daylight Reflectance .....75 percent min.

\*Yellow: Daylight Reflectance .....45 percent min.

\*Shall meet the coordinates of the following color tolerance chart.

x	0.490	0.475	0.485	0.530
y	0.470	0.438	0.425	0.456"

Revise Article 1095.01(b)(1)k. of the Standard Specifications to read:

- “k. Accelerated Weathering. After heating the thermoplastic for four hours  $\pm$  five minutes at  $425 \pm 3$  °F ( $218.3 \pm 2$  °C) the thermoplastic shall be applied to a steel wool abraded aluminum alloy panel (Federal Test Std. No. 141, Method 2013) at a film thickness of 30 mils (0.70 mm) and allowed to cool for 24 hours at room temperature. The coated panel shall be subjected to accelerated weathering using the light and water exposure apparatus (fluorescent UV - condensation type) for 75 hours according to ASTM G 53 (equipped with UVB-313 lamps).

The cycle shall consist of four hours UV exposure at 122 °F (50 °C) followed by four hours of condensation at 104 °F (40 °C). UVB 313 bulbs shall be used. At the end of the exposure period, the panel shall not exceed 10 Hunter Lab Delta E units from the original material.”

## **TRAINING SPECIAL PROVISIONS**

This Training Special Provision supersedes Section 7b of the Special Provision entitled “Specific Equal Employment Opportunity Responsibilities,” and is in implementation of 23 U.S.C. 140(a).

As part of the contractor’s equal employment opportunity affirmative action program, training shall be provided as follows:

The contractor shall provide on-the-job training aimed at developing full journeyman in the type of trade or job classification involved. The number of trainees to be trained under this contract will be 1. In the event the contractor subcontracts a portion of the contract work, he shall determine how many, if any, of the trainees are to be trained by the subcontractor, provided however, that the contractor shall retain the primary responsibility for meeting the training requirements imposed by this special provision. The contractor shall also insure that this Training Special Provision is made applicable to such subcontract. Where feasible, 25 percent of apprentices or trainees in each occupation shall be in their first year of apprenticeship or training.

The number of trainees shall be distributed among the work classifications on the basis of the contractor’s needs and the availability of journeymen in the various classifications within the reasonable area of recruitment. Prior to commencing construction, the contractor shall submit to the Illinois Department of Transportation for approval the number of trainees to be trained in each selected classification and training program to be used. Furthermore, the contractor shall specify the starting time for training in each of the classifications. The contractor will be credited for each trainee employed by him on the contract work who is currently enrolled or becomes enrolled in an approved program and will be reimbursed for such trainees as provided hereinafter.

Training and upgrading of minorities and women toward journeyman status is a primary objective of this Training Special Provision. Accordingly, the contractor shall make every effort to enroll minority trainees and women (e.g. by conducting systematic and direct recruitment through public and private sources likely to yield minority and women trainees) to the extent such persons are available within a reasonable area of recruitment. The contractor will be responsible for demonstrating the steps that he has taken in pursuance thereof, prior to a determination as to whether the contractor is in compliance with this Training Special Provision. This training commitment is not intended, and shall not be used, to discriminate against any applicant for training, whether a member of a minority group or not.

No employee shall be employed as a trainee in any classification in which he has successfully completed a training course leading to journeyman status or in which he has been employed as a journeyman. The contractor should satisfy this requirement by including appropriate questions in the employee application or by other suitable means. Regardless of the method used the contractor's records should document the findings in each case.

The minimum length and type of training for each classification will be as established in the training program selected by the contractor and approved by the Illinois Department of Transportation and the Federal Highway Administration. The Illinois Department of Transportation and the Federal Highway Administration shall approve a program, if it is reasonably calculated to meet the equal employment opportunity obligations of the contractor and to qualify the average trainee for journeyman status in the classification concerned by the end of the training period. Furthermore, apprenticeship programs registered with the U.S. Department of Labor, Bureau of Apprenticeship and Training, or with a State apprenticeship agency recognized by the Bureau and training programs approved by not necessarily sponsored by the U.S. Department of Labor, Manpower Administration, Bureau of Apprenticeship and Training shall also be considered acceptable provided it is being administered in a manner consistent with the equal employment obligations of Federal-aid highway construction contracts. Approval or acceptance of a training program shall be obtained from the State prior to commencing work on the classification covered by the program. It is the intention of these provisions that training is to be provided in the construction crafts rather than clerk-typists or secretarial-type positions. Training is permissible in lower level management positions such as office engineers, estimators, timekeepers, etc., where the training is oriented toward construction applications. Training in the laborer classification may be permitted provided that significant and meaningful training is provided and approved by the Illinois Department of Transportation and the Federal Highway Administration. Some offsite training is permissible as long as the training is an integral part of an approved training program and does not comprise a significant part of the overall training.

Except as otherwise noted below, the contractor will be reimbursed 80 cents per hour of training given an employee on this contract in accordance with an approved training program. As approved by the Engineer, reimbursement will be made for training of persons in excess of the number specified herein. This reimbursement will be made even though the contractor receives additional training program funds from other sources, provided such other source does not specifically prohibit the contractor from receiving other reimbursement. Reimbursement for offsite training indicated above may only be made to the contractor where he does one or more of the following and the trainees are concurrently employed on a Federal-aid project; contributes to the cost of the training, provides the instruction to the trainee or pays the trainee's wages during the offsite training period.



No payment shall be made to the contractor if either the failure to provide the required training, or the failure to hire the trainee as a journeyman, is caused by the contractor and evidences a lack of good faith on the part of the contractor in meeting the requirement of this Training Special Provision. It is normally expected that a trainee will begin his training on the project as soon as feasible after start of work utilizing the skill involved and remain on the project as long as training opportunities exist in his work classification or until he has completed his training program.

It is not required that all trainees be on board for the entire length of the contract. A contractor will have fulfilled his responsibilities under this Training Special Provision if he has provided acceptable training to the number of trainees specified. The number trained shall be determined on the basis of the total number enrolled on the contract for a significant period.

Trainees will be paid at least 60 percent of the appropriate minimum journeyman's rate specified in the contract for the first half of the training period, 75 percent for the third quarter of the training period, and 90 percent for the last quarter of the training period, unless apprentices or trainees in an approved existing program are enrolled as trainees on this project. In that case, the appropriate rates approved by the Departments of Labor or Transportation in connection with the existing program shall apply to all trainees being trained for the same classification who are covered by this Training Special Provision.

The contractor shall furnish the trainee a copy of the program he will follow in providing the training. The contractor shall provide each trainee with a certification showing the type and length of training satisfactorily complete.

The contractor will provide for the maintenance of records and furnish periodic reports documenting his performance under this Training Special Provision.

**METHOD OF MEASUREMENT** The unit of measurement is in hours.

**BASIS OF PAYMENT** This work will be paid for at the contract unit price of 80 cents per hour for TRAINEES. The estimated total number of hours, unit price and total price have been included in the schedule of prices.

**BITUMINOUS MATERIALS COST ADJUSTMENTS (BDE) (RETURN FORM WITH BID)**

Effective: November 2, 2006

Revised: January 2, 2007

**Description.** For projects with at least 1200 tons (1100 metric tons) of work involving applicable bituminous materials, cost adjustments will be made to provide additional compensation to the Contractor, or credit to the Department, for fluctuations in the cost of bituminous materials when optioned by the Contractor. The adjustments shall apply to permanent and temporary hot-mix asphalt (HMA) mixtures, bituminous surface treatments (cover and seal coats), and pavement preservation type surface treatments. The adjustments shall not apply to bituminous prime coats, tack coats, crack filling/sealing, or joint filling/sealing.

The bidder shall indicate on the attached form whether or not this special provision will be part of the contract and submit the completed form with his/her bid. Failure to submit the form, or failure to fill out the form completely, shall make this contract exempt of bituminous materials cost adjustments.

Method of Adjustment. Bituminous materials cost adjustments will be computed as follows.

$$CA = (BPI_P - BPI_L) \times (\%AC_V / 100) \times Q$$

- Where: CA = Cost Adjustment, \$.  
BPI<sub>P</sub> = Bituminous Price Index, as published by the Department for the month the work is performed, \$/ton (\$/metric ton).  
BPI<sub>L</sub> = Bituminous Price Index, as published by the Department for the month prior to the letting, \$/ton (\$/metric ton).  
%AC<sub>V</sub> = Percent of virgin Asphalt Cement in the Quantity being adjusted. For HMA mixtures, the % AC<sub>V</sub> will be determined from the adjusted job mix formula. For bituminous materials applied, a performance graded or cutback asphalt will be considered to be 100% AC<sub>V</sub> and undiluted emulsified asphalt will be considered to be 65% AC<sub>V</sub>.  
Q = Authorized construction Quantity, tons (metric tons) (see below).

For HMA mixtures measured in square yards:  $Q, \text{ tons} = A \times D \times (G_{mb} \times 46.8) / 2000$ . For HMA mixtures measured in square meters:  $Q, \text{ metric tons} = A \times D \times (G_{mb} \times 24.99) / 1000$ . When computing adjustments for full-depth HMA pavement, separate calculations will be made for the binder and surface courses to account for their different  $G_{mb}$  and % AC<sub>V</sub>.

For bituminous materials measured in gallons:  $Q, \text{ tons} = V \times 8.33 \text{ lb/gal} \times SG / 2000$   
For bituminous materials measured in liters:  $Q, \text{ metric tons} = V \times 1.0 \text{ kg/L} \times SG / 1000$

- Where: A = Area of the HMA mixture, sq yd (sq m).  
D = Depth of the HMA mixture, in. (mm).  
G<sub>mb</sub> = Average bulk specific gravity of the mixture, from the approved mix design.  
V = Volume of the bituminous material, gal (L).  
SG = Specific Gravity of bituminous material as shown on the bill of lading.

Basis of Payment. Bituminous materials cost adjustments may be positive or negative but will only be made when there is a difference between the BPI<sub>L</sub> and BPI<sub>P</sub> in excess of five percent, as calculated by:

$$\text{Percent Difference} = \{(BPI_L - BPI_P) \div BPI_L\} \times 100$$

Bituminous materials cost adjustments will be calculated for each calendar month in which applicable bituminous material is placed; and will be paid or deducted when all other contract requirements for the items of work are satisfied. The adjustments shall not apply during contract time subject to liquidated damages for completion of the entire contract.

Return With Bid

**ILLINOIS DEPARTMENT  
OF TRANSPORTATION**

**OPTION FOR  
BITUMINOUS MATERIALS COST ADJUSTMENTS**

The bidder shall submit this completed form with his/her bid. Failure to submit the form, or failure to fill out the form completely, shall make this contract exempt of bituminous materials cost adjustments. After award, this form, when submitted, shall become part of the contract.

**Contract No.:** \_\_\_\_\_

**Company Name:** \_\_\_\_\_

**Contractor's Option:**

Is your company opting to include this special provision as part of the contract?

Yes  No

**Signature:** \_\_\_\_\_ **Date:** \_\_\_\_\_

DATE-TIME  
ADON-SPEC

# STATE OF ILLINOIS

## DEPARTMENT OF TRANSPORTATION

### PLANS FOR PROPOSED

### FAP 327 (US 50)

### SEC (16, 16NRM-Z, 16Z)RS-5

### MARION COUNTY

### RESURFACING

### PROJECT NO: F-0327(039)

### C-98-057-07

FOR INDEX OF SHEETS SEE SHEET NO. 2

BEGIN PROJECT LAT: 38.62327  
MILE STA. 0.000 LONG: -88.98111

R2E

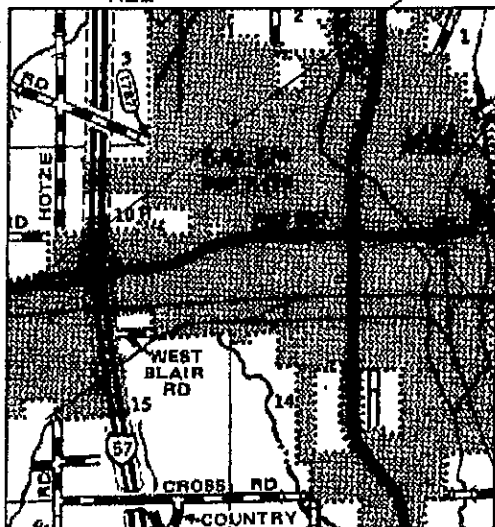

## LOCATION MAP

SCALE: NOT TO SCALE

TRAFFIC DATA  
2005 ADT = 17900  
SU = 3.4%  
MU = 5.3%

GROSS LENGTH OF SECTION: 1.987 MI.  
NET LENGTH OF SECTION: 1.987 MI.

CONTRACT NO. 76A80



LOCATION OF SECTION INDICATED THUS ■

D-98-053-07 PLANS PREPARED BY:  
COOMBE-BLOXDORF P.C.  
LICENSE NO. 184-002703

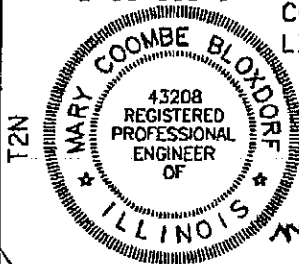

*Mary Coombe Bloxdorf*  
3-23-07  
Exp. 11-30-07

END PROJECT LAT: 38.62730  
MILE STA. 1.987 LONG: -88.93909

JOINT UTILITY LOCATION  
INFORMATION FOR EXCAVATIONS  
PHONE: (800) 892-0123

SUBMITTED March 23, 2007

Mary C. Jamieson  
DEPUTY DIRECTOR OF HIGHWAYS  
REGION FIVE ENGINEER

PASSED \_\_\_\_\_  
ENGINEER OF DESIGN & ENVIRONMENT

APPROVED \_\_\_\_\_  
DIRECTOR, DIVISION OF HIGHWAYS

PRINTED BY THE AUTHORITY OF THE STATE OF ILLINOIS  
PLOT DATE: <DATE-TIME>

PROJECT ENGINEER: PATTI LEBEAU (618) 346-3179  
SQUAD LEADER: CHERYL KEPLAR (618) 346-3186

GENERAL NOTES

TOTAL SHEETS	SHEET NO.
39	2

CONTRACT NO. 76A90

- THE STANDARDS AND REVISIONS NUMBERS LISTED SHALL APPLY TO THIS PROJECT.
  - ILLINOIS STATE LAW REQUIRES A 48-HOUR NOTICE BE GIVEN TO UTILITIES BEFORE DIGGING. FIELD MARKING OF FACILITIES MAY BE OBTAINED BY CONTACTING J.U.L.I.E. OR FOR NON-MEMBERS, THE UTILITY COMPANY DIRECTLY. AGENCIES KNOWN TO HAVE FACILITIES WITHIN THE PROJECT AREA AS FOLLOWS:
    - AMEREN IP (ELECTRIC)
    - ATMOS ENERGY (GAS)
    - CHARTER COMMUNICATIONS (CABLE TV)
    - CITY OF SALEM (WATER & SAN, SEWER, GAS)
    - AT&T ILLINOIS (COMMUNICATIONS)
    - TRI-COUNTY ELECTRIC COOPERATIVE (ELECTRIC)
    - US SONEET (COMMUNICATIONS)
- MEMBERS OF J.U.L.I.E. (800) 892-0123 ARE INDICATED BY \*. NON-J.U.L.I.E. MEMBERS MUST BE NOTIFIED INDIVIDUALLY.
- WHERE SECTION OR SUB-SECTION MONUMENTS ARE ENCOUNTERED THE ENGINEER SHALL BE NOTIFIED BEFORE SUCH MONUMENTS ARE REMOVED. THE CONTRACTOR SHALL PROTECT AND CAREFULLY PRESERVE ALL PROPERTY MARKERS AND MONUMENTS UNTIL THE OWNER, AN AUTHORIZED SURVEYOR, OR AGENT HAS WITNESSED OR OTHERWISE REFERENCED THE LOCATION.
  - THE THICKNESS OF THE HMA MIXTURE SHOWN ON THE PLANS IS THE NOMINAL THICKNESS. DEVIATIONS FROM THE NOMINAL THICKNESS WILL BE PERMITTED WHEN SUCH DEVIATIONS OCCUR DUE TO THE IRREGULARITIES IN THE EXISTING SURFACE OR BASE ON WHICH THE HMA MIXTURE IS PLACED.
  - THE RATES OF APPLICATION SHOWN IN THE PLANS ARE NOMINAL. DEVIATIONS WILL BE ALLOWED AS SPECIFIED BY THE ENGINEER IN ACCORDANCE WITH THE STANDARD SPECIFICATIONS.
  - THE FOLLOWING MIXTURE REQUIREMENTS ARE APPLICABLE FOR THIS PROJECT.

MIXTURE USE:	SURFACE	LEVEL BINDER	SHOULDERS	PATCHING
AC/PG:	SBS 70-22	PG 84-22	PG 58-22	PG 64-22
RAP % (MAX):	10%	10%	30%	10%
DESIGN AIR VOIDS:	4.0% @ Ndes=90	4.0% @ Ndes=90	2.0% @ Ndes=30	4.0% @ Ndes=90
MIX COMPOSITION:				
(GRADATION MIXTURE):				
FRICITION AGG.:	MIXTURE "D"	MIXTURE "C"	BAM	MIXTURE "C"

PLAN QUANTITIES FOR HMA SURFACE COURSE ARE CALCULATED USING A UNIT WEIGHT OF 112 LB/SY-IN (59.8KG/SO M - 25MM THICKNESS)

- ALL DIMENSIONS ARE IN FEET UNLESS OTHERWISE NOTED.
- FLAGMEN SHALL BE PRESENT DURING ALL CLOSURE HOURS INCLUDING LUNCH HOURS AND NO ADDITIONAL COMPENSATION WILL BE ALLOWED.
- NO OVERNIGHT LANE CLOSURES WILL BE ALLOWED ON THIS PROJECT.
- "ROAD CONSTRUCTION AHEAD" SIGNS SHALL BE PLACED AT THE BEGINNING AND END OF THE PROJECT PLUS THE INTERSECTING SIDE ROADS, AND WILL BE CONSIDERED INCLUDED IN THE TRAFFIC CONTROL PAY ITEMS. ALL CONSTRUCTION SIGNS SHALL BE FLUORESCENT ORANGE, 48" x 48".
- SHORT TERM PAVEMENT MARKING SHALL BE APPLIED TO THE MILLED, PRIMED, AND SURFACE COURSE. ONLY THE REMOVAL OF THE FINAL SURFACE APPLICATION WILL BE PAID FOR (WORK ZONE PAVEMENT MARKING REMOVAL - 50, FT.) AN AMOUNT OF TEMPORARY PAVEMENT MARKING WHICH EQUALS THE AMOUNT OF PERMANENT PAVEMENT MARKING HAS ALSO BEEN ADDED TO THE PLANS.
- THE CONTRACTOR SHALL VERIFY ALL DIMENSIONS AND CONDITIONS IN THE FIELD PRIOR TO CONSTRUCTION AND ORDERING MATERIALS.
- ALL SIDE ROADS AND ENTRANCES SHALL REMAIN OPEN.
- TEMPORARY RAMPS SHALL BE PROVIDED AT THE BEGINNING AND END OF THE RESURFACING SECTION.
- SAWCUTTING ON ALL EDGES FOR REMOVAL ITEMS SHALL BE INCLUDED IN THE COST OF THE REMOVAL ITEM AS INDICATED AND IN ACCORDANCE WITH THE STANDARD SPECIFICATIONS.
- ALL PATCHES SHALL BE COMPLETED DURING DAYLIGHT HOURS.
- THE AVERAGE MILLING DEPTH WILL BE 2 1/4". IT IS ESTIMATED TO HAVE 51,517 SQ. YDS. (6,491 TONS) OF HMA SURFACE REMOVAL. THE HMA SURFACE REMOVAL SHALL BE DELIVERED TO THE SALEM MAINTENANCE YARD AT 707 SOUTH MARION, SALEM, IL 62881. CONTACT JASON ROECKENHAUS AT 618/548-0463 2 DAYS PRIOR TO DELIVERY FOR EXACT DUMPING LOCATIONS. THIS WORK WILL NOT BE PAID FOR SEPERATELY BUT WILL BE INCLUDED IN THE CONTRACT UNIT PRICE FOR HMA SURFACE REMOVAL.
- THE EXISTING DETECTOR LOOP CONDUIT FROM PAVEMENT TO THE HANDHOLE WILL BE RE-USED FOR THE REPLACED LOOP. THE CONTRACTOR WILL BE RESPONSIBLE FOR PROTECTING THE EXISTING CONDUIT DURING CONSTRUCTION. SHOULD ANY DAMAGE TO THE CONDUIT OCCUR DUE TO THE OPERATIONS, REPAIR SHALL BE MADE TO THE SATISFACTION OF THE ENGINEER AND WILL BE DONE AT THE CONTRACTOR'S EXPENSE.

INDEX OF SHEETS

- COVER SHEET
- INDEX OF SHEETS, STANDARDS, AND GENERAL NOTES
- 4-8 SUMMARY OF QUANTITIES
- ROADWAY LAYOUT
10. TYPICAL SECTIONS
- 11-17. SCHEDULES
- JOINT & BIT. FEATHER DETAILS
- 19-22. DETECTOR LOOP LOCATIONS
23. DETECTOR LOOP PLAN SHEET
- 24-35. PAVEMENT MARKING DETAILS
- 36-39. GUARDRAIL DETAILS

STANDARDS

- |                      |           |
|----------------------|-----------|
| 00001-04             | 701602-02 |
| 442201-02            | 701701-04 |
| 701411-03            | 702001-06 |
| 701421-01            | 780001-01 |
| <del>701422-01</del> | 781001-02 |
| 701426-02            | 814001-01 |
| 701501-03            | 886001    |
| 701502-01            | 886006    |

COMMITMENTS

COMMITMENTS FOR THIS PROJECT ARE AS FOLLOWS: NONE

ILLINOIS DEPARTMENT OF TRANSPORTATION  
INDEX OF SHEETS, STANDARDS  
AND GENERAL NOTES

FAP 327 (US 50)  
SECTION (16, 16NRM-Z, 16Z)RS-5  
MARION COUNTY

PLOT DATE: \*DATE-TIME\*

\*DATE-TIME\*  
\*CON-SPEC\*  
\*REF\*  
\*REF\*

# SUMMARY OF QUANTITIES

TOTAL SHEETS	SHEET NO.
35	3
CONTRACT NO. 76ABD	

## MARION COUNTY CONSTRUCTION TYPE CODE

80% FEDERAL 20% STATE	50% CITY SALEM, IL 50% STATE
--------------------------	------------------------------------

CODE NO	ITEM	UNIT	TOTAL	URBAN ROADWAY 1000	URBAN ROADWAY 1000	URBAN ROADWAY 1000
40600200	BITUMINOUS MATERIALS (PRIME COAT)	TON	22.4	3.2	18.5	0.7
40600300	AGGREGATE (PRIME COAT)	TON	118.1	17.1	97.4	3.6
40600645	LEVELING BINDER (MACHINE METHOD), N90	TON	2630	359	2195	76
40600895	CONSTRUCTING TEST STRIP	EACH	1	0.5	0.5	
40600990	TEMPORARY RAMP	SQ YD	66	13	53	
40603545	POLYMERIZED HOT-MIX ASPHALT SURFACE COURSE, MIX "D", N90	TON	5009	718	4138	153
44000158	HOT-MIX ASPHALT SURFACE REMOVAL, 2 1/4"	SQ YD	51517	11660	38041	1816
44000500	COMBINATION CURB AND GUTTER REMOVAL	FOOT	135	135		
44002020	CONCRETE MEDIAN SURFACE REMOVAL	SQ FT	1909	1909		
44200140	PAVEMENT PATCHING, TYPE I, 12 INCH	SQ YD	56		56	
44200144	PAVEMENT PATCHING, TYPE II, 12 INCH	SQ YD	745	37	708	
44200148	PAVEMENT PATCHING, TYPE III, 12 INCH	SQ YD	112		112	
44200150	PAVEMENT PATCHING, TYPE IV, 12 INCH	SQ YD	140		140	
44300200	STRIP REFLECTIVE CRACK CONTROL TREATMENT	FOOT	1399	1399		
48203100	HOT-MIX ASPHALT SHOULDERS	TON	392	392		
60618300	CONCRETE MEDIAN SURFACE, 4 INCH	SQ FT	1909	1909		

## SUMMARY OF QUANTITIES

FAP 327 (US 50)  
SECTION (16, 16NRM-Z, 16Z)RS-5  
MARION COUNTY

*Rev.*

PLOT DATE: \*DATE-TIME\*

\*\*DATE\*\*  
\*DATE-TIME\*  
\*JOB-SPEC\*

# SUMMARY OF QUANTITIES

TOTAL SHEETS	SHEET NO.
35	4
CONTRACT NO. 176A80	

**MARION COUNTY  
CONSTRUCTION TYPE CODE**

80% FEDERAL 20% STATE	50% CITY (SALEM, IL) 50% STATE
--------------------------	--------------------------------------

CODE NO	ITEM	UNIT	TOTAL	<del>URBAN</del> ROADWAY 1000	URBAN ROADWAY 1000	URBAN ROADWAY <i>Y025</i>
63301210	REMOVE AND RE-ERECT STEEL PLATE BEAM GUARD RAIL, TYPE A	FOOT	420	420		
67000400	ENGINEER'S FIELD OFFICE, TYPE A	CAL MO	4	1	3	
67100100	MOBILIZATION	L SUM	1	0.5	0.5	
70100310	TRAFFIC CONTROL AND PROTECTION, STANDARD 701421	L SUM	1	0.5	0.5	
<i>70102620</i>	<i>TRAFFIC CONTROL AND PROTECTION, STANDARD 701501</i>	<i>L SUM</i>	<i>1</i>	<i>1</i>		
<i>70102622</i>	<i>TRAFFIC CONTROL AND PROTECTION, STANDARD 701502</i>	<i>L SUM</i>	<i>1</i>	<i>1</i>		
70100420	TRAFFIC CONTROL AND PROTECTION, STANDARD 701411	EACH	4	3	1	
70102632	TRAFFIC CONTROL AND PROTECTION, STANDARD 701602	L SUM	1		1	
70102635	TRAFFIC CONTROL AND PROTECTION, STANDARD 701701	L SUM	1		1	
70300100	SHORT-TERM PAVEMENT MARKING	FOOT	<i>5403</i>	<i>784</i>	<i>4619</i>	
70300220	TEMPORARY PAVEMENT MARKING - LINE 4"	FOOT	<i>59525</i>	<i>11710</i>	<i>47815</i>	
70301000	WORK ZONE PAVEMENT MARKING REMOVAL	SQ FT	<i>1927</i>	<i>224</i>	<i>1703</i>	
* 78000100	THERMOPLASTIC PAVEMENT MARKING - LETTERS AND SYMBOLS	SQ FT	1949	78	1871	

*\* SPECIALTY ITEMS*

## SUMMARY OF QUANTITIES

FAP 327 (US 50)  
SECTION (16, 16NRM-Z, 16Z)RS-5  
MARION COUNTY

*Rev.*

PLOT DATE: \*DATE-TIME\*

#DATE##  
 \*DATE-TIME\*  
 \*ORN-SPEC\*

# SUMMARY OF QUANTITIES

TOTAL SHEETS	SHEET NO.
35	4A
CONTRACT NO.: 7680	

MARION COUNTY  
CONSTRUCTION TYPE CODE

80% FEDERAL 20% STATE	50% CITY (SALEM, IL) 50% STATE
--------------------------	--------------------------------------

CODE NO	ITEM	UNIT	TOTAL	URBAN ROADWAY 1000	URBAN ROADWAY 1000	URBAN ROADWAY Y025
* 78000200	THERMOPLASTIC PAVEMENT MARKING - LINE 4"	FOOT	29762	5855	23907	
<del>* 78000400</del>	<del>THERMOPLASTIC PAVEMENT MARKING - LINE 6"</del>	<del>FOOT</del>	<del>3124</del>	<del>395</del>	<del>2729</del>	
* 78000600	THERMOPLASTIC PAVEMENT MARKING - LINE 12"	FOOT	1247	40	1207	
* 78000650	THERMOPLASTIC PAVEMENT MARKING - LINE 24"	FOOT	434	120	314	
* 78100100	RAISED REFLECTIVE PAVEMENT MARKER	EACH	425	35	390	
78300200	RAISED REFLECTIVE PAVEMENT MARKER REMOVAL	EACH	176	35	141	
* 88600600	DETECTOR LOOP REPLACEMENT	FOOT	2954		2954	
X4421000	PARTIAL DEPTH PATCHING	TON	238		238	
X4422030	PARTIAL DEPTH REMOVAL 3"	SQ YD	1418		1418	
© 20076600	TRAINEES	HOURL	500	500		

© Y08D  
\* SPECIALTY ITEMS

## SUMMARY OF QUANTITIES

FAP 327 (US 50)  
SECTION (16, 16NRM-Z, 16Z)RS-5  
MARION COUNTY

Rev. PLOT DATE: \*DATE-TIME\*

\*DATE-TIME\*  
\*CON-SPEC\*



TOTAL SHEETS	SHEET NO.
39	5
CONTRACT NO. 7680	

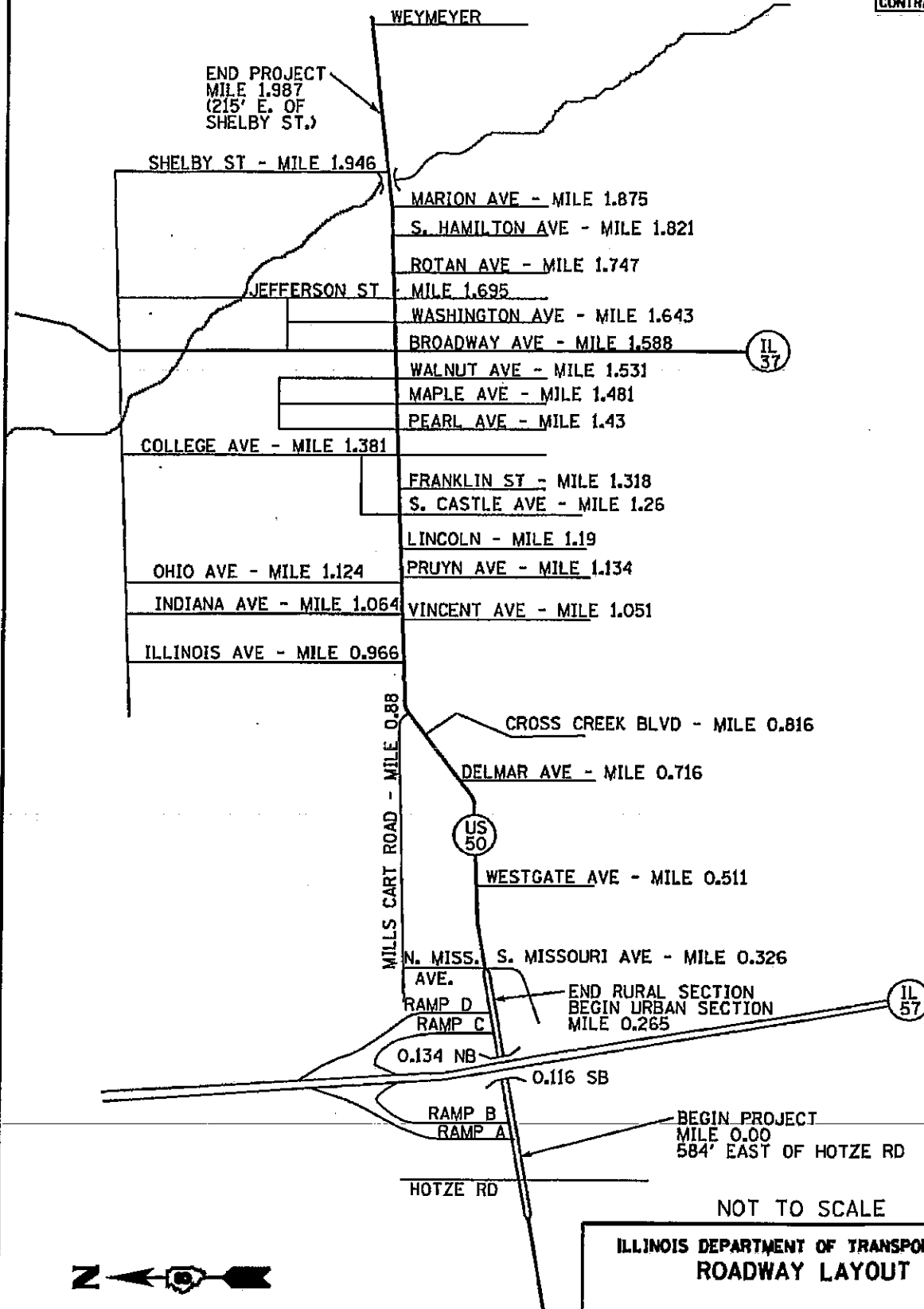

END PROJECT  
MILE 1.987  
(215' E. OF  
SHELBY ST.)

SHELBY ST - MILE 1.946

- MARION AVE - MILE 1.875
- S. HAMILTON AVE - MILE 1.821
- ROTAN AVE - MILE 1.747
- JEFFERSON ST - MILE 1.695
- WASHINGTON AVE - MILE 1.643
- BROADWAY AVE - MILE 1.588
- WALNUT AVE - MILE 1.531
- MAPLE AVE - MILE 1.481
- PEARL AVE - MILE 1.43

COLLEGE AVE - MILE 1.381

- FRANKLIN ST - MILE 1.318
- S. CASTLE AVE - MILE 1.26

OHIO AVE - MILE 1.124

- LINCOLN - MILE 1.19
- PRUYN AVE - MILE 1.134

INDIANA AVE - MILE 1.064

VINCENT AVE - MILE 1.051

ILLINOIS AVE - MILE 0.966

MILLS CART ROAD - MILE 0.88

CROSS CREEK BLVD - MILE 0.816

DELMAR AVE - MILE 0.716

US 50

WESTGATE AVE - MILE 0.511

N. MISS. AVE. S. MISSOURI AVE - MILE 0.326

RAMP D  
RAMP C

END RURAL SECTION  
BEGIN URBAN SECTION  
MILE 0.265

0.134 NB

0.116 SB

RAMP B  
RAMP A

BEGIN PROJECT  
MILE 0.00  
584' EAST OF HOTZE RD

HOTZE RD

NOT TO SCALE

ILLINOIS DEPARTMENT OF TRANSPORTATION  
ROADWAY LAYOUT

FAP 327 (US 50)  
SECTION (16, 16NRM-Z, 16Z)RS-5  
MARION COUNTY

PLOT DATE: DATE-TIME



DATE  
DATE-TIME  
DGN-SPEC  
REF  
REF

\*\*DATE\*\*  
 \*DATE-TIME\*  
 \*DGN-SPEC\*  
 \*REF\*  
 \*REF\*

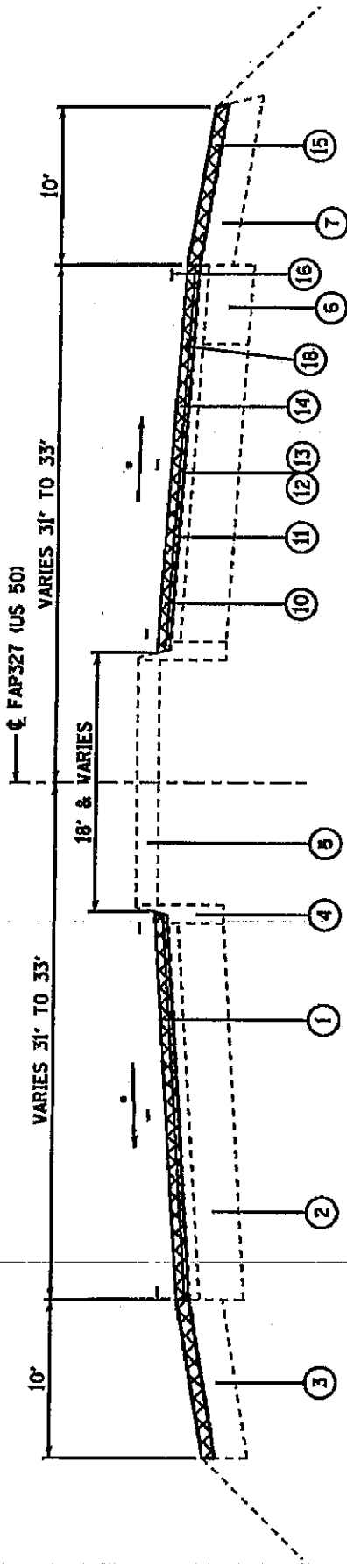

**TYPICAL SECTION 1 - RURAL**

MILE STA 0.000 TO 0.265

(AVG. TOTAL PVT WIDTH = 55')

**NOTE**

• MATCH EX SLOPE

**LEGEND**

- |   |   |   |   |
|---|---|---|---|
| ① | EX HMA CONCRETE SURFACE C&E, 3"                   | ⑩ | PR HMA SURFACE REMOVAL 2 1/4"                                       |
| ② | EX PAVEMENT, 9"                                   | ⑪ | PR LEVELING BINDER (MACHINE METHOD), MIX C 3/4"                     |
| ③ | EX STABILIZED SHOULDERS                           | ⑫ | PR BITUMINOUS MATERIALS (PRIME COAT)                                |
| ④ | EX COMBINATION CONCRETE C&G, TYPE B-6.06/B9.06    | ⑬ | PR AGGREGATE (PRIME COAT)   |
| ⑤ | EX CONCRETE MEDIAN SURFACE, 4"                    | ⑭ | PR HOT-MIX ASPHALT SURFACE COURSE, POLYMERIZED, MIX 'D', N90 1 1/2" |
| ⑥ | EX PORTLAND CEMENT CONC BASE CSE WIDENING, 8 1/2" | ⑮ | PR HOT-MIX ASPHALT SHOULDERS, 2-1/4"                                |
| ⑦ | EX HMA SHOULDER, 6"                               | ⑯ | PR PAVEMENT MARKING   |
| ⑧ | EX COMBINATION CONCRETE C&G, TYPE B-6.24          | ⑰ | PR RAISED REFLECTIVE PAVEMENT MARKERS                               |
| ⑨ | EX COMBINATION CONCRETE C&G, TYPE B-6.18          | ⑱ | PR STRIP REFLECTIVE CRACK CONTROL                                   |
|   |   |   | PR LEVELING BINDER (MACHINE METHOD), MIX C, 1"                      |

**ILLINOIS DEPARTMENT OF TRANSPORTATION  
TYPICAL SECTION**

FAP 327 (US 50)  
 SECTION (16, 16NRM-Z, 16Z)RS-5  
 MARION COUNTY

PLDT DATE: \*DATE-TIME\*

TOTAL SHEETS	SHEET NO.
39	6
CONTRACT NO. 76A80	

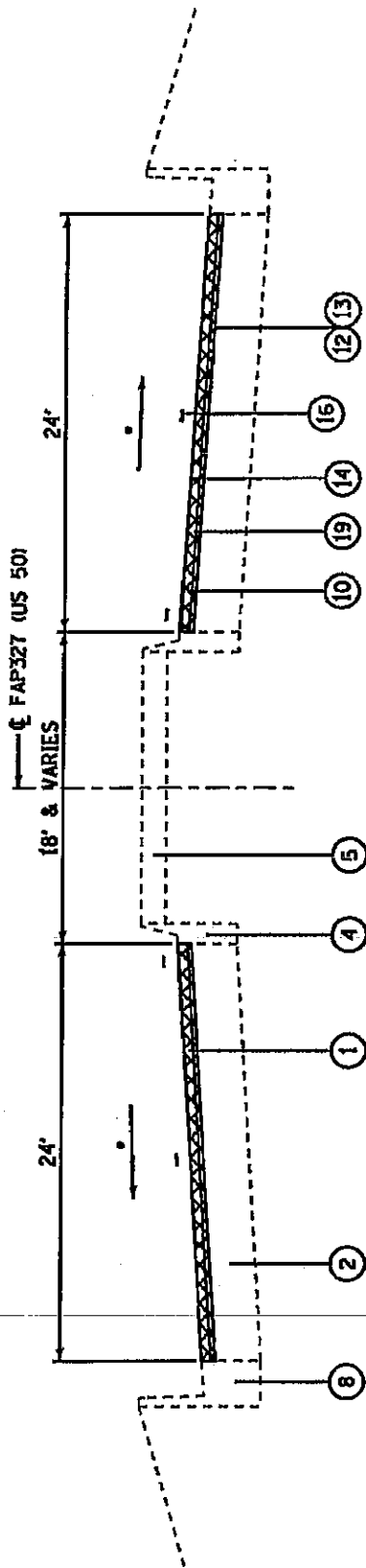

**TYPICAL SECTION 2 - URBAN**

MILE STA 0.265 TO 0.313  
(BEGINNING OF URBAN SECTION)  
(AVG TOTAL PVT WIDTH = 48')

**NOTE**

• MATCH EX SLOPE

**LEGEND**

- |   |   |   |   |  |
|---|---|---|---|--|
| ① | EX HMA CONCRETE SURFACE C&E, 3"                   | ⑩ | PR HMA SURFACE REMOVAL 2 1/4"                                       |  |
| ② | EX PAVEMENT, 9"                                   | ⑪ | PR LEVELING BINDER (MACHINE METHOD), MIX C, 3/4"                    |  |
| ③ | EX STABILIZED SHOULDERS                           | ⑫ | PR BITUMINOUS MATERIALS (PRIME COAT)                                |  |
| ④ | EX COMBINATION CONCRETE C&G, TYPE B-6.06/B9.06    | ⑬ | PR AGGREGATE (PRIME COAT)   |  |
| ⑤ | EX CONCRETE MEDIAN SURFACE, 4"                    | ⑭ | PR HOT-MIX ASPHALT SURFACE COURSE, POLYMERIZED, MIX 'D', NSO 1 1/2" |  |
| ⑥ | EX PORTLAND CEMENT CONC BASE CSE WIDENING, 8 1/2" | ⑮ | PR HOT-MIX ASPHALT SHOULDERS, 2-1/4"                                |  |
| ⑦ | EX HMA SHOULDER, 6"                               | ⑯ | PR PAVEMENT MARKING   |  |
| ⑧ | EX COMBINATION CONCRETE C&G, TYPE B-6.24          | ⑰ | PR RAISED REFLECTIVE PAVEMENT MARKERS                               |  |
| ⑨ | EX COMBINATION CONCRETE C&G, TYPE B-6.18          | ⑱ | PR STRIP REFLECTIVE CRACK CONTROL                                   |  |
|   |   |   | ⑲   | PR LEVELING BINDER (MACHINE METHOD), MIX C, 1" |

**ILLINOIS DEPARTMENT OF TRANSPORTATION  
TYPICAL SECTION**

FAP 327 (US 50)  
SECTION (16, 16NRM-Z, 16Z)RS-5  
MARION COUNTY

PLOT DATE: •DATE-TIME•

•DATE•  
•DATE-TIME•  
•DGN-SPEC•  
•REF•  
•REF•

\*\*DATE\*\*  
 \*DATE-TIME\*  
 \*CON-SPEC\*  
 \*REF\*  
 \*REF\*

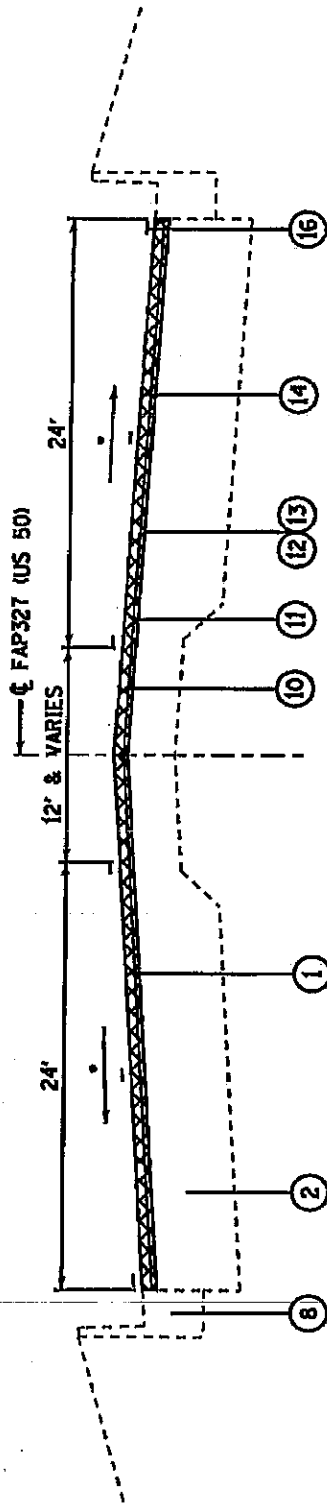

**TYPICAL SECTION 3 - URBAN**

MILE STA 0.313 TO 0.598  
 (TO WEST END CONCRETE PVT SEGMENT)

(TOTAL AVG PVT WIDTH = 59')

**NOTE**

- MATCH EX SLOPE

**LEGEND**

- |   |   |
|---|---|
| ① EX HMA CONCRETE SURFACE C&E, 3"                 | ⑩ PR HMA SURFACE REMOVAL 2-1/4"                                       |
| ② EX PAVEMENT, 9"                                 | ⑪ PR LEVELING BINDER (MACHINE METHOD), MIX C-3/4"                     |
| ③ EX STABILIZED SHOULDERS                         | ⑫ PR BITUMINOUS MATERIALS (PRIME COAT)                                |
| ④ EX COMBINATION CONCRETE C&G, TYPE B-6.06/B9.06  | ⑬ PR AGGREGATE (PRIME COAT)   |
| ⑤ EX CONCRETE MEDIAN SURFACE, 4"                  | ⑭ PR HOT-MIX ASPHALT SURFACE COURSE, POLYMERIZED, MIX 'D', NSU 1 1/2" |
| ⑥ EX PORTLAND CEMENT CONC BASE CSE WIDENING, 8/2" | ⑮ PR HOT-MIX ASPHALT SHOULDERS, 2-1/4"                                |
| ⑦ EX HMA SHOULDER, 6"                             | ⑯ PR PAVEMENT MARKING   |
| ⑧ EX COMBINATION CONCRETE C&G, TYPE B-6.24        | ⑰ PR RAISED REFLECTIVE PAVEMENT MARKERS                               |
| ⑨ EX COMBINATION CONCRETE C&G, TYPE B-6.18        | ⑱ PR STRIP REFLECTIVE CRACK CONTROL                                   |
|   | ⑲ PR LEVELING BINDER (MACHINE METHOD), MIX C, 1"                      |

ILLINOIS DEPARTMENT OF TRANSPORTATION  
TYPICAL SECTION

FAP 327 (US 50)  
 SECTION (16, 16NRM-Z, 16Z)RS-5  
 MARION COUNTY

PLOT DATE: \*DATE-TIME\*

TOTAL SHEETS	SHEET NO.
39	8
CONTRACT NO. 76A80	

\*\*DATE\*\*  
 \*DATE-TIME\*  
 \*CON-SPEC\*  
 \*REF\*  
 \*REF\*

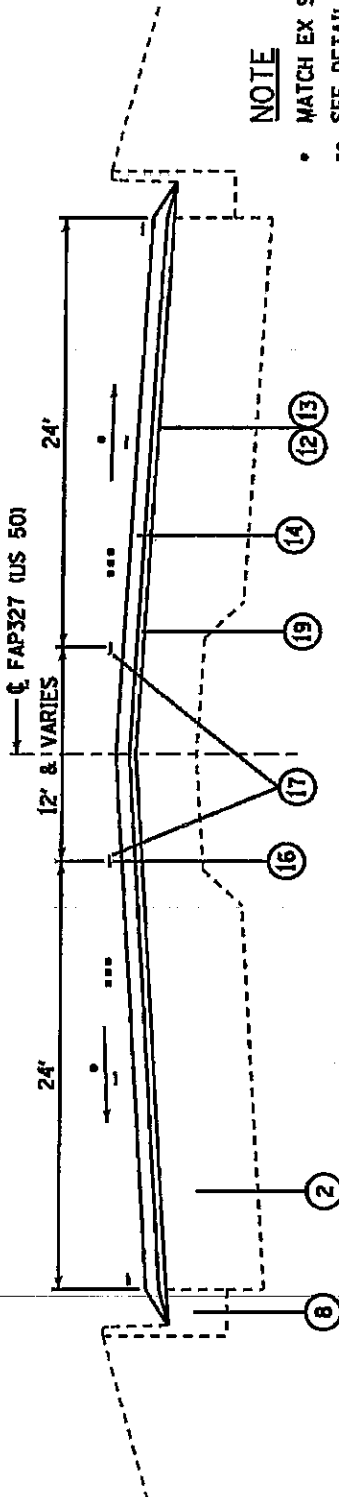

**NOTE**

- MATCH EX SLOPE
- \*\* SEE DETAIL - SHEET 18 OF 32 FOR DETAIL OF FEATHER AT CC&G
- \*\*\* THE CONTRACTOR SHALL MILL THE BITUMINOUS PATCHES THAT ARE 1/2" OR HIGHER PRIOR TO RESURFACING. THE COST FOR THIS WORK WILL BE INCLUDED WITH THE COST FOR HMA SURFACE REMOVAL PAY ITEM.

**TYPICAL SECTION 4 - URBAN**

MILE STA 0.598 TO 0.901  
 (EX BARE CONCRETE PAVEMENT SEGMENT)  
 (AVG TOTAL PVT WIDTH = 60')

**LEGEND**

- |   |    |  |    |    |  |
|---|----|--|----|----|--|
| 1 | EX | HMA CONCRETE SURFACE CSE, 3"                   | 10 | PR | HMA SURFACE REMOVAL 2/4"                                       |
| 2 | EX | PAVEMENT, 9"                                   | 11 | PR | LEVELING BINDER (MACHINE METHOD), MIX C, 3/4"                  |
| 3 | EX | STABILIZED SHOULDERS                           | 12 | PR | BITUMINOUS MATERIALS (PRIME COAT)                              |
| 4 | EX | COMBINATION CONCRETE C&G, TYPE B-6.06/B9.06    | 13 | PR | AGGREGATE (PRIME COAT)   |
| 5 | EX | CONCRETE MEDIAN SURFACE, 4"                    | 14 | PR | HOT-MIX ASPHALT SURFACE COURSE, POLYMERIZED, MIX 'D', N90 1/2" |
| 6 | EX | PORTLAND CEMENT CONC BASE CSE WIDENING, 8 1/2" | 15 | PR | HOT-MIX ASPHALT SHOULDERS, 2-1/4"                              |
| 7 | EX | HMA SHOULDER, 6"                               | 16 | PR | PAVEMENT MARKING   |
| 8 | EX | COMBINATION CONCRETE C&G, TYPE B-6.24          | 17 | PR | RAISED REFLECTIVE PAVEMENT MARKERS                             |
| 9 | EX | COMBINATION CONCRETE C&G, TYPE B-6.18          | 18 | PR | STRIP REFLECTIVE CRACK CONTROL                                 |
|   |    |  | 19 | PR | LEVELING BINDER (MACHINE METHOD), MIX C, 1"                    |

ILLINOIS DEPARTMENT OF TRANSPORTATION  
 TYPICAL SECTION  
 FAP 327 (US 50)  
 SECTION (16, 16NRM-Z, 16Z)RS-5  
 MARION COUNTY  
 PLOT DATE: \*DATE-TIME\*

TOTAL SHEETS	SHEET
39	9
CONTRACT NO. 76A80	

\*\*DATE\*\*  
 \*DATE-TIME\*  
 \*DGN-SPEC\*  
 \*REF\*  
 \*REF\*

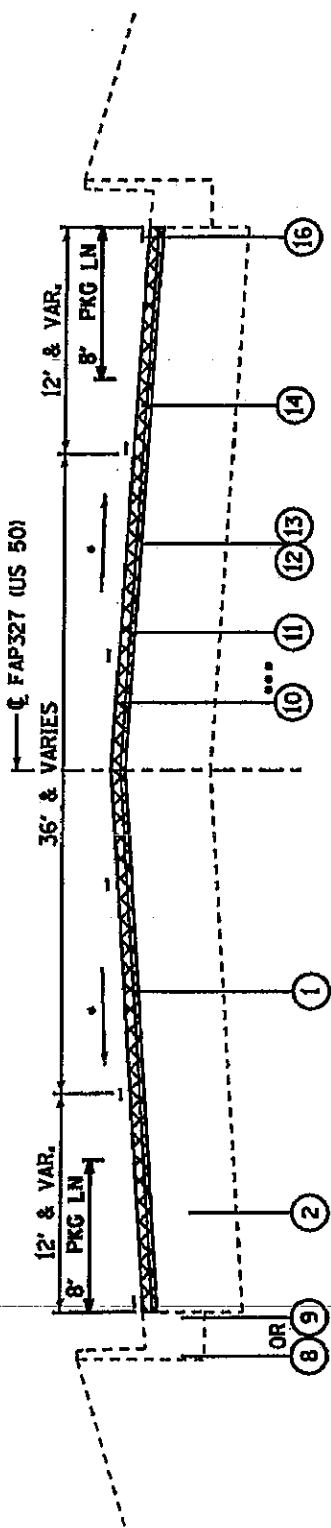

**TYPICAL SECTION 5 - URBAN**

MILE STA 0.901 TO 0.966  
 (ILLINOIS AVE)  
 (TOTAL AVG PVT WIDTH = 56.6')

MILE STA 1.318 TO 1.588  
 (FRANKLIN ST TO BROADWAY AVE)  
 (TOTAL AVG PVT WIDTH = 52.6')

MILE STA 1.695 TO 1.987  
 (JEFFERSON AVE TO EAST BUTT JOINT)  
 (TOTAL AVG PVT WIDTH = 36.4')

MILE STA 0.966 TO 1.318  
 (ILLINOIS AVE TO FRANKLIN ST)  
 (TOTAL AVG PVT WIDTH = 36.8')

MILE STA 1.588 TO 1.695  
 (BROADWAY AVE TO JEFFERSON AVE)  
 (TOTAL AVG PVT WIDTH = 65')

**NOTE**

- MATCH EX SLOPE
- \*\*\* OMIT MILLING AT SN 061-2021, MI STA 1.936 TO MI STA 1.943

**LEGEND**

- |   |   |   |   |
|---|---|---|---|
| ① | EX HMA CONCRETE SURFACE CSE, 3"                   | ⑩ | PR HMA SURFACE REMOVAL 2 1/4"                                       |
| ② | EX PAVEMENT, 9"                                   | ⑪ | PR LEVELING BINDER (MACHINE METHOD), MIX C, 3/4"                    |
| ③ | EX STABILIZED SHOULDERS                           | ⑫ | PR BITUMINOUS MATERIALS (PRIME COAT)                                |
| ④ | EX COMBINATION CONCRETE C&G, TYPE B-6.06/B9.06    | ⑬ | PR AGGREGATE (PRIME COAT)   |
| ⑤ | EX CONCRETE MEDIAN SURFACE, 4"                    | ⑭ | PR HOT-MIX ASPHALT SURFACE COURSE, POLYMERIZED, MIX 'D', N90 1 1/2" |
| ⑥ | EX PORTLAND CEMENT CONC BASE CSE WIDENING, 8 1/2" | ⑮ | PR HOT-MIX ASPHALT SHOULDERS, 2-1/4"                                |
| ⑦ | EX HMA SHOULDER, 6"                               | ⑯ | PR PAVEMENT MARKING   |
| ⑧ | EX COMBINATION CONCRETE C&G, TYPE B-6.24          | ⑰ | PR RAISED REFLECTIVE PAVEMENT MARKERS                               |
| ⑨ | EX COMBINATION CONCRETE C&G, TYPE B-6.18          | ⑱ | PR STRIP REFLECTIVE CRACK CONTROL                                   |
|   |   |   | PR LEVELING BINDER (MACHINE METHOD), MIX C, 1"                      |

ILLINOIS DEPARTMENT OF TRANSPORTATION  
TYPICAL SECTION

FAP 327 (US 50)  
SECTION (16, 16NRM-Z, 16Z)RS-5  
MARION COUNTY

PLOT DATE: \*DATE-TIME\*

TOTAL SHEETS	SHEET NO.
39	10
CONTRACT NO. 76A80	

SIGN SCHEDULE			
MILE	SIDE STREET NAME	SIGN PANEL TY 1 (R3-5R, 30"X36")	WOOD SIGN SUPPORT
		SQ FT	FOOT
1.353	COLLEGE AVE	7.5	15
1.615	BROADWAY AVE	7.5	15
TOTALS		15	30

SIGNS SHALL READ "RIGHT LANE MUST TURN RIGHT" AS NOTED IN THE PLANS

SHORT-TERM PAVEMENT MARKING SCHEDULE		
LOCATION	LENGTH	SHORT TERM
STATION TO STATION	(FT)	(FT)
TEMPORARY EDGE LINES MI STA 0.00 TO 0.265 STAGE I	1399.2	111.94
TEMPORARY EDGE LINES MI STA 0.00 TO 0.265 STAGE II	1399.2	111.94
SKIP-DASH LANE LINES MI STA 0.00 TO 0.265	1399.2	559.68
TOTAL RURAL		784
TEMPORARY LEFT-TURN LANE SEPARATIONS		982
SKIP-DASH LANE LINES MI STA 0.265 TO 1.987	9092.16	3636.86
TOTAL URBAN		4619
TOTAL		5403

PAVEMENT MARKING SCHEDULE												
LOCATION	THERMOPLASTIC PAVEMENT MARKING LINE									TEMPORARY MARKING LINE		
	LETTERS & SYMBOLS	YELLOW				WHITE					4" 2 APPS.	12" 2 APPS
		4" SKIP DASH 10'-30'	4" EDGE LINES	12" DIAGS	4" SKIP DASH 10'-30'	4" ABBR. SKIP DASH 2'-6"	4" EDGE OR PARKING LINES	12" CROSS WALK LINES	24" STOP BARS			
MILES	SQ FT	FT	FT	FT	FT	FT	FT	FT	FT	FT	FT	
RURAL												
0.000 to 0.265	78.0	0	2600	40	660		2595		120	11710	80	
URBAN												
0.265 to 0.511	249.6	48	2733	45	620	37.5	300		36	7477	90	
0.511 to 0.598	0.0	110	1008	45	220	37.5	100		36	2951	90	
0.598 to 0.716	62.4	290	1192		310					3584	0	
0.716 to 0.816	46.8	270	1040		264					3148	0	
0.816 to 0.880	72.8	110	880		184			100		2348	200	
0.880 to 0.901	0.0	0	0		60					100	0	
0.901 to 0.966	67.6	100	645	25		16	75	114	26	1670	278	
0.966 to 1.051	62.4	180	938	60				103	15	2236	328	
1.051 to 1.064	0.0	40	134							348	0	
1.064 to 1.318	218.4	620	2674	30						8588	60	
1.318 to 1.381	246.6		538			92.5				1261	430	
1.381 to 1.430	72.8		402			37.5	140		29	1169	0	
1.430 to 1.461	72.8		452			25	195			1344	0	
1.461 to 1.531	36.4		755	65		21.25	220			1992.5	130	
1.531 to 1.588	109.2		238				522		31	1620	0	
1.588 to 1.643	246.6		221			37.5	565		41	1647	0	
1.643 to 1.695	72.8		230			30	276	140	32	1072	280	
1.695 to 1.875	234.0	250	2242	90		32.5	135	100	24	5319	380	
1.875 to 1.946	0.0	30	920	75		15				1930	150	
1.946 to 1.987	0.0	60								120	0	
URBAN TOTAL	1871.2	2108	17242	435	1648	381.25	2628	772	314	47814.5	2414	
TOTAL QUANTITY	1949.2	2108	19842	475	2308	381	5123	772	434	59525	2494	

ILLINOIS DEPARTMENT OF TRANSPORTATION  
SCHEDULE OF QUANTITIES

FAP 327 (US 50)  
SECTION (16, 16NRM-Z, 16Z)RS-5  
MARION COUNTY

PLOT DATE: \*DATE-TIME\*

\*\*DATE\*\*  
\*DATE-TIME\*  
\*DSN-SPEC\*  
\*REF\*  
\*REF\*

REMOVE AND RE-ERECT STEEL PLATE BEAM GUARDRAIL			
APPROXIMATE LOCATION (MI STA)	LT/RT	BLOCK (INTERSECTION TO INTERSECTION)	GUARDRAIL TO BE ADJUSTED (FEET)
0.116 TO 0.134	LT	AT IL 57 OVERPASS STRUCTURES	210
0.116 TO 0.134	RT	AT IL 57 OVERPASS STRUCTURES	210
TOTAL			420

THE PROPOSED STEEL PLATE BEAM GUARDRAIL AND TRAFFIC BARRIER TERMINAL ITEMS INCLUDED IN THE PLANS SHALL COMPLY WITH THE DETAILS IN THE PLANS AND MANUFACTURER'S DETAILS IN ORDER TO MATCH THE EXISTING GUARDRAIL ELEMENTS THAT WERE ERECTED PRIOR TO JANUARY 1,

WORK ZONE PAVEMENT MARKING REMOVAL		
LOCATION	LENGTH (FT)	WK ZN REM (SQ. FT)
STATION TO STATION		
TEMPORARY EDGE LINES MI STA 0.00 TO 0.265 STAGE II	1399.2	37.31
LANE LINES MI STA 0.00 TO 0.265	1399.2	185.56
TOTAL RURAL		223.87
TEMPORARY LEFT-TURN LANE SEPARATIONS		491
LANE LINES MI STA 0.265 TO 1.987	9092.16	1212.29
TOTAL URBAN		1703.29
TOTAL		1927

DETECTOR LOOP SCHEDULE										
APPROX MI STA	OFFSET (FEET)	SIZE	LOOP LENGTH (FEET)	LOCATING UNDERGND CABLE (FEET)	CONCRETE HANDHOLE	1" PVC IN TRENCH (FEET)	TRENCH & BACKFILL FOR ELECTRICAL WORK (FEET)	REMOVAL OF EX JUNCTION BOXES	PHASE	REQUIRED NO. OF TURNS
0.466	12' RT	6 X 6	41		1	10	10	1	--	5
0.466	24' RT	6 X 6	34			10	10		--	5
0.501	0' RT	6 X 25 Quad	87			30	30		--	3-6-3
0.501	12' RT	6 X 40 Quad	132			25	25		--	3-6-3
0.501	24' RT	6 X 40 Quad	132	25					--	3-6-3
0.517	0' LT	6 X 50 Quad	202	25					--	3-6-3
0.517	12' LT	6 X 40 Quad	187			20	20		--	3-6-3
0.517	24' LT	6 X 40 Quad	142			20	20		--	3-6-3
0.555	12' LT	6 X 6	44		1	15	15	1	--	6
0.555	24' LT	6 X 6	39			15	15		--	6
0.907	12' RT	6 X 6	39		1	10	10	1	2	6
0.907	24' RT	6 X 6	29			10	10		2	6
0.961	7' RT	6 X 50 Quad	196	10					5	3-6-3
0.961	20' RT	6 X 40 Quad	150	10					2	3-6-3
0.973	10' LT	6 X 40 Quad	137	20					6	3-6-3
1.028	10' LT	6 X 6	30	10					6	5
1.335	10' RT	6 X 6	24						2	5
1.373	4' LT	6 X 35 Quad	117						2	3-6-3
1.373	7' RT	6 X 35 Quad	117						2	3-6-3
1.373	20' RT	6 X 35 Quad	117						2	3-6-3
1.388	4' LT	6 X 35 Quad	117						6	3-6-3
1.388	13' LT	6 X 35 Quad	117						6	3-6-3
1.424	10' LT	6 X 6	24						6	6
1.581	0' RT	6 X 40 Quad	132						--	3-6-3
1.581	10' RT	6 X 50 Quad	162						--	3-6-3
1.595	0' RT	6 X 40 Quad	132						--	3-6-3
1.595	10' LT	6 X 45 Quad	147						--	3-6-3
1.595	22' LT	6 X 45 Quad	147						--	3-6-3
TOTALS			2954	100	3	165	165	3		

ILLINOIS DEPARTMENT OF TRANSPORTATION  
SCHEDULE OF QUANTITIES

FAP 327 (US 50)  
SECTION (16, 16NRM-Z, 16ZIRS-5)  
MARION COUNTY

PLOT DATE: DATE-TIME

\*\*DATE\*\*  
\*DATE-TIME\*  
\*ION-SPEC\*  
\*REF\*  
\*REF\*



FULL DEPTH PATCHING SCHEDULE (EASTBOUND LANE)					
LOCATION (MILE)	SIZE	TYPE I	TYPE II	TYPE III	TYPE IV
		SQ YD	SQ YD	SQ YD	SQ YD
0.126	7 X 12 INSIDE		9.3		
0.126	7 X 12 OUTSIDE		9.3		
0.145	6 X 12 OUTSIDE		8.0		
0.149	4 X 12 INSIDE		5.3		
0.149	4 X 12 OUTSIDE		5.3		
0.286	4 X 12 INSIDE		5.3		
0.286	4 X 12 OUTSIDE		5.3		
0.342	10 X 6 OUTSIDE		6.7		
0.61	6 X 12 OUTSIDE		8.0		
0.613	7 X 12 INSIDE		9.3		
0.618	10 X 12		13.3		
0.753	6 X 6	4.0			
0.78	4 X 12 INSIDE		5.3		
0.78	4 X 6 OUTSIDE	2.7			
0.825	4 X 6	2.7			
0.917	32 X 12 OUTSIDE				42.7
0.924	15 X 12 OUTSIDE			20.0	
0.955	4 X 12 OUTSIDE		5.3		
0.955	4 X 9.5 INSIDE	4.2			
0.866	8 X 12		10.7		
0.972	18 X 6		12.0		
1.02	10 X 6		6.7		
1.057	10 X 6		6.7		
1.089	20 X 6		13.3		
1.089	6 X 8 INSIDE		5.3		
1.214	8 X 12		10.7		
1.214	10 X 6 INSIDE		6.7		
1.359	4 X 13		5.8		
1.359	4 X 16		7.1		
1.377	8 X 6	4.0			
1.377	6 X 12		8.0		
1.377	6 X 12		8.0		
1.413	4 X 13		5.8		
1.418	8 X 14		9.3		
1.42	6 X 14		9.3		
1.442	6 X 14		9.3		
1.454	6 X 30			20.0	
1.461	6 X 21		14.0		
1.491	4 X 12		5.3		
1.491	4 X 14 EB DRIVING LANE		6.2		
1.505	4 X 12		5.3		
1.505	4 X 12		5.3		
1.52	10 X 6		6.7		
1.683	4 X 12		5.3		
1.702	4 X 12		5.3		
1.702	4 X 12		5.3		
1.724	5 X 12		6.7		
1.734	5 X 30			16.7	
1.757	4 X 12		5.3		
1.757	4 X 13		5.8		
1.809	4 X 30		13.3		
1.809	4 X 10	4.4			
1.836	4 X 10	4.4			
1.909	4 X 12		5.3		
1.944	4 X 18		8.0		
1.948	6 X 30				28.7
2.03	6 X 16 BUTT JOINT		10.7		
SUBTOTAL EASTBOUND		28.4	344.2	58.7	69.4

ILLINOIS DEPARTMENT OF TRANSPORTATION  
SCHEDULE OF QUANTITIES

FAP 327 (US 50)  
SECTION (16, 16NRM-Z, 16Z)RS-5  
MARION COUNTY

PLOT DATE: DATE-TIME

\*\*DATE\*\*  
\*DATE-TIME\*  
\*DGN-SPEC\*  
\*REF\*  
\*REF\*

**FULL DEPTH PATCHING SCHEDULE (WESTBOUND LANE)**

LOCATION (MILE)	SIZE	TYPE I	TYPE II	TYPE III	TYPE IV
		SQ YD	SQ YD	SQ YD	SQ YD
0.312	6 X 12 OUTSIDE		8.0		
0.318	32 X 12 OUTSIDE				42.7
0.318	6 X 12 INSIDE		8.0		
0.335	4 X 12 INSIDE		5.3		
0.339	6 X 12 OUTSIDE		8.0		
0.353	4 X 24		10.7		
0.539	5 X 12		6.7		
0.708	10 X 6		6.7		
0.718	6 X 18 OUTSIDE		12.0		
0.718	6 X 18 INSIDE		12.0		
0.955	4 X 9.5 OUTSIDE	4.2			
0.955	4 X 12 INSIDE		5.3		
0.988	8 X 18			16.0	
0.988	8 X 18 ILLINOIS ST.		12.0		
1.113	4 X 8	3.6			
1.215	6 X 12		8.0		
1.215	12.5 X 12			16.6	
1.216	15 X 6		10.0		
1.344	5 X 8	4.4			
1.359	13 X 6		8.7		
1.359	13 X 6		8.7		
1.383	5 X 8	3.3			
1.377	11 X 6		7.3		
1.389	4 X 24 COLLEGE ST		10.7		
1.421	6 X 12		8.0		
1.421	4 X 12		5.3		
1.453	6 X 12		8.0		
1.453	4 X 12		5.3		
1.492	4 X 12		5.3		
1.508	4 X 12		5.3		
1.683	4 X 12		5.3		
1.746	5 X 12		6.7		
1.746	6 X 12		8.0		
1.787	4 X 12		5.3		
1.808	5 X 12		6.7		
1.808	6 X 12		8.0		
1.922	5 X 20		11.1		
1.924	4 X 17		7.6		
2.03	6 X 4.8	2.9			
2.03	8 X 12.2		8.1		
<b>SUBTOTAL WESTBOUND</b>		<b>18.4</b>	<b>252.1</b>	<b>32.6</b>	<b>42.7</b>
<b>SUBTOTAL EASTBOUND</b>		<b>28.4</b>	<b>344.2</b>	<b>58.7</b>	<b>69.4</b>
<b>25% CONTINGENCY AMOUNT</b>		<b>11.2</b>	<b>149.1</b>	<b>22.3</b>	<b>28.0</b>
<b>TOTAL PATCHING QUANTITY</b>		<b>56.0</b>	<b>745.4</b>	<b>111.6</b>	<b>140.1</b>

RURAL SHOULDER SCHEDULE		
MILE	HMA SURFACE REM, 2-1/4"	HMA SHOULDERS, BAM, N30, 2-1/4"
	SQ YD	TON
0.000 to 0.265	3109.38	391.8
<b>RURAL TOTAL</b>	<b>3109</b>	<b>392</b>

**ILLINOIS DEPARTMENT OF TRANSPORTATION  
SCHEDULE OF QUANTITIES**

FAP 327 (US 50)  
SECTION (16, 16NRM-Z, 16Z)RS-5  
MARION COUNTY

PLOT DATE: \*DATE-TIME\*

\*\*DATE\*\*  
 \*DATE-TIME\*  
 \*DGN-SPEC\*  
 \*REF\*  
 \*REF\*

STRIP REFLECTIVE CRACK CONTROL TREATMENT	
LOCATION	LENGTH
MI STA TO MI STA	(FT)
MI STA 0.00 TO STA 0.265	1399.2
TOTAL	1399

TEMPORARY RAMP SCHEDULE	
MILE STATION	TEMPORARY RAMP
	SQ. YDS
0.000 to 0.003	13
0.595 to 0.598	23
0.901 to 0.904	23
1.984 to 1.987	7
TOTAL	66

PARKING LANE RESURFACING SCHEDULE						
MILE	HMA SURFACE REM. 2-1/4"	BIT. MATL. PR CT	AGG PR CT	LEVELING BINDER (MACHINE METHOD) SUPERPAVE N90	HMA SURFACE COURSE, MIX "D", N90	REMARKS
	SQ. YD.	TON	TON	TON	TON	
1.430 to 1.481	80	0.0	0.2	3.4	6.7	PEARL TO MAPLE
1.481 to 1.531	409.8	0.2	0.8	17.2	34.4	MAPLE TO WALNUT
1.531 to 1.588	460.4	0.2	0.9	19.3	38.7	WALNUT TO BROADWAY
1.588 to 1.643	448	0.2	0.9	18.8	37.6	BROADWAY TO WASHINGTON
1.643 to 1.695	417.8	0.2	0.8	17.5	35.1	WASHINGTON TO JEFFERSON
URBAN TOTAL	1816	0.7	3.6	76	153	

RESURFACING SCHEDULE						
MILE	HMA SURFACE REM. 2-1/4"	BIT. MATL. PR CT	AGG PR CT	LEVELING BINDER (MACHINE METHOD) SUPERPAVE N90	HMA SURFACE COURSE, MIX "D", N90	REMARKS
	SQ. YD.	TON	TON	TON	TON	
<b>RURAL</b>						
0.003 to 0.265	855.1	3.2	17.1	359.1	718.3	TO END OF RURAL
RURAL TOTAL	855.1	3.2	17.1	359.1	718.3	
<b>URBAN</b>						
0.265 to 0.511	8514.88	3.2	17.0	357.8	715.2	TO WESTGATE
0.511 to 0.598	3062.4	1.2	6.1	128.6	280.6	TO W END CONC PVMT
0.598 to 0.718		1.8	8.3	232.6	348.9	TO DELMAR
0.718 to 0.816		1.3	7.0	197.1	295.7	TO CROSS CREEK
0.816 to 0.880		0.9	4.5	126.2	189.2	TO MILLS CART
0.880 to 0.901		0.3	1.5	41.4	62.1	TO E END CONC PVMT
0.901 to 0.966	2158.95	0.8	4.3	90.7	204.6	TO ILLINOIS
0.966 to 1.051	1795.2	0.7	3.6	75.4	150.8	TO S VINCENT
1.051 to 1.084	277.61	0.1	0.6	11.7	23.3	TO INDIANA
1.084 to 1.318	5588	2.1	11.2	234.7	469.4	TO FRANKLIN
1.318 to 1.381	1848	0.7	3.7	77.6	155.2	TO COLLEGE
1.381 to 1.430	1494.83	0.8	3.0	62.8	125.8	TO PEARL
1.430 to 1.481	1475.84	0.8	3.0	62.0	124.0	TO MAPLE
1.481 to 1.531	1158.62	0.4	2.3	48.6	97.2	TO WALNUT
1.531 to 1.588	1365.38	0.5	2.7	57.3	114.7	TO BROADWAY
1.588 to 1.643	1648.33	0.8	3.3	89.3	188.5	TO WASHINGTON
1.643 to 1.695	1565.16	0.8	3.1	65.7	131.5	TO JEFFERSON
1.695 to 1.875	3960	1.5	7.9	185.3	332.6	TO MARION
1.875 to 1.946	1311.2	0.5	2.6	55.1	110.1	TO SHELBY
1.946 to 1.987	818.15	0.3	1.6	34.4	68.7	TO E BUTT JOINT
URBAN TOTAL	38041	18.5	97.4	2195	4138	
PARKING LANE TOTAL	1816	0.7	3.6	76	153	
TOTAL	48408	22	118	2630	5009	

ILLINOIS DEPARTMENT OF TRANSPORTATION  
SCHEDULE OF QUANTITIES

FAP 327 (US 50)  
SECTION (16, 16NRM-Z, 16Z)RS-5  
MARION COUNTY

PLOT DATE: \*DATE-TIME\*

\*\*DATE\*\*  
\*DATE-TIME\*  
\*IGN-SPEC\*  
\*REF\*  
\*REF\*

REMOVE AND REPLACE CONCRETE MEDIAN SURFACE, 4"			
APPROXIMATE LOCATION (MI STA)	SIZE OF MEDIAN SURFACE TO BE REPAIRED	MEDIAN SURFACE REMOVAL AREA SQ FT	CONCRETE MEDIAN SURFACE, 4" SQ FT
0.042	12' X 3'	36	36
	9' X 3'	9	9
	4' X 5'	20	20
	15' X 5'	75	75
	7' X 5'	35	35
	4' X 2'	8	8
0.061	45' X 6'	270	270
	15' X 6'	90	90
	2' X 2'	4	4
	1' X 1'	1	1
	2' X 2'	4	4
	1' X 1'	1	1
	48' X 12'	576	576
0.08	36' X 12'	432	432
	1' X 4'	4	4
	3' X 4'	12	12
	1' X 1'	1	1
	2' X 1'	2	2
	11' X 7'	77	77
0.099	8' X 3'	24	24
	1' X 1'	1	1
0.099	1' X 4'	4	4
	1' X 1'	1	1
	1' X 1'	1	1
0.118	0	0	0
0.137	3' X 8'	24	24
0.156	2.5' X 1'	2.5	2.5
	2' X 2'	4	4
	1' X 1'	1	1
0.175	2' X 1'	2	2
	3.5' X 3'	10.5	10.5
	3.5' X 1'	3.5	3.5
	1' X 6'	5	5
	3.5' X 7'	24.5	24.5
	3.5' X 2'	7	7
0.194	3.5' X 14'	49	49
	3.5' X 11'	38.5	38.5
	3.5' X 6'	21	21
	3.5' X 1'	3.5	3.5
0.198	3.5' X 7'	24.5	24.5
TOTALS		1909	1909

RAISED REFLECTIVE PAVEMENT MARKER SCHEDULE		
MILE	R.R.P.M.	R.R.P.M. REMOVAL
	EACH	EACH
RURAL		
0.00 TO 0.265	35	35
URBAN		
0.265 TO 0.598	44	44
0.598 TO 0.716	32	32
0.716 TO 0.816	26	26
0.816 TO 0.88	18	16
0.88 TO 0.901	6	6
0.901 TO 0.966	17	17
0.966 TO 1.531	150	
1.531 TO 1.875	91	
1.875 TO 1.987	8	
URBAN TOTAL	390	141
TOTALS	425	176

ILLINOIS DEPARTMENT OF TRANSPORTATION  
**SCHEDULE OF QUANTITIES**

FAP 327 (US 50)  
SECTION (16, 16NRM-Z, 16Z)RS-5  
MARION COUNTY

PLOT DATE: \*DATE-TIME\*

\*\*DATE\*\*  
\*DATE-TIME\*  
\*CON-SPEC\*  
\*REF\*  
\*REF\*

CONCRETE CURB AND GUTTER REPAIR					
APPROXIMATE LOCATION (MI STA)	LT/RT	BLOCK (INTERSECTION TO INTERSECTION)	REMOVAL LENGTH FEET	CC&G TY B8.06 FEET	CC&G TY B9.06 FEET
0.063	CENTER - RT	NEAR IL 57 OVERPASS	3	3	
0.065	CENTER - RT	NEAR IL 57 OVERPASS	3	3	
0.076	CENTER - LT	NEAR IL 57 OVERPASS	6	6	
0.084	CENTER - LT	NEAR IL 57 OVERPASS	3	3	
0.094	CENTER - RT	NEAR IL 57 OVERPASS	7	7	
0.119	CENTER - RT	NEAR IL 57 OVERPASS	3		3
0.123	CENTER - RT	NEAR IL 57 OVERPASS	3		3
0.131	CENTER - RT	NEAR IL 57 OVERPASS	5		5
0.176	CENTER - RT	NEAR IL 57 OVERPASS	36		36
0.183	CENTER - RT	NEAR IL 57 OVERPASS	9	9	
0.187	CENTER - RT	NEAR IL 57 OVERPASS	8	8	
0.193	CENTER - RT	NEAR IL 57 OVERPASS	8	8	
0.197	CENTER - RT	NEAR IL 57 OVERPASS	6	6	
0.224	CENTER - RT	NEAR IL 57 OVERPASS	5	5	
ADDITIONAL QUANTITY FOR ANTICIPATED FAILURES			30	15	15
TOTAL			136	73	62

PARTIAL DEPTH PATCHING SCHEDULE					
LOCATION (MILE)	LANE	LENGTH	WIDTH	PARTIAL DEPTH REMOVAL, 3"	PARTIAL DEPTH PATCHING, 3"
		FEET	FEET	SQ YD	TON
0.598 - 0.617	EAST BOUND	100	4	44.4	7.5
0.617 - 0.636	EAST BOUND	100	4	44.4	7.5
0.636 - 0.655	EAST BOUND	100	4	44.4	7.5
0.655 - 0.674	EAST BOUND	100	4	44.4	7.5
0.674 - 0.693	EAST BOUND	100	4	44.4	7.5
0.693 - 0.712	EAST BOUND	100	4	44.4	7.5
0.712 - 0.731	EAST BOUND	100	4	44.4	7.5
0.731 - 0.75	EAST BOUND	100	4	44.4	7.5
0.75 - 0.769	EAST BOUND	100	4	44.4	7.5
0.769 - 0.788	EAST BOUND	100	4	44.4	7.5
0.788 - 0.807	EAST BOUND	100	4	44.4	7.5
0.807 - 0.826	EAST BOUND	100	4	44.4	7.5
0.826 - 0.845	EAST BOUND	100	4	44.4	7.5
0.845 - 0.864	EAST BOUND	100	4	44.4	7.5
0.864 - 0.883	EAST BOUND	100	4	44.4	7.5
0.883 - 0.901	EAST BOUND	95.04	4	42.2	7.1
0.598 - 0.617	WEST BOUND	100	4	44.4	7.5
0.617 - 0.636	WEST BOUND	100	4	44.4	7.5
0.636 - 0.655	WEST BOUND	100	4	44.4	7.5
0.655 - 0.674	WEST BOUND	100	4	44.4	7.5
0.674 - 0.693	WEST BOUND	100	4	44.4	7.5
0.693 - 0.712	WEST BOUND	100	4	44.4	7.5
0.712 - 0.731	WEST BOUND	100	4	44.4	7.5
0.731 - 0.75	WEST BOUND	100	4	44.4	7.5
0.75 - 0.769	WEST BOUND	100	4	44.4	7.5
0.769 - 0.788	WEST BOUND	100	4	44.4	7.5
0.788 - 0.807	WEST BOUND	100	4	44.4	7.5
0.807 - 0.826	WEST BOUND	100	4	44.4	7.5
0.826 - 0.845	WEST BOUND	100	4	44.4	7.5
0.845 - 0.864	WEST BOUND	100	4	44.4	7.5
0.864 - 0.883	WEST BOUND	100	4	44.4	7.5
0.883 - 0.901	WEST BOUND	95.04	4	42.2	7.1
TOTAL PARTIAL DEPTH PATCHING QUANTITY				1417.8	238.2

ILLINOIS DEPARTMENT OF TRANSPORTATION  
SCHEDULE OF QUANTITIES

FAP 327 (US 50)  
SECTION (16, 16NRM-Z, 16Z)RS-5  
MARION COUNTY

PLOT DATE: \*DATE-TIME\*

\*DATE\*  
\*DATE-TIME\*  
\*DRAWING SPEC\*  
\*REF\*  
\*REF\*

JOINT DETAIL

TOTAL SHEETS	SHEET NO.
39	18
CONTRACT NO. T6AB0	

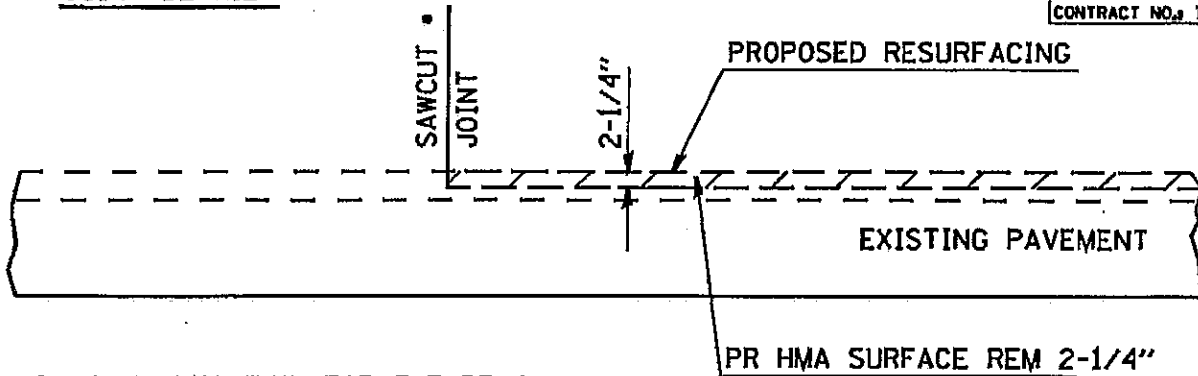

- SAWCUTS REQUIRED FOR THE REMOVAL OF EXISTING BITUMINOUS WILL NOT BE PAID FOR SEPARATELY BUT WILL BE INCLUDED IN THE COST OF THE REMOVAL ITEM.

RAMP DETAIL

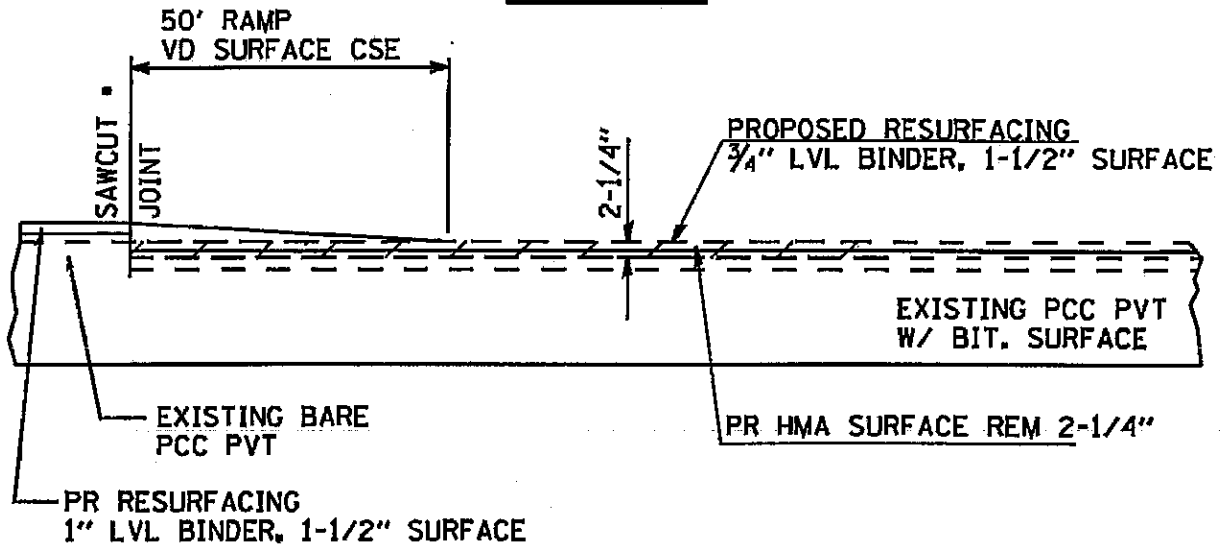

HMA FEATHER DETAIL

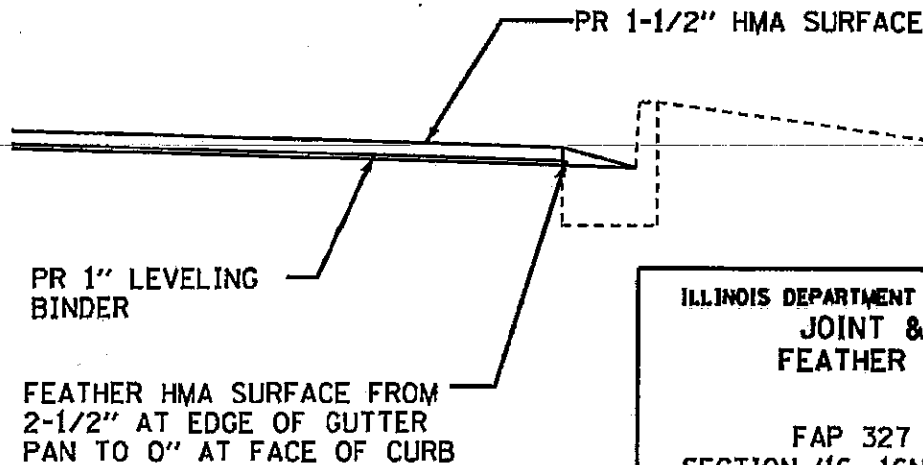

ILLINOIS DEPARTMENT OF TRANSPORTATION  
JOINT & HMA  
FEATHER DETAILS

FAP 327 (US 50)  
SECTION (16, 16NRM-Z, 16Z)RS-5  
MARION COUNTY

PLOT DATE: \*DATE-TIME\*

\*\*DATE\*\*  
\*DATE-TIME\*  
\*CON-SPEC\*  
\*REF\*  
\*REF\*

TOTAL SHEETS	SHEET NO.
39	19
CONTRACT NO. 76A80	

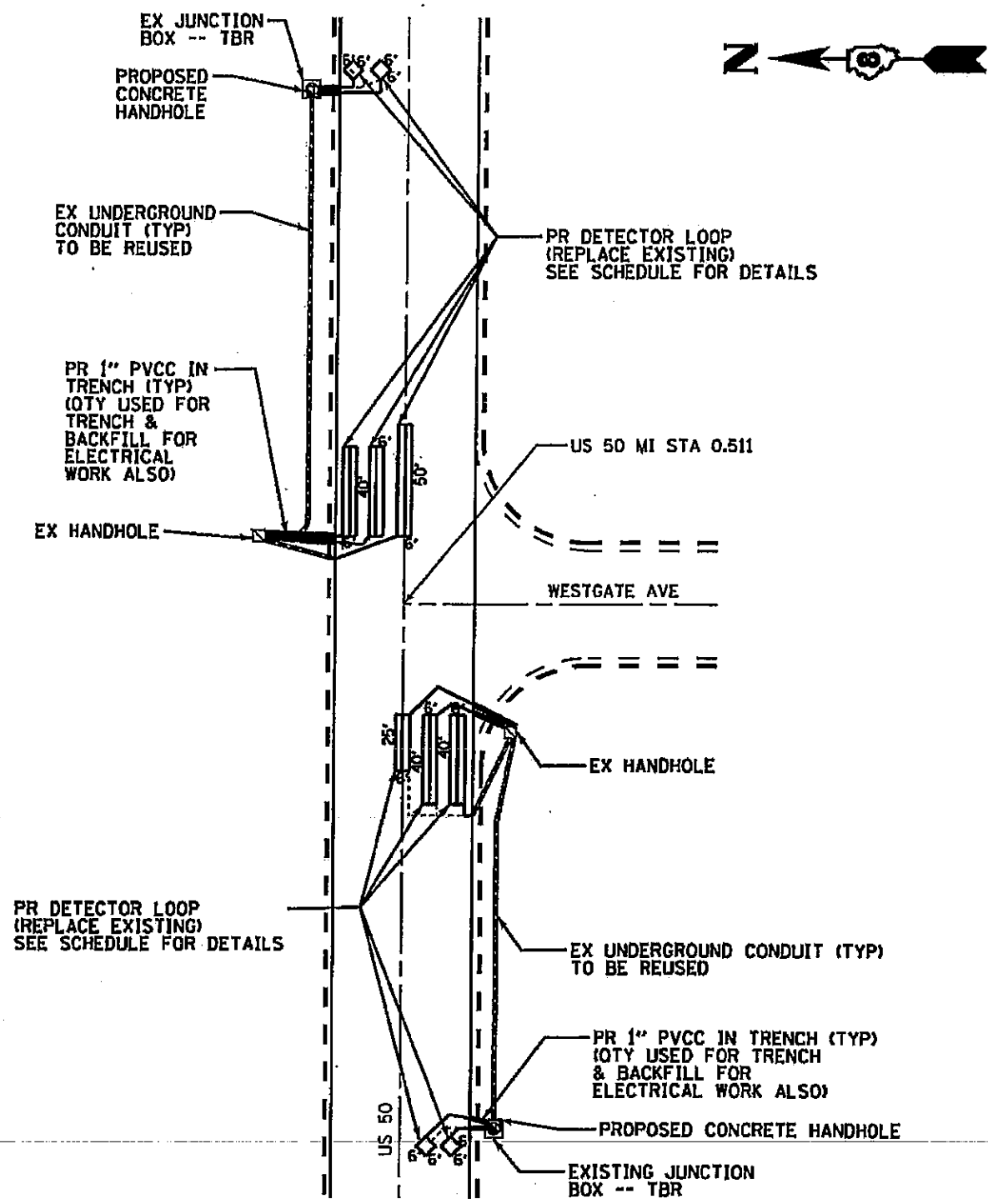

ILLINOIS DEPARTMENT OF TRANSPORTATION  
**DETECTOR LOOP LOCATION 1**

FAP 327 (US 50)  
SECTION (16, 16NRM-Z, 16Z)RS-5  
MARION COUNTY

PLOT DATE: \*DATE-TIME\*

\*DATE-TIME\*  
\*CON-SPEC\*  
\*REF\*  
\*REF\*

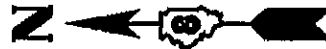
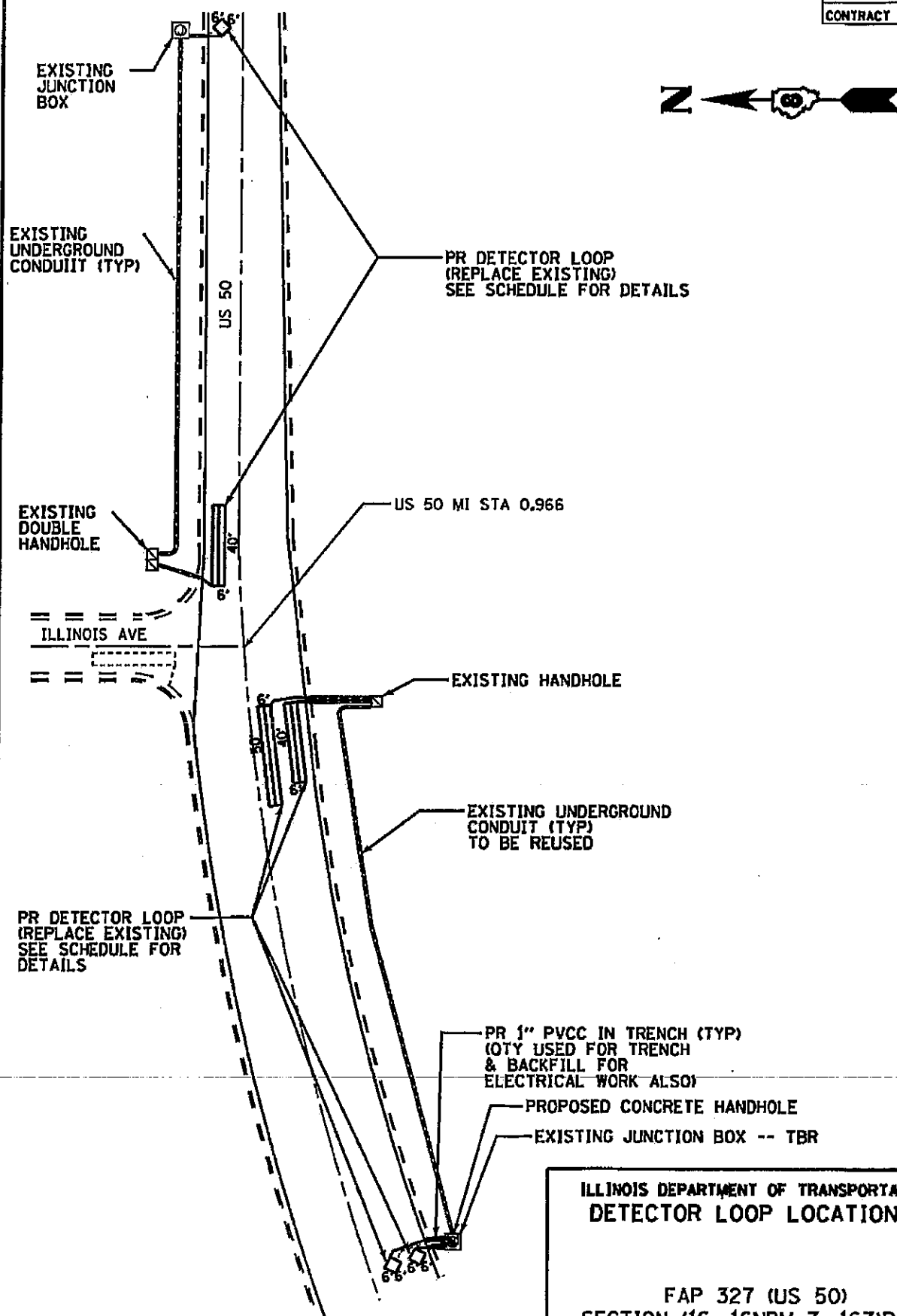

**ILLINOIS DEPARTMENT OF TRANSPORTATION  
DETECTOR LOOP LOCATION 2**

FAP 327 (US 50)  
SECTION (16, 16NRM-Z, 16Z)RS-5  
MARION COUNTY

PLOT DATE: \*DATE-TIME\*

\*DATE\*\*  
\*DATE-TIME\*  
\*DGN-SPEC\*  
\*REF\*  
\*REF\*



TOTAL SHEETS	SHEET NO.
39	21
CONTRACT NO. 76AB0	

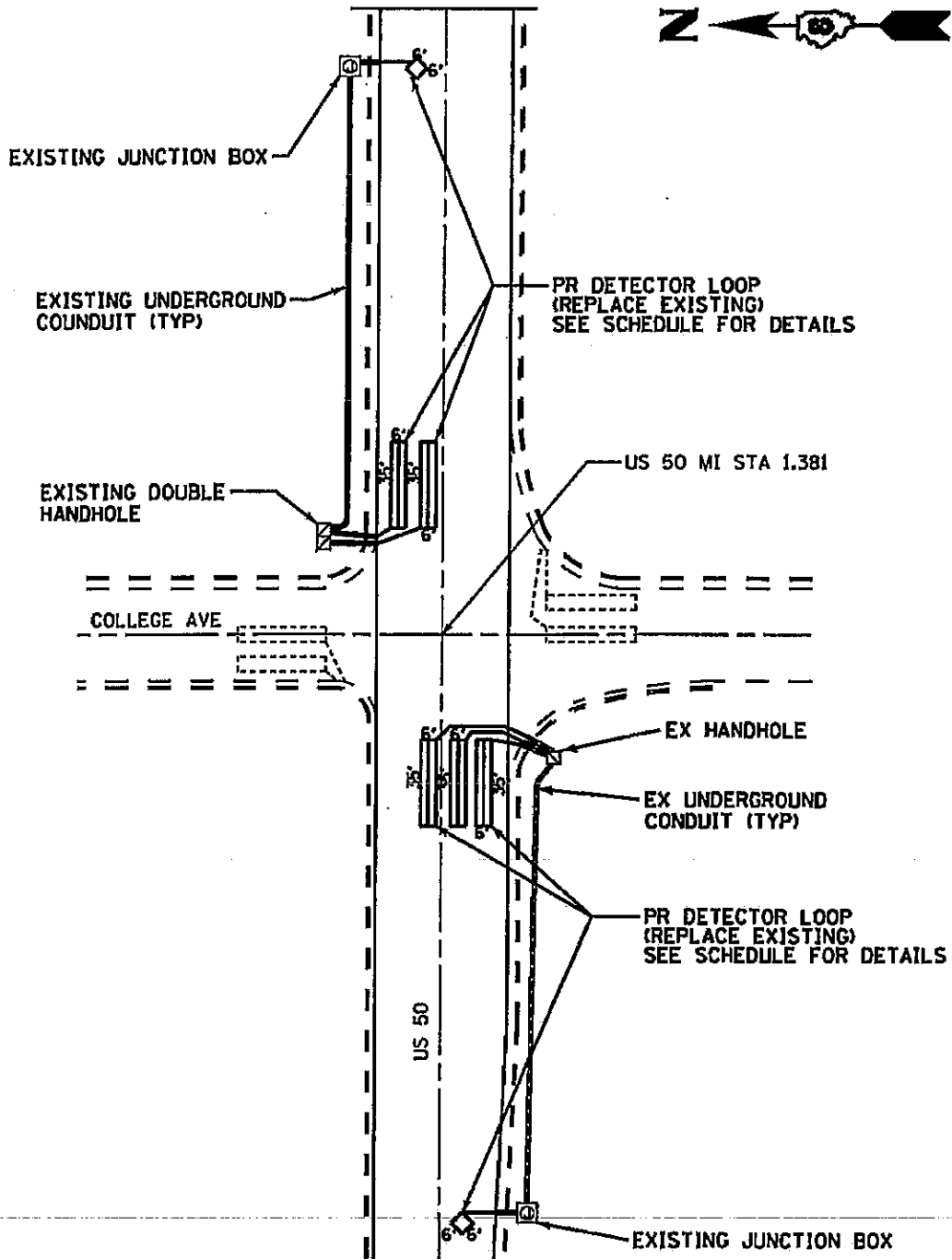

ILLINOIS DEPARTMENT OF TRANSPORTATION  
**DETECTOR LOOP LOCATION 3**

FAP 327 (US 50)  
SECTION (16, 16NRM-Z, 16Z)RS-5  
MARION COUNTY

PLOT DATE: \*DATE-TIME\*

\*\*DATE\*\*  
\*DATE-TIME\*  
\*IGN-SPEC\*  
\*REF\*  
\*REF\*

TOTAL SHEETS	SHEET NO.
39	22
CONTRACT NO. 76ABD	



PR DETECTOR LOOP  
(REPLACE EXISTING)  
SEE SCHEDULE FOR DETAILS

EXISTING UNDERGROUND  
CONDUIT (TYP)

EXISTING HANDHOLE

BROADWAY AVE (IL 371)

US 50 MI STA 1.588

EXISTING HANDHOLE

EXISTING UNDERGROUND  
CONDUIT (TYP)

PR DETECTOR LOOP  
(REPLACE EXISTING)  
SEE SCHEDULE FOR DETAILS

US 50

ILLINOIS DEPARTMENT OF TRANSPORTATION  
DETECTOR LOOP LOCATION 4

FAP 327 (US 50)  
SECTION (16, 16NRM-Z, 16Z)RS-5  
MARION COUNTY

PLOT DATE: \*DATE-TIME\*

\*\*DATE\*\*  
\*DATE-TIME\*  
\*DSN-SPEC\*  
\*REF\*  
\*REF\*

TOTAL SHEETS	SHEET NO.
39	23
CONTRACT NO. 76A80	

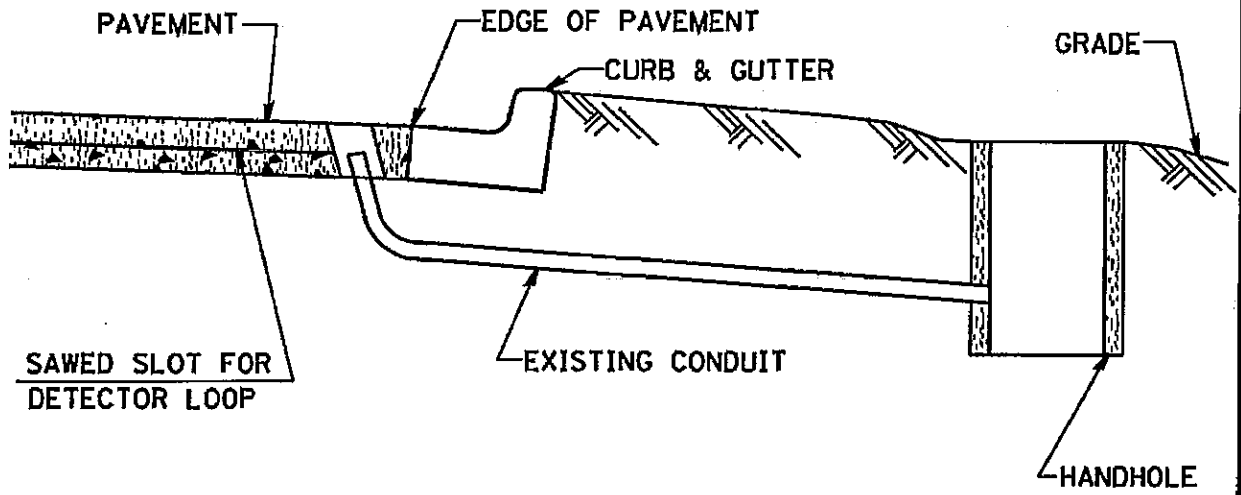

**DETAIL**

(NO SCALE)

**RE-USE EXISTING DETECTOR LOOP LEAD-IN CONDUIT**

1. DRILL OUT PAVEMENT SEALANT AND CLEAN EXISTING CONDUIT. (FIELD CONDITION MAY VARY.)
2. REMOVE EXISTING CABLE TO HANDHOLE.
3. CLEAN CONDUIT AND INSTALL LOOP LEAD-IN CONDUCTORS IN CONDUIT.
4. SPLICE NEW DETECTOR LOOP LEAD-IN CONDUCTORS TO EXISTING LEAD-IN CABLE IN HANDHOLE.
5. FILL HOLE WITH APPROVED SEALER. PREVENT SEALER FROM ENTERING INTO CONDUIT.
6. LOCATING UNDERGROUND CABLE WILL BE PAID FOR SEPARATELY.

ILLINOIS DEPARTMENT OF TRANSPORTATION  
**DETECTOR LOOP  
 LEAD-IN**

FAP 327 (US 50)  
 SECTION (16, 16NRM-Z, 16Z)RS-5  
 MARION COUNTY

PLOT DATE: \*DATE-TIME\*

\*\*DATE\*\*  
 \*DATE-TIME\*  
 \*DGN-SPEC\*  
 \*REF\*  
 \*REF\*

TOTAL SHEETS	SHEET NO.
39	24
CONTRACT NO. 76A80	

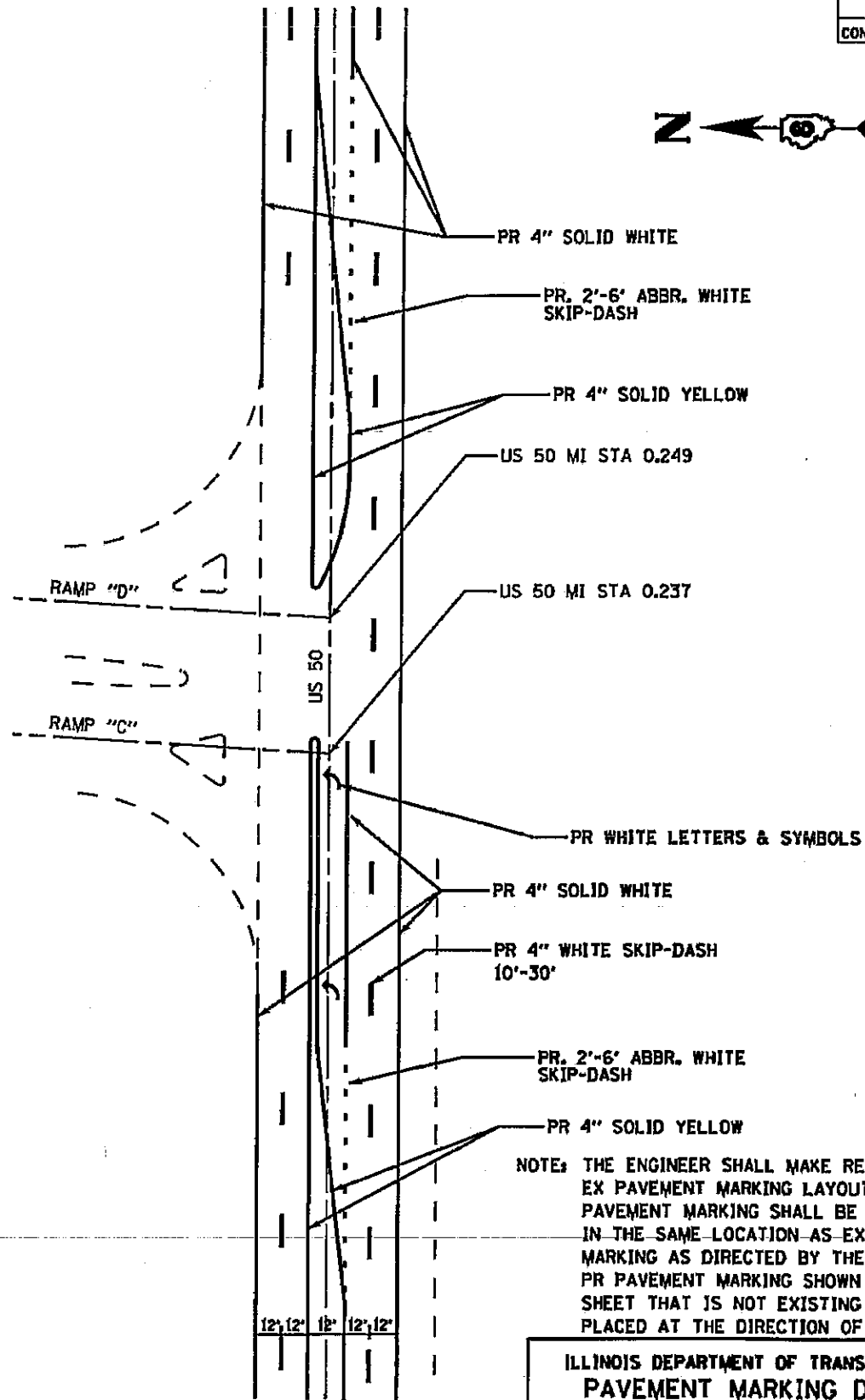

- PR 4" SOLID WHITE
- PR. 2'-6' ABBR. WHITE SKIP-DASH
- PR 4" SOLID YELLOW
- US 50 MI STA 0.249
- US 50 MI STA 0.237
- PR WHITE LETTERS & SYMBOLS
- PR 4" SOLID WHITE
- PR 4" WHITE SKIP-DASH 10'-30'
- PR. 2'-6' ABBR. WHITE SKIP-DASH
- PR 4" SOLID YELLOW

NOTE: THE ENGINEER SHALL MAKE RECORD OF EX PAVEMENT MARKING LAYOUT. PR PAVEMENT MARKING SHALL BE PLACED IN THE SAME LOCATION AS EX PAVEMENT MARKING AS DIRECTED BY THE ENGINEER. PR PAVEMENT MARKING SHOWN ON THIS SHEET THAT IS NOT EXISTING SHALL BE PLACED AT THE DIRECTION OF THE ENGINEER.

ILLINOIS DEPARTMENT OF TRANSPORTATION  
 PAVEMENT MARKING DETAIL  
 RAMP "C" & RAMP "D"

FAP 327 (US 50)  
 SECTION (16, 16NRM-Z, 16Z)RS-5  
 MARION COUNTY

PLOT DATE: \*DATE-TIME\*

\*DATE-TIME\*  
 \*CON-SPEC\*  
 \*REF\*  
 \*REF\*

TOTAL SHEETS	SHEET NO.
39	25
CONTRACT NO. 76A80	

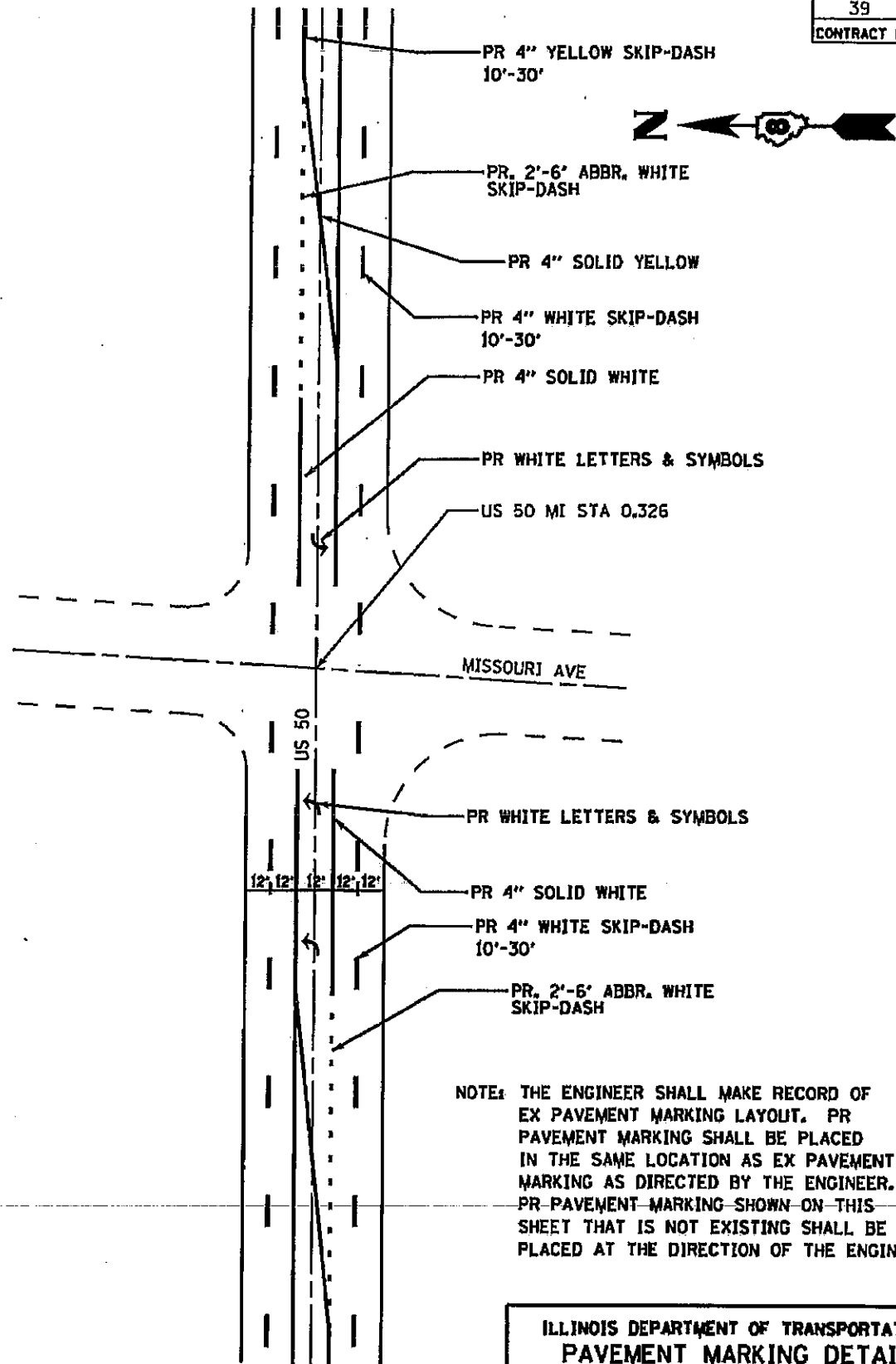

NOTE: THE ENGINEER SHALL MAKE RECORD OF EX PAVEMENT MARKING LAYOUT. PR PAVEMENT MARKING SHALL BE PLACED IN THE SAME LOCATION AS EX PAVEMENT MARKING AS DIRECTED BY THE ENGINEER. PR PAVEMENT MARKING SHOWN ON THIS SHEET THAT IS NOT EXISTING SHALL BE PLACED AT THE DIRECTION OF THE ENGINEER.

ILLINOIS DEPARTMENT OF TRANSPORTATION  
 PAVEMENT MARKING DETAIL  
 MISSOURI AVE INTERSECTION

FAP 327 (US 50)  
 SECTION (16, 16NRM-Z, 16Z)RS-5  
 MARION COUNTY

PLOT DATE: \*DATE-TIME\*

\*DATE-TIME\*  
 \*CON-SPEC\*  
 \*REF\*  
 \*REF\*

TOTAL SHEETS	SHEET NO.
39	26
CONTRACT NO. 76480	

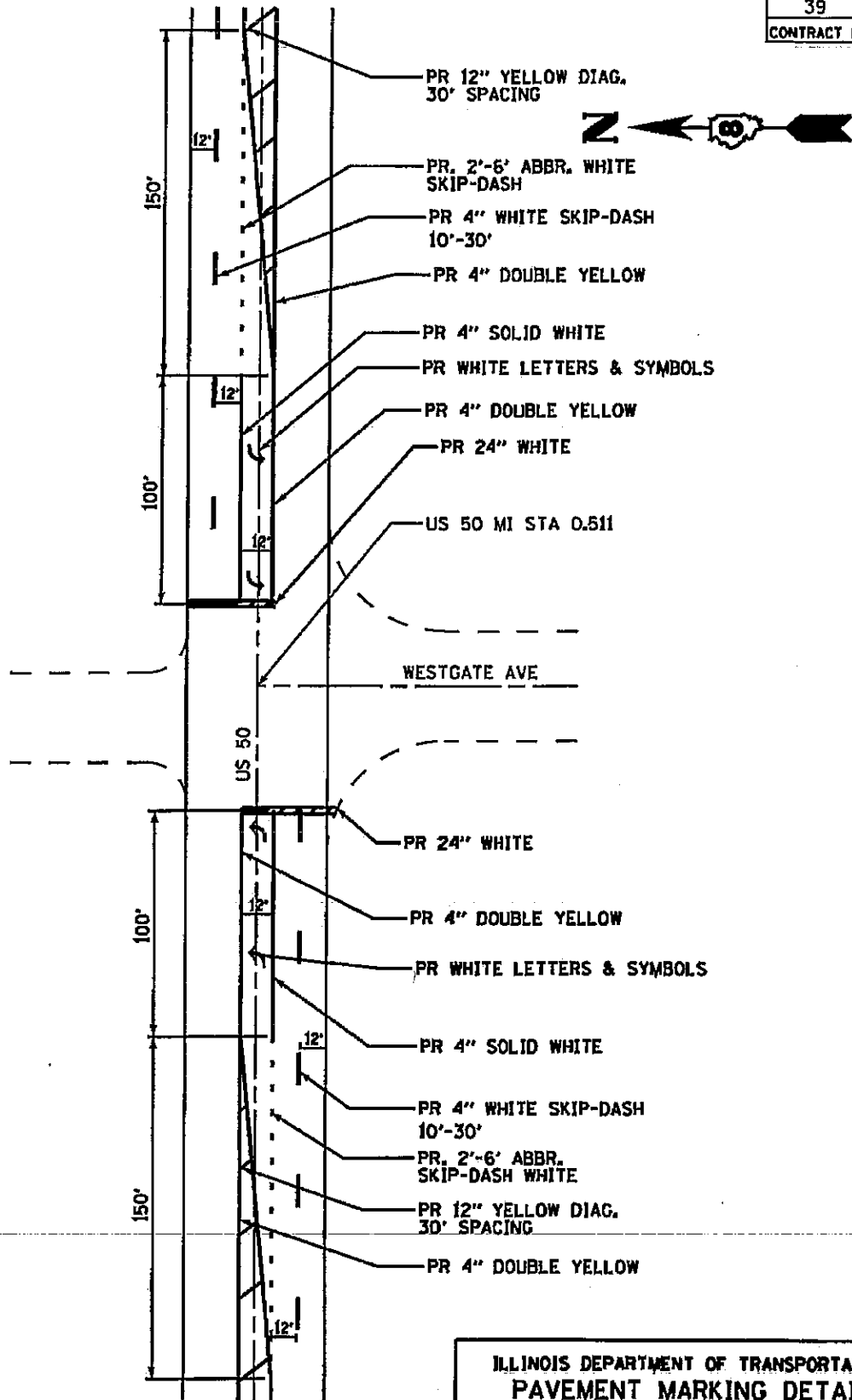

NOTE: THE ENGINEER SHALL MAKE RECORD OF EX PAVEMENT MARKING LAYOUT. PR PAVEMENT MARKING SHALL BE PLACED IN THE SAME LOCATION AS EX PAVEMENT MARKING AS DIRECTED BY THE ENGINEER. PR PAVEMENT MARKING SHOWN ON THIS SHEET THAT IS NOT EXISTING SHALL BE PLACED AT THE DIRECTION OF THE ENGINEER.

ILLINOIS DEPARTMENT OF TRANSPORTATION  
 PAVEMENT MARKING DETAIL  
 WESTGATE AVE INTERSECTION

FAP 327 (US 50)  
 SECTION (16, 16NRM-Z, 16Z)RS-5  
 MARION COUNTY

PLOT DATE: \*DATE-TIME\*

\*DATE-TIME\*  
 \*DIM-SPEC\*  
 \*REF\*  
 \*REF\*

TOTAL SHEETS	SHEET NO.
39	27
CONTRACT NO. 76ABD	

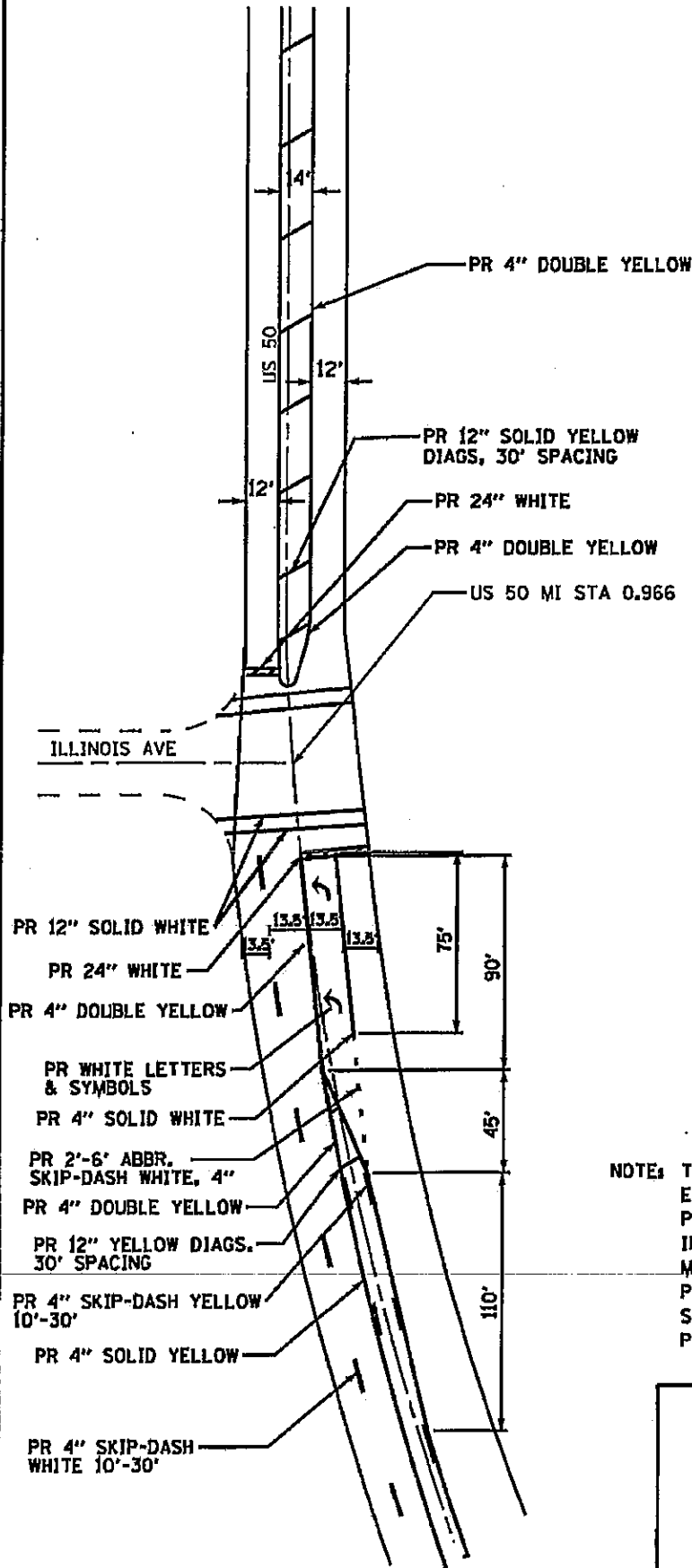

NOTE: THE ENGINEER SHALL MAKE RECORD OF EX PAVEMENT MARKING LAYOUT. PR PAVEMENT MARKING SHALL BE PLACED IN THE SAME LOCATION AS EX PAVEMENT MARKING AS DIRECTED BY THE ENGINEER. PR PAVEMENT MARKING SHOWN ON THIS SHEET THAT IS NOT EXISTING SHALL BE PLACED AT THE DIRECTION OF THE ENGINEER.

ILLINOIS DEPARTMENT OF TRANSPORTATION  
 PAVEMENT MARKING DETAIL  
 ILLINOIS AVE INTERSECTION

FAP 327 (US 50)  
 SECTION (16, 16NRM-Z, 16ZJRS-5)  
 MARION COUNTY

PLOT DATE: \*DATE-TIME\*

\*\*DATE\*\*  
 \*DATE-TIME\*  
 \*DGN-SPEC\*  
 \*REF\*  
 \*REF\*

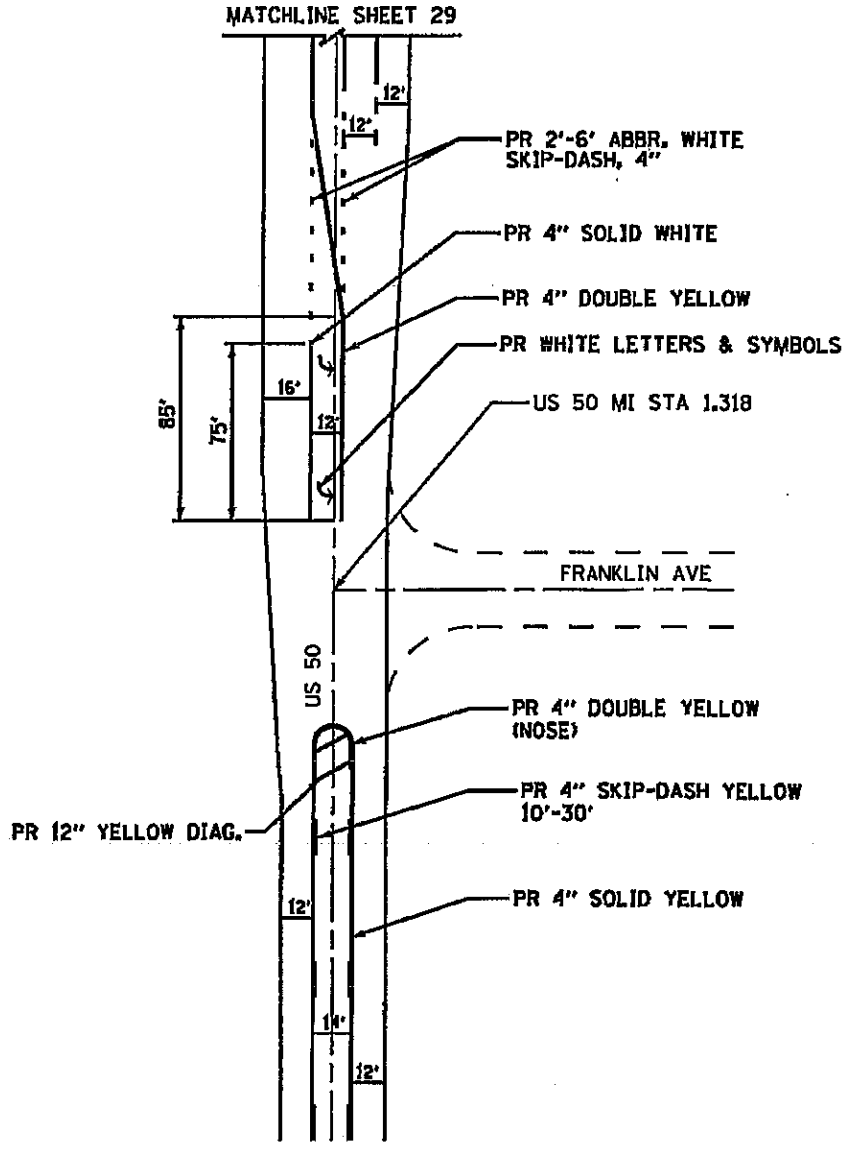

NOTE: THE ENGINEER SHALL MAKE RECORD OF EX PAVEMENT MARKING LAYOUT. PR PAVEMENT MARKING SHALL BE PLACED IN THE SAME LOCATION AS EX PAVEMENT MARKING AS DIRECTED BY THE ENGINEER. PR PAVEMENT MARKING SHOWN ON THIS SHEET THAT IS NOT EXISTING SHALL BE PLACED AT THE DIRECTION OF THE ENGINEER.

ILLINOIS DEPARTMENT OF TRANSPORTATION  
 PAVEMENT MARKING DETAIL  
 FRANKLIN AVE INTERSECTION

FAP 327 (US 50)  
 SECTION (16, 16NRM-Z, 16Z)RS-5  
 MARION COUNTY

PLOT DATE: \*DATE-TIME\*

\*DATE\*  
 \*DATE-TIME\*  
 \*CON-SPEC\*  
 \*REF\*  
 \*REF\*



TOTAL SHEETS	SHEET NO.
39	29
CONTRACT NO. 76AB0	

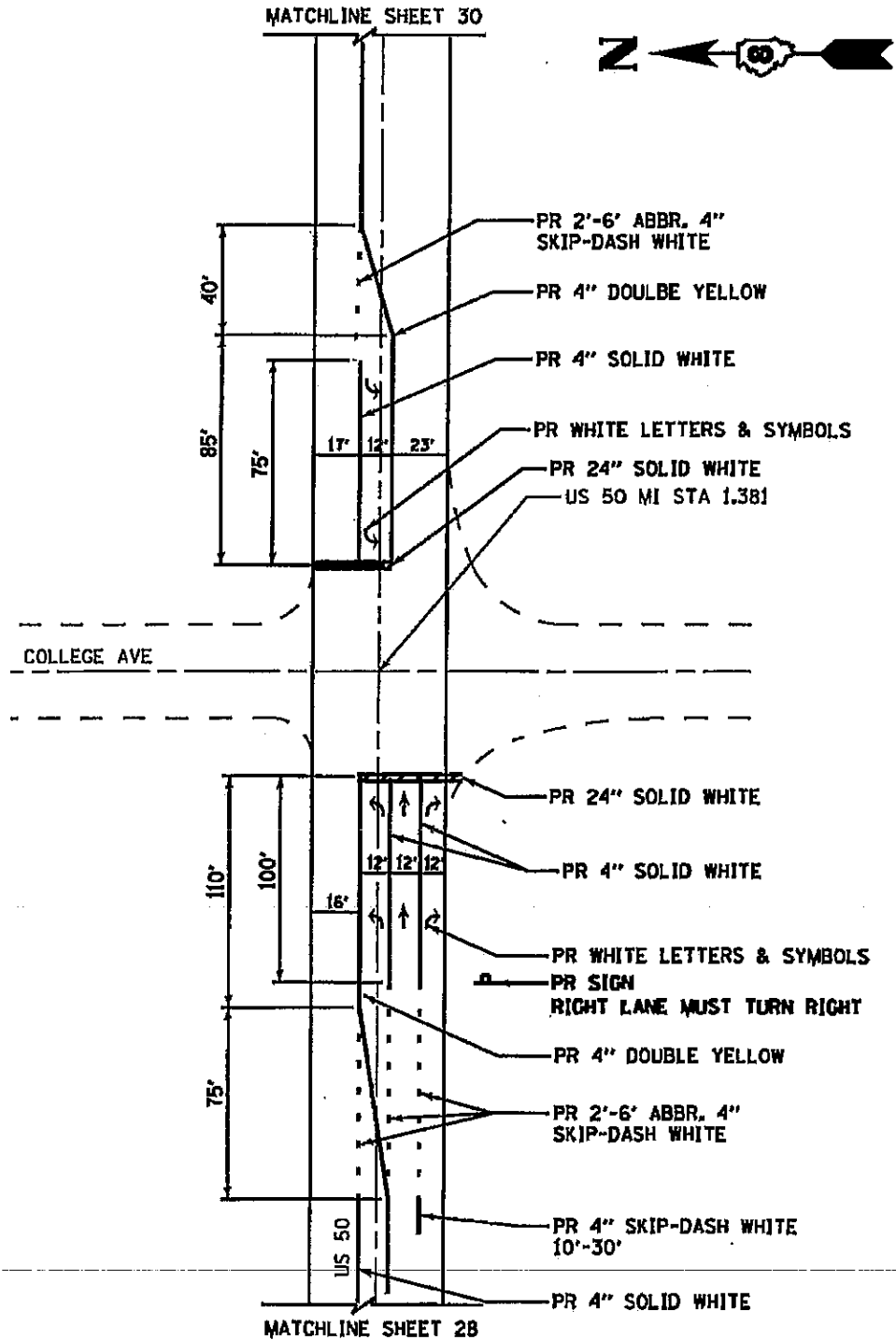

NOTE: THE ENGINEER SHALL MAKE RECORD OF EX PAVEMENT MARKING LAYOUT. PR PAVEMENT MARKING SHALL BE PLACED IN THE SAME LOCATION AS EX PAVEMENT MARKING AS DIRECTED BY THE ENGINEER. PR PAVEMENT MARKING SHOWN ON THIS SHEET THAT IS NOT EXISTING SHALL BE PLACED AT THE DIRECTION OF THE ENGINEER.

ILLINOIS DEPARTMENT OF TRANSPORTATION  
 PAVEMENT MARKING DETAIL  
 COLLEGE AVE INTERSECTION

FAP 327 (US 50)  
 SECTION (16, 16NRM-Z, 16Z)RS-5  
 MARION COUNTY

PLOT DATE: \*DATE-TIME\*

\*\*DATE\*\*  
 \*DATE-TIME\*  
 \*CON/SEC\*  
 \*REF\*  
 \*REF\*

TOTAL SHEETS	SHEET NO.
39	30
CONTRACT NO. 76ABD	

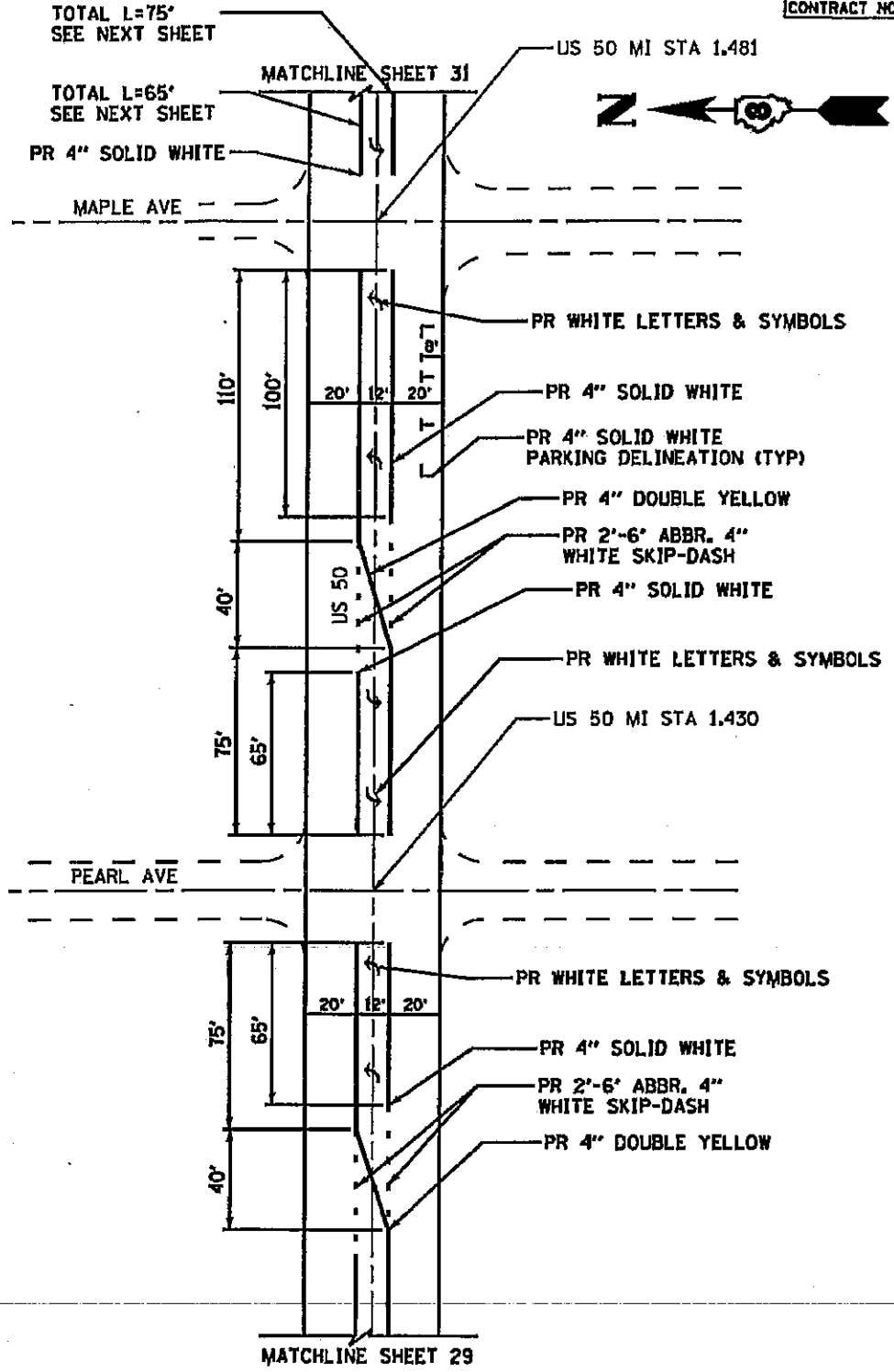

NOTE: THE ENGINEER SHALL MAKE RECORD OF EX PAVEMENT MARKING LAYOUT. PR PAVEMENT MARKING SHALL BE PLACED IN THE SAME LOCATION AS EX PAVEMENT MARKING AS DIRECTED BY THE ENGINEER. PR PAVEMENT MARKING SHOWN ON THIS SHEET THAT IS NOT EXISTING SHALL BE PLACED AT THE DIRECTION OF THE ENGINEER.

ILLINOIS DEPARTMENT OF TRANSPORTATION  
 PAVEMENT MARKING DETAIL  
 PEARL & MAPLE AVE  
 INTERSECTIONS  
 FAP 327 (US 50)  
 SECTION (16, 16NRM-Z, 16Z)RS-5  
 MARION COUNTY  
 PLOT DATE: \*DATE-TIME\*

\*DATE\*\*  
 \*DATE-TIME\*  
 \*DN-SPEC\*  
 \*REF\*  
 \*REF\*

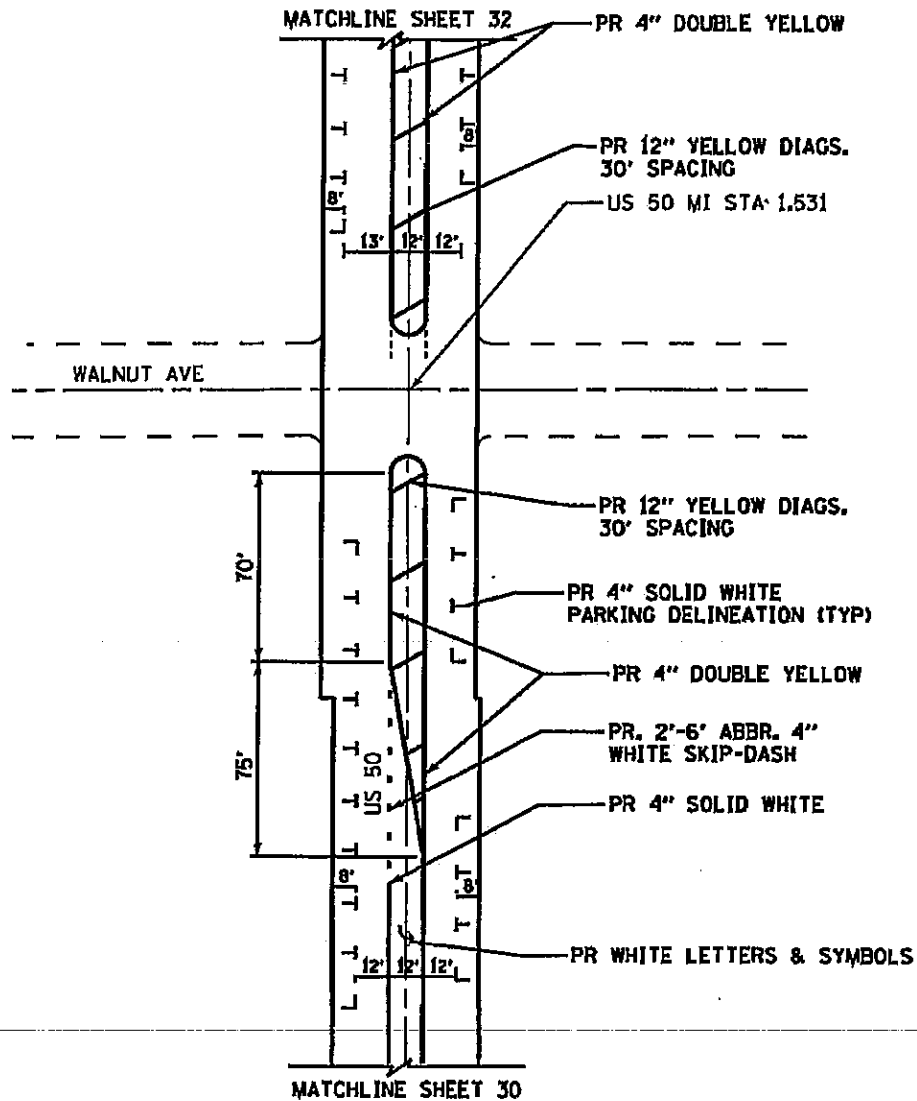

NOTE: THE ENGINEER SHALL MAKE RECORD OF EX PAVEMENT MARKING LAYOUT. PR PAVEMENT MARKING SHALL BE PLACED IN THE SAME LOCATION AS EX PAVEMENT MARKING AS DIRECTED BY THE ENGINEER. PR PAVEMENT MARKING SHOWN ON THIS SHEET THAT IS NOT EXISTING SHALL BE PLACED AT THE DIRECTION OF THE ENGINEER.

ILLINOIS DEPARTMENT OF TRANSPORTATION  
 PAVEMENT MARKING DETAIL  
 WALNUT AVE INTERSECTION

FAP 327 (US 50)  
 SECTION (16, 16NRM-Z, 16ZJRS-5)  
 MARION COUNTY

PLOT DATE: \*DATE-TIME\*

\*DATE\*\*  
 \*DATE-TIME\*  
 \*DGN-SPEC\*  
 \*REF-  
 \*REF-

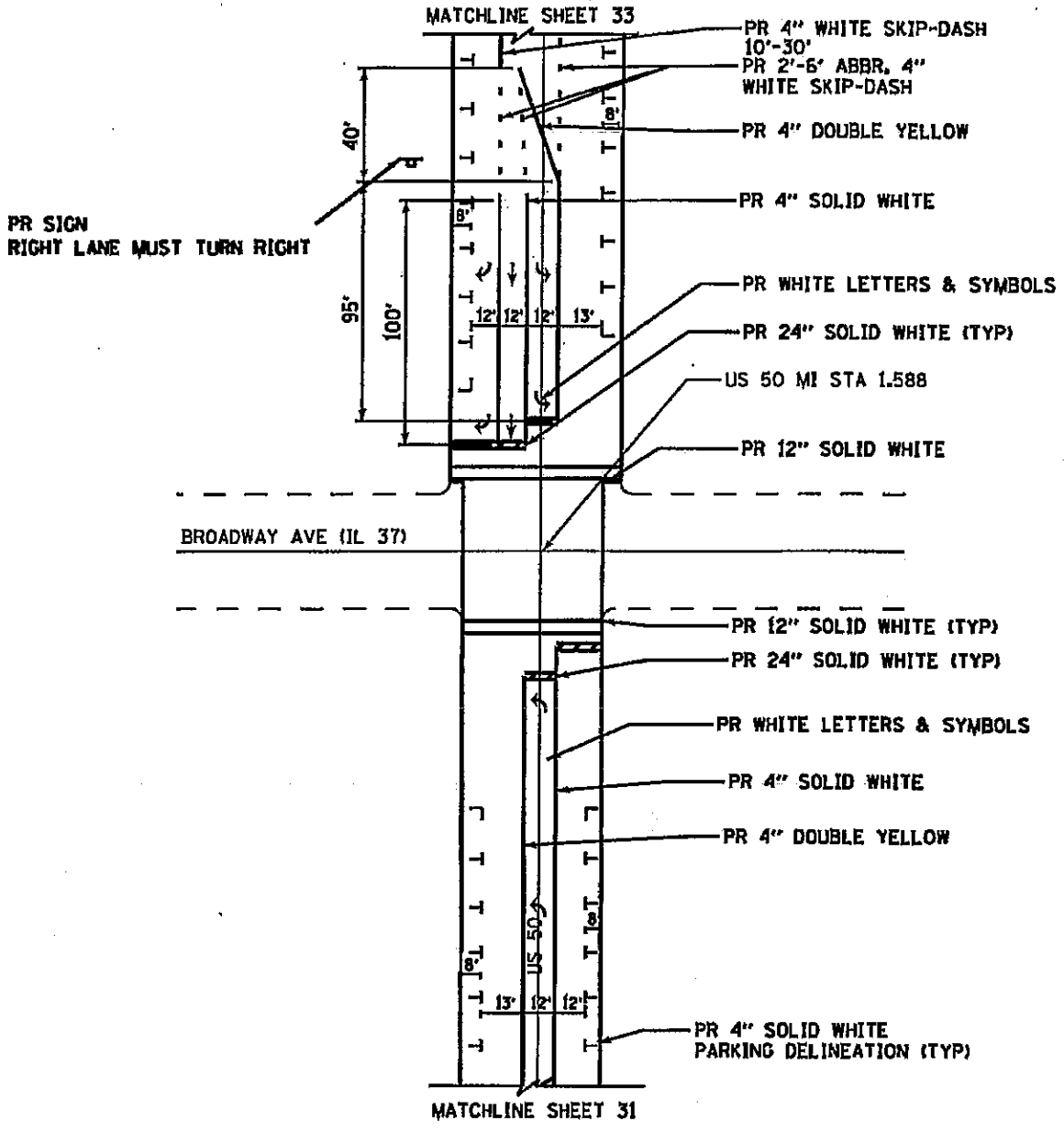
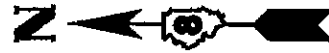

NOTE: THE ENGINEER SHALL MAKE RECORD OF EX PAVEMENT MARKING LAYOUT. PR PAVEMENT MARKING SHALL BE PLACED IN THE SAME LOCATION AS EX PAVEMENT MARKING AS DIRECTED BY THE ENGINEER. PR PAVEMENT MARKING SHOWN ON THIS SHEET THAT IS NOT EXISTING SHALL BE PLACED AT THE DIRECTION OF THE ENGINEER.

ILLINOIS DEPARTMENT OF TRANSPORTATION  
 PAVEMENT MARKING DETAIL  
 BROADWAY AVE INTERSECTION

FAP 327 (US 50)  
 SECTION (16, 16NRM-Z, 16Z)RS-5  
 MARION COUNTY

PLOT DATE: \*DATE-TIME\*

••DATE••  
 •DATE-TIME•  
 •DNV•SEC•  
 •REF•  
 •REF•

TOTAL SHEETS	SHEET NO.
39	33
CONTRACT NO. 76A80	

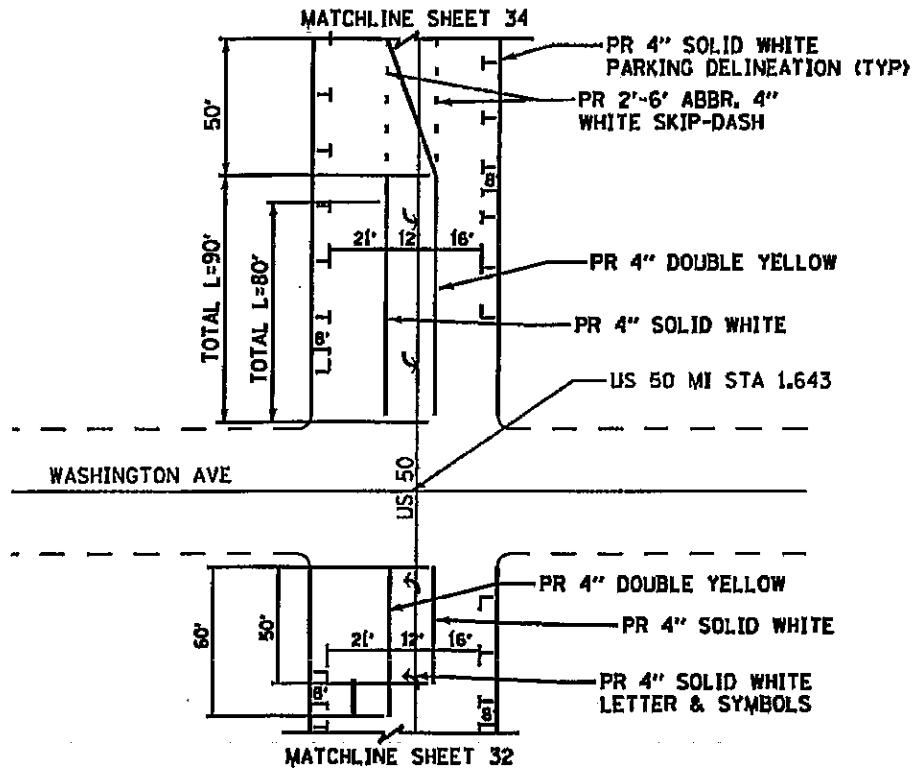
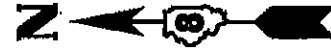

NOTE: THE ENGINEER SHALL MAKE RECORD OF EX PAVEMENT MARKING LAYOUT. PR PAVEMENT MARKING SHALL BE PLACED IN THE SAME LOCATION AS EX PAVEMENT MARKING AS DIRECTED BY THE ENGINEER. PR PAVEMENT MARKING SHOWN ON THIS SHEET THAT IS NOT EXISTING SHALL BE PLACED AT THE DIRECTION OF THE ENGINEER.

ILLINOIS DEPARTMENT OF TRANSPORTATION  
 PAVEMENT MARKING DETAIL  
 WASHINGTON AVE INTERSECTION

FAP 327 (US 50)  
 SECTION (16, 16NRM-Z, 16Z1RS-5  
 MARION COUNTY

PLOT DATE: \*DATE-TIME\*

\*DATE\*  
 \*DATE-TIME\*  
 \*DRAW-SPEC\*  
 \*REF\*  
 \*REF\*

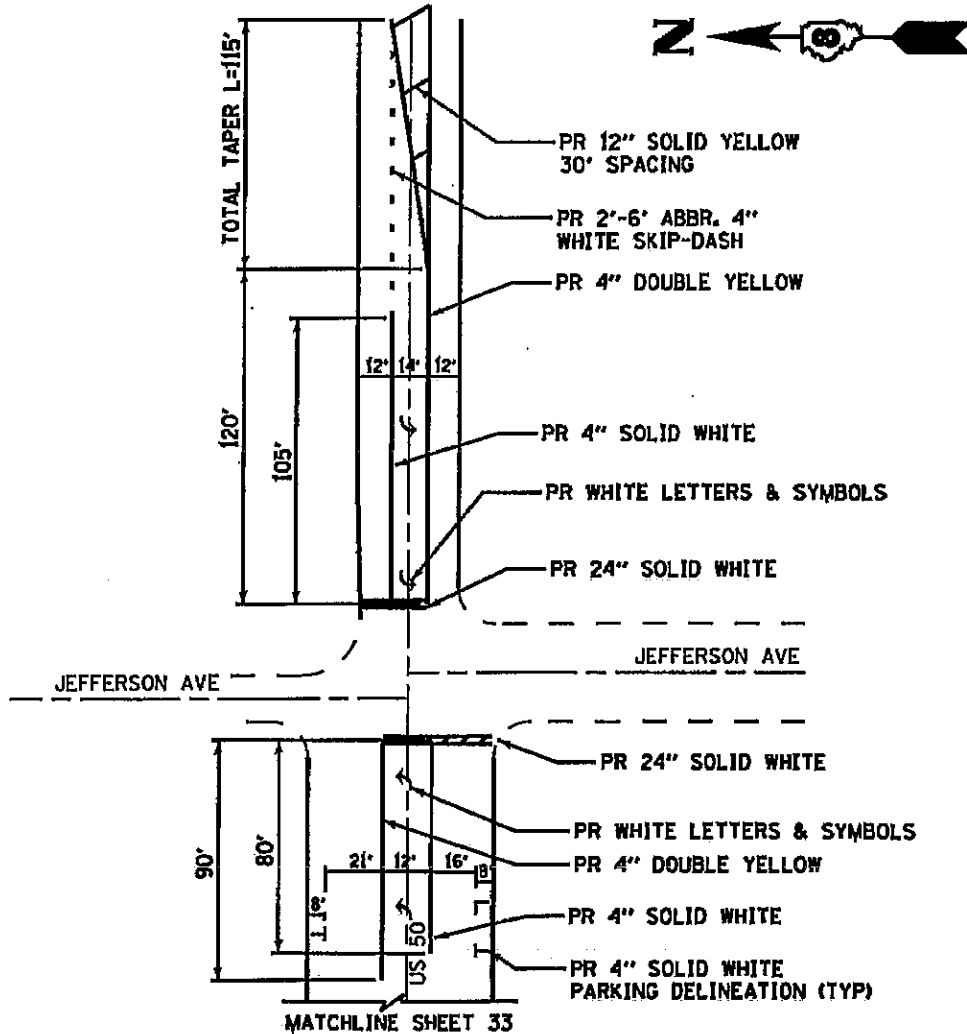

NOTE: THE ENGINEER SHALL MAKE RECORD OF EX PAVEMENT MARKING LAYOUT. PR PAVEMENT MARKING SHALL BE PLACED IN THE SAME LOCATION AS EX PAVEMENT MARKING AS DIRECTED BY THE ENGINEER. PR PAVEMENT MARKING SHOWN ON THIS SHEET THAT IS NOT EXISTING SHALL BE PLACED AT THE DIRECTION OF THE ENGINEER.

ILLINOIS DEPARTMENT OF TRANSPORTATION  
 PAVEMENT MARKING DETAIL  
 JEFFERSON AVE INTERSECTION

FAP 327 (US 50)  
 SECTION (16, 16NRM-Z, 16Z)RS-5  
 MARION COUNTY

\*DATE\*\*  
 \*DATE-TIME\*  
 \*DGN-SPEC\*  
 \*REF\*  
 \*REF\*

PLOT DATE: \*DATE-TIME\*

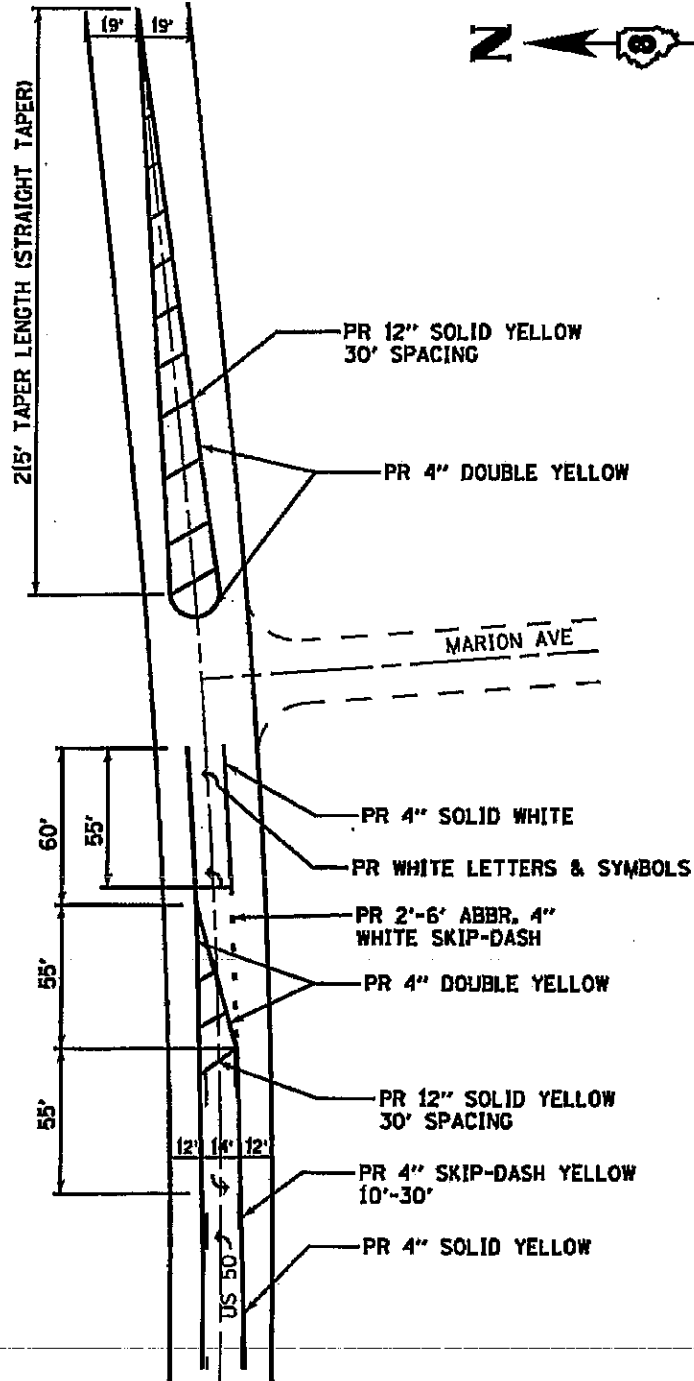

NOTE: THE ENGINEER SHALL MAKE RECORD OF EX PAVEMENT MARKING LAYOUT. PR PAVEMENT MARKING SHALL BE PLACED IN THE SAME LOCATION AS EX PAVEMENT MARKING AS DIRECTED BY THE ENGINEER. PR PAVEMENT MARKING SHOWN ON THIS SHEET THAT IS NOT EXISTING SHALL BE PLACED AT THE DIRECTION OF THE ENGINEER.

ILLINOIS DEPARTMENT OF TRANSPORTATION  
 PAVEMENT MARKING DETAIL  
 MARION AVE INTERSECTION

FAP 327 (US 50)  
 SECTION (16, 16NRM-Z, 16Z)RS-5  
 MARION COUNTY

PLOT DATE: \*DATE-TIME\*

\*\*DATE\*\*  
 \*DATE-TIME\*  
 \*DGN-SPEC\*  
 \*REF\*  
 \*REF\*

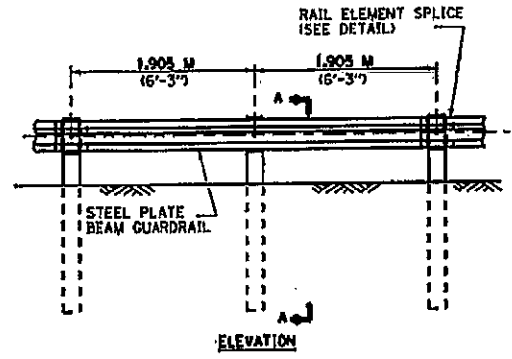

**TYPE A**  
1,905 M (6'-3") TYPICAL POST SPACING

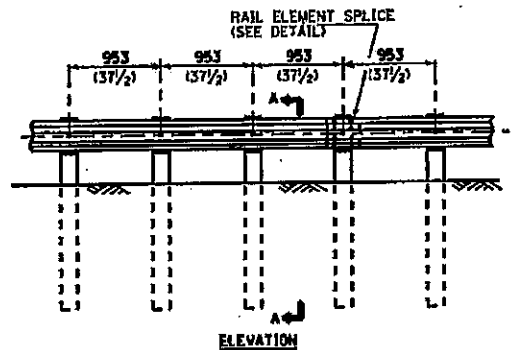
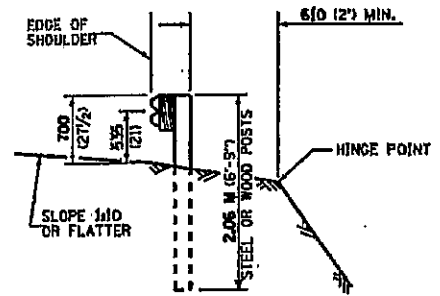

**TYPE B**  
953 (37 1/2) CLOSED POST SPACING

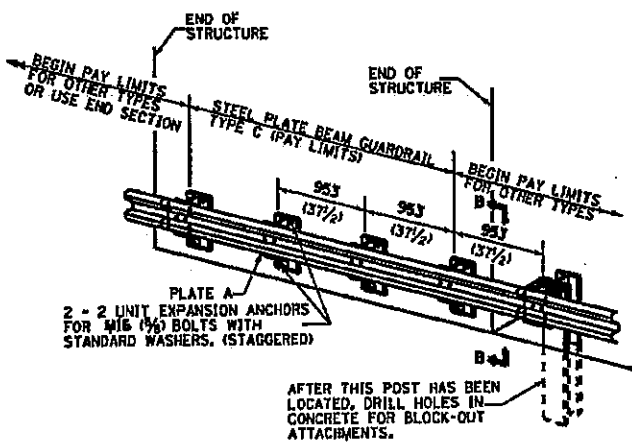
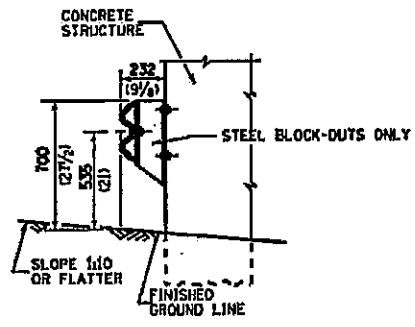

**TYPE C**  
953 (37 1/2) BLOCK-OUT SPACING

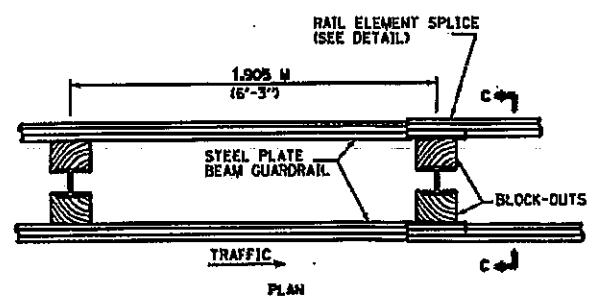
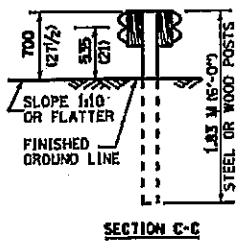

**TYPE D**  
DOUBLE STEEL PLATE BEAM GUARDRAIL  
1,905 M (6'-3") TYPICAL POST SPACING

**GENERAL NOTES**

ALL SLOPE RATIOS ARE EXPRESSED AS UNITS OF VERTICAL DISPLACEMENT TO UNITS OF HORIZONTAL DISPLACEMENT (V:H).

ALL DIMENSIONS ARE IN MILLIMETERS (INCHES) UNLESS OTHERWISE SHOWN.

THE EXISTING STEEL POSTS MAY BE DRILLED TO MATCH THE BOLT PATTERN SHOWN HEREIN FOR THE WOOD BLOCK-OUT, OR A NEW STEEL POST SHALL BE PROVIDED.

THIS DETAIL IS APPLICABLE TO THE GUARDRAIL SYSTEM USED PRIOR TO JANUARY 1, 2007. FOR DETAILS ON THE MIDWEST GUARDRAIL SYSTEM, SEE STANDARD 630001.

ILLINOIS DEPARTMENT OF TRANSPORTATION  
REMOVE & RE-ERECT STEEL  
PLATE BEAM GUARDRAIL DETAIL  
(SHEET 1 OF 4)  
FAP 327 (US 50)  
SECTION (16, 16NRM-Z, 16Z)RS-5  
MARION COUNTY

PLOT DATE: •DATE-TIME•

•DATE-TIME•  
•DATE-TIME•  
•CON-SPEC•  
•REF•  
•REF•





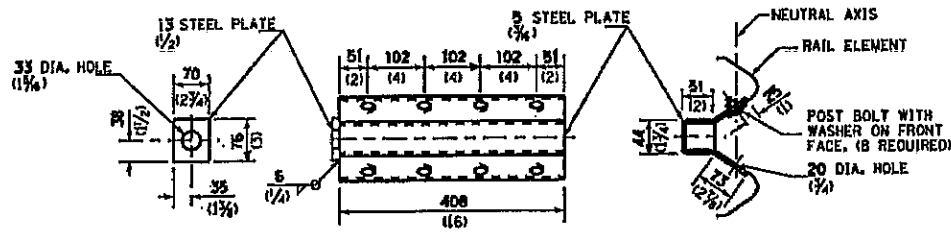

NOTE  
 ANCHOR PLATE T SHALL BE USED TO ATTACH CABLE ASSEMBLY TO GUARDRAIL WHEN REQUIRED ON TRAFFIC BARRIER TERMINALS.

**ANCHOR PLATE T DETAILS**

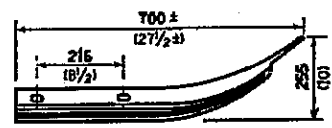

PLACE STANDARD END SHOE BETWEEN SPLICE PLATE AND RAIL ELEMENT

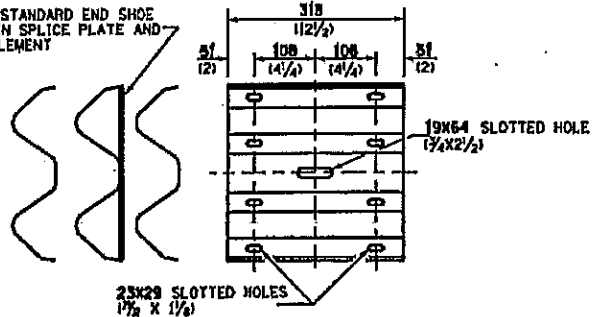

**SPLICE PLATE**

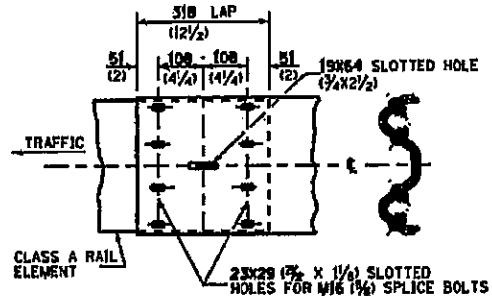
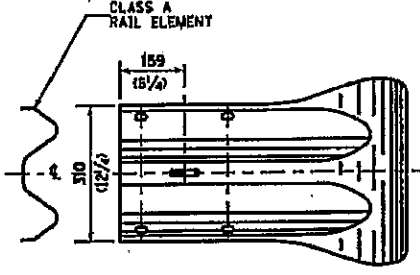

**RAIL ELEMENT SPLICE**

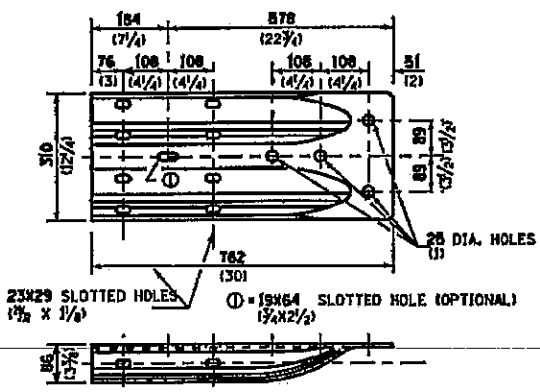
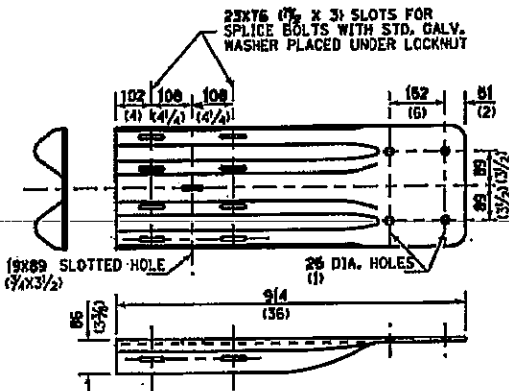

**ALTERNATE END SHOE**

NOTE  
 WHEN END SHOE IS ATTACHED TO A BRIDGE PARAPET WHICH HAS AN EXPANSION JOINT, THE BOLTS SHALL BE PROVIDED WITH A LOCKNUT OR DOUBLE NUT AND SHALL BE TIGHTENED ONLY TO A POINT THAT WILL ALLOW GUARDRAIL MOVEMENT.  
 THE STANDARD END SHOE SHALL BE ATTACHED TO THE CONCRETE WITH PRE-DRILLED OR SELF-DRILLING ANCHOR BOLTS. THE ANCHOR CONE SHALL BE SET FLUSH WITH THE SURFACE OF THE CONCRETE.  
 EXTERNALLY THREADED STUDS PROTRUDING FROM THE SURFACE OF THE CONCRETE WILL NOT BE PERMITTED.

**END SHOE**

ILLINOIS DEPARTMENT OF TRANSPORTATION  
 REMOVE & RE-ERECT STEEL  
 PLATE BEAM GUARDRAIL DETAIL  
 (SHEET 3 OF 4)  
 FAP 327 (US 50)  
 SECTION (16, 16NRM-Z, 16Z)RS-5  
 MARION COUNTY  
 PLOT DATE: •DATE-TIME•

•DATE-TIME•  
 •DDN-SPEC•  
 •REF•  
 •REF•

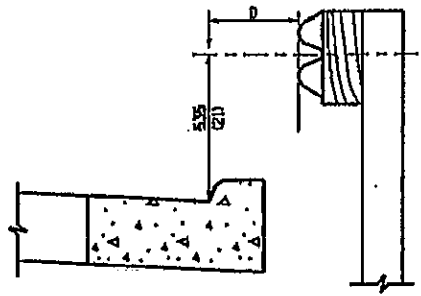

NOTE:  
IF IT IS NECESSARY FOR D TO BE MORE THAN 300 (12) AND LESS THAN 3.0 M (10'-0") TYPE M-5 (M-2) CURB AND GUTTER (STD. 60601) SHALL BE USED IN FRONT OF AND IN ADVANCE OF THE GUARDRAIL.

**GUARDRAIL PLACED BEHIND CURB**

(D = 0 DESIRABLE TO 300 (12) MAXIMUM)

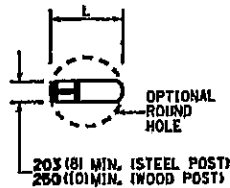

**PLAN**

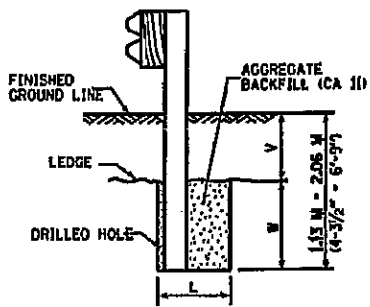

NOTE:  
LEDGE LINE IS TOP OF ROCK LEDGE OR HARD SLAG FILL.

**ELEVATION**

**FOOTING FOR POST WHEN IMPERVIOUS MATERIAL IS ENCOUNTERED**

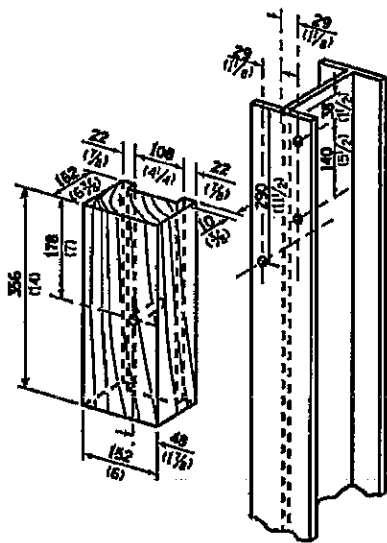

**WOOD BLOCK-OUT AND STEEL POST DETAILS**

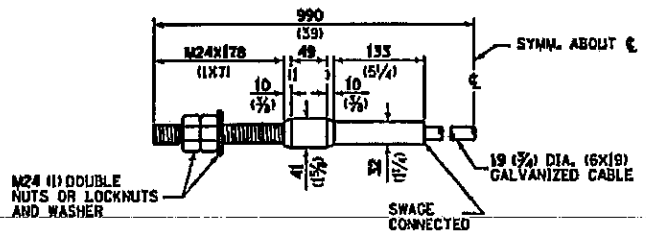

**CABLE ASSEMBLY**

(18,100 KG (40,000 LBS.) MIN. BREAKING STRENGTH)  
TIGHTEN TO TAUT TENSION.

V	W	L	
		STEEL POST	WOOD POST
0 - 460 (0 - 18)	610 (24)	530 (21)	580 (23)
>460 - 825 (18 - 41.5)	305 (12)	203 (8)	250 (10)
>825 - 1,13 M (41.5 - 53.5)	305 - 0 (12 - 0)	203 (8)	250 (10)

ILLINOIS DEPARTMENT OF TRANSPORTATION  
REMOVE & RE-ERECT STEEL  
PLATE BEAM GUARDRAIL DETAIL  
(SHEET 4 OF 4)

FAP 327 (US 50)  
SECTION (16, 16NRM-Z, 16Z)RS-5  
MARION COUNTY

PLOT DATE: DATE-TIME

\*\*DATE\*\*  
\*DATE-TIME\*  
\*DGN-SPEC\*  
\*REF.\*  
\*REF.\*

**REQUIRED CONTRACT PROVISIONS  
FEDERAL-AID CONSTRUCTION CONTRACTS**

	Page
I. General .....	1
II. Nondiscrimination .....	1
III. Nonsegregated Facilities .....	3
IV. Payment of Predetermined Minimum Wage.....	3
V. Statements and Payrolls .....	6
VI. Record of Materials, Supplies, and Labor.....	7
VIII. Safety: Accident Prevention .....	7
IX. False Statements Concerning Highway Projects.....	7
X. Implementation of Clean Air Act and Federal Water Pollution Control Act .....	8
XI. Certification Regarding Debarment, Suspension, Ineligibility, and Voluntary Exclusion .....	8
XII. Certification Regarding Use of Contract Funds for Lobbying .....	9

**ATTACHMENTS**

- A. Employment Preference for Appalachian Contracts  
(included in Appalachian contracts only)

**I. GENERAL**

1. These contract provisions shall apply to all work performed on the contract by the contractor's own organization and with the assistance of workers under the contractor's immediate superintendence and to all work performed on the contract by piecework, station work, or by subcontract.

2. Except as otherwise provided for in each section, the contractor shall insert in each subcontract all of the stipulations contained in these Required Contract Provisions, and further require their inclusion in any lower tier subcontract or purchase order that may in turn be made. The Required Contract Provisions shall not be incorporated by reference in any case. The prime contractor shall be responsible for compliance by any subcontractor or lower tier subcontractor with these Required Contract Provisions.

3. A breach of any of the stipulations contained in these Required Contract Provisions shall be sufficient grounds for termination of the contract.

4. A breach of the following clauses of the Required Contract Provisions may also be grounds for debarment as provided in 29 CFR 5.12:

- Section I, paragraph 2;
- Section IV, paragraphs 1, 2, 3, 4 and 7;
- Section V, paragraphs 1 and 2a through 2g.

5. Disputes arising out of the labor standards provisions of Section IV (except paragraph 5) and Section V of these Required Contract Provisions shall not be subject to the general disputes clause of this contract. Such disputes shall be resolved in accordance with the procedures of the U.S. Department of Labor (DOL) as set forth in 29 CFR 5, 6 and 7. Disputes within the meaning of this clause include disputes between the contractor (or any of its subcontractors) and the contracting agency, the DOL, or the contractor's employees or their representatives.

6. Selection of Labor: During the performance of this contract, the contractor shall not:

- a. Discriminate against labor from any other State, possession, or territory of the United States (except for employment preference for Appalachian contracts, when applicable, as specified in Attachment A), or
- b. Employ convict labor for any purpose within the limits of the project unless it is labor performed by convicts who are on parole, supervised release, or probation.

**II. NONDISCRIMINATION**

1. Equal Employment Opportunity: Equal employment opportunity (EEO) requirements not to discriminate and to take affirmative action to assure equal opportunity as set forth under laws, executive orders, rules, regulations (28 CFR 35, 29 CFR 1630 and 41 CFR 60 (and orders of the Secretary of Labor as modified by the provisions prescribed herein, and imposed pursuant to 23 U.S.C. 140 shall constitute the EEO and specific affirmative action standards for the contractor's project activities under this contract. The Equal Opportunity Construction Contract Specifications set forth under 41 CFR 60-4.3 and the provisions of the American Disabilities Act of 1990 (42 U.S.C. 12101 et seq.) set forth under 28 CFR 35 and 29 CFR 1630 are incorporated by reference in this contract. In the execution of this contract, the contractor agrees to comply with the following minimum specific requirement activities of EEO:

a. The contractor will work with the State highway agency (SHA) and the Federal Government in carrying out EEO obligations and in their review of his/her activities under the contract.

b. The contractor will accept as his operating policy the following statement:

"It is the policy of this Company to assure that applicants are employed, and that employees are treated during employment, without regard to their race, religion, sex, color, national origin, age or disability. Such action shall include: employment, upgrading, demotion, or transfer; recruitment or recruitment advertising; layoff or termination; rates of pay or other forms of compensation; and selection for training, including apprenticeship, preapprenticeship, and/or on-the-job-training."

2. EEO Officer: The contractor will designate and make known to the SHA contracting officers an EEO Officer who will have the responsibility for an must be capable of effectively administering and promoting an active contractor program of EEO and who must be assigned adequate authority and responsibility to do so.

3. Dissemination of Policy: All members of the contractor's staff who are authorized to hire, supervise, promote, and discharge employees, or who recommend such action, or who are substantially involved in such action, will be made fully cognizant of, and will implement, the contractor's EEO policy and contractual responsibilities to provide EEO in each grade and classification of employment. To ensure that the above

agreement will be met, the following actions will be taken as a minimum:

a. Periodic meetings of supervisory and personnel office employees will be conducted before the start of work and then not less often than once every six months, at which time the contractor's EEO policy and its implementation will be reviewed and explained. The meetings will be conducted by the EEO Officer.

b. All new supervisory or personnel office employees will be given a thorough indoctrination by the EEO Officer, covering all major aspects of the contractor's EEO obligations within thirty days following their reporting for duty with the contractor.

c. All personnel who are engaged in direct recruitment for the project will be instructed by the EEO Officer in the contractor's procedures for locating and hiring minority group employees.

d. Notices and posters setting forth the contractor's EEO policy will be placed in areas readily accessible to employees, applicants for employment and potential employees.

e. The contractor's EEO policy and the procedures to implement such policy will be brought to the attention of employees by means of meetings, employee handbooks, or other appropriate means.

4. Recruitment: When advertising for employees, the contractor will include in all advertisements for employees the notation: "An Equal Opportunity Employer." All such advertisements will be placed in publications having a large circulation among minority groups in the area from which the project work force would normally be derived.

a. The contractor will, unless precluded by a valid bargaining agreement, conduct systematic and direct recruitment through public and private employees referral sources likely to yield qualified minority group applicants. To meet this requirement, the contractor will identify sources of potential minority group employees, and establish which such identified sources procedures whereby minority group applicants may be referred to the contractor for employment consideration.

b. In the event the contractor has a valid bargaining agreement providing for exclusive hiring hall referrals, he is expected to observe the provisions of that agreement to the extent that the system permits the contractor's compliance with EEO contract provisions. (The DOL has held that where implementation of such agreements have the effect of discriminating against minorities or women, or obligates the contractor to do the same, such implementation violates Executive Order 11246, as amended.)

c. The contractor will encourage his present employees to refer minority group applicants for employment. Information and procedures with regard to referring minority group applicants will be discussed with employees.

5. Personnel Actions: Wages, working conditions, and employee benefits shall be established and administered, and personnel actions of every type, including hiring, upgrading, promotion, transfer, demotion, layoff, and termination, shall be taken without regard to race, color, religion, sex, national origin, age or disability. The following procedures shall be followed:

a. The contractor will conduct periodic inspections of project sites to insure that working conditions and employee facilities do not indicate discriminatory treatment of project site personnel.

b. The contractor will periodically evaluate the spread of wages paid within each classification to determine any

evidence of discriminatory wage practices.

c. The contractor will periodically review selected personnel actions in depth to determine whether there is evidence of discrimination. Where evidence is found, the contractor will promptly take corrective action. If the review indicates that the discrimination may extend beyond the actions reviewed, such corrective action shall include all affected persons.

d. The contractor will promptly investigate all complaints of alleged discrimination made to the contractor in connection with his obligations under this contract, will attempt to resolve such complaints, and will take appropriate corrective action within a reasonable time. If the investigation indicates that the discrimination may affect persons other than the complainant, such corrective action shall include such other persons. Upon completion of each investigation, the contractor will inform every complainant of all of his avenues of appeal.

6. Training and Promotion:

a. The contractor will assist in locating, qualifying, and increasing the skills of minority group and women employees, and applicants for employment.

b. Consistent with the contractor's work force requirements and as permissible under Federal and State regulations, the contractor shall make full use of training programs, i.e., apprenticeship, and on-the-job training programs for the geographical area of contract performance. Where feasible, 25 percent of apprentices or trainees in each occupation shall be in their first year of apprenticeship or training. In the event a special provision for training is provided under this contract, this subparagraph will be superseded as indicated in the special provision.

c. The contractor will advise employees and applicants for employment of available training programs and entrance requirements for each.

d. The contractor will periodically review the training and promotion potential of minority group and women employees and will encourage eligible employees to apply for such training and promotion.

7. Unions: If the contractor relies in whole or in part upon unions as a source of employees, the contractor will use his/her best efforts to obtain the cooperation of such unions to increase opportunities for minority groups and women within the unions, and to effect referrals by such unions of minority and female employees. Actions by the contractor either directly or through a contractor's association acting as agent will include the procedures set forth below:

a. The contractor will use best efforts to develop, in cooperation with the unions, joint training programs aimed toward qualifying more minority group members and women for membership in the unions and increasing the skills of minority group employees and women so that they may qualify for higher paying employment.

b. The contractor will use best efforts to incorporate an EEO clause into each union agreement to the end that such union will be contractually bound to refer applicants without regard to their race, color, religion, sex, national origin, age or disability.

c. The contractor is to obtain information as to the referral practices and policies of the labor union except that to the extent such information is within the exclusive possession of the labor union and such labor union refuses to furnish such information to the contractor, the contractor shall so certify to

the SHA and shall set forth what efforts have been made to obtain such information.

d. In the event the union is unable to provide the contractor with a reasonable flow of minority and women referrals within the time limit set forth in the collective bargaining agreement, the contractor will, through independent recruitment efforts, fill the employment vacancies without regard to race, color, religion, sex, national origin, age or disability; making full efforts to obtain qualified and/or quailifiable minority group persons and women. (The DOL has held that it shall be no excuse that the union with which the contractor has a collective bargaining agreement providing for exclusive referral failed to refer minority employees.) In the event the union referral practice prevents the contractor from meeting the obligations pursuant to Executive Order 11246, as amended, and these special provisions, such contractor shall immediately notify the SHA.

8. Selection of Subcontractors, Procurement of Materials and Leasing of Equipment: The contractor shall not discriminate on the grounds of race, color, religion, sex, national origin, age or disability in the selection and retention of subcontractors, including procurement of materials and leases of equipment.

a. The contractor shall notify all potential subcontractors and suppliers of his/her EEO obligations under this contract.

b. Disadvantaged business enterprises (DBE), as defined in 49 CFR 23, shall have equal opportunity to compete for and perform subcontracts which the contractor enters into pursuant to this contract. The contractor will use his best efforts to solicit bids from and to utilize DBE subcontractors or subcontractors with meaningful minority group and female representation among their employees. Contractors shall obtain lists of DBE construction firms from SHA personnel.

c. The contractor will use his best efforts to ensure subcontractor compliance with their EEO obligations.

9. Records and Reports: The contractor shall keep such records as necessary to document compliance with the EEO requirements. Such records shall be retained for a period of three years following completion of the contract work and shall be available at reasonable times and places for inspection by authorized representatives of the SHA and the FHWA.

a. The records kept by the contractor shall document the following:

(1) The number of minority and non-minority group members and women employed in each work classification on the project;

(2) The progress and efforts being made in cooperation with unions, when applicable, to increase employment opportunities for minorities and women;

(3) The progress and efforts being made in locating, hiring, training, qualifying, and upgrading minority and female employees; and

(4) The progress and efforts being made in securing the services of DBE subcontractors or subcontractors with meaningful minority and female representation among their employees.

b. The contractors will submit an annual report to the SHA each July for the duration of the project, indicating the number of minority, women, and non-minority group employees currently engaged in each work classification required by the contract work. This information is to be reported on Form FHWA-1391. If on-the-job training is being required by special provision, the contractor will be required to collect and report training data.

### III. NONSEGREGATED FACILITIES

(Applicable to all Federal-aid construction contracts and to all related subcontracts of \$10,000 or more.)

a. By submission of this bid, the execution of this contract or subcontract, or the consummation of this material supply agreement or purchase order, as appropriate, the bidder, Federal-aid construction contractor, subcontractor, material supplier, or vendor, as appropriate, certifies that the firm does not maintain or provide for its employees any segregated facilities at any of its establishments, and that the firm does not permit its employees to perform their services at any location, under its control, where segregated facilities are maintained. The firm agrees that a breach of this certification is a violation of the EEO provisions of this contract. The firm further certifies that no employee will be denied access to adequate facilities on the basis of sex or disability.

b. As used in this certification, the term "segregated facilities" means any waiting rooms, work areas, restrooms and washrooms, restaurants and other eating areas, timeclocks, locker rooms, and other storage or dressing areas, parking lots, drinking fountains, recreation or entertainment areas, transportation, and housing facilities provided for employees which are segregated by explicit directive, or are, in fact, segregated on the basis of race, color, religion, national origin, age or disability, because of habit, local custom, or otherwise. The only exception will be for the disabled when the demands for accessibility override (e.g. disabled parking).

c. The contractor agrees that it has obtained or will obtain identical certification from proposed subcontractors or material suppliers prior to award of subcontracts or consummation of material supply agreements of \$10,000 or more and that it will retain such certifications in its files.

### IV. PAYMENT OF PREDETERMINED MINIMUM WAGE

(Applicable to all Federal-aid construction contracts exceeding \$2,000 and to all related subcontracts, except for projects located on roadways classified as local roads or rural minor collectors, which are exempt.)

#### 1. General:

a. All mechanics and laborers employed or working upon the site of the work will be paid unconditionally and not less often than once a week and without subsequent deduction or rebate on any account [except such payroll deductions as are permitted by regulations (29 CFR 3) issued by the Secretary of Labor under the Copeland Act (40 U.S.C. 276c)] the full amounts of wages and bona fide fringe benefits (or cash equivalents thereof) due at time of payment. The payment shall be computed at wage rates not less than those contained in the wage determination of the Secretary of Labor (hereinafter "the wage determination") which is attached hereto and made a part hereof, regardless of any contractual relationship which may be alleged to exist between the

contractor or its subcontractors and such laborers and mechanics. The wage determination (including any additional classifications and wage rates conformed under paragraph 2 of this Section IV and the DOL poster (WH-1321) or Form FHWA-1495) shall be posted at all times by the contractor and its subcontractors at the site of the work in a prominent and accessible place where it can be easily seen by the workers. For the purpose of this Section, contributions made or costs reasonably anticipated for bona fide fringe benefits under Section 1(b)(2) of the Davis-Bacon Act (40 U.S.C. 276a) on behalf of laborers or mechanics are considered wages paid to such laborers or mechanics, subject to the provisions of Section IV, paragraph 3b, hereof. Also, for the purpose of this Section, regular contributions made or costs incurred for more than a weekly period (but not less often than quarterly) under plans, funds, or programs, which cover the particular weekly period, are deemed to be constructively made or incurred during such weekly period. Such laborers and mechanics shall be paid the appropriate wage rate and fringe benefits on the wage determination for the classification of work actually performed, without regard to skill, except as provided in paragraphs 4 and 5 of this Section IV.

b. Laborers or mechanics performing work in more than one classification may be compensated at the rate specified for each classification for the time actually worked therein, provided, that the employer's payroll records accurately set forth the time spent in each classification in which work is performed.

c. All rulings and interpretations of the Davis-Bacon Act and related acts contained in 29 CFR 1, 3, and 5 are herein incorporated by reference in this contract.

## 2. Classification:

a. The SHA contracting officer shall require that any class of laborers or mechanics employed under the contract, which is not listed in the wage determination, shall be classified in conformance with the wage determination.

b. The contracting officer shall approve an additional classification, wage rate and fringe benefits only when the following criteria have been met:

(1) the work to be performed by the additional classification requested is not performed by a classification in the wage determination;

(2) the additional classification is utilized in the area by the construction industry;

(3) the proposed wage rate, including any bona fide fringe benefits, bears a reasonable relationship to the wage rates contained in the wage determination; and

(4) with respect to helpers, when such a classification prevails in the area in which the work is performed.

c. If the contractor or subcontractors, as appropriate, the laborers and mechanics (if known) to be employed in the additional classification or their representatives, and the contracting officer agree on the classification and wage rate (including the amount designated for fringe benefits where appropriate), a report of the action taken shall be sent by the contracting officer to the DOL, Administrator of the Wage and Hour Division, Employment Standards Administration, Washington, D.C. 20210. The Wage and Hour Administrator, or an authorized representative, will approve, modify, or

disapprove every additional classification action within 30 days of receipt and so advise the contracting officer or will notify the contracting officer within the 30-day period that additional time is necessary.

d. In the event the contractor or subcontractors, as appropriate, the laborers or mechanics to be employed in the additional classification or their representatives, and the contracting officer do not agree on the proposed classification and wage rate (including the amount designated for fringe benefits, where appropriate), the contracting officer shall refer the question, including the views of all interested parties and the recommendation of the contracting officer, to the Wage and Hour Administrator for determination. Said Administrator, or an authorized representative, will issue a determination within 30 days of receipt and so advise the contracting officer or will notify the contracting officer within the 30-day period that additional time is necessary.

e. The wage rate (including fringe benefits where appropriate) determined pursuant to paragraph 2c or 2d of this Section IV shall be paid to all workers performing work in the additional classification from the first day on which work is performed in the classification.

## 3. Payment of Fringe Benefits:

a. Whenever the minimum wage rate prescribed in the contract for a class of laborers or mechanics includes a fringe benefit which is not expressed as an hourly rate, the contractor or subcontractors, as appropriate, shall either pay the benefit as stated in the wage determination or shall pay another bona fide fringe benefit or an hourly case equivalent thereof.

b. If the contractor or subcontractor, as appropriate, does not make payments to a trustee or other third person, he/she may consider as a part of the wages of any laborer or mechanic the amount of any cost reasonably anticipated in providing bona fide fringe benefits under a plan or program, provided that the Secretary of Labor has found, upon the written request of the contractor, that the applicable standards of the Davis-Bacon Act have been met. The Secretary of Labor may require the contractor to set aside in a separate account assets for the meeting of obligations under the plan or program.

## 4. Apprentices and Trainees (Programs of the U.S. DOL) and Helpers:

### a. Apprentices:

(1) Apprentices will be permitted to work at less than the predetermined rate for the work they performed when they are employed pursuant to and individually registered in a bona fide apprenticeship program registered with the DOL, Employment and Training Administration, Bureau of Apprenticeship and Training, or with a State apprenticeship agency recognized by the Bureau, or if a person is employed in his/her first 90 days of probationary employment as an apprentice in such an apprenticeship program, who is not individually registered in the program, but who has been certified by the Bureau of Apprenticeship and Training or a State apprenticeship agency (where appropriate) to be eligible for probationary employment as an apprentice.

(2) The allowable ratio of apprentices to journeyman-level employees on the job site in any craft classification shall not

listed on the wage determination unless the Administrator of the

be greater than the ratio permitted to the contractor as to the entire work force under the registered program. Any employee listed on a payroll at an apprentice wage rate, who is not registered or otherwise employed as stated above, shall be paid not less than the applicable wage rate listed in the wage determination for the classification of work actually performed. In addition, any apprentice performing work on the job site in excess of the ratio permitted under the registered program shall be paid not less than the applicable wage rate on the wage determination for the work actually performed. Where a contractor or subcontractor is performing construction on a project in a locality other than that in which its program is registered, the ratios and wage rates (expressed in percentages of the journeyman-level hourly rate) specified in the contractor's or subcontractor's registered program shall be observed.

(3) Every apprentice must be paid at not less than the rate specified in the registered program for the apprentice's level of progress, expressed as a percentage of the journeyman-level hourly rate specified in the applicable wage determination. Apprentices shall be paid fringe benefits in accordance with the provisions of the apprenticeship program. If the apprenticeship program does not specify fringe benefits, apprentices must be paid the full amount of fringe benefits listed on the wage determination for the applicable classification. If the Administrator for the Wage and Hour Division determines that a different practice prevails for the applicable apprentice classification, fringes shall be paid in accordance with that determination.

(4) In the event the Bureau of Apprenticeship and Training, or a State apprenticeship agency recognized by the Bureau, withdraws approval of an apprenticeship program, the contractor or subcontractor will no longer be permitted to utilize apprentices at less than the applicable predetermined rate for the comparable work performed by regular employees until an acceptable program is approved.

b. Trainees:

(1) Except as provided in 29 CFR 5.16, trainees will not be permitted to work at less than the predetermined rate for the work performed unless they are employed pursuant to and individually registered in a program which has received prior approval, evidenced by formal certification by the DOL, Employment and Training Administration.

(2) The ratio of trainees to journeyman-level employees on the job site shall not be greater than permitted under the plan approved by the Employment and Training Administration. Any employee listed on the payroll at a trainee rate who is not registered and participating in a training plan approved by the Employment and Training Administration shall be paid not less than the applicable wage rate on the wage determination for the classification of work actually performed. In addition, any trainee performing work on the job site in excess of the ratio permitted under the registered program shall be paid not less than the applicable wage rate on the wage determination for the work actually performed.

(3) Every trainee must be paid at not less than the rate specified in the approved program for his/her level of progress, expressed as a percentage of the journeyman-level hourly rate specified in the applicable wage determination. Trainees shall be paid fringe benefits in accordance with the provisions of the trainee program. If the trainee program does not mention fringe benefits, trainees shall be paid the full amount of fringe benefits

Wage and Hour Division determines that there is an apprenticeship program associated with the corresponding journeyman-level wage rate on the wage determination which provides for less than full fringe benefits for apprentices, in which cases such trainees shall receive the same fringe benefits as apprentices.

(4) In the event the Employment and Training Administration withdraws approval of a training program, the contractor or subcontractor will no longer be permitted to utilize trainees at less than the applicable predetermined rate for the work performed until an acceptable program is approved.

c. Helpers:

Helpers will be permitted to work on a project if the helper classification is specified and defined on the applicable wage determination or is approved pursuant to the conformance procedure set forth in Section IV. 2. Any worker listed on a payroll at a helper wage rate, who is not a helper under a approved definition, shall be paid not less than the applicable wage rate on the wage determination for the classification of work actually performed.

5. Apprentices and Trainees (Programs of the U.S. DOT):

Apprentices and trainees working under apprenticeship and skill training programs which have been certified by the Secretary of Transportation as promoting EEO in connection with Federal-aid highway construction programs are not subject to the requirements of paragraph 4 of this Section IV. The straight time hourly wage rates for apprentices and trainees under such programs will be established by the particular programs. The ratio of apprentices and trainees to journeymen shall not be greater than permitted by the terms of the particular program.

6. Withholding:

The SHA shall upon its own action or upon written request of an authorized representative of the DOL withhold, or cause to be withheld, from the contractor or subcontractor under this contract or any other Federal contract with the same prime contractor or any other Federally-assisted contract subject to Davis-Bacon prevailing wage requirements which is held by the same prime contractor, as much of the accrued payments or advances as may be considered necessary to pay laborers and mechanics, including apprentices, trainee's and helpers, employed by the contractor or any subcontractor the full amount of wages required by the contract. In the event of failure to pay any laborer or mechanic, including any apprentice, trainee, or helper, employed or working on the site of the work, all or part of the wages required by the contract, the SHA contracting officer may, after written notice to the contractor, take such action as may be necessary to cause the suspension of any further payment, advance, or guarantee of funds until such violations have ceased.

7. Overtime Requirements:

No contractor or subcontractor contracting for any part of the contract work which may require or involve the employment of laborers, mechanics, watchmen, or guards (including apprentices, trainees, and helpers described in paragraphs 4 and 5 above) shall require or permit any laborer, mechanic, watchman, or guard in any workweek in which he/she is employed on such work, to work in excess of 40 hours in such workweek unless such laborer, mechanic, watchman, or guard receives compensation at a rate not less than one-and-one-half times his/her basic rate of pay for all hours worked in excess of 40 hours in such workweek.



8. Violation:

Liability for Unpaid Wages; Liquidated Damages: In the event of any violation of the clause set forth in paragraph 7 above, the contractor and any subcontractor responsible thereof shall be liable to the affected employee for his/her unpaid wages. In addition, such contractor and subcontractor shall be liable to the United States (in the case of work done under contract for the District of Columbia or a territory, to such District or to such territory) for liquidated damages. Such liquidated damages shall be computed with respect to each individual laborer, mechanic, watchman, or guard employed in violation of the clause set forth in paragraph 7, in the sum of \$10 for each calendar day on which such employee was required or permitted to work in excess of the standard work week of 40 hours without payment of the overtime wages required by the clause set forth in paragraph 7.

9. Withholding for Unpaid Wages and Liquidated Damages:

The SHA shall; upon its own action or upon written request of any authorized representative of the DOL withhold, or cause to be withheld, from any monies payable on account of work performed by the contractor or subcontractor under any such contract or any other Federal contract with the same prime contractor, or any other Federally-assisted contract subject to the Contract Work Hours and Safety Standards Act, which is held by the same prime contractor, such sums as may be determined to be necessary to satisfy any liabilities of such contractor or subcontractor for unpaid wages and liquidated damages as provided in the clause set forth in paragraph 8 above.

**V. STATEMENTS AND PAYROLLS**

(Applicable to all Federal-aid construction contracts exceeding \$2,000 and to all related subcontracts, except for projects located on roadways classified as local roads or rural collectors, which are exempt.)

1. Compliance with Copeland Regulations (29 CFR 3):

The contractor shall comply with the Copeland Regulations of the Secretary of Labor which are herein incorporated by reference.

2. Payrolls and Payroll Records:

a. Payrolls and basic records relating thereto shall be maintained by the contractor and each subcontractor during the course of the work and preserved for a period of 3 years from the date of completion of the contract for all laborers, mechanics, apprentices, trainees, watchmen, helpers, and guards working at the site of the work.

b. The payroll records shall contain the name, social security number, and address of each such employee; his or her correct classification; hourly rates of wages paid (including rates of contributions or costs anticipated for bona fide fringe benefits or cash equivalent thereof the types described in Section 1(b)(2)(B) of the Davis Bacon Act); daily and weekly number of hours worked; deductions made; and actual wages paid. In addition, for Appalachian contracts, the payroll records shall contain a notation indicating whether the employee does, or does not, normally reside in the labor area as defined in Attachment A, paragraph 1. Whenever the Secretary of Labor, pursuant to Section IV, paragraph 3b, has found that the wages of any laborer or mechanic include the amount of any costs reasonably anticipated in providing benefits under a plan

or program described in Section 1(b)(2)(B) of the Davis Bacon Act, the contractor and each subcontractor shall maintain records which show that the commitment to provide such benefits is enforceable, that the plan or program is financially responsible, that the plan or program has been communicated in writing to the laborers or mechanics affected, and show the cost anticipated or the actual cost incurred in providing benefits. Contractors or subcontractors employing apprentices or trainees under approved programs shall maintain written evidence of the registration of apprentices and trainees, and ratios and wage rates prescribed in the applicable programs.

c. Each contractor and subcontractor shall furnish, each week in which any contract work is performed, to the SHA resident engineer a payroll of wages paid each of its employees (including apprentices trainees, and helpers, described in Section IV, paragraphs 4 and 5, and watchmen and guards engaged on work during the preceding weekly payroll period).

The payroll submitted shall set out accurately and completely all of the information required to be maintained under paragraph 2b of this Section V.

This information may be submitted in any form desired. Optional Form WH-347 is available for this purpose and may be purchased from the Superintendent of Documents (Federal stock number 029-005-0014-1), U.S. Government Printing Office, Washington, D.C. 20402. The prime contractor is responsible for the submission of copies of payrolls by all subcontractors.

d. Each payroll submitted shall be accompanied by a "Statement of Compliance," signed by the Contractor or subcontractor or his/her agent who pays or supervises the payment of the persons employed under the contract and shall certify the following:

(1) that the payroll for the payroll period contains the information required to be maintained under paragraph 2b of this Section V and that such information is correct and complete;

(2) that such laborer or mechanic (including each helper, apprentice, and trainee) employed on the contract during the payroll period has been paid the full weekly wages earned, without rebate, either directly or indirectly, and that no deductions have been made either directly or indirectly from the full wages earned, other than permissible deductions as set forth in the Regulations, 29 CFR 3;

(3) that each laborer or mechanic has been paid not less than the applicable wage rate and fringe benefits or cash equivalent for the classification of work performed, as specified in the applicable wage determination incorporated into the contract.

e. The weekly submission of a properly executed certification set forth on the reverse side of Optional Form WH-347 shall satisfy the requirement for submission of the "Statement of Compliance" required by paragraph 2d of this Section V.

f. The falsification of any of the above certifications may subject the contractor to civil or criminal prosecution under 18 U/S. C. 1001 and 31 U.S.C. 231.

g. The contractor or subcontractor shall make the records required under paragraph 2b of this Section V available for

inspection, copying, or transcription by authorized representatives of the SHA, the FHWA, or the DOL, and shall permit such representatives to interview employees during working hours on the job. If the contractor or subcontractor fails to submit the required records or to make them available, the SHA, the FHWA, the DOL, or all may, after written notice to the contractor, sponsor, applicant, or owner, take such actions as may be necessary to cause the suspension of any further payment, advance, or guarantee of funds. Furthermore, failure to submit the required records upon request or to make such records available may be grounds for debarment action pursuant to 29 CFR 5.12.

## **VI. RECORD OF MATERIALS, SUPPLIES, AND LABOR**

1. On all federal-aid contracts on the national highway system, except those which provide solely for the installation of protective devices at railroad grade crossings, those which are constructed on a force account or direct labor basis, highway beautification contracts, and contracts for which the total final construction cost for roadway and bridge is less than \$1,000,000 (23 CFR 635) the contractor shall:

- a. Become familiar with the list of specific materials and supplies contained in Form FHWA-47, "Statement of Materials and Labor Used by Contractor of Highway Construction Involving Federal Funds," prior to the commencement of work under this contract.
- b. Maintain a record of the total cost of all materials and supplies purchased for and incorporated in the work, and also of the quantities of those specific materials and supplies listed on Form FHWA-47, and in the units shown on Form FHWA-47.
- c. Furnish, upon the completion of the contract, to the SHA resident engineer on Form FHWA-47 together with the data required in paragraph 1b relative to materials and supplies, a final labor summary of all contract work indicating the total hours worked and the total amount earned.

2. At the prime contractor's option, either a single report covering all contract work or separate reports for the contractor and for each subcontract shall be submitted.

## **VII. SUBLETTING OR ASSIGNING THE CONTRACT**

1. The contractor shall perform with its own organization contract work amounting to not less than 30 percent (or a greater percentage if specified elsewhere in the contract) of the total original contract price, excluding any specialty items designated by the State. Specialty items may be performed by subcontract and the amount of any such specialty items performed may be deducted from the total original contract price before computing the amount of work required to be performed by the contractor's own organization (23 CFR 635).

- a. "Its own organization" shall be construed to include only workers employed and paid directly by the prime contractor and equipment owned or rented by the prime contractor, with or without operators. Such term does not include employees or equipment of a subcontractor, assignee, or agent of the prime contractor.
- b. "Specialty Items" shall be construed to be limited to work that requires highly specialized knowledge, abilities, or equipment not ordinarily available in the type of contracting organizations qualified and expected to bid on the contract as a

whole and in general are to be limited to minor components of the overall contract.

2. The contract amount upon which the requirements set forth in paragraph 1 of Section VII is computed includes the cost of material and manufactured products which are to be purchased or produced by the contractor under the contract provisions.

3. The contractor shall furnish (a) a competent superintendent or supervisor who is employed by the firm, has full authority to direct performance of the work in accordance with the contract requirements, and is in charge of all construction operations (regardless of who performs the work) and (b) such other of its own organizational resources (supervision, management, and engineering services) as the SHA contracting officer determines is necessary to assure the performance of the contract.

4. No portion of the contract shall be sublet, assigned or otherwise disposed of except with the written consent of the SHA contracting officer, or authorized representative, and such consent when given shall not be construed to relieve the contractor of any responsibility for the fulfillment of the contract.

Written consent will be given only after the SHA has assured that each subcontract is evidenced in writing and that it contains all pertinent provisions and requirements of the prime contract.

## **VIII. SAFETY: ACCIDENT PREVENTION**

1. In the performance of this contract the contractor shall comply with all applicable Federal, State, and local laws governing safety, health, and sanitation (23 CFR 635). The contractor shall provide all safeguards, safety devices and protective equipment and take any other needed actions as it determines, or as the SHA contracting officer may determine, to be reasonably necessary to protect the life and health of employees on the job and the safety of the public and to protect property in connection with the performance of the work covered by the contract.

2. It is a condition of this contract, and shall be made a condition of each subcontract, which the contractor enters into pursuant to this contract, that the contractor and any subcontractor shall not permit any employee, in performance of the contract, to work in surroundings or under conditions which are unsanitary, hazardous or dangerous to his/her health or safety, as determined under construction safety and health standards (29 CFR 1926) promulgated by the Secretary of Labor, in accordance with Section 107 of the Contract Work Hours and Safety Standards Act (40 U.S.C. 333).

3. Pursuant to 29 CFR 1926.3, it is a condition of this contract that the Secretary of Labor or authorized representative thereof, shall have right of entry to any site of contract performance to inspect or investigate the matter of compliance with the construction safety and health standards and to carry out the duties of the Secretary under Section 107 of the Contract Work Hours and Safety Standards Act (40 U.S.C. 333).

## **IX. FALSE STATEMENTS CONCERNING HIGHWAY PROJECTS**

In order to assure high quality and durable construction in conformity with approved plans and specifications and a high degree of reliability on statements and representations made by engineers, contractors, suppliers, and workers on Federal-aid highway projects, it is essential that all persons concerned with the project perform their functions as carefully, thoroughly, and honestly as possible. Willful falsification,

distortion, or misrepresentation with respect to any facts related to the project is a violation of Federal law. To prevent any misunderstanding regarding the seriousness of these and similar acts, the following notice shall be posted on each Federal-aid highway project (23 CFR 635) in one or more places where it is readily available to all persons concerned with the project:

#### **NOTICE TO ALL PERSONNEL ENGAGED ON FEDERAL-AID HIGHWAY PROJECTS**

18 U.S.C. 1020 reads as follows:

*"Whoever, being an officer, agent or employee of the United States, or of any State or Territory, or whoever, whether a person, association, firm, or corporation, knowingly makes any false statement, false representation, or false report as to the character, quality, quantity, or cost of the material used or to be used, or the quantity or quality of the work performed or to be performed, or the cost thereof in connection with the submission of plans, maps, specifications, contracts, or costs of construction on any highway or related project submitted for approval to the Secretary of Transportation; or*

*Whoever knowingly makes any false statement, false representation, false report or false claim with respect to the character, quality, quantity, or cost of any work performed or to be performed, or materials furnished or to be furnished, in connection with the construction of any highway or related project approved by the Secretary of Transportation; or*

*Whoever knowingly makes any false statement or false representation as to material fact in any statement, certificate, or report submitted pursuant to provisions of the Federal-aid Roads Act approved July 1, 1916, (39 Stat. 355), as amended and supplemented;*

*Shall be fined not more than \$10,000 or imprisoned not more than 5 years or both."*

#### **X. IMPLEMENTATION OF CLEAN AIR ACT AND FEDERAL WATER POLLUTION CONTROL ACT**

(Applicable to all Federal-aid construction contracts and to all related subcontracts of \$100,000 or more).

By submission of this bid or the execution of this contract, or subcontract, as appropriate, the bidder, Federal-aid construction contractor, or subcontractor, as appropriate, will be deemed to have stipulated as follows:

1. That any facility that is or will be utilized in the performance of this contract, unless such contract is exempt under the Clean Air Act, as amended (42 U.S.C. 1857 et seq., as amended by Pub.L. 91-604), and under the Federal Water Pollution Control Act, as amended (33 U.S.C. 1251 et seq., as amended by Pub.L. 92-500), Executive Order 11738, and regulations in implementation thereof (40 CFR 15) is not listed, on the date of contract award, on the U.S. Environmental Protection Agency (EPA) List of Violating Facilities pursuant to 40 CFR 15.20.

2. That the firm agrees to comply and remain in compliance with all the requirements of Section 114 of the Clean Air Act and Section 308 of the Federal Water Pollution Control Act and all regulations and guidelines listed thereunder.

3. That the firm shall promptly notify the SHA of the receipt of

any communication from the Director, Office of Federal Activities, EPA indicating that a facility that is or will be utilized for the contract is under consideration to be listed on the EPA List of Violating Facilities.

4. That the firm agrees to include or cause to be included the requirements of paragraph 1 through 4 of this Section X in every nonexempt subcontract, and further agrees to take such action as the government may direct as a means of enforcing such requirements.

#### **XI. CERTIFICATION REGARDING DEBARMENT, SUSPENSION, INELIGIBILITY AND VOLUNTARY EXCLUSION**

1. Instructions for Certification - Primary Covered Transactions:

(Applicable to all Federal-aid contracts - 49 CFR 29)

a. By signing and submitting this proposal, the prospective primary participant is providing the certification set out below.

b. The inability of a person to provide the certification set out below will not necessarily result in denial of participation in this covered transaction. The prospective participant shall submit an explanation of why it cannot provide the certification set out below. The certification or explanation will be considered in connection with the department or agency's determination whether to enter into this transaction. However, failure of the prospective primary participant to furnish a certification or an explanation shall disqualify such a person from participation in this transaction.

c. The certification in this clause is a material representation of fact upon which reliance was placed when the department or agency determined to enter into this transaction. If it is later determined that the prospective primary participant knowingly rendered an erroneous certification, in addition to other remedies available to the Federal Government, the department or agency may terminate this transaction for cause of default.

d. The prospective primary participant shall provide immediate written notice to the department or agency to whom this proposal is submitted if any time the prospective primary participant learns that its certification was erroneous when submitted or has become erroneous by reason of changed circumstances.

e. The terms "covered transaction," "debarred," "suspended," "ineligible," "lower tier covered transaction," "participant," "person," "primary covered transaction," "principal," "proposal," and "voluntarily excluded," as used in this clause, have the meanings set out in the Definitions and Coverage sections of rules implementing Executive Order 12549. You may contact the department or agency to which this proposal is submitted for assistance in obtaining a copy of those regulations.

f. The prospective primary participant agrees by submitting this proposal that, should the proposed covered transaction be entered into, it shall not knowingly enter into any lower tier covered transaction with a person who is debarred, suspended, declared ineligible, or voluntarily excluded from participation in this covered transaction, unless authorized by the department or agency entering into this transaction.

g. The prospective primary participant further agrees by submitting this proposal that it will include the clause titled

\*\*\*\*\*

"Certification Regarding Debarment, Suspension, Ineligibility and Voluntary Exclusion-Lower Tier Covered Transaction," provided by the department or agency entering into this covered transaction, without modification in all lower tier covered transactions and in all solicitations for lower tier covered transactions.

h. A participant in a covered transaction may rely upon a certification of a prospective participant in a lower tier covered transaction that is not debarred, suspended, ineligible, or voluntarily excluded from the covered transaction, unless it knows that the certification is erroneous. A participant may decide the method and frequency by which it determines the eligibility of its principals. Each participant may, but is not required to, check the nonprocurement portion of the "Lists of Parties Excluded from Federal Procurement or Nonprocurement Programs" (Nonprocurement List) which is compiled by the General Services Administration.

i. Nothing contained in the foregoing shall be construed to require establishment of a system of records in order to render in good faith the certification required by this clause. The knowledge and information of participant is not required to exceed that which is normally possessed by a prudent person in the ordinary course of business dealings.

j. Except for transactions authorized under paragraph f of these instructions, if a participant in a covered transaction knowingly enters into a lower tier covered transaction with a person who is suspended, debarred, ineligible, or voluntarily excluded from participation in this transaction, in addition to other remedies available to the Federal Government, the department or agency may terminate this transaction for cause or default.

\*\*\*\*\*

### **Certification Regarding Debarment, Suspension, Ineligibility and Voluntary Exclusion-Primary Covered Transactions**

1. The prospective primary participant certifies to the best of its knowledge and belief, that it and its principals:

- a. Are not presently debarred, suspended, proposed for debarment, declared ineligible, or voluntarily excluded from covered transactions by any Federal department or agency;
- b. Have not within a 3-year period preceding this proposal been convicted of or had a civil judgment rendered against them for commission of fraud or a criminal offense in connection with obtaining, attempting to obtain, or performing a public (Federal, State or local) transaction or contract under a public transaction; violation of Federal or State antitrust statutes or commission of embezzlement, theft, forgery, bribery, falsification or destruction of records, making false statements, or receiving stolen property;
- c. Are not presently indicted for or otherwise criminally or civilly charged by a governmental entity (Federal, State or local) with commission of any of the offenses enumerated in paragraph 1b of this certification; and
- d. Have not within a 3-year period preceding this application/proposal had one or more public transactions (Federal, State or local) terminated for cause or default.

2. Where the prospective primary participant is unable to certify to any of the statements in this certification, such prospective participant shall attach an explanation to this proposal.

### **2. Instructions for Certification - Lower Tier Covered Transactions:**

(Applicable to all subcontracts, purchase orders and other lower tier transactions of \$25,000 or more - 49 CFR 29)

- a. By signing and submitting this proposal, the prospective lower tier is providing the certification set out below.
- b. The certification in this clause is a material representation of fact upon which reliance was placed when this transaction was entered into. If it is later determined that the prospective lower tier participant knowingly rendered an erroneous certification, in addition to other remedies available to the Federal Government, the department, or agency with which this transaction originated may pursue available remedies, including suspension and/or debarment.
- c. The prospective lower tier participant shall provide immediate written notice to the person to which this proposal is submitted if at any time the prospective lower tier participant learns that its certification was erroneous by reason of changed circumstances.
- d. The terms "covered transaction," "debarred," "suspended," "ineligible," "primary covered transaction," "participant," "person," "principal," "proposal," and "voluntarily excluded," as used in this clause, have the meanings set out in the Definitions and Coverage sections of rules implementing Executive Order 12549. You may contact the person to which this proposal is submitted for assistance in obtaining a copy of those regulations.
- e. The prospective lower tier participant agrees by submitting this proposal that, should the proposed covered transaction be entered into, it shall not knowingly enter into any lower tier covered transaction with a person who is debarred, suspended, declared ineligible, or voluntarily excluded from participation in this covered transaction, unless authorized by the department or agency with which this transaction originated.
- f. The prospective lower tier participant further agrees by submitting this proposal that it will include this clause titled "Certification Regarding Debarment, Suspension, Ineligibility and Voluntary Exclusion-Lower Tier Covered Transaction," without modification, in all lower tier covered transactions and in all solicitations for lower tier covered transactions.
- g. A participant in a covered transaction may rely upon a certification of a prospective participant in a lower tier covered transaction that is not debarred, suspended, ineligible, or voluntarily excluded from the covered transaction, unless it knows that the certification is erroneous. A participant may decide the method and frequency by which it determines the eligibility of its principals. Each participant may, but is not required to, check the Nonprocurement List.
- h. Nothing contained in the foregoing shall be construed to require establishment of a system of records in order to render in good faith the certification required by this clause. The knowledge and information of participant is not required to exceed that which is normally possessed by a prudent person in the ordinary course of business dealing.
- i. Except for transactions authorized under paragraph e of these instructions, if a participant in a covered transaction knowingly enters into a lower tier covered transaction with a person who is suspended, debarred, ineligible, or voluntarily

excluded from participation in this transaction, in addition to other remedies available to the Federal Government, the department or agency with which this transaction originated may pursue available remedies, including suspension and/or debarment.

\*\*\*\*\*

**Certification Regarding Debarment, Suspension, Ineligibility And Voluntary Exclusion-Lower Tier Covered Transactions:**

1. The prospective lower tier participant certifies, by submission of this proposal, that neither it nor its principals is presently debarred, suspended, proposed for debarment, declared ineligible, or voluntarily excluded from participation in this transaction by any Federal department or agency.

2. Where the prospective lower tier participant is unable to certify to any of the statements in this certification, such prospective participant shall attach an explanation to this proposal.

\*\*\*\*\*

**XII. CERTIFICATION REGARDING USE OF CONTRACT FUNDS FOR LOBBYING**

(Applicable to all Federal-aid construction contracts and to all related subcontracts which exceed \$100,000 - 49 CFR 20)

1. The prospective participant certifies, by signing and submitting this bid or proposal, to the best of his or her knowledge and belief, that:

a. No Federal appropriated funds have been paid or will be paid, by or on behalf of the undersigned, to any person for influencing or attempting to influence an officer or employee of any Federal agency, a Member of Congress, an officer or employee of Congress, or an employee of a Member of Congress in connection with the awarding of any Federal contract, the making of any Federal grant, the making of any Federal loan, the entering into of any cooperative agreement, and the extension, continuation, renewal, amendment, or modification of any Federal contract, grant, loan, or cooperative agreement.

b. If any funds other than Federal appropriated funds have been paid or will be paid to any person for influencing or attempting to influence an officer or employee of any Federal agency, a Member of Congress, an officer or employee of Congress, or an employee of a Member of Congress in connection with this Federal contract, grant, loan, or cooperative agreement, the undersigned shall complete and submit Standard Form-LLL, "Disclosure Form to Report Lobbying," in accordance with its instructions.

2. This certification is a material representation of fact upon which reliance was placed when this transaction was made or entered into. Submission of this certification is a prerequisite for making or entering into this transaction imposed by 31 U.S.C. 1352. Any person who fails to file the required certification shall be subject to a civil penalty of not less than \$10,000 and not more than \$100,000 for each such failure.

3. The prospective participant also agrees by submitting his or her bid or proposal that he or she shall require that the language of this certification be included in all lower tier subcontracts, which exceed \$100,000 and that all such recipients shall certify and disclose accordingly.

## **MINIMUM WAGES FOR FEDERAL AND FEDERALLY ASSISTED CONSTRUCTION CONTRACTS**

This project is funded, in part, with Federal-aid funds and, as such, is subject to the provisions of the Davis-Bacon Act of March 3, 1931, as amended (46 Sta. 1494, as amended, 40 U.S.C. 276a) and of other Federal statutes referred to in a 29 CFR Part 1, Appendix A, as well as such additional statutes as may from time to time be enacted containing provisions for the payment of wages determined to be prevailing by the Secretary of Labor in accordance with the Davis-Bacon Act and pursuant to the provisions of 29 CFR Part 1. The prevailing rates and fringe benefits shown in the General Wage Determination Decisions issued by the U.S. Department of Labor shall, in accordance with the provisions of the foregoing statutes, constitute the minimum wages payable on Federal and federally assisted construction projects to laborers and mechanics of the specified classes engaged on contract work of the character and in the localities described therein.

General Wage Determination Decisions, modifications and supersedes decisions thereto are to be used in accordance with the provisions of 29 CFR Parts 1 and 5. Accordingly, the applicable decision, together with any modifications issued, must be made a part of every contract for performance of the described work within the geographic area indicated as required by an applicable DBRA Federal prevailing wage law and 29 CFR Part 5. The wage rates and fringe benefits contained in the General Wage Determination Decision

### **NOTICE**

The most current **General Wage Determination Decisions** (wage rates) are available on the IDOT web site. They are located on the Letting and Bidding page at <http://www.dot.il.gov/desenv/delett.html>.

In addition, ten (10) days prior to the letting, the applicable Federal wage rates will be e-mailed to subscribers. It is recommended that all contractors subscribe to the Federal Wage Rates List or the Contractor's Packet through IDOT's subscription service.

PLEASE NOTE: if you have already subscribed to the Contractor's Packet you will automatically receive the Federal Wage Rates.

The instructions for subscribing are at <http://www.dot.il.gov/desenv/subsc.html>.

If you have any questions concerning the wage rates, please contact IDOT's Chief Contract Official at 217-782-7806.