

| | | | | |
|---------------------|---------|---------------------------|--------------|-----------|
| F.A. RTE. | SECTION | COUNTY | TOTAL SHEETS | SHEET NO. |
| | | | 187 | 142 |
| STA. | | TO STA. | | |
| FED. ROAD DIST. NO. | | ILLINOIS FED. AID PROJECT | | |

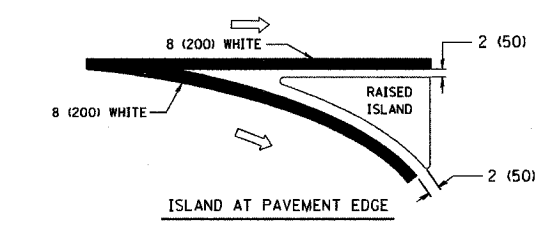
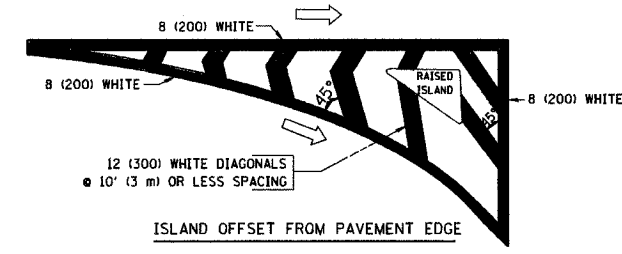
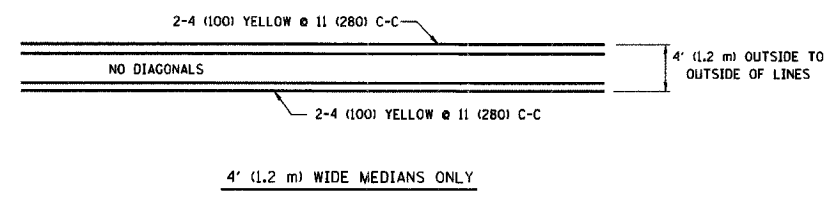
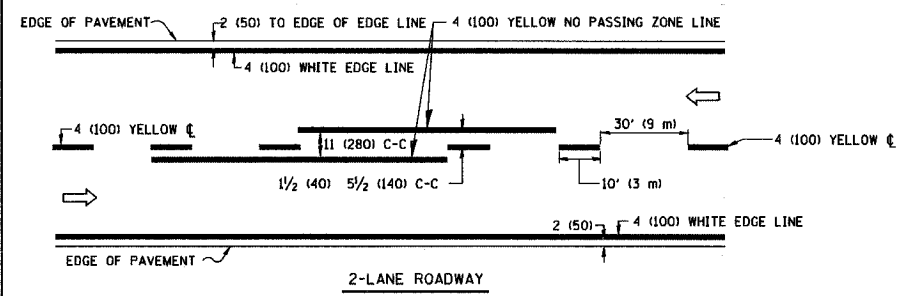

TYPICAL ISLAND MARKING

| TYPE OF MARKING | WIDTH OF LINE | PATTERN | COLOR | SPACING / REMARKS |
|---|--|---------------------------------|---|--|
| CENTERLINE ON 2 LANE PAVEMENT | 4 (100) | SKIP-DASH | YELLOW | 10' (3 m) LINE WITH 30' (9 m) SPACE |
| CENTERLINE ON MULTI-LANE UNDIVIDED PAVEMENT | 2 @ 4 (100) | SOLID | YELLOW | 11 (280) C-C |
| NO PASSING ZONE LINES FOR ONE DIRECTION FOR BOTH DIRECTIONS | 4 (100) 2 @ 4 (100) | SOLID SOLID | YELLOW YELLOW | 5/2 (140) C-C FROM SKIP-DASH CENTERLINE 11 (280) C-C OMIT SKIP-DASH CENTERLINE BETWEEN |
| LANE LINES | 4 (100) 5 (125) ON FREEWAYS | SKIP-DASH SKIP-DASH | WHITE WHITE | 10' (3 m) LINE WITH 30' (9 m) SPACE |
| DOTTED LINES (EXTENSIONS OF CENTER, LANE OR TURN LANE MARKINGS) | SAME AS LINE BEING EXTENDED | SKIP-DASH | SAME AS LINE BEING EXTENDED | 2' (600) LINE WITH 6' (1.8 m) SPACE |
| EDGE LINES | 4 (100) | SOLID | YELLOW-LEFT WHITE-RIGHT | OUTLINE MOUNTABLE MEDIANS IN YELLOW; EDGE LINES ARE NOT USED NEXT TO BARRIER CURB |
| TURN LANE MARKINGS | 6 (150) LINE; FULL SIZE LETTERS & SYMBOLS (8' (2.4m)) | SOLID | WHITE | SEE TYPICAL TURN LANE MARKING DETAIL |
| TWO WAY LEFT TURN MARKING | 2 @ 4 (100) EACH DIRECTION 8' (2.4m) LEFT ARROW | SKIP-DASH AND SOLID IN PAIRS | YELLOW WHITE | 10' (3 m) LINE WITH 30' (9 m) SPACE FOR SKIP-DASH; 5/2 (140) C-C BETWEEN SOLID LINE AND SKIP-DASH LINE SEE TYPICAL TWO-WAY LEFT TURN MARKING DETAIL |
| CROSSWALK LINES (PEDESTRIAN) A. DIAGONALS (BIKE & EQUESTRIAN) B. LONGITUDINAL BARS (SCHOOL) | 2 @ 6 (150) 12 (300) @ 45° 12 (300) @ 90° | SOLID SOLID SOLID | WHITE WHITE WHITE | NOT LESS THAN 6' (1.8 m) APART 2' (600) APART 2' (600) APART SEE TYPICAL CROSSWALK MARKING DETAILS. |
| STOP LINES | 24 (600) | SOLID | WHITE | PLACE 4' (1.2 m) IN ADVANCE OF AND PARALLEL TO CROSSWALK, IF PRESENT. OTHERWISE, PLACE AT DESIRED STOPPING POINT. PARALLEL TO CROSSROAD CENTERLINE, WHERE POSSIBLE |
| PAINTED MEDIANS | 2 @ 4 (100) WITH 12 (300) DIAGONALS @ 45° NO DIAGONALS USED FOR 4' (1.2 m) WIDE MEDIANS | SOLID | YELLOW; TWO WAY TRAFFIC WHITE; ONE WAY TRAFFIC | 11 (280) C-C FOR THE DOUBLE LINE SEE TYPICAL PAINTED MEDIAN MARKING. |
| GORE MARKING AND CHANNELIZING LINES | 8 (200) WITH 12 (300) DIAGONALS @ 45° | SOLID | WHITE | DIAGONALS: 15' (4.5 m) C-C (LESS THAN 30MPH (50 km/h)) 20' (6 m) C-C 30MPH (50 km/h) TO 45MPH (70 km/h) 30' (9 m) C-C (OVER 45MPH (70 km/h)) |
| RAILROAD CROSSING | 24 (600) TRANSVERSE LINES; "RR" IS 6' (1.8 m) LETTERS; 16 (400) LINE FOR "X" | SOLID | WHITE | SEE STATE STANDARD 780001 AREA OF: "R"=3.6 SQ. FT. (0.33 m ²) EACH "X"=54.0 SQ. FT. (5.0 m ²) |
| SHOULDER DIAGONALS | 12 (300) @ 45° | SOLID | WHITE - RIGHT YELLOW - LEFT | 50' (15 m) C-C (LESS THAN 30MPH (50 km/h)) 75' (22.5 m) C-C (30 MPH (50 km/h) TO 45MPH (70 km/h)) 150' (45 m) C-C (OVER 45MPH (70 km/h)) |

FOR FURTHER DETAILS ON PAVEMENT MARKING REFER TO STANDARD SPECIFICATIONS FOR ROAD AND BRIDGE CONSTRUCTION AND STATE STANDARD 780001.

All dimensions are in inches (millimeters) unless otherwise shown.

| REVISIONS | |
|--------------|----------|
| NAME | DATE |
| EVERS | 03-19-90 |
| T. RAMMACHER | 10-27-94 |
| ALEX HOUSEH | 10-09-96 |
| ALEX HOUSEH | 10-17-96 |
| T. RAMMACHER | 01-06-00 |

ILLINOIS DEPARTMENT OF TRANSPORTATION
DISTRICT ONE
TYPICAL PAVEMENT MARKINGS
SCALE: NONE
DRAWN BY CADD
CHECKED BY
TC-13

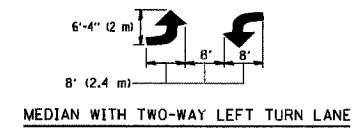
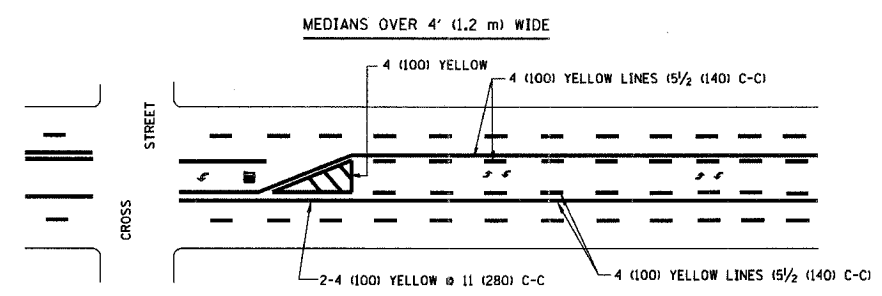
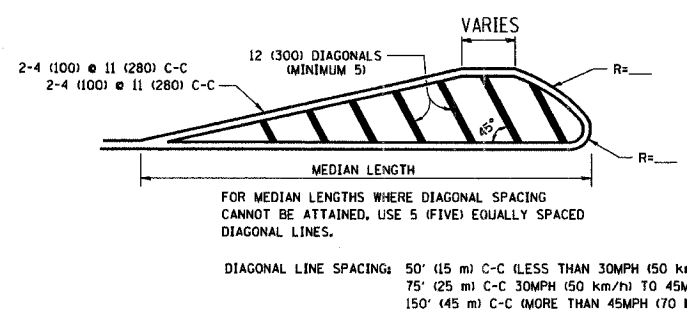
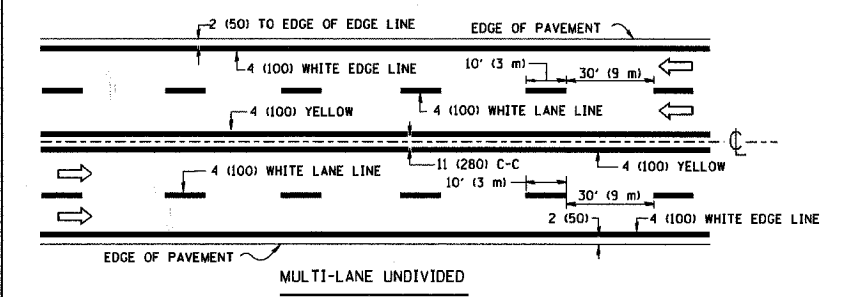

TYPICAL PAINTED MEDIAN MARKING

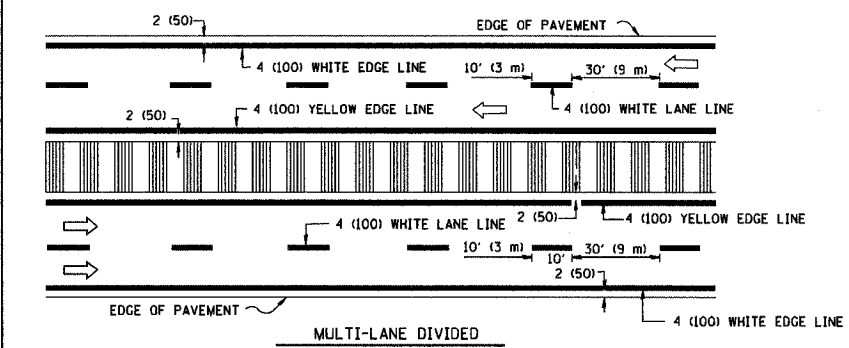

NOTE: MEDIANS WITH BARRIER CURB DO NOT REQUIRE AN EDGE LINE

TYPICAL LANE AND EDGE LINE MARKING

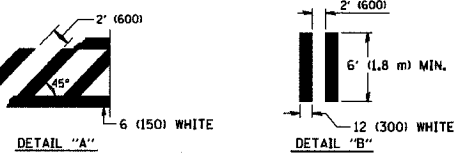
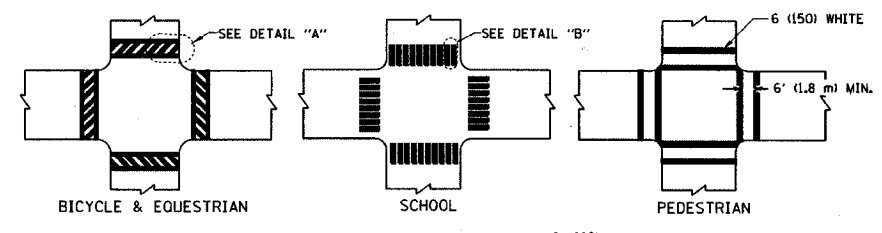

TYPICAL CROSSWALK MARKING

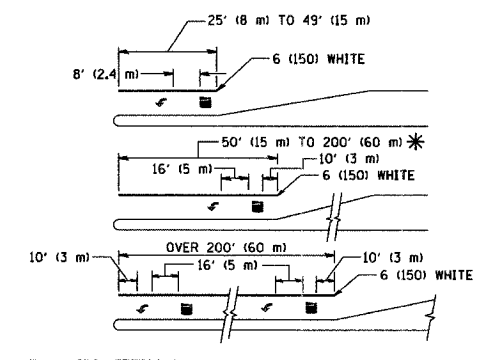

FULL SIZE LETTERS 8' (2.4 m) AND ARROWS SHALL BE USED. AREA = 15.6 SQ. FT. (1.5 m²) | AREA = 20.8 SQ. FT. (1.9 m²)
* TURN LANES IN EXCESS OF 400' (120 m) IN LENGTH MAY HAVE AN ADDITIONAL SET OF ARROW - "ONLY" INSTALLED MIDWAY BETWEEN THE OTHER TWO SETS OF ARROW - "ONLY".

TYPICAL LEFT (OR RIGHT) TURN LANE

TYPICAL TURN LANE MARKING

PLOT DATE = 3/6/2007
FILE NAME = K:\Address\1313.dgn
PLOT SCALE = 80,000 / IN.
USER NAME = bmaur