

| F.A.I. RTE. | SECTION | COUNTY | TOTAL SHEETS | SHEET NO. |
|---------------------|-----------|---------------------------|--------------|-----------|
| 57/64 | (41-3)HBK | JEFFERSON | 18 | 231 |
| STA. | | TO STA. | | |
| FED. ROAD DIST. NO. | | ILLINOIS FED. AID PROJECT | | |

POLE STANDARDS

"INSTALL AND ORIENT ARM BRACKET OVER POLE TENON AND FIRMLY HAND TIGHTEN THE TWO SET SCREWS. USE THIRD HOLE IN ARM BRACKET AS A GUIDE TO DRILL A 3/4" DIAMETER HOLE THROUGH TENON. INSTALL AND TIGHTEN SELF-TAPPING SCREW. TIGHTEN SET SCREWS AN ADDITIONAL 1/4 TO 3/8 TURN WITH HEX KEY (NOT PROVIDED). INSTALL LOCKNUTS ON SET SCREWS IF THREADED PROJECTION ALLOWS."

POLE SHALL MEET AASHTO STANDARD SPECIFICATIONS FOR 80 MPH WIND LOADING AND 90 LB, 4.0 SQ. FT E.P.A. LUMINAIRE.

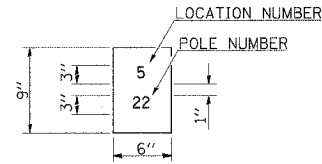

THE CONTRACTOR SHALL FURNISH AND INSTALL A LIGHT POLE IDENTIFICATION OF EACH NEW LIGHT POLE, AS SHOWN ABOVE, INCIDENTAL TO THE RESPECTIVE LIGHT POLE PAY ITEM. THE NUMERALS SHALL BE 3", SERIES "D", BLACK, SCREENED ON SILVER-WHITE TYPE B PRESSURE SENSITIVE REFLECTIVE SHEETING CONFORMING TO THE REQUIREMENTS OF SECTION T602.01 OF THE STANDARD SPECIFICATIONS FOR TRAFFIC CONTROL ITEMS. THE NUMERALS SHALL CONFORM TO THE FHWA "STANDARD ALPHABETS FOR HIGHWAY SIGNS".

THE LIGHT POLE IDENTIFICATION SHALL BE APPLIED TO SIGN BASE MATERIAL AS SPECIFIED IN SECTION 719.11 OF THE STANDARD SPECIFICATIONS, APPROXIMATELY 7" ABOVE THE ADJACENT PAVEMENT GRADE VISIBLE TO APPROACHING TRAFFIC IN ACCORDANCE WITH HIGHWAY STANDARD 2319.

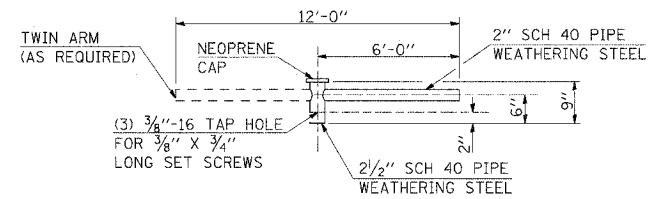
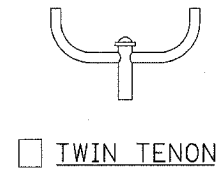

TENON MOUNT BRACKET ARM

NOTE: SINGLE OR TWIN ARM ASSEMBLY SHALL BE TILTED 3° ABOVE HORIZONTAL.

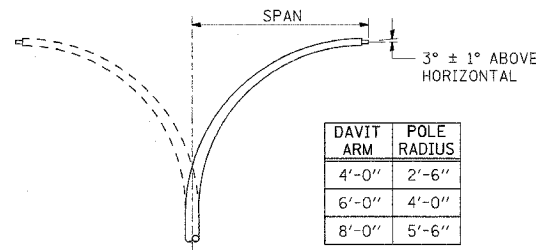
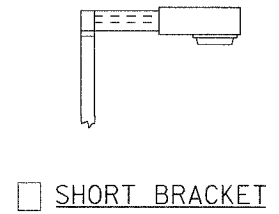
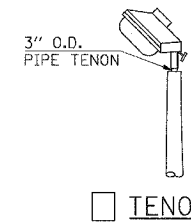

DAVIT ARM (AND OR)
DAVIT ARM-TWIN

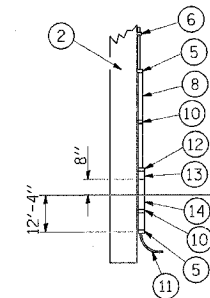

DETAILS FOR UNDERGROUND DISTRIBUTION IF REQUIRED

| POLE LENGTH | DEPTH IN GROUND |
|-------------|-----------------|
| 65'-0" | 12'-0" |
| 60'-0" | 10'-0" |
| 55'-0" | 9'-0" |
| 50'-0" | 8'-0" |
| 45'-0" | 7'-0" |
| 40'-0" | 6'-6" |
| 35'-0" | 6'-0" |
| 30'-0" | 5'-6" |

POLE, WOOD

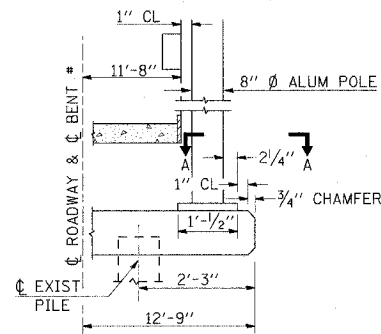

BENT # (LOOKING)

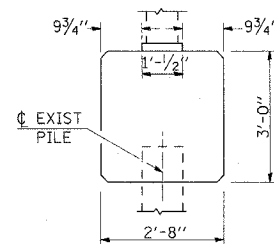

BRIDGE PIER MOUNT

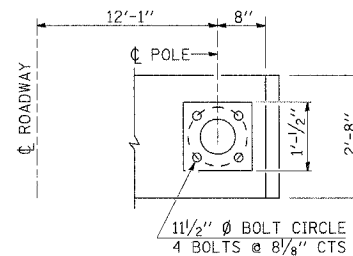

SECTION A-A

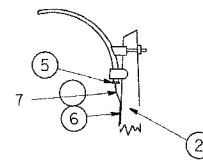

MAST ARM

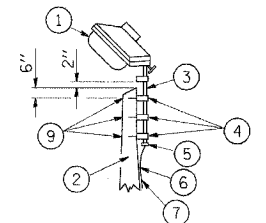

TENON

- ① LUMINAIRE
- ② WOOD POLE, CLASS 3 OR BETTER
- ③ 2 1/2" GALV. STEEL CONDUIT
- ④ SINGLE OFFSET POLE BAND
- ⑤ CONDUIT BUSHING
- ⑥ CABLE CLAMPS ON 2' CENTERS
- ⑦ 2/C #12 TYPE USE CABLE
- ⑧ 1" GALV. STEEL CONDUIT 10' IN LENGTH
- ⑨ 5/8" Ø HOT DIPPED GALVANIZED BOLT WITH FLAT WASHER & LOCKNUT (3 REQ'D)
- ⑩ CONDUIT CLAMPS ON 3' CENTERS
- ⑪ UNIT DUCT
- ⑫ THREADED REDUCER
- ⑬ "C" CONDULET, THREADED
- ⑭ 1 1/2" GALV. STEEL CONDUIT FOR 1 UNIT DUCT OR 3" GALV. STEEL CONDUIT FOR 2 OR 3 UNIT DUCTS.

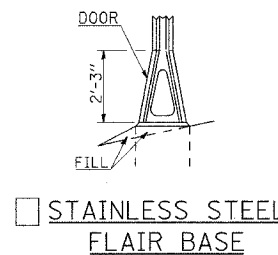

STAINLESS STEEL FLAIR BASE

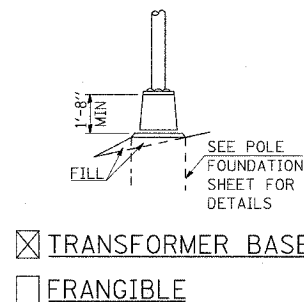

TRANSFORMER BASE
FRANGIBLE

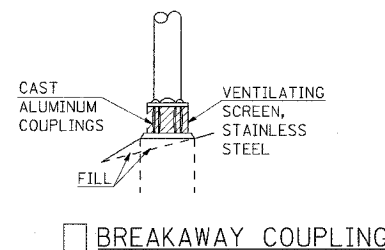

BREAKAWAY COUPLING

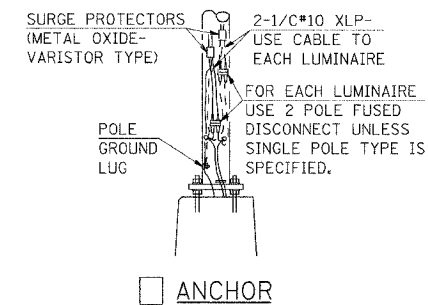

ANCHOR
METAL OR CONCRETE
DETAILS FOR UNDERGROUND DISTRIBUTION IF REQUIRED

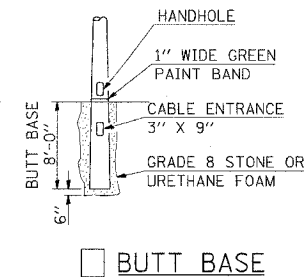

BUTT BASE

03/21/2007 09:55 AM
 510.0000 / 1 IN
 KES

| REVISIONS | |
|-----------|---------|
| DRAWN | 2-9-01 |
| REVISED | 4-14-02 |
| REVISED | |
| REVISED | |