





# SIDEWALK AND DRIVEWAY PAVEMENT PAY AREAS

- PAY FOR AS
-  SIDEWALK REMOVAL
  -  DRIVEWAY PAVEMENT REMOVAL
  -  PCC SIDEWALK 5
  -  PCC DRIVEWAY PAVEMENT 7

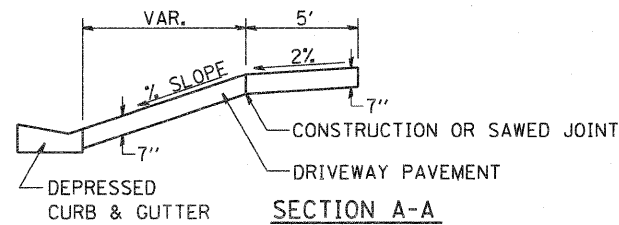
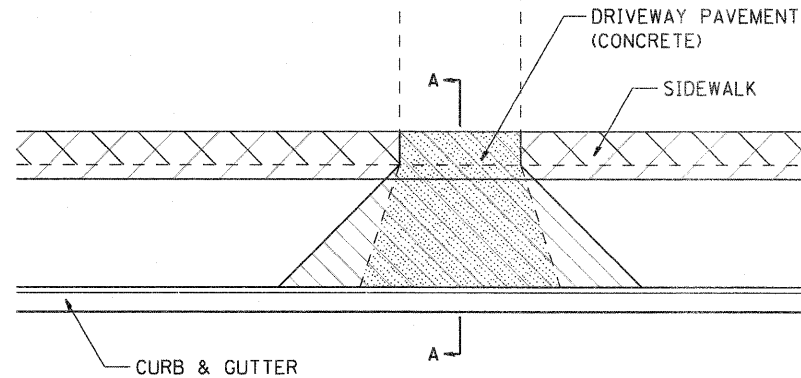

FOR DETAILS ON DIMENSIONS AND GRADES, SEE DISTRICT STANDARD 25.1 OR PLANS.  
ALL DIMENSIONS ARE IN INCHES UNLESS OTHERWISE NOTED.

REVISED - 10-3-11

SIDEWALK AND DRIVEWAY PAVEMENT PAY AREAS 35.4

# DELINEATOR AND POST ORIENTATION

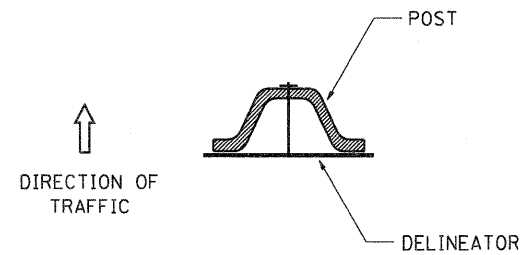

DELINEATORS SHALL BE INSTALLED ACCORDING TO STANDARD 635001 EXCEPT THAT THE POST SHALL BE ROTATED 180°. THE POST WILL HAVE THE WIDE SIDE FACING TRAFFIC AND THE DELINEATOR ATTACHED AS SHOWN ABOVE.

ALL DIMENSIONS ARE IN INCHES UNLESS OTHERWISE NOTED.

REVISED - 10-3-11

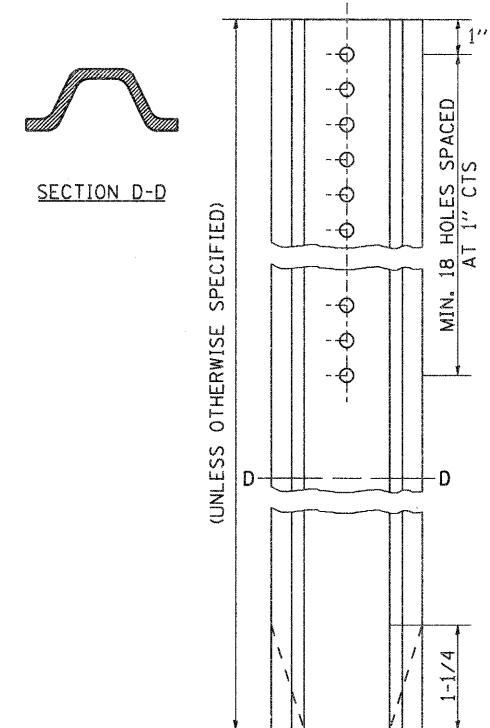

DELINEATOR AND POST ORIENTATION 37.4

# ROAD CLOSED TO OVERSIZED LOADS

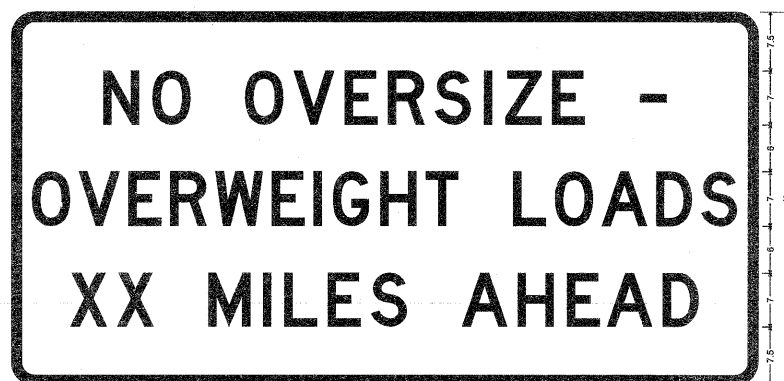

Permit Loads - Loads Over 13 Feet; 30" Radius; 1 3/4" Border; Black on Orange; (NO OVERSIZE - I D; (OVERWEIGHT LOADS) D 80% spacing; (XX MILES AHEAD) D; Table of letter and object sets.

N	O	O	V	E	R	S	I	Z	E	-
11.7	18.1	30.0	36.2	42.8	48.4	54.4	60.7	63.5	69.5	80.8
O	V	E	R	S	I	Z	E	-	A	D
2.8	8.8	15.0	20.4	26.2	33.4	38.8	41.3	47.4	63.2	64.9
X	X	M	I	L	E	S	A	H	E	A
7.8	13.6	25.3	32.3	36.1	40.6	48.2	57.8	65.1	71.4	76.8

All work to furnish and install these signs shall be included in the cost of the Traffic Control Standards and shall not be paid for separately.  
ALL DIMENSIONS ARE IN INCHES UNLESS OTHERWISE NOTED.

REVISED - 3-11-09

ROAD CLOSED TO OVERSIZED LOADS 40.4

# TYPICAL BENCHING ON EXISTING EMBANKMENT

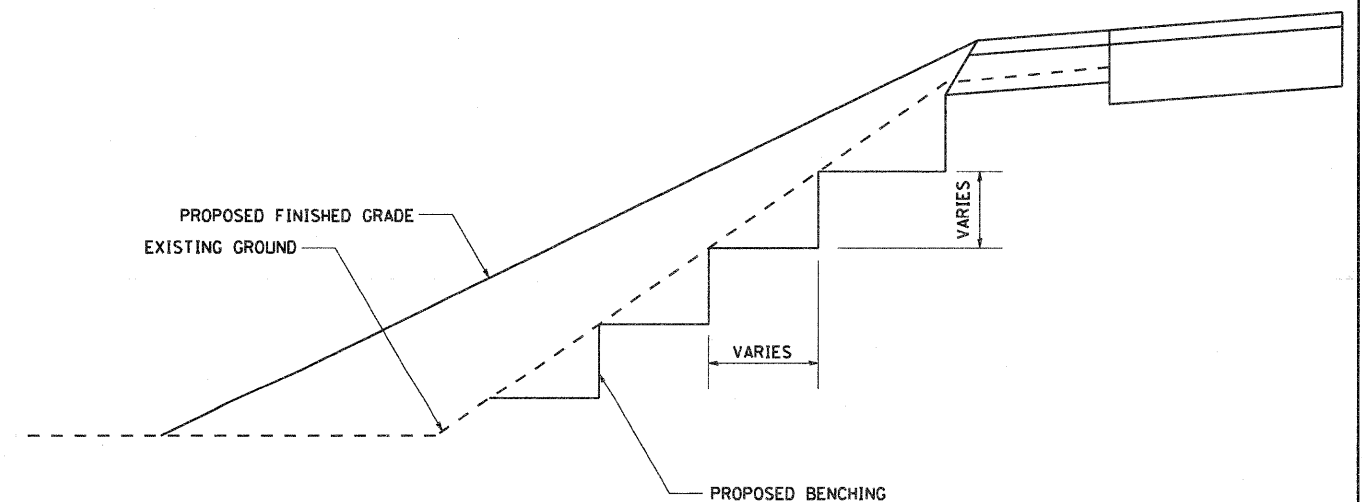

REVISED - 2-22-06	REGION 2 / DISTRICT 2 STANDARD	F.A. RTE.	SECTION	COUNTY	TOTAL SHEETS	SHEET NO.
REVISED -		742	34R	WINNEBAGO	491	336
REVISED -		CONTRACT NO. 64515				
REVISED -		FED. ROAD DIST. NO. (ILLINOIS) FED. AID PROJECT				

PLOT DATE - 1/17/2012

TYPICAL BENCHING ON EXISTING EMBANKMENT 50.4