

F. & I. NO.	SECTION	COUNTY	TOTAL SHEETS	SHEET NO.
3578	1327B	COOK	108	88
STA.		TO STA.		
FED. ROAD DIST. NO.		ILLINOIS	FED. AID PROJECT	

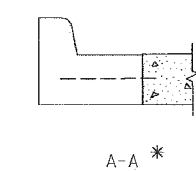

\* DIMENSIONS OF THE CURB & GUTTER AT SECTION A-A ARE SHOWN ON STATE STANDARD 606001. FOR DETAILS OF OUTLET FOR CONCRETE CURB & GUTTER, TYPE B-15.60 (B-6.24) SEE STATE STANDARD 606006.

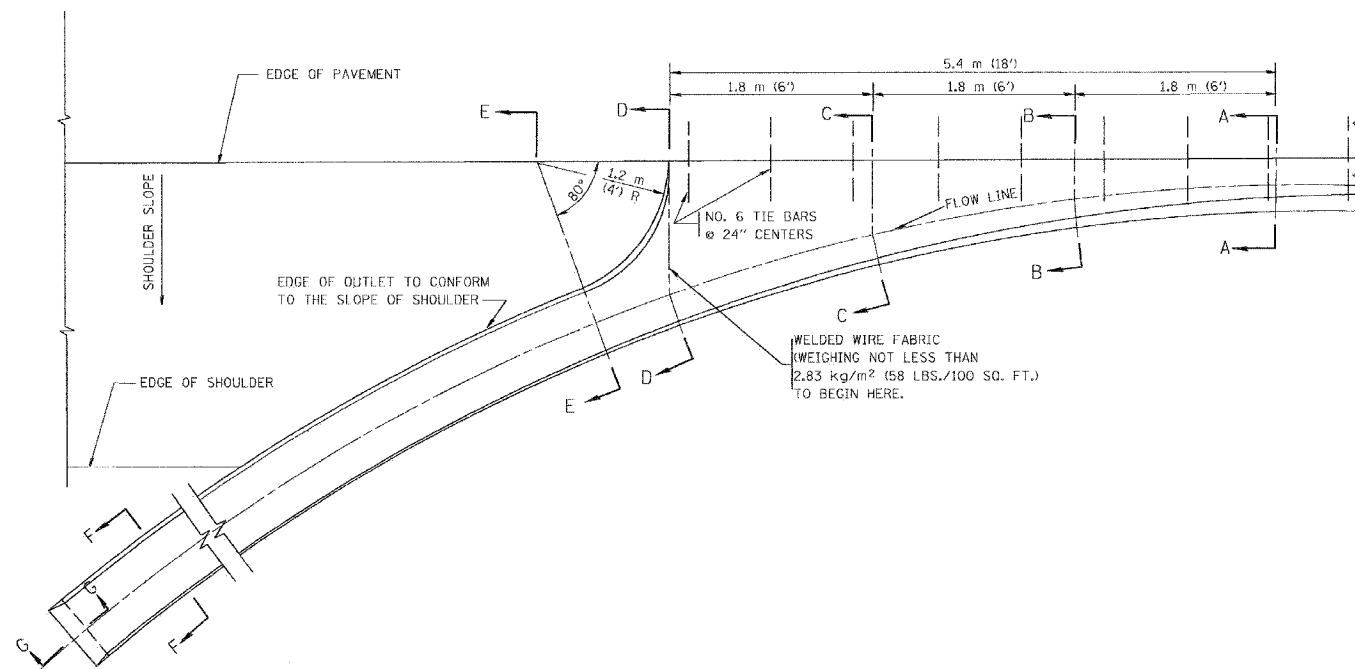
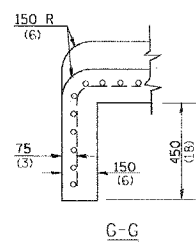
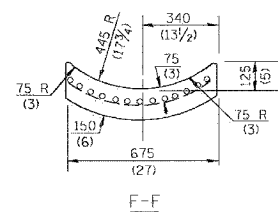
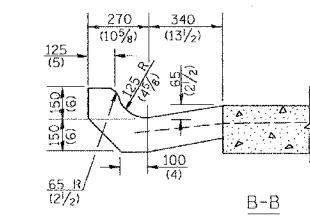
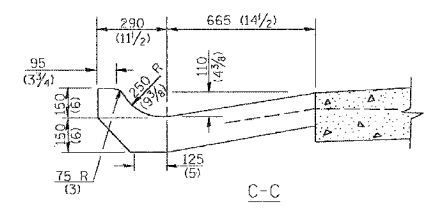
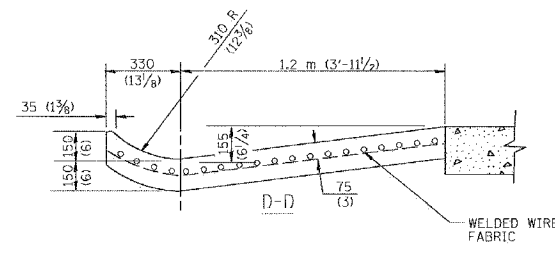
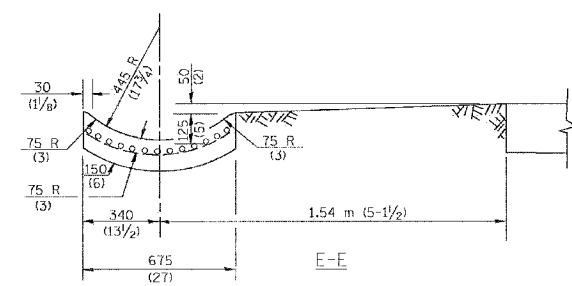

**GENERAL NOTES**

GUTTER OUTLET SHALL BE TIED TO THE PAVEMENT IN ACCORDANCE WITH DETAILS FOR LONGITUDINAL CONSTRUCTION JOINT SHOWN ON STANDARD 420001.

TIE BARS SHALL BE NO. 20 (NO.6) AT 600 (24) CENTERS UNLESS OTHERWISE SHOWN.

IF THE AVERAGE GRADE OF PAVEMENT FOR THE DISTANCE FROM SECTION A-A TO D-D EXCEEDS 2%, THIS DISTANCE SHALL BE INCREASED 1.8 m (6') FOR EACH 1% INCREASE IN GRADE.

**QUANTITIES**

FOR SECTION A-A TO E-E AND CURTAIN WALL-  
 0.96 m<sup>3</sup> (1.25 CU. YDS.) CLASS SI CONCRETE (OUTLET) FOR 225 (9) PAV'T.  
 0.97 m<sup>3</sup> (1.27 CU. YDS.) CLASS SI CONCRETE (OUTLET) FOR 250 (10) PAV'T.  
 FOR SECTION F-F-  
 0.03 m<sup>3</sup> (0.045 CU. YDS.) CLASS SI CONCRETE PER m (ft.).

ALL DIMENSIONS ARE IN MILLIMETERS (INCHES) UNLESS OTHERWISE SHOWN.

ILLINOIS DEPARTMENT OF TRANSPORTATION

**OUTLET FOR CONCRETE CURB AND GUTTER**

REVISIONS	
NAME	DATE
M. DE YONG	8/4/86
R. SHAH	09/09/94
R. SHAH	10/25/94
E. GOMEZ	12/21/00

SCALE: NONE  
 DATE \$\$\$DATE\$\$\$  
 DRAWN BY  
 CHECKED BY