

ROUTE NO.	SECTION	COUNTY	TOTAL SHEETS	SHEET NO.
F.A.P. 714		CHRISTIAN	94	45
FED. ROAD DIST. NO.	ILLINOIS	FED. AID PROJECT		

SHEET NO. 8  
OF 10 SHEETS

**NOTES**

Hollow structural sections shall conform to the requirements of ASTM designation A 500, Grade B, Structural Steel Tubing and shall meet the longitudinal CVN requirements of 15 ft-lbs at 0°F.

All other steel shapes and plates shall conform to the requirements of AASHTO M 270 Grade 36 except posts shall conform to AASHTO M 270, Grade 50.

Bolts, cap screws and nuts shall conform to the requirements of ASTM designation A 307 except that threaded rods, nuts and washers shall conform to AASHTO M 164.

All bolts, nuts, cap screws, washers and lock washers shall be galvanized according to AASHTO M 232.

All posts, railing, rail splices and anchor rods shall be galvanized after shop fabrication according to AASHTO M 111 and ASTM A 385. Galvanized rail shall not be painted.

Railing shall be according to Section 509 of the Standard Specifications, except as noted, and will be paid for at the contract unit price per foot for Steel Bridge Rail.

All field drilled holes shall be coated with an approved zinc rich paint before erection.

Posts shall not be located closer than 1'-3" to an existing bridge expansion joint or end of bridge.

Steel Bridge Rail expansion joint shall be provided between any two (2) posts which span a bridge expansion joint. Bolts located at expansion joint shall be provided with locknuts and shall be tightened only to a point that will allow railing movement.

Provide one 1/8" and two 1/16" steel shims for 25% of the posts. Shims shall be similar to base plates in size and holes.

Expansion joint width shall be "D" at 50°F and shall be adjusted for other temperatures according to Article 503.10(c) of the Standard Specifications.

The Contractor shall use the capsule or the adhesive cartridge type anchor rods that have been previously tested and given a prior approval by the Department. The Contractor shall install these anchor rods in pre-drilled holes according to the manufacturer's recommendations and procedures. The capsule or the adhesive cartridge shall be sealed with pre-measured amounts of the adhesive chemical.

Nuts for 1" threaded anchor rods connecting the base plate to the concrete shall be tightened to a snug fit and given an additional 1/8 turn.

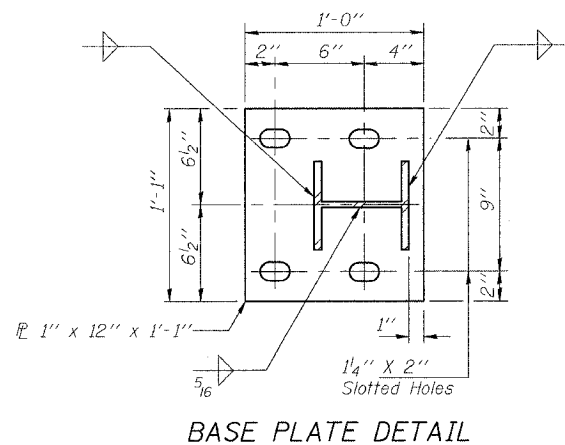

**BASE PLATE DETAIL**

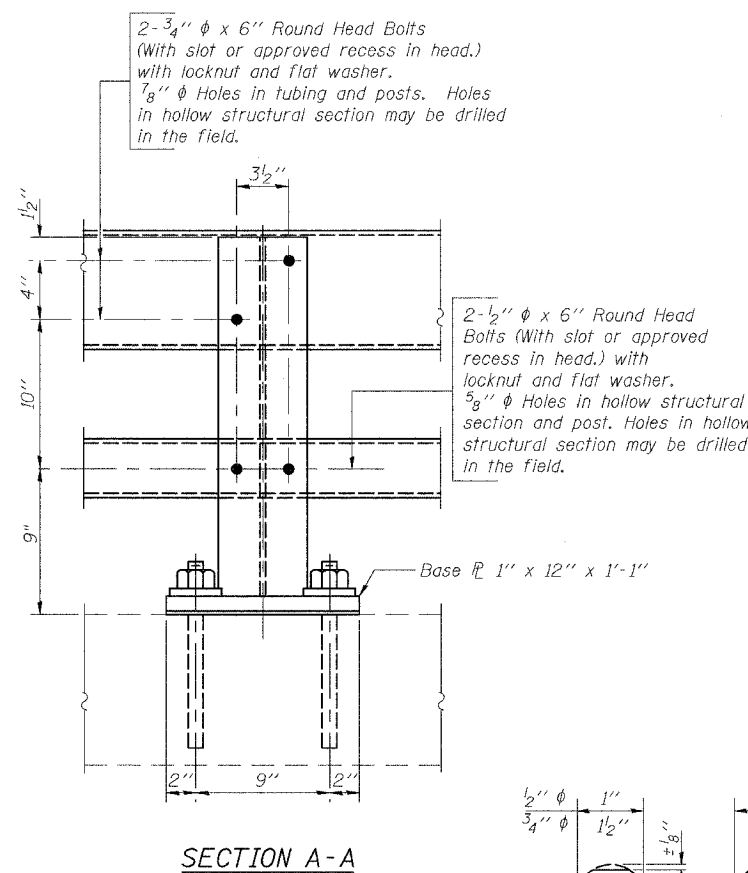

**SECTION A-A**

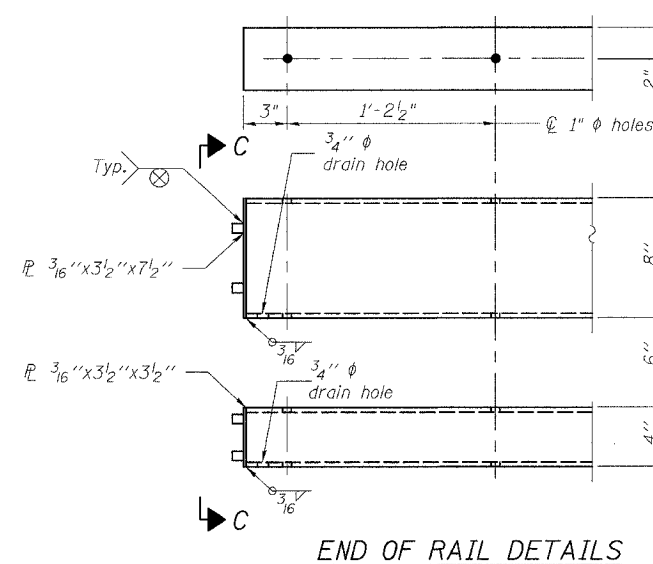

**END OF RAIL DETAILS**

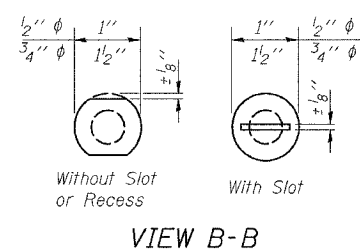

**VIEW B-B**

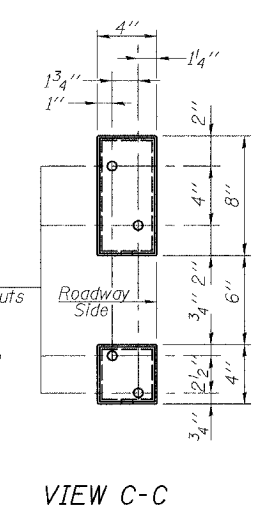

**VIEW C-C**

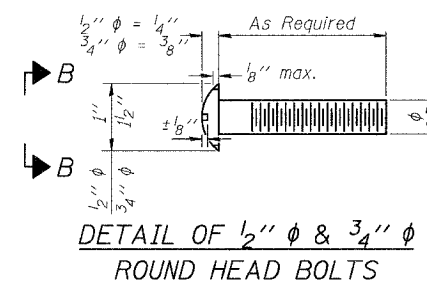

**DETAIL OF 1/2" & 3/4" ROUND HEAD BOLTS**

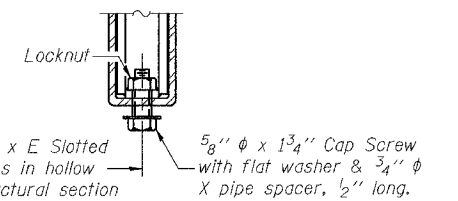

**RAIL SPLICE CONNECTION AT EXPANSION JT.**

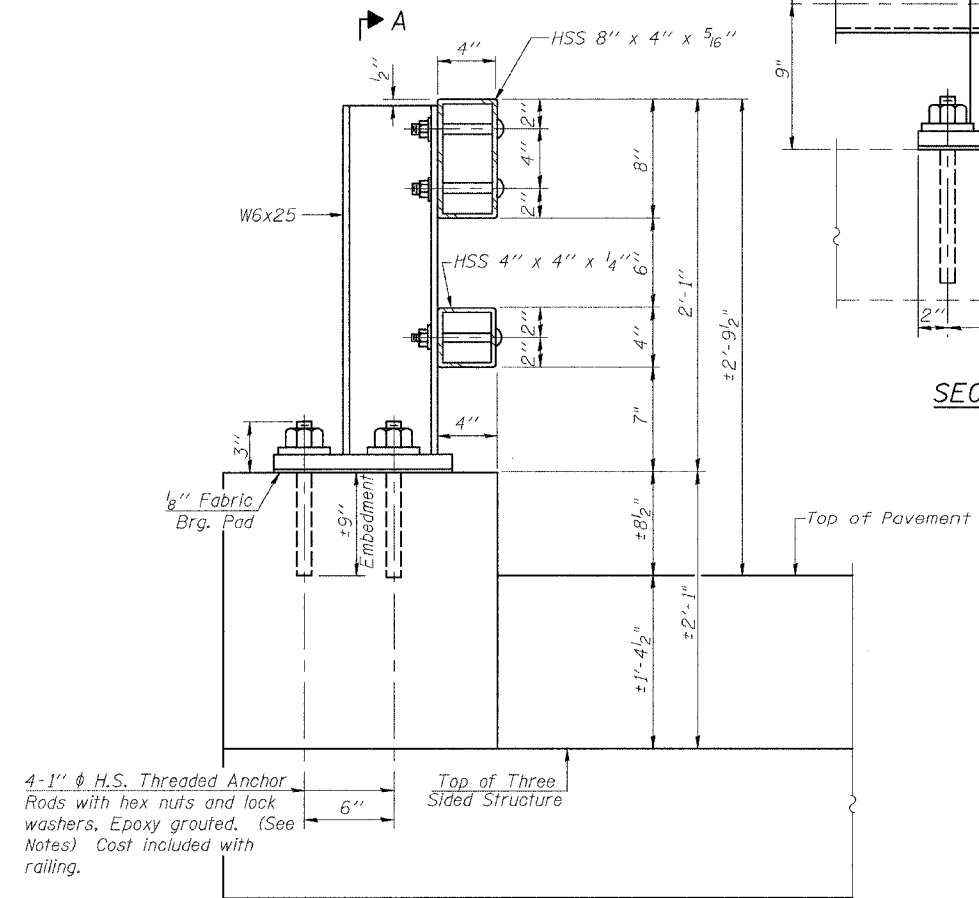

**SECTION AT RAIL POST**

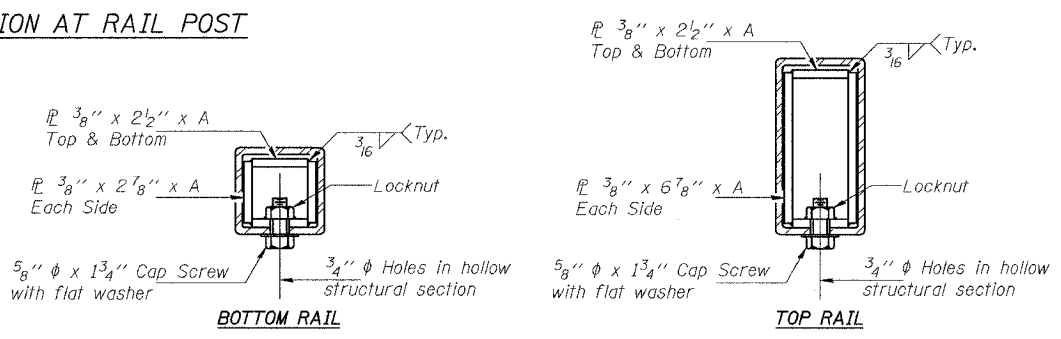

**SECTIONS AT RAIL SPLICE**

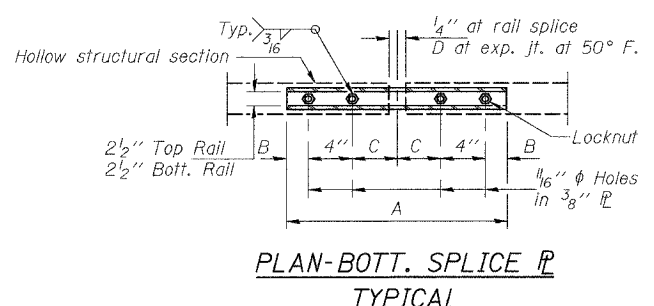

**PLAN-BOTT. SPLICE TYPICAL**

**BILL OF MATERIAL**

Item	Unit	Quantity
Steel Bridge Rail	Foot	114.68

**SPLICE DIMENSIONS**

T	D	A	B	C	E
≤ 4"	2 1/2"	1'-8"	2"	4"	2 1/2"
> 4" ≤ 6 1/2"	3 3/4"	2'-0"	2 1/2"	5 1/2"	3 1/2"
> 6 1/2" ≤ 9"	5"	2'-4"	3 1/2"	6 1/2"	9"
> 9" ≤ 13"	7"	2'-10"	4 1/2"	8 1/2"	11"
Rail Splice	1/4"	1'-8"	2"	4"	—

T = Total movement at expansion joint as shown on the design plans.

**STEEL BRIDGE RAIL CURB MOUNTED**  
**IL. ROUTE 48 OVER BUCKHART CREEK**  
**F.A.P. ROUTE 714 - SECTION**  
**D-6 IL. 48 IMPROVEMENT 2006**  
**CHRISTIAN COUNTY**  
**STA. 401+35.5**  
**S.N. 011-2507**

FILE NAME: 1548-1-STRUCTURE (REV. 3/22/06)