

LIGHT POLE MOUNTING HEIGHT	BOLT CIRCLE DIAMETER	STEEL FOUNDATION			CONCRETE FOUNDATION		
		SHAFT DIAMETER	SHAFT DEPTH	TOP PLATE (min)	SHAFT DIAMETER	SHAFT DEPTH	ANCHOR ROD LENGTH ①
<9.1 m (30')	292 (11.5)	220 (8 5/8)	1.83 m (6')	300 x 300 x 25 12 x 12 x 1	610 (24)	1.52 m (5'-0")	1.45 m (4'-9")
9.4 m - 10.7 m (31'-35')	292 (11.5)	220 (8 5/8)	1.83 m (6')	300 x 300 x 25 12 x 12 x 1	610 (24)	1.67 m (5'-6")	1.60 m (5'-3")
10.9 m - 12.2 m (36'-40')	381 (15) ③	220 (8 5/8)	1.83 m (6') ②	375 x 375 x 31 15 x 15 x 1 1/4	762 (30)	1.83 m (6'-0")	1.75 m (5'-9")
12.5 m - 13.7 m (41'-45')	381 (15) ③	220 (8 5/8)	1.83 m (6') ②	375 x 375 x 31 15 x 15 x 1 1/4	762 (30)	1.98 m (6'-6")	1.90 m (6'-3")
14.0 m - 15.2 m (46'-50')	381 (15) ③	220 (8 5/8)	2.44 m (8')	375 x 375 x 31 15 x 15 x 1 1/4	762 (30)	2.13m (7'-0")	2.00 m (6'-9")

- ① Length does not include 100(4)hook
- ② 220 mm x 2.44 m (8 5/8" x 8'-0") for Twin luminaires
- ③ Bolt circle diam. shall be 430 (17) when a TB3-17 transformer base is used

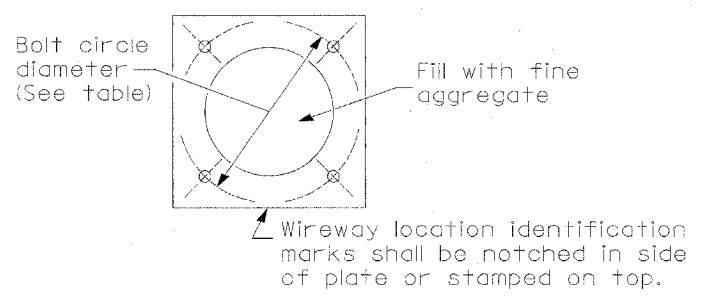

Length above foundation shall be adjusted to accommodate breakaway devices furnished by the contractor for a specific installation.

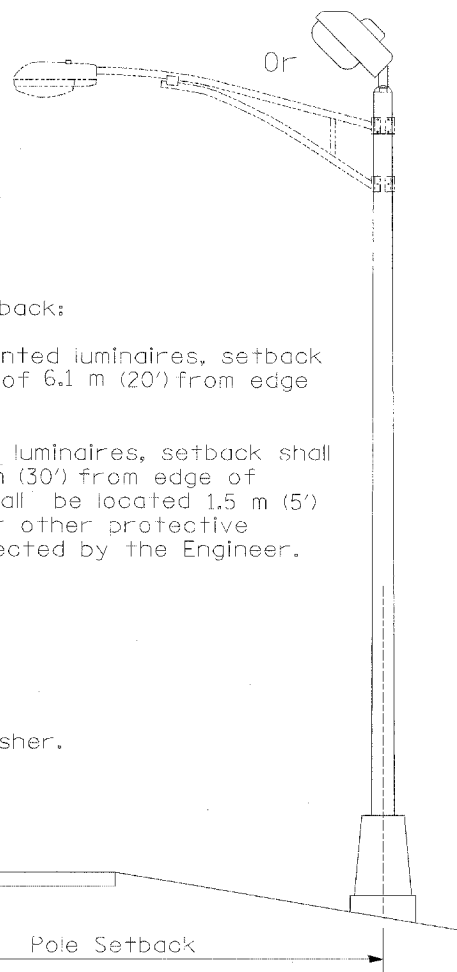
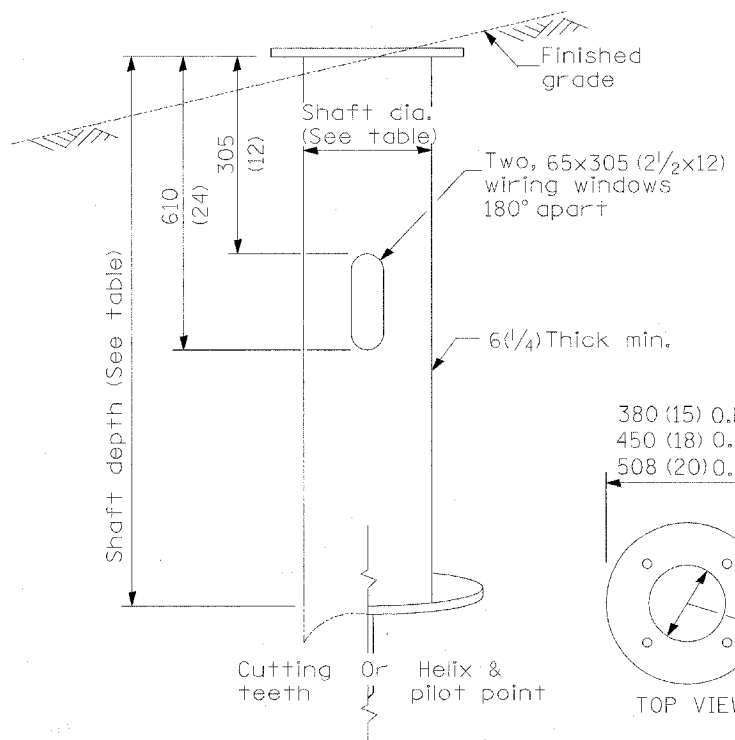
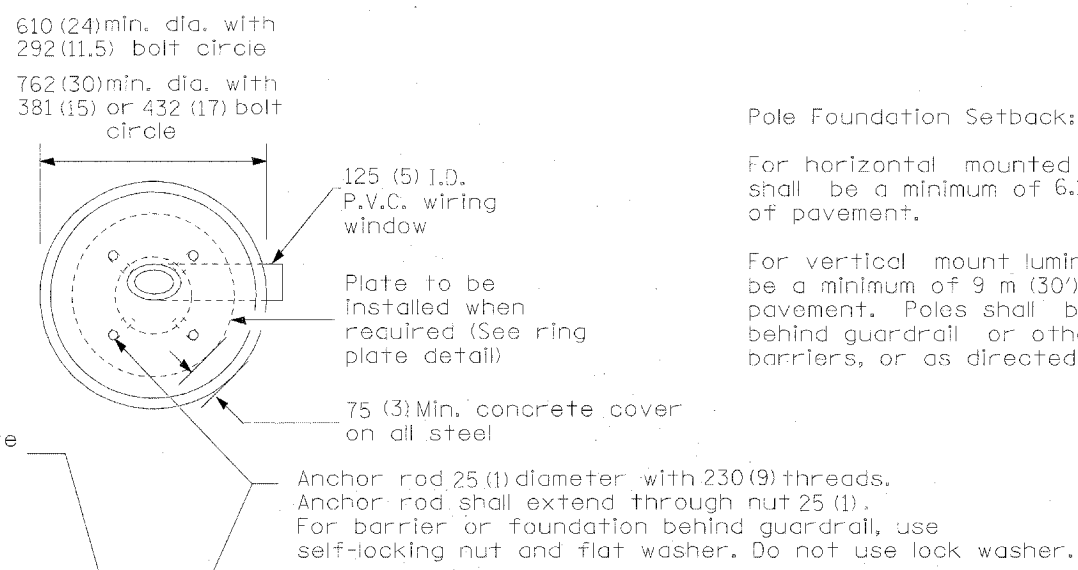

Use dirt removed from foundation to meet 1.52m (5 ft.) chord fill around foundation top. Grade dirt level with bottom of concrete chamfer.

- ④ If the required anchor rod length above top of foundation is less than 75 (3), anchor rods may be lowered below 150 (6).

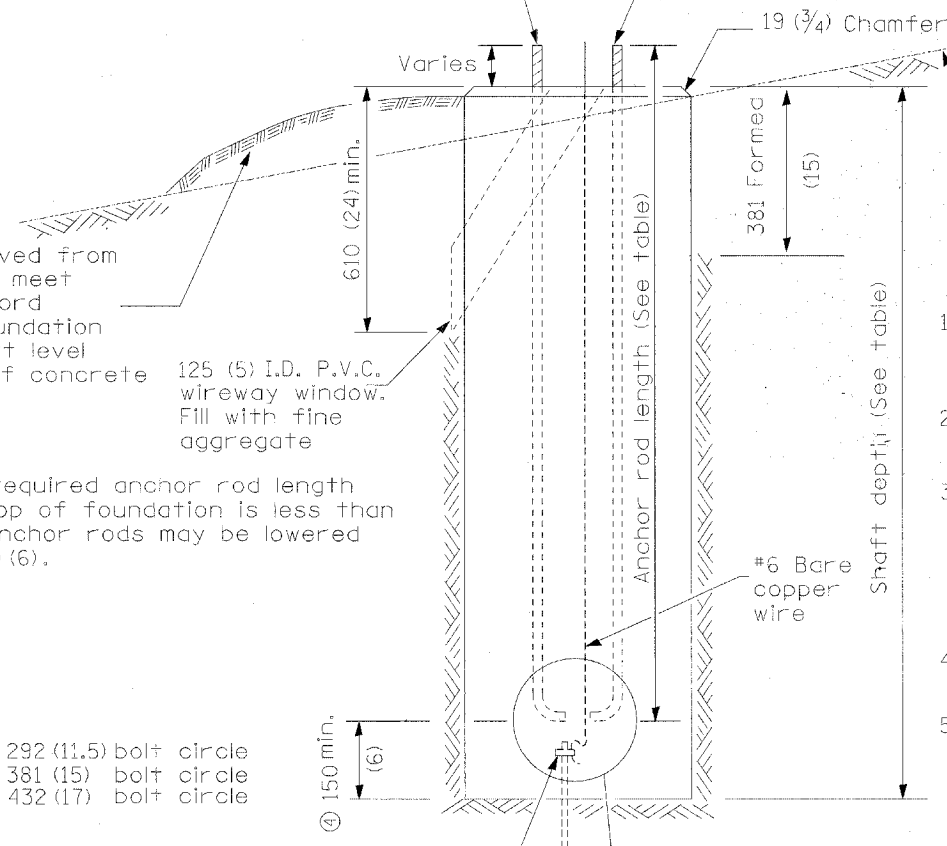
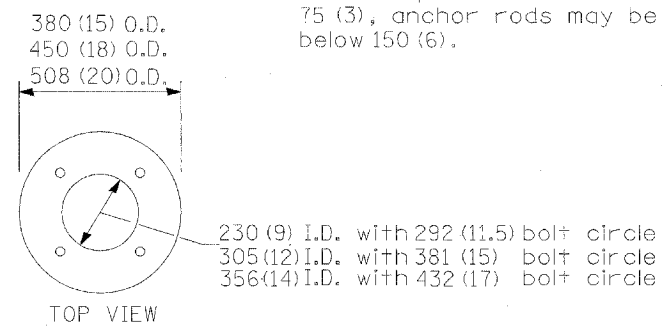

- Notes:
- Wireway may be on front, back or side of foundation as required by the trenching. Place door of transformer base on wireway side to minimize the number of unit duct bends.
  - Top of schedule 40 125 (5) I.D. PVC wiring window, shall be flush with the top of foundation for drainage.
  - All foundations are designed to be located on slopes not exceeding 2:1 where soils have an unconfined compressive strength of at least 1.0 TSF. The contractor shall verify the soil strength during drilling for concrete foundations or by monitoring installation resistance on steel foundations and notify the engineer if other conditions are encountered.
  - Anchor rod shall be increased to 31 (1 1/4) diameter for 15.24 (50') mounting height or above.
  - TB3-17 transformer base is not to be used on metal foundation

All dimensions are in millimeters (inches) unless otherwise shown.

STEEL FOUNDATION

RING PLATE DETAIL

(When rock is encountered and foundation is shallower)

CONCRETE FOUNDATION

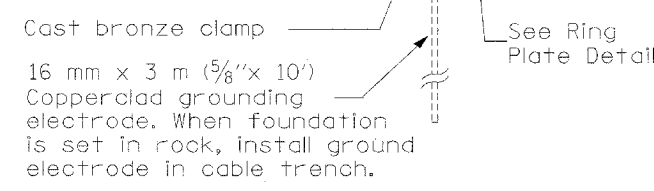

DATE	REVISIONS
10/7/02	Bridge Office depth calc.

LIGHT POLE FOUNDATION

LGT007-836