

CABLE TO GROUND ROD

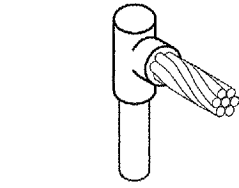

CABLE TO GROUND ROD

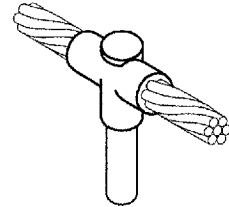

CABLE TO GROUND ROD

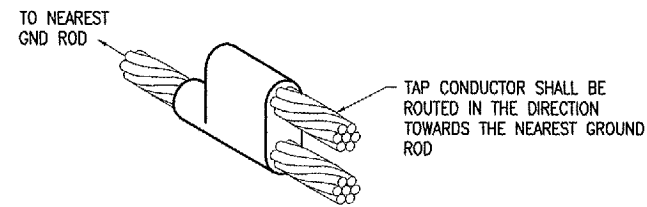

CABLE TO CABLE  
HORIZONTAL PARALLEL TAP

DETAIL NOTES

- EXOTHERMIC WELDS SHALL BE CADWELD AS MANUFACTURED BY ERICO PRODUCTS, SOLON, OHIO OR THERMOWELD AS MANUFACTURED BY CONTINENTAL INDUSTRIES, TULSA, OKLAHOMA. VERIFY PROPER SIZES, TYPES, AND REQUIREMENTS FOR THE RESPECTIVE APPLICATION WITH THE MANUFACTURER, AND INSTALL PER THEIR DIRECTIONS.
- FOR APPLICATIONS TO METAL SURFACES THAT ARE LESS THAN 3/16" THICK CONTACT THE EXOTHERMIC WELD MANUFACTURER FOR DIRECTION AND INSTRUCTION ON EXOTHERMIC WELD INSTALLATION TO THE RESPECTIVE SURFACE.
- FOR APPLICATIONS TO GALVANIZED STEEL OR PAINTED STEEL, REMOVE GALVANIZING AND/OR PAINT & CLEAN THE SURFACE TO EXPOSE BARE STEEL BEFORE MAKING EXOTHERMIC WELD CONNECTION.
- INDIVIDUAL GROUNDING ELECTRODE CONDUCTORS SHALL NOT BE INSTALLED IN METAL CONDUIT. INSTALL GROUNDING ELECTRODE CONDUCTORS IN SCHED 40 PVC CONDUIT AS REQUIRED IN FOUNDATIONS, FOR PROTECTION, WHERE ENTERING ENCLOSURES, ETC.

EXOTHERMIC WELD DETAILS

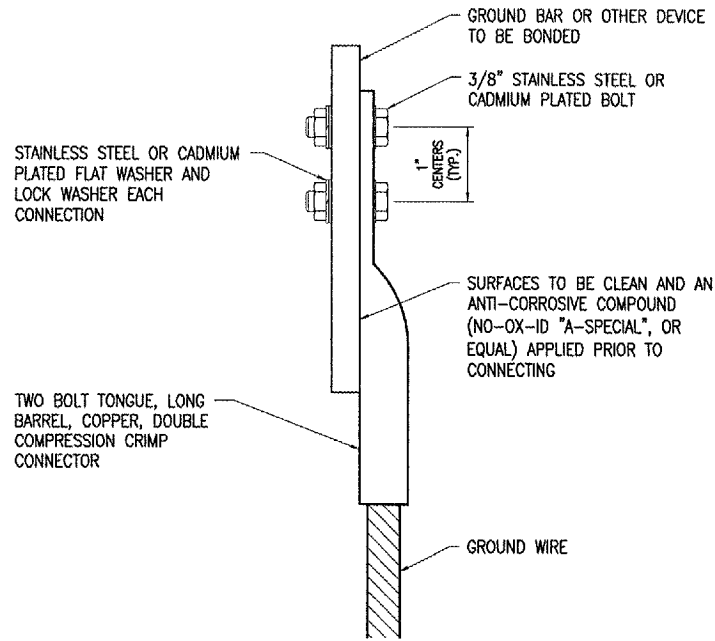

2 HOLE LONG BARREL COMPRESSION LUG TABLE		
WIRE SIZE	BURNDY CAT. NO.	THOMAS & BETTS CAT. NO.
#6 AWG STRANDED	YA6C-2TC38	256-30695-1158
#4 AWG STRANDED	YA4C-2TC38	256-30695-1159
#2 AWG STRANDED	YA2C-2TC38	256-30695-1160
#2 AWG SOLID	YA3C-2TC38	256-30695-1160
#1/0 AWG STRANDED	YA25-2TC38	256-30695-1162
#2/0 AWG STRANDED	YA26-2TC38	256-30695-1116
#3/0 AWG STRANDED	YA27-2TC38	54816BE

NOTES

- ALL CONNECTIONS TO GROUND BUS BAR SHALL BE WITH 2 HOLE TONGUE LONG BARREL COMPRESSION LUGS BOLTED TO THE BUS BAR.
- GROUND WIRE CONNECTIONS TO EQUIPMENT SHALL BE WITH 2 HOLE TONGUE LONG BARREL COMPRESSION LUGS BOLTED TO THE DEVICE OR WITH THE RESPECTIVE EQUIPT MANUFACTURER'S LUG OR TERMINAL WHERE APPLICABLE.
- GROUNDING ELECTRODE CONDUCTORS, BONDING JUMPERS, & INDIVIDUAL GROUND WIRES SHALL NOT BE INSTALLED IN METAL CONDUIT.
- ALL CONNECTIONS SHALL BE COATED WITH A CORROSION PREVENTATIVE COMPOUND (SANCHEM INC. NO-OX-ID "A-SPECIAL", BURNDY PENETROX E, OR EQUAL) BEFORE JOINING. ALL COPPER BUS BARS SHALL BE CLEANED PRIOR TO MAKING CONNECTIONS TO REMOVE SURFACE OXIDATION. CLEAN SURFACES, OF RESPECTIVE DEVICES TO BE BONDED, TO BARE METAL, PER NEC 250-12.

GROUNDING LUG CONNECTION DETAIL

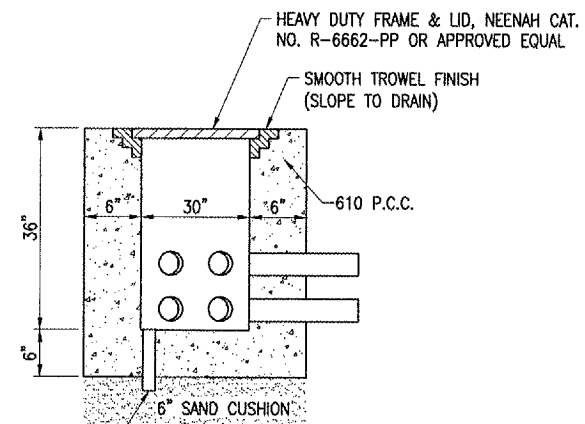
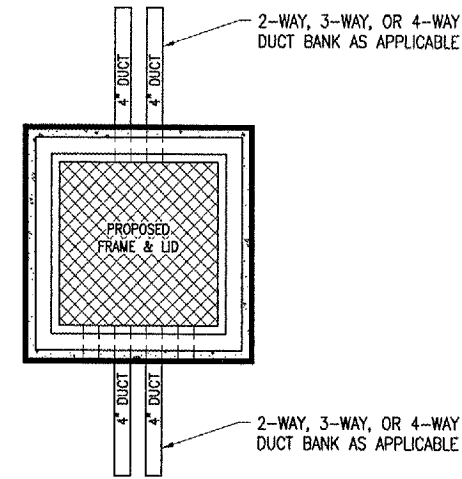

2" SCHED 40 PVC DRAIN PIPE. NOTE 6" OF CA-7 GRAVEL MAY BE PROVIDED, INSTEAD OF 6" CONCRETE FLOOR WITH DRAIN PIPE, AT CONTRACTORS OPTION.

NOTE:

LIDS FOR LOW VOLTAGE HANDHOLES SHALL BE LABELED "LOW VOLTAGE". LIDS FOR HIGH VOLTAGE HANDHOLES SHALL BE LABELED "HIGH VOLTAGE". COORDINATE LETTERING WITH MFR.

ELECTRICAL HANDHOLE DETAIL

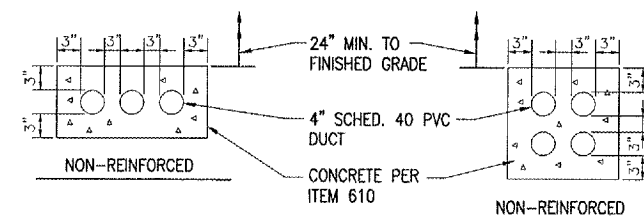

NOTES:

- ALL DIMENSIONS ARE MINIMUM.
- INCLUDE DUCT SPACERS AS MANUFACTURED BY UNDERGROUND DEVICES INC., TO MAINTAIN PROPER SEPARATION OF CONDUITS.

CONCRETE ENCASED DUCT DETAIL

(3-WAY & 4-WAY SHOWN)

DATE	REVISION	BY

KEWANE MUNCIPAL AIRPORT  
KEWANE, HENRY COUNTY, ILLINOIS

IL PROJ.: E21-3586 A.I.P. PROJ.: 3-17-0058-B12

NO.	DATE	BY	REVIEWED
1	07/12/05	KNL	LDP
2	07/12/05	MV	LDP
3	01/17/06	LDP	LDP

**HANSON**  
Hanson Professional Services Inc.  
3125 Dandy Trail, Suite 100  
Indianapolis, Indiana 46214  
Offices Nationwide

CONSTRUCT VAULT  
ELECTRICAL AND  
GROUNDING DETAILS