

122

Letting June 16, 2023

Notice to Bidders, Specifications and Proposal



**Contract No. 62K05
LAKE County
Section 2019-132-DM&T
Route FAP 337
Project NHPP-RLIB(576)
District 1 Construction Funds**

Prepared by

Checked by

F

(Printed by authority of the State of Illinois)



- 1. TIME AND PLACE OF OPENING BIDS.** Electronic bids are to be submitted to the electronic bidding system (iCX-Integrated Contractors Exchange). All bids must be submitted to the iCX system prior to 12:00 p.m. June 16, 2023 at which time the bids will be publicly opened from the iCX SecureVault.
- 2. DESCRIPTION OF WORK.** The proposed improvement is identified and advertised for bids in the Invitation for Bids as:

**Contract No. 62K05
LAKE County
Section 2019-132-DM&T
Project NHPP-RLIB(576)
Route FAP 337
District 1 Construction Funds**

This improvement consists of the demolition of 3 (three) single family residences, 1 (one) shed, and culvert repair at various locations on IL 22 between Quentin Rd and West of IL 83 in the Villages of Long Grove and Kildeer in Lake County, IL.

- 3. INSTRUCTIONS TO BIDDERS.** (a) This Notice, the invitation for bids, proposal and letter of award shall, together with all other documents in accordance with Article 101.09 of the Standard Specifications for Road and Bridge Construction, become part of the contract. Bidders are cautioned to read and examine carefully all documents, to make all required inspections, and to inquire or seek explanation of the same prior to submission of a bid.

(b) State law, and, if the work is to be paid wholly or in part with Federal-aid funds, Federal law requires the bidder to make various certifications as a part of the proposal and contract. By execution and submission of the proposal, the bidder makes the certification contained therein. A false or fraudulent certification shall, in addition to all other remedies provided by law, be a breach of contract and may result in termination of the contract.
- 4. AWARD CRITERIA AND REJECTION OF BIDS.** This contract will be awarded to the lowest responsive and responsible bidder considering conformity with the terms and conditions established by the Department in the rules, Invitation for Bids and contract documents. The issuance of plans and proposal forms for bidding based upon a prequalification rating shall not be the sole determinant of responsibility. The Department reserves the right to determine responsibility at the time of award, to reject any or all proposals, to re-advertise the proposed improvement, and to waive technicalities.

By Order of the
Illinois Department of Transportation

Omer Osman,
Secretary

INDEX
 FOR
 SUPPLEMENTAL SPECIFICATIONS
 AND RECURRING SPECIAL PROVISIONS

Adopted January 1, 2023

This index contains a listing of SUPPLEMENTAL SPECIFICATIONS and frequently used RECURRING SPECIAL PROVISIONS.

ERRATA Standard Specifications for Road and Bridge Construction (Adopted 1-1-22) (Revised 1-1-23)

SUPPLEMENTAL SPECIFICATIONS

<u>Std. Spec. Sec.</u>	<u>Page No.</u>
202 Earth and Rock Excavation	1
204 Borrow and Furnished Excavation	2
207 Porous Granular Embankment	3
211 Topsoil and Compost	4
407 Hot-Mix Asphalt Pavement (Full-Depth)	5
420 Portland Cement Concrete Pavement	6
502 Excavation for Structures	7
509 Metal Railings	8
540 Box Culverts	9
542 Pipe Culverts	29
586 Granular Backfill for Structures	34
644 High Tension Cable Median Barrier	35
782 Reflectors	36
801 Electrical Requirements	38
821 Roadway Luminaires	40
1003 Fine Aggregates	41
1004 Coarse Aggregates	42
1020 Portland Cement Concrete	43
1030 Hot-Mix Asphalt	44
1067 Luminaire	45
1097 Reflectors	52

RECURRING SPECIAL PROVISIONS

The following RECURRING SPECIAL PROVISIONS indicated by an "X" are applicable to this contract and are included by reference:

<u>CHECK SHEET #</u>	<u>PAGE NO.</u>
1 X Additional State Requirements for Federal-Aid Construction Contracts	53
2 X Subletting of Contracts (Federal-Aid Contracts)	56
3 X EEO	57
4 Specific EEO Responsibilities Non Federal-Aid Contracts	67
5 Required Provisions - State Contracts	72
6 Asbestos Bearing Pad Removal	78
7 Asbestos Waterproofing Membrane and Asbestos HMA Surface Removal	79
8 X Temporary Stream Crossings and In-Stream Work Pads	80
9 Construction Layout Stakes	81
10 Use of Geotextile Fabric for Railroad Crossing	84
11 Subsealing of Concrete Pavements	86
12 Hot-Mix Asphalt Surface Correction	90
13 Pavement and Shoulder Resurfacing	92
14 Patching with Hot-Mix Asphalt Overlay Removal	93
15 Polymer Concrete	95
16 Reserved	97
17 Bicycle Racks	98
18 Temporary Portable Bridge Traffic Signals	100
19 Nighttime Inspection of Roadway Lighting	102
20 English Substitution of Metric Bolts	103
21 Calcium Chloride Accelerator for Portland Cement Concrete	104
22 Quality Control of Concrete Mixtures at the Plant	105
23 Quality Control/Quality Assurance of Concrete Mixtures	113
24 Reserved	129
25 Reserved	130
26 Temporary Raised Pavement Markers	131
27 Restoring Bridge Approach Pavements Using High-Density Foam	132
28 Portland Cement Concrete Inlay or Overlay	135
29 Portland Cement Concrete Partial Depth Hot-Mix Asphalt Patching	139
30 Longitudinal Joint and Crack Patching	142
31 Concrete Mix Design – Department Provided	144
32 Station Numbers in Pavements or Overlays	145

TABLE OF CONTENTS

LOCATION OF PROJECT	1
DESCRIPTION OF PROJECT	1
MAINTENANCE OF ROADWAYS (D1)	2
WORK RESTRICTIONS	2
STATUS OF UTILITIES (D1)	2
PUBLIC CONVENIENCE AND SAFETY (D1)	6
BUILDING REMOVAL WITH ASBESTOS ABATEMENT (VILLAGE OF KILDEER AND VILLAGE OF LONG GROVE)	6
DOCUMENTATION OF ROADWAY CONDITIONS BEFORE AND AFTER CONSTRUCTION – PRIVATE ROAD	25
TRAFFIC CONTROL PLAN (D1)	27
COFFERDAM (TYPE 1) (IN-STREAM/WETLAND WORK) (D1)	27
ENGINEER’S FIELD OFFICE TYPE A (D1)	28
DEBRIS REMOVAL	29
TEMPORARY INFORMATION SIGNING	29
COMPENSABLE DELAY COSTS (BDE)	30
CONSTRUCTION AIR QUALITY – DIESEL RETROFIT (BDE)	34
DISADVANTAGED BUSINESS ENTERPRISE PARTICIPATION (BDE)	36
SEEDING (BDE)	45
SOURCE OF SUPPLY AND QUALITY REQUIREMENTS (BDE)	50
SUBCONTRACTOR AND DBE PAYMENT REPORTING (BDE)	51
SUBCONTRACTOR MOBILIZATION PAYMENTS (BDE)	51
SUBMISSION OF PAYROLL RECORDS (BDE)	52
TRAINING SPECIAL PROVISIONS (BDE)	53
IDOT TRAINING PROGRAM GRADUATE ON-THE-JOB TRAINING SPECIAL PROVISION	56
WEEKLY DBE TRUCKING REPORTS (BDE)	58
WORK ZONE TRAFFIC CONTROL DEVICES (BDE)	59
WORKING DAYS (BDE)	60

STATE OF ILLINOIS

SPECIAL PROVISIONS

The following Special Provisions supplement the "Standard Specifications for Road and Bridge Construction," adopted January 1, 2022, the latest edition of the "Manual on Uniform Traffic Control Devices for Streets and Highways," and the "Manual of Test Procedures for Materials" in effect on the date of invitation for bids, and the Supplemental Specifications and Recurring Special Provisions indicated on the Check Sheet included herein which apply to and govern the construction of FAP Route 337 (IL 22), Project NHPP-RLIB(576), Section 2019-132-DM&T, Lake County, Contract No. 62K05 and in case of conflict with any part or parts of said Specifications, the said Special Provisions shall take precedence and shall govern.

FAP Route 337 (IL 22)
Project NHPP-RLIB(576)
Section 2019-132-DM&T
Lake County
Contract No. 62K05

LOCATION OF PROJECT

This project is located at various locations near IL Route 22 west of IL Route 83 (Mundelein Road) in Lake County, Illinois.

DESCRIPTION OF PROJECT

This is a building demolition contract and site- clean-up contract, and the work to be performed consists of the demolition of (3) three single family residences and a shed - (a two-story wood structure with basement and a pitched asphalt-singled roof, a one-story wooden single family residence with a pitched, asphalt-shingled roof, one-half story cedar constructed residence, and one freestanding shed), cleaning up (3) three sites and any incidental and collateral work necessary to complete the improvement as shown in the plans and as described herein.

MAINTENANCE OF ROADWAYS (D1)

Effective: September 30, 1985

Revised: November 1, 1996

Beginning on the date that work begins on this project, the Contractor shall assume responsibility for normal maintenance of all existing roadways within the limits of the improvement. This normal maintenance shall include all repair work deemed necessary by the Engineer, but shall not include snow removal operations. Traffic control and protection for maintenance of roadways will be provided by the Contractor as required by the Engineer.

If items of work have not been provided in the contract, or otherwise specified for payment, such items, including the accompanying traffic control and protection required by the Engineer, will be paid for in accordance with Article 109.04 of the Standard Specifications.

WORK RESTRICTIONS

The contractor will not be allowed to perform any building removal activities until November 1, 2023 in order to preserve the habitat of the Northern Long Eared Bat (NLEB). All buildings must be completely removed by April 1, 2024. Culvert related work and other non-building removal work can occur at any time as approved by the Resident Engineer.

STATUS OF UTILITIES (D1)

Effective: June 1, 2016

Revised: January 1, 2020

Utility companies and/or municipal owners located within the construction limits of this project have provided the following information regarding their facilities and the proposed improvements. The tables below contain a description of specific conflicts to be resolved and/or facilities which will require some action on the part of the Department's contractor to proceed with work. Each table entry includes an identification of the action necessary and, if applicable, the estimated duration required for the resolution.

UTILITIES TO BE ADJUSTED

Conflicts noted below have been identified by following the suggested staging plan included in the contract. The company has been notified of all conflicts and will be required to obtain the necessary permits to complete their work; in some instances, resolution will be a function of the construction staging. The responsible agency must relocate, or complete new installations as noted below; this work has been deemed necessary to be complete for the Department's contractor to then work in the stage under which the item has been listed.

Pre-Stage

STAGE / LOCATION	TYPE	DESCRIPTION	RESPONSIBLE AGENCY	DURATION OF TIME
No conflicts anticipated				

Stage 1

STAGE / LOCATION	TYPE	DESCRIPTION	RESPONSIBLE AGENCY	DURATION OF TIME
No conflicts anticipated				

Stage 2

STAGE / LOCATION	TYPE	DESCRIPTION	RESPONSIBLE AGENCY	DURATION OF TIME
No conflicts anticipated				

No conflicts to be resolved (or if there are conflicts they are to be listed as noted above)

Pre-Stage: _____ Days Total Installation
 Stage 1: _____ Days Total Installation
 Stage 2: _____ Days Total Installation

The following contact information is what was used during the preparation of the plans as provided by the Agency/Company responsible for resolution of the conflict.

Agency/Company Responsible to Resolve Conflict	Name of contact	Phone	E-mail address

UTILITIES TO BE WATCHED AND PROTECTED

The areas of concern noted below have been identified by following the suggested staging plan included for the contract. The information provided is not a comprehensive list of all remaining utilities, but those which during coordination were identified as ones which might require the Department's contractor to take into consideration when making the determination of the means and methods that would be required to construct the proposed improvement. In some instances, the contractor will be responsible to notify the owner in advance of the work to take place so necessary staffing on the owner's part can be secured.

Pre-Stage

20495 W IL 22 Kildeer 20365 W IL 22 Kildeer	Sewer Connection to 18" Sanitary Trunk Sewer	For service disconnections, the contractor will need to contact our Planning Building Department (847-377-2600) and apply for a disconnect permit and pay a fee of \$100 for each permit. LPW shall be notified (48) hours in advance of this work so that an inspection can be scheduled and performed (847-377-7500); Services to be exposed at the top of the riser capped.	Lake County Public Works
20495 W IL 22 Kildeer 20365 W IL 22 Kildeer 4316 Willowbrook Rd Long Grove	Aerial Cable	Aerial Cable on power poles along IL Route 22, and along the east side of Willowbrook Rd.	Comcast
20495 W IL 22 Kildeer 20365 W IL 22 Kildeer 4316 Willowbrook Rd Long Grove	Aerial Cable	Aerial Cable on power poles along IL Route 22, and along the east side of Willowbrook Rd. Service disconnections requests can be obtained by calling ComEd Customer Service 1-866-639-3532.	ComEd

Stage 1

STAGE / LOCATION	TYPE	DESCRIPTION	OWNER

Stage 2

STAGE / LOCATION	TYPE	DESCRIPTION	OWNER

No facilities requiring extra consideration *(or listed as noted above)*

The following contact information is what was used during the preparation of the plans as provided by the owner of the facility.

Agency/Company Responsible to Resolve Conflict	Name of contact	Phone	E-mail address
Lake County Public Works	David Humbert	847-377-7145	DHumbert@lakecountyil.gov
Nicor	Joe Gaca	708-243-5317	jgaca@southernco.com
Comcast	Robert Stoll	224-229-5849	Robert_Stoll2@comcast.com

The above represents the best information available to the Department and is included for the convenience of the bidder. The days required for conflict resolution should be considered in the bid as this information has also been factored into the timeline identified for the project when setting the completion date. The applicable portions of the Standard Specifications for Road and Bridge Construction shall apply.

Estimated duration of time provided above for the first conflicts identified will begin on the date of the executed contract regardless of the status of the utility relocations. The responsible agencies will be working toward resolving subsequent conflicts in conjunction with contractor activities in the number of days noted.

The estimated relocation duration must be part of the progress schedule submitted by the contractor. A utility kickoff meeting will be scheduled between the Department, the Department's contractor and the utility companies when necessary. The Department's contractor is responsible for contacting J.U.L.I.E. prior to all excavation work.

PUBLIC CONVENIENCE AND SAFETY (D1)

Effective: May 1, 2012

Revised: July 15, 2012

Add the following to the end of the fourth paragraph of Article 107.09:

“If the holiday is on a Saturday or Sunday, and is legally observed on a Friday or Monday, the length of Holiday Period for Monday or Friday shall apply.”

Add the following sentence after the Holiday Period table in the fourth paragraph of Article 107.09:

“The Length of Holiday Period for Thanksgiving shall be from 5:00 AM the Wednesday prior to 11:59 PM the Sunday After”

Delete the fifth paragraph of Article 107.09 of the Standard Specifications:

“On weekends, excluding holidays, roadways with Average Daily Traffic of 25,000 or greater, all lanes shall be open to traffic from 3:00 P.M. Friday to midnight Sunday except where structure construction or major rehabilitation makes it impractical.”

BUILDING REMOVAL WITH ASBESTOS ABATEMENT (VILLAGE OF KILDEER AND VILLAGE OF LONG GROVE)

DESCRIPTION: This work shall consist of the complete removal and disposal of 3 building(s), together with all foundations or slabs, retaining walls, piers, basements, and also all incidental and collateral work necessary to complete the removal of the building(s) in a manner approved by the Engineer. The building(s) are identified as follows:

<u>Bldg. No.</u>	<u>Parcel No.</u>	<u>Location</u>	<u>Description</u>
1	1JE0021	20495 W IL Route 22 Kildeer, IL 60047	two-story wood structure constructed single-family with basement
2	1JE0022	20365 W IL Route 22 Kildeer, IL 60047	one-story wooden constructed single-family residence
3	1JE00115	4316 Willowbrook Rd. Long Grove, IL 60047	one-half story cedar constructed single-family Residence
4	1JE00115	4316 Willowbrook Rd. Long Grove, IL 60047	Shed

CONSTRUCTION REQUIREMENTS

General. The IEPA's "State of Illinois Demolition/Renovation/Asbestos Project Notification Form" shall be submitted and a copy sent to the Engineer. It shall be updated if there is a change in the start and/or finish date or if the quantity of asbestos changes by more than 20 percent.

Asbestos abatement work shall be performed by an IDPH licensed Contractor prequalified with the Illinois Capital Development Board who has an on-site supervisor licensed by IDPH and employs workers licensed by IDPH. This work shall be completed according to the requirements of the U.S. Environmental Protection Agency (USEPA), IEPA, OSHA, and local regulatory agencies.

Discontinuance of Utilities. The Contractor shall arrange for the discontinuance of all utility services and the removal of the metering devices that serve the building(s) according to the respective requirements and regulations of the city, county, or utility companies involved. The Contractor shall disconnect and seal the service outlets.

Posting. Upon execution of the contract and prior to the removal of any buildings, the Contractor shall paint or stencil, in contrasting colors of an oil base paint, on all sides of each building or structure, the following posting:

NO TRESPASSING
VIOLATORS WILL BE PROSECUTED

The postings shall be positioned prominently on the structure(s) so they can be easily read and at a sufficient height to prevent defacing.

Asbestos Abatement. Friable asbestos containing building materials (ACBMs) and Category II non-friable ACBMs shall be removed from the building(s) prior to demolition. Category II non-friable ACBMs include asbestos containing transite boards, siding, and other cementitious materials (cement pipe or highly weathered roofing shingles/materials) which have a likelihood of becoming friable during typical demolition activities (by crumbling, pulverizing, or otherwise reducing to powder) making them regulated asbestos containing materials (RACM). Removed ACBM shall be kept separate from non-ACBM demolition debris for purposes of transport and disposal.

Category I non-friable ACBM may be kept in place for demolition or removal of the building unless it has become friable as determined by the ACBM inspector. If the Contractor demolishes the building(s) with the non-friable asbestos in place, the following shall apply.

- (a) The Contractor shall continuously wet the non-friable ACBM and other building debris with water during demolition and loading for disposal.
- (b) The Contractor shall dispose of all demolition debris as ACBM.

The Contractor shall perform air monitoring during asbestos abatement activities. Air sampling shall be conducted by a qualified air sampling professional. Air sampling shall be conducted according to NIOSH Method 7400. Air monitoring equipment shall be calibrated and maintained in proper operating condition. The Contractor shall submit a copy of the air sampling professional's certificate to the Engineer. The results of the tests, and daily calibration and maintenance records shall be kept on site and be available to the Engineer upon request.

Personal monitoring shall be conducted per applicable OSHA regulations. Excursion limits shall be monitored daily, and corrective actions taken immediately to bring excursions within OSHA permissible exposure limits.

When asbestos is removed prior to demolition, clearance testing per IDPH shall be conducted upon the removal of ACBM.

Submittals. The following submittals shall be made to the Engineer prior to the start of the asbestos abatement:

- (a) Manufacturer's certification stating that vacuums, ventilation equipment, and other equipment required to contain airborne fibers conform to ANSI 29.2.
- (b) A listing of the brand name, manufacturer, and specification of all sealants or surfactants to be used.
- (c) Proof that arrangements for transport and disposal of ACBMs have been obtained (i.e., a letter of authorization to utilize designated landfill).
- (d) A detailed work plan of the Contractor's anticipated procedures including the location and layout of decontamination units, the sequencing of work, the respiratory protection plan, a site safety plan, a disposal plan, and a detailed description of the methods to be used to control pollution.
- (e) Proof of the Contractor's prequalification with Capital Development Board and employee certifications with IDPH.

Submittals that shall be made upon completion of abatement work:

- (f) Copies of waste chain-of-custodies, trip tickets, shipping manifests, or disposal receipts for asbestos waste materials removed from the work area.
- (g) Copies of each day's work site entry logbook with information on worker and visitor access.
- (h) Logs documenting filter changes on respirators, HEPA vacuums, negative pressure ventilation units, and other engineering controls.
- (i) Test results of any bulk material analysis and air sampling data collected during the abatement including results of any on-site testing by any federal, state, or local agency.

Any holes, such as basements, shall be backfilled according to Article 502.10.

Basis of Payment. This work will be paid for at the contract lump sum unit price for BUILDING REMOVAL NO. 1,2, and 3.

Removal and disposal of friable ACBM will be paid for at the contract lump sum unit price for REMOVAL AND DISPOSAL OF FRIABLE ASBESTOS, BUILDING NO. 1.

Removal and disposal of non-friable ACBM will be paid for at the contract lump sum unit price for REMOVAL AND DISPOSAL OF NON-FRIABLE ASBESTOS, BUILDING NO. 1, 2, and 3.

Buildings No. 1 – 20495 W IL 22 Kildeer, IL 60047



SECTION 1
 1.1 SURVEY SUMMARY SHEET

ACM SURVEY RESULTS - Parcel No. 1JE20021
 Single Family Residence
 20495 W. Route 22
 Kildeer, IL 60047

The following homogeneous building material types were sampled as part of this survey and their results are summarized in the table below:

MTL #	MATERIAL DESCRIPTION	LOCATION	F/NF ¹	COND. ²	% ACM ³	# SAMPLES	QUANTITY (ENG/MET)
01	Roofing Shingles Black	Front of House	NF	Good	ND	3	1,500 SF
02	Roofing Shingles Green	Back of House	NF	Good	ND	3	1,500 SF
03	Black Mastic	Roof Under Shingles Around Chimney	NF	Good	5% CH	3	100 SF
04	9x9 Green Floor Tile	East Bedrooms	NF	Good	ND	3	800 SF
05	12x12 White Floor Tile/ Mastic	Bathroom	NF	Good	ND	3	50 SF
06 (1)	12x12 White Floor Tile/ Mastic	Kitchen	NF	Good	ND	3	3,600 SF
06 (2)	12x12 White Floor Tile Yellow Mastic	Kitchen	NF	Good	ND	3	3,600 SF
06 (3)	Beige Flooring Under 12x12 White Floor Tile	Kitchen	NF	Good	10% CH	3	3,600 SF
06 (4)	Brown Fiber Board Under 12x12 White Floor Tile	Kitchen	NF	Good	ND	3	3,600 SF
07	White Drywall	Kitchen, Living Room, Basement	F	Good	ND	3	2,000 SF
08	White Plaster	Living Room, Hallway, Basement	NF	Good	ND	3	800 SF
09	Gray Duct Insulation	Basement	F	Good	50% CH	3	90 LF
10	Black Felt	In between Garage and House	NF	Good	ND	3	200 SF
11	White Window Caulking	Around all windows	NF	Good	ND	3	14 Each
TOTAL QUANTITY OF ACM							3,700 SF 90 LF
ESTIMATED ABATEMENT COST							\$28,050.00

¹ F = Friable; NF = Nonfriable Friability is further defined in section 4.
² Cond. = Condition Of Materials Either good, fair or poor.
³ ND = None Detected
^{*} Point Count Analysis

APPENDIX A
Building No. 1 – 20495 W. IL Route 22, Kildeer IL, 60047

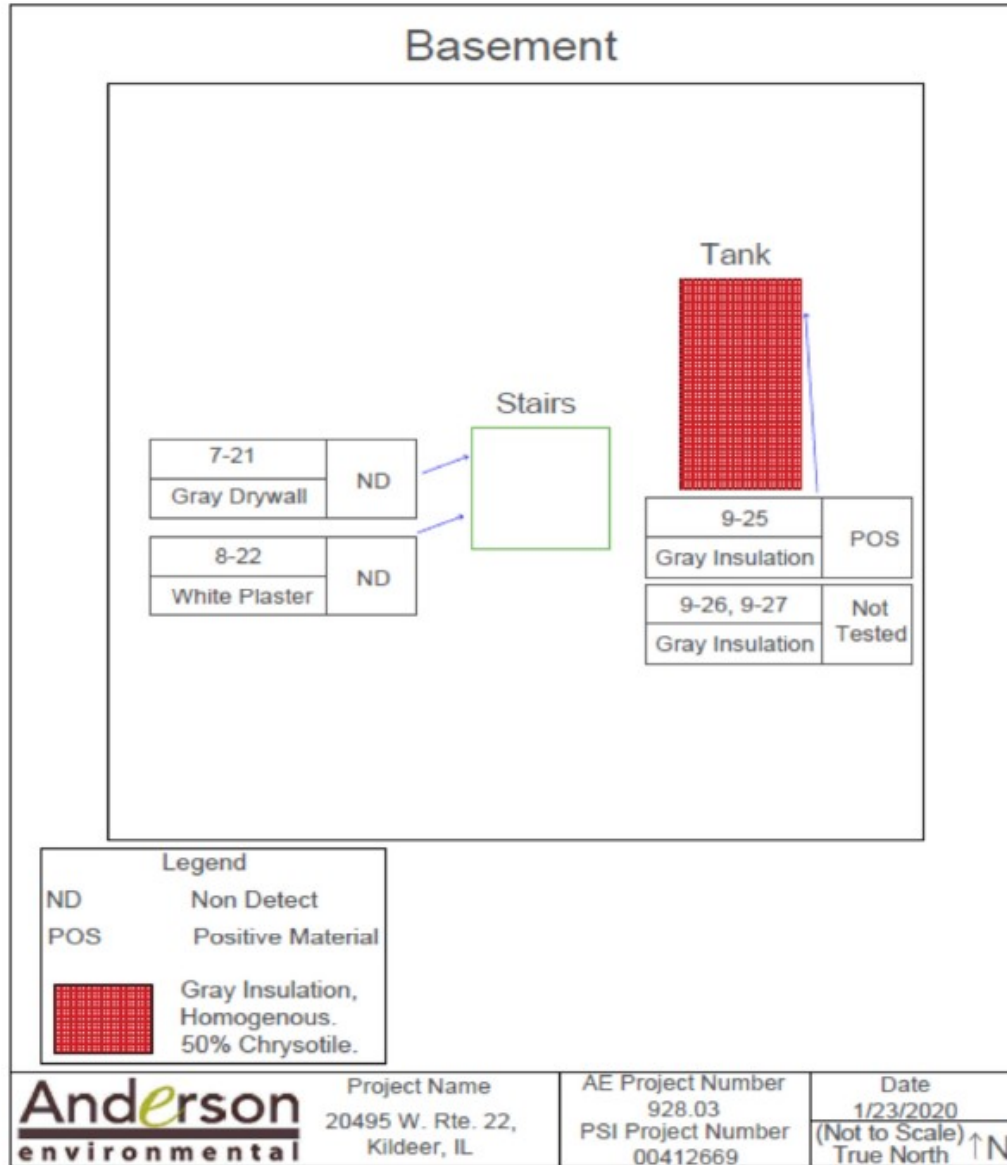

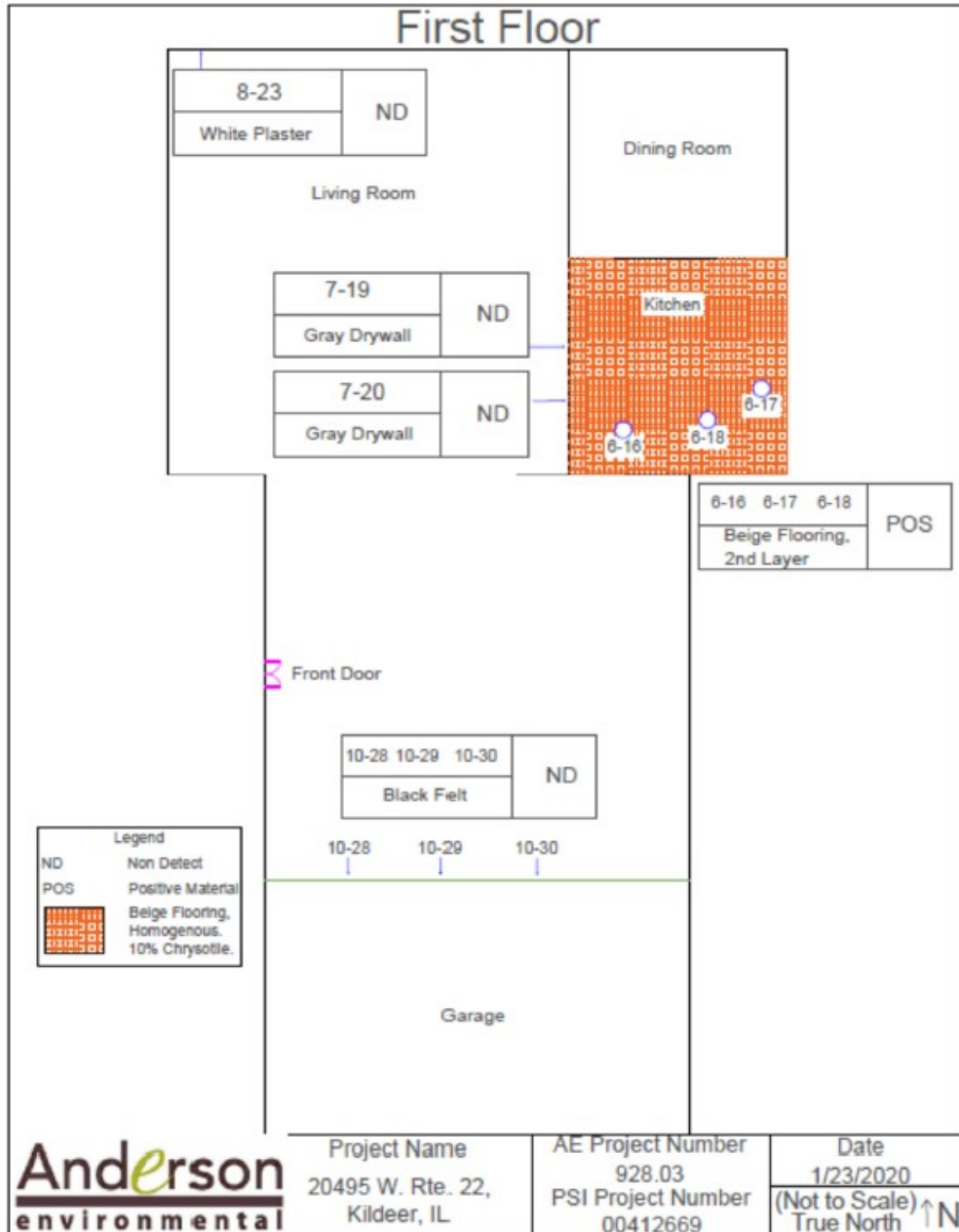

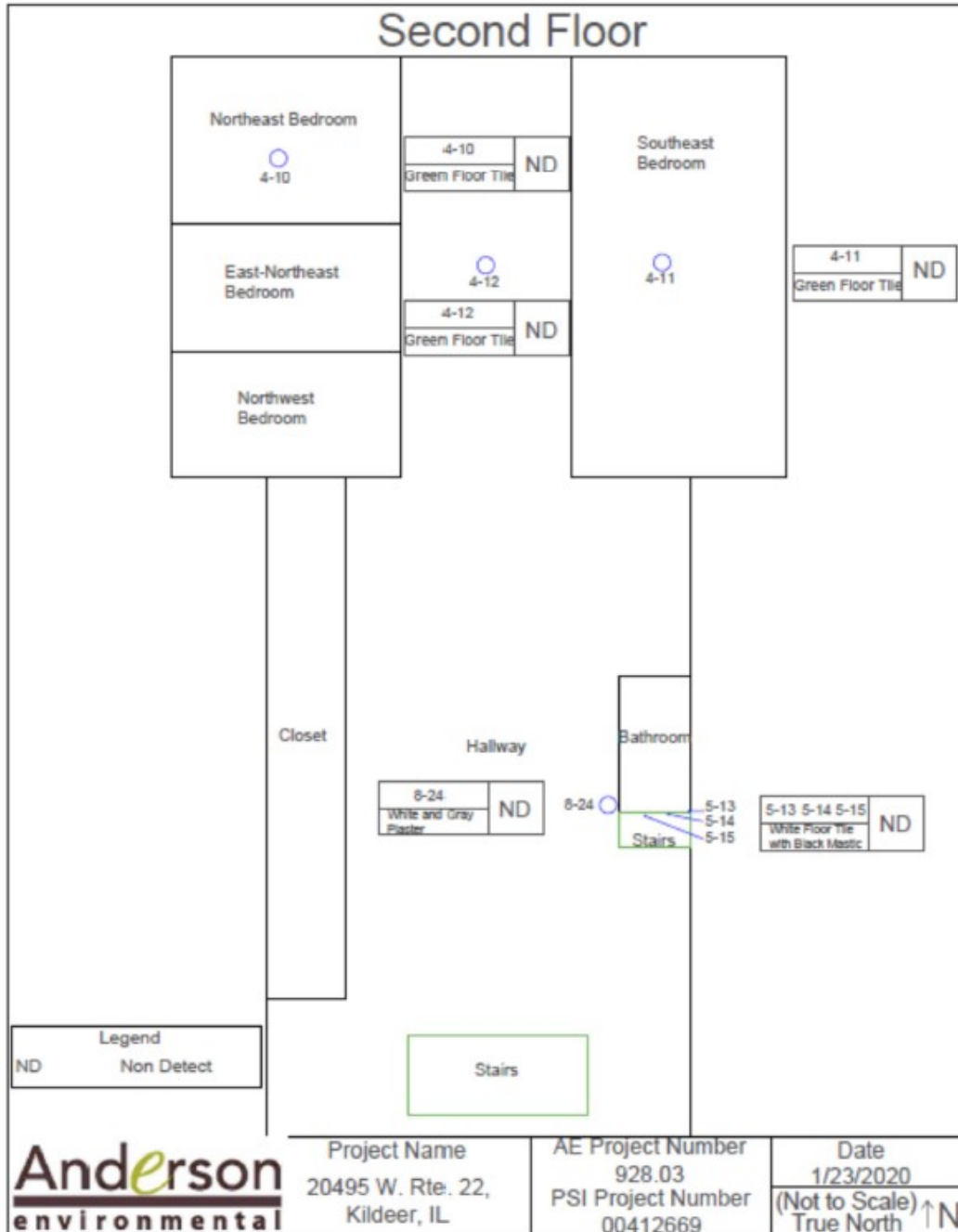

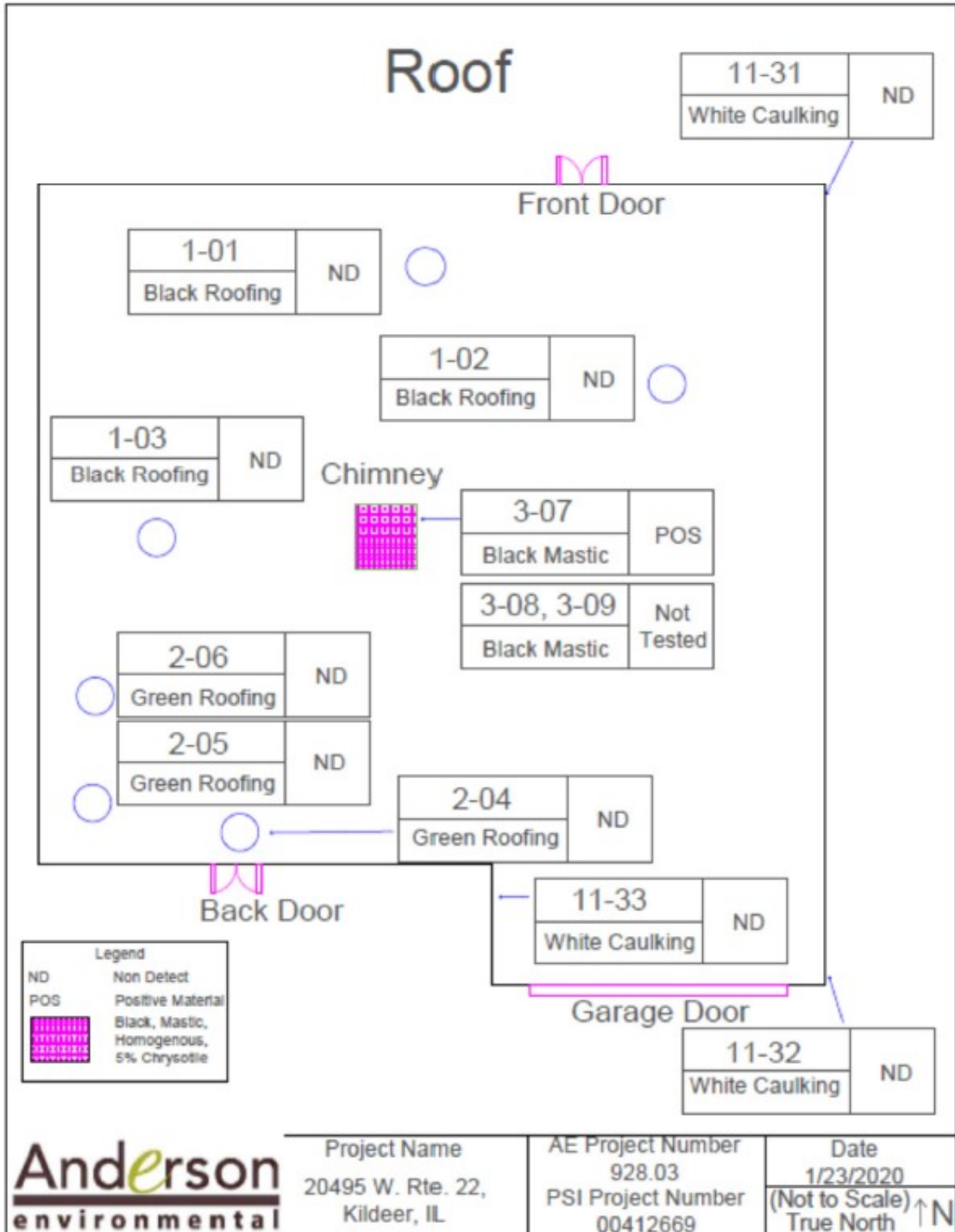

Buildings No. 2 – 20365 W IL 22 , Kildeer, IL 60047



SECTION 2
 INTRODUCTION

ACM SURVEY RESULTS - Parcel No. 1JE0022
 Single Family Residence
 20365 W. IL Route 22
 Kildeer, IL 60047

The following homogeneous building material types were sampled as part of this survey and their results are summarized in the table below:

MTL #	MATERIAL DESCRIPTION	LOCATION	F/NF ¹	COND. ²	% ACM ³	# SAMPLES	QUANTITY (ENG/MET)
01	Roofing Shingles/ Felt	House & front over porch	NF	Good	ND	3	1,200 SF
02	12x12 Brown Floor Tile	Kitchen	NF	Good	ND	3	200 SF
03	White Joint Compound	Kitchen, living room	F	Good	ND	2	1,000 SF
03	White Skim Coat	Basement	F	Good	ND	1	1,000 SF
04	Window Caulking	Around Windows	NF	Good	ND	3	300 LF
TOTAL QUANTITY OF ACM							0 SF
ESTIMATED ABATEMENT COST							\$0

¹ F = Friable; NF = Nonfriable Friability is further defined in section 4.
² Cond. = Condition Of Materials Either good, fair or poor.
³ ND = None Detected
 * Point Count Analysis

Building No. 2 – 20365 W. IL Route 22, Kildeer, IL 60047

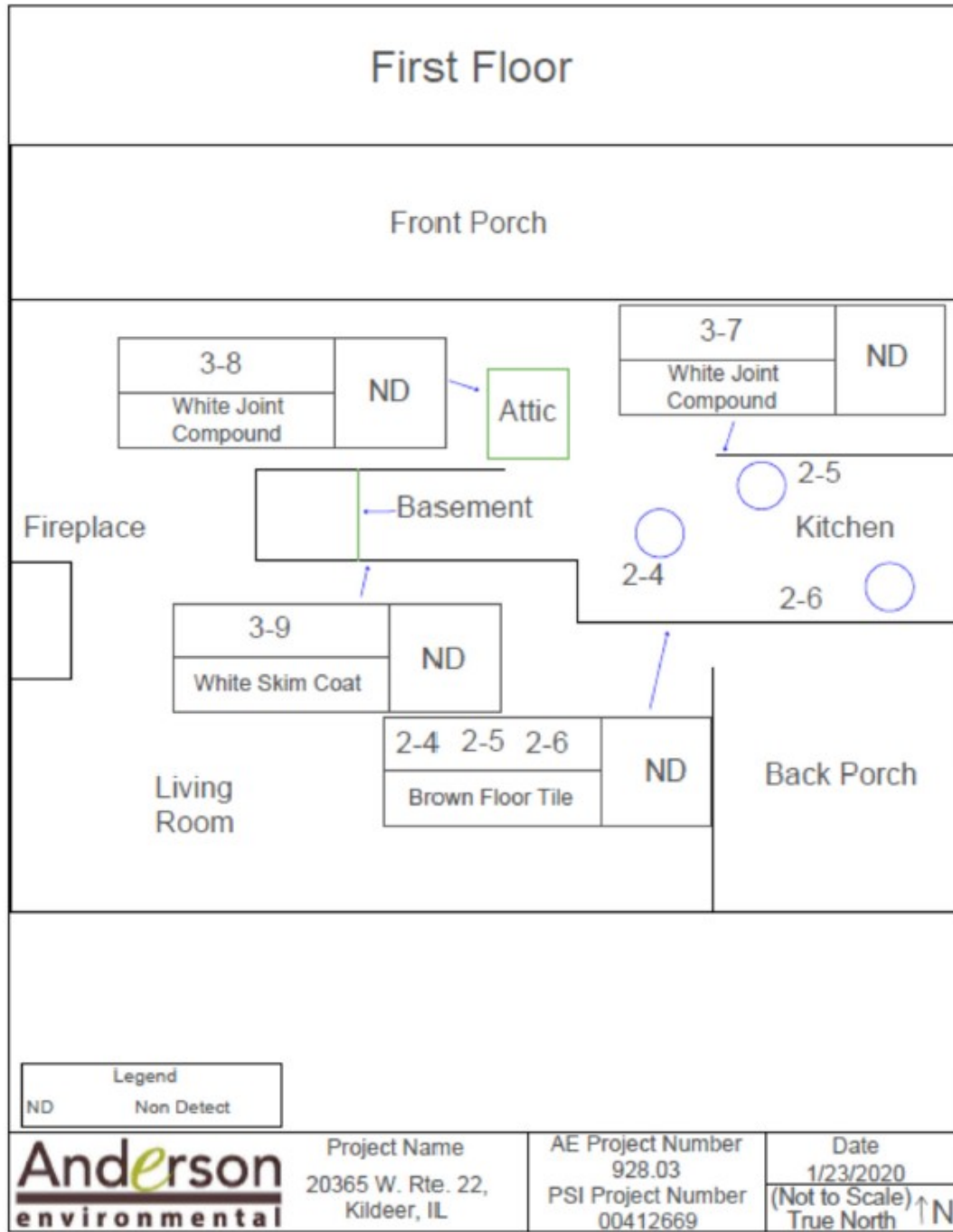

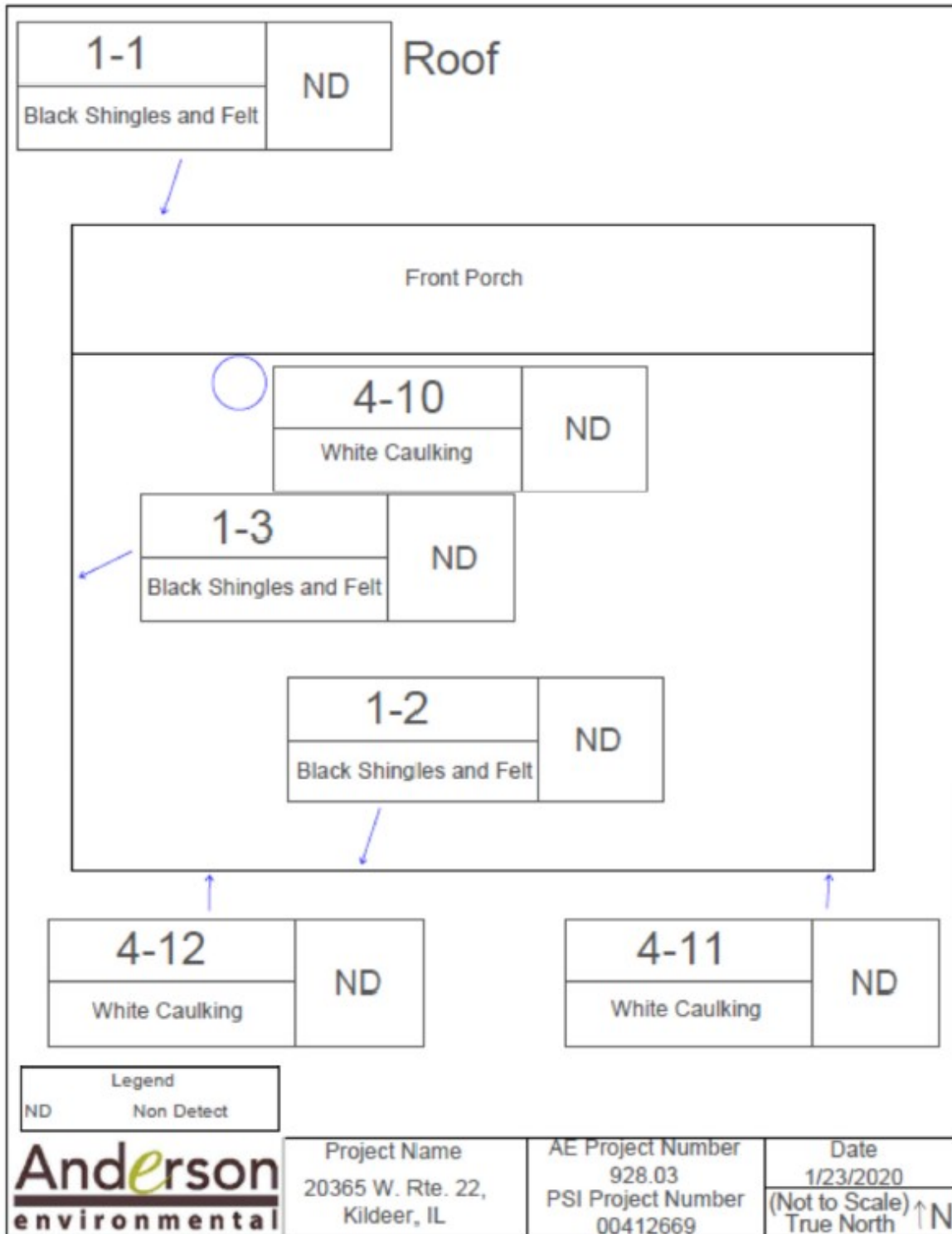

Buildings No. 3 and No. 4 - 4316 Willowbrook Rd, Long Grove IL 60047



SECTION 1
 1.2 SURVEY SUMMARY & RESULTS

ACM SURVEY RESULTS - Parcel No. 1JE0115
 Single Family Residence
 4316 Willowbrook Road
 Long Grove, Illinois 60047

The following homogeneous building material types were sampled as part of this survey and their results are summarized in the table below:

MTL #	MATERIAL DESCRIPTION	LOCATION	F/NF ¹	COND. ²	% ACM ³	# SAMPLES	QUANTITY (ENG/MET)
01	Layered Plaster	Kitchen, Dining, 1 st Floor Hallway, BR 2	NF	Poor	ND	5	4,000 SF 371.6 SM
02	Black Underlayment	Exterior Roof & Walls	NF	Good	ND	3	17,500 SF 1,625 SM
03	Thin Gypsum Paneling	Below Plaster	NF	Good	ND	3	5,000 SF 464.5 SM
04	Green Linoleum	Kitchen	NF	Good	10% Chrysotile	3	140 SF 13 SM
05	Black Linoleum	Kitchen, 2 nd layer	NF	Good	10% Chrysotile	3	140 SF 13 SM
06	White Plaster	Boiler Cover	NF	Good	ND	3	50 SF 4.6 SM
07	9" x 9" Beige & Brown Spotted Vinyl Floor Tile/Mastic	BR 3	NF	Good	5% CH Tile 5% CH Mastic	3	400 SF 65 SM
08	Drywall/Joint Compound	Garage, Work Room, Bath 1, BR 1, BR 3, Study	F	Good	<1%* Chrysotile	3	7,000 SF 650.3 SM
09	Black Underlayment	1 st Floor throughout, Garage	NF	Good	ND	3	1,500 SF 139.4 SM
10	Black Rolled Sheeting	Covered Roof in Attic	NF	Good	ND	3	60 SF 5.6 SM
11	Window Glazing	House Windows	NF	Poor	<1% Chrysotile	3	2,160 LF 658.4 LM
12	Roofing Shingles	Outbuilding Roof	NF	Good	ND	3	225 SF 20.9 SM
13	Window Glazing	Outbuilding Windows	NF	Good	ND	3	190 LF 57.9 LM
TOTAL QUANTITY OF ACM							680 SF
ESTIMATED ABATEMENT COST							\$4,380.00

¹ F = Friable; NF = Nonfriable Friability is further defined in section 4.
² Cond. = Condition Of Materials Either good, fair or poor.
³ ND = None Detected
 * Point Count Analysis



SECTION 1
 1.2 SURVEY SUMMARY & RESULTS

ACM SURVEY RESULTS - Parcel No. 1JE0115
 Shed
 4316 Willowbrook Road
 Long Grove, Illinois 60047

The following homogeneous building material types were sampled as part of this survey and their results are summarized in the table below:

MTL #	MATERIAL DESCRIPTION	LOCATION	F/NF ¹	COND. ²	% ACM ³	# SAMPLES	QUANTITY (ENG/MET)
01	Roof Shingles	Shed Roof	NF	Good	ND	3	300 SF
02	Window Glazing	Shed Windows	NF	Good	ND	3	10 EA
03	Chimney Flashing	Shed Chimney	NF	Good	ND	3	6 LF
TOTAL QUANTITY OF ACM							0 SF
ESTIMATED ABATEMENT COST							0

¹ F = Friable; NF = Nonfriable Friability is further defined in section 4.
² Cond. = Condition Of Materials Either good, fair or poor.
³ ND = None Detected
 * Point Count Analysis

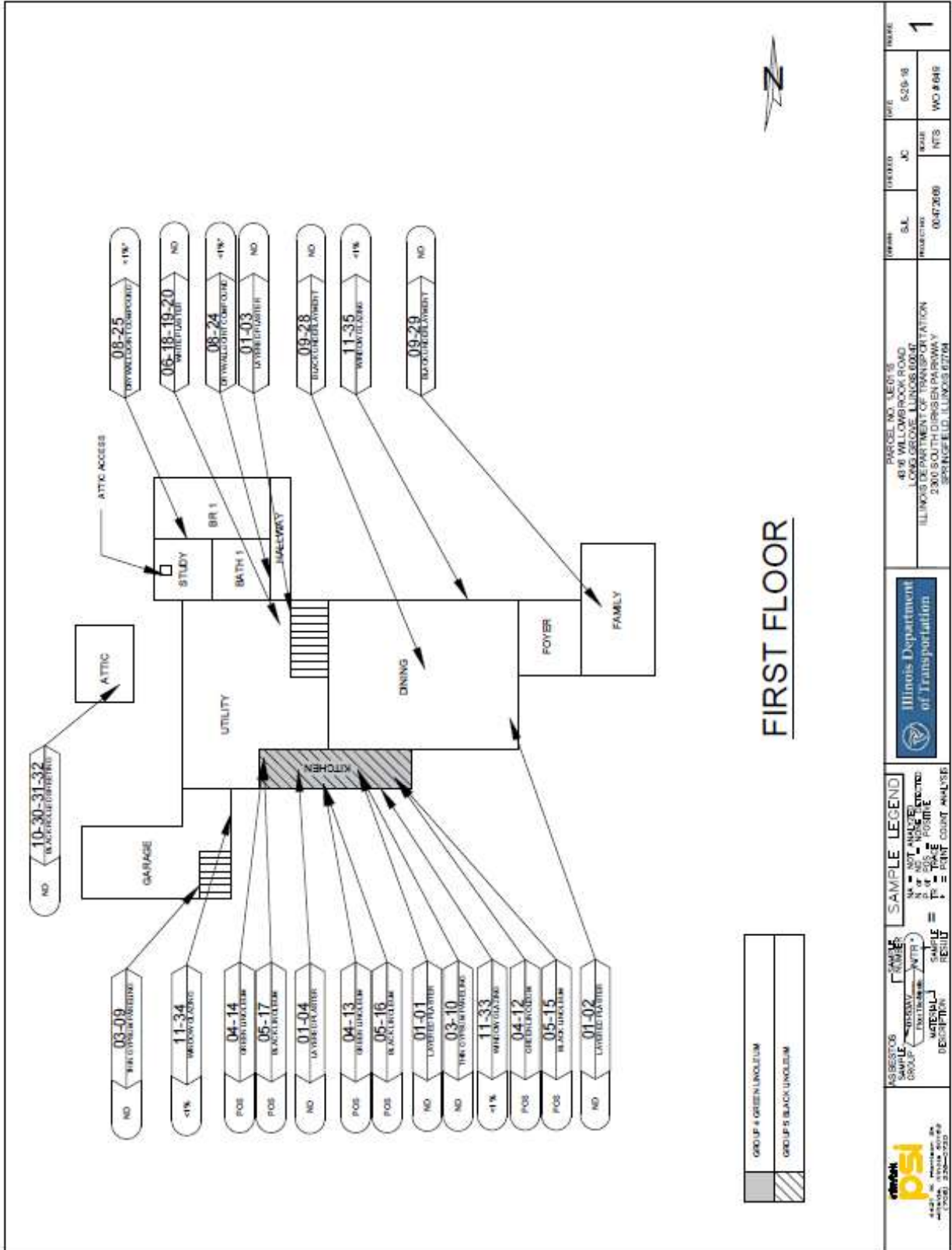

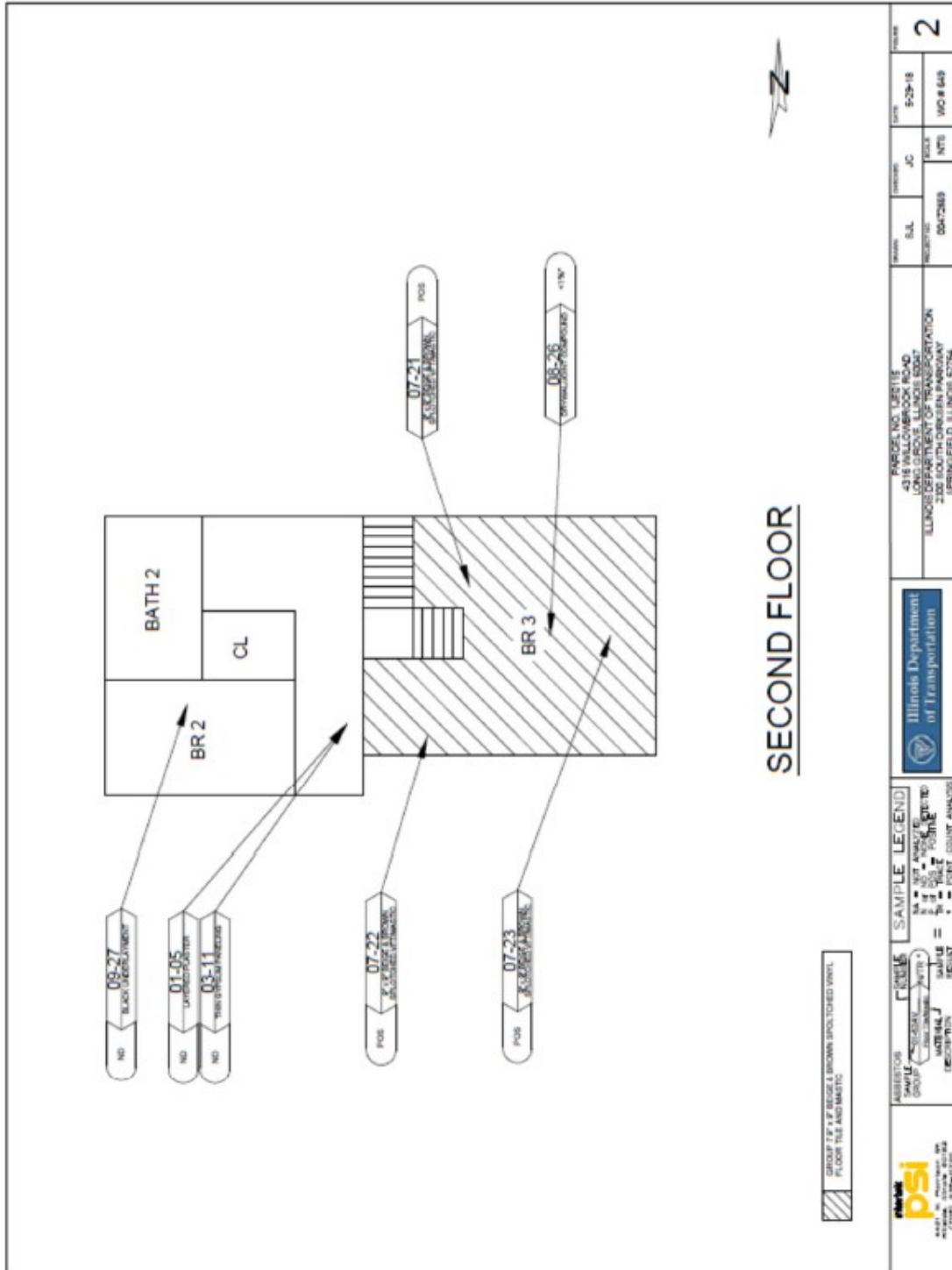

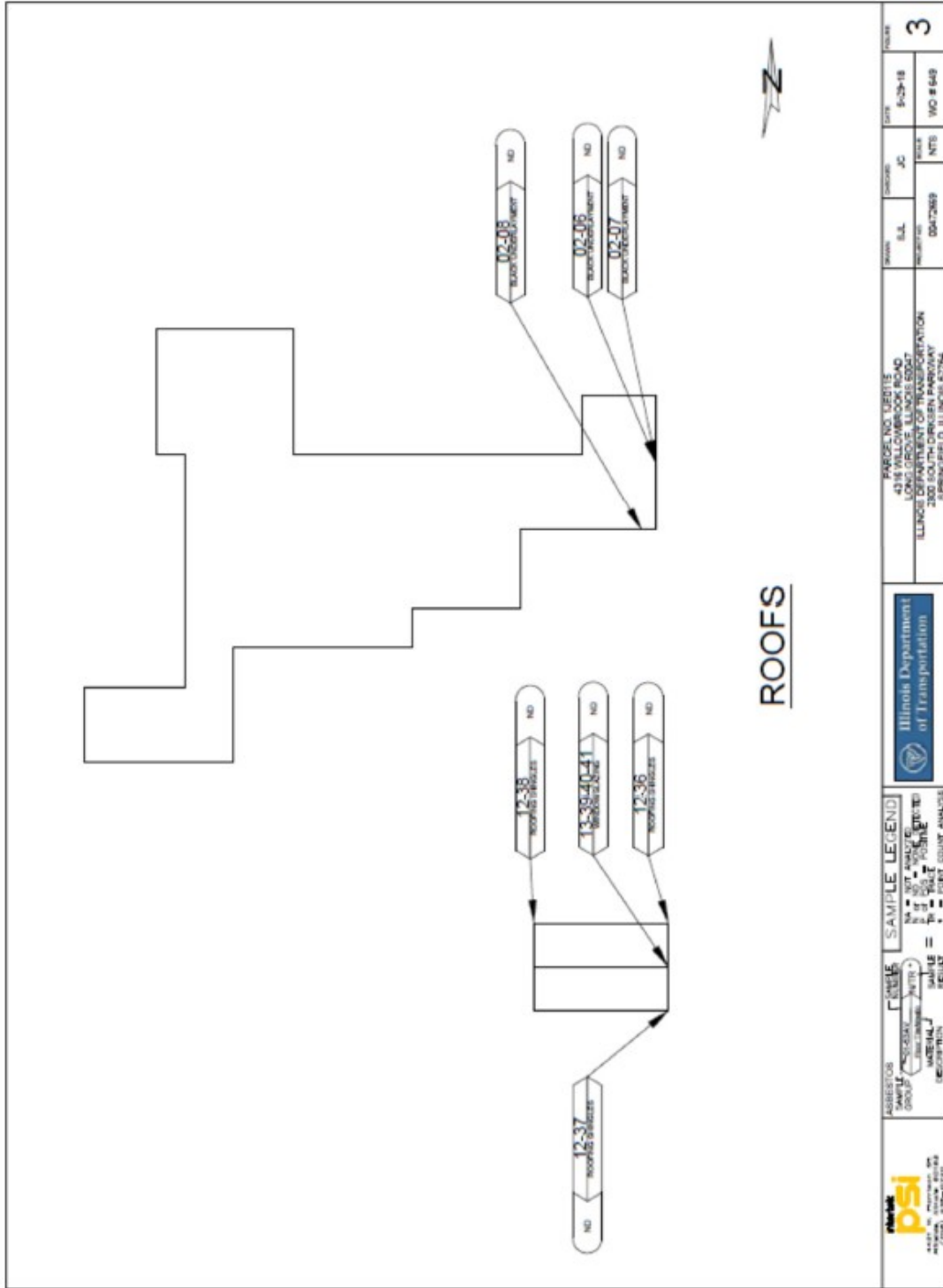

APPENDIX B

MATERIAL DESCRIPTION TABLE

Material Description	% And Type Of Asbestos	Location, Description, Sample Number (If Applicable)
I. <u>Location 1 (20495 W IL Route 22)</u>		
Black Mastic	5% CH	Roof Under Shingles Around Chimney
Beige Flooring Under 12x12 White Floor Tile	10% CH	Kitchen
Gray Duct Insulation	50% CH	Basement
II. <u>Location 3 (4316 Willowbrook Rd)</u>		
Green Linoleum	10% chrysotile	Kitchen
Black Linoleum	10% chrysotile	Kitchen, 2 nd layer
9" x 9" Beige & Brown Spotted Vinyl Floor	5% CH Tile 5% CH Mastic	Bedroom 3
Drywall/Joint Compound	<1%Chrysotile	Garage, Work Room, Bath 1, BR 1, BR 3, Study
Window Glazing	<1%Chrysotile	House Windows

APPENDIX C

MATERIAL QUANTITIES TABLE

The following are approximate quantities of ACM to be removed from the building indicated. These material quantities do not indicate the cleaning required to remove asbestos debris and resulting contamination from the work areas.

I. Location 1 (20495 W IL Route 22)

<u>Material</u>	<u>Floor</u>	<u>Quantity Present</u>	<u>Friable</u>
Black Mastic on Chimney	Roof	100 S.F.	No
Beige Flooring beneath 12" x 12P White Floor Tile	First	3600 S.F.	No
Gray Duct	Basement	90 L.F.	Yes

II. Location 3 (4316 Willowbrook Rd)

<u>Material</u>	<u>Floor</u>	<u>Quantity Present</u>	<u>Friable</u>
Green Linoleum	First	140 S.F.	No
Black Linoleum	First	140 S.F.	No
9" x 9" Beige & Brown Spotched Vinyl Floor	Second	400 S.F.	No
Drywall/Joint Compound	First, Second	7000 S.F.	No
Window Glazing	First, Second	2160 L.F.	No

DOCUMENTATION OF ROADWAY CONDITIONS BEFORE AND AFTER CONSTRUCTION – PRIVATE ROAD

Description

This work shall consist of documenting the roadway conditions of the privately owned Willowbrook Road before and after the commencement of construction activities related to the demolition of the residential building located at: 4316 Willowbrook Road in Long Grove IL. This special provision applies only to the section of Willowbrook Road from south of the intersection of Willowbrook Road and Illinois Route 22 to just south of the entrance of the demolition site, approximately 900 FT from Illinois Route 22.

Pre-Construction:

A pre-construction condition inspection shall be performed prior to the construction operations taking place. The Contractor shall invite the Engineer to the inspection of the roadway condition. The Contractor is to notify the Engineer the date of the inspection 10 business days prior to the start of inspection. It is the responsibility of the Engineer to contact Mark Challenger from Willowbrook Woods HOA at 847-343-7032 or markc@mindbuilder.com and invite them to the inspection.

The roadway condition inspection shall consist of the following:

- Documentation of existing conditions of Willowbrook Road from south of Illinois Route 22 to just south of the entrance of the demolition site.
- Documentation in the form of digital photographs shall include a written detailed log of each photograph and digital narrated video representative of the actual conditions of the existing pavement, shoulders, and other items, as described in this special provision.
- Photograph and video requirements: Digital photographic images and digital format video recordings shall be stored on a DVD. Digital video shall be viewable by standard video software.
- Items to be documented include, but are not limited to pavement, shoulders, immediately surrounding vegetation, landscaping features, driveways, fences, and any other items in the vicinity of the roadway having a potential for getting damaged when construction equipment utilizes Willowbrook Road to access the demolition site.
- Existing defects such as, but not limited to, evidence of cracking, damage, drainage, ponding and so forth shall be documented. Any existing cracks shall be located, measured, and recorded at the time of inspection. All existing deficiencies, major or minor, shall be documented.
- One calendar week prior to the start of construction, the Contractor shall prepare and deliver to the Engineer two DVDs/electronic copies of the pre-construction condition inspection report containing digital photographs, written photograph log, and digital video, as well as any supplementary documentation items voluntarily produced at the Contractor's discretion.

During Construction:

- It is the Contractor's responsibility to confirm the construction equipment could be borne by the existing pavement on Willowbrook Road without causing any damage.
- The Contractor shall notify the Engineer of any damages to the pavement or documented items that occur as a result of the utilization of Willowbrook Road to access the demolition site.
- The Contractor shall be responsible to make necessary repairs to restore the damaged item(s) to their original condition or better to the satisfaction of the Engineer and Willowbrook Woods HOA at Contractor's cost.

Post-Construction:

Prior to completion of construction operations, the Contractor shall complete a post-construction condition inspection of Willowbrook Road in a manner that duplicates the pre-construction condition inspection. The Contractor shall invite the Engineer to the inspection of the roadway condition. The Contractor is to notify the Engineer the date of the inspection 10 business days prior to the start of inspection. It is the responsibility of the Engineer to contact Mark Challenger from Willowbrook Woods HOA at 847-343-7032 or markc@mindbuilder.com and invite them to the inspection.

- One calendar week after completion of the roadway condition inspection, the Contractor shall prepare and deliver to the Engineer two DVDs/electronic copies of the post-construction condition inspection report containing digital photographs, written photograph log, and digital video, as well as any supplementary documentation items voluntarily produced at the Contractor's discretion. The result of the post-construction condition inspection shall be compared to the results of the pre-construction condition inspection. Any similarities or differences shall be noted in the final report.
- The Willowbrook Woods HOA and the Engineer will need to review the post-construction condition report's digital photographs, photograph log, and digital video within 10 business day from the day it was received from the Contractor. The Willowbrook Woods HOA will notify the Engineer of any additional damage to the roadway from pre-construction conditions within 10 business days from the day it was submitted by the contractor. The contractor shall be responsible to make necessary repairs to restore the damaged item(s) to their original condition or better to the satisfaction of the Engineer and Willowbrook Woods HOA at Contractor's cost.

Measurement and Payment. This work will be paid for at the contract lump sum price for CONSTRUCTION LAYOUT (SPECIAL).

TRAFFIC CONTROL PLAN (D1)

Effective: September 30, 1985

Revised: January 1, 2007

Traffic Control shall be according to the applicable sections of the Standard Specifications, the Supplemental Specifications, the "Illinois Manual on Uniform Traffic Control Devices for Streets and Highways", any special details and Highway Standards contained in the plans, and the Special Provisions contained herein.

Special attention is called to Article 107.09 of the Standard Specifications and the following Highway Standards, Details, Quality Standard for Work Zone Traffic Control Devices, Recurring Special Provisions and Special Provisions contained herein, relating to traffic control.

The Contractor shall contact the District One Bureau of Traffic at least 72 hours in advance of beginning work.

STANDARDS: 701001,701006,701301, 701901

DETAILS:

Traffic Control and Protection for Side Roads, Intersections, and Driveways (TC-10)
Arterial Road Information Sign (TC-22)

SPECIAL PROVISIONS:

Maintenance of Roadways
Public Convenience and Safety (D-1)
Temporary Information Signing
Work Zone Traffic Control Devices(BDE)

COFFERDAM (TYPE 1) (IN-STREAM/WETLAND WORK) (D1)

Effective: January 1, 2019

Revised: August 15, 2022

Description. This work shall be performed in accordance with Section 502.06 of the Standard Specifications for Road and Bridge Construction, except as herein modified. The work shall consist of the preparation of an in-stream/wetland work plan and the installation, maintenance, removal and disposal of the temporary cofferdam(s) to isolate the work area from water within regulated wetlands and Waters of the U.S. (WOUS) in accordance with the authorized U.S. Army Corps of Engineers (USACE) Section 404 Permit and the General Conditions of the current Nationwide Permit Program.

Materials. Materials shall be in accordance with the USACE Section 404 Permit and General Conditions of the current Nationwide Permit Program.

Construction Requirements. Construction shall be in accordance with Article 502.06(a) of the Standard Specifications for Road and Bridge Construction and in accordance with the authorized USACE Section 404 Permit. For Cofferdam - Type 1, it is anticipated the design will be based on the flow requirement as shown in the plans and per the General Conditions of the current Nationwide Permit Program.

The Contractor shall be responsible for diverting the water flow from the construction area using a method meeting the approval of the Engineer and in accordance with the authorized USACE Section 404 Permit and General Conditions of the current Nationwide Permit Program.

This project requires a USACE Section 404 Permit prior to the start of work. All conditions of the Section 404 Permit must be followed. As a condition of the Section 404 Permit, the Contractor will be required to submit an In-Stream/Wetland Work Plan to the Department for approval. The USACE defines and determines in-stream/wetland work within the WOUS.

Guidelines on acceptable In-Stream/Wetland work techniques can be found on the USACE website: <https://www.lrc.usace.army.mil/Missions/Regulatory/Illinois/IL-Nationwide-Permits/>

Method of Measurement. This work will be measured for payment in units of Each where Each is defined as a plan detailed stage of bridge, culvert or other construction for which a temporary in-stream cofferdam(s) is required. If staged construction is not detailed/specified on the plans, this work will be measured as a total of One Each.

Basis of Payment. This work will be paid for at the contract unit price per each for COFFERDAM (TYPE 1) (IN-STREAM/WETLAND WORK).

ENGINEER'S FIELD OFFICE TYPE A (D1)

Effective: January 1, 2022

Revise the first paragraph of Article 670.02 to read:

670.02 Engineer's Field Office Type A (D1). Type A (D1) field offices shall have a ceiling height of not less than 7 feet and a floor space of not less than 1000 square feet with a minimum of two separate offices. The office shall also have a separate storage room capable of being locked for the storage of the nuclear measuring devices. The office shall be provided with sufficient heat, natural and artificial light, and air conditioning. Doors and windows shall be equipped with locks approved by the Engineer.

Add the following to Article 670.07 Basis of Payment.

The building or buildings, fully equipped, will be paid for at the contract unit price per calendar month or fraction thereof for ENGINEER'S FIELD OFFICE, TYPE A (D1).

DEBRIS REMOVAL

Effective: June 27, 2002

Description. This work shall consist of the satisfactory removal and disposal of debris from the waterway opening as shown on the plans.

Construction Requirements. This work shall be performed according to Article 202.03 of the Standard Specifications for removal of unsuitable material and organic waste. Any photographs included in the plans are intended to show the existing condition upon which quantities were estimated.

Method of Measurement. The volume of debris removed will be measured for payment in cubic yards. Actual field conditions may vary. The actual extent of debris removal shall be determined by the Engineer. The volume of debris removed will be measured for payment in cubic yards adjusted for voids, as determined by the Engineer, once the material is loaded and is ready to be hauled off site.

Basis of Payment. This work will be paid for at the contract unit price per cubic yard for DEBRIS REMOVAL.

TEMPORARY INFORMATION SIGNING

Effective: November 13, 1996

Revised: January 29, 2020

Description.

This work shall consist of furnishing, installing, maintaining, relocating for various states of construction and eventually removing temporary informational signs. Included in this item may be ground mount signs, skid mount signs, truss mount signs, bridge mount signs, and overlay sign panels which cover portions of existing signs.

Materials.

Materials shall be according to the following Articles of Section 1000 - Materials:

	<u>Item</u>	<u>Article/Section</u>
a.)	Sign Base (Note 1)	1090
b.)	Sign Face (Note 2)	1091
c.)	Sign Legends	1091
d.)	Sign Supports	1093
e.)	Overlay Panels (Note 3)	1090.02

Note 1. The Contractor may use 5/8 inch (16 mm) instead of 3/4 inch (19 mm) thick plywood.

Note 2. The sign face material shall be in accordance with the Department's Fabrication of Highway Signs Policy.

Note 3. The overlay panels shall be 0.08 inch (2 mm) thick.

GENERAL CONSTRUCTION REQUIREMENTS

Installation.

The sign sizes and legend sizes shall be verified by the Contractor prior to fabrication.

Signs which are placed along the roadway and/or within the construction zone shall be installed according to the requirements of Article 701.14 and Article 720.04. The signs shall be 7 ft (2.1 m) above the near edge of the pavement and shall be a minimum of 2 ft (600 mm) beyond the edge of the paved shoulder. A minimum of two (2) posts shall be used.

The attachment of temporary signs to existing bridges, sign structures or sign panels shall be approved by the Engineer. Any damage to the existing signs and/or structures due to the Contractor's operations shall be repaired or signs replaced, as determined by the Engineer, at the Contractor's expense.

Method of Measurement.

This work shall be measured for payment in square feet (square meters) edge to edge (horizontally and vertically).

All hardware, posts or skids, supports, bases for ground mounted signs, connections, which are required for mounting these signs will be included as part of this pay item.

Basis Of Payment.

This work shall be paid for at the contract unit price per square foot (square meter) for TEMPORARY INFORMATION SIGNING.

COMPENSABLE DELAY COSTS (BDE)

Effective: June 2, 2017

Revised: April 1, 2019

Revise Article 107.40(b) of the Standard Specifications to read:

“(b) Compensation. Compensation will not be allowed for delays, inconveniences, or damages sustained by the Contractor from conflicts with facilities not meeting the above definition; or if a conflict with a utility in an unanticipated location does not cause a shutdown of the work or a documentable reduction in the rate of progress exceeding the limits set herein. The provisions of Article 104.03 notwithstanding, compensation for delays caused by a utility in an unanticipated location will be paid according to the provisions of this Article governing minor and major delays or reduced rate of production which are defined as follows.

- (1) Minor Delay. A minor delay occurs when the work in conflict with the utility in an unanticipated location is completely stopped for more than two hours, but not to exceed two weeks.
- (2) Major Delay. A major delay occurs when the work in conflict with the utility in an unanticipated location is completely stopped for more than two weeks.
- (3) Reduced Rate of Production Delay. A reduced rate of production delay occurs when the rate of production on the work in conflict with the utility in an unanticipated location decreases by more than 25 percent and lasts longer than seven calendar days.”

Revise Article 107.40(c) of the Standard Specifications to read:

“(c) Payment. Payment for Minor, Major, and Reduced Rate of Production Delays will be made as follows.

- (1) Minor Delay. Labor idled which cannot be used on other work will be paid for according to Article 109.04(b)(1) and (2) for the time between start of the delay and the minimum remaining hours in the work shift required by the prevailing practice in the area.

Equipment idled which cannot be used on other work, and which is authorized to standby on the project site by the Engineer, will be paid for according to Article 109.04(b)(4).

- (2) Major Delay. Labor will be the same as for a minor delay.

Equipment will be the same as for a minor delay, except Contractor-owned equipment will be limited to two weeks plus the cost of move-out to either the Contractor’s yard or another job and the cost to re-mobilize, whichever is less. Rental equipment may be paid for longer than two weeks provided the Contractor presents adequate support to the Department (including lease agreement) to show retaining equipment on the job is the most economical course to follow and in the public interest.

- (3) Reduced Rate of Production Delay. The Contractor will be compensated for the reduced productivity for labor and equipment time in excess of the 25 percent threshold for that portion of the delay in excess of seven calendar days. Determination of compensation will be in accordance with Article 104.02, except labor and material additives will not be permitted.

Payment for escalated material costs, escalated labor costs, extended project overhead, and extended traffic control will be determined according to Article 109.13.”

Revise Article 108.04(b) of the Standard Specifications to read:

“(b) No working day will be charged under the following conditions.

- (1) When adverse weather prevents work on the controlling item.
- (2) When job conditions due to recent weather prevent work on the controlling item.
- (3) When conduct or lack of conduct by the Department or its consultants, representatives, officers, agents, or employees; delay by the Department in making the site available; or delay in furnishing any items required to be furnished to the Contractor by the Department prevents work on the controlling item.
- (4) When delays caused by utility or railroad adjustments prevent work on the controlling item.
- (5) When strikes, lock-outs, extraordinary delays in transportation, or inability to procure critical materials prevent work on the controlling item, as long as these delays are not due to any fault of the Contractor.
- (6) When any condition over which the Contractor has no control prevents work on the controlling item.”

Revise Article 109.09(f) of the Standard Specifications to read:

“(f) Basis of Payment. After resolution of a claim in favor of the Contractor, any adjustment in time required for the work will be made according to Section 108. Any adjustment in the costs to be paid will be made for direct labor, direct materials, direct equipment, direct jobsite overhead, direct offsite overhead, and other direct costs allowed by the resolution. Adjustments in costs will not be made for interest charges, loss of anticipated profit, undocumented loss of efficiency, home office overhead and unabsorbed overhead other than as allowed by Article 109.13, lost opportunity, preparation of claim expenses and other consequential indirect costs regardless of method of calculation.

The above Basis of Payment is an essential element of the contract and the claim cost recovery of the Contractor shall be so limited.”

Add the following to Section 109 of the Standard Specifications.

“109.13 Payment for Contract Delay. Compensation for escalated material costs, escalated labor costs, extended project overhead, and extended traffic control will be allowed when such costs result from a delay meeting the criteria in the following table.

Contract Type	Cause of Delay	Length of Delay
Working Days	Article 108.04(b)(3) or Article 108.04(b)(4)	No working days have been charged for two consecutive weeks.
Completion Date	Article 108.08(b)(1) or Article 108.08(b)(7)	The Contractor has been granted a minimum two week extension of contract time, according to Article 108.08.

Payment for each of the various costs will be according to the following.

- (a) Escalated Material and/or Labor Costs. When the delay causes work, which would have otherwise been completed, to be done after material and/or labor costs have increased, such increases will be paid. Payment for escalated material costs will be limited to the increased costs substantiated by documentation furnished by the Contractor. Payment for escalated labor costs will be limited to those items in Article 109.04(b)(1) and (2), except the 35 percent and 10 percent additives will not be permitted.
- (b) Extended Project Overhead. For the duration of the delay, payment for extended project overhead will be paid as follows.
 - (1) Direct Jobsite and Offsite Overhead. Payment for documented direct jobsite overhead and documented direct offsite overhead, including onsite supervisory and administrative personnel, will be allowed according to the following table.

Original Contract Amount	Supervisory and Administrative Personnel
Up to \$5,000,000	One Project Superintendent
Over \$ 5,000,000 - up to \$25,000,000	One Project Manager, One Project Superintendent or Engineer, and One Clerk
Over \$25,000,000 - up to \$50,000,000	One Project Manager, One Project Superintendent, One Engineer, and One Clerk
Over \$50,000,000	One Project Manager, Two Project Superintendents, One Engineer, and One Clerk

(2) Home Office and Unabsorbed Overhead. Payment for home office and unabsorbed overhead will be calculated as 8 percent of the total delay cost.

(c) Extended Traffic Control. Traffic control required for an extended period of time due to the delay will be paid for according to Article 109.04.

When an extended traffic control adjustment is paid under this provision, an adjusted unit price as provided for in Article 701.20(a) for increase or decrease in the value of work by more than ten percent will not be paid.

Upon payment for a contract delay under this provision, the Contractor shall assign subrogation rights to the Department for the Department's efforts of recovery from any other party for monies paid by the Department as a result of any claim under this provision. The Contractor shall fully cooperate with the Department in its efforts to recover from another party any money paid to the Contractor for delay damages under this provision."

CONSTRUCTION AIR QUALITY – DIESEL RETROFIT (BDE)

Effective: June 1, 2010

Revised: November 1, 2014

The reduction of emissions of particulate matter (PM) for off-road equipment shall be accomplished by installing retrofit emission control devices. The term "equipment" refers to diesel fuel powered devices rated at 50 hp and above, to be used on the jobsite in excess of seven calendar days over the course of the construction period on the jobsite (including rental equipment).

Contractor and subcontractor diesel powered off-road equipment assigned to the contract shall be retrofitted using the phased in approach shown below. Equipment that is of a model year older than the year given for that equipment's respective horsepower range shall be retrofitted:

Effective Dates	Horsepower Range	Model Year
June 1, 2010 ^{1/}	600-749	2002
	750 and up	2006
June 1, 2011 ^{2/}	100-299	2003
	300-599	2001
	600-749	2002
	750 and up	2006
June 1, 2012 ^{2/}	50-99	2004
	100-299	2003
	300-599	2001
	600-749	2002
	750 and up	2006

1/ Effective dates apply to Contractor diesel powered off-road equipment assigned to the contract.

2/ Effective dates apply to Contractor and subcontractor diesel powered off-road equipment assigned to the contract.

The retrofit emission control devices shall achieve a minimum PM emission reduction of 50 percent and shall be:

- a) Included on the U.S. Environmental Protection Agency (USEPA) *Verified Retrofit Technology List* (<http://www.epa.gov/cleandiesel/verification/verif-list.htm>), or verified by the California Air Resources Board (CARB) (<http://www.arb.ca.gov/diesel/verdev/vt/cvt.htm>); or
- b) Retrofitted with a non-verified diesel retrofit emission control device if verified retrofit emission control devices are not available for equipment proposed to be used on the project, and if the Contractor has obtained a performance certification from the retrofit device manufacturer that the emission control device provides a minimum PM emission reduction of 50 percent.

Note: Large cranes (Crawler mounted cranes) which are responsible for critical lift operations are exempt from installing retrofit emission control devices if such devices adversely affect equipment operation.

Diesel powered off-road equipment with engine ratings of 50 hp and above, which are unable to be retrofitted with verified emission control devices or if performance certifications are not available which will achieve a minimum 50 percent PM reduction, may be granted a waiver by the Department if documentation is provided showing good faith efforts were made by the Contractor to retrofit the equipment.

Construction shall not proceed until the Contractor submits a certified list of the diesel powered off-road equipment that will be used, and as necessary, retrofitted with emission control devices. The list(s) shall include (1) the equipment number, type, make, Contractor/rental company name; and (2) the emission control devices make, model, USEPA or CARB verification number, or performance certification from the retrofit device manufacturer. Equipment reported as fitted with emissions control devices shall be made available to the Engineer for visual inspection of the device installation, prior to being used on the jobsite.

The Contractor shall submit an updated list of retrofitted off-road construction equipment as retrofitted equipment changes or comes on to the jobsite. The addition or deletion of any diesel powered equipment shall be included on the updated list.

If any diesel powered off-road equipment is found to be in non-compliance with any portion of this special provision, the Engineer will issue the Contractor a diesel retrofit deficiency deduction.

Any costs associated with retrofitting any diesel powered off-road equipment with emission control devices shall be considered as included in the contract unit prices bid for the various items of work involved and no additional compensation will be allowed. The Contractor's compliance with this notice and any associated regulations shall not be grounds for a claim.

Diesel Retrofit Deficiency Deduction

When the Engineer determines that a diesel retrofit deficiency exists, a daily monetary deduction will be imposed for each calendar day or fraction thereof the deficiency continues to exist. The calendar day(s) will begin when the time period for correction is exceeded and end with the Engineer's written acceptance of the correction. The daily monetary deduction will be \$1,000.00 for each deficiency identified.

The deficiency will be based on lack of diesel retrofit emissions control.

If a Contractor accumulates three diesel retrofit deficiency deductions for the same piece of equipment in a contract period, the Contractor will be shutdown until the deficiency is corrected. Such a shutdown will not be grounds for any extension of the contract time, waiver of penalties, or be grounds for any claim.

DISADVANTAGED BUSINESS ENTERPRISE PARTICIPATION (DBE)

Effective: September 1, 2000

Revised: March 2, 2019

FEDERAL OBLIGATION. The Department of Transportation, as a recipient of federal financial assistance, is required to take all necessary and reasonable steps to ensure nondiscrimination in the award and administration of contracts. Consequently, the federal regulatory provisions of 49 CFR Part 26 apply to this contract concerning the utilization of disadvantaged business enterprises. For the purposes of this Special Provision, a disadvantaged business enterprise (DBE) means a business certified by the Department in accordance with the requirements of 49 CFR Part 26 and listed in the Illinois Unified Certification Program (IL UCP) DBE Directory.

STATE OBLIGATION. This Special Provision will also be used by the Department to satisfy the requirements of the Business Enterprise for Minorities, Females, and Persons with Disabilities Act, 30 ILCS 575. When this Special Provision is used to satisfy state law requirements on 100 percent state-funded contracts, the federal government has no involvement in such contracts (not a federal-aid contract) and no responsibility to oversee the implementation of this Special Provision by the Department on those contracts. DBE participation on 100 percent state-funded contracts will not be credited toward fulfilling the Department's annual overall DBE goal required by the US Department of Transportation to comply with the federal DBE program requirements.

CONTRACTOR ASSURANCE. The Contractor makes the following assurance and agrees to include the assurance in each subcontract the Contractor signs with a subcontractor.

The Contractor, subrecipient, or subcontractor shall not discriminate on the basis of race, color, national origin, or sex in the performance of this contract. The Contractor shall carry out applicable requirements of 49 CFR Part 26 in the award and administration of contracts funded in whole or in part with federal or state funds. Failure by the Contractor to carry out these requirements is a material breach of this contract, which may result in the termination of this contract or such other remedy as the recipient deems appropriate, which may include, but is not limited to:

- (a) Withholding progress payments;
- (b) Assessing sanctions;
- (c) Liquidated damages; and/or
- (d) Disqualifying the Contractor from future bidding as non-responsible.

OVERALL GOAL SET FOR THE DEPARTMENT. As a requirement of compliance with 49 CFR Part 26, the Department has set an overall goal for DBE participation in its federally assisted contracts. That goal applies to all federal-aid funds the Department will expend in its federally assisted contracts for the subject reporting fiscal year. The Department is required to make a good faith effort to achieve the overall goal. The dollar amount paid to all approved DBE companies performing work called for in this contract is eligible to be credited toward fulfillment of the Department's overall goal.

CONTRACT GOAL TO BE ACHIEVED BY THE CONTRACTOR. This contract includes a specific DBE utilization goal established by the Department. The goal has been included because the Department has determined the work of this contract has subcontracting opportunities that may be suitable for performance by DBE companies. The determination is based on an assessment of the type of work, the location of the work, and the availability of DBE companies to do a part of the work. The assessment indicates, in the absence of unlawful discrimination and in an arena of fair and open competition, DBE companies can be expected to perform **0.00%** of the work. This percentage is set as the DBE participation goal for this contract. Consequently, in addition to the other award criteria established for this contract, the Department will only award this contract to a bidder who makes a good faith effort to meet this goal of DBE participation in the performance of the work. A bidder makes a good faith effort for award consideration if either of the following is done in accordance with the procedures set for in this Special Provision:

- (a) The bidder documents enough DBE participation has been obtained to meet the goal or,
- (b) The bidder documents a good faith effort has been made to meet the goal, even though the effort did not succeed in obtaining enough DBE participation to meet the goal.

DBE LOCATOR REFERENCES. Bidders shall consult the IL UCP DBE Directory as a reference source for DBE-certified companies. In addition, the Department maintains a letting and item specific DBE locator information system whereby DBE companies can register their interest in providing quotes on particular bid items advertised for letting. Information concerning DBE companies willing to quote work for particular contracts may be obtained by contacting the Department's Bureau of Small Business Enterprises at telephone number (217) 785-4611, or by visiting the Department's website at:

<http://www.idot.illinois.gov/doing-business/certifications/disadvantaged-business-enterprise-certification/il-ucp-directory/index>.

BIDDING PROCEDURES. Compliance with this Special Provision is a material bidding requirement and failure of the bidder to comply will render the bid not responsive.

The bidder shall submit a DBE Utilization Plan (form SBE 2026), and a DBE Participation Statement (form SBE 2025) for each DBE company proposed for the performance of work to achieve the contract goal, with the bid. If the Utilization Plan indicates the contract goal will not be met, documentation of good faith efforts shall also be submitted. The documentation of good faith efforts must include copies of each DBE and non-DBE subcontractor quote submitted to the bidder when a non-DBE subcontractor is selected over a DBE for work on the contract. The required forms and documentation must be submitted as a single .pdf file using the "Integrated Contractor Exchange (iCX)" application within the Department's "EBids System".

The Department will not accept a Utilization Plan if it does not meet the bidding procedures set forth herein and the bid will be declared not responsive. In the event the bid is declared not responsive, the Department may elect to cause the forfeiture of the penal sum of the bidder's proposal guaranty and may deny authorization to bid the project if re-advertised for bids.

GOOD FAITH EFFORT PROCEDURES. The contract will not be awarded until the Utilization Plan is approved. All information submitted by the bidder must be complete, accurate and adequately document enough DBE participation has been obtained or document the good faith efforts of the bidder, in the event enough DBE participation has not been obtained, before the Department will commit to the performance of the contract by the bidder. The Utilization Plan will be approved by the Department if the Utilization Plan documents sufficient commercially useful DBE work to meet the contract goal or the bidder submits sufficient documentation of a good faith effort to meet the contract goal pursuant to 49 CFR Part 26, Appendix A. This means the bidder must show that all necessary and reasonable steps were taken to achieve the contract goal. Necessary and reasonable steps are those which, by their scope, intensity and appropriateness to the objective, could reasonably be expected to obtain sufficient DBE participation, even if they were not successful. The Department will consider the quality, quantity, and intensity of the kinds of efforts the bidder has made. Mere *pro forma* efforts, in other words efforts done as a matter of form, are not good faith efforts; rather, the bidder is expected to have taken genuine efforts that would be reasonably expected of a bidder actively and aggressively trying to obtain DBE participation sufficient to meet the contract goal.

(a) The following is a list of types of action that the Department will consider as part of the evaluation of the bidder's good faith efforts to obtain participation. These listed factors are not intended to be a mandatory checklist and are not intended to be exhaustive. Other factors or efforts brought to the attention of the Department may be relevant in appropriate cases and will be considered by the Department.

(1) Soliciting through all reasonable and available means (e.g. attendance at pre-bid meetings, advertising and/or written notices) the interest of all certified DBE companies that have the capability to perform the work of the contract. The bidder must solicit this interest within sufficient time to allow the DBE companies to respond to the solicitation. The bidder must determine with certainty if the DBE companies are interested by taking appropriate steps to follow up initial solicitations.

- (2) Selecting portions of the work to be performed by DBE companies in order to increase the likelihood that the DBE goals will be achieved. This includes, where appropriate, breaking out contract work items into economically feasible units to facilitate DBE participation, even when the Contractor might otherwise prefer to perform these work items with its own forces.
- (3) Providing interested DBE companies with adequate information about the plans, specifications, and requirements of the contract in a timely manner to assist them in responding to a solicitation.
- (4) a. Negotiating in good faith with interested DBE companies. It is the bidder's responsibility to make a portion of the work available to DBE subcontractors and suppliers and to select those portions of the work or material needs consistent with the available DBE subcontractors and suppliers, so as to facilitate DBE participation. Evidence of such negotiation includes the names, addresses, and telephone numbers of DBE companies that were considered; a description of the information provided regarding the plans and specifications for the work selected for subcontracting; and evidence as to why additional agreements could not be reached for DBE companies to perform the work.

b. A bidder using good business judgment would consider a number of factors in negotiating with subcontractors, including DBE subcontractors, and would take a firm's price and capabilities as well as contract goals into consideration. However, the fact that there may be some additional costs involved in finding and using DBE companies is not in itself sufficient reason for a bidder's failure to meet the contract DBE goal, as long as such costs are reasonable. Also the ability or desire of a bidder to perform the work of a contract with its own organization does not relieve the bidder of the responsibility to make good faith efforts. Bidders are not, however, required to accept higher quotes from DBE companies if the price difference is excessive or unreasonable. In accordance with the above Bidding Procedures, the documentation of good faith efforts must include copies of each DBE and non-DBE subcontractor quote submitted to the bidder when a non-DBE subcontractor was selected over a DBE for work on the contract.
- (5) Not rejecting DBE companies as being unqualified without sound reasons based on a thorough investigation of their capabilities. The bidder's standing within its industry, membership in specific groups, organizations, or associations and political or social affiliations (for example union vs. non-union employee status) are not legitimate causes for the rejection or non-solicitation of bids in the bidder's efforts to meet the project goal.
- (6) Making efforts to assist interested DBE companies in obtaining bonding, lines of credit, or insurance as required by the recipient or Contractor.

- (7) Making efforts to assist interested DBE companies in obtaining necessary equipment, supplies, materials, or related assistance or services.
- (8) Effectively using the services of available minority/women community organizations; minority/women contractors' groups; local, state, and federal minority/women business assistance offices; and other organizations as allowed on a case-by-case basis to provide assistance in the recruitment and placement of DBE companies.
- (b) If the Department determines the bidder has made a good faith effort to secure the work commitment of DBE companies to meet the contract goal, the Department will award the contract provided it is otherwise eligible for award. If the Department determines the bidder has failed to meet the requirements of this Special Provision or that a good faith effort has not been made, the Department will notify the responsible company official designated in the Utilization Plan that the bid is not responsive. The notification will also include a statement of reasons for the adverse determination. If the Utilization Plan is not approved because it is deficient as a technical matter, unless waived by the Department, the bidder will be notified and will be allowed no more than a five calendar day period to cure the deficiency.
- (c) The bidder may request administrative reconsideration of an adverse determination by emailing the Department at "DOT.DBE.UP@illinois.gov" within the five calendar days after the receipt of the notification of the determination. The determination shall become final if a request is not made on or before the fifth calendar day. A request may provide additional written documentation or argument concerning the issues raised in the determination statement of reasons, provided the documentation and arguments address efforts made prior to submitting the bid. The request will be reviewed by the Department's Reconsideration Officer. The Reconsideration Officer will extend an opportunity to the bidder to meet in person to consider all issues of documentation and whether the bidder made a good faith effort to meet the goal. After the review by the Reconsideration Officer, the bidder will be sent a written decision within ten working days after receipt of the request for reconsideration, explaining the basis for finding that the bidder did or did not meet the goal or make adequate good faith efforts to do so. A final decision by the Reconsideration Officer that a good faith effort was made shall approve the Utilization Plan submitted by the bidder and shall clear the contract for award. A final decision that a good faith effort was not made shall render the bid not responsive.

CALCULATING DBE PARTICIPATION. The Utilization Plan values represent work anticipated to be performed and paid for upon satisfactory completion. The Department is only able to count toward the achievement of the overall goal and the contract goal the value of payments made for the work actually performed by DBE companies. In addition, a DBE must perform a commercially useful function on the contract to be counted. A commercially useful function is generally performed when the DBE is responsible for the work and is carrying out its responsibilities by actually performing, managing, and supervising the work involved. The Department and Contractor are governed by the provisions of 49 CFR Part 26.55(c) on questions of commercially useful functions as it affects the work. Specific counting guidelines are provided in 49 CFR Part 26.55, the provisions of which govern over the summary contained herein.

- (a) DBE as the Contractor: 100 percent goal credit for that portion of the work performed by the DBE's own forces, including the cost of materials and supplies. Work that a DBE subcontracts to a non-DBE does not count toward the DBE goals.
- (b) DBE as a joint venture Contractor: 100 percent goal credit for that portion of the total dollar value of the contract equal to the distinct, clearly defined portion of the work performed by the DBE's own forces.
- (c) DBE as a subcontractor: 100 percent goal credit for the work of the subcontract performed by the DBE's own forces, including the cost of materials and supplies, excluding the purchase of materials and supplies or the lease of equipment by the DBE subcontractor from the Contractor or its affiliates. Work that a DBE subcontractor in turn subcontracts to a non-DBE does not count toward the DBE goal.
- (d) DBE as a trucker: 100 percent goal credit for trucking participation provided the DBE is responsible for the management and supervision of the entire trucking operation for which it is responsible. At least one truck owned, operated, licensed, and insured by the DBE must be used on the contract. Credit will be given for the following:
 - (1) The DBE may lease trucks from another DBE firm, including an owner-operator who is certified as a DBE. The DBE who leases trucks from another DBE receives credit for the total value of the transportation services the lessee DBE provides on the contract.
 - (2) The DBE may also lease trucks from a non-DBE firm, including from an owner-operator. The DBE who leases trucks from a non-DBE is entitled to credit only for the fee or commission is receives as a result of the lease arrangement.
- (e) DBE as a material supplier:
 - (1) 60 percent goal credit for the cost of the materials or supplies purchased from a DBE regular dealer.
 - (2) 100 percent goal credit for the cost of materials of supplies obtained from a DBE manufacturer.
 - (3) 100 percent credit for the value of reasonable fees and commissions for the procurement of materials and supplies if not a DBE regular dealer or DBE manufacturer.

CONTRACT COMPLIANCE. Compliance with this Special Provision is an essential part of the contract. The Department is prohibited by federal regulations from crediting the participation of a DBE included in the Utilization Plan toward either the contract goal or the Department's overall goal until the amount to be applied toward the goals has been paid to the DBE. The following administrative procedures and remedies govern the compliance by the Contractor with the contractual obligations established by the Utilization Plan. After approval of the Utilization Plan and award of the contract, the Utilization Plan and individual DBE Participation Statements become part of the contract. If the Contractor did not succeed in obtaining enough DBE participation to achieve the advertised contract goal, and the Utilization Plan was approved and contract awarded based upon a determination of good faith, the total dollar value of DBE work calculated in the approved Utilization Plan as a percentage of the awarded contract value shall become the amended contract goal. All work indicated for performance by an approved DBE shall be performed, managed, and supervised by the DBE executing the DBE Participation Commitment Statement.

- (a) NO AMENDMENT. No amendment to the Utilization Plan may be made without prior written approval from the Department's Bureau of Small Business Enterprises. All requests for amendment to the Utilization Plan shall be emailed to the Department at DOT.DBE.UP@illinois.gov.
- (b) CHANGES TO WORK. Any deviation from the DBE condition-of-award or contract plans, specifications, or special provisions must be approved, in writing, by the Department as provided elsewhere in the Contract. The Contractor shall notify affected DBEs in writing of any changes in the scope of work which result in a reduction in the dollar amount condition-of-award to the contract. Where the revision includes work committed to a new DBE subcontractor, not previously involved in the project, then a Request for Approval of Subcontractor, Department form BC 260A or AER 260A, must be signed and submitted. If the commitment of work is in the form of additional tasks assigned to an existing subcontract, a new Request for Approval of Subcontractor will not be required. However, the Contractor must document efforts to assure the existing DBE subcontractor is capable of performing the additional work and has agreed in writing to the change.
- (c) SUBCONTRACT. The Contractor must provide copies of DBE subcontracts to the Department upon request. Subcontractors shall ensure that all lower tier subcontracts or agreements with DBEs to supply labor or materials be performed in accordance with this Special Provision.
- (d) ALTERNATIVE WORK METHODS. In addition to the above requirements for reductions in the condition of award, additional requirements apply to the two cases of Contractor-initiated work substitution proposals. Where the contract allows alternate work methods which serve to delete or create underruns in condition of award DBE work, and the Contractor selects that alternate method or, where the Contractor proposes a substitute work method or material that serves to diminish or delete work committed to a DBE and replace it with other work, then the Contractor must demonstrate one of the following:

- (1) The replacement work will be performed by the same DBE (as long as the DBE is certified in the respective item of work) in a modification of the condition of award; or
 - (2) The DBE is aware its work will be deleted or will experience underruns and has agreed in writing to the change. If this occurs, the Contractor shall substitute other work of equivalent value to a certified DBE or provide documentation of good faith efforts to do so; or
 - (3) The DBE is not capable of performing the replacement work or has declined to perform the work at a reasonable competitive price. If this occurs, the Contractor shall substitute other work of equivalent value to a certified DBE or provide documentation of good faith efforts to do so.
- (e) TERMINATION AND REPLACEMENT PROCEDURES. The Contractor shall not terminate or replace a DBE listed on the approved Utilization Plan, or perform with other forces work designated for a listed DBE except as provided in this Special Provision. The Contractor shall utilize the specific DBEs listed to perform the work and supply the materials for which each is listed unless the Contractor obtains the Department's written consent as provided in subsection (a) of this part. Unless Department consent is provided for termination of a DBE subcontractor, the Contractor shall not be entitled to any payment for work or material unless it is performed or supplied by the DBE in the Utilization Plan.

As stated above, the Contractor shall not terminate or replace a DBE subcontractor listed in the approved Utilization Plan without prior written consent. This includes, but is not limited to, instances in which the Contractor seeks to perform work originally designated for a DBE subcontractor with its own forces or those of an affiliate, a non-DBE firm, or with another DBE firm. Written consent will be granted only if the Bureau of Small Business Enterprises agrees, for reasons stated in its concurrence document, that the Contractor has good cause to terminate or replace the DBE firm. Before transmitting to the Bureau of Small Business Enterprises any request to terminate and/or substitute a DBE subcontractor, the Contractor shall give notice in writing to the DBE subcontractor, with a copy to the Bureau, of its intent to request to terminate and/or substitute, and the reason for the request. The Contractor shall give the DBE five days to respond to the Contractor's notice. The DBE so notified shall advise the Bureau and the Contractor of the reasons, if any, why it objects to the proposed termination of its subcontract and why the Bureau should not approve the Contractor's action. If required in a particular case as a matter of public necessity, the Bureau may provide a response period shorter than five days.

For purposes of this paragraph, good cause includes the following circumstances:

- (1) The listed DBE subcontractor fails or refuses to execute a written contract;

- (2) The listed DBE subcontractor fails or refuses to perform the work of its subcontract in a way consistent with normal industry standards. Provided, however, that good cause does not exist if the failure or refusal of the DBE subcontractor to perform its work on the subcontract results from the bad faith or discriminatory action of the Contractor;
- (3) The listed DBE subcontractor fails or refuses to meet the Contractor's reasonable, nondiscriminatory bond requirements;
- (4) The listed DBE subcontractor becomes bankrupt, insolvent, or exhibits credit unworthiness;
- (5) The listed DBE subcontractor is ineligible to work on public works projects because of suspension and debarment proceedings pursuant 2 CFR Parts 180, 215 and 1200 or applicable state law.
- (6) The Contractor has determined the listed DBE subcontractor is not a responsible contractor;
- (7) The listed DBE subcontractor voluntarily withdraws from the projects and provides written notice to the Contractor of its withdrawal;
- (8) The listed DBE is ineligible to receive DBE credit for the type of work required;
- (9) A DBE owner dies or becomes disabled with the result that the listed DBE subcontractor is unable to complete its work on the contract;
- (10) Other documented good cause that compels the termination of the DBE subcontractor. Provided, that good cause does not exist if the Contractor seeks to terminate a DBE it relied upon to obtain the contract so that the Contractor can self-perform the work for which the DBE contractor was engaged or so that the Contractor can substitute another DBE or non-DBE contractor after contract award.

When a DBE is terminated or fails to complete its work on the Contract for any reason, the Contractor shall make a good faith effort to find another DBE to substitute for the original DBE to perform at least the same amount of work under the contract as the terminated DBE to the extent needed to meet the established Contract goal. The good faith efforts shall be documented by the Contractor. If the Department requests documentation under this provision, the Contractor shall submit the documentation within seven days, which may be extended for an additional seven days if necessary at the request of the Contractor. The Department will provide a written determination to the Contractor stating whether or not good faith efforts have been demonstrated.

- (f) FINAL PAYMENT. After the performance of the final item of work or delivery of material by a DBE and final payment therefore to the DBE by the Contractor, but not later than 30 calendar days after payment has been made by the Department to the Contractor for such work or material, the Contractor shall submit a DBE Payment Agreement on Department form SBE 2115 to the Resident Engineer. If full and final payment has not been made to the DBE, the DBE Payment Agreement shall indicate whether a disagreement as to the payment required exists between the Contractor and the DBE or if the Contractor believes the work has not been satisfactorily completed. If the Contractor does not have the full amount of work indicated in the Utilization Plan performed by the DBE companies indicated in the Utilization Plan and after good faith efforts are reviewed, the Department may deduct from contract payments to the Contractor the amount of the goal not achieved as liquidated and ascertained damages. The Contractor may request an administrative reconsideration of any amount deducted as damages pursuant to subsection (h) of this part.
- (g) ENFORCEMENT. The Department reserves the right to withhold payment to the Contractor to enforce the provisions of this Special Provision. Final payment shall not be made on the contract until such time as the Contractor submits sufficient documentation demonstrating achievement of the goal in accordance with this Special Provision or after liquidated damages have been determined and collected.
- (h) RECONSIDERATION. Notwithstanding any other provision of the contract, including but not limited to Article 109.09 of the Standard Specifications, the Contractor may request administrative reconsideration of a decision to deduct the amount of the goal not achieved as liquidated damages. A request to reconsider shall be delivered to the Contract Compliance Section and shall be handled and considered in the same manner as set forth in paragraph (c) of "Good Faith Effort Procedures" of this Special Provision, except a final decision that a good faith effort was not made during contract performance to achieve the goal agreed to in the Utilization Plan shall be the final administrative decision of the Department. The result of the reconsideration process is not administratively appealable to the U.S. Department of Transportation.

SEEDING (BDE)

Effective: November 1, 2022

Revise Article 250.07 of the Standard Specifications to read:

"250.07 Seeding Mixtures. The classes of seeding mixtures and combinations of mixtures will be designated in the plans.

When an area is to be seeded with two or more seeding classes, those mixtures shall be applied separately on the designated area within a seven day period. Seeding shall occur prior to placement of mulch cover. A Class 7 mixture can be applied at any time prior to applying any seeding class or added to them and applied at the same time.

TABLE 1 - SEEDING MIXTURES		
Class - Type	Seeds	lb/acre (kg/hectare)
1 Lawn Mixture 1/	Kentucky Bluegrass	100 (110)
	Perennial Ryegrass	60 (70)
	<i>Festuca rubra</i> ssp. <i>rubra</i> (Creeping Red Fescue)	40 (50)
1A Salt Tolerant Lawn Mixture 1/	Kentucky Bluegrass	60 (70)
	Perennial Ryegrass	20 (20)
	<i>Festuca rubra</i> ssp. <i>rubra</i> (Creeping Red Fescue)	20 (20)
	<i>Festuca brevipilla</i> (Hard Fescue)	20 (20)
	<i>Puccinellia distans</i> (Fulfs Saltgrass or Salty Alkaligrass)	60 (70)
1B Low Maintenance Lawn Mixture 1/	Turf-Type Fine Fescue 3/	150 (170)
	Perennial Ryegrass	20 (20)
	Red Top	10 (10)
	<i>Festuca rubra</i> ssp. <i>rubra</i> (Creeping Red Fescue)	20 (20)
2 Roadside Mixture 1/	<i>Lolium arundinaceum</i> (Tall Fescue)	100 (110)
	Perennial Ryegrass	50 (55)
	<i>Festuca rubra</i> ssp. <i>rubra</i> (Creeping Red Fescue)	40 (50)
	Red Top	10 (10)
2A Salt Tolerant Roadside Mixture 1/	<i>Lolium arundinaceum</i> (Tall Fescue)	60 (70)
	Perennial Ryegrass	20 (20)
	<i>Festuca rubra</i> ssp. <i>rubra</i> (Creeping Red Fescue)	30 (20)
	<i>Festuca brevipilla</i> (Hard Fescue)	30 (20)
	<i>Puccinellia distans</i> (Fulfs Saltgrass or Salty Alkaligrass)	60 (70)
3 Northern Illinois Slope Mixture 1/	<i>Elymus canadensis</i> (Canada Wild Rye) 5/	5 (5)
	Perennial Ryegrass	20 (20)
	Alsike Clover 4/	5 (5)
	<i>Desmanthus illinoensis</i> (Illinois Bundleflower) 4/ 5/	2 (2)
	<i>Schizachyrium scoparium</i> (Little Bluestem) 5/	12 (12)
	<i>Bouteloua curtipendula</i> (Side-Oats Grama) 5/	10 (10)
	<i>Puccinellia distans</i> (Fulfs Saltgrass or Salty Alkaligrass)	30 (35)
	Oats, Spring	50 (55)
	Slender Wheat Grass 5/	15 (15)
	Buffalo Grass 5/ 7/	5 (5)
	3A Southern Illinois Slope Mixture 1/	Perennial Ryegrass
<i>Elymus canadensis</i> (Canada Wild Rye) 5/		20 (20)
<i>Panicum virgatum</i> (Switchgrass) 5/		10 (10)
<i>Schizachyrium scoparium</i> (Little Blue Stem) 5/		12 (12)
<i>Bouteloua curtipendula</i> (Side-Oats Grama) 5/		10 (10)
<i>Dalea candida</i> (White Prairie Clover) 4/ 5/		5 (5)
<i>Rudbeckia hirta</i> (Black-Eyed Susan) 5/		5 (5)
Oats, Spring		50 (55)

Class – Type	Seeds	lb/acre (kg/hectare)
4 Native Grass 2/ 6/	<i>Andropogon gerardi</i> (Big Blue Stem) 5/	4 (4)
	<i>Schizachyrium scoparium</i> (Little Blue Stem) 5/	5 (5)
	<i>Bouteloua curtipendula</i> (Side-Oats Grama) 5/	5 (5)
	<i>Elymus canadensis</i> (Canada Wild Rye) 5/	1 (1)
	<i>Panicum virgatum</i> (Switch Grass) 5/	1 (1)
	<i>Sorghastrum nutans</i> (Indian Grass) 5/	2 (2)
	Annual Ryegrass	25 (25)
	Oats, Spring	25 (25)
	Perennial Ryegrass	15 (15)
	4A Low Profile Native Grass 2/ 6/	<i>Schizachyrium scoparium</i> (Little Blue Stem) 5/
<i>Bouteloua curtipendula</i> (Side-Oats Grama) 5/		5 (5)
<i>Elymus canadensis</i> (Canada Wild Rye) 5/		1 (1)
<i>Sporobolus heterolepis</i> (Prairie Dropseed) 5/		0.5 (0.5)
Annual Ryegrass		25 (25)
Oats, Spring		25 (25)
Perennial Ryegrass		15 (15)
4B Wetland Grass and Sedge Mixture 2/ 6/		Annual Ryegrass
	Oats, Spring	25 (25)
	Wetland Grasses (species below) 5/	6 (6)
<u>Species:</u>	<u>% By Weight</u>	
<i>Calamagrostis canadensis</i> (Blue Joint Grass)	12	
<i>Carex lacustris</i> (Lake-Bank Sedge)	6	
<i>Carex slipata</i> (Awl-Fruited Sedge)	6	
<i>Carex stricta</i> (Tussock Sedge)	6	
<i>Carex vulpinoidea</i> (Fox Sedge)	6	
<i>Eleocharis acicularis</i> (Needle Spike Rush)	3	
<i>Eleocharis obtusa</i> (Blunt Spike Rush)	3	
<i>Glyceria striata</i> (Fowl Manna Grass)	14	
<i>Juncus effusus</i> (Common Rush)	6	
<i>Juncus tenuis</i> (Slender Rush)	6	
<i>Juncus torreyi</i> (Torrey's Rush)	6	
<i>Leersia oryzoides</i> (Rice Cut Grass)	10	
<i>Scirpus acutus</i> (Hard-Stemmed Bulrush)	3	
<i>Scirpus atrovirens</i> (Dark Green Rush)	3	
<i>Bolboschoenus fluviatilis</i> (River Bulrush)	3	
<i>Schoenoplectus tabernaemontani</i> (Softstem Bulrush)	3	
<i>Spartina pectinata</i> (Cord Grass)	4	

Class – Type	Seeds	lb/acre (kg/hectare)
5	Forb with Annuals Mixture 2/ 5/ 6/	1 (1) 10 (10)
	Annuals Mixture - Mixture not exceeding 25 % by weight of any one species, of the following:	
	<i>Coreopsis lanceolata</i> (Sand Coreopsis)	
	<i>Leucanthemum maximum</i> (Shasta Daisy)	
	<i>Gaillardia pulchella</i> (Blanket Flower)	
	<i>Ratibida columnifera</i> (Prairie Coneflower)	
	<i>Rudbeckia hirta</i> (Black-Eyed Susan)	
	Forb Mixture - Mixture not exceeding 5 % by weight PLS of any one species, of the following:	
	<i>Amorpha canescens</i> (Lead Plant) 4/	
	<i>Anemone cylindrica</i> (Thimble Weed)	
	<i>Asclepias tuberosa</i> (Butterfly Weed)	
	<i>Aster azureus</i> (Sky Blue Aster)	
	<i>Symphotrichum leave</i> (Smooth Aster)	
	<i>Aster novae-angliae</i> (New England Aster)	
	<i>Baptisia leucantha</i> (White Wild Indigo) 4/	
	<i>Coreopsis palmata</i> (Prairie Coreopsis)	
	<i>Echinacea pallida</i> (Pale Purple Coneflower)	
	<i>Eryngium yuccifolium</i> (Rattlesnake Master)	
	<i>Helianthus mollis</i> (Downy Sunflower)	
	<i>Heliopsis helianthoides</i> (Ox-Eye)	
	<i>Liatris aspera</i> (Rough Blazing Star)	
	<i>Liatris pycnostachya</i> (Prairie Blazing Star)	
	<i>Monarda fistulosa</i> (Prairie Bergamot)	
	<i>Parthenium integrifolium</i> (Wild Quinine)	
	<i>Dalea candida</i> (White Prairie Clover) 4/	
	<i>Dalea purpurea</i> (Purple Prairie Clover) 4/	
	<i>Physostegia virginiana</i> (False Dragonhead)	
	<i>Potentilla arguta</i> (Prairie Cinquefoil)	
	<i>Ratibida pinnata</i> (Yellow Coneflower)	
	<i>Rudbeckia subtomentosa</i> (Fragrant Coneflower)	
	<i>Silphium laciniatum</i> (Compass Plant)	
	<i>Silphium terebinthinaceum</i> (Prairie Dock)	
	<i>Oligoneuron rigidum</i> (Rigid Goldenrod)	
	<i>Tradescantia ohiensis</i> (Spiderwort)	
	<i>Veronicastrum virginicum</i> (Culver's Root)	

Class – Type	Seeds	lb/acre (kg/hectare)
5A Large Flower Native Forb Mixture 2/ 5/ 6/	Forb Mixture (see below)	5 (5)
	<u>Species:</u>	<u>% By Weight</u>
	<i>Aster novae-angliae</i> (New England Aster)	5
	<i>Echinacea pallida</i> (Pale Purple Coneflower)	10
	<i>Helianthus mollis</i> (Downy Sunflower)	10
	<i>Heliopsis helianthoides</i> (Ox-Eye)	10
	<i>Liatris pycnostachya</i> (Prairie Blazing Star)	10
	<i>Ratibida pinnata</i> (Yellow Coneflower)	5
	<i>Rudbeckia hirta</i> (Black-Eyed Susan)	10
	<i>Silphium laciniatum</i> (Compass Plant)	10
	<i>Silphium terebinthinaceum</i> (Prairie Dock)	20
	<i>Oligoneuron rigidum</i> (Rigid Goldenrod)	10
5B Wetland Forb 2/ 5/ 6/	Forb Mixture (see below)	2 (2)
	<u>Species:</u>	<u>% By Weight</u>
	<i>Acorus calamus</i> (Sweet Flag)	3
	<i>Angelica atropurpurea</i> (Angelica)	6
	<i>Asclepias incarnata</i> (Swamp Milkweed)	2
	<i>Aster puniceus</i> (Purple Stemmed Aster)	10
	<i>Bidens cernua</i> (Beggarticks)	7
	<i>Eutrochium maculatum</i> (Spotted Joe Pye Weed)	7
	<i>Eupatorium perfoliatum</i> (Boneset)	7
	<i>Helenium autumnale</i> (Autumn Sneezeweed)	2
	<i>Iris virginica shrevei</i> (Blue Flag Iris)	2
	<i>Lobelia cardinalis</i> (Cardinal Flower)	5
	<i>Lobelia siphilitica</i> (Great Blue Lobelia)	5
	<i>Lythrum alatum</i> (Winged Loosestrife)	2
	<i>Physostegia virginiana</i> (False Dragonhead)	5
	<i>Persicaria pensylvanica</i> (Pennsylvania Smartweed)	10
	<i>Persicaria lapathifolia</i> (Curlytop Knotweed)	10
	<i>Pycnanthemum virginianum</i> (Mountain Mint)	5
	<i>Rudbeckia laciniata</i> (Cut-leaf Coneflower)	5
	<i>Oligoneuron riddellii</i> (Riddell Goldenrod)	2
	<i>Sparganium eurycarpum</i> (Giant Burreed)	5
6 Conservation Mixture 2/ 6/	<i>Schizachyrium scoparium</i> (Little Blue Stem) 5/ <i>Elymus canadensis</i> (Canada Wild Rye) 5/ Buffalo Grass 5/ 7/ Vernal Alfalfa 4/ Oats, Spring	5 (5) 2 (2) 5 (5) 15 (15) 48 (55)
6A Salt Tolerant Conservation Mixture 2/ 6/	<i>Schizachyrium scoparium</i> (Little Blue Stem) 5/ <i>Elymus canadensis</i> (Canada Wild Rye) 5/ Buffalo Grass 5/ 7/ Vernal Alfalfa 4/ Oats, Spring <i>Puccinellia distans</i> (Fults Saltgrass or Salty Alkaligrass)	5 (5) 2 (2) 5 (5) 15 (15) 48 (55) 20 (20)
7 Temporary Turf Cover Mixture	Perennial Ryegrass Oats, Spring	50 (55) 64 (70)

Notes:

- 1/ Seeding shall be performed when the ambient temperature has been between 45 °F (7 °C) and 80 °F (27 °C) for a minimum of seven (7) consecutive days and is forecasted to be the same for the next five (5) days according to the National Weather Service.
- 2/ Seeding shall be performed in late fall through spring beginning when the ambient temperature has been below 45 °F (7 °C) for a minimum of seven (7) consecutive days and ending when the ambient temperature exceeds 80 °F (27 °C) according to the National Weather Service.
- 3/ Specific variety as shown in the plans or approved by the Engineer.
- 4/ Inoculation required.
- 5/ Pure Live Seed (PLS) shall be used.
- 6/ Fertilizer shall not be used.
- 7/ Seed shall be primed with KNO₃ to break dormancy and dyed to indicate such.

Seeding will be inspected after a period of establishment. The period of establishment shall be six (6) months minimum, but not to exceed nine (9) months. After the period of establishment, areas not exhibiting 75 percent uniform growth shall be interseeded or reseeded, as determined by the Engineer, at no additional cost to the Department.”

SOURCE OF SUPPLY AND QUALITY REQUIREMENTS (BDE)

Effective: January 2, 2023

Add the following to Article 106.01 of the Standard Specifications:

“The final manufacturing process for construction materials and the immediately preceding manufacturing stage for construction materials shall occur within the United States. Construction materials shall include an article, material, or supply that is or consists primarily of the following.

- (a) Non-ferrous metals;
- (b) Plastic and polymer-based products (including polyvinylchloride, composite building materials, and polymers used in fiber optic cables);
- (c) Glass (including optic glass);
- (d) Lumber;
- (e) Drywall.

Items consisting of two or more of the listed construction materials that have been combined through a manufacturing process, and items including at least one of the listed materials combined with a material that is not listed through a manufacturing process shall be exempt.”

SUBCONTRACTOR AND DBE PAYMENT REPORTING (BDE)

Effective: April 2, 2018

Add the following to Section 109 of the Standard Specifications.

“109.14 Subcontractor and Disadvantaged Business Enterprise Payment Reporting.
 The Contractor shall report all payments made to the following parties:

- (a) first tier subcontractors;
- (b) lower tier subcontractors affecting disadvantaged business enterprise (DBE) goal credit;
- (c) material suppliers or trucking firms that are part of the Contractor’s submitted DBE utilization plan.

The report shall be made through the Department’s on-line subcontractor payment reporting system within 21 days of making the payment.”

SUBCONTRACTOR MOBILIZATION PAYMENTS (BDE)

Effective: November 2, 2017

Revised: April 1, 2019

Replace the second paragraph of Article 109.12 of the Standard Specifications with the following:

“This mobilization payment shall be made at least seven days prior to the subcontractor starting work. The amount paid shall be at the following percentage of the amount of the subcontract reported on form BC 260A submitted for the approval of the subcontractor’s work.

Value of Subcontract Reported on Form BC 260A	Mobilization Percentage
Less than \$10,000	25%
\$10,000 to less than \$20,000	20%
\$20,000 to less than \$40,000	18%
\$40,000 to less than \$60,000	16%
\$60,000 to less than \$80,000	14%
\$80,000 to less than \$100,000	12%
\$100,000 to less than \$250,000	10%
\$250,000 to less than \$500,000	9%
\$500,000 to \$750,000	8%
Over \$750,000	7%”

SUBMISSION OF PAYROLL RECORDS (BDE)

Effective: April 1, 2021

Revised: November 1, 2022

FEDERAL AID CONTRACTS. Revise the following section of Check Sheet #1 of the Recurring Special Provisions to read:

“STATEMENTS AND PAYROLLS

The payroll records shall include the worker’s name, the worker’s address, the worker’s telephone number when available, the worker’s social security number, the worker’s classification or classifications, the worker’s gross and net wages paid in each pay period, the worker’s number of hours worked each day, and the worker’s starting and ending times of work each day. However, any Contractor or subcontractor who remits contributions to a fringe benefit fund that is not jointly maintained and jointly governed by one or more employers and one or more labor organization must additionally submit the worker’s hourly wage rate, the worker’s hourly overtime wage rate, the worker’s hourly fringe benefit rates, the name and address of each fringe benefit fund, the plan sponsor of each fringe benefit, if applicable, and the plan administrator of each fringe benefit, if applicable.

The Contractor and each subcontractor shall certify and submit payroll records to the Department each week from the start to the completion of their respective work, except that full social security numbers shall not be included on weekly submittals. Instead, the payrolls shall include an identification number for each employee (e.g., the last four digits of the employee’s social security number). In addition, starting and ending times of work each day may be omitted from the payroll records submitted. The submittals shall be made using LCPTracker Pro software. The software is web-based and can be accessed at <https://lcptracker.com/>. When there has been no activity during a work week, a payroll record shall still be submitted with the appropriate option (“No Work”, “Suspended”, or “Complete”) selected.”

STATE CONTRACTS. Revise Item 3 of Section IV of Check Sheet #5 of the Recurring Special Provisions to read:

- “3. Submission of Payroll Records. The Contractor and each subcontractor shall, no later than the 15th day of each calendar month, file a certified payroll for the immediately preceding month to the Illinois Department of Labor (IDOL) through the Illinois Prevailing Wage Portal in compliance with the State Prevailing Wage Act (820 ILCS 130). The portal can be found on the IDOL website at <https://www2.illinois.gov/idol/Laws-Rules/CONMED/Pages/Prevailing-Wage-Portal.aspx>. Payrolls shall be submitted in the format prescribed by the IDOL.

In addition to filing certified payroll(s) with the IDOL, the Contractor and each subcontractor shall certify and submit payroll records to the Department each week from the start to the completion of their respective work, except that full social security numbers shall not be included on weekly submittals. Instead, the payrolls shall include an identification number for each employee (e.g., the last four digits of the employee's social security number). In addition, starting and ending times of work each day may be omitted from the payroll records submitted. The submittals shall be made using LCPtracker Pro software. The software is web-based and can be accessed at <https://lcptracker.com/>. When there has been no activity during a work week, a payroll record shall still be submitted with the appropriate option ("No Work", "Suspended", or "Complete") selected."

TRAINING SPECIAL PROVISIONS (BDE)

Effective: October 15, 1975

Revised: September 2, 2021

This Training Special Provision supersedes Section 7b of the Special Provision entitled "Specific Equal Employment Opportunity Responsibilities," and is in implementation of 23 U.S.C. 140(a).

As part of the Contractor's equal employment opportunity affirmative action program, training shall be provided as follows:

The Contractor shall provide on-the-job training aimed at developing full journeyman in the type of trade or job classification involved. The number of trainees to be trained under this contract will be 1. In the event the Contractor subcontracts a portion of the contract work, it shall determine how many, if any, of the trainees are to be trained by the subcontractor, provided however, that the Contractor shall retain the primary responsibility for meeting the training requirements imposed by this special provision. The Contractor shall also ensure that this Training Special Provision is made applicable to such subcontract. Where feasible, 25 percent of apprentices or trainees in each occupation shall be in their first year of apprenticeship or training.

The number of trainees shall be distributed among the work classifications on the basis of the Contractor's needs and the availability of journeymen in the various classifications within the reasonable area of recruitment. Prior to commencing construction, the Contractor shall submit to the Illinois Department of Transportation for approval the number of trainees to be trained in each selected classification and training program to be used. Furthermore, the Contractor shall specify the starting time for training in each of the classifications. The Contractor will be credited for each trainee it employs on the contract work who is currently enrolled or becomes enrolled in an approved program and will be reimbursed for such trainees as provided hereinafter.

Training and upgrading of minorities and women toward journeyman status is a primary objective of this Training Special Provision. Accordingly, the Contractor shall make every effort to enroll minority trainees and women (e.g. by conducting systematic and direct recruitment through public and private sources likely to yield minority and women trainees) to the extent such persons are available within a reasonable area of recruitment. The Contractor will be responsible for demonstrating the steps it has taken in pursuance thereof, prior to a determination as to whether the Contractor is in compliance with this Training Special Provision. This training commitment is not intended, and shall not be used, to discriminate against any applicant for training, whether a member of a minority group or not.

No employee shall be employed as a trainee in any classification in which he or she has successfully completed a training course leading to journeyman status or in which he or she has been employed as a journeyman. The Contractor should satisfy this requirement by including appropriate questions in the employee application or by other suitable means. Regardless of the method used, the Contractor's records should document the findings in each case.

The minimum length and type of training for each classification will be as established in the training program selected by the Contractor and approved by the Illinois Department of Transportation and the Federal Highway Administration. The Illinois Department of Transportation and the Federal Highway Administration shall approve a program, if it is reasonably calculated to meet the equal employment opportunity obligations of the Contractor and to qualify the average trainee for journeyman status in the classification concerned by the end of the training period. Furthermore, apprenticeship programs registered with the U.S. Department of Labor, Bureau of Apprenticeship and Training, or with a State apprenticeship agency recognized by the Bureau and training programs approved by not necessarily sponsored by the U.S. Department of Labor Employment Training Administration shall also be considered acceptable provided it is being administered in a manner consistent with the equal employment obligations of Federal-aid highway construction contracts. Approval or acceptance of a training program shall be obtained from the State prior to commencing work on the classification covered by the program. It is the intention of these provisions that training is to be provided in the construction crafts rather than clerk-typists or secretarial-type positions. Training is permissible in lower level management positions such as office engineers, estimators, timekeepers, etc., where the training is oriented toward construction applications. Training in the laborer classification may be permitted provided that significant and meaningful training is provided and approved by the Illinois Department of Transportation and the Federal Highway Administration. Some offsite training is permissible as long as the training is an integral part of an approved training program and does not comprise a significant part of the overall training.

Except as otherwise noted below, the Contractor will be reimbursed 80 cents per hour of training given an employee on this contract in accordance with an approved training program. As approved by the Engineer, reimbursement will be made for training of persons in excess of the number specified herein. This reimbursement will be made even though the Contractor receives additional training program funds from other sources, provided such other source does not specifically prohibit the Contractor from receiving other reimbursement. Reimbursement for offsite training indicated above may only be made to the Contractor where he does one or more of the following and the trainees are concurrently employed on a Federal-aid project; contributes to the cost of the training, provides the instruction to the trainee or pays the trainee's wages during the offsite training period.

No payment shall be made to the Contractor if either the failure to provide the required training, or the failure to hire the trainee as a journeyman, is caused by the Contractor and evidences a lack of good faith on the part of the Contractor in meeting the requirement of this Training Special Provision. It is normally expected that a trainee will begin his training on the project as soon as feasible after start of work utilizing the skill involved and remain on the project as long as training opportunities exist in his work classification or until he has completed his training program.

It is not required that all trainees be on board for the entire length of the contract. A Contractor will have fulfilled his responsibilities under this Training Special Provision if he has provided acceptable training to the number of trainees specified. The number trained shall be determined on the basis of the total number enrolled on the contract for a significant period.

Trainees will be paid at least 60 percent of the appropriate minimum journeyman's rate specified in the contract for the first half of the training period, 75 percent for the third quarter of the training period, and 90 percent for the last quarter of the training period, unless apprentices or trainees in an approved existing program are enrolled as trainees on this project. In that case, the appropriate rates approved by the Departments of Labor or Transportation in connection with the existing program shall apply to all trainees being trained for the same classification who are covered by this Training Special Provision.

The Contractor shall furnish the trainee a copy of the program he will follow in providing the training. The Contractor shall provide each trainee with a certification showing the type and length of training satisfactorily complete.

The Contractor shall provide for the maintenance of records and furnish periodic reports documenting its performance under this Training Special Provision.

For contracts with an awarded contract value of \$500,000 or more, the Contractor is required to comply with the Illinois Works Apprenticeship Initiative (30 ILCS 559/20-20 to 20-25) and all applicable administrative rules to the extent permitted by Section 20-20(g). For federally funded projects, the number of trainees to be trained under this contract, as stated in the Training Special Provisions, will be the established goal for the Illinois Works Apprenticeship Initiative 30 ILCS 559/20-20(g). The Contractor shall make a good faith effort to meet this goal. For federally funded projects, the Illinois Works Apprenticeship Initiative will be implemented using the FHWA approved OJT procedures. The Contractor must comply with the recordkeeping and reporting obligations of the Illinois Works Apprenticeship Initiative for the life of the project, including the certification as to whether the trainee/apprentice labor hour goals were met.

Method of Measurement. The unit of measurement is in hours.

Basis of Payment. This work will be paid for at the contract unit price of 80 cents per hour for TRAINEES. The estimated total number of hours, unit price, and total price have been included in the schedule of prices.

IDOT TRAINING PROGRAM GRADUATE ON-THE-JOB TRAINING SPECIAL PROVISION

Effective: August 1, 2012

Revised: February 2, 2017

In addition to the Contractor's equal employment opportunity (EEO) affirmative action efforts undertaken as required by this Contract, the Contractor is encouraged to participate in the incentive program described below to provide additional on-the-job training to certified graduates of the IDOT pre-apprenticeship training program, as outlined in this Special Provision.

IDOT funds, and various Illinois community colleges operate, pre-apprenticeship training programs throughout the State to provide training and skill-improvement opportunities to promote the increased employment of minority groups, disadvantaged persons and women in all aspects of the highway construction industry. The intent of this IDOT Pre-Apprenticeship Training Program Graduate (TPG) special provision (Special Provision) is to place these certified program graduates on the project site for this Contract in order to provide the graduates with meaningful on-the-job training. Pursuant to this Special Provision, the Contractor must make every reasonable effort to recruit and employ certified TPG trainees to the extent such individuals are available within a practicable distance of the project site.

Specifically, participation of the Contractor or its subcontractor in the Program entitles the participant to reimbursement for graduates' hourly wages at \$15.00 per hour per utilized TPG trainee, subject to the terms of this Special Provision. Reimbursement payment will be made even though the Contractor or subcontractor may also receive additional training program funds from other non-IDOT sources for other non-TPG trainees on the Contract, provided such other source does not specifically prohibit the Contractor or subcontractor from receiving reimbursement from another entity through another program, such as IDOT through the TPG program. With regard to any IDOT funded construction training program other than TPG, however, additional reimbursement for other IDOT programs will not be made beyond the TPG Program described in this Special Provision when the TPG Program is utilized.

No payment will be made to the Contractor if the Contractor or subcontractor fails to provide the required on-site training to TPG trainees, as solely determined by IDOT. A TPG trainee must begin training on the project as soon as the start of work that utilizes the relevant trade skill and the TPG trainee must remain on the project site through completion of the Contract, so long as training opportunities continue to exist in the relevant work classification. Should a TPG trainee's employment end in advance of the completion of the Contract, the Contractor must promptly notify the IDOT District EEO Officer for the Contract that the TPG's involvement in the Contract has ended. The Contractor must supply a written report for the reason the TPG trainee involvement terminated, the hours completed by the TPG trainee on the Contract, and the number of hours for which the incentive payment provided under this Special Provision will be, or has been claimed for the separated TPG trainee.

Finally, the Contractor must maintain all records it creates as a result of participation in the Program on the Contract, and furnish periodic written reports to the IDOT District EEO Officer that document its contractual performance under and compliance with this Special Provision. Finally, through participation in the Program and reimbursement of wages, the Contractor is not relieved of, and IDOT has not waived, the requirements of any federal or state labor or employment law applicable to TPG workers, including compliance with the Illinois Prevailing Wage Act.

Method of Measurement: The unit of measurement is in hours.

Basis of Payment: This work will be paid for at the contract unit price of \$15.00 per hour for each utilized certified TPG Program trainee (TRAINEES TRAINING PROGRAM GRADUATE). The estimated total number of hours, unit price, and total price must be included in the schedule of prices for the Contract submitted by Contractor prior to beginning work. The initial number of TPG trainees for which the incentive is available for this contract is 1.

The Department has contracted with several educational institutions to provide screening, tutoring and pre-training to individuals interested in working as a TPG trainee in various areas of common construction trade work. Only individuals who have successfully completed a Pre-Apprenticeship Training Program at these IDOT approved institutions are eligible to be TPG trainees. To obtain a list of institutions that can connect the Contractor with eligible TPG trainees, the Contractor may contact: HCCTP TPG Program Coordinator, Office of Business and Workforce Diversity (IDOT OBWD), Room 319, Illinois Department of Transportation, 2300 S. Dirksen Parkway, Springfield, Illinois 62764. Prior to commencing construction with the utilization of a TPG trainee, the Contractor must submit documentation to the IDOT District EEO Officer for the Contract that provides the names and contact information of the TPG trainee(s) to be trained in each selected work classification, proof that that the TPG trainee(s) has successfully completed a Pre-Apprenticeship Training Program, proof that the TPG is in an Apprenticeship Training Program approved by the U.S. Department of Labor Bureau of Apprenticeship Training, and the start date for training in each of the applicable work classifications.

To receive payment, the Contractor must provide training opportunities aimed at developing a full journeyworker in the type of trade or job classification involved. During the course of performance of the Contract, the Contractor may seek approval from the IDOT District EEO Officer to employ additional eligible TPG trainees. In the event the Contractor subcontracts a portion of the contracted work, it must determine how many, if any, of the TPGs will be trained by the subcontractor. Though a subcontractor may conduct training, the Contractor retains the responsibility for meeting all requirements imposed by this Special Provision. The Contractor must also include this Special Provision in any subcontract where payment for contracted work performed by a TPG trainee will be passed on to a subcontractor.

Training through the Program is intended to move TPGs toward journeyman status, which is the primary objective of this Special Provision. Accordingly, the Contractor must make every effort to enroll TPG trainees by recruitment through the Program participant educational institutions to the extent eligible TPGs are available within a reasonable geographic area of the project. The Contractor is responsible for demonstrating, through documentation, the recruitment efforts it has undertaken prior to the determination by IDOT whether the Contractor is in compliance with this Special Provision, and therefore, entitled to the Training Program Graduate reimbursement of \$15.00 per hour.

Notwithstanding the on-the-job training requirement of this TPG Special Provision, some minimal off-site training is permissible as long as the offsite training is an integral part of the work of the contract, and does not compromise or conflict with the required on-site training that is central to the purpose of the Program. No individual may be employed as a TPG trainee in any work classification in which he/she has previously successfully completed a training program leading to journeyman status in any trade, or in which he/she has worked at a journeyman level or higher.

WEEKLY DBE TRUCKING REPORTS (BDE)

Effective: June 2, 2012

Revised: November 1, 2021

The Contractor shall submit a weekly report of Disadvantaged Business Enterprise (DBE) trucks hired by the Contractor or subcontractors (i.e. not owned by the Contractor or subcontractors) that are used for DBE goal credit.

The report shall be submitted to the Engineer on Department form "SBE 723" within ten business days following the reporting period. The reporting period shall be Sunday through Saturday for each week reportable trucking activities occur.

Any costs associated with providing weekly DBE trucking reports shall be considered as included in the contract unit prices bid for the various items of work involved and no additional compensation will be allowed.

WORK ZONE TRAFFIC CONTROL DEVICES (BDE)

Effective: March 2, 2020

Add the following to Article 701.03 of the Standard Specifications:

“(q) Temporary Sign Supports1106.02”

Revise the third paragraph of Article 701.14 of the Standard Specifications to read:

“For temporary sign supports, the Contractor shall provide a FHWA eligibility letter for each device used on the contract. The letter shall provide information for the set-up and use of the device as well as a detailed drawing of the device. The signs shall be supported within 20 degrees of vertical. Weights used to stabilize signs shall be attached to the sign support per the manufacturer’s specifications.”

Revise the first paragraph of Article 701.15 of the Standard Specifications to read:

“701.15 Traffic Control Devices. For devices that must meet crashworthiness standards, the Contractor shall provide a manufacturer’s self-certification or a FHWA eligibility letter for each Category 1 device and a FHWA eligibility letter for each Category 2 and Category 3 device used on the contract. The self-certification or letter shall provide information for the set-up and use of the device as well as a detailed drawing of the device.”

Revise the first six paragraphs of Article 1106.02 of the Standard Specifications to read:

“1106.02 Devices. Work zone traffic control devices and combinations of devices shall meet crashworthiness standards for their respective categories. The categories are as follows.

Category 1 includes small, lightweight, channelizing and delineating devices that have been in common use for many years and are known to be crashworthy by crash testing of similar devices or years of demonstrable safe performance. These include cones, tubular markers, plastic drums, and delineators, with no attachments (e.g. lights). Category 1 devices manufactured after December 31, 2019 shall be MASH-16 compliant. Category 1 devices manufactured on or before December 31, 2019, and compliant with NCHRP 350 or MASH 2009, may be used on contracts let before December 31, 2024.

Category 2 includes devices that are not expected to produce significant vehicular velocity change but may otherwise be hazardous. These include vertical panels with lights, barricades, temporary sign supports, and Category 1 devices with attachments (e.g. drums with lights). Category 2 devices manufactured after December 31, 2019 shall be MASH-16 compliant. Category 2 devices manufactured on or before December 31, 2019, and compliant with NCHRP 350 or MASH 2009, may be used on contracts let before December 31, 2024.

Category 3 includes devices that are expected to cause significant velocity changes or other potentially harmful reactions to impacting vehicles. These include crash cushions (impact attenuators), truck mounted attenuators, and other devices not meeting the definitions of Category 1 or 2. Category 3 devices manufactured after December 31, 2019 shall be MASH-16 compliant. Category 3 devices manufactured on or before December 31, 2019, and compliant with NCHRP 350 or MASH 2009, may be used on contracts let before December 31, 2029. Category 3 devices shall be crash tested for Test Level 3 or the test level specified.

Category 4 includes portable or trailer-mounted devices such as arrow boards, changeable message signs, temporary traffic signals, and area lighting supports. It is preferable for Category 4 devices manufactured after December 31, 2019 to be MASH-16 compliant; however, there are currently no crash tested devices in this category, so it remains exempt from the NCHRP 350 or MASH compliance requirement.

For each type of device, when no more than one MASH-16 compliant is available, an NCHRP 350 or MASH-2009 compliant device may be used, even if manufactured after December 31, 2019.”

Revise Articles 1106.02(g), 1106.02(k), and 1106.02(l) to read:

“(g) Truck Mounted/Trailer Mounted Attenuators. The attenuator shall be approved for use at Test Level 3. Test Level 2 may be used for normal posted speeds less than or equal to 45 mph.

(k) Temporary Water Filled Barrier. The water filled barrier shall be a lightweight plastic shell designed to accept water ballast and be on the Department’s qualified product list.

Shop drawings shall be furnished by the manufacturer and shall indicate the deflection of the barrier as determined by acceptance testing; the configuration of the barrier in that test; and the vehicle weight, velocity, and angle of impact of the deflection test. The Engineer shall be provided one copy of the shop drawings.

(l) Movable Traffic Barrier. The movable traffic barrier shall be on the Department’s qualified product list.

Shop drawings shall be furnished by the manufacturer and shall indicate the deflection of the barrier as determined by acceptance testing; the configuration of the barrier in that test; and the vehicle weight, velocity, and angle of impact of the deflection test. The Engineer shall be provided one copy of the shop drawings. The barrier shall be capable of being moved on and off the roadway on a daily basis.”

WORKING DAYS (BDE)

Effective: January 1, 2002

The Contractor shall complete the work within **40** working days.

REQUIRED CONTRACT PROVISIONS FEDERAL-AID CONSTRUCTION CONTRACTS

- I. General
- II. Nondiscrimination
- III. Non-segregated Facilities
- IV. Davis-Bacon and Related Act Provisions
- V. Contract Work Hours and Safety Standards Act Provisions
- VI. Subletting or Assigning the Contract
- VII. Safety: Accident Prevention
- VIII. False Statements Concerning Highway Projects
- IX. Implementation of Clean Air Act and Federal Water Pollution Control Act
- X. Certification Regarding Debarment, Suspension, Ineligibility and Voluntary Exclusion
- XI. Certification Regarding Use of Contract Funds for Lobbying
- XII. Use of United States-Flag Vessels:

ATTACHMENTS

A. Employment and Materials Preference for Appalachian Development Highway System or Appalachian Local Access Road Contracts (included in Appalachian contracts only)

I. GENERAL

1. Form FHWA-1273 must be physically incorporated in each construction contract funded under title 23, United States Code, as required in 23 CFR 633.102(b) (excluding emergency contracts solely intended for debris removal). The contractor (or subcontractor) must insert this form in each subcontract and further require its inclusion in all lower tier subcontracts (excluding purchase orders, rental agreements and other agreements for supplies or services). 23 CFR 633.102(e).

The applicable requirements of Form FHWA-1273 are incorporated by reference for work done under any purchase order, rental agreement or agreement for other services. The prime contractor shall be responsible for compliance by any subcontractor, lower-tier subcontractor or service provider. 23 CFR 633.102(e).

Form FHWA-1273 must be included in all Federal-aid design-build contracts, in all subcontracts and in lower tier subcontracts (excluding subcontracts for design services, purchase orders, rental agreements and other agreements for supplies or services) in accordance with 23 CFR 633.102. The design-builder shall be responsible for compliance by any subcontractor, lower-tier subcontractor or service provider.

Contracting agencies may reference Form FHWA-1273 in solicitation-for-bids or request-for-proposals documents, however, the Form FHWA-1273 must be physically incorporated (not referenced) in all contracts, subcontracts and lower-tier subcontracts (excluding purchase orders, rental agreements and other agreements for supplies or services related to a construction contract). 23 CFR 633.102(b).

2. Subject to the applicability criteria noted in the following sections, these contract provisions shall apply to all work

performed on the contract by the contractor's own organization and with the assistance of workers under the contractor's immediate superintendence and to all work performed on the contract by piecework, station work, or by subcontract. 23 CFR 633.102(d).

3. A breach of any of the stipulations contained in these Required Contract Provisions may be sufficient grounds for withholding of progress payments, withholding of final payment, termination of the contract, suspension / debarment or any other action determined to be appropriate by the contracting agency and FHWA.

4. Selection of Labor: During the performance of this contract, the contractor shall not use convict labor for any purpose within the limits of a construction project on a Federal-aid highway unless it is labor performed by convicts who are on parole, supervised release, or probation. 23 U.S.C. 114(b). The term Federal-aid highway does not include roadways functionally classified as local roads or rural minor collectors. 23 U.S.C. 101(a).

II. NONDISCRIMINATION (23 CFR 230.107(a); 23 CFR Part 230, Subpart A, Appendix A; EO 11246)

The provisions of this section related to 23 CFR Part 230, Subpart A, Appendix A are applicable to all Federal-aid construction contracts and to all related construction subcontracts of \$10,000 or more. The provisions of 23 CFR Part 230 are not applicable to material supply, engineering, or architectural service contracts.

In addition, the contractor and all subcontractors must comply with the following policies: Executive Order 11246, 41 CFR Part 60, 29 CFR Parts 1625-1627, 23 U.S.C. 140, Section 504 of the Rehabilitation Act of 1973, as amended (29 U.S.C. 794), Title VI of the Civil Rights Act of 1964, as amended (42 U.S.C. 2000d et seq.), and related regulations including 49 CFR Parts 21, 26, and 27; and 23 CFR Parts 200, 230, and 633.

The contractor and all subcontractors must comply with: the requirements of the Equal Opportunity Clause in 41 CFR 60-1.4(b) and, for all construction contracts exceeding \$10,000, the Standard Federal Equal Employment Opportunity Construction Contract Specifications in 41 CFR 60-4.3.

Note: The U.S. Department of Labor has exclusive authority to determine compliance with Executive Order 11246 and the policies of the Secretary of Labor including 41 CFR Part 60, and 29 CFR Parts 1625-1627. The contracting agency and the FHWA have the authority and the responsibility to ensure compliance with 23 U.S.C. 140, Section 504 of the Rehabilitation Act of 1973, as amended (29 U.S.C. 794), and Title VI of the Civil Rights Act of 1964, as amended (42 U.S.C. 2000d et seq.), and related regulations including 49 CFR Parts 21, 26, and 27; and 23 CFR Parts 200, 230, and 633.

The following provision is adopted from 23 CFR Part 230, Subpart A, Appendix A, with appropriate revisions to conform to the U.S. Department of Labor (US DOL) and FHWA requirements.

1. Equal Employment Opportunity: Equal Employment Opportunity (EEO) requirements not to discriminate and to take affirmative action to assure equal opportunity as set forth under laws, executive orders, rules, regulations (see 28 CFR Part 35, 29 CFR Part 1630, 29 CFR Parts 1625-1627, 41 CFR Part 60 and 49 CFR Part 27) and orders of the Secretary of Labor as modified by the provisions prescribed herein, and imposed pursuant to 23 U.S.C. 140, shall constitute the EEO and specific affirmative action standards for the contractor's project activities under this contract. The provisions of the Americans with Disabilities Act of 1990 (42 U.S.C. 12101 et seq.) set forth under 28 CFR Part 35 and 29 CFR Part 1630 are incorporated by reference in this contract. In the execution of this contract, the contractor agrees to comply with the following minimum specific requirement activities of EEO:

a. The contractor will work with the contracting agency and the Federal Government to ensure that it has made every good faith effort to provide equal opportunity with respect to all of its terms and conditions of employment and in their review of activities under the contract. 23 CFR 230.409 (g)(4) & (5).

b. The contractor will accept as its operating policy the following statement:

"It is the policy of this Company to assure that applicants are employed, and that employees are treated during employment, without regard to their race, religion, sex, sexual orientation, gender identity, color, national origin, age or disability. Such action shall include: employment, upgrading, demotion, or transfer; recruitment or recruitment advertising; layoff or termination; rates of pay or other forms of compensation; and selection for training, including apprenticeship, pre-apprenticeship, and/or on-the-job training."

2. EEO Officer: The contractor will designate and make known to the contracting officers an EEO Officer who will have the responsibility for and must be capable of effectively administering and promoting an active EEO program and who must be assigned adequate authority and responsibility to do so.

3. Dissemination of Policy: All members of the contractor's staff who are authorized to hire, supervise, promote, and discharge employees, or who recommend such action or are substantially involved in such action, will be made fully cognizant of and will implement the contractor's EEO policy and contractual responsibilities to provide EEO in each grade and classification of employment. To ensure that the above agreement will be met, the following actions will be taken as a minimum:

a. Periodic meetings of supervisory and personnel office employees will be conducted before the start of work and then not less often than once every six months, at which time the contractor's EEO policy and its implementation will be reviewed and explained. The meetings will be conducted by the EEO Officer or other knowledgeable company official.

b. All new supervisory or personnel office employees will be given a thorough indoctrination by the EEO Officer, covering all major aspects of the contractor's EEO obligations within thirty days following their reporting for duty with the contractor.

c. All personnel who are engaged in direct recruitment for the project will be instructed by the EEO Officer in the contractor's procedures for locating and hiring minorities and women.

d. Notices and posters setting forth the contractor's EEO policy will be placed in areas readily accessible to employees, applicants for employment and potential employees.

e. The contractor's EEO policy and the procedures to implement such policy will be brought to the attention of employees by means of meetings, employee handbooks, or other appropriate means.

4. Recruitment: When advertising for employees, the contractor will include in all advertisements for employees the notation: "An Equal Opportunity Employer." All such advertisements will be placed in publications having a large circulation among minorities and women in the area from which the project work force would normally be derived.

a. The contractor will, unless precluded by a valid bargaining agreement, conduct systematic and direct recruitment through public and private employee referral sources likely to yield qualified minorities and women. To meet this requirement, the contractor will identify sources of potential minority group employees and establish with such identified sources procedures whereby minority and women applicants may be referred to the contractor for employment consideration.

b. In the event the contractor has a valid bargaining agreement providing for exclusive hiring hall referrals, the contractor is expected to observe the provisions of that agreement to the extent that the system meets the contractor's compliance with EEO contract provisions. Where implementation of such an agreement has the effect of discriminating against minorities or women, or obligates the contractor to do the same, such implementation violates Federal nondiscrimination provisions.

c. The contractor will encourage its present employees to refer minorities and women as applicants for employment. Information and procedures with regard to referring such applicants will be discussed with employees.

5. Personnel Actions: Wages, working conditions, and employee benefits shall be established and administered, and personnel actions of every type, including hiring, upgrading, promotion, transfer, demotion, layoff, and termination, shall be taken without regard to race, color, religion, sex, sexual orientation, gender identity, national origin, age or disability. The following procedures shall be followed:

a. The contractor will conduct periodic inspections of project sites to ensure that working conditions and employee facilities do not indicate discriminatory treatment of project site personnel.

b. The contractor will periodically evaluate the spread of wages paid within each classification to determine any evidence of discriminatory wage practices.

c. The contractor will periodically review selected personnel actions in depth to determine whether there is evidence of discrimination. Where evidence is found, the contractor will promptly take corrective action. If the review indicates that the discrimination may extend beyond the actions reviewed, such corrective action shall include all affected persons.

d. The contractor will promptly investigate all complaints of alleged discrimination made to the contractor in connection with its obligations under this contract, will attempt to resolve such complaints, and will take appropriate corrective action

within a reasonable time. If the investigation indicates that the discrimination may affect persons other than the complainant, such corrective action shall include such other persons. Upon completion of each investigation, the contractor will inform every complainant of all of their avenues of appeal.

6. Training and Promotion:

a. The contractor will assist in locating, qualifying, and increasing the skills of minorities and women who are applicants for employment or current employees. Such efforts should be aimed at developing full journey level status employees in the type of trade or job classification involved.

b. Consistent with the contractor's work force requirements and as permissible under Federal and State regulations, the contractor shall make full use of training programs (i.e., apprenticeship and on-the-job training programs for the geographical area of contract performance). In the event a special provision for training is provided under this contract, this subparagraph will be superseded as indicated in the special provision. The contracting agency may reserve training positions for persons who receive welfare assistance in accordance with 23 U.S.C. 140(a).

c. The contractor will advise employees and applicants for employment of available training programs and entrance requirements for each.

d. The contractor will periodically review the training and promotion potential of employees who are minorities and women and will encourage eligible employees to apply for such training and promotion.

7. Unions: If the contractor relies in whole or in part upon unions as a source of employees, the contractor will use good faith efforts to obtain the cooperation of such unions to increase opportunities for minorities and women. 23 CFR 230.409. Actions by the contractor, either directly or through a contractor's association acting as agent, will include the procedures set forth below:

a. The contractor will use good faith efforts to develop, in cooperation with the unions, joint training programs aimed toward qualifying more minorities and women for membership in the unions and increasing the skills of minorities and women so that they may qualify for higher paying employment.

b. The contractor will use good faith efforts to incorporate an EEO clause into each union agreement to the end that such union will be contractually bound to refer applicants without regard to their race, color, religion, sex, sexual orientation, gender identity, national origin, age, or disability.

c. The contractor is to obtain information as to the referral practices and policies of the labor union except that to the extent such information is within the exclusive possession of the labor union and such labor union refuses to furnish such information to the contractor, the contractor shall so certify to the contracting agency and shall set forth what efforts have been made to obtain such information.

d. In the event the union is unable to provide the contractor with a reasonable flow of referrals within the time limit set forth in the collective bargaining agreement, the contractor will, through independent recruitment efforts, fill the employment vacancies without regard to race, color, religion, sex, sexual orientation, gender identity, national origin, age, or disability; making full efforts to obtain qualified and/or qualifiable minorities and women. The failure of a union to provide

sufficient referrals (even though it is obligated to provide exclusive referrals under the terms of a collective bargaining agreement) does not relieve the contractor from the requirements of this paragraph. In the event the union referral practice prevents the contractor from meeting the obligations pursuant to Executive Order 11246, as amended, and these special provisions, such contractor shall immediately notify the contracting agency.

8. Reasonable Accommodation for Applicants /

Employees with Disabilities: The contractor must be familiar with the requirements for and comply with the Americans with Disabilities Act and all rules and regulations established thereunder. Employers must provide reasonable accommodation in all employment activities unless to do so would cause an undue hardship.

9. Selection of Subcontractors, Procurement of Materials and Leasing of Equipment:

The contractor shall not discriminate on the grounds of race, color, religion, sex, sexual orientation, gender identity, national origin, age, or disability in the selection and retention of subcontractors, including procurement of materials and leases of equipment. The contractor shall take all necessary and reasonable steps to ensure nondiscrimination in the administration of this contract.

a. The contractor shall notify all potential subcontractors, suppliers, and lessors of their EEO obligations under this contract.

b. The contractor will use good faith efforts to ensure subcontractor compliance with their EEO obligations.

10. Assurances Required:

a. The requirements of 49 CFR Part 26 and the State DOT's FHWA-approved Disadvantaged Business Enterprise (DBE) program are incorporated by reference.

b. The contractor, subrecipient or subcontractor shall not discriminate on the basis of race, color, national origin, or sex in the performance of this contract. The contractor shall carry out applicable requirements of 49 CFR part 26 in the award and administration of DOT-assisted contracts. Failure by the contractor to carry out these requirements is a material breach of this contract, which may result in the termination of this contract or such other remedy as the recipient deems appropriate, which may include, but is not limited to:

- (1) Withholding monthly progress payments;
- (2) Assessing sanctions;
- (3) Liquidated damages; and/or
- (4) Disqualifying the contractor from future bidding as non-responsible.

c. The Title VI and nondiscrimination provisions of U.S. DOT Order 1050.2A at Appendixes A and E are incorporated by reference. 49 CFR Part 21.

11. Records and Reports: The contractor shall keep such records as necessary to document compliance with the EEO requirements. Such records shall be retained for a period of three years following the date of the final payment to the contractor for all contract work and shall be available at reasonable times and places for inspection by authorized representatives of the contracting agency and the FHWA.

a. The records kept by the contractor shall document the following:

(1) The number and work hours of minority and non-minority group members and women employed in each work classification on the project;

(2) The progress and efforts being made in cooperation with unions, when applicable, to increase employment opportunities for minorities and women; and

(3) The progress and efforts being made in locating, hiring, training, qualifying, and upgrading minorities and women.

b. The contractors and subcontractors will submit an annual report to the contracting agency each July for the duration of the project indicating the number of minority, women, and non-minority group employees currently engaged in each work classification required by the contract work. This information is to be reported on [Form FHWA-1391](#). The staffing data should represent the project work force on board in all or any part of the last payroll period preceding the end of July. If on-the-job training is being required by special provision, the contractor will be required to collect and report training data. The employment data should reflect the work force on board during all or any part of the last payroll period preceding the end of July.

III. NONSEGREGATED FACILITIES

This provision is applicable to all Federal-aid construction contracts and to all related construction subcontracts of more than \$10,000. 41 CFR 60-1.5.

As prescribed by 41 CFR 60-1.8, the contractor must ensure that facilities provided for employees are provided in such a manner that segregation on the basis of race, color, religion, sex, sexual orientation, gender identity, or national origin cannot result. The contractor may neither require such segregated use by written or oral policies nor tolerate such use by employee custom. The contractor's obligation extends further to ensure that its employees are not assigned to perform their services at any location under the contractor's control where the facilities are segregated. The term "facilities" includes waiting rooms, work areas, restaurants and other eating areas, time clocks, restrooms, washrooms, locker rooms and other storage or dressing areas, parking lots, drinking fountains, recreation or entertainment areas, transportation, and housing provided for employees. The contractor shall provide separate or single-user restrooms and necessary dressing or sleeping areas to assure privacy between sexes.

IV. DAVIS-BACON AND RELATED ACT PROVISIONS

This section is applicable to all Federal-aid construction projects exceeding \$2,000 and to all related subcontracts and lower-tier subcontracts (regardless of subcontract size), in accordance with 29 CFR 5.5. The requirements apply to all projects located within the right-of-way of a roadway that is functionally classified as Federal-aid highway. 23 U.S.C. 113. This excludes roadways functionally classified as local roads or rural minor collectors, which are exempt. 23 U.S.C. 101. Where applicable law requires that projects be treated as a project on a Federal-aid highway, the provisions of this subpart will apply regardless of the location of the project. Examples include: Surface Transportation Block Grant Program projects funded under 23 U.S.C. 133 [excluding recreational trails projects], the Nationally Significant Freight and Highway

Projects funded under 23 U.S.C. 117, and National Highway Freight Program projects funded under 23 U.S.C. 167.

The following provisions are from the U.S. Department of Labor regulations in 29 CFR 5.5 "Contract provisions and related matters" with minor revisions to conform to the FHWA- 1273 format and FHWA program requirements.

1. Minimum wages (29 CFR 5.5)

a. All laborers and mechanics employed or working upon the site of the work, will be paid unconditionally and not less often than once a week, and without subsequent deduction or rebate on any account (except such payroll deductions as are permitted by regulations issued by the Secretary of Labor under the Copeland Act (29 CFR part 3)), the full amount of wages and bona fide fringe benefits (or cash equivalents thereof) due at time of payment computed at rates not less than those contained in the wage determination of the Secretary of Labor which is attached hereto and made a part hereof, regardless of any contractual relationship which may be alleged to exist between the contractor and such laborers and mechanics.

Contributions made or costs reasonably anticipated for bona fide fringe benefits under section 1(b)(2) of the Davis-Bacon Act on behalf of laborers or mechanics are considered wages paid to such laborers or mechanics, subject to the provisions of paragraph 1.d. of this section; also, regular contributions made or costs incurred for more than a weekly period (but not less often than quarterly) under plans, funds, or programs which cover the particular weekly period, are deemed to be constructively made or incurred during such weekly period. Such laborers and mechanics shall be paid the appropriate wage rate and fringe benefits on the wage determination for the classification of work actually performed, without regard to skill, except as provided in 29 CFR 5.5(a)(4). Laborers or mechanics performing work in more than one classification may be compensated at the rate specified for each classification for the time actually worked therein: Provided, That the employer's payroll records accurately set forth the time spent in each classification in which work is performed. The wage determination (including any additional classification and wage rates conformed under paragraph 1.b. of this section) and the Davis-Bacon poster (WH-1321) shall be posted at all times by the contractor and its subcontractors at the site of the work in a prominent and accessible place where it can be easily seen by the workers.

b. (1) The contracting officer shall require that any class of laborers or mechanics, including helpers, which is not listed in the wage determination and which is to be employed under the contract shall be classified in conformance with the wage determination. The contracting officer shall approve an additional classification and wage rate and fringe benefits therefore only when the following criteria have been met:

(i) The work to be performed by the classification requested is not performed by a classification in the wage determination; and

(ii) The classification is utilized in the area by the construction industry; and

(iii) The proposed wage rate, including any bona fide fringe benefits, bears a reasonable relationship to the wage rates contained in the wage determination.

(2) If the contractor and the laborers and mechanics to be employed in the classification (if known), or their representatives, and the contracting officer agree on the classification and wage rate (including the amount designated for fringe benefits where appropriate), a report of the action taken shall be sent by the contracting officer to the Administrator of the Wage and Hour Division, U.S. Department of Labor, Washington, DC 20210. The Administrator, or an authorized representative, will approve, modify, or disapprove every additional classification action within 30 days of receipt and so advise the contracting officer or will notify the contracting officer within the 30-day period that additional time is necessary.

(3) In the event the contractor, the laborers or mechanics to be employed in the classification or their representatives, and the contracting officer do not agree on the proposed classification and wage rate (including the amount designated for fringe benefits, where appropriate), the contracting officer shall refer the questions, including the views of all interested parties and the recommendation of the contracting officer, to the Administrator for determination. The Administrator, or an authorized representative, will issue a determination within 30 days of receipt and so advise the contracting officer or will notify the contracting officer within the 30-day period that additional time is necessary.

(4) The wage rate (including fringe benefits where appropriate) determined pursuant to paragraphs 1.b.(2) or 1.b.(3) of this section, shall be paid to all workers performing work in the classification under this contract from the first day on which work is performed in the classification.

c. Whenever the minimum wage rate prescribed in the contract for a class of laborers or mechanics includes a fringe benefit which is not expressed as an hourly rate, the contractor shall either pay the benefit as stated in the wage determination or shall pay another bona fide fringe benefit or an hourly cash equivalent thereof.

d. If the contractor does not make payments to a trustee or other third person, the contractor may consider as part of the wages of any laborer or mechanic the amount of any costs reasonably anticipated in providing bona fide fringe benefits under a plan or program, Provided, That the Secretary of Labor has found, upon the written request of the contractor, that the applicable standards of the Davis-Bacon Act have been met. The Secretary of Labor may require the contractor to set aside in a separate account assets for the meeting of obligations under the plan or program.

2. Withholding (29 CFR 5.5)

The contracting agency shall upon its own action or upon written request of an authorized representative of the Department of Labor, withhold or cause to be withheld from the contractor under this contract, or any other Federal contract with the same prime contractor, or any other federally- assisted contract subject to Davis-Bacon prevailing wage requirements, which is held by the same prime contractor, so much of the accrued payments or advances as may be considered necessary to pay laborers and mechanics,

including apprentices, trainees, and helpers, employed by the contractor or any subcontractor the full amount of wages required by the contract. In the event of failure to pay any laborer or mechanic, including any apprentice, trainee, or helper, employed or working on the site of the work, all or part of the wages required by the contract, the contracting agency may, after written notice to the contractor, take such action as may be necessary to cause the suspension of any further payment, advance, or guarantee of funds until such violations have ceased.

3. Payrolls and basic records (29 CFR 5.5)

a. Payrolls and basic records relating thereto shall be maintained by the contractor during the course of the work and preserved for a period of three years thereafter for all laborers and mechanics working at the site of the work. Such records shall contain the name, address, and social security number of each such worker, his or her correct classification, hourly rates of wages paid (including rates of contributions or costs anticipated for bona fide fringe benefits or cash equivalents thereof of the types described in section 1(b)(2)(B) of the Davis-Bacon Act), daily and weekly number of hours worked, deductions made and actual wages paid. Whenever the Secretary of Labor has found under 29 CFR 5.5(a)(1)(iv) that the wages of any laborer or mechanic include the amount of any costs reasonably anticipated in providing benefits under a plan or program described in section 1(b)(2)(B) of the Davis-Bacon Act, the contractor shall maintain records which show that the commitment to provide such benefits is enforceable, that the plan or program is financially responsible, and that the plan or program has been communicated in writing to the laborers or mechanics affected, and records which show the costs anticipated or the actual cost incurred in providing such benefits. Contractors employing apprentices or trainees under approved programs shall maintain written evidence of the registration of apprenticeship programs and certification of trainee programs, the registration of the apprentices and trainees, and the ratios and wage rates prescribed in the applicable programs.

b.(1) The contractor shall submit weekly for each week in which any contract work is performed a copy of all payrolls to the contracting agency. The payrolls submitted shall set out accurately and completely all of the information required to be maintained under 29 CFR 5.5(a)(3)(i), except that full social security numbers and home addresses shall not be included on weekly transmittals. Instead the payrolls shall only need to include an individually identifying number for each employee (e.g., the last four digits of the employee's social security number). The required weekly payroll information may be submitted in any form desired. Optional Form WH-347 is available for this purpose from the Wage and Hour Division Web site. The prime contractor is responsible for the submission of copies of payrolls by all subcontractors. Contractors and subcontractors shall maintain the full social security number and current address of each covered worker, and shall provide them upon request to the contracting agency for transmission to the State DOT, the FHWA or the Wage and Hour Division of the Department of Labor for purposes of an investigation or audit of compliance with prevailing wage requirements. It is not a violation of this section for a prime contractor to require a subcontractor to provide addresses and social security numbers to the prime contractor for its own records, without weekly submission to the contracting agency.

(2) Each payroll submitted shall be accompanied by a "Statement of Compliance," signed by the contractor or

subcontractor or his or her agent who pays or supervises the payment of the persons employed under the contract and shall certify the following:

(i) That the payroll for the payroll period contains the information required to be provided under 29 CFR 5.5(a)(3)(ii), the appropriate information is being maintained under 29 CFR 5.5(a)(3)(i), and that such information is correct and complete;

(ii) That each laborer or mechanic (including each helper, apprentice, and trainee) employed on the contract during the payroll period has been paid the full weekly wages earned, without rebate, either directly or indirectly, and that no deductions have been made either directly or indirectly from the full wages earned, other than permissible deductions as set forth in 29 CFR part 3;

(iii) That each laborer or mechanic has been paid not less than the applicable wage rates and fringe benefits or cash equivalents for the classification of work performed, as specified in the applicable wage determination incorporated into the contract.

(3) The weekly submission of a properly executed certification set forth on the reverse side of Optional Form WH-347 shall satisfy the requirement for submission of the "Statement of Compliance" required by paragraph 3.b.(2) of this section.

(4) The falsification of any of the above certifications may subject the contractor or subcontractor to civil or criminal prosecution under 18 U.S.C. 1001 and 31 U.S.C. 231.

c. The contractor or subcontractor shall make the records required under paragraph 3.a. of this section available for inspection, copying, or transcription by authorized representatives of the contracting agency, the State DOT, the FHWA, or the Department of Labor, and shall permit such representatives to interview employees during working hours on the job. If the contractor or subcontractor fails to submit the required records or to make them available, the FHWA may, after written notice to the contractor, the contracting agency or the State DOT, take such action as may be necessary to cause the suspension of any further payment, advance, or guarantee of funds. Furthermore, failure to submit the required records upon request or to make such records available may be grounds for debarment action pursuant to 29 CFR 5.12.

4. Apprentices and trainees (29 CFR 5.5)

a. Apprentices (programs of the USDOL).

Apprentices will be permitted to work at less than the predetermined rate for the work they performed when they are employed pursuant to and individually registered in a bona fide apprenticeship program registered with the U.S. Department of Labor, Employment and Training Administration, Office of Apprenticeship Training, Employer and Labor Services, or with a State Apprenticeship Agency recognized by the Office, or if a person is employed in his or her first 90 days of probationary employment as an apprentice in such an apprenticeship program, who is not individually registered in the program, but who has been certified by the Office of Apprenticeship Training, Employer and Labor Services or a State

Apprenticeship Agency (where appropriate) to be eligible for probationary employment as an apprentice.

The allowable ratio of apprentices to journeymen on the job site in any craft classification shall not be greater than the ratio permitted to the contractor as to the entire work force under the registered program. Any worker listed on a payroll at an apprentice wage rate, who is not registered or otherwise employed as stated above, shall be paid not less than the applicable wage rate on the wage determination for the classification of work actually performed. In addition, any apprentice performing work on the job site in excess of the ratio permitted under the registered program shall be paid not less than the applicable wage rate on the wage determination for the work actually performed. Where a contractor is performing construction on a project in a locality other than that in which its program is registered, the ratios and wage rates (expressed in percentages of the journeyman's hourly rate) specified in the contractor's or subcontractor's registered program shall be observed.

Every apprentice must be paid at not less than the rate specified in the registered program for the apprentice's level of progress, expressed as a percentage of the journeymen hourly rate specified in the applicable wage determination.

Apprentices shall be paid fringe benefits in accordance with the provisions of the apprenticeship program. If the apprenticeship program does not specify fringe benefits, apprentices must be paid the full amount of fringe benefits listed on the wage determination for the applicable classification. If the Administrator determines that a different practice prevails for the applicable apprentice classification, fringes shall be paid in accordance with that determination.

In the event the Office of Apprenticeship Training, Employer and Labor Services, or a State Apprenticeship Agency recognized by the Office, withdraws approval of an apprenticeship program, the contractor will no longer be permitted to utilize apprentices at less than the applicable predetermined rate for the work performed until an acceptable program is approved.

b. Trainees (programs of the USDOL).

Except as provided in 29 CFR 5.16, trainees will not be permitted to work at less than the predetermined rate for the work performed unless they are employed pursuant to and individually registered in a program which has received prior approval, evidenced by formal certification by the U.S. Department of Labor, Employment and Training Administration.

The ratio of trainees to journeymen on the job site shall not be greater than permitted under the plan approved by the Employment and Training Administration.

Every trainee must be paid at not less than the rate specified in the approved program for the trainee's level of progress, expressed as a percentage of the journeyman hourly rate specified in the applicable wage determination. Trainees shall be paid fringe benefits in accordance with the provisions of the trainee program. If the trainee program does not mention fringe benefits, trainees shall be paid the full amount of fringe benefits listed on the wage determination unless the Administrator of the Wage and Hour Division determines that there is an apprenticeship program associated with the

corresponding journeyman wage rate on the wage determination which provides for less than full fringe benefits for apprentices. Any employee listed on the payroll at a trainee rate who is not registered and participating in a training plan approved by the Employment and Training Administration shall be paid not less than the applicable wage rate on the wage determination for the classification of work actually performed. In addition, any trainee performing work on the job site in excess of the ratio permitted under the registered program shall be paid not less than the applicable wage rate on the wage determination for the work actually performed.

In the event the Employment and Training Administration withdraws approval of a training program, the contractor will no longer be permitted to utilize trainees at less than the applicable predetermined rate for the work performed until an acceptable program is approved.

c. Equal employment opportunity. The utilization of apprentices, trainees and journeymen under this part shall be in conformity with the equal employment opportunity requirements of Executive Order 11246, as amended, and 29 CFR part 30.

d. Apprentices and Trainees (programs of the U.S. DOT).

Apprentices and trainees working under apprenticeship and skill training programs which have been certified by the Secretary of Transportation as promoting EEO in connection with Federal-aid highway construction programs are not subject to the requirements of paragraph 4 of this Section IV. 29 CFR 230.111(e)(2). The straight time hourly wage rates for apprentices and trainees under such programs will be established by the particular programs. The ratio of apprentices and trainees to journeymen shall not be greater than permitted by the terms of the particular program.

5. Compliance with Copeland Act requirements. The contractor shall comply with the requirements of 29 CFR part 3, which are incorporated by reference in this contract as provided in 29 CFR 5.5.

6. Subcontracts. The contractor or subcontractor shall insert Form FHWA-1273 in any subcontracts and also require the subcontractors to include Form FHWA-1273 in any lower tier subcontracts. The prime contractor shall be responsible for the compliance by any subcontractor or lower tier subcontractor with all the contract clauses in 29 CFR 5.5.

7. Contract termination: debarment. A breach of the contract clauses in 29 CFR 5.5 may be grounds for termination of the contract, and for debarment as a contractor and a subcontractor as provided in 29 CFR 5.12.

8. Compliance with Davis-Bacon and Related Act requirements. All rulings and interpretations of the Davis-Bacon and Related Acts contained in 29 CFR parts 1, 3, and 5 are herein incorporated by reference in this contract as provided in 29 CFR 5.5.

9. Disputes concerning labor standards. As provided in 29 CFR 5.5, disputes arising out of the labor standards provisions of this contract shall not be subject to the general disputes clause of this contract. Such disputes shall be resolved in accordance with the procedures of the Department of Labor

set forth in 29 CFR parts 5, 6, and 7. Disputes within the meaning of this clause include disputes between the contractor (or any of its subcontractors) and the contracting agency, the U.S. Department of Labor, or the employees or their representatives.

10. Certification of eligibility (29 CFR 5.5)

a. By entering into this contract, the contractor certifies that neither it (nor he or she) nor any person or firm who has an interest in the contractor's firm is a person or firm ineligible to be awarded Government contracts by virtue of section 3(a) of the Davis-Bacon Act or 29 CFR 5.12(a)(1).

b. No part of this contract shall be subcontracted to any person or firm ineligible for award of a Government contract by virtue of section 3(a) of the Davis-Bacon Act or 29 CFR 5.12(a)(1).

c. The penalty for making false statements is prescribed in the U.S. Criminal Code, 18 U.S.C. 1001.

V. CONTRACT WORK HOURS AND SAFETY STANDARDS ACT

Pursuant to 29 CFR 5.5(b), the following clauses apply to any Federal-aid construction contract in an amount in excess of \$100,000 and subject to the overtime provisions of the Contract Work Hours and Safety Standards Act. These clauses shall be inserted in addition to the clauses required by 29 CFR 5.5(a) or 29 CFR 4.6. As used in this paragraph, the terms laborers and mechanics include watchmen and guards.

1. Overtime requirements. No contractor or subcontractor contracting for any part of the contract work which may require or involve the employment of laborers or mechanics shall require or permit any such laborer or mechanic in any workweek in which he or she is employed on such work to work in excess of forty hours in such workweek unless such laborer or mechanic receives compensation at a rate not less than one and one-half times the basic rate of pay for all hours worked in excess of forty hours in such workweek. 29 CFR 5.5.

2. Violation; liability for unpaid wages; liquidated damages. In the event of any violation of the clause set forth in paragraph 1 of this section, the contractor and any subcontractor responsible therefor shall be liable for the unpaid wages. In addition, such contractor and subcontractor shall be liable to the United States (in the case of work done under contract for the District of Columbia or a territory, to such District or to such territory), for liquidated damages. Such liquidated damages shall be computed with respect to each individual laborer or mechanic, including watchmen and guards, employed in violation of the clause set forth in paragraph 1 of this section, in the sum currently provided in 29 CFR 5.5(b)(2)* for each calendar day on which such individual was required or permitted to work in excess of the standard workweek of forty hours without payment of the overtime wages required by the clause set forth in paragraph 1 of this section. 29 CFR 5.5.

* \$27 as of January 23, 2019 (See 84 FR 213-01, 218) as may be adjusted annually by the Department of Labor; pursuant to the Federal Civil Penalties Inflation Adjustment Act of 1990).

3. Withholding for unpaid wages and liquidated damages.

The FHWA or the contracting agency shall upon its own action or upon written request of an authorized representative of the Department of Labor withhold or cause to be withheld, from any moneys payable on account of work performed by the contractor or subcontractor under any such contract or any other Federal contract with the same prime contractor, or any other federally-assisted contract subject to the Contract Work Hours and Safety Standards Act, which is held by the same prime contractor, such sums as may be determined to be necessary to satisfy any liabilities of such contractor or subcontractor for unpaid wages and liquidated damages as provided in the clause set forth in paragraph 2 of this section. 29 CFR 5.5.

4. Subcontracts. The contractor or subcontractor shall insert in any subcontracts the clauses set forth in paragraphs 1 through 4 of this section and also a clause requiring the subcontractors to include these clauses in any lower tier subcontracts. The prime contractor shall be responsible for compliance by any subcontractor or lower tier subcontractor with the clauses set forth in paragraphs 1 through 4 of this section. 29 CFR 5.5.

VI. SUBLETTING OR ASSIGNING THE CONTRACT

This provision is applicable to all Federal-aid construction contracts on the National Highway System pursuant to 23 CFR 635.116.

1. The contractor shall perform with its own organization contract work amounting to not less than 30 percent (or a greater percentage if specified elsewhere in the contract) of the total original contract price, excluding any specialty items designated by the contracting agency. Specialty items may be performed by subcontract and the amount of any such specialty items performed may be deducted from the total original contract price before computing the amount of work required to be performed by the contractor's own organization (23 CFR 635.116).

a. The term "perform work with its own organization" in paragraph 1 of Section VI refers to workers employed or leased by the prime contractor, and equipment owned or rented by the prime contractor, with or without operators. Such term does not include employees or equipment of a subcontractor or lower tier subcontractor, agents of the prime contractor, or any other assignees. The term may include payments for the costs of hiring leased employees from an employee leasing firm meeting all relevant Federal and State regulatory requirements. Leased employees may only be included in this term if the prime contractor meets all of the following conditions: (based on longstanding interpretation)

- (1) the prime contractor maintains control over the supervision of the day-to-day activities of the leased employees;
- (2) the prime contractor remains responsible for the quality of the work of the leased employees;
- (3) the prime contractor retains all power to accept or exclude individual employees from work on the project; and
- (4) the prime contractor remains ultimately responsible for the payment of predetermined minimum wages, the submission of payrolls, statements of compliance and all other Federal regulatory requirements.

b. "Specialty Items" shall be construed to be limited to work that requires highly specialized knowledge, abilities, or

equipment not ordinarily available in the type of contracting organizations qualified and expected to bid or propose on the contract as a whole and in general are to be limited to minor components of the overall contract. 23 CFR 635.102.

2. Pursuant to 23 CFR 635.116(a), the contract amount upon which the requirements set forth in paragraph (1) of Section VI is computed includes the cost of material and manufactured products which are to be purchased or produced by the contractor under the contract provisions.

3. Pursuant to 23 CFR 635.116(c), the contractor shall furnish (a) a competent superintendent or supervisor who is employed by the firm, has full authority to direct performance of the work in accordance with the contract requirements, and is in charge of all construction operations (regardless of who performs the work) and (b) such other of its own organizational resources (supervision, management, and engineering services) as the contracting officer determines is necessary to assure the performance of the contract.

4. No portion of the contract shall be sublet, assigned or otherwise disposed of except with the written consent of the contracting officer, or authorized representative, and such consent when given shall not be construed to relieve the contractor of any responsibility for the fulfillment of the contract. Written consent will be given only after the contracting agency has assured that each subcontract is evidenced in writing and that it contains all pertinent provisions and requirements of the prime contract. (based on long-standing interpretation of 23 CFR 635.116).

5. The 30-percent self-performance requirement of paragraph (1) is not applicable to design-build contracts; however, contracting agencies may establish their own self-performance requirements. 23 CFR 635.116(d).

VII. SAFETY: ACCIDENT PREVENTION

This provision is applicable to all Federal-aid construction contracts and to all related subcontracts.

1. In the performance of this contract the contractor shall comply with all applicable Federal, State, and local laws governing safety, health, and sanitation (23 CFR Part 635). The contractor shall provide all safeguards, safety devices and protective equipment and take any other needed actions as it determines, or as the contracting officer may determine, to be reasonably necessary to protect the life and health of employees on the job and the safety of the public and to protect property in connection with the performance of the work covered by the contract. 23 CFR 635.108.

2. It is a condition of this contract, and shall be made a condition of each subcontract, which the contractor enters into pursuant to this contract, that the contractor and any subcontractor shall not permit any employee, in performance of the contract, to work in surroundings or under conditions which are unsanitary, hazardous or dangerous to his/her health or safety, as determined under construction safety and health standards (29 CFR Part 1926) promulgated by the Secretary of Labor, in accordance with Section 107 of the Contract Work Hours and Safety Standards Act (40 U.S.C. 3704). 29 CFR 1926.10.

3. Pursuant to 29 CFR 1926.3, it is a condition of this contract that the Secretary of Labor or authorized representative thereof, shall have right of entry to any site of contract performance to inspect or investigate the matter of compliance

with the construction safety and health standards and to carry out the duties of the Secretary under Section 107 of the Contract Work Hours and Safety Standards Act (40 U.S.C. 3704).

VIII. FALSE STATEMENTS CONCERNING HIGHWAY PROJECTS

This provision is applicable to all Federal-aid construction contracts and to all related subcontracts.

In order to assure high quality and durable construction in conformity with approved plans and specifications and a high degree of reliability on statements and representations made by engineers, contractors, suppliers, and workers on Federal-aid highway projects, it is essential that all persons concerned with the project perform their functions as carefully, thoroughly, and honestly as possible. Willful falsification, distortion, or misrepresentation with respect to any facts related to the project is a violation of Federal law. To prevent any misunderstanding regarding the seriousness of these and similar acts, Form FHWA-1022 shall be posted on each Federal-aid highway project (23 CFR Part 635) in one or more places where it is readily available to all persons concerned with the project:

18 U.S.C. 1020 reads as follows:

"Whoever, being an officer, agent, or employee of the United States, or of any State or Territory, or whoever, whether a person, association, firm, or corporation, knowingly makes any false statement, false representation, or false report as to the character, quality, quantity, or cost of the material used or to be used, or the quantity or quality of the work performed or to be performed, or the cost thereof in connection with the submission of plans, maps, specifications, contracts, or costs of construction on any highway or related project submitted for approval to the Secretary of Transportation; or

Whoever knowingly makes any false statement, false representation, false report or false claim with respect to the character, quality, quantity, or cost of any work performed or to be performed, or materials furnished or to be furnished, in connection with the construction of any highway or related project approved by the Secretary of Transportation; or

Whoever knowingly makes any false statement or false representation as to material fact in any statement, certificate, or report submitted pursuant to provisions of the Federal-aid Roads Act approved July 11, 1916, (39 Stat. 355), as amended and supplemented;

Shall be fined under this title or imprisoned not more than 5 years or both."

IX. IMPLEMENTATION OF CLEAN AIR ACT AND FEDERAL WATER POLLUTION CONTROL ACT (42 U.S.C. 7606; 2 CFR 200.88; EO 11738)

This provision is applicable to all Federal-aid construction contracts in excess of \$150,000 and to all related subcontracts. 48 CFR 2.101; 2 CFR 200.326.

By submission of this bid/proposal or the execution of this contract or subcontract, as appropriate, the bidder, proposer, Federal-aid construction contractor, subcontractor, supplier, or vendor agrees to comply with all applicable standards, orders

or regulations issued pursuant to the Clean Air Act (42 U.S.C. 7401-7671q) and the Federal Water Pollution Control Act, as amended (33 U.S.C. 1251-1387). Violations must be reported to the Federal Highway Administration and the Regional Office of the Environmental Protection Agency. 2 CFR Part 200, Appendix II.

The contractor agrees to include or cause to be included the requirements of this Section in every subcontract, and further agrees to take such action as the contracting agency may direct as a means of enforcing such requirements. 2 CFR 200.326.

X. CERTIFICATION REGARDING DEBARMENT, SUSPENSION, INELIGIBILITY AND VOLUNTARY EXCLUSION

This provision is applicable to all Federal-aid construction contracts, design-build contracts, subcontracts, lower-tier subcontracts, purchase orders, lease agreements, consultant contracts or any other covered transaction requiring FHWA approval or that is estimated to cost \$25,000 or more – as defined in 2 CFR Parts 180 and 1200. 2 CFR 180.220 and 1200.220.

1. Instructions for Certification – First Tier Participants:

a. By signing and submitting this proposal, the prospective first tier participant is providing the certification set out below.

b. The inability of a person to provide the certification set out below will not necessarily result in denial of participation in this covered transaction. The prospective first tier participant shall submit an explanation of why it cannot provide the certification set out below. The certification or explanation will be considered in connection with the department or agency's determination whether to enter into this transaction. However, failure of the prospective first tier participant to furnish a certification or an explanation shall disqualify such a person from participation in this transaction. 2 CFR 180.320.

c. The certification in this clause is a material representation of fact upon which reliance was placed when the contracting agency determined to enter into this transaction. If it is later determined that the prospective participant knowingly rendered an erroneous certification, in addition to other remedies available to the Federal Government, the contracting agency may terminate this transaction for cause of default. 2 CFR 180.325.

d. The prospective first tier participant shall provide immediate written notice to the contracting agency to whom this proposal is submitted if any time the prospective first tier participant learns that its certification was erroneous when submitted or has become erroneous by reason of changed circumstances. 2 CFR 180.345 and 180.350.

e. The terms "covered transaction," "debarred," "suspended," "ineligible," "participant," "person," "principal," and "voluntarily excluded," as used in this clause, are defined in 2 CFR Parts 180, Subpart I, 180.900-180.1020, and 1200. "First Tier Covered Transactions" refers to any covered transaction between a recipient or subrecipient of Federal funds and a participant (such as the prime or general contract). "Lower Tier Covered Transactions" refers to any covered transaction under a First Tier Covered Transaction (such as subcontracts). "First Tier Participant" refers to the participant

who has entered into a covered transaction with a recipient or subrecipient of Federal funds (such as the prime or general contractor). "Lower Tier Participant" refers any participant who has entered into a covered transaction with a First Tier Participant or other Lower Tier Participants (such as subcontractors and suppliers).

f. The prospective first tier participant agrees by submitting this proposal that, should the proposed covered transaction be entered into, it shall not knowingly enter into any lower tier covered transaction with a person who is debarred, suspended, declared ineligible, or voluntarily excluded from participation in this covered transaction, unless authorized by the department or agency entering into this transaction. 2 CFR 180.330.

g. The prospective first tier participant further agrees by submitting this proposal that it will include the clause titled "Certification Regarding Debarment, Suspension, Ineligibility and Voluntary Exclusion-Lower Tier Covered Transactions," provided by the department or contracting agency, entering into this covered transaction, without modification, in all lower tier covered transactions and in all solicitations for lower tier covered transactions exceeding the \$25,000 threshold. 2 CFR 180.220 and 180.300.

h. A participant in a covered transaction may rely upon a certification of a prospective participant in a lower tier covered transaction that is not debarred, suspended, ineligible, or voluntarily excluded from the covered transaction, unless it knows that the certification is erroneous. 2 CFR 180.300; 180.320, and 180.325. A participant is responsible for ensuring that its principals are not suspended, debarred, or otherwise ineligible to participate in covered transactions. 2 CFR 180.335. To verify the eligibility of its principals, as well as the eligibility of any lower tier prospective participants, each participant may, but is not required to, check the System for Award Management website (<https://www.sam.gov/>). 2 CFR 180.300, 180.320, and 180.325.

i. Nothing contained in the foregoing shall be construed to require the establishment of a system of records in order to render in good faith the certification required by this clause. The knowledge and information of the prospective participant is not required to exceed that which is normally possessed by a prudent person in the ordinary course of business dealings.

j. Except for transactions authorized under paragraph (f) of these instructions, if a participant in a covered transaction knowingly enters into a lower tier covered transaction with a person who is suspended, debarred, ineligible, or voluntarily excluded from participation in this transaction, in addition to other remedies available to the Federal Government, the department or agency may terminate this transaction for cause or default. 2 CFR 180.325.

* * * * *

2. Certification Regarding Debarment, Suspension, Ineligibility and Voluntary Exclusion – First Tier Participants:

a. The prospective first tier participant certifies to the best of its knowledge and belief, that it and its principals:

(1) Are not presently debarred, suspended, proposed for debarment, declared ineligible, or voluntarily excluded from participating in covered transactions by any Federal department or agency, 2 CFR 180.335;.

(2) Have not within a three-year period preceding this proposal been convicted of or had a civil judgment rendered against them for commission of fraud or a criminal offense in connection with obtaining, attempting to obtain, or performing a public (Federal, State, or local) transaction or contract under a public transaction; violation of Federal or State antitrust statutes or commission of embezzlement, theft, forgery, bribery, falsification or destruction of records, making false statements, or receiving stolen property, 2 CFR 180.800;

(3) Are not presently indicted for or otherwise criminally or civilly charged by a governmental entity (Federal, State or local) with commission of any of the offenses enumerated in paragraph (a)(2) of this certification, 2 CFR 180.700 and 180.800; and

(4) Have not within a three-year period preceding this application/proposal had one or more public transactions (Federal, State or local) terminated for cause or default. 2 CFR 180.335(d).

(5) Are not a corporation that has been convicted of a felony violation under any Federal law within the two-year period preceding this proposal (USDOT Order 4200.6 implementing appropriations act requirements); and

(6) Are not a corporation with any unpaid Federal tax liability that has been assessed, for which all judicial and administrative remedies have been exhausted, or have lapsed, and that is not being paid in a timely manner pursuant to an agreement with the authority responsible for collecting the tax liability (USDOT Order 4200.6 implementing appropriations act requirements).

b. Where the prospective participant is unable to certify to any of the statements in this certification, such prospective participant should attach an explanation to this proposal. 2 CFR 180.335 and 180.340.

3. Instructions for Certification - Lower Tier Participants:

(Applicable to all subcontracts, purchase orders, and other lower tier transactions requiring prior FHWA approval or estimated to cost \$25,000 or more - 2 CFR Parts 180 and 1200). 2 CFR 180.220 and 1200.220.

a. By signing and submitting this proposal, the prospective lower tier participant is providing the certification set out below.

b. The certification in this clause is a material representation of fact upon which reliance was placed when this transaction was entered into. If it is later determined that the prospective lower tier participant knowingly rendered an erroneous certification, in addition to other remedies available to the Federal Government, the department, or agency with which this transaction originated may pursue available remedies, including suspension and/or debarment.

c. The prospective lower tier participant shall provide immediate written notice to the person to which this proposal is submitted if at any time the prospective lower tier participant learns that its certification was erroneous by reason of changed circumstances. 2 CFR 180.365.

d. The terms "covered transaction," "debarred," "suspended," "ineligible," "participant," "person," "principal," and "voluntarily excluded," as used in this clause, are defined in 2 CFR Parts 180, Subpart I, 180.900 – 180.1020, and 1200. You may contact the person to which this proposal is

submitted for assistance in obtaining a copy of those regulations. "First Tier Covered Transactions" refers to any covered transaction between a recipient or subrecipient of Federal funds and a participant (such as the prime or general contractor). "Lower Tier Covered Transactions" refers to any covered transaction under a First Tier Covered Transaction (such as subcontracts). "First Tier Participant" refers to the participant who has entered into a covered transaction with a recipient or subrecipient of Federal funds (such as the prime or general contractor). "Lower Tier Participant" refers any participant who has entered into a covered transaction with a First Tier Participant or other Lower Tier Participants (such as subcontractors and suppliers).

e. The prospective lower tier participant agrees by submitting this proposal that, should the proposed covered transaction be entered into, it shall not knowingly enter into any lower tier covered transaction with a person who is debarred, suspended, declared ineligible, or voluntarily excluded from participation in this covered transaction, unless authorized by the department or agency with which this transaction originated. 2 CFR 1200.220 and 1200.332.

f. The prospective lower tier participant further agrees by submitting this proposal that it will include this clause titled "Certification Regarding Debarment, Suspension, Ineligibility and Voluntary Exclusion-Lower Tier Covered Transaction," without modification, in all lower tier covered transactions and in all solicitations for lower tier covered transactions exceeding the \$25,000 threshold. 2 CFR 180.220 and 1200.220.

g. A participant in a covered transaction may rely upon a certification of a prospective participant in a lower tier covered transaction that is not debarred, suspended, ineligible, or voluntarily excluded from the covered transaction, unless it knows that the certification is erroneous. A participant is responsible for ensuring that its principals are not suspended, debarred, or otherwise ineligible to participate in covered transactions. To verify the eligibility of its principals, as well as the eligibility of any lower tier prospective participants, each participant may, but is not required to, check the System for Award Management website (<https://www.sam.gov/>), which is compiled by the General Services Administration. 2 CFR 180.300, 180.320, 180.330, and 180.335.

h. Nothing contained in the foregoing shall be construed to require establishment of a system of records in order to render in good faith the certification required by this clause. The knowledge and information of participant is not required to exceed that which is normally possessed by a prudent person in the ordinary course of business dealings.

i. Except for transactions authorized under paragraph e of these instructions, if a participant in a covered transaction knowingly enters into a lower tier covered transaction with a person who is suspended, debarred, ineligible, or voluntarily excluded from participation in this transaction, in addition to other remedies available to the Federal Government, the department or agency with which this transaction originated may pursue available remedies, including suspension and/or debarment. 2 CFR 180.325.

Certification Regarding Debarment, Suspension, Ineligibility and Voluntary Exclusion--Lower Tier Participants:

1. The prospective lower tier participant certifies, by submission of this proposal, that neither it nor its principals:

(a) is presently debarred, suspended, proposed for debarment, declared ineligible, or voluntarily excluded from participating in covered transactions by any Federal department or agency, 2 CFR 180.355;

(b) is a corporation that has been convicted of a felony violation under any Federal law within the two-year period preceding this proposal (USDOT Order 4200.6 implementing appropriations act requirements); and

(c) is a corporation with any unpaid Federal tax liability that has been assessed, for which all judicial and administrative remedies have been exhausted, or have lapsed, and that is not being paid in a timely manner pursuant to an agreement with the authority responsible for collecting the tax liability. (USDOT Order 4200.6 implementing appropriations act requirements)

2. Where the prospective lower tier participant is unable to certify to any of the statements in this certification, such prospective participant should attach an explanation to this proposal.

XI. CERTIFICATION REGARDING USE OF CONTRACT FUNDS FOR LOBBYING

This provision is applicable to all Federal-aid construction contracts and to all related subcontracts which exceed \$100,000. 49 CFR Part 20, App. A.

1. The prospective participant certifies, by signing and submitting this bid or proposal, to the best of his or her knowledge and belief, that:

a. No Federal appropriated funds have been paid or will be paid, by or on behalf of the undersigned, to any person for influencing or attempting to influence an officer or employee of any Federal agency, a Member of Congress, an officer or employee of Congress, or an employee of a Member of Congress in connection with the awarding of any Federal contract, the making of any Federal grant, the making of any Federal loan, the entering into of any cooperative agreement, and the extension, continuation, renewal, amendment, or modification of any Federal contract, grant, loan, or cooperative agreement.

b. If any funds other than Federal appropriated funds have been paid or will be paid to any person for influencing or attempting to influence an officer or employee of any Federal agency, a Member of Congress, an officer or employee of Congress, or an employee of a Member of Congress in connection with this Federal contract, grant, loan, or cooperative agreement, the undersigned shall complete and submit Standard Form-LLL, "Disclosure Form to Report Lobbying," in accordance with its instructions.

2. This certification is a material representation of fact upon which reliance was placed when this transaction was made or entered into. Submission of this certification is a prerequisite for making or entering into this transaction imposed by 31 U.S.C. 1352. Any person who fails to file the required certification shall be subject to a civil penalty of not less than \$10,000 and not more than \$100,000 for each such failure.

3. The prospective participant also agrees by submitting its bid or proposal that the participant shall require that the language of this certification be included in all lower tier

subcontracts, which exceed \$100,000 and that all such recipients shall certify and disclose accordingly.

XII. USE OF UNITED STATES-FLAG VESSELS:

This provision is applicable to all Federal-aid construction contracts, design-build contracts, subcontracts, lower-tier subcontracts, purchase orders, lease agreements, or any other covered transaction. 46 CFR Part 381.

This requirement applies to material or equipment that is acquired for a specific Federal-aid highway project. 46 CFR 381.7. It is not applicable to goods or materials that come into inventories independent of an FHWA funded-contract.

When oceanic shipments (or shipments across the Great Lakes) are necessary for materials or equipment acquired for a specific Federal-aid construction project, the bidder, proposer, contractor, subcontractor, or vendor agrees:

1. To utilize privately owned United States-flag commercial vessels to ship at least 50 percent of the gross tonnage (computed separately for dry bulk carriers, dry cargo liners, and tankers) involved, whenever shipping any equipment, material, or commodities pursuant to this contract, to the extent such vessels are available at fair and reasonable rates for United States-flag commercial vessels. 46 CFR 381.7.
2. To furnish within 20 days following the date of loading for shipments originating within the United States or within 30 working days following the date of loading for shipments originating outside the United States, a legible copy of a rated, 'on-board' commercial ocean bill-of-lading in English for each shipment of cargo described in paragraph (b)(1) of this section to both the Contracting Officer (through the prime contractor in the case of subcontractor bills-of-lading) and to the Office of Cargo and Commercial Sealift (MAR-620), Maritime Administration, Washington, DC 20590. (MARAD requires copies of the ocean carrier's (master) bills of lading, certified onboard, dated, with rates and charges. These bills of lading may contain business sensitive information and therefore may be submitted directly to MARAD by the Ocean Transportation Intermediary on behalf of the contractor). 46 CFR 381.7.

Contract Provision - Cargo Preference Requirements

In accordance with Title 46 CFR § 381.7 (b), the contractor agrees—

“(1) To utilize privately owned United States-flag commercial vessels to ship at least 50 percent of the gross tonnage (computed separately for dry bulk carriers, dry cargo liners, and tankers) involved, whenever shipping any equipment, material, or commodities pursuant to this contract, to the extent such vessels are available at fair and reasonable rates for United States-flag commercial vessels.

(2) To furnish within 20 days following the date of loading for shipments originating within the United States or within 30 working days following the date of loading for shipments originating outside the United States, a legible copy of a rated, ‘on-board’ commercial ocean bill-of-lading in English for each shipment of cargo described in paragraph (b) (1) of this section to both the Contracting Officer (through the prime contractor in the case of subcontractor bills-of-lading) and to the Division of National Cargo, Office of Market Development, Maritime Administration, Washington, DC 20590.

(3) To insert the substance of the provisions of this clause in all subcontracts issued pursuant to this contract.”

Provisions (1) and (2) apply to materials or equipment that are acquired solely for the project. The two provisions do not apply to goods or materials that come into inventories independent of the project, such as shipments of Portland cement, asphalt cement, or aggregates, when industry suppliers and contractors use these materials to replenish existing inventories.

