

F.A.P. RTE.	SECTION	COUNTY	TOTAL SHEETS	SHEET NO.
310	(38-2)RS	MCDONOUGH	66	49
STA.		TO STA.		
FED. ROAD DIST. NO.		ILLINOIS FED. AID PROJECT		

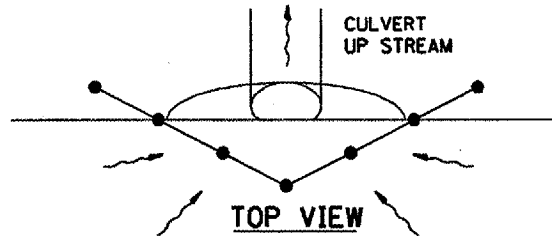

UPSTREAM PIPE CULVERT EROSION CONTROL

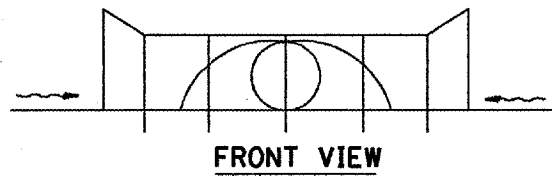
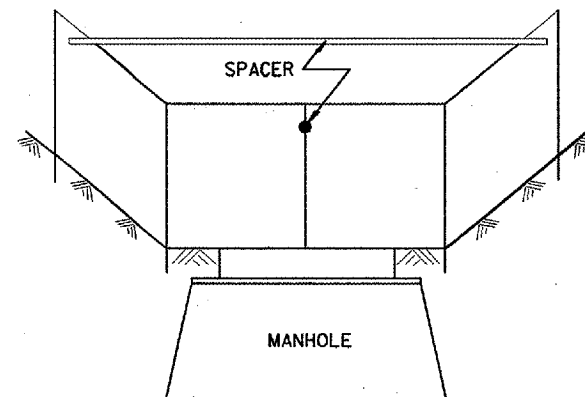
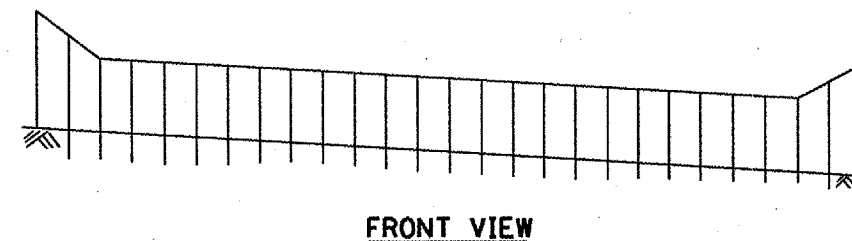
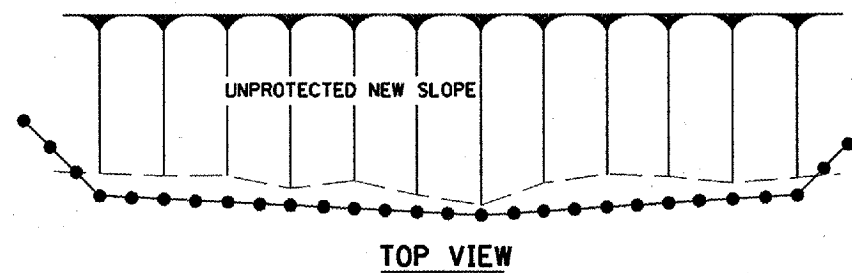
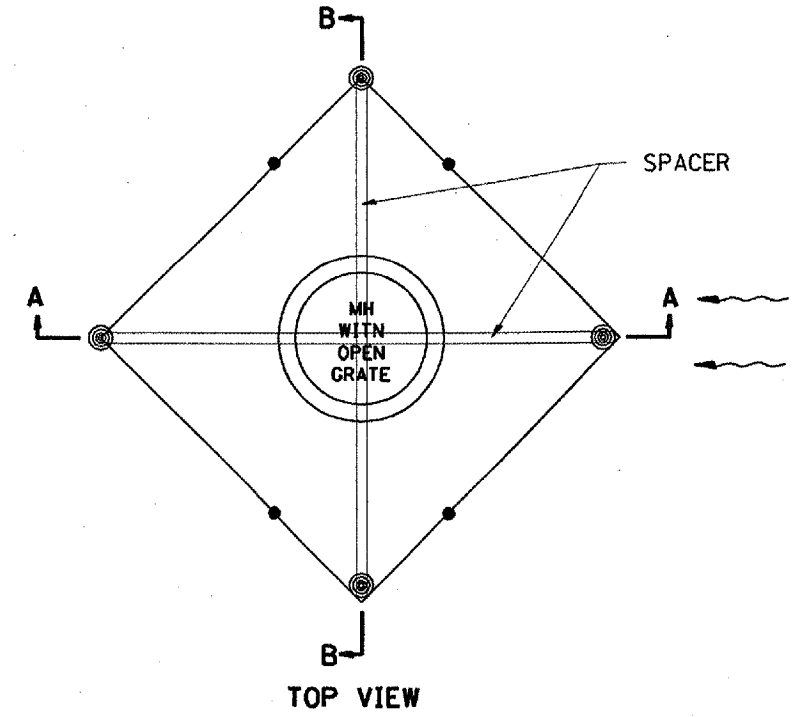
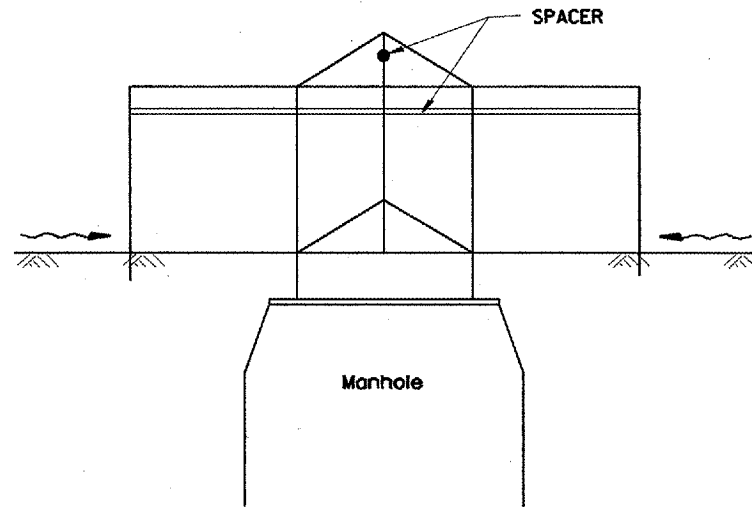

EROSION CONTROL AT OPEN GRATE MAN HOLE

GENERAL NOTES:

1. This work shall be performed in accordance with Sections 280 & 1081, of the Standard Specifications.
2. Additional Timber or Metal Post shall be installed, as needed.

All dimensions are in millimeters (Inches) unless otherwise noted.

ILLINOIS DEPARTMENT OF TRANSPORTATION

SPECIAL DETAIL SHEET

TYPICAL APPLICATION OF SILT FILTER FENCE

CADD DETAIL 280001-D4 SCALE: NOT DRAWN TO SCALE
DRAWN BY CADD CHECKED BY

DATE	REVISIONS	BY
1-1-97	RENUM. A-12.05, NEW REVISION BOX	T.P.
3-11-03	ELIMINATED SILT FENCE DITCH CHECK	M.M.A.

\$\$\$DATE\$\$\$