

If you plan to submit a bid directly to the Department of Transportation

PREQUALIFICATION

Any contractor who desires to become pre-qualified to bid on work advertised by IDOT must submit the properly completed pre-qualification forms to the Bureau of Construction no later than 4:30 p.m. prevailing time twenty-one days prior to the letting of interest. This pre-qualification requirement applies to first time contractors, contractors renewing expired ratings, contractors maintaining continuous pre-qualification or contractors requesting revised ratings. To be eligible to bid, existing pre-qualification ratings must be effective through the date of letting.

REQUESTS FOR AUTHORIZATION TO BID

Contractors downloading and/or ordering CD-ROM's and are wanting to bid on items included in a particular letting must submit the properly completed "Request for Authorization to Bid/or Not For Bid Status" (BDE 124INT) and the ORIGINAL, signed and notarized, "Affidavit of Availability" (BC 57) to the proper office no later than 4:30 p.m. prevailing time, three (3) days prior to the letting date.

WHO CAN BID ?

Bids will be accepted from only those companies that request and receive written **Authorization to Bid** from IDOT's Central Bureau of Construction.

WHAT CONSTITUTES WRITTEN AUTHORIZATION TO BID? When a prospective prime bidder submits a "Request for Authorization to Bid/or Not For Bid Status" (BDE 124INT) he/she must indicate at that time which items are being requested For Bidding purposes. Only those items requested For Bidding will be analyzed. After the request has been analyzed, the bidder will be issued a **Proposal Denial and/or Authorization Form**, approved by the Central Bureau of Construction, that indicates which items have been approved For Bidding. If **Authorization to Bid** cannot be approved, the **Proposal Denial and/or Authorization Form** will indicate the reason for denial.

ABOUT AUTHORIZATION TO BID: Firms that have not received an authorization form within a reasonable time of complete and correct original document submittal should contact the department as to status. This is critical in the week before the letting. These documents must be received three days before the letting date. Firms unsure as to authorization status should call the Prequalification Section of the Bureau of Construction at the number listed at the end of these instructions.

ADDENDA AND REVISIONS: It is the contractor's responsibility to determine which, if any, addenda or revisions pertain to any project they may be bidding. Failure to incorporate all relevant addenda or revisions may cause the bid to be declared unacceptable.

Each addendum will be placed with the contract number. Addenda and revisions will also be placed on the Addendum/Revision Checklist and each subscription service subscriber will be notified by e-mail of each addendum and revision issued.

The Internet is the Department's primary way of doing business. The subscription server e-mails are an added courtesy the Department provides. It is suggested that bidder check IDOT's website <http://www.dot.il.gov/desenv/delett.html> before submitting final bid information.

IDOT is not responsible for any e-mail related failures.

Addenda Questions may be directed to the Contracts Office at (217)782-7806 or D&Econtracts@dot.il.gov

Technical Questions about downloading these files may be directed to Tim Garman (217)524-1642 or garmantr@dot.il.gov.

WHAT MUST BE INCLUDED WHEN BIDS ARE SUBMITTED?: Bidders need not return the entire proposal when bids are submitted. That portion of the proposal that must be returned includes the following:

1. All documents from the Proposal Cover Sheet through the Proposal Bid Bond
2. Other special documentation and/or information that may be required by the contract special provisions

All proposal documents, including Proposal Guaranty Checks or Proposal Bid Bonds, should be stapled together to prevent loss when bids are processed by IDOT personnel.

ABOUT SUBMITTING BIDS: It is recommended that bidders deliver bids in person to insure they arrive at the proper location prior to the time specified for the receipt of bids. Any bid received at the place of letting after the time specified will not be accepted.

WHO SHOULD BE CALLED IF ASSISTANCE IS NEEDED?

Questions Regarding	Call
Prequalification and/or Authorization to Bid	(217)782-3413
Preparation and submittal of bids	(217)782-7806
Mailing of plans and proposals	(217)782-7806
Electronic plans and proposals	(217)524-1642

ADDENDUMS AND REVISIONS TO THE PROPOSAL FORMS

Planholders should verify that they have received and incorporated the addendum and/or revision prior to submitting their bid. Failure by the bidder to include an addendum could result in a bid being rejected as irregular.

RETURN WITH BID

100

Proposal Submitted By
Name
Address
City

Letting June 17, 2005

BIDDERS NEED NOT RETURN THE ENTIRE PROPOSAL
(See instructions inside front cover)

NOTICE TO PROSPECTIVE BIDDERS
 This proposal can be used for bidding purposes
 by only those companies that request and receive
 written AUTHORIZATION TO BID from IDOT's
 Central Bureau of Construction.
 (SEE INSTRUCTIONS ON THE INSIDE OF COVER)

Notice To Bidders, Specifications, Proposal, Contract and Contract Bond



**Illinois Department
 of Transportation**

Springfield, Illinois 62764

**Contract No. 76909
 MADISON County
 Section 52RS-2,52-I
 District 8 Construction Funds
 Route FAS 777**

PLEASE MARK THE APPROPRIATE BOX BELOW:

A Bid Bond is included.

A Cashier's Check or a Certified Check is included.

Plans Included
 Herein

Prepared by	S
Checked by	

(Printed by authority of the State of Illinois)

INSTRUCTIONS

ABOUT IDOT PROPOSALS: All proposals issued by IDOT are potential bidding proposals. Each proposal contains all Certifications and Affidavits, a Proposal Signature Sheet and a Proposal Bid Bond required for Prime Contractors to submit a bid after written **Authorization to Bid** has been issued by IDOT's Central Bureau of Construction.

WHO CAN BID?: Bids will be accepted from only those companies that request and receive written **Authorization to Bid** from IDOT's Central Bureau of Construction. To request authorization, a potential bidder must complete and submit Part B of the Request for Authorization to Bid/or Not For Bid Status form (BDE 124 INT) and submit an original Affidavit of Availability (BC 57).

WHAT CONSTITUTES WRITTEN AUTHORIZATION TO BID?: When a prospective prime bidder submits a "Request for Proposal Forms and Plans" he/she must indicate at that time which items are being requested For Bidding purposes. Only those items requested For Bidding will be analyzed. After the request has been analyzed, the bidder will be issued a **Proposal Denial and/or Authorization Form**, approved by the Central Bureau of Construction, that indicates which items have been approved For Bidding. If **Authorization to Bid** cannot be approved, the **Proposal Denial and/or Authorization Form** will indicate the reason for denial. If a contractor has requested to bid but has not received a **Proposal Denial and/or Authorization Form**, they should contact the Central Bureau of Construction in advance of the letting date.

WHAT MUST BE INCLUDED WHEN BIDS ARE SUBMITTED?: Bidders need not return the entire proposal when bids are submitted. That portion of the proposal that must be returned includes the following:

1. All documents from the Proposal Cover Sheet through the Proposal Bid Bond
2. Other special documentation and/or information that may be required by the contract special provisions

All proposal documents, including Proposal Guaranty Checks or Proposal Bid Bonds, should be stapled together to prevent loss when bids are processed by IDOT personnel.

ABOUT SUBMITTING BIDS: It is recommended that bidders deliver bids in person to insure they arrive at the proper location prior to the time specified for the receipt of bids. Any bid received at the place of letting after the time specified will not be accepted.

WHO SHOULD BE CALLED IF ASSISTANCE IS NEEDED?

Questions Regarding	Call
Prequalification and/or Authorization to Bid	217/782-3413
Preparation and submittal of bids	217/782-7806
Mailing of CD-ROMS	217/782-7806

RETURN WITH BID



PROPOSAL

TO THE DEPARTMENT OF TRANSPORTATION

1. Proposal of _____

for the improvement identified and advertised for bids in the Invitation for Bids as:

**Contract No. 76909
MADISON County
Section 52RS-2,52-I
Route FAS 777
District 8 Construction Funds**

Construction of bituminous shoulders, gutter replacement and 18 ft and variable width bituminous concrete surface on New Douglas Road from I-55 to New Douglas.

2. The undersigned bidder will furnish all labor, material and equipment to complete the above described project in a good and workmanlike manner as provided in the contract documents provided by the Department of Transportation. This proposal will become part of the contract and the terms and conditions contained in the contract documents shall govern performance and payments.

RETURN WITH BID

3. **ASSURANCE OF EXAMINATION AND INSPECTION/WAIVER.** The undersigned further declares that he/she has carefully examined the proposal, plans, specifications, form of contract and contract bond, and special provisions, and that he/she has inspected in detail the site of the proposed work, and that he/she has familiarized themselves with all of the local conditions affecting the contract and the detailed requirements of construction, and understands that in making this proposal he/she waives all right to plead any misunderstanding regarding the same.
4. **EXECUTION OF CONTRACT AND CONTRACT BOND.** The undersigned further agrees to execute a contract for this work and present the same to the department within fifteen (15) days after the contract has been mailed to him/her. The undersigned further agrees that he/she and his/her surety will execute and present within fifteen (15) days after the contract has been mailed to him/her contract bond satisfactory to and in the form prescribed by the Department of Transportation, in the penal sum of the full amount of the contract, guaranteeing the faithful performance of the work in accordance with the terms of the contract.
5. **PROPOSAL GUARANTY.** Accompanying this proposal is either a bid bond on the department form, executed by a corporate surety company satisfactory to the department, or a proposal guaranty check consisting of a bank cashier's check or a properly certified check for not less than 5 per cent of the amount bid or for the amount specified in the following schedule:

<u>Amount of Bid</u>		<u>Proposal Guaranty</u>	<u>Amount of Bid</u>		<u>Proposal Guaranty</u>	
Up to	\$5,000	\$150	\$2,000,000	to	\$3,000,000	\$100,000
\$5,000	to \$10,000	\$300	\$3,000,000	to	\$5,000,000	\$150,000
\$10,000	to \$50,000	\$1,000	\$5,000,000	to	\$7,500,000	\$250,000
\$50,000	to \$100,000	\$3,000	\$7,500,000	to	\$10,000,000	\$400,000
\$100,000	to \$150,000	\$5,000	\$10,000,000	to	\$15,000,000	\$500,000
\$150,000	to \$250,000	\$7,500	\$15,000,000	to	\$20,000,000	\$600,000
\$250,000	to \$500,000	\$12,500	\$20,000,000	to	\$25,000,000	\$700,000
\$500,000	to \$1,000,000	\$25,000	\$25,000,000	to	\$30,000,000	\$800,000
\$1,000,000	to \$1,500,000	\$50,000	\$30,000,000	to	\$35,000,000	\$900,000
\$1,500,000	to \$2,000,000	\$75,000	over		\$35,000,000	\$1,000,000

Bank cashier's checks or properly certified checks accompanying proposals shall be made payable to the Treasurer, State of Illinois, when the state is awarding authority; the county treasurer, when a county is the awarding authority; or the city, village, or town treasurer, when a city, village, or town is the awarding authority.

If a combination bid is submitted, the proposal guaranties which accompany the individual proposals making up the combination will be considered as also covering the combination bid.

The amount of the proposal guaranty check is _____ \$(_____). If this proposal is accepted and the undersigned shall fail to execute a contract bond as required herein, it is hereby agreed that the amount of the proposal guaranty shall become the property of the State of Illinois, and shall be considered as payment of damages due to delay and other causes suffered by the State because of the failure to execute said contract and contract bond; otherwise, the bid bond shall become void or the proposal guaranty check shall be returned to the undersigned.

Attach Cashier's Check or Certified Check Here

In the event that one proposal guaranty check is intended to cover two or more proposals, the amount must be equal to the sum of the proposal guaranties which would be required for each individual proposal. If the guaranty check is placed in another proposal, state below where it may be found.

The proposal guaranty check will be found in the proposal for:

Item _____

Section No. _____

County _____

Mark the proposal cover sheet as to the type of proposal guaranty submitted.

RETURN WITH BID

6. **COMBINATION BIDS.** The undersigned further agrees that if awarded the contract for the sections contained in the following combination, he/she will perform the work in accordance with the requirements of each individual proposal comprising the combination bid specified in the schedule below, and that the combination bid shall be prorated against each section in proportion to the bid submitted for the same. If an error is found to exist in the gross sum bid for one or more of the individual sections included in a combination, the combination bid shall be corrected as provided in the specifications.

When a combination bid is submitted, the schedule below must be completed in each proposal comprising the combination.

If alternate bids are submitted for one or more of the sections comprising the combination, a combination bid must be submitted for each alternate.

Schedule of Combination Bids

Combination No.	Sections Included in Combination	Combination Bid	
		Dollars	Cents

7. **SCHEDULE OF PRICES.** The undersigned bidder submits herewith, in accordance with the rules and instructions, a schedule of prices for the items of work for which bids are sought. The unit prices bid are in U.S. dollars and cents, and all extensions and summations have been made. The bidder understands that the quantities appearing in the bid schedule are approximate and are provided for the purpose of obtaining a gross sum for the comparison of bids. If there is an error in the extension of the unit prices, the unit prices shall govern. Payment to the contractor awarded the contract will be made only for actual quantities of work performed and accepted or materials furnished according to the contract. The scheduled quantities of work to be done and materials to be furnished may be increased, decreased or omitted as provided elsewhere in the contract.

8. **CERTIFICATE OF AUTHORITY.** The undersigned bidder, if a business organized under the laws of another State, assures the Department that it will furnish a copy of its certificate of authority to do business in the State of Illinois with the return of the executed contract and bond. Failure to furnish the certificate within the time provided for execution of an awarded contract may be cause for cancellation of the award and forfeiture of the proposal guaranty to the State.

ILLINOIS DEPARTMENT OF TRANSPORTATION
 SCHEDULE OF PRICES
 CONTRACT
 NUMBER - 76909

State Job # - C-98-070-05
 PPS NBR - 0-00856-8005
 County Name - MADISON - -
 Code - 119 - -
 District - 8 - -
 Section Number - 52RS-2, 52-I

Project Number

Route
 FAS 777

Item Number	Pay Item Description	Unit of Measure	Quantity	x	Unit Price	=	Total Price
X4066416	BC SC SUPER "C" N70	TON	1,972.000				
X4066770	LEV BIND MM SUPER N70	TON	1,031.000				
20200600	EXC & GR EX SHOULDER	UNIT	338.000				
25000210	SEEDING CL 2A	ACRE	0.900				
25000400	NITROGEN FERT NUTR	POUND	86.000				
25000500	PHOSPHORUS FERT NUTR	POUND	86.000				
25000600	POTASSIUM FERT NUTR	POUND	86.000				
25100110	MULCH METHOD 1	TON	1.800				
40600200	BIT MATLS PR CT	TON	8.100				
40600300	AGG PR CT	TON	38.000				
40600980	BIT SURF REM BUTT JT	SQ YD	267.000				
40600985	PCC SURF REM BUTT JT	SQ YD	925.000				
40600990	TEMPORARY RAMP	SQ YD	190.000				
44002720	GUTTER REMOV SPL	FOOT	4,831.000				
48202000	BIT SHOULDERS SUPER	TON	202.000				

ILLINOIS DEPARTMENT OF TRANSPORTATION
 SCHEDULE OF PRICES
 CONTRACT
 NUMBER -

76909

State Job # - C-98-070-05
 PPS NBR - 0-00856-8005
 County Name - MADISON -
 Code - 119 - -
 District - 8 - -
 Section Number - 52RS-2, 52-I

Project Number

Route
 FAS 777

Item Number	Pay Item Description	Unit of Measure	Quantity	x	Unit Price	=	Total Price
48202600	BIT SHLD SUPER 8	SQ YD	11,413.000				
60600095	CLASS SI CONC OUTLET	CU YD	68.000				
60602700	CONC GUTTER TA SPL	FOOT	4,590.000				
67100100	MOBILIZATION	L SUM	1.000				
70100460	TRAF CONT-PROT 701306	L SUM	1.000				
70100500	TRAF CONT-PROT 701326	L SUM	1.000				
70103815	TR CONT SURVEILLANCE	CAL DA	24.000				
70300100	SHORT-TERM PAVT MKING	FOOT	1,091.000				
70300210	TEMP PVT MK LTR & SYM	SQ FT	94.000				
70300220	TEMP PVT MK LINE 4	FOOT	24,981.000				
70301000	WORK ZONE PAVT MK REM	SQ FT	8,603.000				
78001100	PT PVT MK LTRS & SYMB	SQ FT	94.000				
78001110	PAINT PVT MK LINE 4	FOOT	69,711.000				
78100100	RAISED REFL PAVT MKR	EACH	53.000				
78300200	RAISED REF PVT MK REM	EACH	53.000				

CONTRACT NUMBER

76909

THIS IS THE TOTAL BID

\$ _____

NOTES:

1. Each PAY ITEM should have a UNIT PRICE and a TOTAL PRICE.
2. The UNIT PRICE shall govern if no TOTAL PRICE is shown or if there is a discrepancy between the product of the UNIT PRICE multiplied by the QUANTITY.
3. If a UNIT PRICE is omitted, the TOTAL PRICE will be divided by the QUANTITY in order to establish a UNIT PRICE.
4. A bid may be declared UNACCEPTABLE if neither a unit price nor a total price is shown.

RETURN WITH BID

STATE REQUIRED ETHICAL STANDARDS GOVERNING CONTRACT PROCUREMENT: ASSURANCES, CERTIFICATIONS AND DISCLOSURES

I. GENERAL

A. Article 50 of the Illinois Procurement Code establishes the duty of all State chief procurement officers, State purchasing officers, and their designees to maximize the value of the expenditure of public moneys in procuring goods, services, and contracts for the State of Illinois and to act in a manner that maintains the integrity and public trust of State government. In discharging this duty, they are charged by law to use all available information, reasonable efforts, and reasonable actions to protect, safeguard, and maintain the procurement process of the State of Illinois.

B. In order to comply with the provisions of Article 50 and to carry out the duty established therein, all bidders are to adhere to ethical standards established for the procurement process, and to make such assurances, disclosures and certifications required by law. By execution of the Proposal Signature Sheet, the bidder indicates that each of the mandated assurances has been read and understood, that each certification is made and understood, and that each disclosure requirement has been understood and completed.

C. In addition to all other remedies provided by law, failure to comply with any assurance, failure to make any disclosure or the making of a false certification shall be grounds for termination of the contract and the suspension or debarment of the bidder.

II. ASSURANCES

A. The assurances hereinafter made by the bidder are each a material representation of fact upon which reliance is placed should the Department enter into the contract with the bidder. The Department may terminate the contract if it is later determined that the bidder rendered a false or erroneous assurance, and the surety providing the performance bond shall be responsible for the completion of the contract.

B. Felons

1. The Illinois Procurement Code provides:

Section 50-10. Felons. Unless otherwise provided, no person or business convicted of a felony shall do business with the State of Illinois or any state agency from the date of conviction until 5 years after the date of completion of the sentence for that felony, unless no person held responsible by a prosecutorial office for the facts upon which the conviction was based continues to have any involvement with the business.

2. The bidder assures the Department that the award and execution of the contract would not cause a violation of Section 50-10.

C. Conflicts of Interest

1. The Illinois Procurement Code provides in pertinent part:

Section 50-13. Conflicts of Interest.

(a) Prohibition. It is unlawful for any person holding an elective office in this State, holding a seat in the General Assembly, or appointed to or employed in any of the offices or agencies of state government and who receives compensation for such employment in excess of 60% of the salary of the Governor of the State of Illinois, or who is an officer or employee of the Capital Development Board or the Illinois Toll Highway Authority, or who is the spouse or minor child of any such person to have or acquire any contract, or any direct pecuniary interest in any contract therein, whether for stationery, printing, paper, or any services, materials, or supplies, that will be wholly or partially satisfied by the payment of funds appropriated by the General Assembly of the State of Illinois or in any contract of the Capital Development Board or the Illinois Toll Highway authority.

(b) Interests. It is unlawful for any firm, partnership, association or corporation, in which any person listed in subsection (a) is entitled to receive (i) more than 7 1/2% of the total distributable income or (ii) an amount in excess of the salary of the Governor, to have or acquire any such contract or direct pecuniary interest therein.

(c) Combined interests. It is unlawful for any firm, partnership, association, or corporation, in which any person listed in subsection (a) together with his or her spouse or minor children is entitled to receive (i) more than 15%, in the aggregate, of the total distributable income or (ii) an amount in excess of 2 times the salary of the Governor, to have or acquire any such contract or direct pecuniary interest therein.

(d) Securities. Nothing in this Section invalidates the provisions of any bond or other security previously offered or to be offered for sale or sold by or for the State of Illinois.

(e) Prior interests. This Section does not affect the validity of any contract made between the State and an officer or employee of the State or member of the General Assembly, his or her spouse, minor child or any combination of those persons if that contract was in existence before his or her election or employment as an officer, member, or employee. The contract is voidable, however, if it cannot be completed within 365 days after the officer, member, or employee takes office or is employed.

The current salary of the Governor is \$150,700.00. Sixty percent of the salary is \$90,420.00.

RETURN WITH BID

2. The bidder assures the Department that the award and execution of the contract would not cause a violation of Section 50-13, or that an effective exemption has been issued by the Board of Ethics to any individual subject to the Section 50-13 prohibitions pursuant to the provisions of Section 50-20 of the Code and Executive Order Number 3 (1998). Information concerning the exemption process is available from the Department upon request.

D. Negotiations

1. The Illinois Procurement Code provides in pertinent part:

Section 50-15. Negotiations.

(a) It is unlawful for any person employed in or on a continual contractual relationship with any of the offices or agencies of State government to participate in contract negotiations on behalf of that office or agency with any firm, partnership, association, or corporation with whom that person has a contract for future employment or is negotiating concerning possible future employment.

2. The bidder assures the Department that the award and execution of the contract would not cause a violation of Section 50-15, and that the bidder has no knowledge of any facts relevant to the kinds of acts prohibited therein.

E. Inducements

1. The Illinois Procurement Code provides:

Section 50-25. Inducement. Any person who offers or pays any money or other valuable thing to any person to induce him or her not to bid for a State contract or as recompense for not having bid on a State contract is guilty of a Class 4 felony. Any person who accepts any money or other valuable thing for not bidding for a State contract or who withholds a bid in consideration of the promise for the payment of money or other valuable thing is guilty of a Class 4 felony.

2. The bidder assures the Department that the award and execution of the contract would not cause a violation of Section 50-25, and that the bidder has no knowledge of any facts relevant to the kinds of acts prohibited therein.

F. Revolving Door Prohibition

1. The Illinois Procurement Code provides:

Section 50-30. Revolving door prohibition. Chief procurement officers, associate procurement officers, State purchasing officers, their designees whose principal duties are directly related to State procurement, and executive officers confirmed by the Senate are expressly prohibited for a period of 2 years after terminating an affected position from engaging in any procurement activity relating to the State agency most recently employing them in an affected position for a period of at least 6 months. The prohibition includes, but is not limited to: lobbying the procurement process; specifying; bidding; proposing bid, proposal, or contract documents; on their own behalf or on behalf of any firm, partnership, association, or corporation. This Section applies only to persons who terminate an affected position on or after January 15, 1999.

2. The bidder assures the Department that the award and execution of the contract would not cause a violation of Section 50-30, and that the bidder has no knowledge of any facts relevant to the kinds of acts prohibited therein.

G. Reporting Anticompetitive Practices

1. The Illinois Procurement Code provides:

Section 50-40. Reporting anticompetitive practices. When, for any reason, any vendor, bidder, contractor, chief procurement officer, State purchasing officer, designee, elected official, or State employee suspects collusion or other anticompetitive practice among any bidders, offerors, contractors, proposers, or employees of the State, a notice of the relevant facts shall be transmitted to the Attorney General and the chief procurement officer.

2. The bidder assures the Department that it has not failed to report any relevant facts concerning the practices addressed in Section 50-40 which may involve the contract for which the bid is submitted.

H. Confidentiality

1. The Illinois Procurement Code provides:

Section 50-45. Confidentiality. Any chief procurement officer, State purchasing officer, designee, or executive officer who willfully uses or allows the use of specifications, competitive bid documents, proprietary competitive information, proposals, contracts, or selection information to compromise the fairness or integrity of the procurement, bidding, or contract process shall be subject to immediate dismissal, regardless of the Personnel code, any contract, or any collective bargaining agreement, and may in addition be subject to criminal prosecution.

2. The bidder assures the Department that it has no knowledge of any fact relevant to the practices addressed in Section 50-45 which may involve the contract for which the bid is submitted.

RETURN WITH BID

I. Insider Information

1. The Illinois Procurement Act provides:

Section 50-50. Insider information. It is unlawful for any current or former elected or appointed State official or State employee to knowingly use confidential information available only by virtue of that office or employment for actual or anticipated gain for themselves or another person.

2. The bidder assures the Department that it has no knowledge of any facts relevant to the practices addressed in Section 50-50 which may involve the contract for which the bid is submitted.

III. CERTIFICATIONS

A. The certifications hereinafter made by the bidder are each a material representation of fact upon which reliance is placed should the Department enter into the contract with the bidder. The Department may terminate the contract if it is later determined that the bidder rendered a false or erroneous certification, and the surety providing the performance bond shall be responsible for completion of the contract.

B. Bribery

1. The Illinois Procurement Code provides:

Section 50-5. Bribery.

(a) Prohibition. No person or business shall be awarded a contract or subcontract under this Code who:

(1) has been convicted under the laws of Illinois or any other state of bribery or attempting to bribe an officer or employee of the State of Illinois or any other state in that officer's or employee's official capacity; or

(2) has made an admission of guilt of that conduct that is a matter of record but has not been prosecuted for that conduct.

(b) Businesses. No business shall be barred from contracting with any unit of State or local government as a result of a conviction under this Section of any employee or agent of the business if the employee or agent is no longer employed by the business and:

(1) the business has been finally adjudicated not guilty; or

(2) the business demonstrates to the governmental entity with which it seeks to contract, and that entity finds that the commission of the offense was not authorized, requested, commanded, or performed by a director, officer, or high managerial agent on behalf of the business as provided in paragraph (2) of subsection (a) of Section 5-4 of the Criminal Code of 1961.

(c) Conduct on behalf of business. For purposes of this Section, when an official, agent, or employee of a business committed the bribery or attempted bribery on behalf of the business and in accordance with the direction or authorization of a responsible official of the business, the business shall be chargeable with the conduct.

(d) Certification. Every bid submitted to and contract executed by the State shall contain a certification by the contractor that the contractor is not barred from being awarded a contract or subcontract under this Section. A contractor who makes a false statement, material to the certification, commits a Class 3 felony.

2. The bidder certifies that it is not barred from being awarded a contract under Section 50.5.

C. Educational Loan

1. Section 3 of the Educational Loan Default Act provides:

§ 3. No State agency shall contract with an individual for goods or services if that individual is in default, as defined in Section 2 of this Act, on an educational loan. Any contract used by any State agency shall include a statement certifying that the individual is not in default on an educational loan as provided in this Section.

2. The bidder, if an individual as opposed to a corporation, partnership or other form of business organization, certifies that the bidder is not in default on an educational loan as provided in Section 3 of the Act.

D. Bid-Rigging/Bid Rotating

1. Section 33E-11 of the Criminal Code of 1961 provides:

§ 33E-11. (a) Every bid submitted to and public contract executed pursuant to such bid by the State or a unit of local government shall contain a certification by the prime contractor that the prime contractor is not barred from contracting with any unit of State or local government as a result of a violation of either Section 33E-3 or 33E-4 of this Article. The State and units of local government shall provide the appropriate forms for such certification.

RETURN WITH BID

(b) A contractor who makes a false statement, material to the certification, commits a Class 3 felony.

A violation of Section 33E-3 would be represented by a conviction of the crime of bid-rigging which, in addition to Class 3 felony sentencing, provides that any person convicted of this offense or any similar offense of any state or the United States which contains the same elements as this offense shall be barred for 5 years from the date of conviction from contracting with any unit of State or local government. No corporation shall be barred from contracting with any unit of State or local government as a result of a conviction under this Section of any employee or agent of such corporation if the employee so convicted is no longer employed by the corporation and: (1) it has been finally adjudicated not guilty or (2) if it demonstrates to the governmental entity with which it seeks to contract and that entity finds that the commission of the offense was neither authorized, requested, commanded, nor performed by a director, officer or a high managerial agent in behalf of the corporation.

A violation of Section 33E-4 would be represented by a conviction of the crime of bid-rotating which, in addition to Class 2 felony sentencing, provides that any person convicted of this offense or any similar offense of any state or the United States which contains the same elements as this offense shall be permanently barred from contracting with any unit of State or local government. No corporation shall be barred from contracting with any unit of State or local government as a result of a conviction under this Section of any employee or agent of such corporation if the employee so convicted is no longer employed by the corporation and: (1) it has been finally adjudicated not guilty or (2) if it demonstrates to the governmental entity with which it seeks to contract and that entity finds that the commission of the offense was neither authorized, requested, commanded, nor performed by a director, officer or a high managerial agent in behalf of the corporation.

2. The bidder certifies that it is not barred from contracting with the Department by reason of a violation of either Section 33E-3 or Section 33E-4.

E. International Anti-Boycott

1. Section 5 of the International Anti-Boycott Certification Act provides:

§ 5. State contracts. Every contract entered into by the State of Illinois for the manufacture, furnishing, or purchasing of supplies, material, or equipment or for the furnishing of work, labor, or services, in an amount exceeding the threshold for small purchases according to the purchasing laws of this State or \$10,000.00, whichever is less, shall contain certification, as a material condition of the contract, by which the contractor agrees that neither the contractor nor any substantially-owned affiliated company is participating or shall participate in an international boycott in violation of the provisions of the U.S. Export Administration Act of 1979 or the regulations of the U.S. Department of Commerce promulgated under that Act.

2. The bidder makes the certification set forth in Section 5 of the Act.

F. Drug Free Workplace

1. The Illinois "Drug Free Workplace Act" applies to this contract and it is necessary to comply with the provisions of the "Act" if the contractor is a corporation, partnership, or other entity (including a sole proprietorship) which has 25 or more employees.

2. The bidder certifies that if awarded a contract in excess of \$5,000 it will provide a drug free workplace by:

(a) Publishing a statement notifying employees that the unlawful manufacture, distribution, dispensation, possession or use of a controlled substance, including cannabis, is prohibited in the contractor's workplace; specifying the actions that will be taken against employees for violations of such prohibition; and notifying the employee that, as a condition of employment on such contract, the employee shall abide by the terms of the statement, and notify the employer of any criminal drug statute conviction for a violation occurring in the workplace no later than five (5) days after such conviction.

(b) Establishing a drug free awareness program to inform employees about the dangers of drug abuse in the workplace; the contractor's policy of maintaining a drug free workplace; any available drug counseling, rehabilitation, and employee assistance programs; and the penalties that may be imposed upon employees for drug violations.

(c) Providing a copy of the statement required by subparagraph (1) to each employee engaged in the performance of the contract and to post the statement in a prominent place in the workplace.

(d) Notifying the Department within ten (10) days after receiving notice from an employee or otherwise receiving actual notice of the conviction of an employee for a violation of any criminal drug statute occurring in the workplace.

(e) Imposing or requiring, within 30 days after receiving notice from an employee of a conviction or actual notice of such a conviction, an appropriate personnel action, up to and including termination, or the satisfactory participation in a drug abuse assistance or rehabilitation program approved by a federal, state or local health, law enforcement or other appropriate agency.

(f) Assisting employees in selecting a course of action in the event drug counseling, treatment, and rehabilitation is required and indicating that a trained referral team is in place.

(g) Making a good faith effort to continue to maintain a drug free workplace through implementation of the actions and efforts stated in this certification.

G. Debt Delinquency

1. The Illinois Procurement Code provides:

Section 50-11 and 50-12. Debt Delinquency.

The contractor or bidder certifies that it, or any affiliate, is not barred from being awarded a contract under 30 ILCS 500. Section 50-11 prohibits a person from entering into a contract with a State agency if it knows or should know that it, or any affiliate, is delinquent in the payment of any debt to the State as defined by the Debt Collection Board. Section 50-12 prohibits a person from entering into a contract with a State agency if it, or any affiliate, has failed to collect and remit Illinois Use Tax on all sales of tangible personal property into the State of Illinois in accordance with the provisions of the Illinois Use Tax Act. The contractor further acknowledges that the contracting State agency may declare the contract void if this certification is false or if the contractor, or any affiliate, is determined to be delinquent in the payment of any debt to the State during the term of the contract.

H. Sarbanes-Oxley Act of 2002

1. The Illinois Procurement Code provides:

Section 50-60(c).

The contractor certifies in accordance with 30 ILCS 500/50-10.5 that no officer, director, partner or other managerial agent of the contracting business has been convicted of a felony under the Sarbanes-Oxley Act of 2002 or a Class 3 or Class 2 felony under the Illinois Securities Law of 1953 for a period of five years prior to the date of the bid or contract. The contractor acknowledges that the contracting agency shall declare the contract void if this certification is false.

I. ADDENDA

The contractor or bidder certifies that all relevant addenda have been incorporated in to this contract. Failure to do so may cause the bid to be declared unacceptable.

J. Section 42 of the Environmental Protection Act

The contractor certifies in accordance with 30 ILCS 500/50-12 that the bidder or contractor is not barred from being awarded a contract under this Section which prohibits the bidding on or entering into contracts with the State of Illinois or a State agency by a person or business found by a court or the Pollution Control Board to have committed a willful or knowing violation of Section 42 of the Environmental Protection Act for a period of five years from the date of the order. The contractor acknowledges that the contracting agency may declare the contract void if this certification is false.

K. Apprenticeship and Training Certification (Does not apply to federal aid projects)

In accordance with the provisions of Section 30-22 (6) of the Illinois Procurement Code, the bidder certifies that it is a participant, either as an individual or as part of a group program, in the approved apprenticeship and training programs applicable to each type of work or craft that the bidder will perform with its own forces. The bidder further certifies for work that will be performed by subcontract that each of its subcontractors submitted for approval either (a) is, at the time of such bid, participating in an approved, applicable apprenticeship and training program; or (b) will, prior to commencement of performance of work pursuant to this contract, begin participation in an approved apprenticeship and training program applicable to the work of the subcontract. The Department, at any time before or after award, may require the production of a copy of each applicable Certificate of Registration issued by the United States Department of Labor evidencing such participation by the contractor and any or all of its subcontractors. Applicable apprenticeship and training programs are those that have been approved and registered with the United States Department of Labor. The bidder shall list in the space below, the official name of the program sponsor holding the Certificate of Registration for all of the types of work or crafts in which the bidder is a participant and that will be performed with the bidder's forces. Types of work or craft work that will be subcontracted shall be included and listed as subcontract work. The list shall also indicate any type of work or craft job category that does not have an applicable apprenticeship or training program. **The bidder is responsible for making a complete report and shall make certain that each type of work or craft job category that will be utilized on the project as reported on the Construction Employee Workforce Projection (Form BC-1256) and returned with the bid is accounted for and listed.**

The requirements of this certification and disclosure are a material part of the contract, and the contractor shall require this certification provision to be included in all approved subcontracts. In order to fulfill this requirement, it shall not be necessary that an applicable program sponsor be currently taking or that it will take applications for apprenticeship, training or employment during the performance of the work of this contract.

TO BE RETURNED WITH BID

IV. DISCLOSURES

A. The disclosures hereinafter made by the bidder are each a material representation of fact upon which reliance is placed should the Department enter into the contract with the bidder. The Department may terminate the contract if it is later determined that the bidder rendered a false or erroneous disclosure, and the surety providing the performance bond shall be responsible for completion of the contract.

B. Financial Interests and Conflicts of Interest

1. Section 50-35 of the Illinois Procurement Code provides that all bids of more than \$10,000 shall be accompanied by disclosure of the financial interests of the bidder. This disclosed information for the successful bidder, will be maintained as public information subject to release by request pursuant to the Freedom of Information Act.

The financial interests to be disclosed shall include ownership or distributive income share that is in excess of 5%, or an amount greater than 60% of the annual salary of the Governor, of the bidding entity or its parent entity, whichever is less, unless the contractor or bidder is a publicly traded entity subject to Federal 10K reporting, in which case it may submit its 10K disclosure in place of the prescribed disclosure. If a bidder is a privately held entity that is exempt from Federal 10K reporting, but has more than 400 shareholders, it may submit the information that Federal 10K companies are required to report, and list the names of any person or entity holding any ownership share that is in excess of 5%. The disclosure shall include the names, addresses, and dollar or proportionate share of ownership of each person making the disclosure, their instrument of ownership or beneficial relationship, and notice of any potential conflict of interest resulting from the current ownership or beneficial interest of each person making the disclosure having any of the relationships identified in Section 50-35 and on the disclosure form.

In addition, all disclosures shall indicate any other current or pending contracts, proposals, leases, or other ongoing procurement relationships the bidding entity has with any other unit of state government and shall clearly identify the unit and the contract, proposal, lease, or other relationship.

2. Disclosure Forms. Disclosure Form A is attached for use concerning the individuals meeting the above ownership or distributive share requirements. Subject individuals should be covered each by one form. In addition, a second form (Disclosure Form B) provides for the disclosure of current or pending procurement relationships with other (non-IDOT) state agencies. **The forms must be included with each bid or incorporated by reference.**

C. Disclosure Form Instructions

Form A: For bidders that have previously submitted the information requested in Form A

The Department has retained the Form A disclosures submitted by all bidders responding to these requirements for the April 24, 1998 or any subsequent letting conducted by the Department. The bidder has the option of submitting the information again or the bidder may sign the following certification statement indicating that the information previously submitted by the bidder is, as of the date of signature, current and accurate. The Certification must be signed and dated by a person who is authorized to execute contracts for the bidding company. Before signing this certification, the bidder should carefully review its prior submissions to ensure the Certification is correct. If the Bidder signs the Certification, the Bidder should proceed to Form B instructions.

CERTIFICATION STATEMENT

I have determined that the Form A disclosure information previously submitted is current and accurate, and all forms are hereby incorporated by reference in this bid. Any necessary additional forms or amendments to previously submitted forms are attached to this bid.

(Bidding Company)

Name of Authorized Representative (type or print)

Title of Authorized Representative (type or print)

Signature of Authorized Representative

Date

Form A: For bidders who have NOT previously submitted the information requested in Form A

If the bidder is a publicly traded entity subject to Federal 10K reporting, the 10K Report may be submitted to meet the requirements of Form A. If a bidder is a privately held entity that is exempt from Federal 10K reporting, but has more than 400 shareholders, it may submit the information that Federal 10K companies are required to report, and list the names of any person or entity holding any ownership share that is in excess of 5%. If a bidder is not subject to Federal 10K reporting, the bidder must determine if any individuals are required by law to complete a financial disclosure form. To do this, the bidder should answer each of the following questions. A "YES" answer indicates Form A must be completed. If the answer to each of the following questions is "NO", then the NOT APPLICABLE STATEMENT on the second page of Form A must be signed and dated by a person that is authorized to execute contracts for the bidding company. Note: These questions are for assistance only and are not required to be completed.

1. Does anyone in your organization have a direct or beneficial ownership share of greater than 5% of the bidding entity or parent entity? YES ___ NO ___
2. Does anyone in your organization have a direct or beneficial ownership share of less than 5%, but which has a value greater than \$90,420.00? YES ___ NO ___
3. Does anyone in your organization receive more than \$90,420.00 of the bidding entity's or parent entity's distributive income? (Note: Distributive income is, for these purposes, any type of distribution of profits. An annual salary is not distributive income.) YES ___ NO ___
4. Does anyone in your organization receive greater than 5% of the bidding entity's or parent entity's total distributive income, but which is less than \$90,420.00? YES ___ NO ___

(Note: Only one set of forms needs to be completed per person per bid even if a specific individual would require a yes answer to more than one question.)

A "YES" answer to any of these questions requires the completion of Form A. The bidder must determine each individual in the bidding entity or the bidding entity's parent company that would cause the questions to be answered "Yes". Each form must be signed and dated by a person that is authorized to execute contracts for your organization. **Photocopied or stamped signatures are not acceptable.** The person signing can be, but does not have to be, the person for which the form is being completed. The bidder is responsible for the accuracy of any information provided.

If the answer to each of the above questions is "NO", then the NOT APPLICABLE STATEMENT on page 2 of Form A must be signed and dated by a person that is authorized to execute contracts for your company.

Form B: Identifying Other Contracts & Procurement Related Information Disclosure Form B must be completed for each bid submitted by the bidding entity. It must be signed by an individual who is authorized to execute contracts for the bidding entity. *Note: Signing the NOT APPLICABLE STATEMENT on Form A does not allow the bidder to ignore Form B. Form B must be completed, signed and dated or the bidder may be considered nonresponsive and the bid will not be accepted.*

The Bidder shall identify, by checking Yes or No on Form B, whether it has any pending contracts (including leases), bids, proposals, or other ongoing procurement relationship with any other (non-IDOT) State of Illinois agency. If "No" is checked, the bidder only needs to complete the signature box on the bottom of Form B. If "Yes" is checked, the bidder must do one of the following:

Option I: If the bidder did not submit an Affidavit of Availability to obtain authorization to bid, the bidder must list all non-IDOT State of Illinois agency pending contracts, leases, bids, proposals, and other ongoing procurement relationships. These items may be listed on Form B or on an attached sheet(s). Do not include IDOT contracts. Contracts with cities, counties, villages, etc. are not considered State of Illinois agency contracts and are not to be included. Contracts with other State of Illinois agencies such as the Department of Natural Resources or the Capital Development Board must be included. Bidders who submit Affidavits of Availability are suggested to use Option II.

Option II: If the bidder is required and has submitted an Affidavit of Availability in order to obtain authorization to bid, the bidder may write or type "See Affidavit of Availability" which indicates that the Affidavit of Availability is incorporated by reference and includes all non-IDOT State of Illinois agency pending contracts, leases, bids, proposals, and other ongoing procurement relationships. For any contracts that are not covered by the Affidavit of Availability, the bidder must identify them on Form B or on an attached sheet(s). These might be such things as leases.

D. Bidders Submitting More Than One Bid

Bidders submitting multiple bids may submit one set of forms consisting of all required Form A disclosures and one Form B for use with all bids. Please indicate in the space provided below the bid item that contains the original disclosure forms and the bid items which incorporate the forms by reference.

- The bid submitted for letting item _____ contains the Form A disclosures or Certification Statement and the Form B disclosures. The following letting items incorporate the said forms by reference:

**ILLINOIS DEPARTMENT
OF TRANSPORTATION**

**Form A
Financial Information &
Potential Conflicts of Interest
Disclosure**

Contractor Name		
Legal Address		
City, State, Zip		
Telephone Number	Email Address	Fax Number (if available)

Disclosure of the information contained in this Form is required by the Section 50-35 of the Illinois Procurement Code (30 ILCS 500). Vendors desiring to enter into a contract with the State of Illinois must disclose the financial information and potential conflict of interest information as specified in this Disclosure Form. This information shall become part of the publicly available contract file. This Form A must be completed for bids in excess of \$10,000, and for all open-ended contracts. **A publicly traded company may submit a 10K disclosure (or equivalent if applicable) in satisfaction of the requirements set forth in Form A. See Disclosure Form Instructions.**

DISCLOSURE OF FINANCIAL INFORMATION

1. Disclosure of Financial Information. The individual named below has an interest in the BIDDER (or its parent) in terms of ownership or distributive income share in excess of 5%, or an interest which has a value of more than \$90,420.00 (60% of the Governor's salary as of 7/1/01). **(Make copies of this form as necessary and attach a separate Disclosure Form A for each individual meeting these requirements)**

FOR INDIVIDUAL (type or print information)

NAME: _____

ADDRESS _____

Type of ownership/distributable income share:

stock _____ sole proprietorship _____ Partnership _____ other: (explain on separate sheet):
% or \$ value of ownership/distributable income share: _____

2. Disclosure of Potential Conflicts of Interest. Check "Yes" or "No" to indicate which, if any, of the following potential conflict of interest relationships apply. If the answer to any question is "Yes", please attach additional pages and describe.

(a) State employment, currently or in the previous 3 years, including contractual employment of services. Yes ___ No ___

If your answer is yes, please answer each of the following questions.

1. Are you currently an officer or employee of either the Capitol Development Board or the Illinois Toll Highway Authority? Yes ___ No ___

2. Are you currently appointed to or employed by any agency of the State of Illinois? If you are currently appointed to or employed by any agency of the State of Illinois, and your annual salary exceeds \$90,420.00, (60% of the Governor's salary as of 7/1/01) provide the name the State agency for which you are employed and your annual salary. _____

RETURN WITH BID/OFFER

3. If you are currently appointed to or employed by any agency of the State of Illinois, and your annual salary exceeds \$90,420.00, (60% of the Governor's salary as of 7/1/01) are you entitled to receive (i) more than 7 1/2% of the total distributable income of your firm, partnership, association or corporation, or (ii) an amount in excess of the salary of the Governor? Yes ___ No ___
4. If you are currently appointed to or employed by any agency of the State of Illinois, and your annual salary exceeds \$90,420.00, (60% of the Governor's salary as of 7/1/01) are you and your spouse or minor children entitled to receive (i) more than 15 % in the aggregate of the total distributable income of your firm, partnership, association or corporation, or (ii) an amount in excess of 2 times the salary of the Governor? Yes ___ No ___

(b) State employment of spouse, father, mother, son, or daughter, including contractual employment services in the previous 2 years.

Yes ___ No ___

If your answer is yes, please answer each of the following questions.

1. Is your spouse or any minor children currently an officer or employee of the Capitol Development Board or the Illinois Toll Highway Authority? Yes ___ No ___
2. Is your spouse or any minor children currently appointed to or employed by any agency of the State of Illinois? If your spouse or minor children is/are currently appointed to or employed by any agency of the State of Illinois, and his/her annual salary exceeds \$90,420.00, (60 % of the Governor's salary as of 7/1/01) provide the name of your spouse and/or minor children, the name of the State agency for which he/she is employed and his/her annual salary. _____
-
3. If your spouse or any minor children is/are currently appointed to or employed by any agency of the State of Illinois, and his/her annual salary exceeds \$90,420.00, (60% of the salary of the Governor as of 7/1/01) are you entitled to receive (i) more then 71/2% of the total distributable income of your firm, partnership, association or corporation, or (ii) an amount in excess of the salary of the Governor? Yes ___ No ___
4. If your spouse or any minor children are currently appointed to or employed by any agency of the State of Illinois, and his/her annual salary exceeds \$90,420.00, (60% of the Governor's salary as of 7/1/01) are you and your spouse or minor children entitled to receive (i) more than 15 % in the aggregate of the total distributable income of your firm, partnership, association or corporation, or (ii) an amount in excess of 2 times the salary of the Governor? Yes ___ No ___

(c) Elective status; the holding of elective office of the State of Illinois, the government of the United States, any unit of local government authorized by the Constitution of the State of Illinois or the statutes of the State of Illinois currently or in the previous 3 years.

Yes ___ No ___

(d) Relationship to anyone holding elective office currently or in the previous 2 years; spouse, father, mother, son, or daughter.

Yes ___ No ___

(e) Appointive office; the holding of any appointive government office of the State of Illinois, the United States of America, or any unit of local government authorized by the Constitution of the State of Illinois or the statutes of the State of Illinois, which office entitles the holder to compensation in excess of the expenses incurred in the discharge of that office currently or in the previous 3 years.

Yes ___ No ___

(f) Relationship to anyone holding appointive office currently or in the previous 2 years; spouse, father, mother, son, or daughter.

Yes ___ No ___

(g) Employment, currently or in the previous 3 years, as or by any registered lobbyist of the State government.

Yes ___ No ___

RETURN WITH BID/OFFER

(h) Relationship to anyone who is or was a registered lobbyist in the previous 2 years; spouse, father, mother, son, or daughter. Yes ___ No ___

(i) Compensated employment, currently or in the previous 3 years, by any registered election or reelection committee registered with the Secretary of State or any county clerk of the State of Illinois, or any political action committee registered with either the Secretary of State or the Federal Board of Elections. Yes ___ No ___

(j) Relationship to anyone; spouse, father, mother, son, or daughter; who was a compensated employee in the last 2 years by any registered election or re-election committee registered with the Secretary of State or any county clerk of the State of Illinois, or any political action committee registered with either the Secretary of State or the Federal Board of Elections. Yes ___ No ___

APPLICABLE STATEMENT

This Disclosure Form A is submitted on behalf of the INDIVIDUAL named on previous page.

Completed by: _____
Name of Authorized Representative (type or print)

Completed by: _____
Title of Authorized Representative (type or print)

Completed by: _____ Date _____
Signature of Individual or Authorized Representative

NOT APPLICABLE STATEMENT

I have determined that no individuals associated with this organization meet the criteria that would require the completion of this Form A.

This Disclosure Form A is submitted on behalf of the CONTRACTOR listed on the previous page.

Name of Authorized Representative (type or print)

Title of Authorized Representative (type or print)

Signature of Authorized Representative Date _____

RETURN WITH BID/OFFER

ILLINOIS DEPARTMENT
OF TRANSPORTATION

Form B
Other Contracts &
Procurement Related Information
Disclosure

Contractor Name		
Legal Address		
City, State, Zip		
Telephone Number	Email Address	Fax Number (if available)

Disclosure of the information contained in this Form is required by the Section 50-35 of the Illinois Procurement Act (30 ILCS 500). This information shall become part of the publicly available contract file. This Form B must be completed for bids in excess of \$10,000, and for all open-ended contracts.

DISCLOSURE OF OTHER CONTRACTS AND PROCUREMENT RELATED INFORMATION

1. Identifying Other Contracts & Procurement Related Information. The BIDDER shall identify whether it has any pending contracts (including leases), bids, proposals, or other ongoing procurement relationship with any other State of Illinois agency: Yes ___ No ___

If **“No” is checked**, the bidder only needs to complete the signature box on the bottom of this page.

2. If “Yes” is checked. Identify each such relationship by showing State of Illinois agency name and other descriptive information such as bid or project number (attach additional pages as necessary). SEE DISCLOSURE FORM INSTRUCTIONS:

THE FOLLOWING STATEMENT MUST BE SIGNED

Name of Authorized Representative (type or print)	

Title of Authorized Representative (type or print)	
_____	_____
Signature of Authorized Representative	Date

RETURN WITH BID

SPECIAL NOTICE TO CONTRACTORS

The following requirements of the Illinois Department of Human Rights' Rules and Regulations are applicable to bidders on all construction contracts advertised by the Illinois Department of Transportation:

CONSTRUCTION EMPLOYEE UTILIZATION PROJECTION

- (a) All bidders on construction contracts shall complete and submit, along with and as part of their bids, a Bidder's Employee Utilization Form (Form BC-1256) setting forth a projection and breakdown of the total workforce intended to be hired and/or allocated to such contract work by the bidder including a projection of minority and female employee utilization in all job classifications on the contract project.
- (b) The Department of Transportation shall review the Employee Utilization Form, and workforce projections contained therein, of the contract awardee to determine if such projections reflect an underutilization of minority persons and/or women in any job classification in accordance with the Equal Employment Opportunity Clause and Section 7.2 of the Illinois Department of Human Rights' Rules and Regulations for Public Contracts adopted as amended on September 17, 1980. If it is determined that the contract awardee's projections reflect an underutilization of minority persons and/or women in any job classification, it shall be advised in writing of the manner in which it is underutilizing and such awardee shall be considered to be in breach of the contract unless, prior to commencement of work on the contract project, it submits revised satisfactory projections or an acceptable written affirmative action plan to correct such underutilization including a specific timetable geared to the completion stages of the contract.
- (c) The Department of Transportation shall provide to the Department of Human Rights a copy of the contract awardee's Employee Utilization Form, a copy of any required written affirmative action plan, and any written correspondence related thereto. The Department of Human Rights may review and revise any action taken by the Department of Transportation with respect to these requirements.

RETURN WITH BID



Contract No. 76909
MADISON County
Section 52RS-2,52-I
Route FAS 777
District 8 Construction Funds

PART I. IDENTIFICATION

Dept. Human Rights # _____ Duration of Project: _____

Name of Bidder: _____

PART II. WORKFORCE PROJECTION

A. The undersigned bidder has analyzed minority group and female populations, unemployment rates and availability of workers for the location in which this contract work is to be performed, and for the locations from which the bidder recruits employees, and hereby submits the following workforce projection including a projection for minority and female employee utilization in all job categories in the workforce to be allocated to this contract:

TABLE A

TOTAL Workforce Projection for Contract												
JOB CATEGORIES	TOTAL EMPLOYEES		MINORITY EMPLOYEES						TRAINEES			
			BLACK		HISPANIC		*OTHER MINOR.		APPRENTICES		ON THE JOB TRAINEES	
	M	F	M	F	M	F	M	F	M	F	M	F
OFFICIALS (MANAGERS)												
SUPERVISORS												
FOREMEN												
CLERICAL EQUIPMENT OPERATORS												
MECHANICS												
TRUCK DRIVERS												
IRONWORKERS												
CARPENTERS												
CEMENT MASONS												
ELECTRICIANS												
PIPEFITTERS, PLUMBERS												
PAINTERS												
LABORERS, SEMI-SKILLED												
LABORERS, UNSKILLED												
TOTAL												

TABLE B

CURRENT EMPLOYEES TO BE ASSIGNED TO CONTRACT			
TOTAL EMPLOYEES		MINORITY EMPLOYEES	
M	F	M	F

TABLE C

TOTAL Training Projection for Contract								
EMPLOYEES IN TRAINING	TOTAL EMPLOYEES		BLACK		HISPANIC		*OTHER MINOR.	
	M	F	M	F	M	F	M	F
APPRENTICES								
ON THE JOB TRAINEES								

FOR DEPARTMENT USE ONLY

*Other minorities are defined as Asians (A) or Native Americans (N).

Please specify race of each employee shown in Other Minorities column.
Note: See instructions on the next page

RETURN WITH BID

**Contract No. 76909
MADISON County
Section 52RS-2,52-I
Route FAS 777
District 8 Construction Funds**

PART II. WORKFORCE PROJECTION - continued

B. Included in "Total Employees" under Table A is the total number of **new hires** that would be employed in the event the undersigned bidder is awarded this contract.

The undersigned bidder projects that: (number) _____ new hires would be recruited from the area in which the contract project is located; and/or (number) _____ new hires would be recruited from the area in which the bidder's principal office or base of operation is located.

C. Included in "Total Employees" under Table A is a projection of numbers of persons to be employed directly by the undersigned bidder as well as a projection of numbers of persons to be employed by subcontractors.

The undersigned bidder estimates that (number) _____ persons will be directly employed by the prime contractor and that (number) _____ persons will be employed by subcontractors.

PART III. AFFIRMATIVE ACTION PLAN

A. The undersigned bidder understands and agrees that in the event the foregoing minority and female employee utilization projection included under **PART II** is determined to be an underutilization of minority persons or women in any job category, and in the event that the undersigned bidder is awarded this contract, he/she will, prior to commencement of work, develop and submit a written Affirmative Action Plan including a specific timetable (geared to the completion stages of the contract) whereby deficiencies in minority and/or female employee utilization are corrected. Such Affirmative Action Plan will be subject to approval by the contracting agency and the **Department of Human Rights**.

B. The undersigned bidder understands and agrees that the minority and female employee utilization projection submitted herein, and the goals and timetable included under an Affirmative Action Plan if required, are deemed to be part of the contract specifications.

Company _____ Telephone Number _____

Address _____

NOTICE REGARDING SIGNATURE

The Bidder's signature on the Proposal Signature Sheet will constitute the signing of this form. The following signature block needs to be completed only if revisions are required.

Signature: _____ Title: _____ Date: _____

- Instructions: All tables must include subcontractor personnel in addition to prime contractor personnel.
- Table A - Include both the number of employees that would be hired to perform the contract work and the total number currently employed (Table B) that will be allocated to contract work, and include all apprentices and on-the-job trainees. The "Total Employees" column should include all employees including all minorities, apprentices and on-the-job trainees to be employed on the contract work.
- Table B - Include all employees currently employed that will be allocated to the contract work including any apprentices and on-the-job trainees currently employed.
- Table C - Indicate the racial breakdown of the total apprentices and on-the-job trainees shown in Table A.

RETURN WITH BID

**Contract No. 76909
MADISON County
Section 52RS-2,52-I
Route FAS 777
District 8 Construction Funds**

PROPOSAL SIGNATURE SHEET

The undersigned bidder hereby makes and submits this bid on the subject Proposal, thereby assuring the Department that all requirements of the Invitation for Bids and rules of the Department have been met, that there is no misunderstanding of the requirements of paragraph 3 of this Proposal, and that the contract will be executed in accordance with the rules of the Department if an award is made on this bid.

Firm Name _____
(IF AN INDIVIDUAL) Signature of Owner _____
Business Address _____

Firm Name _____
By _____
(IF A CO-PARTNERSHIP) Business Address _____

Name and Address of All Members of the Firm:

Corporate Name _____
By _____
Signature of Authorized Representative _____
Typed or printed name and title of Authorized Representative _____
(IF A CORPORATION) Attest _____
Signature _____
(IF A JOINT VENTURE, USE THIS SECTION
FOR THE MANAGING PARTY AND THE
SECOND PARTY SHOULD SIGN BELOW) Business Address _____

Corporate Name _____
By _____
Signature of Authorized Representative _____
Typed or printed name and title of Authorized Representative _____
(IF A JOINT VENTURE) Attest _____
Signature _____
Business Address _____

If more than two parties are in the joint venture, please attach an additional signature sheet.



RETURN WITH BID

Division of Highways
Proposal Bid Bond
(Effective November 1, 1992)

Item No.
Letting Date

KNOW ALL MEN BY THESE PRESENTS, That We
as PRINCIPAL, and

held jointly, severally and firmly bound unto the STATE OF ILLINOIS in the penal sum of 5 percent of the total bid price, or for the amount specified in Article 102.09 of the "Standard Specifications for Road and Bridge Construction" in effect on the date of invitation for bids, whichever is the lesser sum, well and truly to be paid unto said STATE OF ILLINOIS, for the payment of which we bind ourselves, our heirs, executors, administrators, successors and assigns.

THE CONDITION OF THE FOREGOING OBLIGATION IS SUCH, That Whereas, the PRINCIPAL has submitted a bid proposal to the STATE OF ILLINOIS, acting through the Department of Transportation, for the improvement designated by the Transportation Bulletin Item Number and Letting Date indicated above.

NOW, THEREFORE, if the Department shall accept the bid proposal of the PRINCIPAL; and if the PRINCIPAL shall, within the time and as specified in the bidding and contract documents, submit a DBE Utilization Plan that is accepted and approved by the Department; and if, after award by the Department, the PRINCIPAL shall enter into a contract in accordance with the terms of the bidding and contract documents including evidence of the required insurance coverages and providing such bond as specified with good and sufficient surety for the faithful performance of such contract and for the prompt payment of labor and material furnished in the prosecution thereof; or if, in the event of the failure of the PRINCIPAL to make the required DBE submission or to enter into such contract and to give the specified bond, the PRINCIPAL pays to the Department the difference not to exceed the penalty hereof between the amount specified in the bid proposal and such larger amount for which the Department may contract with another party to perform the work covered by said bid proposal, then this obligation shall be null and void, otherwise, it shall remain in full force and effect.

IN THE EVENT the Department determines the PRINCIPAL has failed to comply with any requirement as set forth in the preceding paragraph, then Surety shall pay the penal sum to the Department within fifteen (15) days of written demand therefor. If Surety does not make full payment within such period of time, the Department may bring an action to collect the amount owed. Surety is liable to the Department for all its expenses, including attorney's fees, incurred in any litigation in which it prevails either in whole or in part.

In TESTIMONY WHEREOF, the said PRINCIPAL and the said SURETY have caused this instrument to be signed by their respective officers this day of A.D.,

PRINCIPAL SURETY
(Company Name) (Company Name)
By: (Signature & Title) By: (Signature of Attorney-in-Fact)

Notary Certification for Principal and Surety

STATE OF ILLINOIS,
COUNTY OF

I, a Notary Public in and for said County, do hereby certify that
and

(Insert names of individuals signing on behalf of PRINCIPAL & SURETY)

who are each personally known to me to be the same persons whose names are subscribed to the foregoing instrument on behalf of PRINCIPAL and SURETY, appeared before me this day in person and acknowledged respectively, that they signed and delivered said instrument as their free and voluntary act for the uses and purposes therein set forth.

Given under my hand and notarial seal this day of A.D.

My commission expires Notary Public

In lieu of completing the above section of the Proposal Bid Form, the Principal may file an Electronic Bid Bond. By signing below the Principal is ensuring the identified electronic bid bond has been executed and the Principal and Surety are firmly bound unto the State of Illinois under the conditions of the bid bond as shown above.

Electronic Bid Bond ID# Company/Bidder Name Signature and Title

PROPOSAL ENVELOPE



PROPOSALS

for construction work advertised for bids by the
Illinois Department of Transportation

Item No.	Item No.	Item No.

Submitted By:

Name:
Address:
Phone No.

Bidders should use an IDOT proposal envelope or affix this form to the front of a 10" x 13" envelope for the submittal of bids. If proposals are mailed, they should be enclosed in a second or outer envelope addressed to:

Engineer of Design and Environment - Room 326
Illinois Department of Transportation
2300 South Dirksen Parkway
Springfield, Illinois 62764

NOTICE

Individual bids, including Bid Bond and/or supplemental information if required, should be securely stapled.

CONTRACTOR OFFICE COPY OF CONTRACT SPECIFICATIONS

NOTICE

None of the following material needs to be returned with the bid package unless the special provisions require documentation and/or other information to be submitted.

**Contract No. 76909
MADISON County
Section 52RS-2,52-I
Route FAS 777
District 8 Construction Funds**



Illinois Department of Transportation



NOTICE TO BIDDERS

1. TIME AND PLACE OF OPENING BIDS. Sealed proposals for the improvement described herein will be received by the Department of Transportation at the Harry R. Hanley Building, 2300 South Dirksen Parkway, in Springfield, Illinois until 10:00 o'clock a.m., June 17, 2005. All bids will be gathered, sorted, publicly opened and read in the auditorium at the Department of Transportation's Harry R. Hanley Building shortly after the 10:00 a.m. cut off time.

2. DESCRIPTION OF WORK. The proposed improvement is identified and advertised for bids in the Invitation for Bids as:

**Contract No. 76909
MADISON County
Section 52RS-2,52-I
Route FAS 777
District 8 Construction Funds**

Construction of bituminous shoulders, gutter replacement and 18 ft and variable width bituminous concrete surface on New Douglas Road from I-55 to New Douglas.

3. INSTRUCTIONS TO BIDDERS. (a) This Notice, the invitation for bids, proposal and letter of award shall, together with all other documents in accordance with Article 101.09 of the Standard Specifications for Road and Bridge Construction, become part of the contract. Bidders are cautioned to read and examine carefully all documents, to make all required inspections, and to inquire or seek explanation of the same prior to submission of a bid.

(b) State law, and, if the work is to be paid wholly or in part with Federal-aid funds, Federal law requires the bidder to make various certifications as a part of the proposal and contract. By execution and submission of the proposal, the bidder makes the certification contained therein. A false or fraudulent certification shall, in addition to all other remedies provided by law, be a breach of contract and may result in termination of the contract.

4. AWARD CRITERIA AND REJECTION OF BIDS. This contract will be awarded to the lowest responsive and responsible bidder considering conformity with the terms and conditions established by the Department in the rules, Invitation for Bids and contract documents. The issuance of plans and proposal forms for bidding based upon a prequalification rating shall not be the sole determinant of responsibility. The Department reserves the right to determine responsibility at the time of award, to reject any or all proposals, to readvertise the proposed improvement, and to waive technicalities.

By Order of the
Illinois Department of Transportation

Timothy W. Martin, Secretary

BD 351 (Rev. 01/2003)

INDEX
FOR
SUPPLEMENTAL SPECIFICATIONS AND RECURRING SPECIAL PROVISIONS
Adopted March 1, 2005

This index contains a listing of SUPPLEMENTAL SPECIFICATIONS and frequently used RECURRING SPECIAL PROVISIONS.

ERRATA Standard Specifications for Road and Bridge Construction (Adopted 1-1-02) (Revised 3-1-05)

SUPPLEMENTAL SPECIFICATIONS

<u>Std. Spec. Sec.</u>		<u>Page No.</u>
101	Definition of Terms	1
105	Control of Work	2
205	Embankment	3
251	Mulch	4
281	Riprap.....	5
282	Filter Fabric for Use With Riprap	8
285	Concrete Revetment Mats.....	10
311	Granular Subbase	14
351	Aggregate Base Course.....	15
440	Removal of Existing Pavement and Appurtenances	16
442	Pavement Patching	17
449	Removal and Replacement of Preformed Elastomeric Compression Joint Seal	18
481	Aggregate Shoulders	19
501	Removal of Existing Structures	20
503	Concrete Structures	21
505	Steel Structures	22
506	Cleaning and Painting Metal Structures	25
508	Reinforcement Bars	26
512	Piling	27
540	Box Culverts.....	28
589	Elastic Joint Sealer	30
602	Catch Basin, Manhole, Inlet, Drainage Structures and Valve Vault Construction, Adjustment and Reconstruction	31
603	Adjusting Frames and Grates of Drainage and Utility Structures	32
610	Shoulder Inlets with Curb	33
665	Woven Wire Fence	34
669	Removal and Disposal of Regulated Substances	35
671	Mobilization	36
702	Work Zone Traffic Control Devices	37
1003	Fine Aggregates	38
1004	Coarse Aggregate	39
1005	Stone, Concrete Blocks and Broken Concrete for Erosion Protection, Sediment Control and Rockfill	42
1006	Metals	46
1007	Timber and Preservative Treatment	49
1012	Hydrated Lime	50
1020	Portland Cement Concrete	51
1021	Concrete Admixtures	58
1022	Concrete Curing Materials	59
1024	Nonshrink Grout	61
1041	Brick	63
1043	Precast Reinforced Concrete Manhole Sections and Adjusting Rings.....	64
1056	Preformed Flexible Gaskets and Mastic Joint Sealer for Sewer and Culvert Pipe	66
1059	Elastic Joint Sealers	67
1060	Waterproofing Materials	68
1069	Pole and Tower	69
1070	Foundation and Breakaway Devices	70
1077	Post and Foundation	72
1080	Fabric Materials	73
1081	Materials For Planting	76
1083	Elastomeric Bearings	77
1094	Overhead Sign Structures	78
1103	Portland Cement Concrete Equipment	79

RECURRING SPECIAL PROVISIONS

The following RECURRING SPECIAL PROVISIONS indicated by an "X" are applicable to this contract and are included by reference:

<u>CHECK SHEET #</u>	<u>PAGE NO.</u>
1 State Required Contract Provisions All Federal-aid Construction Contracts (Eff. 2-1-69) (Rev. 10-1-83)	80
2 Subletting of Contracts (Federal-aid Contracts) (Eff. 1-1-88) (Rev. 5-1-93).....	82
3 X EEO (Eff. 7-21-78) (Rev. 11-18-80)	83
4 X Specific Equal Employment Opportunity Responsibilities NonFederal-aid Contracts (Eff. 3-20-69) (Rev. 1-1-94)	94
5 X Required Provisions - State Contracts (Eff. 4-1-65) (Rev. 4-1-93).....	100
6 Reserved	105
7 X Asphalt Quantities and Cost Reviews (Eff. 7-1-88).....	106
8 National Pollutant Discharge Elimination System Permit (Eff. 7-1-94) (Rev. 1-1-03).....	107
9 Haul Road Stream Crossings, Other Temporary Stream Crossings and In-Stream Work Pads (Eff. 1-2-92) (Rev. 1-1-98)	108
10 Construction Layout Stakes Except for Bridges (Eff. 1-1-99) (Rev. 1-1-02).....	109
11 Construction Layout Stakes (Eff. 5-1-93) (Rev. 1-1-02).....	112
12 Use of Geotextile Fabric for Railroad Crossing (Eff. 1-1-95) (Rev. 1-1-97).....	115
13 Asphaltic Emulsion Slurry Seal and Fibrated Asphaltic Emulsion Slurry Seal (Eff. 8-1-89) (Rev. 2-1-97)	117
14 Bituminous Surface Treatments Half-Smart (Eff. 7-1-93) (Rev. 1-1-97)	123
15 X Quality Control/Quality Assurance of Bituminous Concrete Mixtures (Eff. 1-1-00) (Rev. 3-1-05)	129
16 Subsealing of Concrete Pavements (Eff. 11-1-84) (Rev. 2-1-95).....	148
17 Bituminous Surface Removal (Cold Milling) (Eff. 11-1-87) (Rev. 10-15-97).....	152
18 Resurfacing of Milled Surfaces (Eff. 10-1-95)	154
19 PCC Partial Depth Bituminous Patching (Eff. 1-1-98).....	155
20 Patching with Bituminous Overlay Removal (Eff. 10-1-95) (Rev. 7-1-99)	157
21 Reserved	159
22 Protective Shield System (Eff. 4-1-95) (Rev. 1-1-03).....	160
23 Polymer Concrete (Eff. 8-1-95) (Rev. 3-1-05).....	162
24 Controlled Low-Strength Material (CLSM) (Eff. 1-1-90) (Rev. 3-1-05).....	164
25 Pipe Underdrains (Eff. 9-9-87) (Rev. 1-1-98).....	169
26 Guardrail and Barrier Wall Delineation (Eff. 12-15-93) (Rev. 1-1-97)	170
27 Bicycle Racks (Eff. 4-1-94) (Rev. 1-1-97)	175
28 Reserved	177
29 Reserved	178
30 Reserved	179
31 Night Time Inspection of Roadway Lighting (Eff. 5-1-96).....	180
32 Reserved	181
33 English Substitution of Metric Bolts (Eff. 7-1-96).....	182
34 English Substitution of Metric Reinforcement Bars (Eff. 4-1-96) (Rev. 1-1-03)	183
35 Polymer Modified Emulsified Asphalt (Eff. 5-15-89) (Rev. 1-1-04).....	185
36 Corrosion Inhibitor (Eff. 3-1-80) (Rev. 7-1-99)	187
37 X Quality Control of Concrete Mixtures at the Plant-Single A (Eff. 8-1-00) (Rev. 1-1-04)	188
38 Quality Control of Concrete Mixtures at the Plant-Double A (Eff. 8-1-00) (Rev. 1-1-04)	194
39 Quality Control/Quality Assurance of Concrete Mixtures (Eff. 4-1-92) (Rev. 3-1-05).....	202
40 Traffic Barrier Terminal Type 1, Special (Eff. 8-1-94) (Rev. 1-1-03)	215
41 Reserved	216
42 X Segregation Control of Bituminous Concrete (Eff. 7-15-97).....	217
43 Reserved	220

TABLE OF CONTENTS

LOCATION OF PROJECT	1
DESCRIPTION OF PROJECT	1
PAYROLLS AND PROCEDURES	1
MONTHLY LABOR SUMMARY AND ACTIVITY REPORTING SYSTEM	2
TRAFFIC CONTROL PLAN	5
CONSTRUCTION AND MAINTENANCE SIGN SUPPORTS	5
STATUS OF UTILITIES TO BE ADJUSTED	6
BITUMINOUS CONCRETE SURFACE COURSE (BDE).....	6
BITUMINOUS EQUIPMENT, SPREADING AND FINISHING MACHINE (BDE)	7
BUTT JOINTS (BDE)	7
CONCRETE ADMIXTURES (BDE)	8
CURING AND PROTECTION OF CONCRETE CONSTRUCTION (BDE)	12
DISADVANTAGED BUSINESS ENTERPRISE PARTICIPATION (BDE)	19
FLAGGER VESTS (BDE)	26
FREEZE-THAW RATING (BDE).....	26
PARTIAL PAYMENTS (BDE).....	27
PAYMENTS TO SUBCONTRACTORS (BDE)	27
PERSONAL PROTECTIVE EQUIPMENT (BDE)	28
PORTLAND CEMENT (BDE).....	29
PORTLAND CEMENT CONCRETE (BDE)	29
RAP FOR USE IN BITUMINOUS CONCRETE MIXTURES (BDE).....	29
SEEDING AND SODDING (BDE).....	33
STABILIZED SUBBASE AND BITUMINOUS SHOULDERS SUPERPAVE (BDE).....	35
SUPERPAVE BITUMINOUS CONCRETE MIXTURES (BDE).....	41
TRAFFIC CONTROL DEFICIENCY DEDUCTION (BDE)	47
TRUCK BED RELEASE AGENT (BDE)	48
WEIGHT CONTROL DEFICIENCY DEDUCTION.....	48
WORK ZONE SPEED LIMIT SIGNS (BDE)	49
WORK ZONE TRAFFIC CONTROL DEVICES (BDE)	50
WORKING DAYS (BDE)	51
SUBCONTRACTOR MOBILIZATION PAYMENTS (BDE).....	51

STATE OF ILLINOIS

SPECIAL PROVISIONS

The following Special Provisions supplement the "Standard Specifications for Road and Bridge Construction," adopted January 1, 2002, the latest edition of the "Manual on Uniform Traffic Control Devices for Streets and Highways," and the "Manual of Test Procedures for Materials" in effect on the date of invitation for bids, and the Supplemental Specifications and Recurring Special Provisions indicated on the Check Sheet included herein which apply to and govern the construction of FAS Route 777 (New Douglas Road); Section 52RS-2, 52-I; Madison County; Contract No. 76909 and in case of conflict with any part or parts of said Specifications, the said Special Provisions shall take precedence and shall govern.

LOCATION OF PROJECT

The project is located on New Douglas Road from I-55 to New Douglas in Madison County.

DESCRIPTION OF PROJECT

This project consists of resurfacing New Douglas Road over I-55 and two locations between I-55 and New Douglas. Gutter replacement and bituminous shoulder installation between I-55 and New Douglas is also included in the contract. The major pay items in the project are as follows:

- Bituminous Concrete Leveling Binder and Surface Course
- Aggregate Shoulders
- Bituminous Shoulders
- Gutter Removal
- Concrete Gutter, Type A (Special)
- Paint Pavement Marking
- Excavating and Grading Existing Shoulders

PAYROLLS AND PROCEDURES

Effective: 2/5/1975

Revised: 11/7/1986, 1/14/1994, and June 2001

The prime contractor and each subcontractor shall submit a weekly certified original and one copy of their company's payroll directly to the District Engineer.

Payrolls must be received within seven days of the payroll ending period.

Payroll data shall be submitted on Payroll Form RE 48 or an approved facsimile.

Every person paid by a contractor or subcontractor in any manner for his or her labor in the construction, prosecution, completion, or repair of this public work is **employed** and receiving “wages”, regardless of any contractual relationship alleged to exist between him or her and the real employer.

Payroll data shall include all persons employed on the job site.

The following employee codes are to be used to identify each individual on the payroll:

- A. **Gender:** M - Male F - Female
- B. **Ethnic Group:** 1 - White 2 - Black 3 - Hispanic
4 - American Indian/Alaskan Native 5 - Asian/Pacific Islander
- C. **Work Classification:** OF - Officials SU - Supervisors FO – Foremen
CL - Clerical CA - Carpenters EO - Operators ME – Mechanics
TD - Truck Drivers IW - Ironworkers PA - Painters CM - Cement Masons
EL - Electricians PP - Pipefitters TE - Technical LA – Laborers
OT - Other
- D. **Employee Status:** O - Owner Operator J - Journeyman C – Company
A - Apprentice T - Trainee

Payroll data shall be submitted by the prime contractor and each subcontractor for each consecutive week, from the start to the completion of their work. When there has been no activity during a work week, a payroll is still required to be sent to the District Engineer, with the appropriate box (“No Work”, “Suspended”, “Completed”) checked at the bottom of the Payroll Form RE 48. Do Not check any of these boxes when payroll data is being reported on the payroll.

The Department of Transportation is requesting disclosure of information necessary to accomplish the statutory purpose as outlined under 23CFR part 230 and 41CFR part 60.4 and the Illinois Human Rights Act. Disclosure of this information is REQUIRED. Failure to comply with this special provision may result in the withholding of payments to the contractor, and/or cancellation, termination, or suspension of the contract in whole or part.

Compliance with this Special Provision shall be considered incidental to the cost of the contract and no additional compensation will be allowed for any costs incurred.

This Special Provision must be included in each subcontract agreement.

MONTHLY LABOR SUMMARY AND ACTIVITY REPORTING SYSTEM

Effective: 1-1-1995

Revised June 2001

- I. Monthly Labor Summary Report, Form SBE 148

The prime contractor and each first and second tier sub-contractor, (hereinafter referred to as "subcontractor") shall submit a certified Monthly Labor Summary Report directly to the District Engineer.

This report is in lieu of submittal of the Monthly Workforce Analysis Report, Form SBE 956.

This report must be received in District Eight no later than the tenth day of the next month.

This Report shall be submitted by the prime contractor and each subcontractor, for each consecutive month, from the start, to the completion of their work on the contract.

The data source for this Report will be a summation of all personnel and hours worked on each subject contract for the month based on weekly payrolls for that month.

The Monthly Labor Summary Report is required to be submitted in one of the following formats:

- a.) For contractors having IDOT contracts valued in the aggregate at \$250,000 or less, the report may be typed or clearly handwritten using Form SBE 148 for submittal to the District Engineer for District Eight.
- b.) For contractors having IDOT contracts valued in the aggregate at more than \$250,000, the report must be submitted in a specific "Fixed Length Comma Delimited ASCII Text File Format". The subject file format is detailed on the next page. Submittal of this file may be by 3.5 inch disk, modem, or by e-mail.

II. Monthly Contract Activity Report, Form SBE 248

The prime contractor and each subcontractor shall submit a monthly report directly to the District Engineer reflecting their contract activity on all Illinois Department of Transportation contracts they have in force in District Eight.

This report shall be submitted for each consecutive month, from the start, to the completion of all contracts in District Eight.

The report must be received in the District Office no later than the tenth day of the next month.

Monthly Labor Summary and Activity Reporting System Codes and Formats

Indicated below for your reference are the Employee Codes and File Formats required for this system.

I.) Monthly Labor Summary Report, Form SBE 148

The following employee codes are to be used to identify each individual on the Summary Report:

1. **Gender:** **M** - Male **F** - Female

2. **Ethnic Group:** 1 - White 2 - Black 3 - Hispanic
 4 - American Indian/Alaskan Native 5 - Asian/Pacific Islander
3. **Work Classification:** **OF** - Official **SU** - Supervisor **FO** - Foremen
CL - Clerical **CA** - Carpenter **EO** - Operator **ME** - Mechanic
TD - Truck Driver **IW** - Ironworker **PA** - Painter **OT** - Other
EL - Electrician **PP** - Pipefitter **TE** - Technical **LA** - Laborer
CM - Cement Mason
4. **Employee Status:** **O** - Owner Operator **J** - Journeyman
C - Company **A** - Apprentice **T** - Trainee

Specific "Fixed Length Comma Delimited ASCII File Format"

Order	Field Name	Type	Size
1	Contractor Number	A	4
2	Contractor Reference Number	A	6
3	Contract Number	A	5
4	Period (07/28/2000)	D	10
5	SSN (111-11-1111)	A	11
6	Name	A	40
7	Gender	A	1
8	Ethnic Group	A	1
9	Work Classification	A	1
10	Employee Status	A	1
11	Total Hours (000060.00)	N	10

File Name Conventions: (Contractor Number + Report Month/Year).Txt
 i.e. 20001298.Txt

II.) Monthly Contract Activity Report, Form SBE 248

The following activity codes are to be used to identify the contractor's contract status each month on the Monthly Activity Report, Form SBE 248:

- A. **Contract Status:** 1 - Not Started 2 - Active 3 - No Work
 4 - Suspended 5 - Complete

Failure to comply with this special provision may result in the withholding of payments to the contractor, and/or cancellation, termination, or suspension of the contract in whole or part.

Compliance with this Special Provision shall be considered incidental to the cost of the contract and no additional compensation will be allowed for any costs incurred.

All prime and subcontractors having contracts in the aggregate exceeding \$250,000 must provide a "Fixed Length Comma Delimited ASCII File" for approval prior to the start of construction.

This Special Provision must be included in each subcontract agreement.

The Department of Transportation is requesting disclosure of information necessary to accomplish the statutory purpose as outlined under 23CFR part 230 and 41CFR part 60.4 and the Illinois Human Rights Act. Disclosure of this information is REQUIRED. Failure to comply with this special provision may result in the withholding of payments to the contractor, and/or cancellation, termination, or suspension of the contract in whole or part.

Compliance with this Special Provision shall be considered incidental to the cost of the contract and no additional compensation will be allowed for any costs incurred.

This Special Provision must be included in each subcontract agreement.

TRAFFIC CONTROL PLAN

Effective: July 12, 1993

Revised: May 12, 1997

Traffic control shall be in accordance with the applicable sections of the "Standard Specifications for Road and Bridge Construction", the applicable guidelines contained in the "National Manual on Uniform Traffic Control Devices for Streets and Highways", Illinois Supplement to the National Manual of Uniform Traffic Control Devices, these Special Provisions, and any special details and Highway Standards contained herein and in the plans.

Special attention is called to Articles 107.09 and 107.14 of the "Standard Specifications for Road and Bridge Construction and the following Highway Standards relating to traffic control:

701001	701006	701011	701301	701306	701311
701321	701326	702001			

In addition, the following Special Provision(s) will also govern traffic control for this project:

- Flagger Vests
- Personal Protective Equipment
- Traffic Control Deficiency Deduction
- Work Zone Speed Limit Signs
- Work Zone Traffic Control Devices
- Construction and Maintenance Sign Supports

CONSTRUCTION AND MAINTENANCE SIGN SUPPORTS

Effective: April 21, 1981

Revised: October 15, 1996

This work shall be done in accordance with Article 1084.04 of the Standard Specifications and Highway Standard 702001 except as herein modified.

All construction signs mounted on permanent support for use in temporary traffic control having an area of 1 square meter (10 square feet) or more shall be mounted on two 100 mm x 100 mm (4 in x 4 in) or two 100 mm x 150 mm (4 in x 6 in) wood posts.

Type A metal post (two for each sign) conforming to Article 1006.29 of the Standard Specifications may be used in lieu of wood posts. Type A metal posts used for these signs may be unfinished.

This work shall not be measured and paid for but shall be considered incidental to the contract.

STATUS OF UTILITIES TO BE ADJUSTED

NAME AND ADDRESS OF UTILITY	TYPE	LOCATION	ESTIMATED DATE RELOCATION COMPLETED
NO UTILITIES TO BE ADJUSTED			

The above represents the best information of the Department and is only included for the convenience of the bidder. The applicable provisions of Sections 102, 103, and Articles 105.07 and 107.20 of the Standard Specifications for Road and Bridge Construction shall apply.

If any utility adjustment or removal has not been completed when required by the Contractor's operation, the Contractor should notify the Engineer in writing. A request for an extension of time will be considered to the extent the Contractor's operations were affected.

BITUMINOUS CONCRETE SURFACE COURSE (BDE)

Effective: April 1, 2001

Revised: April 1, 2003

Replace the fourth paragraph of Article 406.23(b) of the Standard Specifications with the following:

“Mixture for cracks, joints, flangeways, leveling binder (machine method), leveling binder (hand method) and binder course in excess of 103 percent of the quantity specified by the Engineer will not be measured for payment.

Surface course mixture in excess of 103 percent of adjusted plan quantity will not be measured for payment. The adjusted plan quantity for surface course mixtures will be calculated as follows:

Adjusted Plan Quantity = C x quantity shown on the plans or as specified by the Engineer.

where C = metric: $C = \frac{G_{mb} \times 24.99}{U}$ English: $C = \frac{G_{mb} \times 46.8}{U}$

and where:

- G_{mb} = average bulk specific gravity from approved mix design.
- U = Unit weight of surface course shown on the plans in kg/sq m/25 mm (lb/sq yd/in.), used to estimate plan quantity.
- 24.99 = metric constant.
- 46.8 = English constant.

If project circumstances warrant a new surface course mix design, the above equations shall be used to calculate the adjusted plan quantity for each mix design using its respective average bulk specific gravity.”

BITUMINOUS EQUIPMENT, SPREADING AND FINISHING MACHINE (BDE)

Effective: January 1, 2005

Revise the fourth paragraph of Article 1102.03 of the Standard Specifications to read:

“The paver shall be equipped with a receiving hopper having sufficient capacity for a uniform spreading operation. The hopper shall be equipped with a distribution system to uniformly place a non-segregated mixture in front of the screed. The distribution system shall have chain curtains, deflector plates, and/or other devices designed and built by the paver manufacturer to prevent segregation during distribution of the mixture from the hopper to the paver screed. The Contractor shall submit a written certification that the devices recommended by the paver manufacturer to prevent segregation have been installed and are operational. Prior to paving, the Contractor, in the presence of the Engineer, shall visually inspect paver parts specifically identified by the manufacturer for excessive wear and the need for replacement. The Contractor shall supply a completed check list to the Engineer noting the condition of the parts. Worn parts shall be replaced. The Engineer may require an additional inspection prior to the placement of a surface course or at other times throughout the work.”

BUTT JOINTS (BDE)

Effective: April 1, 2004

Revised: April 1, 2005

Revise Article 406.18 of the Standard Specifications to read:

406.18 Butt Joints. Butt joints shall be constructed according to the details shown on the plans. The surface removal shall be performed according to Section 440. Construction of butt joints shall not begin prior to beginning general operations on the project.

When butt joints are to be constructed under traffic, temporary ramps shall be constructed and maintained at both the upstream and downstream ends of the surface removal areas immediately upon completion of the surface removal operation. The temporary ramps shall be constructed by the following methods.

- (a) Temporary Bituminous Ramps. Temporary bituminous ramps shall have a minimum taper rate of 1:40 (V:H). The bituminous material used shall meet the approval of the Engineer. Cold-milled bituminous tailings will not be acceptable.
- (b) Temporary Rubber Ramps. Temporary rubber ramps shall only be used on roadways with permanent posted speeds of 55 mph or less. The ramps shall have a minimum taper rate of 1:30 (V:H). The leading edge of the rubber ramp shall have a maximum thickness of 6 mm (1/4 in.) and the trailing edge shall match the height of the adjacent pavement \pm 6 mm (1/4 in.).

The rubber material shall conform to the following.

Property	Test Method	Requirement
Durometer Hardness, Shore A	ASTM D 2240	80 ±10
Tensile Strength	ASTM D 412	5500 kPa (800 psi) min.
Elongation, percent	ASTM D 412	100 min.
Specific Gravity	ASTM D 297	1.1-1.3
Brittleness	ASTM D 746	-40 °C (-40 °F)

The rubber ramps shall be installed according to the manufacturer's specifications and fastened with the anchors provided. Rubber ramps that fail to stay in place or create a traffic hazard shall be replaced immediately with temporary bituminous ramps at the Contractor's expense.

The temporary ramps shall be removed just prior to placing the proposed surface course. If work is suspended for the winter season prior to completion of surface course construction, precut butt joints shall be filled to the elevation of the existing pavement surface with compacted bituminous concrete surface course or binder course."

CONCRETE ADMIXTURES (BDE)

Effective: January 1, 2003

Revised: July 1, 2004

Revise Article 1020.05(b) of the Standard Specifications to read:

"(b) Admixtures. Except as specified, the use of admixtures to increase the workability or to accelerate the hardening of the concrete will be permitted only when approved in writing by the Engineer. The Department will maintain an Approved List of Concrete Admixtures. When the Department permits the use of a calcium chloride accelerator, it shall be according to Article 442.02, Note 5.

When the atmosphere or concrete temperature is 18 °C (65 °F) or higher, a retarding admixture meeting the requirements of Article 1021.03 shall be used in the Class BD Concrete and portland cement concrete bridge deck overlays. The amount of retarding admixture to be used will be determined by the Engineer. The proportions of the ingredients of the concrete shall be the same as without the retarding admixture except that the amount of mixing water shall be reduced, as may be necessary, in order to maintain the consistency of the concrete as required. In addition, a high range water-reducing admixture shall be used in Class BD Concrete. The amount of high range water-reducing admixture will be determined by the Engineer. At the option of the Contractor, a water-reducing admixture may be used. Type I cement shall be used.

For Class PC and PS Concrete, a retarding admixture may be added to the concrete mixture when the concrete temperature is 18 °C (65 °F) or higher. Other admixtures may be used when approved by the Engineer, or if specified by the contract. If an accelerating admixture is permitted by the Engineer, it shall be the non-chloride type.

At the Contractor's option, admixtures in addition to an air-entraining admixture may be used for Class PP-1 concrete. The accelerator shall be the non-chloride type. If a

water-reducing or retarding admixture is used, the cement factor may be reduced a maximum 18 kg/cu m (0.30 hundredweight/cu yd). If a high range water-reducing admixture is used, the cement factor may be reduced a maximum 36 kg/cu m (0.60 hundredweight/cu yd). Cement factor reductions shall not be cumulative when using multiple admixtures. An accelerator shall always be added prior to a high range water-reducing admixture, if both are used.

If Class C fly ash or ground granulated blast-furnace slag is used in Class PP-1 concrete, a water-reducing or high range water-reducing admixture shall be used. However, the cement factor shall not be reduced if a water-reducing, retarding, or high range water-reducing admixture is used. In addition, an accelerator shall not be used.

For Class PP-2 or PP-3 concrete, a non-chloride accelerator followed by a high range water-reducing admixture shall be used, in addition to the air-entraining admixture. For Class PP-3 concrete, the non-chloride accelerator shall be calcium nitrite.

For Class PP-2 or PP-3 concrete, the Contractor has the option to use a water-reducing admixture. A retarding admixture shall not be used unless approved by the Engineer. A water-reducing, retarding, or high range water-reducing admixture shall not be used to reduce the cement factor.

When the air temperature is less than 13 °C (55 °F) for Class PP-1 or PP-2 concrete, the non-chloride accelerator shall be calcium nitrite.

For Class PP-4 concrete, a high range water-reducing admixture shall be used in addition to the air-entraining admixture. The Contractor has the option to use a water-reducing admixture. An accelerator shall not be used. For stationary or truck mixed concrete, a retarding admixture shall be used to allow for haul time. The Contractor has the option to use a mobile portland cement concrete plant according to Article 1103.04, but a retarding admixture shall not be used unless approved by the Engineer. A water-reducing, retarding, or high range water-reducing admixture shall not be used to reduce the cement factor.

If the Department specifies a calcium chloride accelerator for Class PP-1 concrete, the maximum chloride dosage shall be 1.0 L (1.0 quart) of solution per 45 kg (100 lb) of cement. The dosage may be increased to a maximum 2.0 L (2.0 quarts) per 45 kg (100 lb) of cement if approved by the Engineer. If the Department specifies a calcium chloride accelerator for Class PP-2 concrete, the maximum chloride dosage shall be 1.3 L (1.3 quarts) of solution per 45 kg (100 lb) of cement. The dosage may be increased to a maximum 2.6 L (2.6 quarts) per 45 kg (100 lb) of cement if approved by the Engineer.

For Class PV, MS, SI, RR, SC and SH concrete, at the option of the Contractor, or when specified by the Engineer, a water-reducing admixture or a retarding admixture may be used. The amount of water-reducing admixture or retarding admixture permitted will be determined by the Engineer. The air-entraining admixture and other admixtures shall be added to the concrete separately, and shall be permitted to intermingle only after they have separately entered the concrete batch. The sequence, method and equipment for adding the admixtures shall be approved by the Engineer. The water-reducing

admixture shall not delay the initial set of the concrete by more than one hour. Type I cement shall be used.

When a water-reducing admixture is added, a cement factor reduction of up to 18 kg/cu m (0.30 hundredweight/cu yd), from the concrete designed for a specific slump without the admixture, will be permitted for Class PV, MS, SI, RR, SC and SH concrete. When an approved high range water-reducing admixture is used, a cement factor reduction of up to 36 kg/cu m (0.60 hundredweight/cu yd), from a specific water cement/ratio without the admixture, will be permitted based on a 14 percent minimum water reduction. This is applicable to Class PV, MS, SI, RR, SC and SH concrete. A cement factor below 320 kg/cu m (5.35 hundredweight/cu yd) will not be permitted for Class PV, MS, SI, RR, SC and SH concrete. A cement factor reduction will not be allowed for concrete placed underwater. Cement factor reductions shall not be cumulative when using multiple admixtures.

For use of admixtures to control concrete temperature, refer to Articles 1020.14(a) and 1020.14(b).

The maximum slumps given in Table 1 may be increased to 175 mm (7 in.) when a high range water-reducing admixture is used for all classes of concrete except Class PV and PP.”

Revise Section 1021 of the Standard Specifications to read:

“SECTION 1021. CONCRETE ADMIXTURES”

1021.01 General. Admixtures shall be furnished in liquid form ready for use. The admixtures may be delivered in the manufacturer's original containers, bulk tank trucks or such containers or tanks as are acceptable to the Engineer. Delivery shall be accompanied by a ticket which clearly identifies the manufacturer and trade name of the material. Containers shall be readily identifiable to the satisfaction of the Engineer as to manufacturer and trade name of the material they contain.

Prior to inclusion of a product on the Department's Approved List of Concrete Admixtures, the manufacturer shall submit a report prepared by an independent laboratory accredited by the AASHTO Accreditation Program. The report shall show the results of physical tests conducted no more than five years prior to the time of submittal, according to applicable specifications.

Tests shall be conducted using materials and methods specified on a "test" concrete and a "reference" concrete, together with a certification that no changes have been made in the formulation of the material since the performance of the tests. Per the manufacturer's option, the cement content for all required tests shall either be according to applicable specifications or 335 kg/cu m (5.65 cwt/cu yd). Compressive strength test results for six months and one year will not be required.

In addition to the report, the manufacturer shall submit AASHTO T 197 water content and set time test results on the standard cement used by the Department. The test and reference concrete mixture shall contain a cement content of 335 kg/cu m (5.65 cwt/cu yd). The

manufacturer may select their lab or an independent lab to perform this testing. The laboratory is not required to be accredited by the AASHTO Accreditation Program.

Prior to the approval of an admixture, the Engineer may conduct all or part of the applicable tests on a sample that is representative of the material to be furnished. The test and reference concrete mixtures tested by the Engineer will contain a cement content of 335 kg/cu m (5.65 cwt/cu yd). For freeze-thaw testing, the Department will perform the test according to Illinois Modified AASHTO T 161, Procedure B.

The manufacturer shall include in the submittal the following information according to ASTM C 494; the average and manufacturing range of specific gravity, the average and manufacturing range of solids in the solution, and the average and manufacturing range of pH. The submittal shall also include an infrared spectrophotometer trace no more than five years old.

When test results are more than seven years old, the manufacturer shall re-submit the infrared spectrophotometer trace and the report prepared by an independent laboratory accredited by the AASHTO Accreditation Program.

All admixtures, except chloride-based accelerators, shall contain no more than 0.3 percent chloride by mass (weight).

1021.02 Air-Entraining Admixtures. Air-entraining admixtures shall conform to the requirements of AASHTO M 154.

If the manufacturer certifies that the air-entraining admixture is an aqueous solution of Vinsol resin that has been neutralized with sodium hydroxide (caustic soda), testing for compliance with the requirements may be waived by the Engineer. In the certification, the manufacturer shall show complete information with respect to the formulation of the solution, including the number of parts of Vinsol resin to each part of sodium hydroxide. Before the approval of its use is granted, the Engineer will test the solution for its air-entraining quality in comparison with a solution prepared and kept for that purpose.

1021.03 Retarding and Water-Reducing Admixtures. The admixture shall comply with the following requirements:

- (a) The retarding admixture shall comply with the requirements of AASHTO M 194, Type B (retarding) or Type D (water-reducing and retarding).
- (b) The water-reducing admixture shall comply with the requirements of AASHTO M 194, Type A.
- (c) The high range water-reducing admixture shall comply with the requirements of AASHTO M 194, Type F (high range water-reducing) or Type G (high range water-reducing and retarding).

When a Type F or Type G high range water-reducing admixture is used, water-cement ratios shall be a minimum of 0.32.

Type F or Type G admixtures may be used, subject to the following restrictions:

For Class MS, SI, RR, SC and SH concrete, the water-cement ratio shall be a maximum of 0.44.

The Type F or Type G admixture shall be added at the jobsite unless otherwise directed by the Engineer. The initial slump shall be a minimum of 40 mm (1 1/2 in.) prior to addition of the Type F or Type G admixture, except as approved by the Engineer.

When a Type F or Type G admixture is used, retempering with water or with a Type G admixture will not be allowed. An additional dosage of a Type F admixture, not to exceed 40 percent of the original dosage, may be used to retemper concrete once, provided set time is not unduly affected. A second retempering with a Type F admixture may be used for all classes of concrete except Class PP and SC, provided that the dosage does not exceed the dosage used for the first retempering, and provided that the set time is not unduly affected. No further retempering will be allowed.

Air tests shall be performed after the addition of the Type F or Type G admixture.

1021.04 Set Accelerating Admixtures. The admixture shall comply with the requirements of AASHTO M 194, Type C (accelerating) or Type E (water reducing and accelerating)”

CURING AND PROTECTION OF CONCRETE CONSTRUCTION (BDE)

Effective: January 1, 2004

Revise the second and third sentences of the eleventh paragraph of Article 503.06 of the Standard Specifications to read:

“Forms on substructure units shall remain in place at least 24 hours. The method of form removal shall not result in damage to the concrete.”

Delete the twentieth paragraph of Article 503.22 of the Standard Specifications.

Revise the “Unit Price Adjustments” table of Article 503.22 of the Standard Specifications to read:

"UNIT PRICE ADJUSTMENTS"	
Type of Construction	Percent Adjustment in Unit Price
For concrete in substructures, culverts (having a waterway opening of more than 1 sq m (10 sq ft)), pump houses, and retaining walls (except concrete pilings, footings and foundation seals): When protected by: Protection Method II Protection Method I	 115% 110%
For concrete in superstructures: When protected by: Protection Method II Protection Method I	 123% 115%
For concrete in footings: When protected by: Protection Method I, II or III	 107%
For concrete in slope walls: When protected by: Protection Method I	 107%"

Delete the fourth paragraph of Article 504.05(a) of the Standard Specifications.

Revise the second and third sentences of the fifth paragraph of Article 504.05(a) of the Standard Specifications to read:

"All test specimens shall be cured with the units according to Article 1020.13."

Revise the first paragraph of Article 504.06(c)(6) of the Standard Specifications to read:

"Curing and Low Air Temperature Protection. The curing and protection for precast, prestressed concrete members shall be according to Article 1020.13 and this Article."

Revise the first sentence of the second paragraph of Article 504.06(c)(6) of the Standard Specifications to read:

"For curing, air vents shall be in place, and shall be so arranged that no water can enter the void tubes during the curing of the members."

Revise the first sentence of the third paragraph of Article 504.06(c)(6) of the Standard Specifications to read:

"As soon as each member is finished, the concrete shall be covered with curing material according to Article 1020.13."

Revise the eighth paragraph of Article 504.06(c)(6) of the Standard Specifications to read:

"The prestressing force shall not be transferred to any member before the concrete has attained the compressive strength of 28,000 kPa (4000 psi) or other higher compressive release strength specified on the plans, as determined from tests of 150 mm (6 in.) by 300 mm (12 in.) cylinders cured with the member according to

Article 1020.13. Members shall not be shipped until 28-day strengths have been attained and members have a yard age of at least 4 days.”

Delete the third paragraph of Article 512.03(a) of the Standard Specifications.

Delete the last sentence of the second paragraph of Article 512.04(d) of the Standard Specifications.

Revise the “Index Table of Curing and Protection of Concrete Construction” table of Article 1020.13 of the Standard Specifications to read:

"INDEX TABLE OF CURING AND PROTECTION OF CONCRETE CONSTRUCTION"			
TYPE OF CONSTRUCTION	CURING METHODS	CURING PERIOD DAYS	LOW AIR TEMPERATURE PROTECTION METHODS
Cast-in-Place Concrete: ^{11/}			
Pavement			
Shoulder	1020.13(a)(1)(2)(3)(4)(5) ^{3/ 5/}	3	1020.13(c)
Base Course			
Base Course Widening	1020.13(a)(1)(2)(3)(4)(5) ^{1/ 2/}	3	1020.13(c)
Driveway			
Median			
Curb			
Gutter	1020.13(a)(1)(2)(3)(4)(5) ^{4/ 5/}	3	1020.13(c) ^{16/}
Curb and Gutter			
Sidewalk			
Slope Wall			
Paved Ditch			
Catch Basin			
Manhole	1020.13(a)(1)(2)(3)(4)(5) ^{4/}	3	1020.13(c)
Inlet			
Valve Vault			
Pavement Patching	1020.13(a)(1)(2)(3)(4)(5) ^{2/}	3 ^{12/}	1020.13(c)
Pavement Replacement	1020.13(a)(1)(2)(3)(4)(5) ^{1/ 2/}	3	442.06(h) and 1020.13(c)
Railroad Crossing	1020.13(a)(3)(5)	1	1020.13(c)
Piles	1020.13(a)(3)(5)	7	1020.13(e)(1)(2)(3)
Footings			
Foundation Seals	1020.13(a)(1)(2)(3)(4)(5) ^{4/6/}	7	1020.13(e)(1)(2)(3)
Substructure	1020.13(a)(1)(2)(3)(4)(5) ^{1/7/}	7	1020.13(e)(1)(2)(3)
Superstructure (except deck)	1020.13(a)(1)(2)(3)(5) ^{8/}	7	1020.13(e)(1)(2)
Deck	1020.13(a)(5)	7	1020.13(e)(1)(2) ^{17/}
Retaining Walls	1020.13(a)(1)(2)(3)(4)(5) ^{1/7/}	7	1020.13(e)(1)(2)
Pump Houses	1020.13(a)(1)(2)(3)(4)(5) ^{1/}	7	1020.13(e)(1)(2)
Culverts	1020.13(a)(1)(2)(3)(4)(5) ^{4/6/}	7	1020.13(e)(1)(2) ^{18/}
Other Incidental Concrete	1020.13(a)(1)(2)(3)(5)	3	1020.13(c)
Precast Concrete: ^{11/}			
Bridge Beams			
Piles			
Bridge Slabs	1020.13(a)(3)(5) ^{9/10/}	As required.	^{13/} 504.06(c)(6), 1020.13(e)(2) ^{19/}
Nelson Type Structural Member			
All Other Precast Items	1020.13(a)(3)(4)(5) ^{2/9/10/}	As required.	^{14/} 504.06(c)(6), 1020.13(e)(2) ^{19/}
Precast, Prestressed Concrete: ^{11/}			
All Items	1020.13(a)(3)(5) ^{9/10/}	Until strand tensioning is released. ^{15/}	504.06(c)(6), 1020.13(e)(2) ^{19/}

Notes-General:

- 1/ Type I, membrane curing only
- 2/ Type II, membrane curing only
- 3/ Type III, membrane curing only
- 4/ Type I, II and III membrane curing
- 5/ Membrane curing will not be permitted between November 1 and April 15.
- 6/ The use of water to inundate footings, foundation seals or the bottom slab of culverts is permissible when approved by the Engineer, provided the water temperature can be maintained at 7 °C (45 °F) or higher.
- 7/ Asphalt Emulsion for Waterproofing may be used in lieu of other curing methods when specified and permitted according to Article 503.18.
- 8/ On non-traffic surfaces which receive protective coat according to Article 503.19, a linseed oil emulsion curing compound may be used as a substitute for protective coat and other curing methods. The linseed emulsion curing compound will be permitted between April 16 and October 31 of the same year, provided it is applied with a mechanical sprayer according to Article 1101.09 (b), and meets the material requirements of Article 1022.07.
- 9/ Steam curing (heat and moisture) is acceptable and shall be accomplished by the method specified in Article 504.06(c)(6).
- 10/ A moist room according to AASHTO M 201 is acceptable for curing.
- 11/ If curing is required and interrupted because of form removal for cast-in-place concrete items, precast concrete products, or precast prestressed concrete products, the curing shall be resumed within two hours from the start of the form removal.
- 12/ Curing maintained only until opening strength is attained, with a maximum curing period of three days.
- 13/ The curing period shall end when the concrete has attained the mix design strength. The producer has the option to discontinue curing when the concrete has attained 80 percent of the mix design strength or after seven days. All strength test specimens shall remain with the units and shall be subjected to the same curing method and environmental condition as the units, until the time of testing.
- 14/ The producer shall determine the curing period or may elect to not cure the product. All strength test specimens shall remain with the units and shall be subjected to the same curing method and environmental condition as the units, until the time of testing.
- 15/ The producer has the option to continue curing after strand release.
- 16/ When structural steel or structural concrete is in place above slope wall, Article 1020.13(c) shall not apply. The protection method shall be according to Article 1020.13(e)(1).
- 17/ When Article 1020.13(e)(2) is used to protect the deck, the housing may enclose only the bottom and sides. The top surface shall be protected according to Article 1020.13(e)(1).
- 18/ For culverts having a waterway opening of 1 sq m (10 sq ft) or less, the culverts may be protected according to Article 1020.13(e)(3).
- 19/ The seven day protection period in the first paragraph of Article 1020.13(e)(2) shall not apply. The protection period shall end when curing is finished. For the third paragraph of Article 1020.13(e)(2), the decrease in temperature shall be according to Article 504.06(c)(6)."

Add the following to Article 1020.13(a) of the Standard Specifications:

“(5) Wetted Cotton Mat Method. After the surface of concrete has been textured or finished, it shall be covered immediately with dry cotton mats. The cotton mats shall be placed in a manner which will not mar the concrete surface. A texture resulting from the cotton mat material is acceptable. The cotton mats shall then be wetted immediately and thoroughly soaked with a gentle spray of water. For bridge decks, a foot bridge shall be used to place and wet the cotton mats.

The cotton mats shall be maintained in a wetted condition until the concrete has hardened sufficiently to place soaker hoses without marring the concrete surface. The soaker hoses shall be placed on top of the cotton mats at a maximum 1.2 m (4 ft) spacing. The cotton mats shall be kept wet with a continuous supply of water for the remainder of the curing period. Other continuous wetting systems may be used if approved by the Engineer.

After placement of the soaker hoses, the cotton mats shall be covered with white polyethylene sheeting or burlap-polyethylene blankets.

For construction items other than bridge decks, soaker hoses or a continuous wetting system will not be required if the alternative method keeps the cotton mats wet. Periodic wetting of the cotton mats is acceptable.

For areas inaccessible to the cotton mats on bridge decks, curing shall be according to Article 1020.13(a)(3).”

Revise the first paragraph of Article 1020.13(c) of the Standard Specifications to read:

“Protection of Portland Cement Concrete, Other Than Structures, From Low Air Temperatures. When the official National Weather Service forecast for the construction area predicts a low of 0 °C (32 °F), or lower, or if the actual temperature drops to 0 °C (32 °F), or lower, concrete less than 72 hours old shall be provided at least the following protection:”

Delete Article 1020.13(d) and Articles 1020.13(d)(1),(2),(3),(4) of the Standard Specifications.

Revise the first five paragraphs of Article 1020.13(e) of the Standard Specifications to read:

“Protection of Portland Cement Concrete Structures From Low Air Temperatures. When the official National Weather Service Forecast for the construction area predicts a low below 7 °C (45 °F), or if the actual temperature drops below 7 °C (45 °F), concrete less than 72 hours old shall be provided protection. Concrete shall also be provided protection when placed during the winter period of December 1 through March 15. Concrete shall not be placed until the materials, facilities and equipment for protection are approved by the Engineer.

When directed by the Engineer, the Contractor may be required to place concrete during the winter period. If winter construction is specified, the Contractor shall proceed with the construction, including concrete, excavation, pile driving, steel erection and all appurtenant work required for the complete construction of the item, except at times when weather conditions make such operations impracticable.

Regardless of the precautions taken, the Contractor shall be responsible for protection of the concrete placed and any concrete damaged by cold temperatures shall be removed and replaced by the Contractor at his/her own expense.”

Add the following at the end of the third paragraph of Article 1020.13(e)(1) of the Standard Specifications:

“The Contractor shall provide means for checking the temperature of the surface of the concrete during the protection period.”

Revise the second sentence of the first paragraph of Article 1020.13(e)(2) of the Standard Specifications to read:

“The Contractor shall provide means for checking the temperature of the surface of the concrete or air temperature within the housing during the protection period.”

Delete the last sentence of the first paragraph of Article 1020.13(e)(3) of the Standard Specifications.

Add the following Article to Section 1022 of the Standard Specifications:

“1022.06 Cotton Mats. Cotton mats shall consist of a cotton fill material, minimum 400 g/sq m (11.8 oz/sq yd), covered with unsized cloth or burlap, minimum 200 g/sq m (5.9 oz/sq yd), and be tufted or stitched to maintain stability.

Cotton mats shall be in a condition satisfactory to the Engineer. Any tears or holes in the mats shall be repaired.

Add the following Article to Section 1022 of the Standard Specifications:

“1022.07 Linseed Oil Emulsion Curing Compound. Linseed oil emulsion curing compound shall be composed of a blend of boiled linseed oil and high viscosity, heavy bodied linseed oil emulsified in a water solution. The curing compound shall meet the requirements of a Type I, II, or III according to Article 1022.01, except the drying time requirement will be waived. The oil phase shall be 50 ± 4 percent by volume. The oil phase shall consist of 80 percent by mass (weight) boiled linseed oil and 20 percent by mass (weight) Z-8 viscosity linseed oil. The water phase shall be 50 ± 4 percent by volume.”

Revise Article 1020.14 of the Standard Specifications to read:

“1020.14 Temperature Control for Placement. Temperature control for concrete placement shall conform to the following requirements:

- (a) Temperature Control other than Structures. The temperature of concrete immediately before placing, shall be not less than 10 °C (50 °F) nor more than 32 °C (90 °F). Aggregates and/or water shall be heated or cooled as necessary to produce concrete within these temperature limits.

When the temperature of the plastic concrete reaches 30 °C (85 °F), an approved retarding admixture shall be used or the approved water reducing admixture in use shall have its dosage increased by 50 percent over the dosage recommended on the Department's Approved List of Concrete Admixtures for the temperature experienced. The amount of retarding admixture to be used will be determined by the Engineer. This requirement may be waived by the Engineer when fly ash compensated mixtures are used.

Plastic concrete temperatures up to 35 °C (96 °F), as placed, may be permitted provided job site conditions permit placement and finishing without excessive use of water on and/or overworking of the surface. The occurrence within 24 hours of unusual surface distress shall be cause to revert to a maximum 32 °C (90 °F) plastic concrete temperature.

Concrete shall not be placed when the air temperature is below 5 °C (40 °F) and falling or below 2 °C (35 °F), without permission of the Engineer. When placing of concrete is authorized during cold weather, the Engineer may require the water and/or the aggregates to be heated to not less than 20 °C (70 °F) nor more than 65 °C (150 °F). The aggregates may be heated by either steam or dry heat prior to being placed in the mixer. The apparatus used shall heat the mass uniformly and shall be so arranged as to preclude the possible occurrence of overheated areas which might damage the materials. No frozen aggregates shall be used in the concrete.

For pavement patching, refer to Article 442.06(e) for additional information on temperature control for placement.

- (b) Temperature Control for Structures. The temperature of concrete as placed in the forms shall be not less than 10 °C (50 °F) nor more than 32 °C (90 °F). Aggregates and/or water shall be heated or cooled as necessary to produce concrete within these temperature limits. When insulated forms are used, the temperature of the concrete mixture shall not exceed 25 °C (80 °F). If the Engineer determines that heat of hydration might cause excessive temperatures in the concrete, the concrete shall be placed at a temperature between 10 °C (50 °F) and 15 °C (60 °F), per the Engineer's instructions. When concrete is placed in contact with previously placed concrete, the temperature of the concrete may be increased as required to offset anticipated heat loss.

Concrete shall not be placed when the air temperature is below 7 °C (45 °F) and falling or below 4 °C (40 °F), without permission of the Engineer. When placing of concrete is authorized during cold weather, the Engineer may require the water and/or the aggregates to be heated to not less than 20 °C (70 °F) nor more than 65 °C (150 °F). The aggregates may be heated by either steam or dry heat prior to being placed in the mixer. The apparatus used shall heat the mass uniformly and shall be so arranged as to preclude the possible occurrence of overheated areas which might damage the materials. No frozen aggregates shall be used in the concrete.

When the temperature of the plastic concrete reaches 30 °C (85 °F), an approved retarding admixture shall be used or the approved water reducing admixture in use shall have its dosage increased by 50 percent over the dosage recommended on the Department's Approved List of Concrete Admixtures for the temperature experienced.

The amount of retarding admixture to be used will be determined by the Engineer. This requirement may be waived by the Engineer when fly ash compensated mixtures are used.

- (c) Temperature. The concrete temperature shall be determined according to ASTM C 1064.”

DISADVANTAGED BUSINESS ENTERPRISE PARTICIPATION (BDE)

Effective: September 1, 2000

Revised: June 1, 2004

FEDERAL OBLIGATION. The Department of Transportation, as a recipient of federal financial assistance, is required to take all necessary and reasonable steps to ensure nondiscrimination in the award and administration of contracts. Consequently, the federal regulatory provisions of 49 CFR part 26 apply to this contract concerning the utilization of disadvantaged business enterprises. This Special Provision will also be used by the Department to satisfy the requirements of the Business Enterprise for Minorities, Females, and Persons with Disabilities Act, 30 ILCS 575. For the purposes of this Special Provision, a disadvantaged business enterprise (DBE) means a business certified by the Department in accordance with the requirements of 49 CFR part 26 and listed in the DBE Directory or most recent addendum.

CONTRACTOR ASSURANCE. The Contractor makes the following assurance and agrees to include the assurance in each subcontract that the Contractor signs with a subcontractor:

The contractor, subrecipient or subcontractor shall not discriminate on the basis of race, color, national origin, or sex in the performance of this contract. The contractor shall carry out applicable requirements of 49 CFR part 26 in the award and administration of federally-assisted contracts. Failure by the contractor to carry out these requirements is a material breach of this contract, which may result in the termination of this contract or such other remedy as the recipient deems appropriate.

OVERALL GOAL SET FOR THE DEPARTMENT. As a requirement of compliance with 49 CFR part 26, the Department has set an overall goal for DBE participation in its federally assisted contracts. That goal applies to all federal-aid funds the Department will expend in its federally assisted contracts for the subject reporting fiscal year. The Department is required to make a good faith effort to achieve the overall goal. The dollar amount paid to all approved DBE firms performing work called for in this contract is eligible to be credited toward fulfillment of the Department's overall goal.

CONTRACT GOAL TO BE ACHIEVED BY THE CONTRACTOR. This contract includes a specific DBE utilization goal established by the Department. The goal has been included because the Department has determined that the work of this contract has subcontracting opportunities that may be suitable for performance by DBE companies. This determination is based on an assessment of the type of work, the location of the work, and the availability of DBE companies to do a part of the work. The assessment indicates that, in the absence of unlawful discrimination, and in an arena of fair and open competition, DBE companies can be expected to perform 8.0% of the work. This percentage is set as the DBE participation goal for this contract. Consequently, in addition to the other award criteria established for this contract, the Department will award this contract to a bidder who makes a good faith effort to meet this

goal of DBE participation in the performance of the work. A bidder makes a good faith effort for award consideration if either of the following is done in accordance with the procedures set forth in this Special Provision:

- (a) The bidder documents that firmly committed DBE participation has been obtained to meet the goal; or
- (b) The bidder documents that a good faith effort has been made to meet the goal, even though the effort did not succeed in obtaining enough DBE participation to meet the goal.

DBE LOCATOR REFERENCES. Bidders may consult the DBE Directory as a reference source for DBE companies certified by the Department. In addition, the Department maintains a letting and item specific DBE locator information system whereby DBE companies can register their interest in providing quotes on particular bid items advertised for letting. Information concerning DBE companies willing to quote work for particular contracts may be obtained by contacting the Department's Bureau of Small Business Enterprises at telephone number (217)785-4611, or by visiting the Department's web site at www.dot.state.il.us.

BIDDING PROCEDURES. Compliance with the bidding procedures of this Special Provision is required prior to the award of the contract and the failure of the as-read low bidder to comply will render the bid nonresponsive.

- (a) In order to assure the timely award of the contract, the as-read low bidder must submit a Disadvantaged Business Utilization Plan on Department form SBE 2026 within seven (7) working days after the date of letting. To meet the seven (7) day requirement, the bidder may send the Plan by certified mail or delivery service within the seven (7) working day period. If a question arises concerning the mailing date of a Plan, the mailing date will be established by the U.S. Postal Service postmark on the original certified mail receipt from the U.S. Postal Service or the receipt issued by a delivery service. It is the responsibility of the as-read low bidder to ensure that the postmark or receipt date is affixed within the seven (7) working days if the bidder intends to rely upon mailing or delivery to satisfy the submission day requirement. The Plan is to be submitted to the Department of Transportation, Bureau of Small Business Enterprises, Contract Compliance Section, 2300 South Dirksen Parkway, Room 319, Springfield, Illinois 62764 (Telefax: (217)785-1524). It is the responsibility of the bidder to obtain confirmation of telefax delivery. The Department will not accept a Utilization Plan if it does not meet the seven (7) day submittal requirement, and the bid will be declared nonresponsive. In the event the bid is declared nonresponsive due to a failure to submit a Plan or failure to comply with the bidding procedures set forth herein, the Department may elect to cause the forfeiture of the penal sum of the bidder's proposal guaranty, and may deny authorization to bid the project if re-advertised for bids. The Department reserves the right to invite any other bidder to submit a Utilization Plan at any time for award consideration or to extend the time for award.
- (b) The Utilization Plan shall indicate that the bidder either has obtained sufficient DBE participation commitments to meet the contract goal or has not obtained enough DBE participation commitments in spite of a good faith effort to meet the goal. The Utilization Plan shall further provide the name, telephone number and telefax number of a

responsible official of the bidder designated for purposes of notification of plan approval or disapproval under the procedures of this Special Provision.

- (c) The Utilization Plan shall include a DBE Participation Commitment Statement, Department form SBE 2025, for each DBE proposed for the performance of work to achieve the contract goal. The signatures on these forms must be original signatures. All elements of information indicated on the said form shall be provided, including but not limited to the following:
- (1) The name and address of each DBE to be used;
 - (2) A description, including pay item numbers, of the commercially useful work to be done by each DBE;
 - (3) The price to be paid to each DBE for the identified work specifically stating the quantity, unit price and total subcontract price for the work to be completed by the DBE. If partial pay items are to be performed by the DBE, indicate the portion of each item, a unit price where appropriate and the subcontract price amount;
 - (4) A commitment statement signed by the bidder and each DBE evidencing availability and intent to perform commercially useful work on the project; and
 - (5) If the bidder is a joint venture comprised of DBE firms and non-DBE firms, the plan must also include a clear identification of the portion of the work to be performed by the DBE partner(s).
- (d) The contract will not be awarded until the Utilization Plan submitted by the bidder is approved. The Utilization Plan will be approved by the Department if the Plan commits sufficient commercially useful DBE work performance to meet the contract goal. The Utilization Plan will not be approved by the Department if the Plan does not commit sufficient DBE performance to meet the contract goal unless the bidder documents that it made a good faith effort to meet the goal. The good faith procedures of Section VIII of this special provision apply. If the Utilization Plan is not approved because it is deficient in a technical matter, unless waived by the Department, the bidder will be notified and will be allowed no less than a five (5) working day period in order to cure the deficiency.

CALCULATING DBE PARTICIPATION. The Utilization Plan values represent work anticipated to be performed and paid for upon satisfactory completion. The Department is only able to count toward the achievement of the overall goal and the contract goal the value of payments made for the work actually performed by DBE companies. In addition, a DBE must perform a commercially useful function on the contract to be counted. A commercially useful function is generally performed when the DBE is responsible for the work and is carrying out its responsibilities by actually performing, managing, and supervising the work involved. The Department and Contractor are governed by the provisions of 49 CFR part 26.55(c) on questions of commercially useful functions as it affects the work. Specific counting guidelines are provided in 49 CFR part 26.55, the provisions of which govern over the summary contained herein.

- (a) DBE as the Contractor: 100% goal credit for that portion of the work performed by the DBE's own forces, including the cost of materials and supplies. Work that a DBE subcontracts to a non-DBE firm does not count toward the DBE goals.
- (b) DBE as a joint venture Contractor: 100% goal credit for that portion of the total dollar value of the contract equal to the distinct, clearly defined portion of the work performed by the DBE's own forces.
- (c) DBE as a subcontractor: 100% goal credit for the work of the subcontract performed by the DBE's own forces, including the cost of materials and supplies, excluding the purchase of materials and supplies or the lease of equipment by the DBE subcontractor from the prime contractor or its affiliates. Work that a DBE subcontractor in turn subcontracts to a non-DBE firm does not count toward the DBE goal.
- (d) DBE as a trucker: 100% goal credit for trucking participation provided the DBE is responsible for the management and supervision of the entire trucking operation for which it is responsible. At least one truck owned, operated, licensed and insured by the DBE must be used on the contract. Credit will be given for the full value of all such DBE trucks operated using DBE employed drivers. Goal credit will be limited to the value of the reasonable fee or commission received by the DBE if trucks are leased from a non-DBE company.
- (e) DBE as a material supplier:
 - (1) 60% goal credit for the cost of the materials or supplies purchased from a DBE regular dealer.
 - (2) 100% goal credit for the cost of materials or supplies obtained from a DBE manufacturer.
 - (3) 100% credit for the value of reasonable fees and commissions for the procurement of materials and supplies if not a regular dealer or manufacturer.

GOOD FAITH EFFORT PROCEDURES. If the bidder cannot obtain sufficient DBE commitments to meet the contract goal, the bidder must document in the Utilization Plan the good faith efforts made in the attempt to meet the goal. This means that the bidder must show that all necessary and reasonable steps were taken to achieve the contract goal. Necessary and reasonable steps are those which could reasonably be expected to obtain sufficient DBE participation. The Department will consider the quality, quantity and intensity of the kinds of efforts that the bidder has made. Mere *pro forma* efforts are not good faith efforts; rather, the bidder is expected to have taken those efforts that would be reasonably expected of a bidder actively and aggressively trying to obtain DBE participation sufficient to meet the contract goal.

- (a) The following is a list of types of action that the Department will consider as part of the evaluation of the bidder's good faith efforts to obtain participation. These listed factors are not intended to be a mandatory checklist and are not intended to be exhaustive. Other factors or efforts brought to the attention of the Department may be relevant in appropriate cases, and will be considered by the Department.

- (1) Soliciting through all reasonable and available means (e.g. attendance at pre-bid meetings, advertising and/or written notices) the interest of all certified DBE companies that have the capability to perform the work of the contract. The bidder must solicit this interest within sufficient time to allow the DBE companies to respond to the solicitation. The bidder must determine with certainty if the DBE companies are interested by taking appropriate steps to follow up initial solicitations.
- (2) Selecting portions of the work to be performed by DBE companies in order to increase the likelihood that the DBE goals will be achieved. This includes, where appropriate, breaking out contract work items into economically feasible units to facilitate DBE participation, even when the prime contractor might otherwise prefer to perform these work items with its own forces.
- (3) Providing interested DBE companies with adequate information about the plans, specifications, and requirements of the contract in a timely manner to assist them in responding to a solicitation.
- (4) a. Negotiating in good faith with interested DBE companies. It is the bidder's responsibility to make a portion of the work available to DBE subcontractors and suppliers and to select those portions of the work or material needs consistent with the available DBE subcontractors and suppliers, so as to facilitate DBE participation. Evidence of such negotiation includes the names, addresses, and telephone numbers of DBE companies that were considered; a description of the information provided regarding the plans and specifications for the work selected for subcontracting; and evidence as to why additional agreements could not be reached for DBE companies to perform the work.
 - b. A bidder using good business judgment would consider a number of factors in negotiating with subcontractors, including DBE subcontractors, and would take a firm's price and capabilities as well as contract goals into consideration. However, the fact that there may be some additional costs involved in finding and using DBE companies is not in itself sufficient reason for a bidder's failure to meet the contract DBE goal, as long as such costs are reasonable. Also, the ability or desire of a prime contractor to perform the work of a contract with its own organization does not relieve the bidder of the responsibility to make good faith efforts. Prime contractors are not, however, required to accept higher quotes from DBE companies if the price difference is excessive or unreasonable.
- (5) Not rejecting DBE companies as being unqualified without sound reasons based on a thorough investigation of their capabilities. The contractor's standing within its industry, membership in specific groups, organizations, or associations and political or social affiliations (for example union vs. non-union employee status) are not legitimate causes for the rejection or non-solicitation of bids in the contractor's efforts to meet the project goal.
- (6) Making efforts to assist interested DBE companies in obtaining bonding, lines of credit, or insurance as required by the recipient or contractor.

- (7) Making efforts to assist interested DBE companies in obtaining necessary equipment, supplies, materials, or related assistance or services.
 - (8) Effectively using the services of available minority/women community organizations; minority/women contractors' groups; local, state, and Federal minority/women business assistance offices; and other organizations as allowed on a case-by-case basis to provide assistance in the recruitment and placement of DBE companies.
- (b) If the Department determines that the Contractor has made a good faith effort to secure the work commitment of DBE companies to meet the contract goal, the Department will award the contract provided that it is otherwise eligible for award. If the Department determines that a good faith effort has not been made, the Department will notify the bidder of that preliminary determination by contacting the responsible company official designated in the Utilization Plan. The preliminary determination shall include a statement of reasons why good faith efforts have not been found, and may include additional good faith efforts that the bidder could take. The notification will designate a five (5) working day period during which the bidder shall take additional efforts. The bidder is not limited by a statement of additional efforts, but may take other action beyond any stated additional efforts in order to obtain additional DBE commitments. The bidder shall submit an amended Utilization Plan if additional DBE commitments to meet the contract goal are secured. If additional DBE commitments sufficient to meet the contract goal are not secured, the bidder shall report the final good faith efforts made in the time allotted. All additional efforts taken by the bidder will be considered as part of the bidder's good faith efforts. If the bidder is not able to meet the goal after taking additional efforts, the Department will make a pre-final determination of the good faith efforts of the bidder and will notify the designated responsible company official of the reasons for an adverse determination.
- (c) The bidder may request administrative reconsideration of a pre-final determination adverse to the bidder within the five (5) working days after the notification date of the determination by delivering the request to the Department of Transportation, Bureau of Small Business Enterprises, Contract Compliance Section, 2300 South Dirksen Parkway, Room 319, Springfield, Illinois 62764 (Telefax: (217)785-1524). Deposit of the request in the United States mail on or before the fifth business day shall not be deemed delivery. The pre-final determination shall become final if a request is not made and delivered. A request may provide additional written documentation and/or argument concerning the issue of whether an adequate good faith effort was made to meet the contract goal. In addition, the request shall be considered a consent by the bidder to extend the time for award. The request will be forwarded to the Department's Reconsideration Officer. The Reconsideration Officer will extend an opportunity to the bidder to meet in person in order to consider all issues of whether the bidder made a good faith effort to meet the goal. After the review by the Reconsideration Officer, the bidder will be sent a written decision within ten (10) working days after receipt of the request for reconsideration, explaining the basis for finding that the bidder did or did not meet the goal or make adequate good faith efforts to do so. A final decision by the Reconsideration Officer that a good faith effort was made shall approve the Utilization Plan submitted by the bidder and shall clear the contract for award. A final decision that a good faith effort was not made shall render the bid nonresponsive.

CONTRACT COMPLIANCE. Compliance with this Special Provision is an essential part of the contract. The Department is prohibited by federal regulations from crediting the participation of a DBE included in the Utilization Plan toward either the contract goal or the Department's overall goal until the amount to be applied toward the goals has been paid to the DBE. The following administrative procedures and remedies govern the compliance by the Contractor with the contractual obligations established by the Utilization Plan. After approval of the Plan and award of the contract, the Utilization Plan and individual DBE Participation Statements become part of the contract. If the contractor did not succeed in obtaining enough DBE participation to achieve the advertised contract goal, and the Utilization Plan was approved and contract awarded based upon a determination of good faith, the total dollar value of DBE work calculated in the approved Utilization Plan as a percentage of the awarded contract value shall become the amended contract goal.

- (a) No amendment to the Utilization Plan may be made without prior written approval from the Department's Bureau of Small Business Enterprises. All requests for amendment to the Utilization Plan shall be submitted to the Department of Transportation, Bureau of Small Business Enterprises, Contract Compliance Section, 2300 South Dirksen Parkway, Room 319, Springfield, Illinois 62764. Telephone number (217) 785-4611. Telefax number (217) 785-1524.
- (b) All work indicated for performance by an approved DBE shall be performed, managed and supervised by the DBE executing the Participation Statement. The Contractor shall not terminate for convenience a DBE listed in the Utilization Plan and then perform the work of the terminated DBE with its own forces, those of an affiliate or those of another subcontractor, whether DBE or not, without first obtaining the written consent of the Bureau of Small Business Enterprises to amend the Utilization Plan. If a DBE listed in the Utilization Plan is terminated for reasons other than convenience, or fails to complete its work on the contract for any reason, the Contractor shall make good faith efforts to find another DBE to substitute for the terminated DBE. The good faith efforts shall be directed at finding another DBE to perform at least the same amount of work under the contract as the DBE that was terminated, but only to the extent needed to meet the contract goal or the amended contract goal. The Contractor shall notify the Bureau of Small Business Enterprises of any termination for reasons other than convenience, and shall obtain approval for inclusion of the substitute DBE in the Utilization Plan. If good faith efforts following a termination of a DBE for cause are not successful, the Contractor shall contact the Bureau and provide a full accounting of the efforts undertaken to obtain substitute DBE participation. The Bureau will evaluate the good faith efforts in light of all circumstances surrounding the performance status of the contract, and determine whether the contract goal should be amended.
- (c) The Contractor shall maintain a record of payments for work performed to the DBE participants. The records shall be made available to the Department for inspection upon request. After the performance of the final item of work or delivery of material by a DBE and final payment therefor to the DBE by the Contractor, but not later than thirty (30) calendar days after payment has been made by the Department to the Contractor for such work or material, the Contractor shall submit a DBE Payment Report on Department form SBE 2115 to the District Engineer. If full and final payment has not been made to the DBE, the Report shall indicate whether a disagreement as to the payment required exists between the Contractor and the DBE or if the Contractor

believes that the work has not been satisfactorily completed. If the Contractor does not have the full amount of work indicated in the Utilization Plan performed by the DBE companies indicated in the Plan, the Department will deduct from contract payments to the Contractor the amount of the goal not achieved as liquidated and ascertained damages.

- (d) The Department reserves the right to withhold payment to the Contractor to enforce the provisions of this Special Provision. Final payment shall not be made on the contract until such time as the Contractor submits sufficient documentation demonstrating achievement of the goal in accordance with this Special Provision or after liquidated damages have been determined and collected.

FLAGGER VESTS (BDE)

Effective: April 1, 2003

Revised: April 1, 2005

Revise the first sentence of Article 701.04(c)(1) of the Standard Specifications to read:

“The flagger shall be stationed to the satisfaction of the Engineer and be equipped with a fluorescent orange, fluorescent yellow/green or a combination of fluorescent orange and fluorescent yellow/green vest meeting the requirements of the American National Standards Institute specification ANSI/ISEA 107-1999 for Conspicuity Class 2 garments and approved flagger traffic control signs conforming to Standard 702001 and Article 702.05(e).”

Revise Article 701.04(c)(6) of the Standard Specifications to read:

“(6) Nighttime Flagging. The flagger station shall be lit by additional overhead lighting other than streetlights. The flagger shall be equipped with a fluorescent orange, fluorescent yellow/green, or a combination of fluorescent orange and fluorescent yellow/green garment meeting the requirements of the American National Standards Institute specification ANSI/ISEA 107-1999 for Conspicuity Class 3 garments.”

FREEZE-THAW RATING (BDE)

Effective: November 1, 2002

Revise the first sentence of Article 1004.02(f) of the Standard Specifications to read:

“When coarse aggregate is used to produce portland cement concrete for base course, base course widening, pavement, driveway pavement, sidewalk, shoulders, curb, gutter, combination curb and gutter, median, paved ditch or their repair using concrete, the gradation permitted will be determined from the results of the Department’s Freeze-Thaw Test.”

PARTIAL PAYMENTS (BDE)

Effective: September 1, 2003

Revise Article 109.07 of the Standard Specifications to read:

"109.07 Partial Payments. Partial payments will be made as follows:

- (a) Progress Payments. At least once each month, the Engineer will make a written estimate of the amount of work performed in accordance with the contract, and the value thereof at the contract unit prices. The amount of the estimate approved as due for payment will be vouchered by the Department and presented to the State Comptroller for payment. No amount less than \$1000.00 will be approved for payment other than the final payment.

The failure to perform any requirement, obligation, or term of the contract by the Contractor shall be reason for withholding any progress payments until the Department determines that compliance has been achieved. Furthermore, progress payments may be reduced by liens filed pursuant to Section 23(c) of the Mechanics Lien Act, 770 ILCS 60/23(c).

- (b) Material Allowances. At the discretion of the Department, payment may be made for materials, prior to their use in the work, when satisfactory evidence is presented by the Contractor. Satisfactory evidence includes justification for the allowance (to expedite the work, meet project schedules, regional or national material shortages, etc.), documentation of material and transportation costs, and evidence that such material is properly stored on the project or at a secure location acceptable and accessible to the Department.

Material allowances will be considered only for nonperishable materials when the cost, including transportation, exceeds \$10,000 and such materials are not expected to be utilized within 60 days of the request for the allowance. For contracts valued under \$500,000, the minimum \$10,000 requirement may be met by combining the principal (material) product of no more than two contract items. An exception to this two item limitation may be considered for any contract regardless of value for items in which material (products) are similar except for type and/or size.

Material allowances shall not exceed the value of the contract items in which used and shall not include the cost of installation or related markups. Amounts paid by the Department for material allowances will be deducted from estimates due the Contractor as the material is used. Two-sided copies of the Contractor's cancelled checks for materials and transportation must be furnished to the Department within 60 days of payment of the allowances or the amounts will be reclaimed by the Department."

PAYMENTS TO SUBCONTRACTORS (BDE)

Effective: June 1, 2000

Revised: September 1, 2003

Federal regulations found at 49 CFR §26.29 mandate the Department to establish a contract clause to require Contractors to pay subcontractors for satisfactory performance of their subcontracts no later than 30 days from the receipt of each payment made to the Contractor.

State law addresses the timing of payments to be made to subcontractors. Section 7 of the Prompt Payment Act, 30 ILCS 540/7, generally requires that when a Contractor receives any payment from the Department, the Contractor is required to make corresponding, proportional payments to each subcontractor performing work within 15 calendar days after receipt of the state payment. Section 7 of the State Prompt Payment Act further provides that interest in the amount of 2% per month, in addition to the payment due, shall be paid to any subcontractor by the Contractor if the payment required by the Act is withheld or delayed without reasonable cause. The Act also provides that the time for payment required and the calculation of any interest due applies to transactions between subcontractors and lower-tier subcontractors throughout the contracting chain.

This Special Provision establishes the required federal contract clause, and adopts the 15 calendar day requirement of the Act for purposes of compliance with the federal regulation regarding payments to subcontractors. This contract is subject to the following payment obligations.

As progress payments are made to the Contractor in accordance with Article 109.07 of the Standard Specifications for Road and Bridge Construction, the Contractor shall make a corresponding partial payment within 15 calendar days to each subcontractor in proportion to the work satisfactorily completed by each subcontractor. The proportionate amount of partial payment due to each subcontractor shall be determined by the quantities measured or otherwise determined as eligible for payment by the Department and included in the progress payment to the Contractor. Subcontractors shall be paid in full within 15 calendar days after the subcontractor's work has been satisfactorily completed. The Contractor shall hold no retainage from the subcontractors.

This Special Provision does not create any rights in favor of any subcontractor against the State of Illinois or authorize any cause of action against the State of Illinois on account of any payment, nonpayment, delayed payment or interest claimed by application of the State Prompt Payment Act. The Department will neither determine the reasonableness of any cause for delay of payment nor enforce any claim to payment, including interest. Moreover, the Department will not approve any delay or postponement of the 15 day requirement. State law creates remedies available to any subcontractor or material supplier, regardless of tier, who has not been paid for work properly performed or material furnished. These remedies are a lien against public funds set forth in Section 23(c) of the Mechanics Lien Act, 770 ILCS 60/23(c), and a recovery on the Contractor's payment bond in accordance with the Public Construction Bond Act, 30 ILCS 550.

PERSONAL PROTECTIVE EQUIPMENT (BDE)

Effective: July 1, 2004

All personnel, excluding flaggers, working outside of a vehicle (car or truck) within 7.6 m (25 ft) of pavement open to traffic shall wear a fluorescent orange, fluorescent yellow/green or a combination of fluorescent orange and fluorescent yellow/.green vest meeting the requirements of the American National Standards Institute specification ANSI/ISEA 107-1999 for Conspicuity Class 2 garments. Other types of garments may be substituted for the vest as long as the garments have manufacturers tags identifying them as meeting the ANSI Class 2 requirement.

PORTLAND CEMENT (BDE)

Effective: January 1, 2005

Replace the first sentence of the second paragraph of Article 1001.01 of the Standard Specifications with the following:

“For portland cement according to ASTM C 150, the addition of up to 5.0 percent limestone by mass (weight) to the cement will not be permitted. Also, the total of all organic processing additions shall not exceed 1.0 percent by mass (weight) of the cement and the total of all inorganic processing additions shall not exceed 4.0 percent by mass (weight) of the cement.”

PORTLAND CEMENT CONCRETE (BDE)

Effective: November 1, 2002

Add the following paragraph after the fourth paragraph of Article 1103.01(b) of the Standard Specifications:

“The truck mixer shall be approved before use according to the Bureau of Materials and Physical Research’s Policy Memorandum, “Approval of Concrete Plants and Delivery Trucks”.”

Add the following paragraph after the first paragraph of Article 1103.01(c) of the Standard Specifications:

“The truck agitator shall be approved before use according to the Bureau of Materials and Physical Research’s Policy Memorandum, “Approval of Concrete Plants and Delivery Trucks”.”

Add the following paragraph after the first paragraph of Article 1103.01(d) of the Standard Specifications:

“The nonagitator truck shall be approved before use according to the Bureau of Materials and Physical Research’s Policy Memorandum, “Approval of Concrete Plants and Delivery Trucks”.”

Revise the first sentence of the first paragraph of Article 1103.02 of the Standard Specifications to read:

“The plant shall be approved before production begins according to the Bureau of Materials and Physical Research’s Policy Memorandum, “Approval of Concrete Plants and Delivery Trucks”.”

RAP FOR USE IN BITUMINOUS CONCRETE MIXTURES (BDE)

Effective: January 1, 2000

Revised: April 1, 2002

Revise Article 1004.07 to read:

“1004.07 RAP Materials. RAP is reclaimed asphalt pavement resulting from cold milling or crushing of an existing dense graded hot-mix asphalt pavement. RAP must originate from routes or airfields under federal, state or local agency jurisdiction. The Contractor shall supply documentation that the RAP meets these requirements.

(a) Stockpiles. The Contractor shall construct individual, sealed RAP stockpiles meeting one of the following definitions. No additional RAP will be allowed on top of the pile after the pile has been sealed.

(1) Homogeneous. Homogeneous RAP stockpiles shall consist of RAP from Class I/ Superpave, or equivalent mixtures only and represent the same aggregate quality, but shall be at least C quality or better, the same type of crushed aggregate (either crushed natural aggregate, ACBF slag, or steel slag), similar gradation and similar AC content. If approved by the Engineer, combined single pass surface/binder millings may be considered “homogenous”, with a quality rating dictated by the lowest coarse aggregate quality present in the mixture. Homogenous stockpiles shall meet the requirements of Article 1004.07(d). Homogeneous RAP stockpiles not meeting these requirements may be processed (crushing and screening) and retested.

(2) Conglomerate. Conglomerate RAP stockpiles shall consist of RAP from Class I/ Superpave, or equivalent mixtures only. The coarse aggregate in this RAP shall be crushed aggregate only and may represent more than one aggregate type and/or quality but shall be at least C quality or better. This RAP may have an inconsistent gradation and/or asphalt cement content prior to processing. All conglomerate RAP shall be processed prior to testing by crushing to where all RAP shall pass the 16 mm (5/8 in.) or smaller screen. Conglomerate RAP stockpiles shall not contain steel slag or other expansive material as determined by the Department. Conglomerate RAP stockpiles shall meet the requirements of Article 1004.07(d).

(3) Conglomerate “D” Quality (DQ). Conglomerate DQ RAP stockpiles shall consist of RAP containing coarse aggregate (crushed or round) that is at least D quality or better. This RAP may have an inconsistent gradation and/or asphalt content. Conglomerate DQ RAP stockpiles shall not contain steel slag or other expansive material as determined by the Department. Conglomerate DQ RAP shall meet the requirements of Article 1004.07(d).

Reclaimed Superpave Low ESAL IL-9.5L surface mixtures shall only be placed in conglomerate DQ RAP stockpiles due to the potential for rounded aggregate.

(4) Other. RAP stockpiles that do not meet the requirements of the stockpile categories listed above shall be classified as “Other”. “Other” RAP stockpiles shall not be used in any of the Department’s bituminous mixtures.

(b) Use. The allowable use of a RAP stockpile shall be set by the lowest quality of coarse aggregate in the RAP stockpile. Class I/Superpave surface mixtures are designated as containing Class B quality coarse aggregate only. Superpave Low ESAL IL-19.0L binder and IL-9.5L surface mixtures are designated as Class C quality coarse aggregate only. Class I/Superpave binder mixtures, bituminous base course mixtures, and bituminous

base course widening mixtures are designated as containing Class C quality coarse aggregate only. Bituminous stabilized subbase and BAM shoulders are designated as containing Class D quality coarse aggregate only. Any mixture not listed above shall have the designated quality determined by the Department.

RAP containing steel slag or other expansive material, as determined by the Department, shall be homogeneous and will be approved for use in Class I/Superpave (including Low ESAL) surface mixtures only. RAP stockpiles for use in Class I/Superpave mixtures (including Low ESAL), base course, base course widening and Class B mixtures shall be either homogeneous or conglomerate RAP stockpiles except conglomerate RAP stockpiles shall not be used in Superpave surface mixture Ndesign 50 or greater. RAP for use in bituminous aggregate mixtures (BAM) shoulders and BAM stabilized subbase shall be from homogeneous, conglomerate, or conglomerate DQ stockpiles.

Additionally, RAP used in Class I/Superpave surface mixtures shall originate from milled or crushed mixtures only, in which the coarse aggregate is of Class B quality or better. RAP stockpiles for use in Class I/Superpave (including Low ESAL) binder mixes as well as base course, base course widening and Class B mixtures shall originate from milled or processed surface mixture, binder mixture, or a combination of both mixtures uniformly blended to the satisfaction of the Engineer, in which the coarse aggregate is of Class C quality or better.

(c) Contaminants. RAP containing contaminants, such as earth, brick, sand, concrete, sheet asphalt, bituminous surface treatment (i.e. chip seal), pavement fabric, etc., will be unacceptable unless the contaminants are removed to the satisfaction of the Engineer. Sheet asphalt shall be stockpiled separately.

(d) Testing. All RAP shall be sampled and tested either during or after stockpiling.

For testing during stockpiling, washed extraction samples shall be run at the minimum frequency of one sample per 450 metric tons (500 tons) for the first 1800 metric tons (2,000 tons) and one sample per 1800 metric tons (2,000 tons) thereafter. A minimum of five tests shall be required for stockpiles less than 3600 metric tons (4,000 tons).

For testing existing stockpiles, the Contractor shall submit a plan for approval to the District proposing a satisfactory method of sampling and testing the RAP pile either in-situ or by restockpiling. The sampling plan shall meet the minimum frequency required above and detail the procedure used to extract representative samples throughout the pile for testing.

Before extraction, each field sample shall be split to test sample size. One of the two test samples from the final split shall be labeled and stored for Department use. The Contractor shall extract the other test sample according to Department procedure. The Engineer reserves the right to test any sample (split or Department-taken) to verify Contractor test results.

All of the extraction results shall be compiled and averaged for asphalt content and gradation. Individual extraction test results, when compared to the averages, will be accepted if within the tolerances listed below.

Parameter	Homogeneous / Conglomerate	Conglomerate "D" Quality
25 mm (1 in.)		± 5%
12.5 mm (1/2 in.)	± 8%	± 15%
4.75 mm (No. 4)	± 6%	± 13%
2.36 mm (No. 8)	± 5%	
1.18 mm (No. 16)		± 15%
600 μm (No. 30)	± 5%	
75 μm (No. 200)	± 2.0%	± 4.0%
AC	± 0.4%	± 0.5%

If more than 20 percent of the individual sieves are out of the gradation tolerances, or if more than 20 percent of the asphalt content test results fall outside the appropriate tolerances, the RAP will not be allowed to be used in the Department's bituminous concrete mixtures unless the RAP representing the failing tests is removed from the stockpile to the satisfaction of the Engineer. All test data and acceptance ranges shall be sent to the District for evaluation.

With the approval of the Engineer, the ignition oven may be substituted for extractions according to the Illinois Test Procedure, "Calibration of the Ignition Oven for the Purpose of Characterizing Reclaimed Asphalt Pavement (RAP)".

- (e) Designs. At the Contractor's option, bituminous concrete mixtures may be constructed utilizing RAP material meeting the above detailed requirements. The amount of RAP included in the mixture shall not exceed the percentages specified in the plans.

RAP designs shall be submitted for volumetric verification. If additional RAP stockpiles are tested and found that no more than 20 percent of the results, as defined under "Testing" herein, are outside of the control tolerances set for the original RAP stockpile and design, and meets all of the requirements herein, the additional RAP stockpiles may be used in the original mix design at the percent previously verified.

- (f) Production. The coarse aggregate in all RAP used shall be equal to or less than the nominal maximum size requirement for the bituminous mixture being produced.

To remove or reduce agglomerated material, a scalping screen, crushing unit or comparable sizing device approved by the Engineer shall be used in the RAP feed system to remove or reduce oversized material. If material passing the sizing device adversely affects the mix production or quality of the mix, the sizing device shall be set at a size specified by the Engineer.

If the RAP control tolerances or QC/QA test results require corrective action, the Contractor shall cease production of the mixture containing RAP and either switch to the virgin aggregate design or submit a new RAP design.

SEEDING AND SODDING (BDE)

Effective: July 1, 2004

Revised: November 1, 2004

Revise Class 1A and 2A seeding mixtures shown in Table 1 of Article 250.07 of the Standard Specifications to read:

"Table 1 - SEEDING MIXTURES		
Class – Type	Seeds	kg/hectare (lb/acre)
1A Salt Tolerant Lawn Mixture 7/	Bluegrass	70 (60)
	Perennial Ryegrass	20 (20)
	Audubon Red Fescue	20 (20)
	Rescue 911 Hard Fescue	20 (20)
	Fults Salt Grass*	70 (60)
2A Salt Tolerant Roadside Mixture 7/	Alta Fescue or Ky 31	70 (60)
	Perennial Ryegrass	20 (20)
	Audubon Red Fescue	20 (30)
	Rescue 911 Hard Fescue	20 (30)
	Fults Salt Grass 1/	70 (60)"

Revise Note 7 of Article 250.07 of the Standard Specifications to read:

"Note 7. In Districts 1 through 6, the planting times shall be April 1 to June 15 and August 1 to November 1. In Districts 7 through 9, the planting times shall be March 1 to June 1 and August 1 to November 15. Seeding may be performed outside these dates provided the Contractor guarantees a minimum of 75 percent coverage over the entire seeded area(s) after one growing season. The guarantee shall be submitted to the Engineer in writing prior to performing the work. After one growing season, areas not sustaining 75 percent growth shall be interseeded or reseeded, as determined by the Engineer, at the Contractor's expense."

Add the following sentence to Article 252.04 of the Standard Specifications:

"Sod shall not be placed during the months of July and August."

Revise the first paragraph of Article 252.08 of the Standard Specifications to read:

"252.08 Sod Watering. Within two hours after the sod has been placed, water shall be applied at a rate of 25 L/sq m (5 gal/sq yd). Additional water shall be applied every other day at a rate of 15 L/sq m (3 gal/sq yd) for a total of 15 additional waterings. During periods exceeding 26 °C (80 °F) or subnormal rainfall, the schedule of additional waterings may be altered with the approval of the Engineer."

Revise Article 252.09 of the Standard Specifications to read:

"252.09 Supplemental Watering. During periods exceeding 26 °C (80 °F) or subnormal rainfall, supplemental watering may be required after the initial and additional waterings."

Supplemental watering shall be performed when directed by the Engineer. Water shall be applied at the rate specified by the Engineer within 24 hours of notice.”

Revise the first and third paragraphs of Article 252.12 of the Standard Specifications to read:

“**252.12 Method of Measurement.** Sodding will be measured for payment in place and the area computed in square meters (square yards). To be acceptable for final payment, the sod shall be growing in place for a minimum of 30 days in a live, healthy condition. When directed by the Engineer, any defective or unacceptable sod shall be removed, replaced and watered by the Contractor at his/her own expense.”

“Supplemental watering will be measured for payment in units of 1000 L (1000 gal) of water applied on the sodded areas. Waterings performed in addition to those required by Article 252.08 or after the 30 day establishment period will be considered as supplemental watering.”

Replace the first paragraph of Article 252.13 of the Standard Specifications with the following:

“**252.13 Basis of Payment.** Sodding will be paid for at the contract unit price per square meter (square yard) for SODDING or SODDING, SALT TOLERANT according to the following schedule.

- (a) Initial Payment. Upon placement of sod, 25 percent of the pay item will be paid.
- (b) Final Payment. Upon acceptance of sod, the remaining 75 percent of the pay item will be paid.”

Revise Article 1081.03(b) of the Standard Specifications to read:

“(b) Salt Tolerant Sod.

Variety	Percent by Weight
Buffalo Grass	30%
Buchloe Dactyloides	
Amigo Fineleaf Tall Fescue	20%
Audubon Red Fescue	15%
Rescue 911 Hard Fescue	15%
Rugby Kentucky Bluegrass	5%
Fults Pucinnellia Distans	15%”

Revise Table II of Article 1081.04(c)(6) of the Standard Specifications to read:

TABLE II						
Variety of Seeds	Hard Seed Percent Maximum	Purity Percent Minimum	Pure, Live Seed Percent Minimum	Weed Percent Maximum	Secondary Noxious Weeds No. per kg (oz) Max. Permitted*	Remarks
Alfalfa	20	92	89	0.50	211 (6)	1/
Brome Grass	-	90	75	0.50	175 (5)	-
Clover, Alsike	15	92	87	0.30	211 (6)	2/
Clover, Crimson	15	92	83	0.50	211 (6)	-
Clover, Ladino	15	92	87	0.30	211 (6)	-
Clover, Red	20	92	87	0.30	211 (6)	-
Clover, White Dutch	30	92	87	0.30	211 (6)	3/
Audubon Red Fescue	0	97	82	0.10	105 (3)	-
Fescue, Alta or Ky. 31	-	97	82	1.00	105 (3)	-
Fescue, Creeping Red	-	97	82	1.00	105 (3)	-
Fults Salt Grass	0	98	85	0.10	70 (2)	-
Kentucky Bluegrass	-	97	80	0.30	247 (7)	5/
Lespedeza, Korean	20	92	84	0.50	211 (6)	3/
Oats	-	92	88	0.50	70 (2)	4/
Orchard Grass	-	90	78	1.50	175 (5)	4/
Redtop	-	90	78	1.80	175 (5)	4/
Ryegrass, Perennial, Annual	-	97	85	0.30	175 (5)	4/
Rye, Grain, Winter	-	92	83	0.50	70 (2)	4/
Rescue 911 Hard Fescue	0	97	82	0.10	105 (3)	-
Timothy	-	92	84	0.50	175 (5)	4/
Vetch, Crown	30	92	67	1.00	211 (6)	3/ & 6/
Vetch, Spring	30	92	88	1.00	70 (2)	4/
Vetch, Winter	15	92	83	1.00	105 (3)	4/
Wheat, hard Red Winter	-	92	89	0.50	70 (2)	4/

STABILIZED SUBBASE AND BITUMINOUS SHOULDERS SUPERPAVE (BDE)

Effective: April 1, 2002

Revised: July 1, 2004

Description. This work shall consist of constructing stabilized subbase and bituminous shoulders Superpave according to Sections 312 and 482 respectively, of the Standard Specifications and the special provision, "Quality Control/Quality Assurance of Bituminous Concrete Mixtures" except as modified herein.

Revise Article 312.03(b) of the Standard Specifications to read:

"(b) RAP Material (Note 3)"

Revise Note 2 of Article 312.03 of the Standard Specifications to read:

"Note 2. Gradation CA 6, CA 10, or CA 12 shall be used."

Revise Note 3 of Article 312.03 of the Standard Specifications to read:

"Note 3. RAP shall meet the requirements of the special provision "RAP for Use in Bituminous Concrete Mixtures". RAP containing steel slag shall be permitted for use in top-lift surface mixtures only."

Revise Note 4 of Article 312.03 of the Standard Specifications to read:

"Note 4. Unless otherwise specified on the plans, the bituminous material shall be performance graded asphalt cement, PG58-22. When more than 15 percent RAP is used, a softer PG binder may be required as determined by the Engineer."

Revise Article 312.06 of the Standard Specifications to read:

"312.06 Mixture Design. The Contractor shall submit mix designs for approval, for each required mixture. Mix designs shall be developed by Level III personnel who have completed the course, "Superpave Mix Design Upgrade". The mixtures shall be designed according to the respective Illinois Modified AASHTO references listed below:

- AASHTO MP 2 Standard Specification for Superpave Volumetric Mix Design
- AASHTO R 30 Standard Practice for Mixture Conditioning of Hot-Mix Asphalt (HMA)
- AASHTO PP 28 Standard Practice for Designing Superpave HMA
- AASHTO T 209 Theoretical Maximum Specific Gravity and Density of Bituminous Paving Mixtures
- AASHTO T 312 Preparing and Determining the Density of Hot Mix Asphalt (HMA) Specimens by Means of the Superpave Gyrotory Compactor
- AASHTO T 308 Determining the Asphalt Content of Hot Mix Asphalt (HMA) by the Ignition Method

(a) Job Mix Formula (JMF). The JMF shall be according to the following limits:

<u>Ingredient</u>	<u>Percent by Dry Weight</u>
Aggregate.....	94.0 to 96.0
Asphalt Cement.....	4.0 to 6.0*
Dust/AC Ratio	1.4

*Upper limit may be raised for the lower or top lifts if the Contractor elects to use a highly absorptive coarse and/or fine aggregate requiring more than six percent asphalt. The additional asphalt shall be furnished at no cost to the Department.

When RAP material is being used, the JMF shall be according to the following limits:

<u>Ingredient</u>	<u>Percent by Dry Weight</u>
Virgin Aggregate(s)	46.0 to 96.0
RAP Material(s) (Note 1).....	0 to 50
Mineral Filler (if required)	0 to 5.0
Asphalt Cement.....	4.0 to 7.0
Dust/AC Ratio	1.4

Note 1. If specified on the plans, the maximum percentage of RAP shall be as specified therein.

It is recommended that the selected combined aggregate gradation not pass through the restricted zones specified in Illinois Modified AASHTO MP 2.

(b) Volumetric Requirements.

Design Compactive Effort	Design Air Voids Target (%)
$N_{DES} = 30$	2.0

(c) Determination of Need for Anti-Stripping Additive. The mixture designer shall determine if an additive is needed in the mix to prevent stripping. The determination will be made on the basis of tests performed according to Illinois Modified AASHTO T 283 using 4 in. Marshall bricks. To be considered acceptable by the Engineer as a mixture not susceptible to stripping, the ratio of conditioned to unconditioned split tensile strengths (TSR) shall be equal to or greater than 0.75. Mixtures, either with or without an additive, with TSR values less than 0.75 will be considered unacceptable.

If it is determined that an additive is required, the additive may be hydrated lime, slaked quicklime, or a liquid additive, at the Contractor's option. The liquid additive shall be selected from the Department's list of approved additives and may be limited to those which have exhibited satisfactory performance in similar mixes.

Dry hydrated lime shall be added at a rate of 1.0 to 1.5 percent by weight of total dry aggregate. Slurry shall be added in such quantity as to provide the required amount of hydrated lime solids by weight of total dry aggregate. The exact rate of application for all anti-stripping additives will be determined by the Engineer. The method of application shall be according to Article 406.12 of the Standard Specifications."

Revise Article 312.08 of the Standard Specifications to read:

"312.08 Mixture Production. When a hot-mix plant conforming to Article 1102.01 is used, the aggregate shall be dried and heated in the revolving dryer to a temperature of 120 °C (250 °F) to 175 °C (350 °F).

The aggregate and bituminous material used in the bituminous aggregate mixture shall be measured separately and accurately by weight or by volume. When the aggregate is in the mixer, the bituminous material shall be added and mixing continued for a minimum of 35 seconds and until a homogeneous mixture is produced in which all particles of the aggregate are coated. The mixing period, size of the batch and the production rate shall be approved by the Engineer.

The ingredients shall be heated and combined in such a manner as to produce a mixture which, when discharged from the mixer, shall be workable and vary not more 10 °C (20 °F) from the temperature set by the Engineer.

When RAP material(s) is used in the bituminous aggregate mixture, the virgin aggregate(s) shall be dried and heated in the dryer to a temperature that will produce the specified resultant mix temperature when combined with the RAP material.

The heated virgin aggregates and mineral filler shall be combined with RAP material in such a manner as to produce a bituminous mixture which when discharged from the mixer shall not vary more than 15 °C (30 °F) from the temperature set by the Engineer. The combined ingredients shall be mixed for a minimum of 35 seconds and until a homogeneous mixture as to composition and temperature is obtained. The total mixing time shall be a minimum of 45 seconds consisting of dry and wet mixing. Variation in wet and dry mixing times may be permitted, depending on the moisture content and amount of salvaged material used. The mix temperature shall not exceed 175 °C (350 °F). Wide variations in the mixture temperature will be cause for rejection of the mix.

- (a) Personnel. The QC Manager and Level I Technician shall have successfully completed the Department's "Superpave Field Control Course".
- (b) Required Tests. Testing for stabilized subbase and bituminous shoulders shall be conducted to control the production of the bituminous mixture using the test methods identified and performed at a frequency not less than indicated in the following table.

Parameter	Frequency of Tests Non-Class I Mixtures	Test Method
Aggregate Gradation Hot bins for batch and continuous plants. Individual cold-feeds or combined belt-feed for drier-drum plants. (% passing sieves: 12.5 mm (1/2 In.), 4.75 mm (No. 4), 75 µm (No. 200))	1 gradation per day of production. The first day of production shall be washed ignition oven test on the mix. Thereafter, the testing shall alternate between dry gradation and washed ignition oven test on the mix. The dry gradation and the washed ignition oven test results shall be plotted on the same control chart.	Illinois Procedure (See Manual of Test Procedures for Materials).
Asphalt Content by ignition oven (Note 1.)	1 per day	Illinois-Modified AASHTO T 308
Air Voids		
Bulk Specific Gravity of Gyratory Sample	1 per day	Illinois-Modified AASHTO T 312
Maximum Specific Gravity of Mixture	1 per day	Illinois-Modified AASHTO T 209

Note 1. The Engineer may waive the ignition oven requirement for AC content if the aggregates to be used are known to have ignition AC content calibration factors which exceed 1.5 percent. If the ignition oven requirement is waived, other Department approved methods shall be used to determine the AC content.

During production, the ratio of minus 75 µm (#200) sieve material to total asphalt cement shall be not less than 0.6 nor more than 1.6, and the moisture content of the mixture at discharge from the mixer shall not exceed 0.5 percent. If at any time the ratio of minus 75 µm (#200) material to asphalt or moisture content of the mixture falls outside the stated limits, production of the mix shall cease. The cause shall be determined and corrective action satisfactory to the Engineer shall be initiated prior to resumption of production.

During production, mixture containing an anti-stripping additive will be tested by the Engineer for stripping according to Illinois Modified AASHTO T 283. If the mixture fails to meet the TSR criteria for acceptance, no further mixture will be accepted until the Contractor takes such action as is necessary to furnish a mixture meeting the criteria.

- (c) Control Charts/Limits. Control charts/limits shall be according to QC/QA requirements for Non-Class I Mixtures except air voids shall be plotted on the control charts within the following control limits:

Air Void Control Limits	
Mixture	Individual Test
Shoulders	± 1.2 %
Others	± 1.2 %"

Replace the first paragraph of Article 312.10 of the Standard Specifications with the following:

“312.10 Placing and Compacting. After the subgrade has been compacted and is acceptable to the Engineer, the bituminous aggregate mixture shall be spread upon it with a mechanical spreader. The maximum compacted thickness of each lift shall be 150 mm (6 in.) provided the required density is obtained. The minimum compacted thickness of each lift shall be according to the following table:

Nominal Maximum Aggregate Size of Mixture	Minimum Compacted Lift Thickness
CA 12 – 12.5 mm (1/2 in.)	38 mm (1 1/2 in.)
CA 10 - 19 mm (3/4 in.)	57 mm (2 1/4 in.)
CA 6 – 25 mm (1 in.)	76 mm (3 in.)

The surface of each lift shall be clean and dry before succeeding lifts are placed.”

Revise Article 482.02 of the Standard Specifications to read:

“482.02 Materials. Materials shall meet the requirements of Article 312.03. For the top lift, the aggregate used shall meet the gradation requirements for a CA 10 or CA 12. Blending of aggregates to meet these gradation requirements will be permitted.”

Revise the first paragraph of Article 482.04 of the Standard Specifications to read:

“482.04 General. For pavement and shoulder resurfacing projects, Superpave binder and surface course mixtures may be used in lieu of bituminous aggregate mixture for the resurfacing of shoulders, at the option of the Contractor, or shall be used when specified on the plans.”

Revise Article 482.04(c) of the Standard Specifications to read:

“(c) Mixture Production312.08”

Revise Article 482.05 of the Standard Specifications to read:

“**482.05 Composition of Bituminous Aggregate Mixture.** The composition of the mixture shall be according to Article 312.06, except that the amount of asphalt cement used in the top lift shall be increased up to 0.5 percent more than that required in the lower lifts. For resurfacing projects when the Superpave binder and surface course mixtures option is used, the asphalt cement used in the top lift shall not be increased. Superpave mixtures used on the top lift of such shoulders shall meet the gradation requirements of the special provision “Superpave Bituminous Concrete Mixtures”.

For shoulder and strip construction, the composition of the Superpave binder and surface course shall be the same as that specified for the mainline pavement.”

In the following locations of Section 482 of the Standard Specifications, change “Class I” to “Superpave”:

- the second paragraph of Article 482.04
- the first sentence of the second paragraph of Article 482.06
- the first sentence of the fourth paragraph of Article 482.06
- the second sentence of the fourth paragraph of Article 482.06
- the first sentence of the third paragraph of Article 482.08(b)

Revise the first paragraph of Article 482.06 of the Standard Specifications to read:

“**482.06 Placing and Compacting.** This work shall be according to Article 312.10. The mechanical spreader for the top lift of shoulders shall meet the requirements of Article 1102.03 when the shoulder width is 3 m (10 ft) or greater.”

Revise Article 482.09 of the Standard Specifications to read:

“**482.09 Basis of Payment.** When bituminous shoulders are constructed along the edges of the completed pavement structure, this work will be paid for at the contract unit price per square meter (square yard) for BITUMINOUS SHOULDERS SUPERPAVE of the thickness specified. The specified thickness shall be the thickness shown on the plans at the edge of the pavement.

On pavement and shoulder resurfacing projects, the shoulder resurfacing will be paid for at the contract unit price per metric ton (ton) for BITUMINOUS SHOULDERS SUPERPAVE.

The construction of shoulder strips for resurfacing pavements will be paid according to the special provision, “Superpave Bituminous Concrete Mixtures”.

SUPERPAVE BITUMINOUS CONCRETE MIXTURES (BDE)

Effective: January 1, 2000

Revised: April 1, 2004

Description. This work shall consist of designing, producing and constructing Superpave bituminous concrete mixtures using Illinois Modified Strategic Highway Research Program (SHRP) Superpave criteria. This work shall be according to Sections 406 and 407 of the Standard Specifications and the special provision, "Quality Control/Quality Assurance of Bituminous Concrete Mixtures", except as follows.

Materials.

- (a) Fine Aggregate Blend Requirement. The Contractor may be required to provide FA 20 manufactured sand to meet the design requirements. For mixtures with $N_{design} \geq 90$, at least 50 percent of the required fine aggregate fraction shall consist of either stone sand, slag sand, or steel slag sand meeting the FA/FM 20 gradation.
- (b) Reclaimed Asphalt Pavement (RAP). If the Contractor is allowed to use more than 15 percent RAP, as specified in the plans, a softer performance-graded binder may be required as determined by the Engineer.

RAP shall meet the requirements of the special provision, "RAP for Use in Bituminous Concrete Mixtures".

RAP will not be permitted in mixtures containing polymer modifiers.

RAP containing steel slag will be permitted for use in top-lift surface mixtures only.

- (c) Bituminous Material. The asphalt cement (AC) shall be performance-graded (PG) or polymer modified performance-graded (SBS-PG or SBR-PG) meeting the requirements of Article 1009.05 of the Standard Specifications for the grade specified on the plans.

The following additional guidelines shall be used if a polymer modified asphalt is specified:

- (1) The polymer modified asphalt cement shall be shipped, maintained, and stored at the mix plant according to the manufacturer's requirements. Polymer modified asphalt cement shall be placed in an empty tank and shall not be blended with other asphalt cements.
- (2) The mixture shall be designed using a mixing temperature of 163 ± 3 °C (325 ± 5 °F) and a gyratory compaction temperature of 152 ± 3 °C (305 ± 5 °F).
- (3) Pneumatic-tired rollers will not be allowed unless otherwise specified by the Engineer. A vibratory roller meeting the requirements of Article 406.16 of the Standard Specifications shall be required in the absence of the pneumatic-tired roller.

Laboratory Equipment.

- (a) Superpave Gyrotory Compactor. The superpave gyrotory compactor (SGC) shall be used for all QC/QA testing.
- (b) Ignition Oven. The ignition oven shall be used to determine the AC content. The ignition oven shall also be used to recover aggregates for all required washed gradations.

The Engineer may waive the ignition oven requirement for AC content if the aggregates to be used are known to have ignition AC content calibration factors which exceed 1.5 percent. If the ignition oven requirement is waived, other Department approved methods shall be used to determine the AC content.

Mixture Design. The Contractor shall submit mix designs, for approval, for each required mixture. Mix designs shall be developed by Level III personnel who have successfully completed the course, "Superpave Mix Design Upgrade". Articles 406.10 and 406.13 of the Standard Specifications shall not apply. The mixtures shall be designed according to the respective Illinois Modified AASHTO references listed below.

AASHTO MP 2	Standard Specification for Superpave Volumetric Mix Design
AASHTO R 30	Standard Practice for Mixture Conditioning of Hot-Mix Asphalt (HMA)
AASHTO PP 28	Standard Practice for Designing Superpave HMA
AASHTO T 209	Theoretical Maximum Specific Gravity and Density of Bituminous Paving Mixtures
AASHTO T 312	Preparing and Determining the Density of Hot Mix Asphalt (HMA) Specimens by Means of the Superpave Gyrotory Compactor
AASHTO T 308	Determining the Asphalt Content of Hot Mix Asphalt (HMA) by the Ignition Method

- (a) Mixture Composition. The ingredients of the bituminous mixture shall be combined in such proportions as to produce a mixture conforming to the composition limits by weight. The gradation mixture specified on the plans shall produce a mixture falling within the limits specified in Table 1.

TABLE 1. MIXTURE COMPOSITION (% PASSING) ^{1/}								
Sieve Size	IL-25.0 mm		IL-19.0 mm		IL-12.5 mm ^{4/}		IL-9.5 mm ^{4/}	
	min	max	min	max	Min	max	min	max
37.5 mm (1 1/2 in.)		100						
25 mm (1 in.)	90	100		100				
19 mm (3/4 in.)		90	82	100		100		
12.5 mm (1/2 in.)	45	75	50	85	90	100		100
9.5 mm (3/8 in.)						89	90	100
4.75 mm (#4)	24	42 ^{2/}	24	50 ^{2/}	28	65	28	65
2.36 mm (#8)	16	31	20	36	28	48 ^{3/}	28	48 ^{3/}
1.18 mm (#16)	10	22	10	25	10	32	10	32
600 μm (#30)								
300 μm (#50)	4	12	4	12	4	15	4	15
150 μm (#100)	3	9	3	9	3	10	3	10
75 μm (#200)	3	6	3	6	4	6	4	6

- 1/ Based on percent of total aggregate weight.
- 2/ The mixture composition shall not exceed 40 percent passing the 4.75 mm (#4) sieve for binder courses with Ndesign ≥ 90.
- 3/ The mixture composition shall not exceed 40 percent passing the 2.36 mm (#8) sieve for surface courses with Ndesign ≥ 90.
- 4/ The mixture composition for surface courses shall be according to IL-12.5 mm or IL-9.5 mm, unless otherwise specified by the Engineer.

One of the above gradations shall be used for leveling binder as specified in the plans and according to Article 406.04 of the Standard Specifications.

It is recommended that the selected combined aggregate gradation not pass through the restricted zones specified in Illinois Modified AASHTO MP 2.

- (b) Dust/AC Ratio for Superpave. The ratio of material passing the 75 μm (#200) sieve to total asphalt cement shall not exceed 1.0 for mixture design (based on total weight of mixture).
- (c) Volumetric Requirements. The target value for the air voids of the hot mix asphalt (HMA) shall be 4.0 percent at the design number of gyrations. The VMA and VFA of the HMA design shall be based on the nominal maximum size of the aggregate in the mix and shall conform to the requirements listed in Table 2.

TABLE 2. VOLUMETRIC REQUIREMENTS					
Ndesign	Voids in the Mineral Aggregate (VMA), % minimum				Voids Filled with Asphalt (VFA), %
	IL-25.0	IL-19.0	IL-12.5	IL-9.5	
50	12.0	13.0	14.0	15	65 - 78
70					65 - 75
90					
105					

- (d) Determination of Need for Anti-Stripping Additive. The mixture designer shall determine if an additive is needed in the mix to prevent stripping. The determination will be made on the basis of tests performed according to Illinois Modified T 283 using 4 in. Marshall bricks. To be considered acceptable by the Department as a mixture not susceptible to stripping, the ratio of conditioned to unconditioned split tensile strengths (TSRs) shall be equal to or greater than 0.75. Mixtures, either with or without an additive, with TSRs less than 0.75 will be considered unacceptable.

If it is determined that an additive is required, the additive may be hydrated lime, slaked quicklime, or a liquid additive, at the Contractor's option. The liquid additive shall be selected from the Department's list of approved additives and may be limited to those which have exhibited satisfactory performance in similar mixes.

Dry hydrated lime shall be added at a rate of 1.0 to 1.5 percent by weight of total dry aggregate. Slurry shall be added in such quantity as to provide the required amount of hydrated lime solids by weight of total dry aggregate. The exact rate of application for all anti-stripping additives will be determined by the Department. The method of application shall be according to Article 406.12 of the Standard Specifications.

Personnel. The QC Manager and Level I Technician shall have successfully completed the Department's "Superpave Field Control Course".

Required Plant Tests. Testing shall be conducted to control the production of the bituminous mixture. The Contractor shall use the test methods identified to perform the following mixture tests at a frequency not less than that indicated in Table 3.

TABLE 3. REQUIRED PLANT TESTS for SUPERPAVE

Parameter		Frequency of Tests	Test Method
Aggregate Gradation Hot bins for batch and continuous plants Individual cold-feeds or combined belt-feed for drier drum plants. (% passing sieves: 12.5 mm (1/2 in.), 4.75 mm (No. 4), 2.36 mm (No. 8), 600 µm (No. 30), 75 µm (No. 200))		1 dry gradation per day of production (either morning or afternoon sample). And 1 washed ignition oven test on the mix per day of production (conduct in afternoon if dry gradation is conducted in the morning or vice versa). NOTE. The order in which the above tests are conducted shall alternate from the previous production day (example: a dry gradation conducted in the morning will be conducted in the afternoon on the next production day and so forth). The dry gradation and washed ignition oven test results shall be plotted on the same control chart.	Illinois Procedure (See Manual of Test Procedures for Materials).
Asphalt Content by Ignition Oven (Note 1.)		1 per half day of production	Illinois Modified AASHTO T 308
Air Voids	Bulk Specific Gravity of Gyratory Sample	1 per half day of production for first 2 days and 1 per day thereafter (first sample of the day)	Illinois Modified AASHTO T 312
	Maximum Specific Gravity of Mixture		Illinois Modified AASHTO T 209

Note 1. The Engineer may waive the ignition oven requirement for AC content if the aggregates to be used are known to have ignition AC content calibration factors which exceed 1.5 percent. If the ignition oven requirement is waived, other Department approved methods shall be used to determine the AC content.

During production, the ratio of minus 75 µm (#200) sieve material to total asphalt cement shall be not less than 0.6 nor more than 1.2 and the moisture content of the mixture at discharge from the mixer shall not exceed 0.5 percent. If at any time the ratio of minus 75 µm (#200) material to asphalt or moisture content of the mixture falls outside the stated limits, production of the mix shall cease. The cause shall be determined and corrective action satisfactory to the Engineer shall be initiated prior to resuming production.

During production, mixtures containing an anti-stripping additive will be tested by the Department for stripping according to Illinois Modified T 283. If the mixture fails to meet the TSR criteria for acceptance, no further mixture will be accepted until the Contractor takes such action as is necessary to furnish a mixture meeting the criteria.

Construction Requirements

Lift Thickness.

- (a) Binder and Surface Courses. The minimum compacted lift thickness for constructing bituminous concrete binder and surface courses shall be according to Table 4:

TABLE 4 – MINIMUM COMPACTED LIFT THICKNESS	
Mixture	Thickness, mm (in.)
IL-9.5	32 (1 1/4)
IL-12.5	38 (1 1/2)
IL-19.0	57 (2 1/4)
IL-25.0	76 (3)

- (b) Leveling Binder. Mixtures used for leveling binder shall be as follows:

TABLE 5 – LEVELING BINDER	
Nominal, Compacted, Leveling Binder Thickness, mm (in.)	Mixture
≤ 32 (1 1/4)	IL-9.5
32 (1 1/4) to 50 (2)	IL 9.5 or IL-12.5

Density requirements shall apply for leveling binder when the nominal, compacted thickness is 32 mm (1 1/4 in.) or greater for IL-9.5 mixtures and 38 mm (1 1/2 in.) or greater for IL-12.5 mixtures.

- (c) Full-Depth Pavement. The compacted thickness of the initial lift of binder course shall be 100 mm (4 in.). The compacted thickness of succeeding lifts shall meet the minimums specified in Table 4 but not exceed 100 mm (4 in.).

If a vibratory roller is used for breakdown, the compacted thickness of the binder lifts, excluding the top lift, may be increased to 150 mm (6 in.) provided the required density is obtained.

- (d) Bituminous Patching. The minimum compacted lift thickness for constructing bituminous patches shall be according to Table 4.

Control Charts/Limits. Control charts/limits shall be according to QC/QA Class I requirements, except density shall be plotted on the control charts within the following control limits:

TABLE 6. DENSITY CONTROL LIMITS		
Mixture	Parameter	Individual Test
12.5 mm / 9.5 mm	N _{design} ≥ 90	92.0 – 96.0%
12.5 mm / 9.5 mm	N _{design} < 90	92.5 – 97.4%
19.0 mm / 25.0 mm	N _{design} ≥ 90	93.0 – 96.0%
19.0 mm / 25.0 mm	N _{design} < 90	93.0 – 97.4%

Basis of Payment. On resurfacing projects, this work will be paid for at the contract unit price per metric ton (ton) for BITUMINOUS CONCRETE SURFACE COURSE, SUPERPAVE, of the friction aggregate mixture and Ndesign specified, LEVELING BINDER (HAND METHOD), SUPERPAVE, of the Ndesign specified, LEVELING BINDER (MACHINE METHOD), SUPERPAVE, of the Ndesign specified, and BITUMINOUS CONCRETE BINDER COURSE, SUPERPAVE, of the mixture composition and Ndesign specified.

On resurfacing projects in which polymer modifiers are required, this work will be paid for at the contract unit price per metric ton (ton) for POLYMERIZED BITUMINOUS CONCRETE SURFACE COURSE, SUPERPAVE, of the friction aggregate mixture and Ndesign specified, POLYMERIZED LEVELING BINDER (HAND METHOD), SUPERPAVE, of the Ndesign specified, POLYMERIZED LEVELING BINDER (MACHINE METHOD), SUPERPAVE, of the Ndesign specified, and POLYMERIZED BITUMINOUS CONCRETE BINDER COURSE, SUPERPAVE, of the mixture composition and Ndesign specified.

On full-depth pavement projects, this work will be paid for at the contract unit price per square meter (square yard) for BITUMINOUS CONCRETE PAVEMENT, (FULL-DEPTH), SUPERPAVE, of the thickness specified.

On projects where widening is constructed and the entire pavement is then resurfaced, the binder for the widening will be paid for at the contract unit price per square meter (square yard) for BITUMINOUS CONCRETE BINDER COURSE, SUPERPAVE, of the mixture composition, Ndesign, and thickness specified. The surface and binder used to resurface the entire pavement will be paid for according to the paragraphs above for resurfacing projects.

TRAFFIC CONTROL DEFICIENCY DEDUCTION (BDE)

Effective: April 1, 1992

Revised: January 1, 2005

To ensure a prompt response to incidents involving the integrity of work zone traffic control, the Contractor shall provide a telephone number where a responsible individual can be contacted 24 hours-a-day.

When the Engineer is notified, or determines a traffic control deficiency exists, he/she will notify and direct the Contractor to correct the deficiency within a specified time. The specified time, which begins upon notification to the Contractor, will be from 1/2 hour to 12 hours based upon the urgency of the situation and the nature of the deficiency. The Engineer shall be the sole judge.

A deficiency may be any lack of repair, maintenance, or non-compliance with the traffic control plan. A deficiency may also be applied to situations where corrective action is not an option such as the use of non-certified flaggers for short term operations; working with lane closures beyond the time allowed in the contract; or failure to perform required contract obligations such as traffic control surveillance.

If the Contractor fails to correct a deficiency within the specified time, a daily monetary deduction will be imposed for each calendar day or fraction thereof the deficiency exists. The calendar day(s) will begin with notification to the Contractor and end with the Engineer's acceptance of the correction. The daily monetary deduction will be either \$1,000 or

0.05 percent of the awarded contract value, whichever is greater. For those deficiencies where corrective action was not an option this monetary deduction will be immediate.

In addition, if the Contractor fails to respond, the Engineer may correct the deficiency and the cost thereof will be deducted from monies due or which may become due the Contractor. This corrective action will in no way relieve the Contractor of his/her contractual requirements or responsibilities.

TRUCK BED RELEASE AGENT (BDE)

Effective: April 1, 2004

Add the following sentence after the third sentence of the first paragraph of Article 406.14 of the Standard Specifications.

“In addition to the release agent, the Contractor may use a light scatter of manufactured sand (FA 20 or FA 21) evenly distributed over the bed of the vehicle.”

WEIGHT CONTROL DEFICIENCY DEDUCTION

Effective: April 1, 2001

Revised: August 1, 2002

The Contractor shall provide accurate weights of materials delivered to the contract for incorporation into the work (whether temporary or permanent) and for which the basis of payment is by weight. These weights shall be documented on delivery tickets which shall identify the source of the material, type of material, the date and time the material was loaded, the contract number, the net weight, the tare weight when applicable and the identification of the transporting vehicle. For aggregates, the Contractor shall have the driver of the vehicle furnish or establish an acceptable alternative to provide the contract number and a copy of the material order to the source for each load. The source is defined as that facility that produces the final material product that is to be incorporated into the contract pay items.

The Department will conduct random, independent vehicle weight checks for material sources according to the procedures outlined in the Documentation Section Policy Statement of the Department's Construction Manual and hereby incorporated by reference. The results of the independent weight checks shall be applicable to all contracts containing this Special Provision. Should the vehicle weight check for a source result in the net weight of material on the vehicle exceeding the net weight of material shown on the delivery ticket by 0.50% (0.70% for aggregates) or more, the Engineer will document the independent vehicle weight check and immediately furnish a copy of the results to the Contractor. No adjustment in pay quantity will be made. Should the vehicle weight check for a source result in the net weight of material shown on the delivery ticket exceeding the net weight of material on the vehicle by 0.50% (0.70% for aggregates) or more, the Engineer will document the independent vehicle weight check and immediately furnish a copy of the results to the Contractor. The Engineer will adjust the net weight shown on the delivery ticket to the checked delivered net weight as determined by the independent vehicle weight check.

The Engineer will also adjust the method of measurement for all contracts for subsequent deliveries of all materials from the source based on the independent weight check. The net

weight of all materials delivered to all contracts containing this Special Provision from this source, for which the basis of payment is by weight, will be adjusted by applying a correction factor "A" as determined by the following formula:

$$A = 1.0 - \left(\frac{B - C}{B} \right); \text{ Where } A \leq 1.0; \left(\frac{B - C}{C} \right) > 0.50\% \text{ (0.70\% for aggregates)}$$

Where A = Adjustment factor
B = Net weight shown on delivery ticket
C = Net weight determined from independent weight check

The adjustment factor will be applied as follows:

$$\text{Adjusted Net Weight} = A \times \text{Delivery Ticket Net Weight}$$

The adjustment factor will be imposed until the cause of the deficient weight is identified and corrected by the Contractor to the satisfaction of the Engineer. If the cause of the deficient weight is not identified and corrected within seven (7) calendar days, the source shall cease delivery of all materials to all contracts containing this Special Provision for which the basis of payment is by weight.

Should the Contractor elect to challenge the results of the independent weight check, the Engineer will continue to document the weight of material for which the adjustment factor would be applied. However, provided the Contractor furnishes the Engineer with written documentation that the source scale has been calibrated within seven (7) calendar days after the date of the independent weight check, adjustments in the weight of material paid for will not be applied unless the scale calibration demonstrates that the source scale was not within the specified Department of Agriculture tolerance.

At the Contractor's option, the vehicle may be weighed on a second independent Department of Agriculture certified scale to verify the accuracy of the scale used for the independent weight check.

WORK ZONE SPEED LIMIT SIGNS (BDE)

Effective: April 2, 2004

Revised: April 15, 2004

Delete Article 702.05(c).

Revise Article 702.05(d) to read:

"(d) Work Zone Speed Limit Signs. Work zone speed limit sign assemblies shall be provided and located as shown on the plans. Two additional assemblies shall be placed 150 m (500 ft) beyond the last entrance ramp for each interchange. The individual signs that make up an assembly may be combined on a single panel. The sheeting for the signs shall be reflective and conform to the requirements of Article 1084.02.

All permanent "SPEED LIMIT" signs located within the work zone shall be removed or covered. This work shall be coordinated with the lane closure(s) by promptly establishing a reduced posted speed zone when the lane closure(s) are put into effect and promptly reinstating the posted speed zone when the lane closure(s) are removed.

The work zone speed limit signs and end work zone speed limit signs shown in advance of and at the end of the lane closure(s) shall be used for the entire duration of the closure(s).

The work zone speed limit signs shown within the lane closure(s) shall only be used when workers are present in the closed lane adjacent to traffic; at all other times, the signs shall be promptly removed or covered. The sign assemblies shown within the lane closure(s) will not be required when the worker(s) are located behind a concrete barrier wall.

WORK ZONE TRAFFIC CONTROL DEVICES (BDE)

Effective: January 1, 2003

Revised: November 1, 2004

Add the following to Article 702.01 of the Standard Specifications:

"All devices and combinations of devices shall meet the requirements of the National Cooperative Highway Research Program (NCHRP) Report 350 for their respective categories. The categories are as follows:

Category 1 includes small, lightweight, channelizing and delineating devices that have been in common use for many years and are known to be crashworthy by crash testing of similar devices or years of demonstrable safe performance. These include cones, tubular markers, flexible delineators and plastic drums with no attachments. Category 1 devices shall be crash tested and accepted or may be self-certified by the manufacturer.

Category 2 includes devices that are not expected to produce significant vehicular velocity change but may otherwise be hazardous. These include drums and vertical panels with lights, barricades and portable sign supports. Category 2 devices shall be crash tested and accepted for Test Level 3.

Category 3 includes devices that are expected to cause significant velocity changes or other potentially harmful reactions to impacting vehicles. These include crash cushions, truck mounted attenuators and other devices not meeting the definitions of Category 1 or 2. Category 3 devices shall be crash tested and accepted for either Test Level 3 or the test level specified.

Category 4 includes portable or trailer-mounted devices such as arrow boards, changeable message signs, temporary traffic signals and area lighting supports. Currently, there is no implementation date set for this category and it is exempt from the NCHRP 350 compliance requirement.

The Contractor shall provide a manufacturer's self-certification letter for each Category 1 device and an FHWA acceptance letter for each Category 2 and Category 3 device used on the contract. The letters shall state the device meets the NCHRP 350 requirements for its respective category and test level, and shall include a detail drawing of the device."

Delete the third, fourth and fifth paragraphs of Article 702.03(b) of the Standard Specifications.

Delete the third sentence of the first paragraph of Article 702.03(c) of the Standard Specifications.

Revise the first sentence of the first paragraph of Article 702.03(e) of the Standard Specifications to read:

“Drums shall be nonmetallic and have alternating reflectorized Type AA or Type AP fluorescent orange and reflectorized white horizontal, circumferential stripes.”

Add the following to Article 702.03 of the Standard Specifications:

“(h) Vertical Barricades. Vertical barricades may be used in lieu of cones, drums or Type II barricades to channelize traffic.”

Delete the fourth paragraph of Article 702.05(a) of the Standard Specifications.

Revise the sixth paragraph of Article 702.05(a) of the Standard Specifications to read:

“When the work operations exceed four days, all signs shall be post mounted unless the signs are located on the pavement or define a moving or intermittent operation. When approved by the Engineer, a temporary sign stand may be used to support a sign at 1.2 m (5 ft) minimum where posts are impractical. Longitudinal dimensions shown on the plans for the placement of signs may be increased up to 30 m (100 ft) to avoid obstacles, hazards or to improve sight distance, when approved by the Engineer. “ROAD CONSTRUCTION AHEAD” signs will also be required on side roads located within the limits of the mainline “ROAD CONSTRUCTION AHEAD” signs.”

Delete all references to “Type 1A barricades” and “wing barricades” throughout Section 702 of the Standard Specifications.

WORKING DAYS (BDE)

Effective: January 1, 2002

The Contractor shall complete the work within 35 working days.

SUBCONTRACTOR MOBILIZATION PAYMENTS (BDE)

Effective: April 2, 2005

To account for the preparatory work and operations necessary for the movement of subcontractor personnel, equipment, supplies, and incidentals to the project site and for all other work or operations that must be performed or costs incurred when beginning work approved for subcontracting in accordance with Article 108.01 of the Standard Specifications, the Contractor shall make a mobilization payment to each subcontractor.

This mobilization payment shall be made at least 14 days prior to the subcontractor starting work. The amount paid shall be equal to 3 percent of the amount of the subcontract reported on form BC 260A submitted for the approval of the subcontractor's work.

This provision shall be incorporated directly or by reference into each subcontract approved by the Department.

STATE OF ILLINOIS

DEPARTMENT OF TRANSPORTATION

PLANS FOR PROPOSED

FAS 777 (NEW DOUGLASS RD)

SECTION 52RS-2, 52-1

MADISON COUNTY

SHOULDER REPLACEMENT,

GUTTER REPLACEMENT & RESURFACING

C-98-070-05

FOR INDEX OF SHEETS SEE SHEET NO. 2



LOCATION OF SECTION INDICATED THIS

D-98-052-05

TRAFFIC INFORMATION

2002 ADT = 2000

2005 ADT = 2100 (ESTIMATED)

2025 ADT = 2800 (ESTIMATED)

SJ = 2.9%

MU = 2.6%

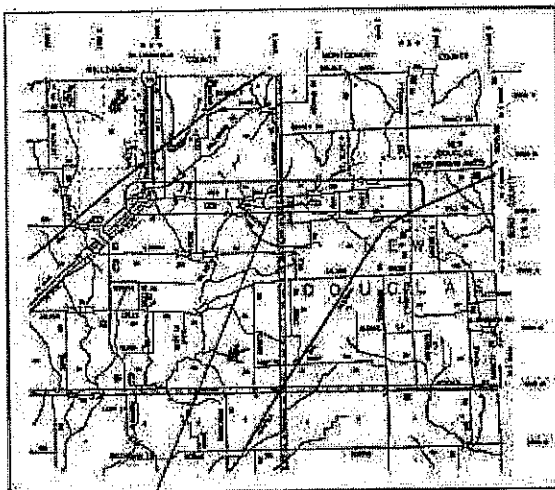

FAS 777 (NEW DOUGLASS RD)
FROM NEW DOUGLASS CITY LIMIT
TO WEST OF I-55

JOINT UTILITY LOCATION
INFORMATION FOR EXCAVATIONS

PHONE: (800) 892-0125

LOCATION MAP

I-55 INTERCHANGE: LAT. 38.96826
LONG. -89.75365

NEW DOUGLASS CITY LIMIT: LAT. 38.97109
LONG. -89.966655

SUBMITTED: March 31, 2005

DEPUTY DIRECTOR OF HIGHWAYS REGION 5 ENGINEER

PASSED

APPROVED

DIRECTOR, DIVISION OF HIGHWAYS

CONTRACT NO. 76909

PRINTED BY THE AUTHORITY OF THE STATE OF ILLINOIS

PROJECT LEADER: WENDA SOUTHERLAND (618-346-3195)
SQUAD LEADER: BRIAN COURTWRIGHT (618-346-3192)

STATE OF ILLINOIS
DEPARTMENT OF TRANSPORTATION
DIVISION OF HIGHWAYS
REGION 5 ENGINEER

TOTAL SHEETS	SHEET NO.
31	2
CONTRACT NO.: 76909	

INDEX OF SHEETS

- 1. Cover Sheet
- 2. Index of Sheets, Standards, Mixture Chart
- 3.-4. General Notes
- 5.-7. Summary of Quantities
- 8.-11. Typical
- 12.-21. Schedules
- 22. Project Layout Map
- 23.-25. I-55 Interchange Details
- 26.-29. Gutter Replacement Details
- 30.-31. Sideroad & Entrance Details

STANDARDS

482001	701306-01	001006
482011-01	701311-01	
606101-01	701326-02	
701001-01	702001-05	
701006-02	780001-01	
701011-01	781001-02	
701301-02	000001-04	

MIXTURE USE	SURFACE	LEVEL BINDER	SHOULDERS	TOP LIFT SHOULDERS
AC/PG	PG 64-22	PG 64-22	PG 58-22	PG 58-22
RAP% (MAX)	10%	15%	30%	30%
DESIGN AIR Voids	4.0% @ Ndes=70	4.0% @ Ndes=70	2.0% @ Ndes=30	**2.0% @ Ndes=30
MIX COMPOSITION (GRADATION MIXTURE)				
FRICITION AGG	MIXTURE "C"	MIXTURE "C"	BAM	BAM

** Top Lift Shoulders - Design this mix at 2.0% voids and add asphalt to reduce voids to 1.5%.

Plan quantities for Bituminous Concrete Surface Course Items are calculated using a unit weight of 112lb/sq yd/in (59.8 kg/sq m/25 mm thickness).

INDEX OF SHEETS & STANDARDS

FAS 777
SECTION 52RS-2, 52-1
MADISON COUNTY

\$\$\$DATE\$\$\$
 3/31/2005
 c:\projects\ed07405\plan\p1n07405a.dgn
 *REF
 *REF

TOTAL SHEETS	SHEET NO.
31	3
CONTRACT NO. 76909	

GENERAL NOTES

1. SAW CUTTING ON ALL EDGES FOR REMOVAL ITEMS SHALL BE INCLUDED IN THE COST OF THE REMOVAL ITEM AS INDICATED AND IN ACCORDANCE WITH SECTION 440 OF THE STANDARD SPECIFICATIONS.

2. IF ANY SECTION OR SUB-SECTION MONUMENTS ARE ENCOUNTERED, THE ENGINEER SHALL BE NOTIFIED BEFORE SUCH MONUMENTS ARE REMOVED OR RESURFACED OVER. THE CONTRACTOR SHALL PROTECT AND CAREFULLY PRESERVE ALL PROPERTY MARKERS AND MONUMENTS UNTIL THE OWNER, AN AUTHORIZED SURVEYOR, OR AGENT HAS WITNESSED OR OTHERWISE REFERENCED THEIR LOCATION.

3. ILLINOIS STATE LAW REQUIRES A 48-HOUR NOTICE BE GIVEN TO ALL UTILITIES BEFORE DIGGING. FIELD MARKING OF FACILITIES MAY BE OBTAINED BY CONTACTING J.U.L.I.E. OR FOR NON-MEMBERS, THE UTILITY COMPANY DIRECTLY. AGENCIES KNOWN TO HAVE FACILITIES WITHIN THE PROJECT AREA ARE AS FOLLOWS:

* AMEREN IP	* MADISON TELEPHONE COMPANY
* CONOCOPHILLIPS COMPANY	* MARATHON ASHLAND PIPELINE, LLC
* CONSOLIDATED COMMUNICATIONS	* MCLEOD USA TELECOMMUNICATIONS, INC.
* FRONTIER COMMUNICATIONS COMPANY	* VILLAGE OF NEW DOUGLAS
* THREE COUNTY PUBLIC WATER DISTRICT	* WILTEL COMMUNICATIONS, LLC
* SOUTHWESTERN ELECTRIC COOPERATIVE, INC.	* VILLAGE OF LIVINGSTON

MEMBERS OF J.U.L.I.E. (800)-892-0123 ARE INDICATED BY *. NON J.U.L.I.E. MEMBERS MUST BE NOTIFIED INDIVIDUALLY.

4. REFER TO ARTICLE 107.20 & 107.25 OF THE STANDARD SPECIFICATIONS AND AS DIRECTED BY THE ENGINEER FOR RELOCATION OF ALL MAILBOXES, EXISTING STREET NAME SIGNS, AND ALL PRIVATE AND COMMERCIAL SIGNS.

5. THE CONTRACTOR SHALL VERIFY ALL DIMENSIONS AND CONDITIONS IN THE FIELD PRIOR TO CONSTRUCTION AND ORDERING OF MATERIALS.

GENERAL NOTES

FAS 777
SECTION 52RS-2, 52-I
MADISON COUNTY

\$\$\$DATE\$\$
 3/31/2005
 c:\projects\ed07405\plan\bln07405a.dgn
 *REF
 *REF

TOTAL SHEETS	SHEET NO.
31	4
CONTRACT NO.: 76909	

6. NO OVERNIGHT LANE CLOSURES WILL BE ALLOWED.
7. ROAD CONSTRUCTION AHEAD SIGNS SHALL BE PLACED AT THE BEGINNING AND END OF THE PROJECT PLUS THE INTERSECTING SIDE ROADS, AND WILL BE INCLUDED IN THE TRAFFIC CONTROL PAY ITEMS. ALL CONSTRUCTION SIGNS SHALL BE FLUORESCENT ORANGE.
8. FLAGMEN SHALL BE PRESENT DURING ALL CLOSURE HOURS, INCLUDING LUNCH HOUR, AND NO ADDITIONAL COMPENSATION SHALL BE APPLIED.
9. IT SHALL BE THE CONTRACTOR'S RESPONSIBILITY TO INSURE THAT ADJACENT PAVEMENT IS NOT DAMAGED DURING OPERATIONS.

GENERAL NOTES

FAS 777
SECTION 52RS-2, 52-I
MADISON COUNTY

\$\$\$DATE\$\$\$
3/23/2005
c:\projects\ed07405\plan\pin07405a.dgn
*REF
*REF

\$\$\$DATE\$\$\$
 3/31/2005
 c:\projects\ec07405\plan\p07405a.dgn
 *REF
 *REF

SUMMARY OF QUANTITIES

CODE NO	ITEM	UNIT	100% STATE TOTAL QUANTITIES	I 000	
				CONTRACT MAINTENANCE FUNDS RURAL	D-8 MISC. FUNDS RURAL
20200600	EXCAVATING AND GRADING EXISTING SHOULDER	UNIT	338		338
25000210	SEEDING, CLASS 2A	ACRE	0.9		0.9
25000400	NITROGEN FERTILIZER NUTRIENT	POUND	86		86
25000500	PHOSPHORUS FERTILIZER NUTRIENT	POUND	86		86
25000600	POTASSIUM FERTILIZER NUTRIENT	POUND	86		86
25100110	MULCH, METHOD 1	TON	1.8		1.8
40600200	BITUMINOUS MATERIALS (PRIME COAT)	TON	8.1	7.2	0.9
40600300	AGGREGATE (PRIME COAT)	TON	38	34.2	3.8
40600980	BITUMINOUS SURFACE REMOVAL - BUTT JOINT	SQ YD	267	267	
40600985	PORTLAND CEMENT CONCRETE SURFACE REMOVAL - BUTT JOINT	SQ YD	925	925	
40600990	TEMPORARY RAMP	SQ YD	190	190	
44002720	GUTTER REMOVAL (SPECIAL)	FOOT	4831	4831	

TOTAL SHEETS	SHEET NO.
31	5
CONTRACT NO.: 76909	

SUMMARY
 OF
 QUANTITIES
 FAS 777
 SECTION 52RS-2, 52-I
 MADISON COUNTY
 PLOT DATE: 3/31/2005

\$\$\$DATE\$\$\$
 3/31/2005
 c:\projects\ed07405\plan\p07405a.dgn
 *REF
 *REF

SUMMARY OF QUANTITIES

CODE NO	ITEM	UNIT	100% STATE TOTAL QUANTITIES	1000		5FTY-2A
				CONTRACT MAINTENANCE FUNDS RURAL	D-8 MISC. FUNDS RURAL	
48202000	BITUMINOUS SHOULDERS SUPERPAVE	TON	202		202	
48202600	BITUMINOUS SHOULDERS SUPERPAVE 8"	SO YD	11413		11413	
60600095	CLASS SI CONCRETE (OUTLET)	CU YD	68	68		
60602700	CONCRETE GUTTER, TYPE A (SPECIAL)	FOOT	4590	4590		
67100100	MOBILIZATION	L SUM	1		1	
70100460	TRAFFIC CONTROL AND PROTECTION, STANDARD 701306	L SUM	1	0.5	0.5	
70100500	TRAFFIC CONTROL AND PROTECTION, STANDARD 701326	L SUM	1	0.5	0.5	
70103815	TRAFFIC CONTROL SURVEILLANCE	CAL DA	24		24	
70300100	SHORT-TERM PAVEMENT MARKING	FOOT	1091	1091		
70300210	TEMPORARY PAVEMENT MARKING - LETTERS AND SYMBOLS	SO FT	94		94	
70300220	TEMPORARY PAVEMENT MARKING - LINE 4"	FOOT	24981		24981	
70301000	WORK ZONE PAVEMENT MARKING REMOVAL	SO FT	8603		8603	

TOTAL SHEETS	SHEET NO.
31	6
CONTRACT NO.: 76909	

SUMMARY
 OF
 QUANTITIES
 FAS 777
 SECTION 52RS-2, 52-1
 MADISON COUNTY
 PLOT DATE: 3/31/2005

SUMMARY OF QUANTITIES

CODE NO	ITEM	UNIT	100% STATE TOTAL QUANTITIES	1000		577Y-2A
				CONTRACT MAINTENANCE FUNDS	RURAL	
* 78001100	PAINT PAVEMENT MARKING - LETTERS AND SYMBOLS	SQ FT	94		94	D-8 MISC. FUNDS RURAL
* 78001110	PAINT PAVEMENT MARKING - LINE 4"	FOOT	69711		69711	
* 78100100	RAISED REFLECTIVE PAVEMENT MARKER	EACH	53	53		
78300200	RAISED REFLECTIVE PAVEMENT MARKER REMOVAL	EACH	53	53		
X4066416	BITUMINOUS CONCRETE SURFACE COURSE, SUPERPAVE, MIX "C", N70	TON	1972		1972	
X4066770	LEVELING BINDER (MACHINE METHOD), SUPERPAVE N70	TON	1031		1031	
	*SPECIALTY ITEMS					

SUMMARY
 OF
 QUANTITIES
 FAS 777
 SECTION 52RS-2, 52-I
 MADISON COUNTY
 PLOT DATE: 3/31/2005

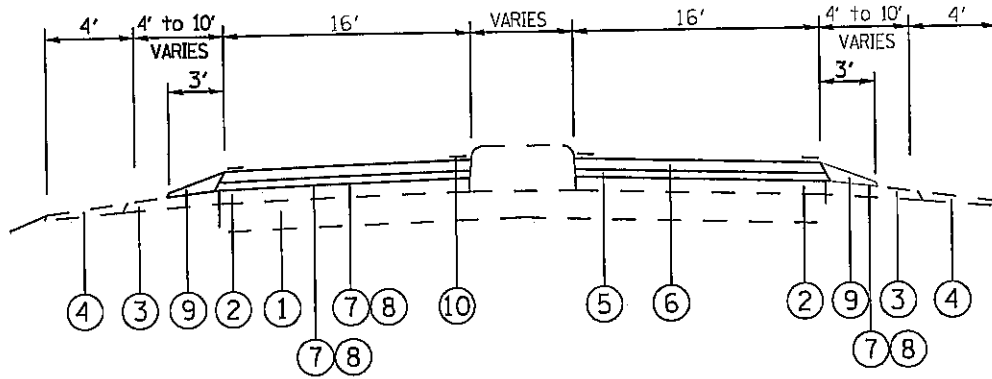

TYPICAL SECTION
Mile Pt. 0.00 to Mile Pt. 0.486

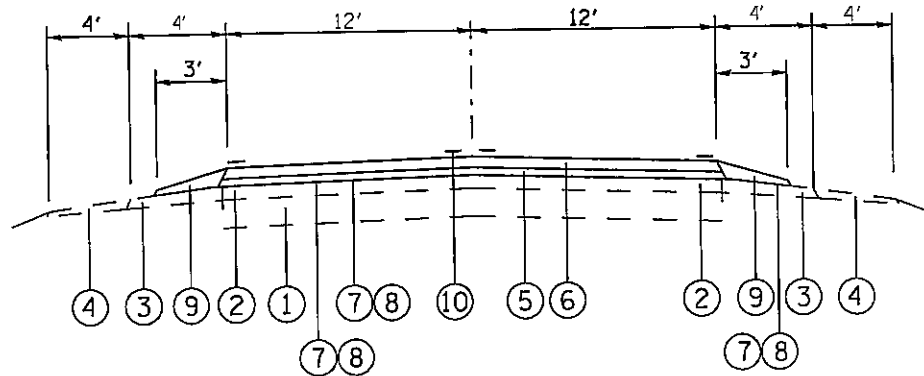

TYPICAL SECTION
Mile Pt. 0.486 to Mile Pt. 0.79

LEGEND

- ① Existing PCC Pavement
- ② Existing Bituminous Concrete
- ③ Existing Bituminous Concrete Shoulder
- ④ Existing Aggregate Shoulder
- ⑤ Proposed Leveling Binder 1"
- ⑥ Proposed Bituminous Concrete Surface Course 1 1/2"
- ⑦ Proposed Bituminous Prime Coat
- ⑧ Proposed Aggregate Prime Coat
- ⑨ Proposed Bituminous Shoulder
- ⑩ Proposed Paint Pavement Marking

TYPICAL SECTIONS

FAS 777
SECTION 52 RS-2, 52-I
MADISON COUNTY

PLOT DATE: 3/31/2005

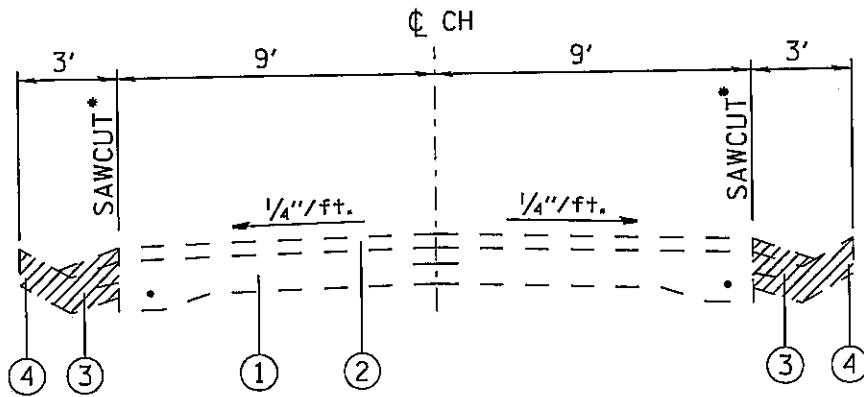

EXISTING TYPICAL SECTION

Mile Pt. 0.79 to Mile Pt. 1.02
 Mile Pt. 1.84 to Mile Pt. 2.14
 Mile Pt. 3.04 to Mile Pt. 3.35

*Saw Cut min. 12", Depth
 Incidental to PCC Gutter
 Type A Special

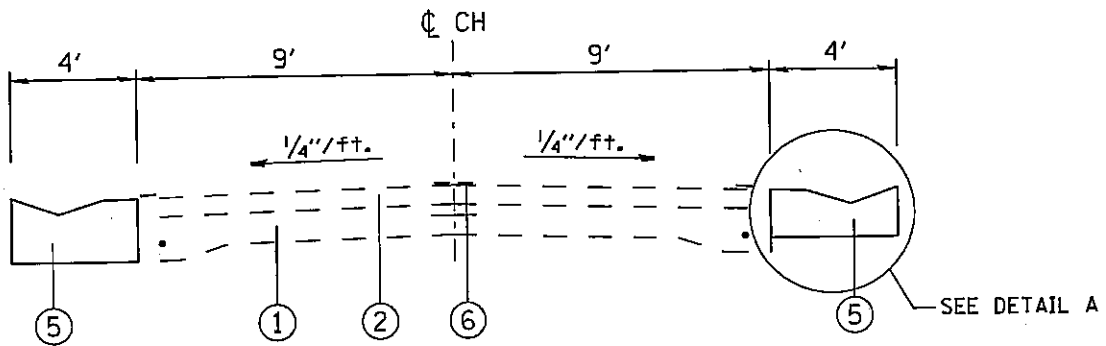

TYPICAL SECTION

Mile Pt. 0.79 to Mile Pt. 1.02

LEGEND

- ① Existing Concrete Pavement 9"-6"-9"
- ② Existing Bituminous Concrete
- ③ Existing Gutter, Type A
- ④ Gutter Removal (Special)
- ⑤ Proposed PCC Gutter Type A Special
- ⑥ Proposed Paint Pavement Marking

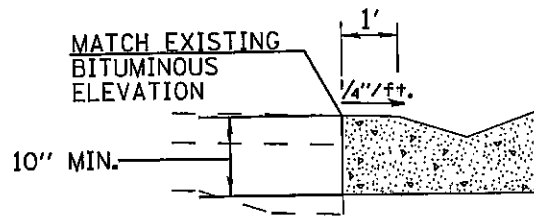

DETAIL A

TYPICAL SECTIONS

FAS 777
 SECTION 52 RS-2, 52-I
 MADISON COUNTY

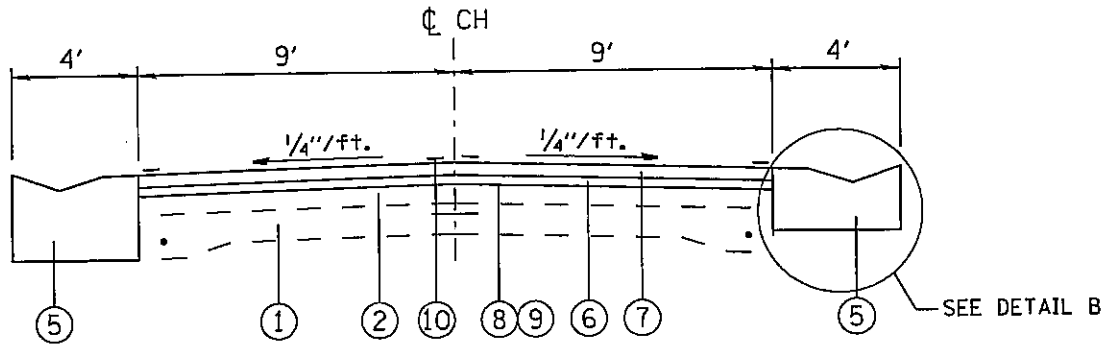

TYPICAL SECTION

Mile Pt. 1.84 to Mile Pt. 2.14
Mile Pt. 3.04 to Mile Pt. 3.37

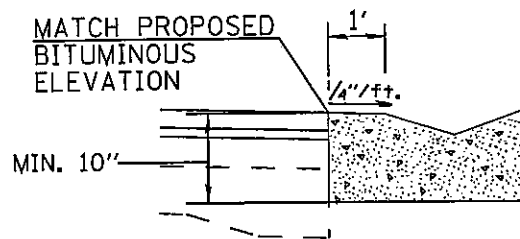

DETAIL B

LEGEND

- ① Existing Concrete Pavement 9'-6'-9"
- ② Existing Bituminous Concrete
- ③ Existing Gutter, Type A
- ④ Gutter Removal (Special)
- ⑤ Proposed PCC Gutter Type A Special
- ⑥ Proposed Leveling Binder 3/4"
- ⑦ Proposed Bituminous Concrete Surface Course 1/2"
- ⑧ Proposed Bituminous Prime Coat
- ⑨ Proposed Aggregate Prime Coat
- ⑩ Proposed Paint Pavement Marking

TYPICAL SECTIONS

FAS 777
SECTION 52 RS-2, 52-I
MADISON COUNTY

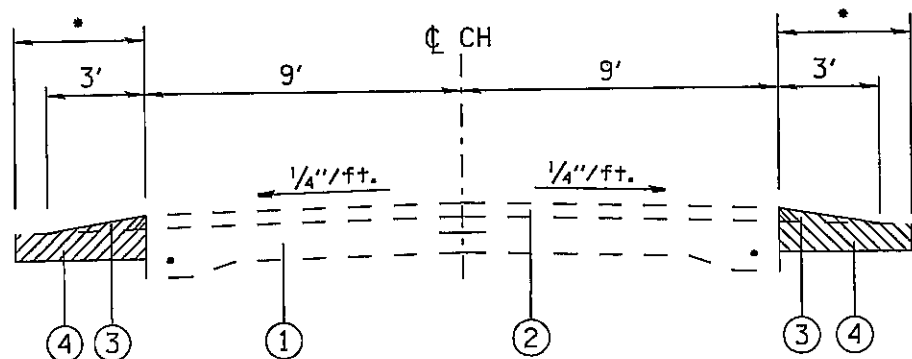

* 4' Or As Directed
By the Engineer

EXISTING TYPICAL SECTION

Mile Pt. 1.02 to Mile Pt. 1.84
Mile Pt. 2.14 to Mile Pt. 3.04
Mile Pt. 3.37 to Mile Pt. 4.54

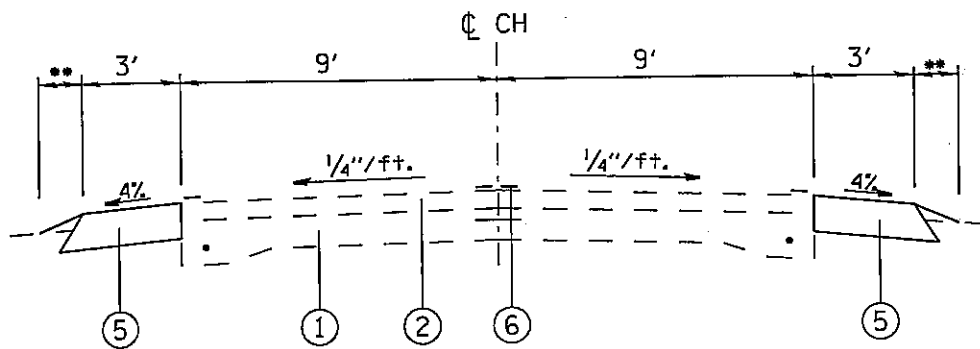

**Embankment Included in
the Cost of Excavating
and Grading Existing
Shoulder as Per Section
202.06 of the Standard
Specifications.

TYPICAL SECTION

Mile Pt. 1.02 to Mile Pt. 1.84
Mile Pt. 2.14 to Mile Pt. 3.04
Mile Pt. 3.37 to Mile Pt. 4.54

LEGEND

- ① Existing Concrete Pavement 9'-6"-9"
- ② Existing Bituminous Overlay Varies ±2.25' To ±4"
- ③ Existing Aggregate Shoulder
- ④ Proposed Excavating and Grading Existing Shoulder
- ⑤ Proposed Bituminous Shoulder 8"
- ⑥ Proposed Paint Pavement Marking

TYPICAL SECTIONS

FAS 777
SECTION 52 RS-2, 52-I
MADISON COUNTY

RESURFACING SCHEDULE - MI 0.00 TO 0.79 (CONT. MAINT. FUNDS)

LOCATION		BIT. MAT'L (P.C.)	AGG. MAT'L (P.C.)	LEVEL BINDER (ton)	SURF CRSE (ton)
M.P.	to M.P.	(ton)	(ton)	(ton)	(ton)
<i>E.B. Mainline</i>					
0.000	to 0.220	0.7	3.1	117	176
0.270	to 0.388	0.3	1.6	61	92
0.388	to 0.486	0.3	1.3	50	75
0.486	to 0.790	0.6	2.8	104	155
<i>W.B. Mainline</i>					
0.000	to 0.220	0.7	3.1	117	176
0.270	to 0.388	0.3	1.6	61	92
0.388	to 0.486	0.3	1.3	50	75
0.486	to 0.790	0.6	2.8	104	155
<i>Turn Lanes</i>					
0.024	to 0.087	0.1	0.5	20	30
0.136	to 0.210	0.2	0.7	28	42
0.283	to 0.350	0.1	0.6	22	34
<i>Intersection Areas</i>					
0.009	to 0.024	0.0	0.2	8	13
0.125	to 0.136	0.0	0.2	7	10
0.350	to 0.360	0.0	0.2	8	11
<i>Rumble Strip</i>					
0.433	to 0.486	0.1	0.4	15	23
<i>Sideroads</i>					
0.02 LT		0.1	0.5		33
0.02 RT		0.1	0.5		33
S.B. I-55 ENT. RAMP		0.1	0.5		33
S.B. I-55 EXIT RAMP		0.1	0.5		33
N.B. I-55 ENT. RAMP		0.1	0.5		33
N.B. I-55 EXIT RAMP		0.1	0.5		33
0.55 LT		0.1	0.5		33
0.55 RT		0.1	0.5		33
0.70 LT		0.1	0.5		33
TOTAL =		5.2	24.9	772	1456

I-55 INTERCHANGE RESURFACING SCHEDULE

FAS 777
SECTION 52 RS-2, 52-I
MADISON COUNTY

DATE: 3/31/2005

\$\$\$DATE\$\$\$
 3/31/2005
 c:\p\projects\ed07405\plan\pin07405a.dgn
 *REF.
 *REF.

RESURFACING SCHEDULE - MI 1.84 TO 2.14 AND 3.04 TO 3.37 (CONT. MAINT. FUNDS)

M.P.	to	M.P.	BIT. MAT'L (P.C.) (ton)	AGG. MAT'L (P.C.) (ton)	LEVEL BINDER (ton)	SURF CRSE (ton)
1.840	to	2.022	0.6	2.9	81	161
2.046	to	2.140	0.3	1.5	42	83
3.040	to	3.240	0.7	3.2	89	177
3.243	to	3.350	0.4	1.7	47	95
TOTAL =			2.0	9.3	259	516

SIDEROAD SCHEDULE

MI	LT/RT	WIDTH (FT)	NAME
1.24	LT	60	HEINZ RD
1.24	RT	60	HEINZ RD
2.04	RT	43	ARCHER RD
2.39	LT	45	DEER CROSSING
2.77	LT	50	NIEHAUS
2.77	RT	46	NIEHAUS
3.09	RT	30	ENTRANCE
3.69	RT	45	URICH RD
3.99	LT	45	MT. OLIVE
4.27	RT	33	ERNST
		457	

LOCATION 2 & 3
RESURFACING &
SIDEROAD SCHEDULE

FAS 777
SECTION 52 RS-2, 52-I
MADISON COUNTY

PLOT DATE: 3/31/2005

SHOULDER SCHEDULE - MI 0.00 TO 0.79 (D-8 MISC. FUNDS)

		BITUMINOUS SHOULDER			
M.P.	to M.P.	Width (ft)	BIT. MAT'L (P.C.) (ton)	AGG. MAT'L (P.C.) (ton)	BIT. SHLDR (ton)
<i>Right</i>					
0.023	to 0.125	3	0.1	0.3	15
0.125	to 0.220	3	0.1	0.3	14
0.270	to 0.388	3	0.1	0.3	17
0.388	to 0.790	3	0.2	1.0	55
<i>Left</i>					
0.020	to 0.087	3	0.0	0.2	9
0.087	to 0.220	3	0.1	0.4	20
0.270	to 0.388	3	0.1	0.3	17
0.388	to 0.790	3	0.2	1.0	55
TOTAL =			0.9	3.8	202

**I-55 INTERCHANGE SHOULDER
RESURFACING SCHEDULE**

FAS 777
SECTION 52 RS-2, 52-1
MADISON COUNTY

PLOT DATE: 3/31/2005

GUTTER, EXCAVATING & SHOULDER SCHEDULE

LOCATION (MILE PT.)	CONT. MAINT. FUNDS			D-8 MISC. FUNDS			COMMENTS
	GUTTER REMOVAL (LIN. FT.)	CONCRETE GUTTER, TYPE A, (SPECIAL) (LIN. FT.)	CLASS SI CONCRETE (OUTLET) (CU.YD.)	EXCAVATING AND GRADING EXISTING SHOULDER (UNIT)	BITUMINOUS SHOULDER 8" (SQ.YD.)		
0.820 TO 0.905	LT 450						
0.908 TO 0.913	LT 28						
0.985 TO 0.990	LT 28						
0.990 TO 1.064	LT 390						
0.840 TO 0.903	RT 335						
0.903 TO 0.908	RT 28						
0.984 TO 0.990	RT 28						
0.990 TO 1.064	RT 390						
0.790 TO 0.823	LT			1.8	58		INLET
0.823 TO 0.825	LT		0.92				
0.825 TO 0.902	LT	448					
0.902 TO 0.912	LT		4.80				OUTLET
0.912 TO 0.943	LT			1.6	55		
0.973 TO 0.986	LT			0.7	23		
0.986 TO 0.997	LT		4.80				OUTLET
0.997 TO 1.010	LT	342					
1.010 TO 1.020	LT		0.92				INLET
0.790 TO 0.844	RT			2.8	95		
0.844 TO 0.847	RT		0.92				INLET
0.847 TO 0.902	RT	333					
0.902 TO 0.912	RT		4.80				OUTLET
0.912 TO 0.943	RT			1.6	55		
0.973 TO 0.986	RT			0.7	23		
0.986 TO 0.997	RT		4.80				OUTLET
0.997 TO 1.010	RT	342					
1.010 TO 1.020	RT		0.92				INLET

SCHEDULE CONTINUED ON NEXT

GUTTER, EXCAVATING & SHOULDER SCHEDULE

FAS 777
 SECTION 52 RS-2, 52-I
 MADISON COUNTY

\$\$\$DATE\$\$\$
 3/31/2005
 c:\projects\ed07405\plan\pin07405a.dgn
 *REF
 *REF

GUTTER, EXCAVATING & SHOULDER SCHEDULE

LOCATION (MILE PT.)	CONT. MAINT. FUNDS			D-8 MISC. FUNDS			COMMENTS
	GUTTER REMOVAL (LIN. FT.)	CONCRETE GUTTER, TYPE A, (SPECIAL) (LIN. FT.)	CLASS SI CONCRETE (OUTLET) (CU.YD.)	EXCAVATING AND GRADING EXISTING SHOULDER (UNIT)	BITUMINOUS SHOULDER 8" (SQ.YD.)		
1.020 TO 1.840	LT						
1.020 TO 1.840	RT			43.3	1443		
1.840 TO 1.940	LT	538		43.3	1443		
1.940 TO 1.943	LT	22					OUTLET
1.840 TO 1.940	RT	538					
1.940 TO 1.943	RT	22					OUTLET
2.042 TO 2.045	RT	20					OUTLET
2.045 TO 2.140	RT	500					
1.840 TO 1.842	LT		0.92				INLET
1.842 TO 1.938	LT	490					
1.938 TO 1.945	LT		4.8				OUTLET
1.945 TO 2.022	LT			4.1	136		
2.046 TO 2.140	LT			5	165		
1.840 TO 1.842	RT		0.92				INLET
1.842 TO 1.938	RT	490					
1.938 TO 1.945	RT		4.8				OUTLET
1.945 TO 2.022	RT			3.9	132		
2.042 TO 2.050	RT		4.8				OUTLET
2.050 TO 2.055	RT		3.12				ENTRANCE
2.055 TO 2.138	RT	433					
2.138 TO 2.140	RT		0.92				OUTLET
2.140 TO 3.040	LT			47.5	1584		
2.140 TO 3.040	RT			47.5	1584		

SCHEDULE CONTINUED ON NEXT

GUTTER, EXCAVATING & SHOULDER SCHEDULE

FAS 777
 SECTION 52 RS-2, 52-1
 MADISON COUNTY

PLOT DATE: 3/31/2005

TOTAL SHEETS	SHEET NO.
31	16
CONTRACT NO. 76909	

\$\$\$DATE\$\$
 3/31/2005
 c:\p\projects\ed07405\plan\pin07405a.dgn
 *REF
 *REF

GUTTER, EXCAVATING & SHOULDER SCHEDULE

LOCATION (MILE PT.)	CONT. MAINT. FUNDS			D-8 MISC. FUNDS			COMMENTS
	GUTTER REMOVAL (LIN. FT.)	CONCRETE GUTTER, TYPE A, (SPECIAL) (LIN. FT.)	CLASS SI CONCRETE (OUTLET) (CU.YD.)	EXCAVATING AND GRADING EXISTING SHOULDER (UNIT)	BITUMINOUS SHOULDER 8" (SQ.YD.)		
3.040 TO 3.100	LT						
3.100 TO 3.108	LT						OUTLET
3.269 TO 3.270	LT						OUTLET
3.270 TO 3.370	LT						
3.040 TO 3.100	RT						
3.100 TO 3.108	RT						OUTLET
3.269 TO 3.270	RT						OUTLET
3.270 TO 3.32	RT						
3.040 TO 3.042	LT			0.92			INLET
3.042 TO 3.100	LT	309					
3.100 TO 3.110	LT			4.8			OUTLET
3.110 TO 3.240	LT				6.9	229	
3.243 TO 3.269	LT			1.4	1.4	46	
3.269 TO 3.277	LT			4.8			OUTLET
3.277 TO 3.368	LT		483				
3.368 TO 3.371	LT			0.92			INLET
3.040 TO 3.042	RT			0.92			INLET
3.042 TO 3.100	RT						
3.100 TO 3.110	RT		309				OUTLET
3.110 TO 3.240	RT			4.8			
3.242 TO 3.250	RT			4.8			OUTLET
3.250 TO 3.368	RT		611				
3.368 TO 3.370	RT			0.92			
3.370 TO 4.540	LT				61.8	2059	
3.370 TO 4.540	RT				61.8	2059	
LESS FOR S.R./ENT.*					4.6	152	
TOTAL		4831	4590	68	338	11413	

TOTAL SHEETS	SHEET NO.
31	17
CONTRACT NO.: 76909	

*SEE SIDEROAD SCHEDULE OF PAGE 13

**GUTTER, EXCAVATING
& SHOULDER SCHEDULE**

FAS 777
 SECTION 52 RS-2, 52-I
 MADISON COUNTY

DATE: 3/31/2005

BUTT-JOINT SCHEDULE (CM FUNDS)

LOCATION (MILE PTS.)	LT/RT	BITUMINOUS BUTT JOINT (SQ YDS)	COMMENTS
1.840 TO 1.843		33.33	
2.018 TO 2.022		33.33	
2.046 TO 2.049		33.33	
2.136 TO 2.140		33.33	
3.040 TO 3.043		33.33	
3.239 TO 3.240		33.33	
3.243 TO 3.246		33.33	
3.346 TO 3.350		33.33	
TOTAL		267	

TEMPORARY RAMP SCHEDULE (CM FUNDS)

LOCATION (MILE PTS.)	LT/RT	TEMPORARY RAMP (SQ YDS)
1.840		5
2.022		5
2.046		5
2.146		5
3.040		5
3.240		5
3.243		5
3.350		5
TOTAL		40

BUTT-JOINT SCHEDULE (CM FUNDS)

LOCATION (STATIONS)	LT/RT	PCC BUTT JOINT (SQ YDS)	COMMENTS
0+00 TO 0+20		115.56	
11+55 TO 11+75		115.56	
14+08 TO 14+28		115.56	
39+55 TO 39+85		80.00	
1+05	LT/RT	142.22	SIDEROAD
6+90	RT	40.00	EXIT RAMP
6+90	LT	71.11	ENT. RAMP
19+00	LT	44.44	EXIT RAMP
19+35	RT	66.67	ENT. RAMP
29+30	RT	66.67	SIDEROAD
35+30	LT	66.67	SIDEROAD
TOTAL		925	

TEMPORARY RAMP SCHEDULE (CM FUNDS)

LOCATION (STATIONS)	LT/RT	TEMPORARY RAMP (SQ YDS)
I-55 INTERCHANGE		
0+00		19.24
11+75		19.24
14+25		19.24
40+15		8.88
1+05	LT	11.84
1+05	RT	11.84
6+90	RT	6.66
6+90	LT	11.84
19+00	LT	7.4
19+35	RT	11.1
29+30	RT	11.1
35+30	LT	11.1
TOTAL		150

**BUTT-JOINT &
 TEMPORARY RAMP
 SCHEDULE
 FAS 777
 SECTION 52-I
 MADISON COUNTY**

PAV'T MARKING SCHED. @ I-55 INTERCHANGE MI. 0.00 TO 0.79 (D-8 MISC. FUNDS)

LOCATION		PAINT PAVEMENT MARKING 4"				
		EDGE LINE SOLID WHITE	N.P. ZONE SOLID YELLOW	PASSING ZONE SOLID YELLOW	SKIP DASH YELLOW	
APPROX, MILE PT.	STA. TO STA.	(FEET)	(FEET)	(FEET)	(FEET)	
0	0+00 TO 0+57	LT	57			
	0+00 TO 0+69	RT	69			
	0+00 TO 0+46	C		105		
0.02	1+05	LT			8	
	1+05	RT			8	
0.023	1+21 TO 6+60	C		1122		
	1+21 TO 3+56	C	235			
	1+51 TO 6+10	LT	459			
	1+51 TO 6+12	RT	461			
0.13	6+90	LT		30		
0.136	7+20 TO 11+75	LT	455			
	7+20 TO 11+75	RT	455			
	7+20 TO 9+70	C	250			
	7+20 TO 11+75	C		916		
0.27	14+08 TO 18+28	LT	420			
	14+08 TO 18+68	RT	460			
	14+08 TO 18+58	C		960		
	16+58 TO 18+58	C	200			
	18+58	LT		30		
0.36	19+25	LT	30			
	19+25	RT		30		
	19+25 TO 26+00	C		1395		
	19+55 TO 28+90	LT	935			
	19+75	RT	30			
	19+85 TO 28+90	RT	905			
0.486	26+00 TO 29+75	C		375	94	
0.56	29+75 TO 34+70	LT	495			
	29+75 TO 39+85	RT	1010			
	29+75 TO 32+15	C		240		
0.61	32+15 TO 39+85	C		770	193	
0.67	35+60 TO 39+85	LT	425			
SUB-TOTAL			7351	240	5733	303
TOTAL			7351		6276	

**PAVEMENT MARKING
SCHEDULE**

**FAS 777
SECTION 52 RS-2, 52-I
MADISON COUNTY**

PLT DATE: 3/31/2005

\$\$\$DATE\$\$\$
 3/31/2005
 c:\projects\ed07405\plan\p1n07405a.dgn
 *REF
 *REF

PAVT MARKING SCHED. MI 0.79 TO 4.54 (D-8 MISC. FUNDS)

LOCATION MILE PT. TO MILE PT.	PAINT PAVEMENT MARKING 4"			
	EDGE LINE SOLID WHITE (FEET)	N.P. ZONE SOLID YELLOW (FEET)	PASSING ZONE SOLID YELLOW (FEET)	SKIP DASH YELLOW (FEET)
0.79 TO 0.81	240		120	30
0.81 TO 1.02	2660	2660		
1.02 TO 1.25	2430		1215	304
1.25 TO 1.51	2746			343
1.51 TO 1.75	2534		1267	317
1.75 TO 1.84	950	950		
1.84 TO 1.95	1162		581	146
1.95 TO 2.01	634	634		
2.01 TO 2.13	1380		690	173
2.13 TO 2.53	4224	4224		
2.53 TO 2.73	2112		1056	264
2.73 TO 2.78	528			66
2.78 TO 3.04	2746		1373	343
3.04 TO 3.19	1620		810	203
3.19 TO 3.27	822	822		
3.27 TO 3.37	1032		516	129
3.37 TO 3.39	212		106	27
3.39 TO 3.64	2640		1320	330
3.64 TO 4.54	3906			488
SUB-TOTAL		9290	9054	3162
TOTAL	34578		21506	
GRAND TOTAL		69711		

RRPM SCHED. (C.M. FUNDS)

LOCATION MILE TO MILE	RRPM REMOVAL (EACH)	RRPM (EACH)
0.00 TO 0.79	18	18
1.84 TO 2.13	20	20
3.04 TO 3.37	15	15
TOTAL	53	53

PAVEMENT MARKING SCHEDULE

FAS 777
SECTION 52 RS-2, 52-1
MADISON COUNTY

EROSION CONTROL SCHEDULE (D-8 MISC FUNDS)

LOCATION (MILE PT. TO MILE PT.)	LT/RT	SEEDING CLASS 2A (acre)	NITROGEN FERTILIZER NUTRIENT (lb)	PHOSPHORUS FERTILIZER NUTRIENT (lb)	POTASSIUM FERTILIZER NUTRIENT (lb)	MULCH METHOD 1 (ton)
0.79 TO 1.02	LT	0.03	3.0	3.0	3.0	0.06
1.02 TO 1.84	LT	0.10	9.0	9.0	9.0	0.20
1.84 TO 2.13	LT	0.04	4.0	4.0	4.0	0.08
2.13 TO 3.04	LT	0.11	10.0	10.0	10.0	0.22
3.04 TO 3.37	LT	0.04	4.0	4.0	4.0	0.08
3.37 TO 4.54	LT	0.14	13.0	13.0	13.0	0.28
0.79 TO 1.02	RT	0.03	3.0	3.0	3.0	0.06
1.02 TO 1.84	RT	0.10	9.0	9.0	9.0	0.20
1.84 TO 2.13	RT	0.04	4.0	4.0	4.0	0.08
2.13 TO 3.04	RT	0.11	10.0	10.0	10.0	0.22
3.04 TO 3.37	RT	0.04	4.0	4.0	4.0	0.08
3.37 TO 4.54	RT	0.14	13.0	13.0	13.0	0.28
		0.9	86	86	86	1.8

EROSION CONTROL
 SCHEDULE

FAS 777
 SECTION 52 RS-2, 52-I
 MADISON COUNTY

TOTAL SHEETS	SHEET NO.
31	22
CONTRACT NO. 76909	

\$\$\$DATE\$\$\$
 3/31/2005
 c:\projects\ed07405\plan\p1n07405a.dgn
 *REF
 *REF

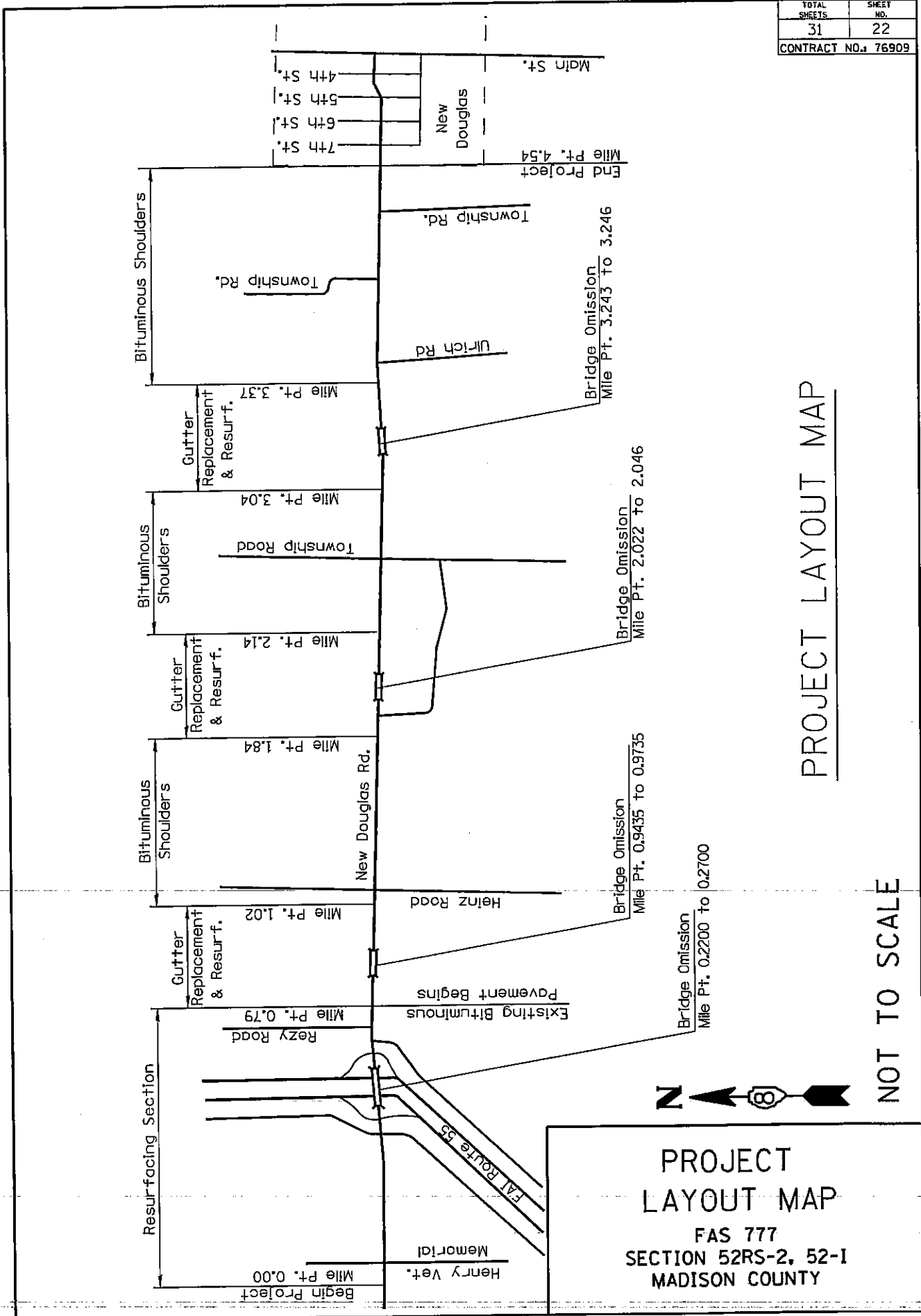

PROJECT LAYOUT MAP

PROJECT
 LAYOUT MAP
 FAS 777
 SECTION 52RS-2, 52-1
 MADISON COUNTY

NOT TO SCALE

TOTAL SHEETS	SHEET NO.
31	23
CONTRACT NO.: 76909	

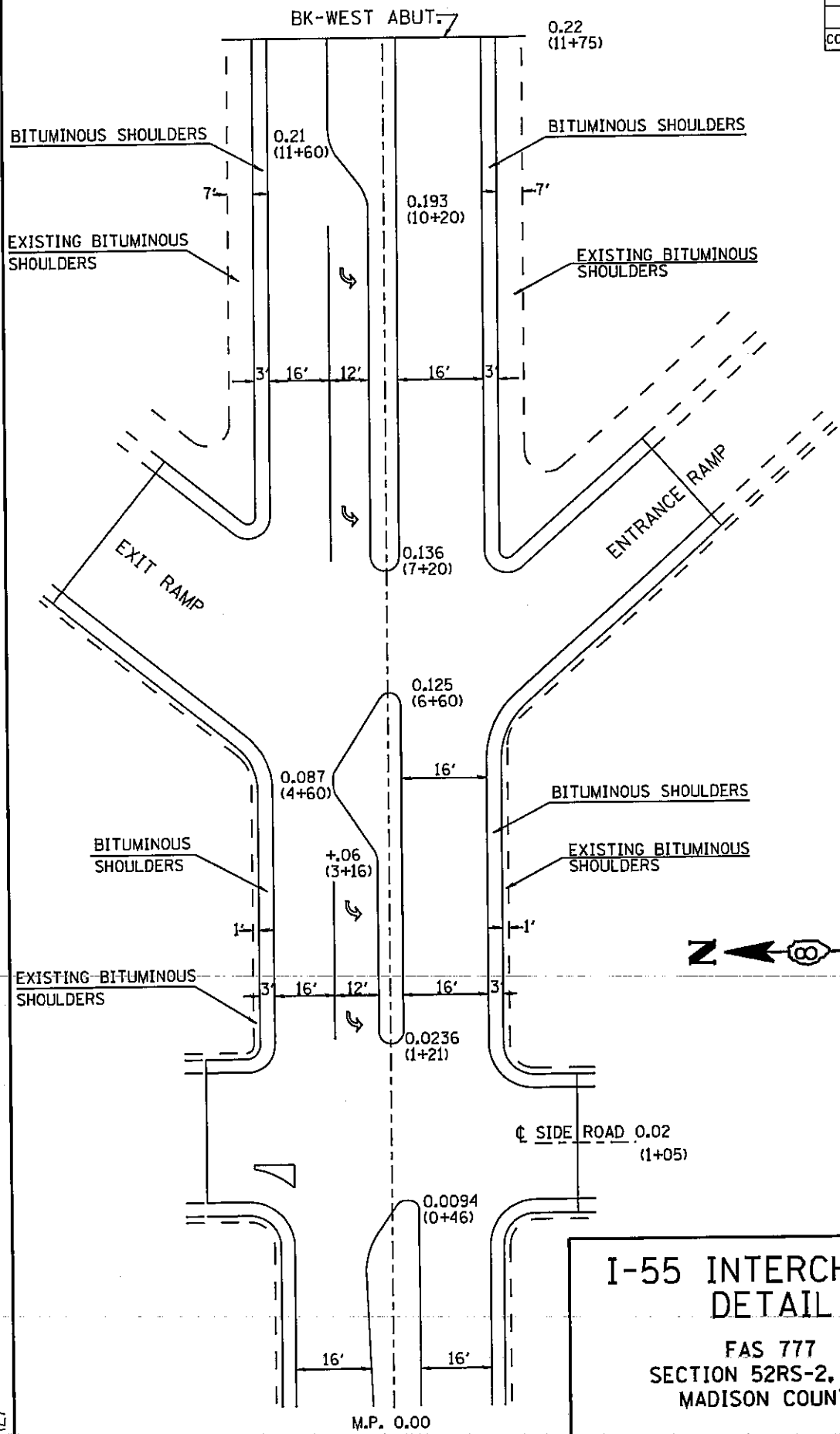

**I-55 INTERCHANGE
DETAIL**

FAS 777
SECTION 52RS-2, 52-I
MADISON COUNTY

DATE: 3/31/2005
 PROJECT: c:\projects\ec07405\plan\p1n07405a.dgn
 REF: *REF

PLOT DATE: 3/31/2005

TOTAL SHEETS	SHEET NO.
31	24
CONTRACT NO.: 76909	

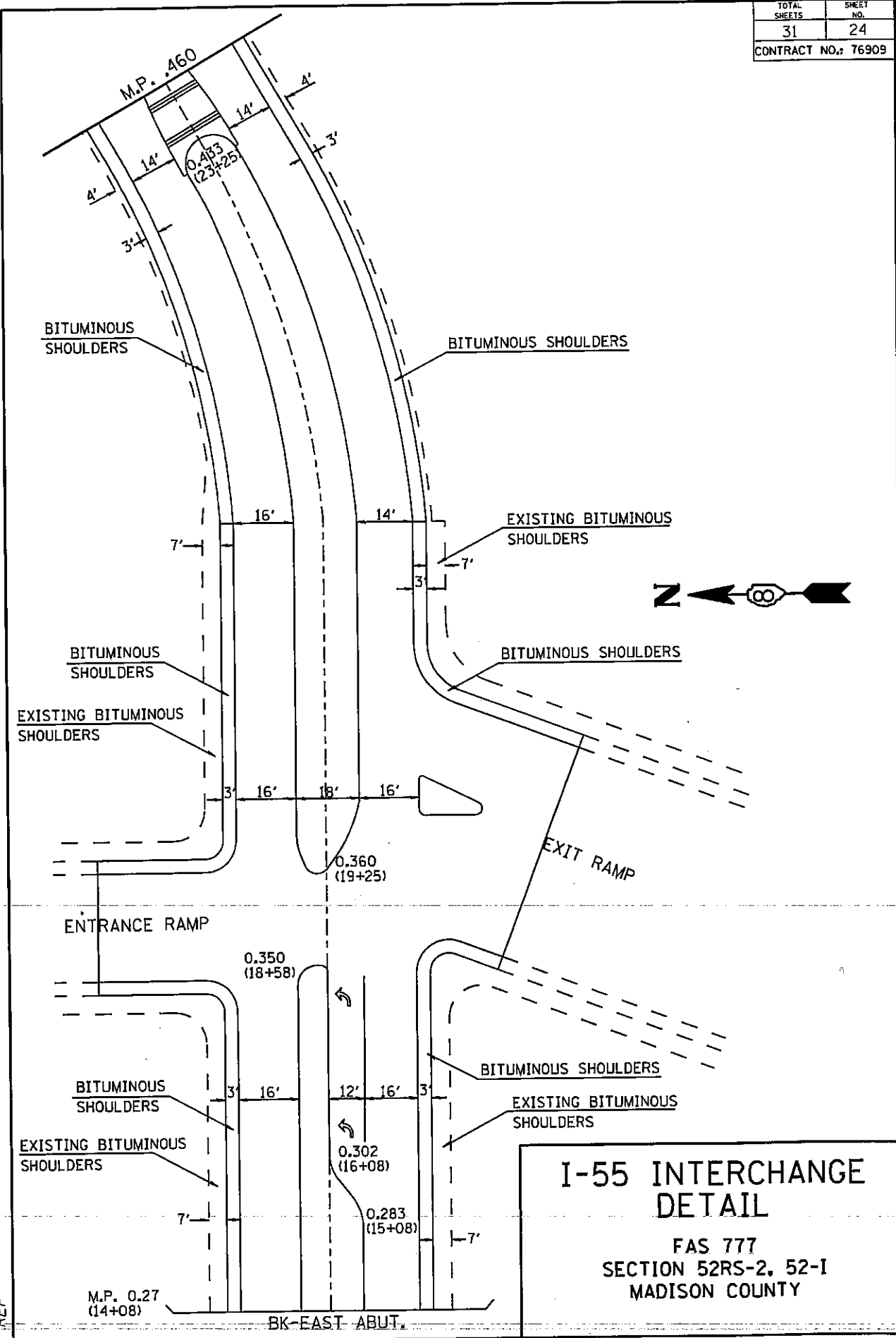

**I-55 INTERCHANGE
DETAIL**

FAS 777
SECTION 52RS-2, 52-I
MADISON COUNTY

\$\$\$DATE\$\$\$
3/31/2005
c:\projects\ed07405\plan\p1n07405a.dgn
*REF
*REF

TOTAL SHEETS	SHEET NO.
31	25
CONTRACT NO. 76909	

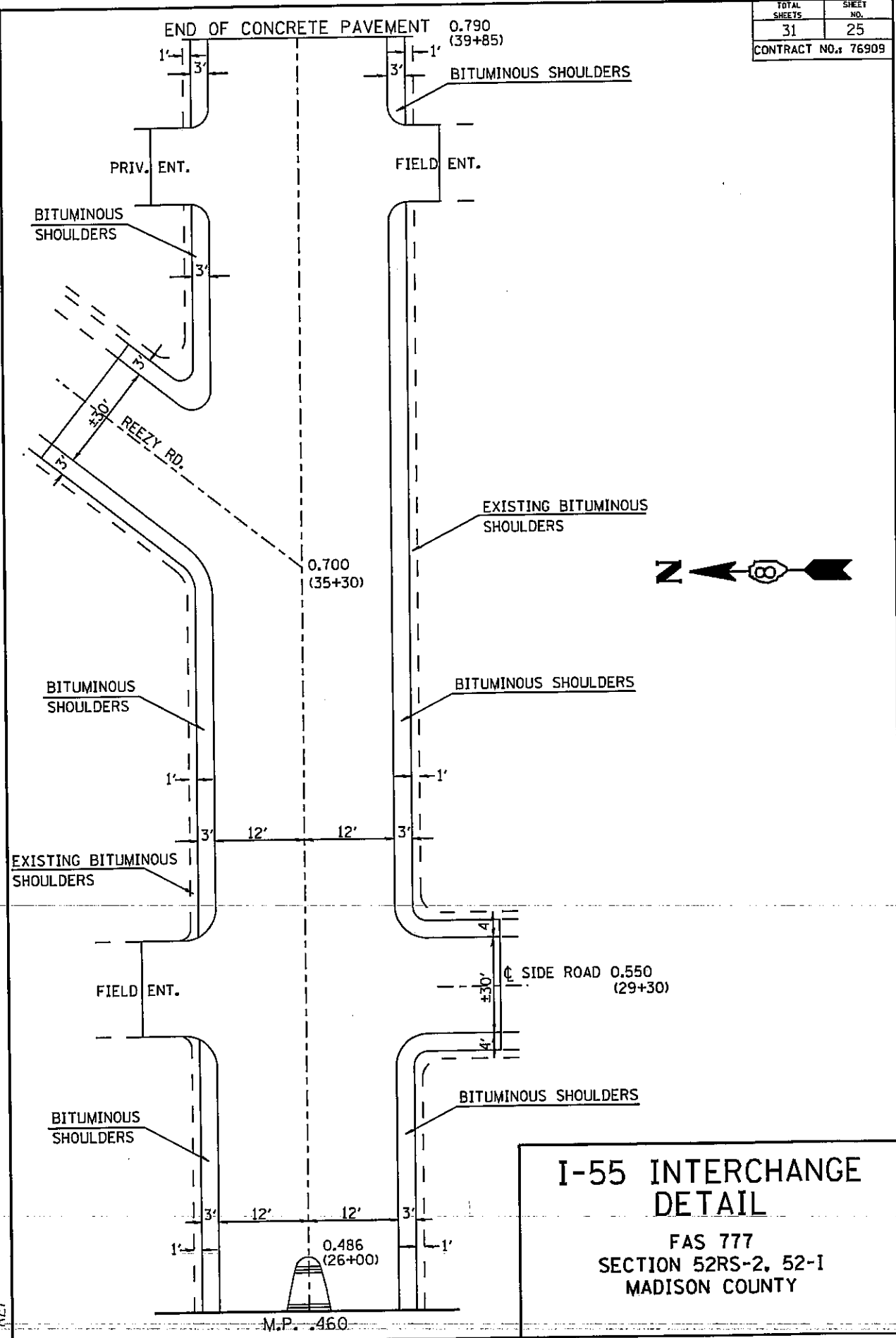

**I-55 INTERCHANGE
DETAIL**

FAS 777
SECTION 52RS-2, 52-1
MADISON COUNTY

\$\$\$\$DATE\$\$
3/31/2005
c:\projects\ed07405\plan\pin07405a.dgn
*REF
*REF

TOTAL SHEETS	SHEET NO.
31	26
CONTRACT NO.: 76909	

M.P. 0.1136

CONCRETE GUTTER,
TYPE A (SPECIAL)

9'

9'

2+90

M.P. 0.845

1+85

1+75



BITUMINOUS SHOULDER
SUPERPAVE-8"

M.P. 0.82

12'

12'

M.P. 0.79

(0+00)

PLOT DATE: 3/31/2005

GUTTER
REPLACEMENT
DETAILS
FAS 777
SECTION 52RS-2, 52-1
MADISON COUNTY

DATE: 3/31/2005
C:\projects\ed07405\plan\pin07405a.dgn
*REF
*REF

TOTAL SHEETS	SHEET NO.
31	27
CONTRACT NO.: 76909	

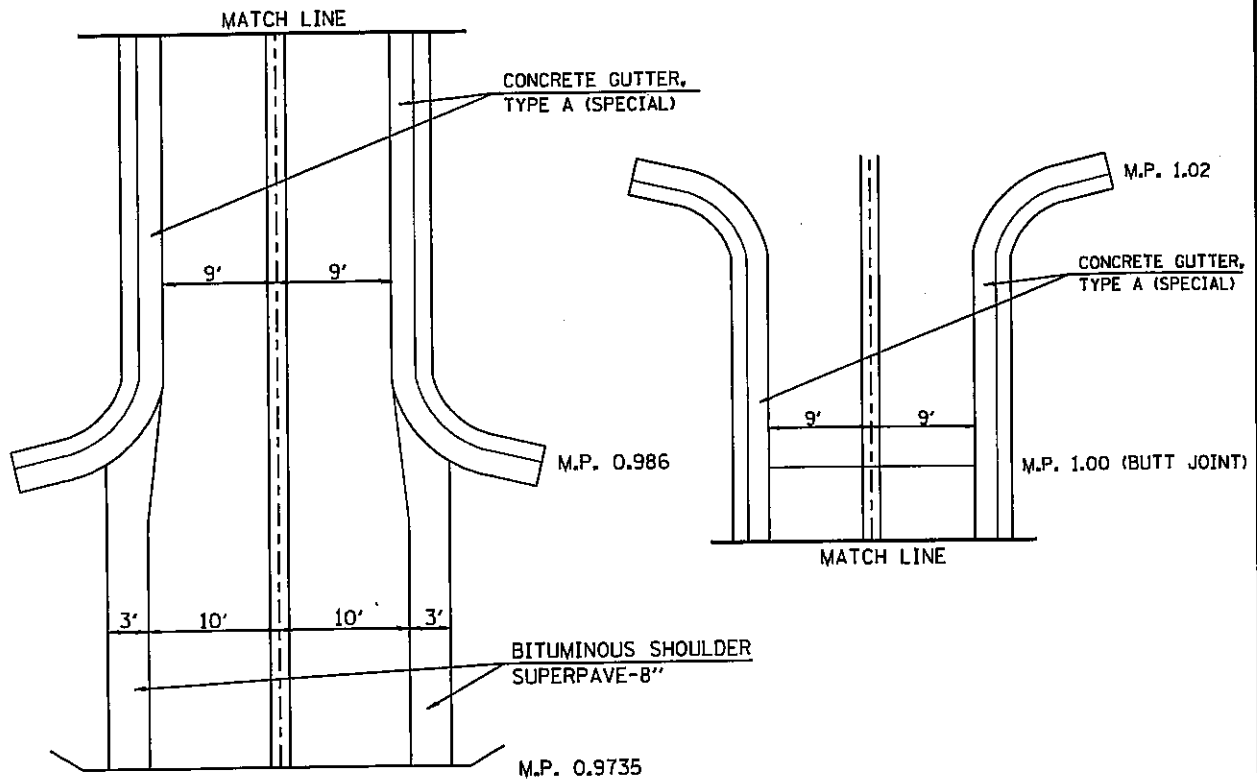

BRIDGE OMISSION

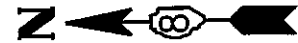
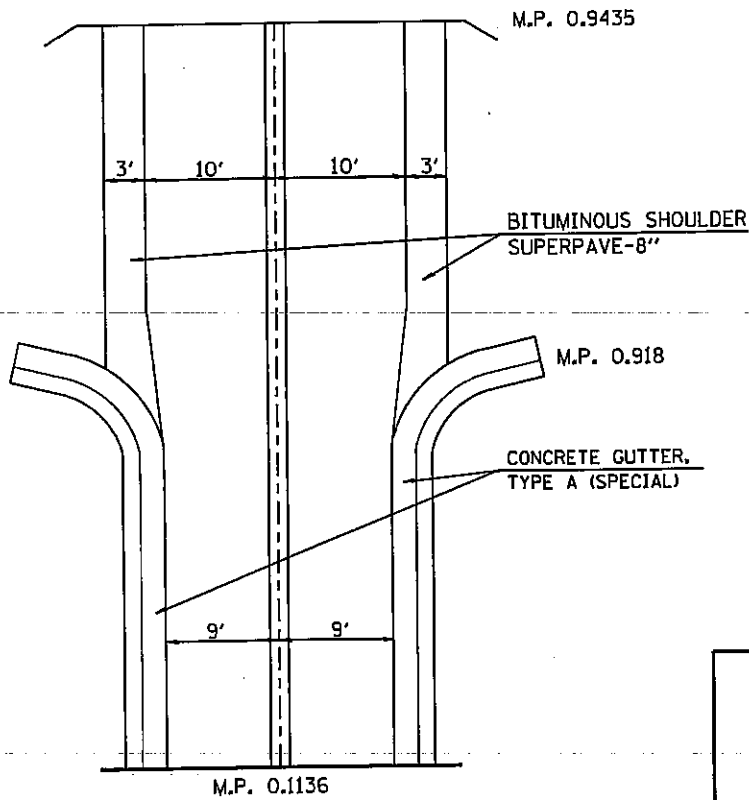

**GUTTER
REPLACEMENT
DETAILS**
 FAS 777
 SECTION 52RS-2, 52-1
 MADISON COUNTY

\$\$\$DATE\$\$\$
 3/31/2005
 c:\projects\ed07405\plan\plan07405a.dgn
 *REF
 *REF

PL01-DATE: 3/31/2005

TOTAL SHEETS	SHEET NO.
31	28
CONTRACT NO.: 76909	

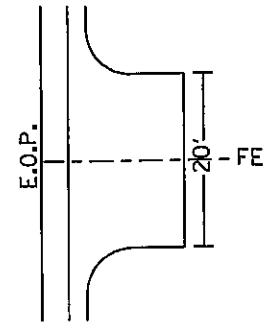
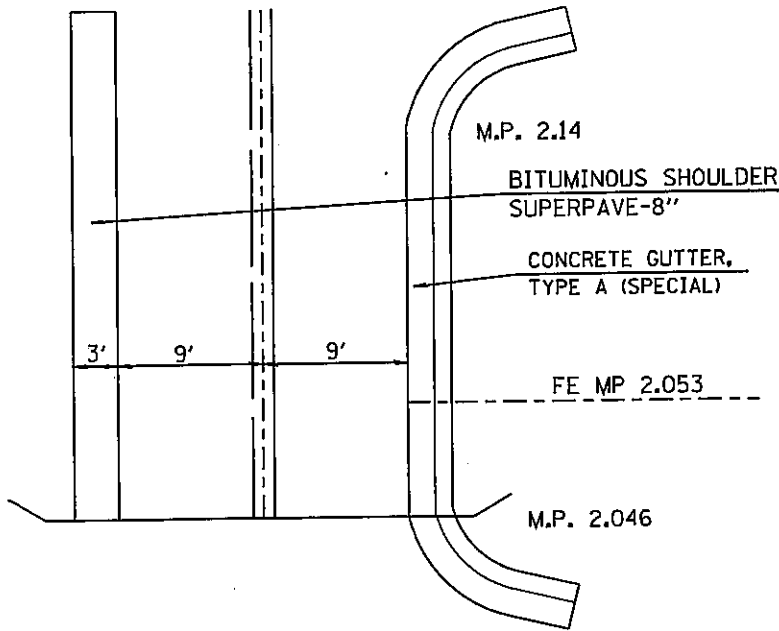

BRIDGE OMISSION

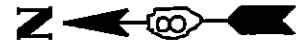
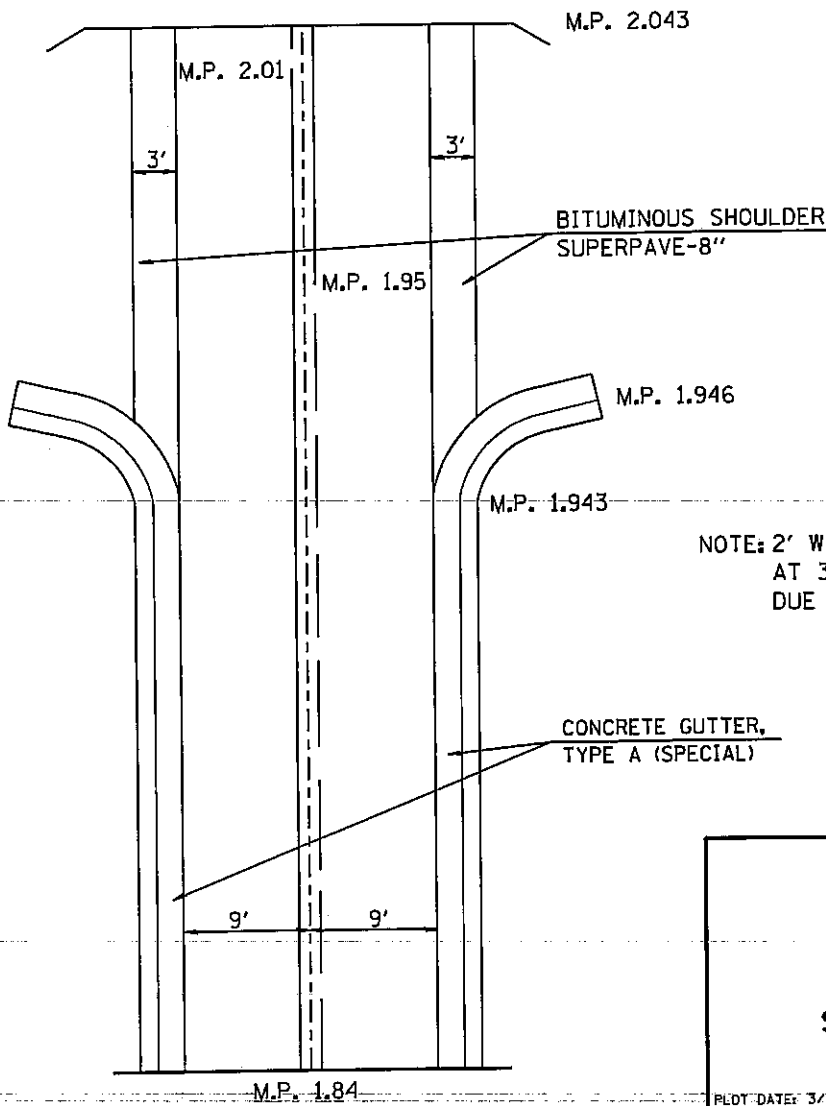

NOTE: 2' WIDE BITUMINOUS SHOULDERS
AT 3 CORNERS OF BRIDGE FOR 50 FT.
DUE TO GUARD RAIL RESTRICTIONS

GUTTER
REPLACEMENT
DETAILS
FAS 777
SECTION 52RS-2, 52-1
MADISON COUNTY

DATE: 3/31/2005
PROJECT: c:\projects\ed07405\plan\pln07405a.dgn
REF

PLOT DATE: 3/31/2005

TOTAL SHEETS	SHEET NO.
31	29
CONTRACT NO.: 76909	

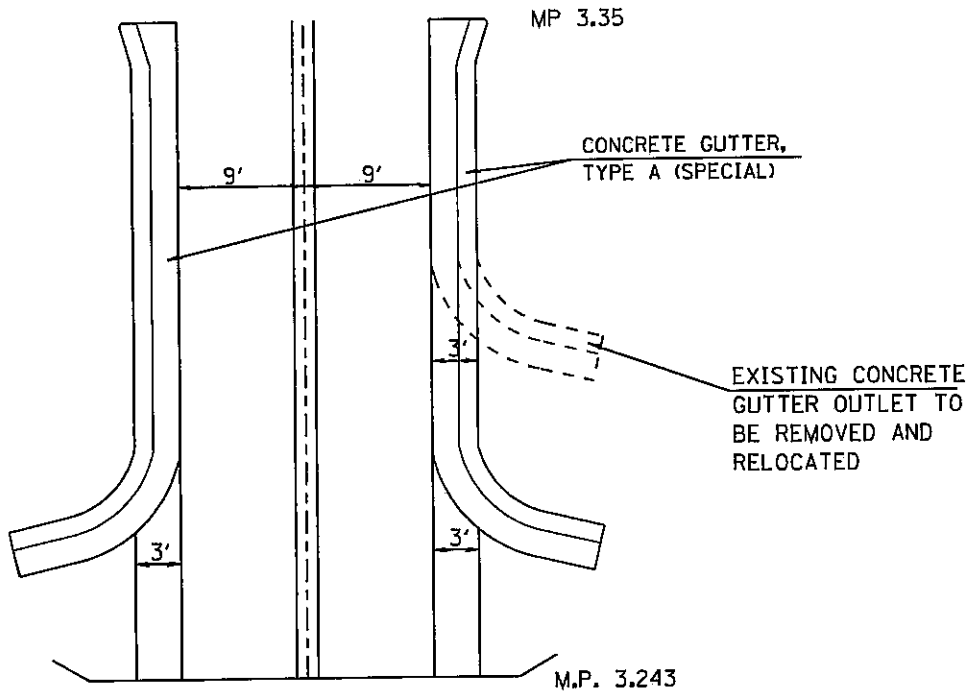

BRIDGE OMISSION

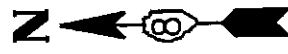
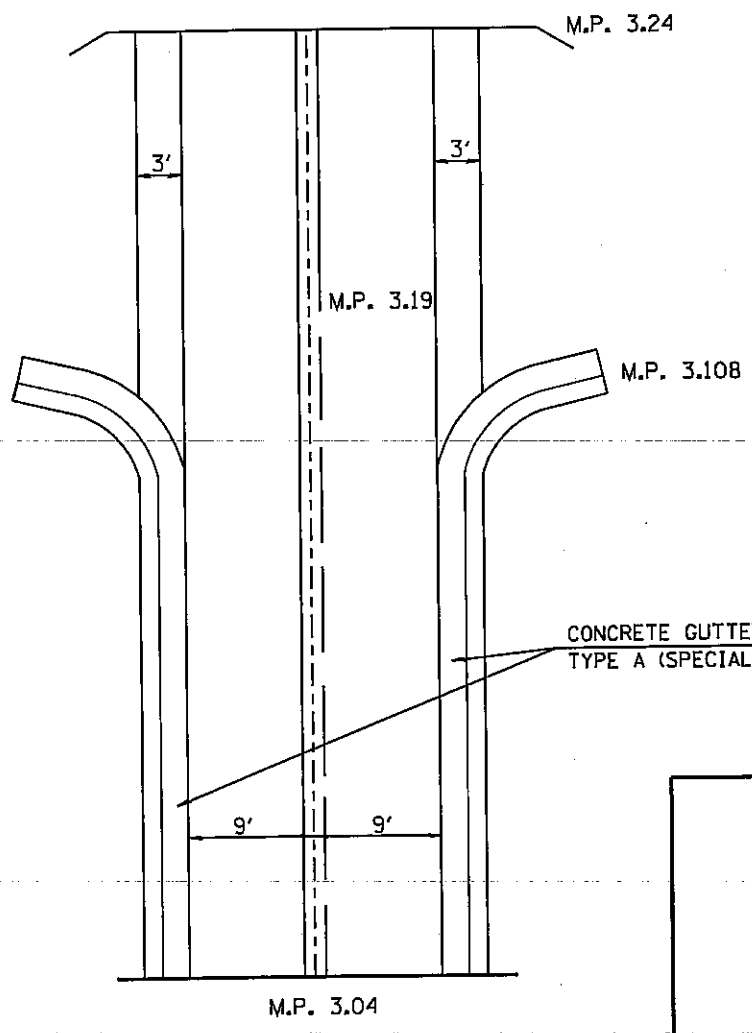

GUTTER
REPLACEMENT
DETAILS
FAS 777
SECTION 52RS-2, 52-I
MADISON COUNTY

DATE
3/31/2005
c:\projects\ed07405\plan\pin07405a.dgn
REF
REF

TOTAL SHEETS	SHEET NO.
31	30
CONTRACT NO.: 76909	

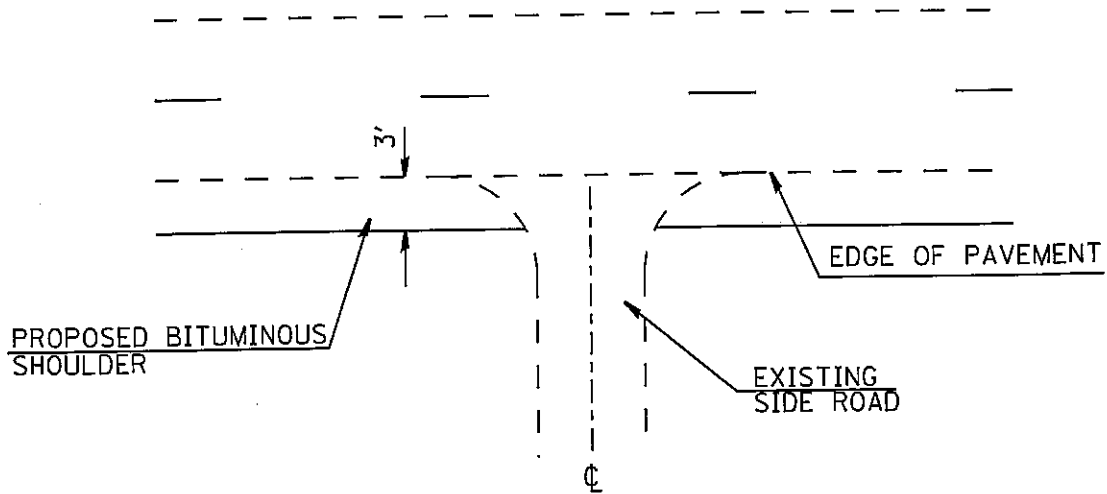

SIDEROAD & PAVED
ENTRANCE DETAIL

GUTTER
REPLACEMENT
DETAILS
FAS 777
SECTION 52RS-2, 52-1
MADISON COUNTY

\$\$\$DATE\$\$\$
3/31/2005
c:\projects\ed07405\plan\pin07405a.dgn
*REF
*REF

PLOT DATE: 3/31/2005

TOTAL SHEETS	SHEET NO.
31	31
CONTRACT NO.: 76909	

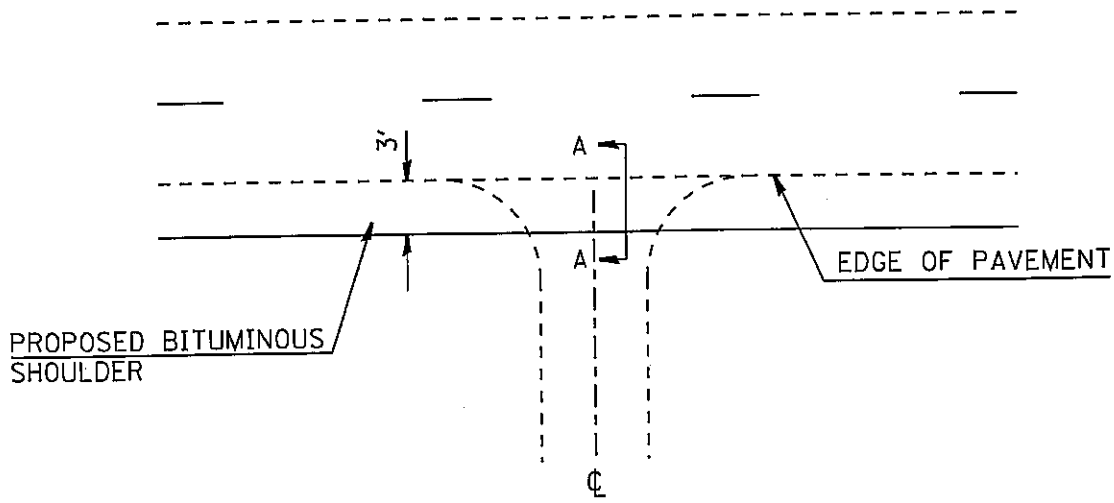

AGGREGATE SIDEROAD
& ENTRANCE DETAIL

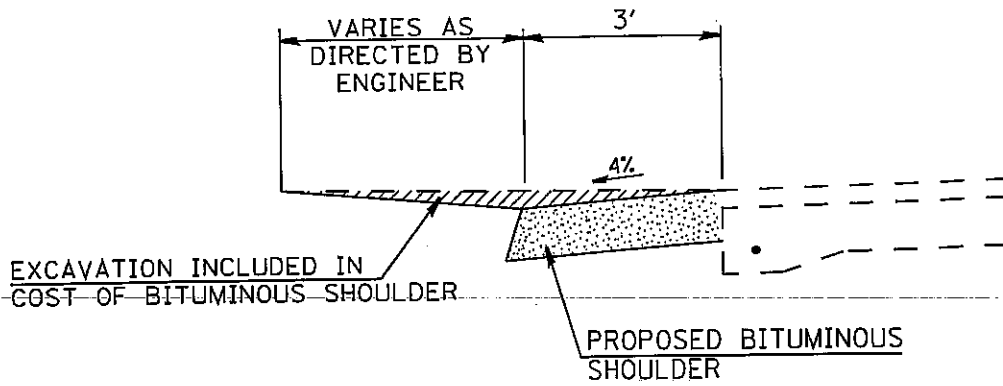

SECTION A-A

AGGREGATE
ENTRANCE DETAIL

FAS 777
SECTION 52RS-2, 52-I
MADISON COUNTY

PLOT DATE: 3/31/2005

DATE: 3/31/2005
 PROJECT: c:\projects\ed07405\plan\pin07405a.dgn
 REF: REF

ILLINOIS DEPARTMENT OF LABOR

PREVAILING WAGES FOR MADISON COUNTY EFFECTIVE JUNE 2005

The Prevailing rates of wages are included in the Contract proposals which are subject to Check Sheet #5 of the Supplemental Specifications and Recurring Special Provisions. The rates have been ascertained and certified by the Illinois Department of Labor for the locality in which the work is to be performed and for each craft or type of work or mechanic needed to execute the work of the Contract. As required by Prevailing Wage Act (820 ILCS 130/0.01, et seq.) and Check Sheet #5 of the Contract, not less than the rates of wages ascertained by the Illinois Department of Labor and as revised during the performance of a Contract shall be paid to all laborers, workers and mechanics performing work under the Contract. Post the scale of wages in a prominent and easily accessible place at the site of work.

If the Illinois Department of Labor revises the prevailing rates of wages to be paid as listed in the specification of rates, the contractor shall post the revised rates of wages and shall pay not less than the revised rates of wages. Current wage rate information shall be obtained by visiting the Illinois Department of Labor web site at <http://www.state.il.us/agency/idol/> or by calling 312-793-2814. It is the responsibility of the contractor to review the rates applicable to the work of the contract at regular intervals in order to insure the timely payment of current rates. Provision of this information to the contractor by means of the Illinois Department of Labor web site satisfies the notification of revisions by the Department to the contractor pursuant to the Act, and the contractor agrees that no additional notice is required. The contractor shall notify each of its subcontractors of the revised rates of wages.

Madison County Prevailing Wage for June 2005

Trade Name Trng	RG	TYP	C	Base	FRMAN	*M-F>8	OSA	OSH	H/W	Pensn	Vac
ASBESTOS ABT-GEN 0.500	NW	ALL		22.250	22.750	1.5	1.5	2.0	4.600	6.300	0.000
ASBESTOS ABT-GEN 0.500	SE	ALL		22.400	22.900	1.5	1.5	2.0	4.750	6.000	0.000
ASBESTOS ABT-MEC 0.000		BLD		24.010	25.010	1.5	1.5	2.0	2.920	4.320	0.000
BOILERMAKER 0.210		BLD		27.000	29.500	1.5	1.5	2.0	7.020	10.21	0.000
BRICK MASON 0.370		BLD		24.970	26.590	1.5	1.5	2.0	4.100	7.400	2.000
CARPENTER 0.350		ALL		29.030	30.530	1.5	1.5	2.0	4.450	3.250	0.000
CEMENT MASON 0.100		ALL		25.450	26.200	1.5	1.5	2.0	4.850	7.250	0.000
CERAMIC TILE FNSHER 0.250		BLD		22.040	0.000	1.5	1.5	2.0	4.800	4.100	0.000
ELECTRIC PWR EQMT OP 0.140	NW	ALL		27.580	33.960	1.5	2.0	2.0	5.150	6.070	0.000
ELECTRIC PWR EQMT OP 0.150	SE	ALL		29.820	35.940	1.5	2.0	2.0	4.120	7.450	0.000
ELECTRIC PWR GRNDMAN 0.090	NW	ALL		18.810	33.960	1.5	2.0	2.0	5.150	4.140	0.000
ELECTRIC PWR GRNDMAN 0.110	SE	ALL		22.260	35.940	1.5	2.0	2.0	3.080	5.570	0.000
ELECTRIC PWR LINEMAN 0.160	NW	ALL		32.020	33.960	1.5	2.0	2.0	5.150	7.040	0.000
ELECTRIC PWR LINEMAN 0.170	SE	ALL		34.280	35.940	1.5	2.0	2.0	4.740	8.570	0.000
ELECTRIC PWR TRK DRV 0.100	NW	ALL		20.520	33.960	1.5	2.0	2.0	5.150	4.520	0.000
ELECTRIC PWR TRK DRV 0.120	SE	ALL		24.340	35.940	1.5	2.0	2.0	3.370	6.080	0.000
ELECTRICIAN 0.200	NW	ALL		29.040	31.040	1.5	1.5	2.0	5.150	6.520	0.000
ELECTRICIAN 0.460	SE	ALL		30.570	32.400	1.5	1.5	2.0	4.740	5.800	0.000
ELECTRONIC SYS TECH 0.460	NW	BLD		22.990	24.490	1.5	1.5	2.0	5.150	3.640	0.000
ELECTRONIC SYS TECH 0.450	SE	BLD		22.610	24.110	1.5	1.5	2.0	2.800	3.180	1.750
ELEVATOR CONSTRUCTOR 0.000		BLD		32.700	36.790	2.0	2.0	2.0	7.275	3.420	1.960
FLOOR LAYER 0.330		BLD		25.220	25.970	1.5	1.5	2.0	4.450	3.250	0.000
GLAZIER 0.160		BLD		28.730	0.000	2.0	2.0	2.0	7.150	5.920	2.300
HT/FROST INSULATOR 0.000		BLD		28.790	29.790	1.5	1.5	2.0	4.250	7.360	0.000
IRON WORKER 0.420		ALL		24.540	26.040	1.5	1.5	2.0	5.710	7.750	0.000

LABORER 0.500	NW ALL	21.750	22.250	1.5	1.5	2.0	4.600	6.300	0.000
LABORER 0.500	SE ALL	21.900	22.400	1.5	1.5	2.0	4.750	6.000	0.000
MACHINIST 0.000	BLD	33.230	34.980	2.0	2.0	2.0	3.200	3.600	2.290
MARBLE FINISHERS 0.250	BLD	22.040	0.000	1.5	1.5	2.0	4.800	4.100	0.000
MARBLE MASON 0.370	BLD	24.970	26.590	1.5	1.5	2.0	4.100	7.400	2.000
MILLWRIGHT 0.350	ALL	29.030	30.530	1.5	1.5	2.0	4.450	3.250	0.000
OPERATING ENGINEER 1.000	ALL 1	24.650	25.780	1.5	1.5	2.0	5.600	9.900	0.000
OPERATING ENGINEER 1.000	ALL 2	23.520	25.780	1.5	1.5	2.0	5.600	9.900	0.000
OPERATING ENGINEER 1.000	ALL 3	19.040	25.780	1.5	1.5	2.0	5.600	9.900	0.000
OPERATING ENGINEER 1.000	ALL 4	19.100	25.780	1.5	1.5	2.0	5.600	9.900	0.000
OPERATING ENGINEER 1.000	ALL 5	18.770	25.780	1.5	1.5	2.0	5.600	9.900	0.000
OPERATING ENGINEER 1.000	ALL 6	25.200	25.780	1.5	1.5	2.0	5.600	9.900	0.000
OPERATING ENGINEER 1.000	ALL 7	25.500	25.780	1.5	1.5	2.0	5.600	9.900	0.000
OPERATING ENGINEER 1.000	ALL 8	25.780	25.780	1.5	1.5	2.0	5.600	9.900	0.000
PAINTER 0.350	BLD	23.800	24.800	1.5	1.5	2.0	3.900	5.150	0.000
PAINTER 0.350	HWY	25.000	26.000	1.5	1.5	2.0	3.900	5.150	0.000
PAINTER OVER 30FT 0.350	BLD	24.800	25.800	1.5	1.5	2.0	3.900	5.150	0.000
PAINTER PWR EQMT 0.350	BLD	24.800	25.800	1.5	1.5	2.0	3.900	5.150	0.000
PAINTER PWR EQMT 0.350	HWY	26.000	27.000	1.5	1.5	2.0	3.900	5.150	0.000
PILEDRIVER 0.350	ALL	29.030	30.530	1.5	1.5	2.0	4.450	3.250	0.000
PIPEFITTER 0.000	N BLD	29.000	30.250	2.0	2.0	2.0	5.350	4.950	0.000
PIPEFITTER 0.400	S BLD	28.000	30.000	1.5	1.5	2.0	5.200	6.840	0.000
PLASTERER 0.250	BLD	25.300	26.300	1.5	1.5	2.0	4.850	6.750	0.000
PLUMBER 0.000	N BLD	29.000	30.250	2.0	2.0	2.0	5.350	4.950	0.000
PLUMBER 0.300	S BLD	29.200	31.700	1.5	1.5	2.0	4.550	4.700	0.000
ROOFER 0.200	BLD	25.250	27.250	1.5	1.5	2.0	5.200	5.300	0.000
SHEETMETAL WORKER 0.120	ALL	26.470	27.720	1.5	1.5	2.0	5.750	4.310	1.580
SPRINKLER FITTER 0.400	BLD	31.080	33.080	2.0	2.0	2.0	5.900	5.850	0.000

TERRAZZO FINISHER 0.000	BLD	30.050	0.000	1.5	1.5	2.0	0.000	0.000	0.000
TERRAZZO MASON 0.000	BLD	29.550	29.850	1.5	1.5	2.0	0.000	3.750	0.000
TRUCK DRIVER 0.000	ALL 1	24.905	0.000	1.5	1.5	2.0	7.000	3.200	0.000
TRUCK DRIVER 0.000	ALL 2	25.305	0.000	1.5	1.5	2.0	7.000	3.200	0.000
TRUCK DRIVER 0.000	ALL 3	25.505	0.000	1.5	1.5	2.0	7.000	3.200	0.000
TRUCK DRIVER 0.000	ALL 4	25.755	0.000	1.5	1.5	2.0	7.000	3.200	0.000
TRUCK DRIVER 0.000	ALL 5	26.505	0.000	1.5	1.5	2.0	7.000	3.200	0.000
TRUCK DRIVER 0.000	O&C 1	19.924	0.000	1.5	1.5	2.0	7.000	3.200	0.000
TRUCK DRIVER 0.000	O&C 2	20.244	0.000	1.5	1.5	2.0	7.000	3.200	0.000
TRUCK DRIVER 0.000	O&C 3	20.404	0.000	1.5	1.5	2.0	7.000	3.200	0.000
TRUCK DRIVER 0.000	O&C 4	20.604	0.000	1.5	1.5	2.0	7.000	3.200	0.000
TRUCK DRIVER 0.000	O&C 5	21.204	0.000	1.5	1.5	2.0	7.000	3.200	0.000

Legend:

M-F>8 (Overtime is required for any hour greater than 8 worked each day, Monday through Friday.)

OSA (Overtime is required for every hour worked on Saturday)

OSH (Overtime is required for every hour worked on Sunday and Holidays)

H/W (Health & Welfare Insurance)

Pensn (Pension)

Vac (Vacation)

Trng (Training)

Explanations

MADISON COUNTY

ELECTRICIANS AND ELECTRIC SYSTEMS TECHNICIAN (NORTHWEST) - Townships of Godfrey, Foster and Wood River, and the western one mile of Moro, Ft. Russell and Edwardsville, south to the north side of Hwy. 66 and west to the Mississippi River. This includes SIU-Edwardsville Dental Facility and Alton Mental Health Hospital.

ELECTRICIANS AND ELECTRIC SYSTEMS TECHNICIAN (SOUTHEAST) - Remainder

of county not covered by ELECTRICIANS AND ELECTRIC SYSTEMS TECHNICIAN (NW) including SIU-Edwardsville Main Campus.

LABORERS (NORTHWEST) - That area northwest of a diagonal line running from the Mississippi River at the intersection of the waterway known as Wood River at Maple Island, northeast through the highway intersection of Illinois Routes 3 and 143 and following the boundary of Alton/East Alton, then preceding northeast to the county line at a point approximately one mile west of Illinois Route 159.

PLUMBERS AND PIPEFITTERS (SOUTH) - That part of the county South of a line between Mitchell and Highland including the town of Glen Carbon.

The following list is considered as those days for which holiday rates of wages for work performed apply: New Years Day, Memorial/Decoration Day, Fourth of July, Labor Day, Veterans Day, Thanksgiving Day, Christmas Day. Generally, any of these holidays which fall on a Sunday is celebrated on the following Monday. This then makes work performed on that Monday payable at the appropriate overtime rate for holiday pay. Common practice in a given local may alter certain days of celebration such as the day after Thanksgiving for Veterans Day. If in doubt, please check with IDOL.

Oil and chip resealing (O&C) means the application of road oils and liquid asphalt to coat an existing road surface, followed by application of aggregate chips or gravel to coated surface, and subsequent rolling of material to seal the surface.

EXPLANATION OF CLASSES

ASBESTOS - GENERAL - removal of asbestos material/mold and hazardous materials from any place in a building, including mechanical systems where those mechanical systems are to be removed. This includes the removal of asbestos materials/mold and hazardous materials from ductwork or pipes in a building when the building is to be demolished at the time or at some close future date.

ASBESTOS - MECHANICAL - removal of asbestos material from mechanical systems, such as pipes, ducts, and boilers, where the mechanical systems are to remain.

CERAMIC TILE FINISHER AND MARBLE FINISHER

The handling, at the building site, of all sand, cement, tile, marble or stone and all other materials that may be used and installed by [a] tile layer or marble mason. In addition, the grouting, cleaning, sealing, and mixing on the job site, and all other work as required in assisting the setter. The term "Ceramic" is used for naming the classification only and is in no way a limitation of the product handled. Ceramic takes into consideration most hard tiles.

COMMUNICATIONS TECHNICIAN

Installing telephones; installing, testing, and troubleshooting voice circuits, installing station sets, including blocks and associated wiring; responsible for cross connects in IDF's (wiring closets); programming PBX switches and associated peripheral equipment; moving,

adding, changing activities for customer owned PBX locations; and, installing voice trunks for various local exchange carriers. All work associated with these system installations will be included except: (1) the installation of protective metallic conduit; and (2) 120 volt AC (or higher) power wiring and associated hardware. With respect to the pulling of telephone wire, said work is not to include work associated with new construction or major renovation (substantially altering existing fixed structural floor plans), but not to include altering free standing office partitions. Nothing in this definition shall be construed as including work historically performed by persons properly classified as wiremen or telecommunication workers.

ELECTRONIC SYSTEMS TECHNICIAN

Installation, service and maintenance of low-voltage systems which utilizes the transmission and/or transference of voice, sound, vision, or digital for commercial, education, security and entertainment purposes for the following: TV monitoring and surveillance, background/foreground music, intercom and telephone interconnect, field programming, inventory control systems, microwave transmission, multi-media, multiplex, radio page, school, intercom and sound burglar alarms and low voltage master clock systems.

Excluded from this classification are energy management systems, life safety systems, supervisory controls and data acquisition systems not intrinsic with the above listed systems, fire alarm systems, nurse call systems and raceways exceeding fifteen feet in length.

TRUCK DRIVER - BUILDING, HEAVY AND HIGHWAY CONSTRUCTION

Class 1. Drivers on 2 axle trucks hauling less than 9 ton. Air compressor and welding machines and brooms, including those pulled by separate units, truck driver helpers, warehouse employees, mechanic helpers, greasers and tiremen, pickup trucks when hauling materials, tools, or workers to and from and on-the-job site, and fork lifts up to 6,000 lb. capacity.

Class 2. Two or three axle trucks hauling more than 9 ton but hauling less than 16 ton. A-frame winch trucks, hydrolift trucks, vector trucks or similar equipment when used for transportation purposes. Fork lifts over 6,000 lb. capacity, winch trucks, four axle combination units, and ticket writers.

Class 3. Two, three or four axle trucks hauling 16 ton or more. Drivers on water pulls, articulated dump trucks, mechanics and working forepersons, and dispatchers. Five axle or more combination units.

Class 4. Low Boy and Oil Distributors.

Class 5. Drivers who require special protective clothing while employed on hazardous waste work.

TRUCK DRIVER - OIL AND CHIP RESEALING ONLY.

This shall encompass laborers, workers and mechanics who drive contractor or subcontractor owned, leased, or hired pickup, dump, service, or oil distributor trucks. The work includes transporting materials and equipment (including but not limited to, oils, aggregate

supplies, parts, machinery and tools) to or from the job site; distributing oil or liquid asphalt and aggregate; stock piling material when in connection with the actual oil and chip contract. The Truck Driver (Oil & Chip Resealing) wage classification does not include supplier delivered materials.

OPERATING ENGINEERS

GROUP I. Cranes, Dragline, Shovels, Skimmer Scoops, Clamshells or Derrick Boats, Pile Drivers, Crane-Type Backhoes, Asphalt Plant Operators, Concrete Plant Operators, Dredges, Asphalt Spreading Machines, All Locomotives, Cable Ways, or Tower Machines, Hoists, Hydraulic Backhoes, Ditching Machines or Backfiller, Cherrypickers, Overhead Cranes, Roller, Steam or Gas, Concrete Pavers, Excavators, Concrete Breakers, Concrete Pumps, Bulk Cement Plants, Cement Pumps, Derrick-Type Drills, Boat Operators, Motor Graders or Pushcats, Scoops or Tournapulls, Bulldozers, Endloaders or Fork Lifts, Power Blade or Elevating Graders, Winch Cats, Boom or Winch Trucks or Boom Tractors, Pipe Wrapping or Painting Machines, Asphalt Plant Engineer, Journeyman Lubricating Engineer, Drills (other than Derrick Type), Mud Jacks, or Well Drilling Machines, Boring Machines or Track Jacks, Mixers, Conveyors (Two), Air Compressors (Two), Water Pumps regardless of size (Two), Welding Machines (Two), Siphons or Jets (Two), Winch Heads or Apparatuses (Two), Light Plants (Two), Waterblasters (two), All Tractors regardless of size (straight tractor only), Fireman on Stationary Boilers, Automatic Elevators, Form Grading Machines, Finishing Machines, Power Sub-Grader or Ribbon Machines, Longitudinal Floats, Distributor Operators on Trucks, Winch Heads or Apparatuses (One), Mobil Track air and heaters (two to five), Heavy Equipment Greaser, Relief Operator, Assistant Master Mechanic and Heavy Duty Mechanic, all Operators (except those listed below).

GROUP II. Assistant Operators.

GROUP III. Air Compressors (One), Water Pumps, regardless of Size (One), Waterblasters (one), Welding Machine (One), Mixers (One Bag), Conveyor (One), Siphon or Jet (One), Light Plant (One), Heater (One), Immobile Track Air (One), and Self Propelled Walk-Behind Rollers.

GROUP IV. Asphalt Spreader Oilers, Fireman on Whirlies and Heavy Equipment Oilers, Truck Cranes, Dredges, Monigans, Large Cranes - (Over 65-ton rated capacity) Concrete Plant Oiler, Blacktop Plant Oiler, and Creter Crane Oiler (when required).

GROUP V. Oiler.

GROUP VI. Master Mechanics, Operators on equipment with Booms, including jibs, 100 feet and over, and less than 150 feet long.

GROUP VII. Operators on equipment with Booms, including jibs, 150 feet and over, and less than 200 feet long.

GROUP VIII. Operators on Equipment with Booms, including jibs, 200 feet and over; Tower Cranes; Whirlie Cranes; and Operator Foreman.

TERRAZZO FINISHER

The handling of all materials used for Mosaic and Terrazzo work

including preparing, mixing by hand, by mixing machine or transporting of pre-mixed materials and distributing with shovel, rake, hoe, or pail, all kinds of concrete foundations necessary for Mosaic and Terrazzo work, all cement terrazzo, magnesite terrazzo, Do-O-Tex terrazzo, epoxy matrix ter-razzo, exposed aggregate, rustic or rough washed for exterior or interior of buildings placed either by machine or by hand, and any other kind of mixture of plastics composed of chips or granules when mixed with cement, rubber, neoprene, vinyl, magnesium chloride or any other resinous or chemical substances used for seamless flooring systems, and all other building materials, all similar materials and all precast terrazzo work on jobs, all scratch coat used for Mosaic and Terrazzo work and sub-bed, tar paper and wire mesh (2x2 etc.) or lath. The rubbing, grinding, cleaning and finishing of same either by hand or by machine or by terrazzo resurfacing equipment on new or existing floors. When necessary finishers shall be allowed to assist the mechanics to spread sand bed, lay tarpaper and wire mesh (2x2 etc.) or lath. The finishing of cement floors where additional aggregate of stone is added by spreading or sprinkling on top of the finished base, and troweled or rolled into the finish and then the surface is ground by grinding machines.

Other Classifications of Work:

For definitions of classifications not otherwise set out, the Department generally has on file such definitions which are available. If a task to be performed is not subject to one of the classifications of pay set out, the Department will upon being contacted state which neighboring county has such a classification and provide such rate, such rate being deemed to exist by reference in this document. If no neighboring county rate applies to the task, the Department shall undertake a special determination, such special determination being then deemed to have existed under this determination. If a project requires these, or any classification not listed, please contact IDOL at 618/993-7271 for wage rates or clarifications.

LANDSCAPING

Landscaping work falls under the existing classifications for laborer, operating engineer and truck driver. The work performed by landscape plantsman and landscape laborer is covered by the existing classification of laborer. The work performed by landscape operators (regardless of equipment used or its size) is covered by the classifications of operating engineer. The work performed by landscape truck drivers (regardless of size of truck driven) is covered by the classifications of truck driver.