

STATE OF ILLINOIS
DEPARTMENT OF TRANSPORTATION

PANEL DIMENSIONS TABLE

PANEL	H	H1	H2	W	T
A	1'-11 ³ / ₄ "	-	-	9'-9"	9 ¹ / ₄ "
B	-	11 ³ / ₄ "	1'-11 ³ / ₄ "	9'-9"	9 ¹ / ₄ "
C	2'-11 ³ / ₄ "	-	-	9'-9"	9 ¹ / ₄ "
D	-	1'-11 ³ / ₄ "	11 ³ / ₄ "	9'-9"	9 ¹ / ₄ "
-	-	-	-	-	-
-	-	-	-	-	-
-	-	-	-	-	-

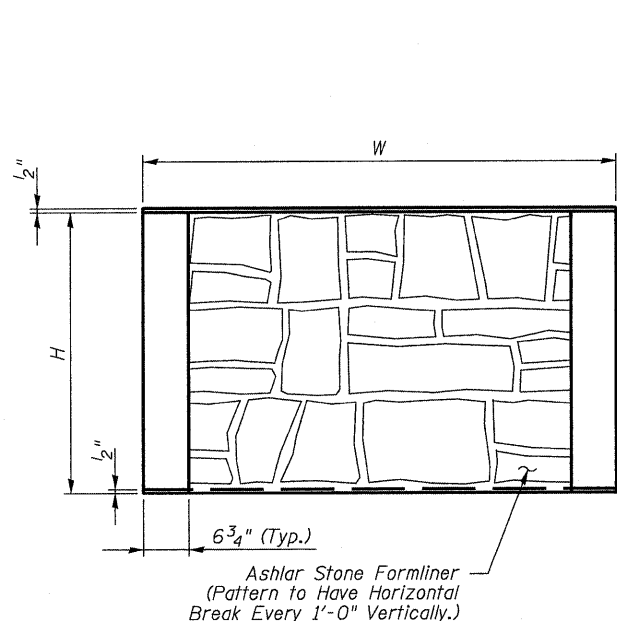

TYPICAL PANEL
ELEVATION

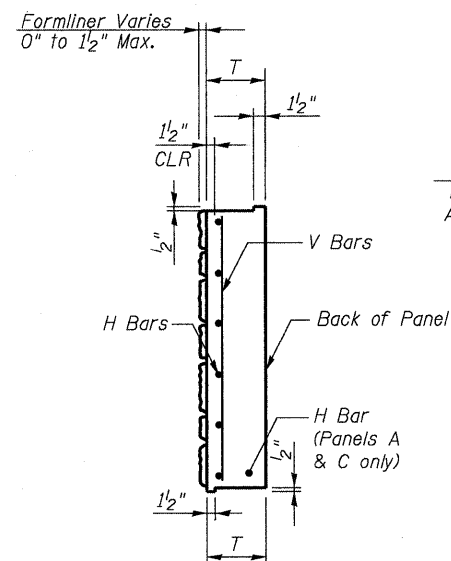

PANEL END VIEW

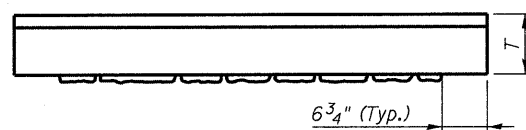

PANEL TOP VIEW

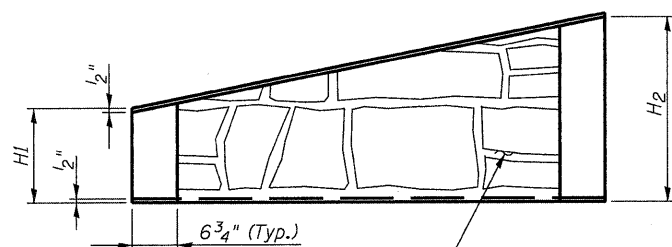

SLOPED PANEL
ELEVATION

(Left end low shown.
Right end low opp. hand.)

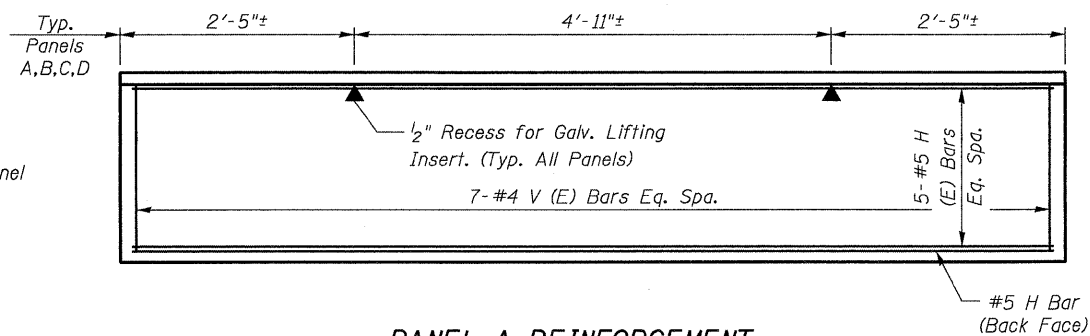

PANEL A REINFORCEMENT

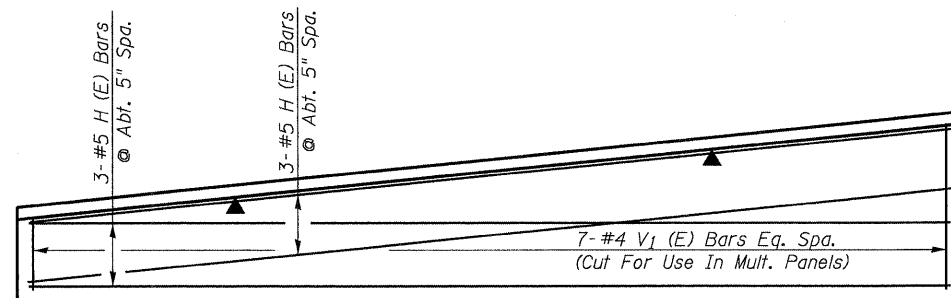

PANEL B REINFORCEMENT

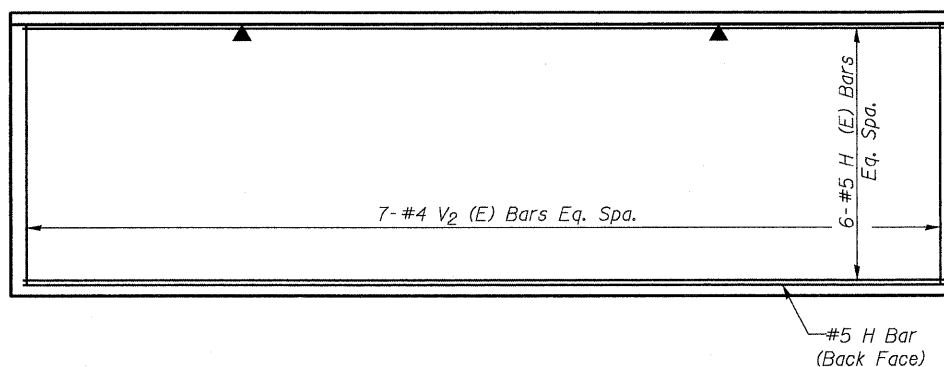

PANEL C REINFORCEMENT

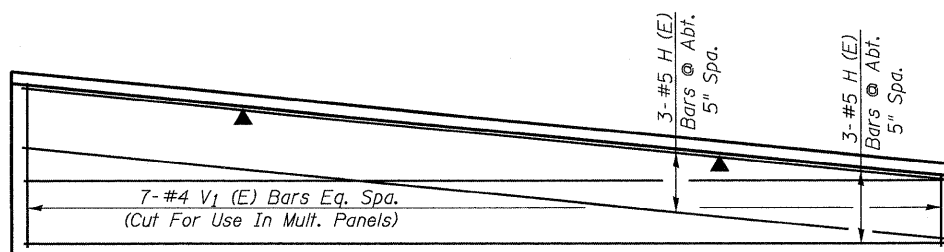

PANEL D REINFORCEMENT

DESIGNED	CTH
CHECKED	DFM
DRAWN	CTH
CHECKED	DFM

PANEL DETAILS
STRUCTURE NO. 071-7006

SHEET NO. 7	F.A.P. RTE.	SECTION	COUNTY	TOTAL SHEETS	SHEET NO.
	742	37R-4	OGLE	867	260
11 SHEETS	CONTRACT NO. 64E17				
FED. ROAD DIST. NO. 7 ILLINOIS FED. AID PROJECT					