

07-30-2021 LETTING ITEM 023

STATE OF ILLINOIS  
DEPARTMENT OF TRANSPORTATION

F.A. RTE.	SECTION	COUNTY	TOTAL SHEETS	SHEET NO.
VAR.	D2 BDS 2022-3	VARIOUS	18	1
ILLINOIS			CONTRACT NO. 64R20	

FOR INDEX OF SHEETS, SEE SHEET NO. 2  
FOR HIGHWAY STANDARDS, SEE SHEET NO. 2

**PROPOSED  
HIGHWAY PLANS**  
PROJECT: STP-88JK(682)  
VARIOUS ROUTES  
SECTION D2 BDS 2022-3  
TYPE OF IMPROVEMENT: BRIDGE DECK SEALING  
VARIOUS COUNTIES  
C-92-087-21

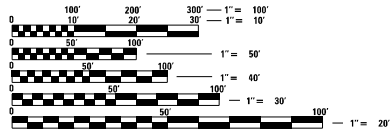

FULL SIZE PLANS HAVE BEEN PREPARED USING STANDARD ENGINEERING SCALES. REDUCED SIZED PLANS WILL NOT CONFORM TO STANDARD SCALES. IN MAKING MEASUREMENTS ON REDUCED PLANS, THE ABOVE SCALES MAY BE USED.

J.U.L.I.E.  
JOINT UTILITY LOCATION INFORMATION FOR EXCAVATORS  
1-800-892-0123  
DR 811

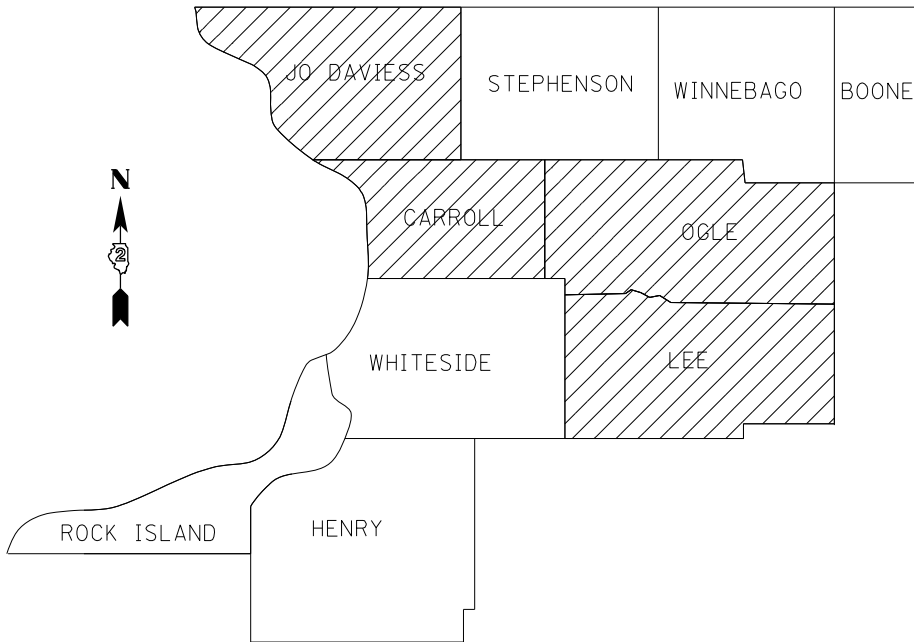

PROJECT ENGINEER: DAVID DOSS (815) 284-5416  
PROJECT MANAGER: MAHMOUD ETEMADI (815) 284-5393  
CONTRACT NO. 64R20

**DISTRICT 2**

D-92-064-21

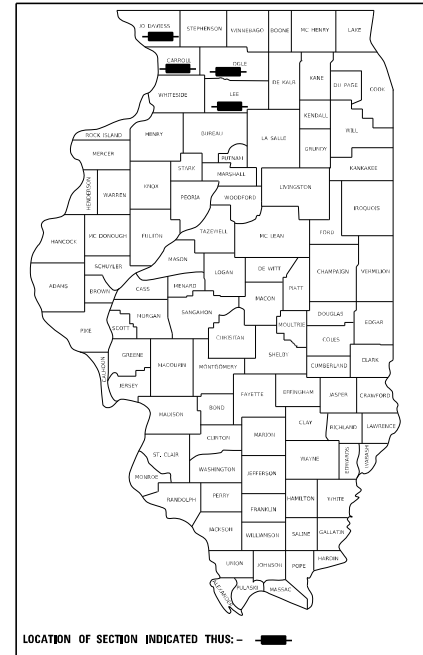

STATE OF ILLINOIS  
DEPARTMENT OF TRANSPORTATION

SUBMITTED 04-21, 20 21  
*Mahmoud Etemadi* REGIONAL ENGINEER

June 25, 2021 *David A. Etkin*  
ENGINEER OF DESIGN AND ENVIRONMENT

June 25, 2021 *James J. Quinn*  
DIRECTOR OF HIGHWAYS PROJECT IMPLEMENTATION

PRINTED BY THE AUTHORITY  
OF THE STATE OF ILLINOIS







# LOCATION MAP CARROLL COUNTY

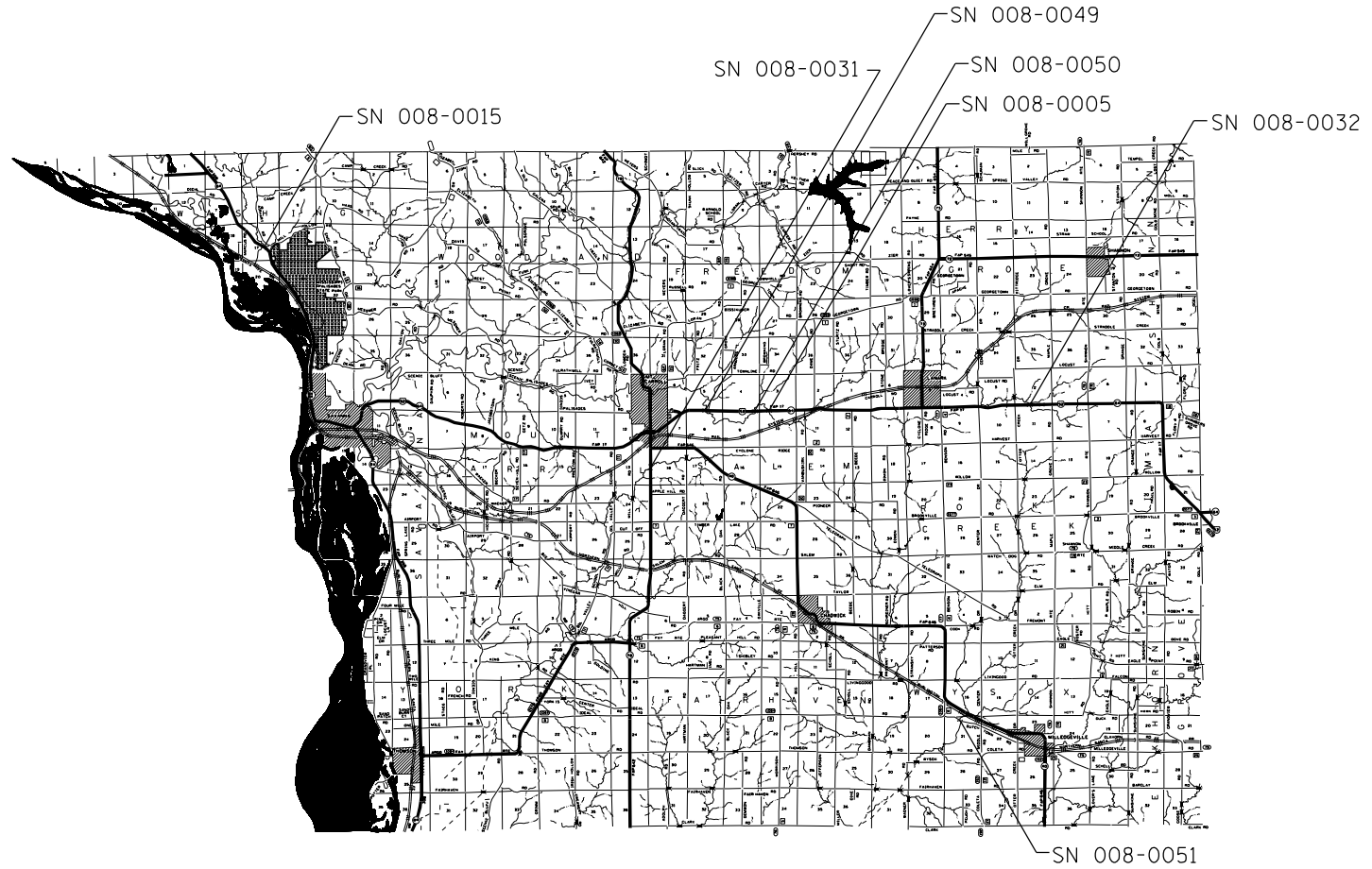

MODEL: D:\work\...  
 FILE: D:\work\...

USER NAME = dksaad	DESIGNED -	REVISED -
	DRAWN -	REVISED -
PLOT SCALE = 40,0000 * 1/4"	CHECKED -	REVISED -
PLOT DATE = Apr-15-2023 11:38:30 AM	DATE -	REVISED -

**STATE OF ILLINOIS**  
**DEPARTMENT OF TRANSPORTATION**

**LOCATION MAP CARROLL COUNTY**

SCALE: \_\_\_\_\_ SHEET \_\_\_\_\_ OF \_\_\_\_\_ SHEETS STA. \_\_\_\_\_ TO STA. \_\_\_\_\_

F.A. SITE	SECTION	COUNTY	TOTAL SHEETS	SHEET NO.
VAR	D2 BDS 2022-3	VARIOUS	18	5
CONTRACT NO. 64R20				
ILLINOIS FED. AID PROJECT				

# LOCATION MAP JO DAVIESS COUNTY

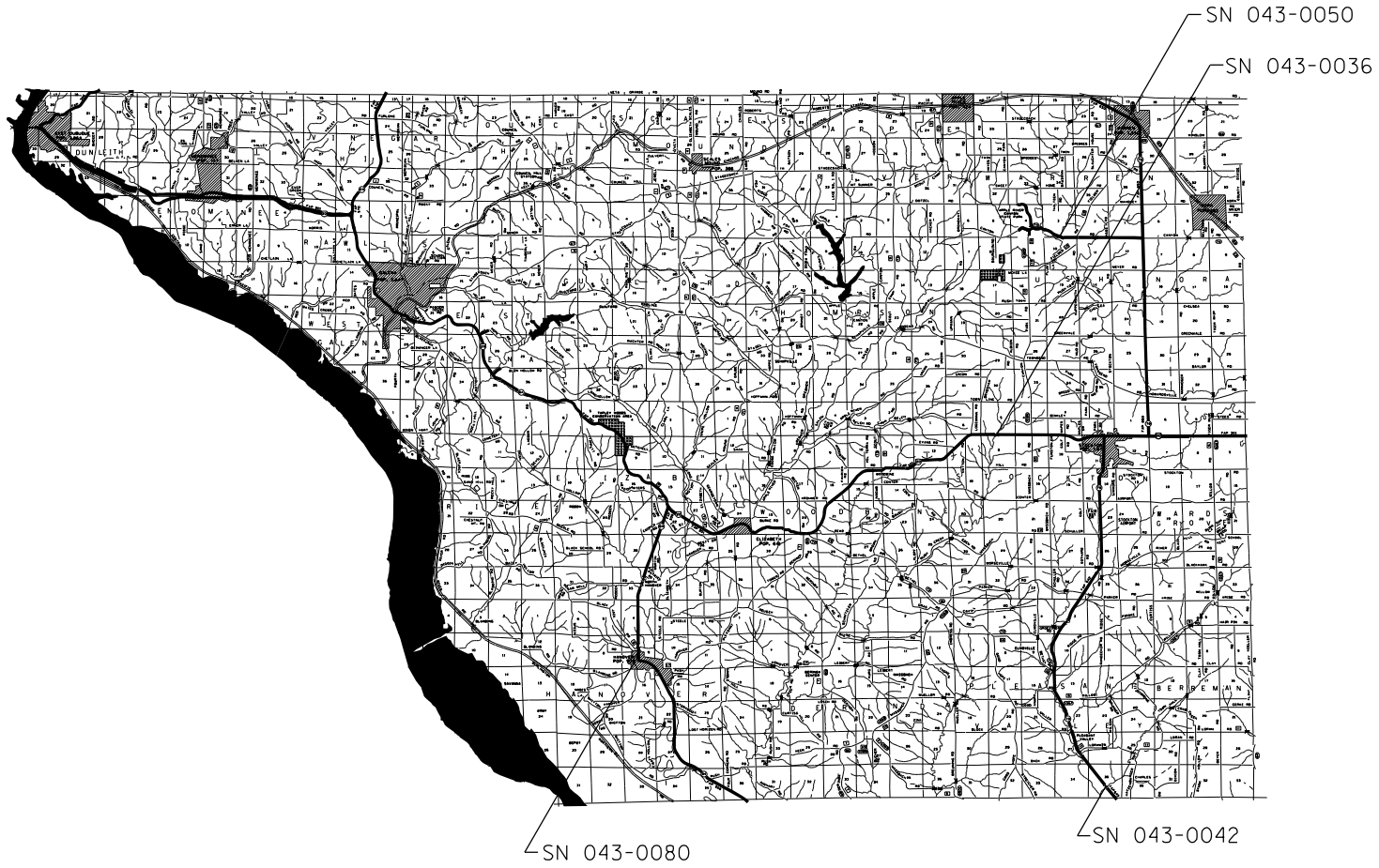

MODEL: D:\dwg\...  
 FILE: D:\dwg\...  
 USER: ...  
 DATE: ...

USER NAME = dksaad	DESIGNED -	REVISED -
	DRAWN -	REVISED -
	CHECKED -	REVISED -
PLOT SCALE = 40,0000 * 1/4"		
PLOT DATE = Apr-15-2023 11:38:41 AM	DATE -	REVISED -

**STATE OF ILLINOIS**  
**DEPARTMENT OF TRANSPORTATION**

**LOCATION MAP JO DAVIESS COUNTY**

SCALE: \_\_\_\_\_ SHEET \_\_\_\_\_ OF \_\_\_\_\_ SHEETS STA. \_\_\_\_\_ TO STA. \_\_\_\_\_

F.A. SITE	SECTION	COUNTY	TOTAL SHEETS	SHEET NO.
VAR	D2 BDS 2022-3	VARIOUS	18	6
CONTRACT NO. 64R20				
ILLINOIS FED. AID PROJECT				

# LOCATION MAP LEE COUNTY

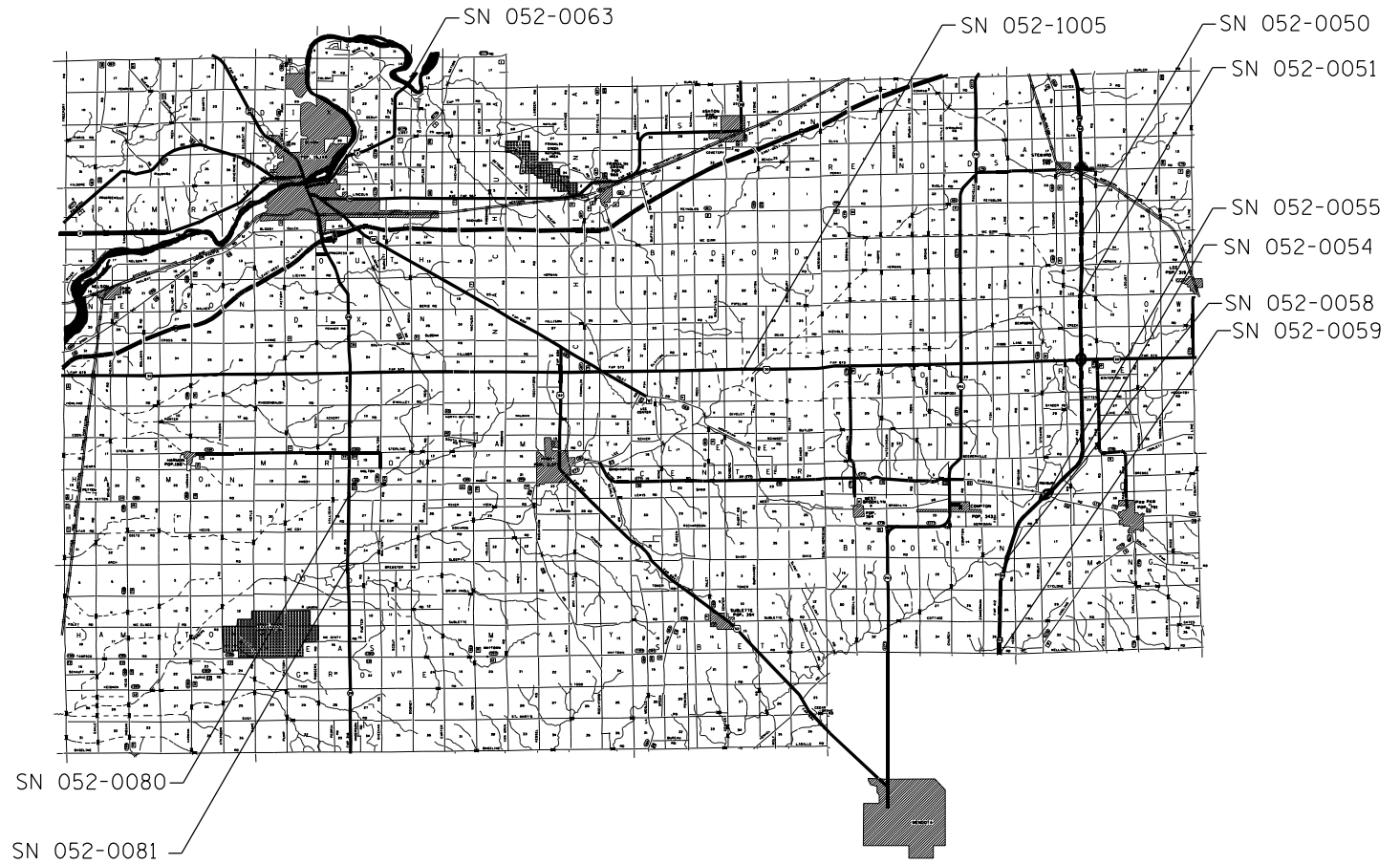

MODEL: D:\work\...  
 FILE: D:\work\...  
 USER: ...  
 DATE: ...

USER NAME = dksand	DESIGNED -	REVISED -
	DRAWN -	REVISED -
PLOT SCALE = 40,0000 * 1/4"	CHECKED -	REVISED -
PLOT DATE = Apr-15-2023 11:38:52 AM	DATE -	REVISED -

**STATE OF ILLINOIS**  
**DEPARTMENT OF TRANSPORTATION**

**LOCATION MAP LEE COUNTY**

SCALE: \_\_\_\_\_ SHEET \_\_\_\_\_ OF \_\_\_\_\_ SHEETS STA. \_\_\_\_\_ TO STA. \_\_\_\_\_

F.A.L. SITE	SECTION	COUNTY	TOTAL SHEETS	SHEET NO.
VAR	D2 BDS 2022-3	VARIOUS	18	7
CONTRACT NO. 64R20				
ILLINOIS FED. AID PROJECT				

# LOCATION MAP OGLE COUNTY

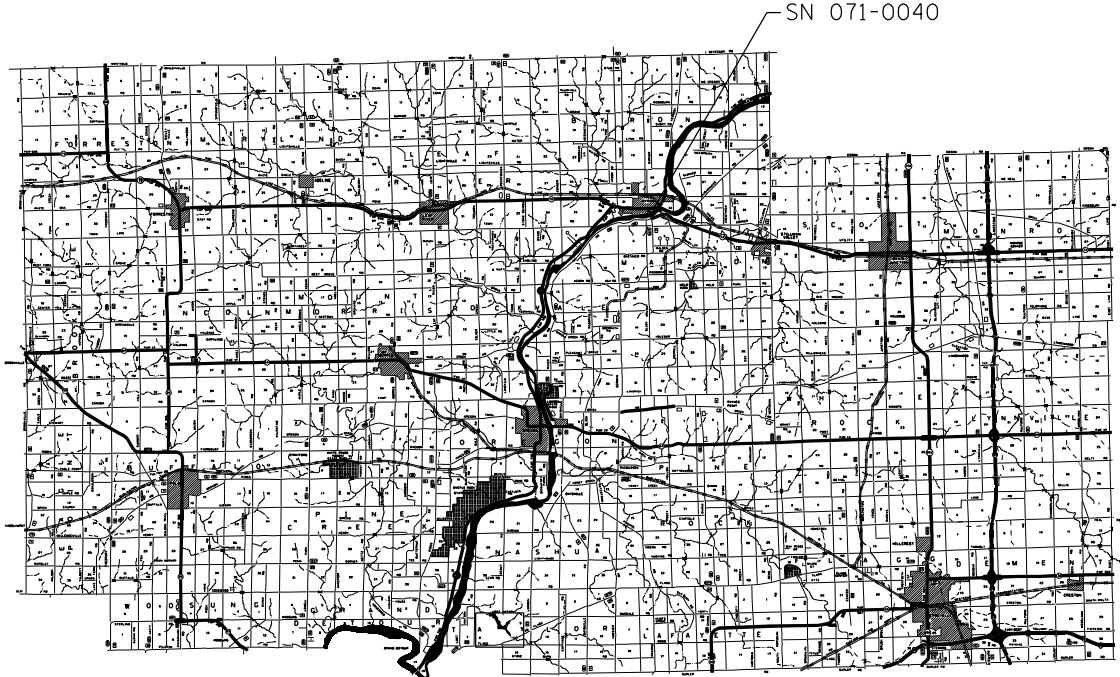

MODEL: D:\work\...  
 FILE: STATE: ILLINOIS\...  
 PROJECT: ...  
 SHEET: ...

USER NAME = dks444	DESIGNED -	REVISED -
	DRAWN -	REVISED -
PLOT SCALE = 40,0000 * 1/4"	CHECKED -	REVISED -
PLOT DATE = Apr-15-2023 11:39:00 AM	DATE -	REVISED -

**STATE OF ILLINOIS**  
**DEPARTMENT OF TRANSPORTATION**

**LOCATION MAP OGLE COUNTY**

SCALE: \_\_\_\_\_ SHEET \_\_\_\_\_ OF \_\_\_\_\_ SHEETS STA. \_\_\_\_\_ TO STA. \_\_\_\_\_

F.A. SITE	SECTION	COUNTY	TOTAL SHEETS	SHEET NO.
VAR	D2 BDS 2022-3	VARIOUS	18	8
CONTRACT NO. 64R20				
ILLINOIS FED. AID PROJECT				



# SEALING DETAILS

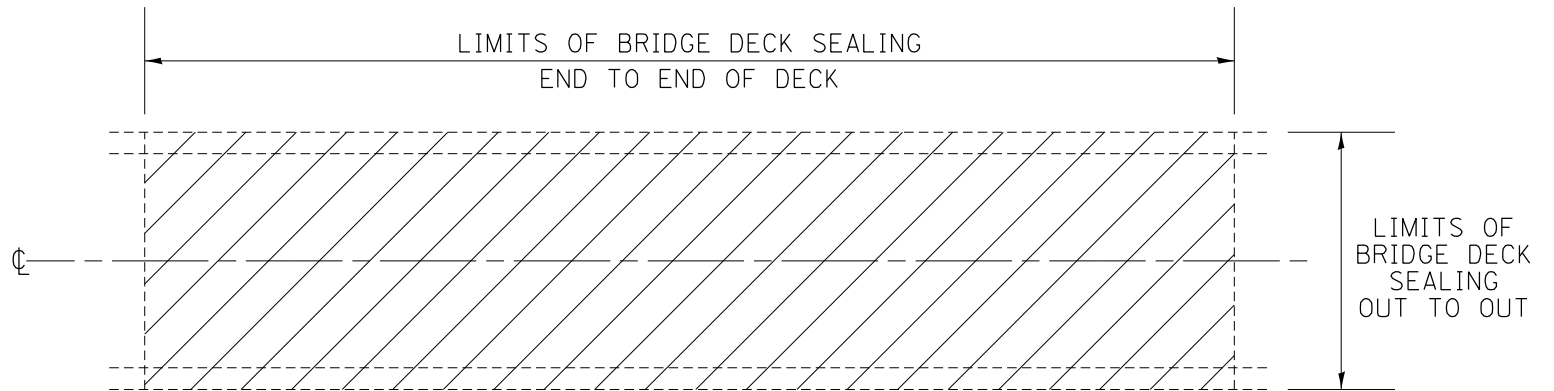

PLAN VIEW

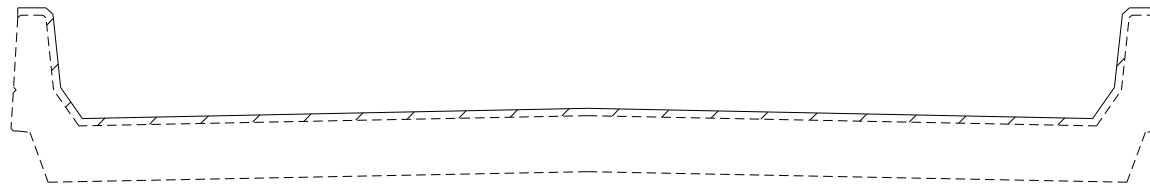

CROSS SECTION WITH PARAPET

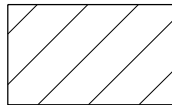

AREA TO BE SEALED

MODEL: D:\work\

USER NAME = dksard	DESIGNED - _____	REVISED - _____
PLOT SCALE = 40.0000 * 1/8"	DRAWN - _____	REVISED - _____
PLOT DATE = Apr-15-2023 11:39:09 AM	CHECKED - _____	REVISED - _____
	DATE - _____	REVISED - _____

**STATE OF ILLINOIS**  
**DEPARTMENT OF TRANSPORTATION**

**SEALING DETAILS**  
 SCALE: \_\_\_\_\_ SHEET \_\_\_\_\_ OF \_\_\_\_\_ SHEETS STA. \_\_\_\_\_ TO STA. \_\_\_\_\_

F.A. SITE	SECTION	COUNTY	TOTAL SHEETS	SHEET NO.
VAR	D2 BDS 2022-3	VARIOUS	18	9
CONTRACT NO. 64R20				
ILLINOIS FED. AID PROJECT				

# WORK ZONE SIGN DETAILS

**ILLINOIS STANDARD G20-I100**

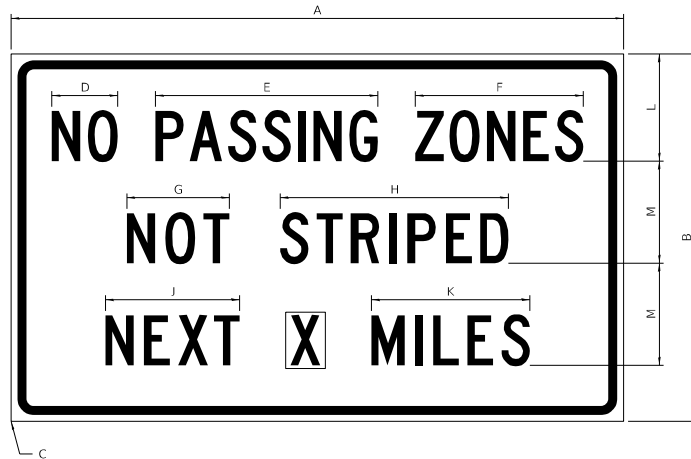

COLOR    LEGEND AND BORDER BACKGROUND    BLACK ORANGE    NON-REFLECTORIZED REFLECTORIZED

SIGN SIZE	DIMENSIONS											
	A	B	C	D	E	F	G	H	J	K	L	M
60 x 36	60.00	36.00	2.25	6.4	21.80	16.40	10.00	22.40	13.20	15.50	10.50	10.00

SIGN SIZE	SERIES BY LINE			MARGIN	BORDER
	1	2	3		
60 x 36	5C	5C	5C	0.625	0.875

Sign not to scale

**GENERAL NOTES**

All work to furnish and install these signs shall be included in the cost of the specified traffic control standards and shall not be paid separately.

All Illinois Standard signs shall conform to the latest edition of the "Illinois Standard Highway Signs Book" in effect on the date of invitation for bids.

Signs shall meet the applicable portions of Sections 701 and 720 of the Standard Specifications.

All dimensions are in inches unless otherwise noted.

**ILLINOIS STANDARD W8-I107**

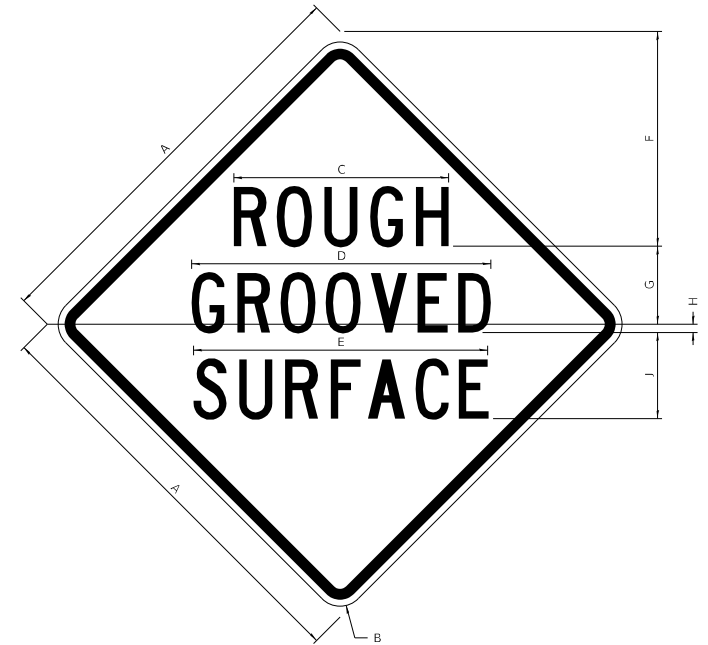

COLOR    LEGEND AND BORDER BACKGROUND    BLACK ORANGE    NON-REFLECTORIZED REFLECTORIZED

SIGN SIZE	DIMENSIONS								
	A	B	C	D	E	F	G	H	J
48 x 48	48.00	3.00	25.00	34.80	34.20	24.94	9.00	1.00	10.00

SIGN SIZE	SERIES BY LINE			MARGIN	BORDER
	1	2	3		
48 x 48	7C	7C	7C	1.250	0.750

Sign not to scale

FILE NAME: p:\cpl\anroom\dtd\illinoisgpc\PIV001	USER NAME: ddesoid	DESIGNED: _____	REVISED: 3-20-16	<b>STATE OF ILLINOIS DEPARTMENT OF TRANSPORTATION</b>	<b>REGION 2 / DISTRICT 2 STANDARD</b>	F.A.L. _____	SECTION _____	COUNTY _____	TOTAL SHEET _____	
	Documents\DOT Offices\Boritt 2\Projects\Operations\DRAWN\bridge Dept. Sealing Contracts 2022\Boritt 2\IllinoisG20-I100-site-cover.dgn	DRAWN: _____	REVISED: 2/20/22			VAR _____	D2 BDS 2022-3	VARIOUS	18	10
	PLOT SCALE = 40.0000 " = 1'	CHECKED: _____	REVISED: _____			CONTRACT NO. 64R20				
	PLOT DATE = Apr-15-2023 11:39:39 AM	DATE: _____	REVISED: _____			ILLINOIS FED. AID PROJECT				

# WORK ZONE SIGN DETAILS

**ILLINOIS STANDARD W12-I102**

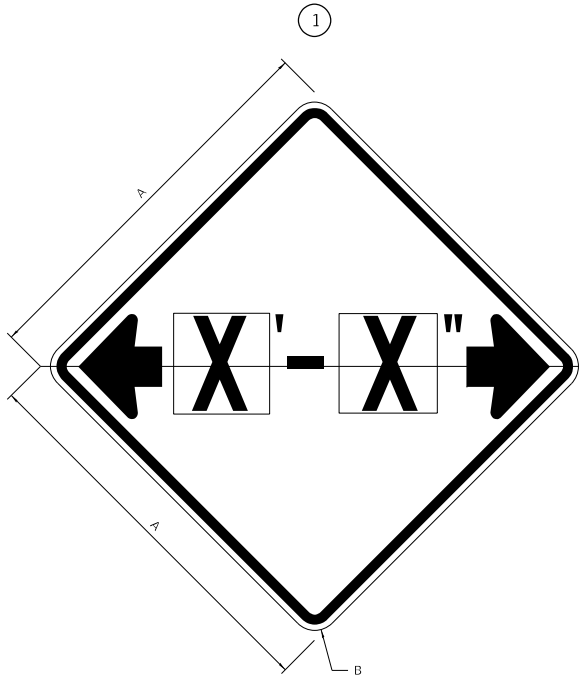

**ILLINOIS STANDARD W12-I103**

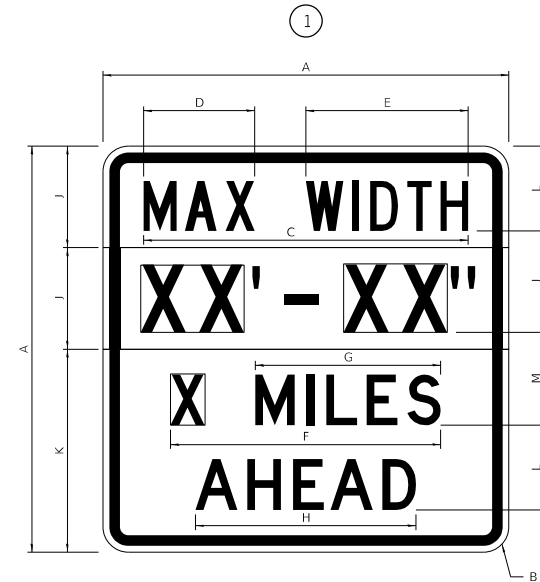

**GENERAL NOTES**

All work to furnish and install these signs shall be included in the cost of the specified traffic control standards and shall not be paid separately.

All Illinois Standard signs shall conform to the latest edition of the "Illinois Standard Highway Signs Book" in effect on the date of invitation for bids.

Signs shall meet the applicable portions of Sections 701 and 720 of the Standard Specifications.

All dimensions are in inches unless otherwise noted.

COLOR LEGEND AND BORDER BACKGROUND BLACK FL ORANGE NON-REFLECTORIZED REFLECTORIZED

SIGN SIZE	DIMENSIONS	
	A	B
48 x 48	48.00	3.00

① Illinois Standard signs W12-I102 and W12-I103 shall be used as described in the special provisions.

SIGN SIZE	SERIES BY LINE	MARGIN	BORDER
	1		
48 x 48	12C	0.750	1.250

Sign not to scale

COLOR LEGEND AND BORDER BACKGROUND (WIDTH) BLACK WHITE FL ORANGE NON-REFLECTORIZED REFLECTORIZED

SIGN SIZE	DIMENSIONS											
	A	B	C	D	E	F	G	H	J	K	L	M
48 x 48	48.00	3.00	38.40	13.20	19.20	32.00	22.00	26.20	12.00	24.00	10.00	11.00

SIGN SIZE	SERIES BY LINE				MARGIN	BORDER
	1	2	3	4		
48 x 48	6C	8D	6D	6D	0.750	1.250

Sign not to scale

XX'-XX" WIDTH AND X MILES ARE VARIABLE TOP AND BOTTOM OF BACKGROUND WHITE

FILE NAME: p:\work\lanroom\dtd\illinois\signs\W12-I102.dwg	USER NAME: ddesard	DESIGNED: _____	REVISED: 3-20-16	<b>STATE OF ILLINOIS DEPARTMENT OF TRANSPORTATION</b>	<b>REGION 2 / DISTRICT 2 STANDARD</b>	SCALE: _____	SHEET 2 OF 4 SHEETS	STA. _____ TO STA. _____	F.A.C. _____	SECTION _____	COUNTY _____	TOTAL SHEETS _____
	DOCUMENTS\DOT Offices\Boritt 2\Projects\Operations\Boritt 2\Drawings\Boritt 2\2016\4820-site-conver.dwg	DRAWN: _____	REVISED: _____			VAR: _____	D2 BDS 2022-3	VARIOUS	18	11		
	PLOT SCALE: = 40.0000 * 1/16"	CHECKED: _____	REVISED: _____			CONTRACT NO. 64R20						
	PLOT DATE: = Apr-15-2023 11:38:26 AM	DATE: _____	REVISED: _____			ILLINOIS FED. AID PROJECT						

# WORK ZONE SIGN DETAILS

## ROAD CLOSED TO OVERSIZED LOADS

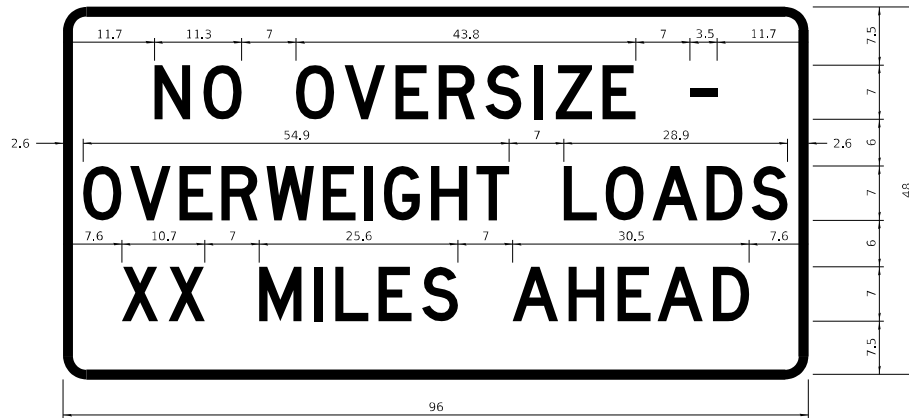

## STOP LINE SIGN FOR TEMPORARY SIGNALS

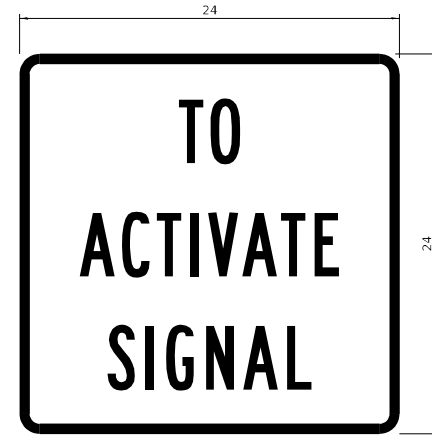

COLOR	LEGEND AND BORDER BACKGROUND	BLACK ORANGE	NON-REFLECTORIZED REFLECTORIZED
-------	------------------------------	--------------	---------------------------------

Permit Loads - Loads Over 13 Feet; 3.0" Radius, 1.3" Border;  
 [NO OVERSIZE -] D; [OVERWEIGHT LOADS] D 85% spacing; [XX MILES AHEAD] D;  
 Table of letter and object lefts.

N	O	O	V	E	R	S	I	Z	E	-
11.7	18.1	30.0	36.2	42.8	48.4	54.4	60.7	63.5	69.5	80.8

O	V	E	R	W	E	I	G	H	T	L	O	A	D	S
2.6	8.6	15.0	20.4	26.2	33.4	38.8	41.3	47.4	53.2	64.5	69.9	75.9	82.9	88.7

X	X	M	I	L	E	S	A	H	E	A	D
7.6	13.6	25.3	32.3	35.1	40.6	46.2	57.9	65.1	71.4	76.6	83.7

Sign not to scale

COLOR	LEGEND AND BORDER BACKGROUND	BLACK WHITE	NON-REFLECTORIZED REFLECTORIZED
-------	------------------------------	-------------	---------------------------------

SIGN SIZE	SERIES BY LINE		
	1	2	3
24 x 24	4C	4C	4C

Sign not to scale

### GENERAL NOTES

All work to furnish and install these signs shall be included in the cost of the specified traffic control standards and shall not be paid separately.

All Illinois Standard signs shall conform to the latest edition of the "Illinois Standard Highway Signs Book" in effect on the date of invitation for bids.

Signs shall meet the applicable portions of Sections 701 and 720 of the Standard Specifications.

All dimensions are in inches unless otherwise noted.

FILE NAME: p:\cpl\anroom\dtd\illinois\gov\PIV\DOT	USER NAME: d\osaid	DESIGNED: -	REVISED: - 3-20-16	<b>STATE OF ILLINOIS DEPARTMENT OF TRANSPORTATION</b>	<b>REGION 2 / DISTRICT 2 STANDARD</b>	F.A.:	SECTION	COUNTY	TOTAL SHEETS	SHEET NO.	
	Documents\DOT Offices\Boritt 2\Projects\Operations	DRAWN: n\bridge Dept. Sealing Contracts 2022	REVISED: Lethal\2020\64R20-site-overload			VAR:	D2 BDS 2022-3	VARIOUS	18	12	
	PLOT SCALE = 40.0000 * 1/16"	CHECKED: -	REVISED: -			CONTRACT NO. 64R20					
	PLOT DATE = Apr-19-2023 11:39:03 AM	DATE: -	REVISED: -			ILLINOIS FED. AID PROJECT					

**ENTRANCE SIGN FOR USE WITH TEMPORARY SIGNALS**

**WORK ZONE SIGN DETAILS**

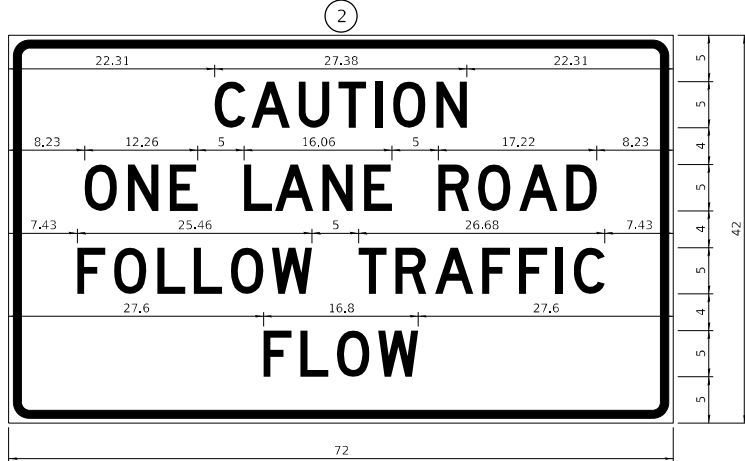

**STAY IN YOUR LANE**

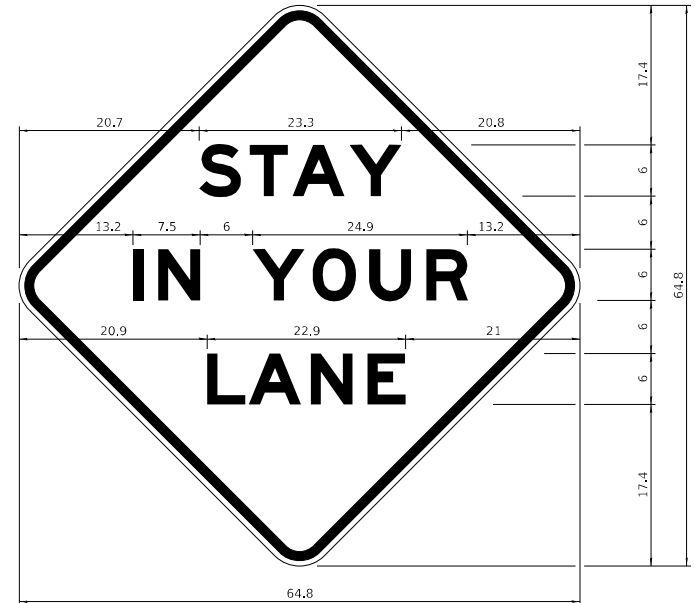

COLOR LEGEND AND BORDER BACKGROUND BLACK ORANGE NON-REFLECTORIZED REFLECTORIZED

2.25" Radius, 0.88" Border, 0.50" Indent;  
[CAUTION] D; [ONE LANE ROAD] D;  
[FOLLOW TRAFFIC] D; [FLOW] D

② This sign shall be installed at entrances located between the temporary signals as shown in the staging plans.

**Table Of Widths And Spaces**

22.31	C	3.36	0.62	A	4.18	0.94	U	3.36	0.94	T	3.04	0.94	I	0.78	1.17	O	3.52	1.17	N	3.36	22.31
-------	---	------	------	---	------	------	---	------	------	---	------	------	---	------	------	---	------	------	---	------	-------

8.23	O	3.51	1.17	N	3.36	1.18	E	3.04
------	---	------	------	---	------	------	---	------

5.00	L	3.05	0.31	A	4.18	0.94	N	3.36	1.17	E	3.05
------	---	------	------	---	------	------	---	------	------	---	------

5.00	R	3.36	0.93	O	3.52	0.94	A	4.18	0.93	D	3.36	8.23
------	---	------	------	---	------	------	---	------	------	---	------	------

7.43	F	3.04	0.94	O	3.52	1.17	L	3.04	0.94	L	3.05	0.94	O	3.51	0.94	W	4.37
------	---	------	------	---	------	------	---	------	------	---	------	------	---	------	------	---	------

5.00	T	3.05	0.94	R	3.36	0.94	A	4.18	0.93	F	3.05	0.94	F	3.04	0.94	I	0.78	1.18	C	3.35	7.43
------	---	------	------	---	------	------	---	------	------	---	------	------	---	------	------	---	------	------	---	------	------

27.60	F	3.05	0.94	L	3.04	0.94	O	3.52	0.93	W	4.38	27.60
-------	---	------	------	---	------	------	---	------	------	---	------	-------

Sign not to scale

**GENERAL NOTES**

All work to furnish and install these signs shall be included in the cost of the specified traffic control standards and shall not be paid separately.

All Illinois Standard signs shall conform to the latest edition of the "Illinois Standard Highway Signs Book" in effect on the date of invitation for bids.

Signs shall meet the applicable portions of Sections 701 and 720 of the Standard Specifications.

All dimensions are in inches unless otherwise noted.

COLOR LEGEND AND BORDER BACKGROUND BLACK ORANGE NON-REFLECTORIZED REFLECTORIZED

48.0" across sides 3.8" Radius, 1.0" Border, 0.6" Indent;  
"STAY" E Mod; "IN YOUR" E Mod; "LANE" E Mod;

**Table of Letter and Object Lefts**

S	T	A	Y
20.7	26.8	31.6	38.0

I	N	Y	O	U	R
13.2	15.9	26.7	33.9	40.5	46.8

L	A	N	E
20.9	25.8	33.1	39.4

Sign not to scale

FILE NAME: p:\cpl\an\m\dot\illinois\p\RD02\	USER NAME: d\osaid	DESIGNED: _____	REVISED: 3-20-16	STATE OF ILLINOIS DEPARTMENT OF TRANSPORTATION	REGION 2 / DISTRICT 2 STANDARD	F.A.L. _____	SECTION _____	COUNTY _____	TOTAL SHEET _____
DOCUMENTS\DOT Offices\Boritt 2\Projects\Operations\	DRAWN: Bridge Des. Sealing Contracts 2022\	REVISED: Letting\2022\64R20-site-coner\sign	VAR _____			D2 BDS 2022-3	VARIOUS	18	13
PLOT SCALE: = 40.0000 " = 1"	CHECKED: _____	REVISED: _____	CONTRACT NO. 64R20						
PLOT DATE: = Apr-19-2023 11:39:41 AM	DATE: _____	REVISED: _____	ILLINOIS FED. AID PROJECT						
SCALE: _____		SHEET 4 OF 4 SHEETS		STA. _____ TO STA. _____		ILLINOIS FED. AID PROJECT			

# TRAFFIC CONTROL FOR TRANSITION AREAS

## CASE 1

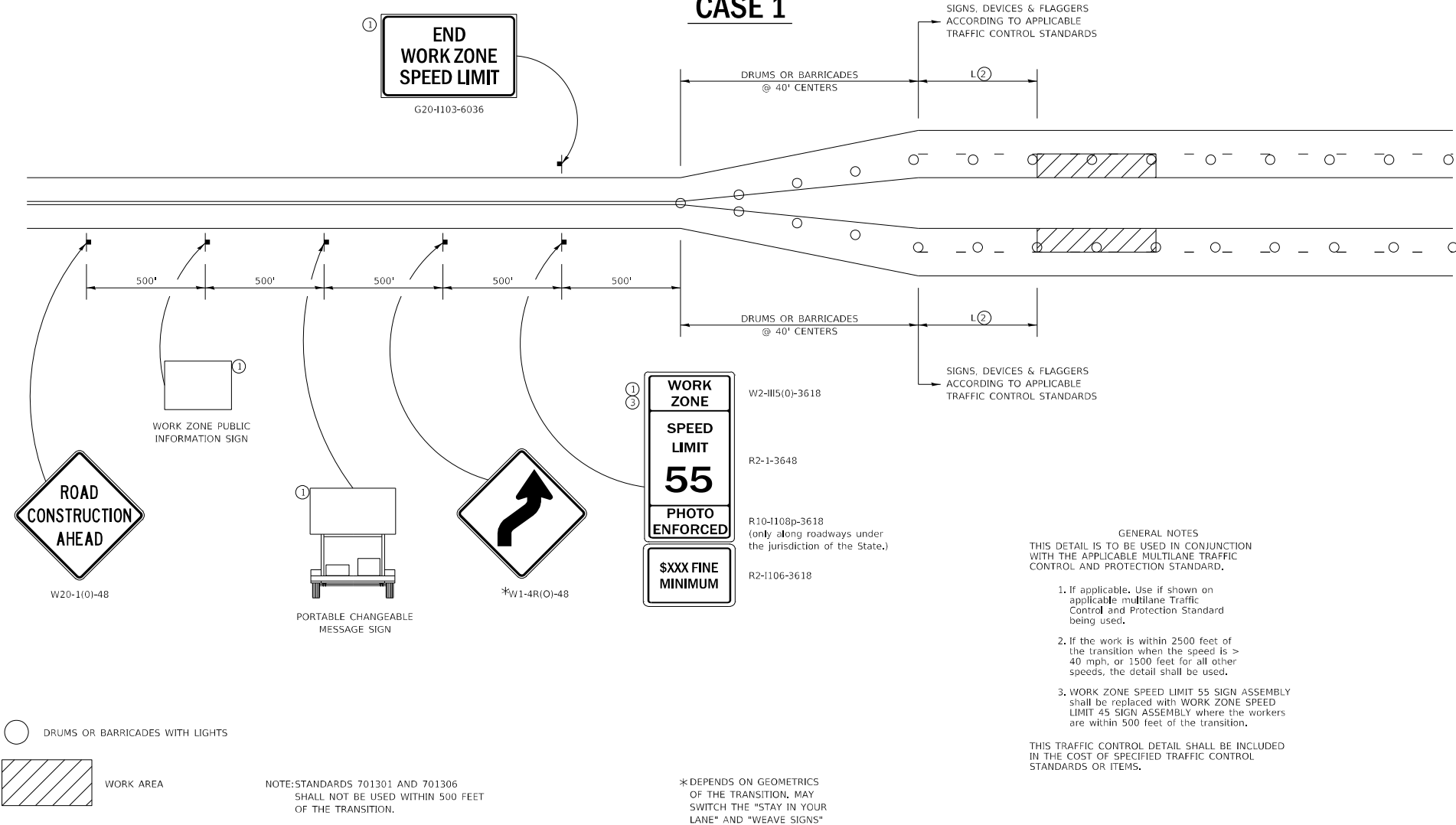

FILE NAME: p:\cpl\anroom\dtd\illinois\gpc\PIV001	USER NAME = dssaid	DESIGNED -	REVISED - 4-20-17	STATE OF ILLINOIS DEPARTMENT OF TRANSPORTATION	REGION 2 / DISTRICT 2 STANDARD	F.A.L. SITE	SECTION	COUNTY	TOTAL SHEET NO.
	DOCUMENTS\DOT Offices\Boritt 2\Projects\Operations\DRAWN\bridge Dept. Sealing Contracts 2022\01-REVISIONS\02 - Letter to 2022-08-20-site-conver.sgn	CHECKED -	REVISED - 8-27-13			VAR	D2 BDS 2022-3	VARIOUS	18
	PLOT SCALE = 40:0000 " = 1' = 1/4"	DATE -	REVISED - 1-16-11		SCALE: _____	SHEET 11	OF 4	SHEETS	STA. _____ TO STA. _____
	PLOT DATE = Apr-19-2023 11:38:49 AM					ILLINOIS FED. AID PROJECT CONTRACT NO. 64R20			

# TRAFFIC CONTROL FOR TRANSITION AREAS

## CASE 2

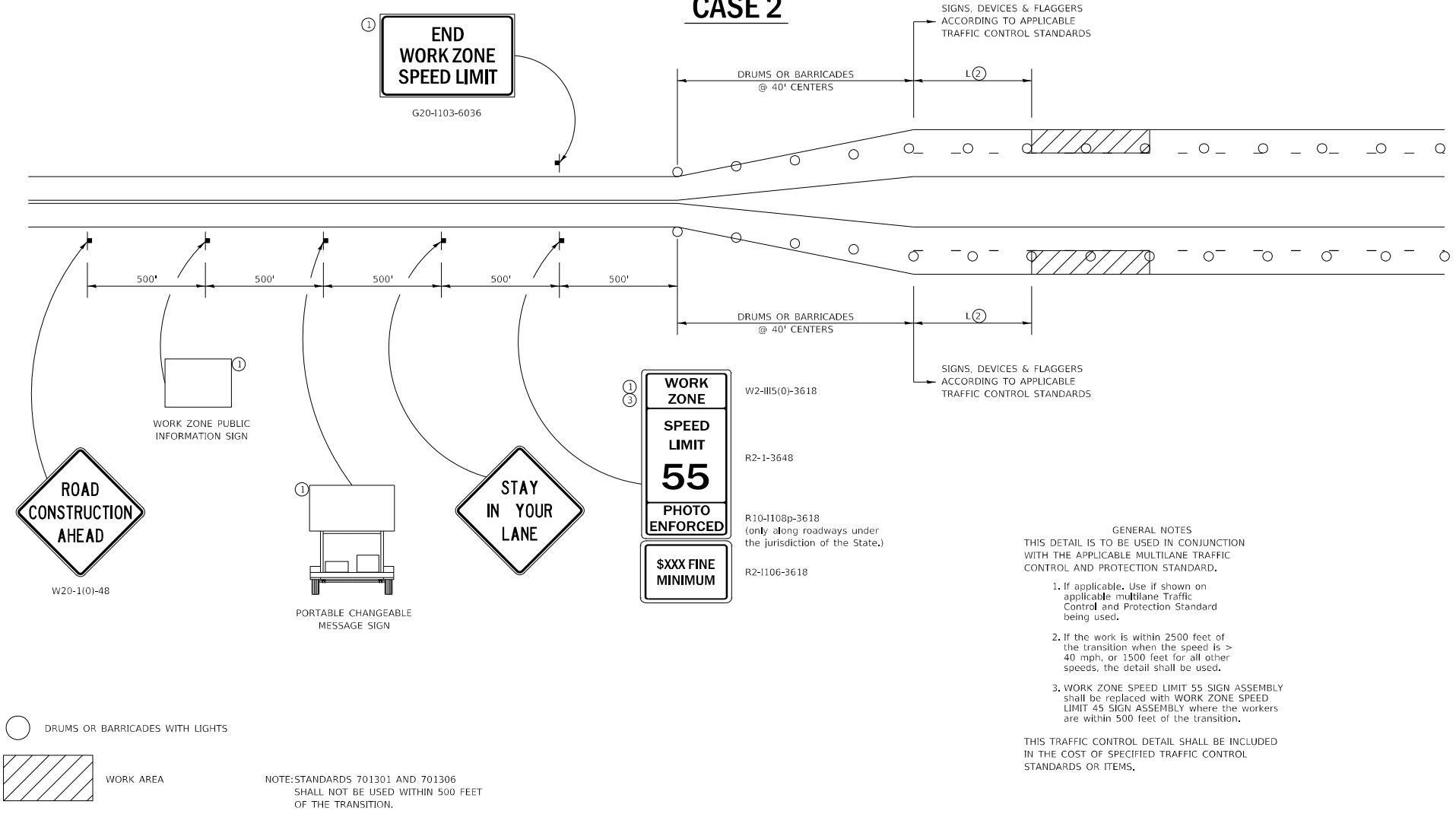

FILE NAME: p:\cpl\anroom\dtd\illinois\p\1103-6036	USER NAME: ddesard	DESIGNED: _____	REVISED: 4-20-17	<b>STATE OF ILLINOIS DEPARTMENT OF TRANSPORTATION</b>	<b>REGION 2 / DISTRICT 2 STANDARD</b>	F.A.L. _____	SECTION _____	COUNTY _____	TOTAL SHEET _____	
DOCUMENTS\DOT Office\Boritt 2\Projects\Operations	DRAWN: Bridge Des. Sealing Contracts 2022	REVIEWED: _____	REVISED: 2-27-18			VAR _____	D2 BDS 2022-3	VARIOUS	18	15
PLOT SCALE: = 40.0000 * 1/16"	CHECKED: _____	REVISED: _____	REVISED: _____			CONTRACT NO. 64R20				
PLOT DATE: = Apr-19-2023 11:39:56 AM	DATE: _____	REVISED: _____	REVISED: _____			ILLINOIS FED. AID PROJECT				

# TRAFFIC CONTROL FOR TRANSITION AREAS

## CASE 3

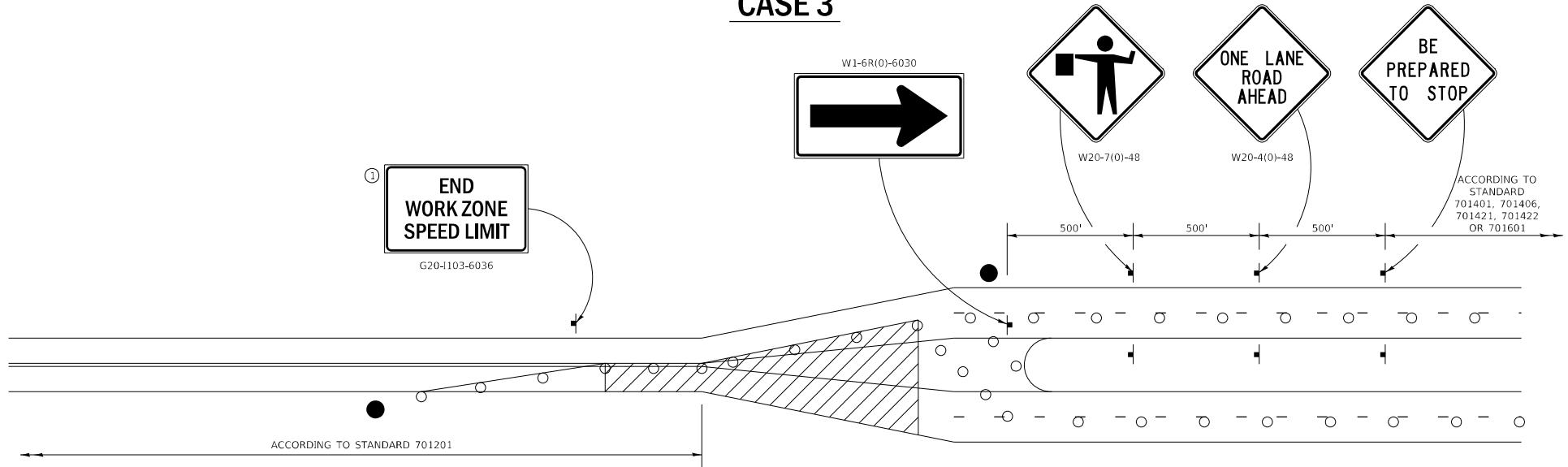

**GENERAL NOTES**  
 THIS DETAIL IS TO BE USED IN CONJUNCTION WITH THE APPLICABLE MULTILANE TRAFFIC CONTROL AND PROTECTION STANDARD.

1. If applicable, Use if shown on applicable multilane Traffic Control and Protection Standard being used.
2. If the work is within 2500 feet of the transition when the speed is > 40 mph, or 1500 feet for all other speeds, the detail shall be used.
3. WORK ZONE SPEED LIMIT 55 SIGN ASSEMBLY shall be replaced with WORK ZONE SPEED LIMIT 45 SIGN ASSEMBLY where the workers are within 500 feet of the transition.

THIS TRAFFIC CONTROL DETAIL SHALL BE INCLUDED IN THE COST OF SPECIFIED TRAFFIC CONTROL STANDARDS OR ITEMS.

- FLAGGER WITH TRAFFIC CONTROL SIGN
- DRUMS OR BARRICADES WITH LIGHTS
- WORK AREA

NOTE: STANDARDS 701301 AND 701306 SHALL NOT BE USED WITHIN 500 FEET OF THE TRANSITION.

FILE NAME: p:\work\rooms\dot\illinois\pwr\DOT	USER NAME: dssaid	DESIGNED: _____	REVISED: 4-20-17	<b>STATE OF ILLINOIS DEPARTMENT OF TRANSPORTATION</b>	<b>REGION 2 / DISTRICT 2 STANDARD</b>	F.A. SITE: _____	SECTION: _____	COUNTY: _____	TOTAL SHEETS: _____	SHEET NO.: _____
Documents\DOT Offices\Boritt 2\Projects\Operations	DRAWN: Bridge Des. Sealing Contracts 2022	CHECKED: _____	REVISED: 8-27-13			VAR: _____	D2 BDS 2022-3	VARIOUS	18	16
PLOT SCALE: = 40:6000 * 1/4"	PLOT DATE: = Apr-19-2023 11:05:05 AM	DATE: _____	REVISED: 3-20-17			CONTRACT NO. 64R20				
						ILLINOIS FED. AID PROJECT				



# TRAFFIC CONTROL FOR TRANSITION AREAS

## CASE 4

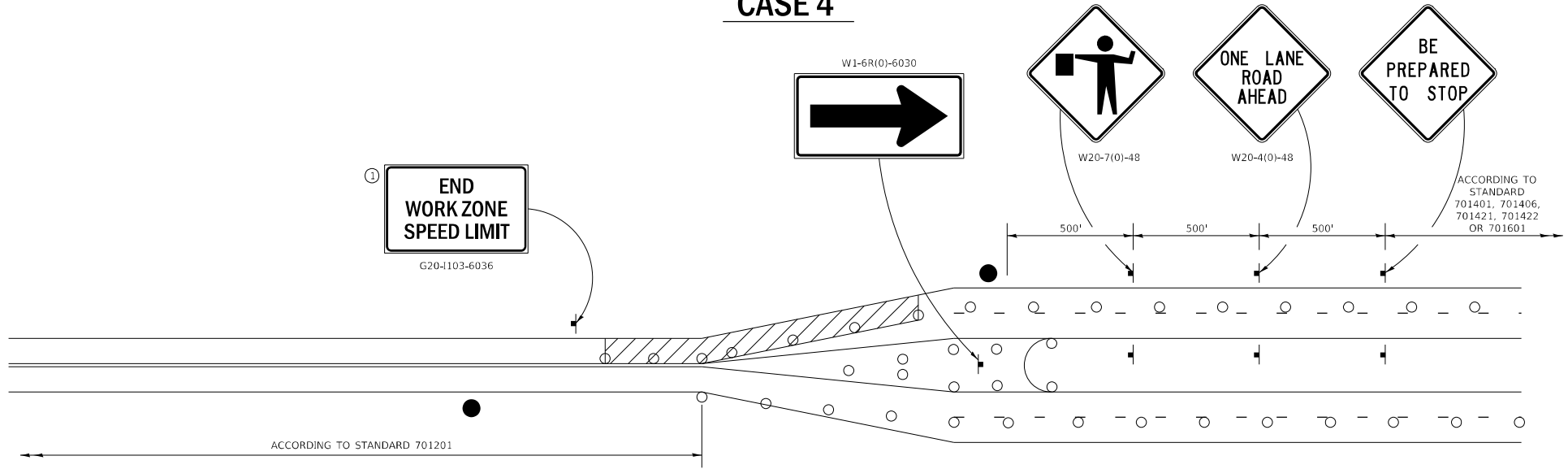

- FLAGGER WITH TRAFFIC CONTROL SIGN
- DRUMS OR BARRICADES WITH LIGHTS
- WORK AREA

NOTE: STANDARDS 701301 AND 701306 SHALL NOT BE USED WITHIN 500 FEET OF THE TRANSITION.

**GENERAL NOTES**  
 THIS DETAIL IS TO BE USED IN CONJUNCTION WITH THE APPLICABLE MULTILANE TRAFFIC CONTROL AND PROTECTION STANDARD.

1. If applicable, Use if shown on applicable multilane Traffic Control and Protection Standard being used.
2. If the work is within 2500 feet of the transition when the speed is > 40 mph, or 1500 feet for all other speeds, the detail shall be used.
3. WORK ZONE SPEED LIMIT 55 SIGN ASSEMBLY shall be replaced with WORK ZONE SPEED LIMIT 45 SIGN ASSEMBLY where the workers are within 500 feet of the transition.





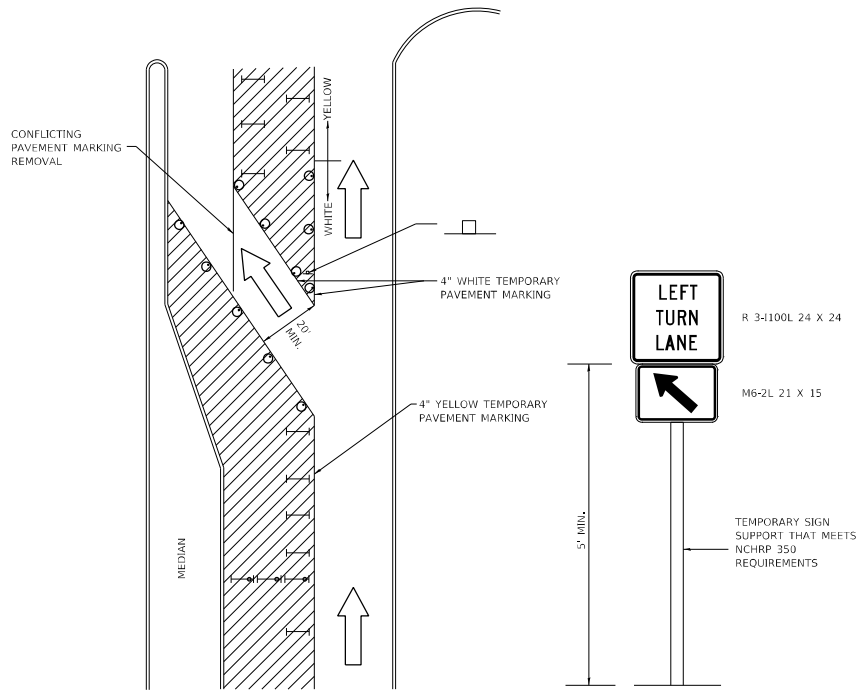

THIS TRAFFIC CONTROL DETAIL SHALL BE INCLUDED IN THE COST OF SPECIFIED TRAFFIC CONTROL STANDARDS OR ITEMS.

FILE NAME: p:\work\inroom\dot\illinois\pwr\DOT	USER NAME: dssaid	DESIGNED: _____	REVISED: 4-20-17	<b>STATE OF ILLINOIS DEPARTMENT OF TRANSPORTATION</b>	<b>REGION 2 / DISTRICT 2 STANDARD</b>	F.A.L.	SECTION	COUNTY	TOTAL SHEETS	SHEET NO.	
DRAWN: Bridge Des. Sealing Contracts 2022	CHECKED: _____	REVISED: 8-27-17	VAR			D2 BDS 2022-3	VARIOUS	18	17	CONTRACT NO. 64R20	
PLOT SCALE: 40,000" = 1'	DATE: _____	REVISED: 3-06-17	SCALE: _____ SHEET 4 OF 4 SHEETS STA. _____ TO STA. _____			ILLINOIS FED. AID PROJECT					

# TRAFFIC CONTROL AND PROTECTION AT TURN BAYS (TO REMAIN OPEN TO TRAFFIC)



## LEGEND

-  WORK AREA
-  LANE OPEN TO TRAFFIC
-  TYPE I OR II BARRICADE OR DRUM WITH FLASHING BURNING LIGHT
-  DRUM OR BARRICADE WITH STEADY BURN LIGHT
-  SIGN (SEE DETAIL)
-  TYPE I OR II CHECK BARRICADE WITH STEADY LIGHT BURN

REVISED - 10-14-11

## GENERAL NOTES

- CONES MAY BE SUBSTITUTED FOR BARRICADES OR DRUMS AT HALF THE SPACING DURING DAY OPERATIONS. CONES SHALL BE A MINIMUM OF 20 IN HEIGHT.
- STEADY BURNING LIGHTS WILL NOT BE REQUIRED ON BARRICADES OR DRUMS FOR DAY OPERATIONS. ALL LIGHTS WILL BE MONODIRECTIONAL.
- TEMPORARY PAVEMENT MARKING SHALL BE PLACED THROUGHOUT THE BARRICADED AREA OF EACH BAY WHERE THE CLOSURE TIME IS GREATER THAN FOURTEEN DAYS.
- THIS APPLICATION ALSO APPLIES WHEN WORK IS BEING PERFORMED IN THE RIGHT LANE(S) AND THE RIGHT TURN BAY IS TO REMAIN OPEN. UNDER THIS CONDITION, "RIGHT TURN LANE" R3-1100 24 X 24 AND M6-2R 21 X 15 SHALL BE USED.
- THESE CONTROLS SHALL SUPPLEMENT MAINLINE TRAFFIC CONTROL FOR LANE CLOSURES. LONGITUDINAL DIMENSIONS MAY BE ADJUSTED TO FIT FIELD CONDITIONS.
- TRAFFIC CONTROL AND PROTECTION AT TURN BAYS (TO REMAIN OPEN TO TRAFFIC) SHALL BE INCLUDED IN THE COST SPECIFIED TRAFFIC CONTROL STANDARDS OR ITEMS.
- ALL DIMENSIONS ARE IN INCHES UNLESS OTHERWISE NOTED.

FILE NAME: \\sdc\share\p04\11\110622\110622.dwg PLOT DATE: 11/14/11 11:28:22 AM

REVISED -		<b>REGION 2 / DISTRICT 2 STANDARD</b>	F.A.L.	SECTION	COUNTY	TOTAL SHEETS
REVISED -			SITE	D2 BDS 2022-3	VARIOUS	18
REVISED -			VAR			18
REVISED -					CONTRACT NO. 64R20	
REVISED -		SCALE: 1/8" = 1'-0"	SHEET	OF	SHEETS	STA. TO STA.
						ILLINOIS FED. AID PROJECT