

If you plan to submit a bid directly to the Department of Transportation

PREQUALIFICATION

Any contractor who desires to become pre-qualified to bid on work advertised by IDOT must submit the properly completed pre-qualification forms to the Bureau of Construction no later than 4:30 p.m. prevailing time twenty-one days prior to the letting of interest. This pre-qualification requirement applies to first time contractors, contractors renewing expired ratings, contractors maintaining continuous pre-qualification or contractors requesting revised ratings. To be eligible to bid, existing pre-qualification ratings must be effective through the date of letting.

REQUESTS FOR AUTHORIZATION TO BID

Contractors wanting to bid on items included in a particular letting must submit the properly completed "Request for Authorization to Bid/or Not For Bid Status" (BDE 124INT) and the ORIGINAL "Affidavit of Availability" (BC 57) to the proper office no later than 4:30 p.m. prevailing time, three (3) days prior to the letting date.

WHO CAN BID ?

Bids will be accepted from only those companies that request and receive written **Authorization to Bid** from IDOT's Central Bureau of Construction.

WHAT CONSTITUTES WRITTEN AUTHORIZATION TO BID?: When a prospective prime bidder submits a "Request for Authorization to Bid/or Not For Bid Status"(BDE 124INT) he/she must indicate at that time which items are being requested For Bidding purposes. Only those items requested For Bidding will be analyzed. After the request has been analyzed, the bidder will be issued a **Proposal Denial and/or Authorization Form**, approved by the Central Bureau of Construction, that indicates which items have been approved For Bidding. If **Authorization to Bid** cannot be approved, the **Proposal Denial and/or Authorization Form** will indicate the reason for denial.

ABOUT AUTHORIZATION TO BID: Firms that have not received an authorization form within a reasonable time of complete and correct original document submittal should contact the department as to status. This is critical in the week before the letting. These documents must be received three days before the letting date. Firms unsure as to authorization status should call the Prequalification Section of the Bureau of Construction at the number listed at the end of these instructions.

ADDENDA AND REVISIONS: It is the contractor's responsibility to determine which, if any, addenda or revisions pertain to any project they may be bidding. Failure to incorporate all relevant addenda or revisions may cause the bid to be declared unacceptable.

Each addendum will be placed with the contract number. Addenda and revisions will also be placed on the Addendum/Revision Checklist and each subscription service subscriber will be notified by e-mail of each addendum and revision issued.

The Internet is the Department's primary way of doing business. The subscription server e-mails are an added courtesy the Department provides. It is suggested that bidders check IDOT's website at <http://www.dot.il.gov/desenv/delett.html> before submitting final bid information.

IDOT IS NOT RESPONSIBLE FOR ANY E-MAIL FAILURES.

Addenda Questions may be directed to the Contracts Office at (217)782-7806 or D&Econtracts@dot.il.gov

Technical Questions about downloading these files may be directed to Tim Garman (217)524-1642 or Timothy.Garman@illinois.gov.

WHAT MUST BE INCLUDED WHEN BIDS ARE SUBMITTED?: Bidders need not return the entire proposal when bids are submitted. That portion of the proposal that must be returned includes the following:

1. All documents from the Proposal Cover Sheet through the Proposal Bid Bond
2. Other special documentation and/or information that may be required by the contract special provisions

All proposal documents, including Proposal Guaranty Checks or Proposal Bid Bonds, should be stapled together to prevent loss when bids are processed by IDOT personnel.

ABOUT SUBMITTING BIDS: It is recommended that bidders deliver bids in person to insure they arrive at the proper location prior to the time specified for the receipt of bids. Any bid received at the place of letting after the time specified will not be accepted.

WHO SHOULD BE CALLED IF ASSISTANCE IS NEEDED?

Questions Regarding	Call
Prequalification and/or Authorization to Bid	217/782-3413
Preparation and submittal of bids	217/782-7806
Mailing of plans and proposals	217/782-7806

ADDENDUMS AND REVISIONS TO THE PROPOSAL FORMS

Planholders should verify that they have received and incorporated any addendum and/or revision prior to submitting their bid. Failure by the bidder to include an addendum or revision could result in a bid being rejected as irregular.

RETURN WITH BID

118

Proposal Submitted By
Name
Address
City

Letting July 31, 2009

BIDDERS NEED NOT RETURN THE ENTIRE PROPOSAL
(See instructions inside front cover)

NOTICE TO PROSPECTIVE BIDDERS

This proposal can be used for bidding purposes by only those companies that request and receive written AUTHORIZATION TO BID from IDOT's Central Bureau of Construction.
(SEE INSTRUCTIONS ON THE INSIDE OF COVER)

**Notice To Bidders,
Specifications,
Proposal, Contract
and Contract Bond**



**Illinois Department
of Transportation**

Springfield, Illinois 62764

Contract No. 89547
TAZEWELL County
Section 09-00023-00-RS (DeLavan)
Route FAS 1464 (Locust Street)
Project ARA-1464(103)
District 4 Construction Funds

PLEASE MARK THE APPROPRIATE BOX BELOW:

- A Bid Bond is included.
- A Cashier's Check or a Certified Check is included

Plans Included
Herein

Prepared by	
Checked by	F

(Printed by authority of the State of Illinois)

INSTRUCTIONS

ABOUT IDOT PROPOSALS: All proposals issued by IDOT are potential bidding proposals. Each proposal contains all Certifications and Affidavits, a Proposal Signature Sheet and a Proposal Bid Bond required for Prime Contractors to submit a bid after written **Authorization to Bid** has been issued by IDOT's Central Bureau of Construction.

WHO CAN BID?: Bids will be accepted from only those companies that request and receive written **Authorization to Bid** from IDOT's Central Bureau of Construction. To request authorization, a potential bidder must complete and submit Part B of the Request for Authorization to Bid/or Not For Bid Status form (BDE 124 INT) and submit an original Affidavit of Availability (BC 57).

WHAT CONSTITUTES WRITTEN AUTHORIZATION TO BID?: When a prospective prime bidder submits a "Request for Proposal Forms and Plans" he/she must indicate at that time which items are being requested For Bidding purposes. Only those items requested For Bidding will be analyzed. After the request has been analyzed, the bidder will be issued a **Proposal Denial and/or Authorization Form**, approved by the Central Bureau of Construction, that indicates which items have been approved For Bidding. If **Authorization to Bid** cannot be approved, the **Proposal Denial and/or Authorization Form** will indicate the reason for denial. If a contractor has requested to bid but has not received a **Proposal Denial and/or Authorization Form**, they should contact the Central Bureau of Construction in advance of the letting date.

WHAT MUST BE INCLUDED WHEN BIDS ARE SUBMITTED?: Bidders need not return the entire proposal when bids are submitted. That portion of the proposal that must be returned includes the following:

1. All documents from the Proposal Cover Sheet through the Proposal Bid Bond
2. Other special documentation and/or information that may be required by the contract special provisions

All proposal documents, including Proposal Guaranty Checks or Proposal Bid Bonds, should be stapled together to prevent loss when bids are processed by IDOT personnel.

ABOUT SUBMITTING BIDS: It is recommended that bidders deliver bids in person to insure they arrive at the proper location prior to the time specified for the receipt of bids. Any bid received at the place of letting after the time specified will not be accepted.

WHO SHOULD BE CALLED IF ASSISTANCE IS NEEDED?

Questions Regarding	Call
Prequalification and/or Authorization to Bid	217/782-3413
Preparation and submittal of bids	217/782-7806
Mailing of CD-ROMS	217/782-7806

RETURN WITH BID



PROPOSAL

TO THE DEPARTMENT OF TRANSPORTATION

1. Proposal of _____

Taxpayer Identification Number (Mandatory) _____

for the improvement identified and advertised for bids in the Invitation for Bids as:

**Contract No. 89547
TAZEWELL County
Section 09-00023-00-RS (DeLavan)
Project ARA-1464(103)
Route FAS 1464 (Locust Street)
District 4 Construction Funds**

Project consists of 0.41 mile of HMA surface removal, HMA resurfacing and thermoplastic pavement marking on FAS Route 1464 (Locust Street) from Ninth Street to Fifth Street in Delavan.

2. The undersigned bidder will furnish all labor, material and equipment to complete the above described project in a good and workmanlike manner as provided in the contract documents provided by the Department of Transportation. This proposal will become part of the contract and the terms and conditions contained in the contract documents shall govern performance and payments.

RETURN WITH BID

3. **ASSURANCE OF EXAMINATION AND INSPECTION/WAIVER.** The undersigned further declares that he/she has carefully examined the proposal, plans, specifications, form of contract and contract bond, and special provisions, and that he/she has inspected in detail the site of the proposed work, and that he/she has familiarized themselves with all of the local conditions affecting the contract and the detailed requirements of construction, and understands that in making this proposal he/she waives all right to plead any misunderstanding regarding the same.

4. **EXECUTION OF CONTRACT AND CONTRACT BOND.** The undersigned further agrees to execute a contract for this work and present the same to the department within fifteen (15) days after the contract has been mailed to him/her. The undersigned further agrees that he/she and his/her surety will execute and present within fifteen (15) days after the contract has been mailed to him/her contract bond satisfactory to and in the form prescribed by the Department of Transportation, in the penal sum of the full amount of the contract, guaranteeing the faithful performance of the work in accordance with the terms of the contract.

5. **PROPOSAL GUARANTY.** Accompanying this proposal is either a bid bond on the department form, executed by a corporate surety company satisfactory to the department, or a proposal guaranty check consisting of a bank cashier's check or a properly certified check for not less than 5 per cent of the amount bid or for the amount specified in the following schedule:

<u>Amount of Bid</u>		<u>Proposal Guaranty</u>	<u>Amount of Bid</u>		<u>Proposal Guaranty</u>
Up to	\$5,000	\$150	\$2,000,000	to	\$3,000,000
\$5,000	to	\$300	\$3,000,000	to	\$5,000,000
\$10,000	to	\$1,000	\$5,000,000	to	\$7,500,000
\$50,000	to	\$3,000	\$7,500,000	to	\$10,000,000
\$100,000	to	\$5,000	\$10,000,000	to	\$15,000,000
\$150,000	to	\$7,500	\$15,000,000	to	\$20,000,000
\$250,000	to	\$12,500	\$20,000,000	to	\$25,000,000
\$500,000	to	\$25,000	\$25,000,000	to	\$30,000,000
\$1,000,000	to	\$50,000	\$30,000,000	to	\$35,000,000
\$1,500,000	to	\$75,000	over		\$35,000,000

Bank cashier's checks or properly certified checks accompanying proposals shall be made payable to the Treasurer, State of Illinois, when the state is awarding authority; the county treasurer, when a county is the awarding authority; or the city, village, or town treasurer, when a city, village, or town is the awarding authority.

If a combination bid is submitted, the proposal guaranties which accompany the individual proposals making up the combination will be considered as also covering the combination bid.

The amount of the proposal guaranty check is _____ \$(_____). If this proposal is accepted and the undersigned shall fail to execute a contract bond as required herein, it is hereby agreed that the amount of the proposal guaranty shall become the property of the State of Illinois, and shall be considered as payment of damages due to delay and other causes suffered by the State because of the failure to execute said contract and contract bond; otherwise, the bid bond shall become void or the proposal guaranty check shall be returned to the undersigned.

Attach Cashier's Check or Certified Check Here

In the event that one proposal guaranty check is intended to cover two or more proposals, the amount must be equal to the sum of the proposal guaranties which would be required for each individual proposal. If the guaranty check is placed in another proposal, state below where it may be found.

The proposal guaranty check will be found in the proposal for:

Item _____

Section No. _____

County _____

Mark the proposal cover sheet as to the type of proposal guaranty submitted.

RETURN WITH BID

6. **COMBINATION BIDS.** The undersigned further agrees that if awarded the contract for the sections contained in the following combination, he/she will perform the work in accordance with the requirements of each individual proposal comprising the combination bid specified in the schedule below, and that the combination bid shall be prorated against each section in proportion to the bid submitted for the same. If an error is found to exist in the gross sum bid for one or more of the individual sections included in a combination, the combination bid shall be corrected as provided in the specifications.

When a combination bid is submitted, the schedule below must be completed in each proposal comprising the combination.

If alternate bids are submitted for one or more of the sections comprising the combination, a combination bid must be submitted for each alternate.

Schedule of Combination Bids

Combination No.	Sections Included in Combination	Combination Bid	
		Dollars	Cents

7. **SCHEDULE OF PRICES.** The undersigned bidder submits herewith, in accordance with the rules and instructions, a schedule of prices for the items of work for which bids are sought. The unit prices bid are in U.S. dollars and cents, and all extensions and summations have been made. The bidder understands that the quantities appearing in the bid schedule are approximate and are provided for the purpose of obtaining a gross sum for the comparison of bids. If there is an error in the extension of the unit prices, the unit prices shall govern. Payment to the contractor awarded the contract will be made only for actual quantities of work performed and accepted or materials furnished according to the contract. The scheduled quantities of work to be done and materials to be furnished may be increased, decreased or omitted as provided elsewhere in the contract.

8. **CERTIFICATE OF AUTHORITY.** The undersigned bidder, if a business organized under the laws of another State, assures the Department that it will furnish a copy of its certificate of authority to do business in the State of Illinois with the return of the executed contract and bond. Failure to furnish the certificate within the time provided for execution of an awarded contract may be cause for cancellation of the award and forfeiture of the proposal guaranty to the State.

STATE JOB # - C-94-135-09
 PPS NBR - 4-10430-0010

ILLINOIS DEPARTMENT OF TRANSPORTATION
 SCHEDULE OF PRICES
 CONTRACT NUMBER - 89547

ECMS002 DTGECM03 ECMR003 PAGE 1
 RUN DATE - 06/10/09
 RUN TIME - 193315

COUNTY NAME	CODE	DIST	SECTION NUMBER	PROJECT NUMBER	ROUTE		
TAZEWELL	179	04	09-00023-00-RS DELAVAN	ARA-1464/103/000	FAS 1464		
ITEM NUMBER	PAY ITEM DESCRIPTION	UNIT OF MEASURE	QUANTITY	UNIT PRICE DOLLARS	CENTS	TOTAL PRICE DOLLARS	CTS
Z0048665	RR PROT LIABILITY INS	L SUM	1.000 X	=			
40600100	BIT MATLS PR CT	GALLON	610.000 X	=			
40600300	AGG PR CT	TON	15.300 X	=			
40600515	LEV BIND HM N30	TON	1.000 X	=			
40603305	HMA SC "C" N30	TON	854.000 X	=			
44000157	HMA SURF REM 2	SQ YD	7,627.000 X	=			
67100100	MOBILIZATION	L SUM	1.000 X	=			
78000200	THPL PVT MK LINE 4	FOOT	4,320.000 X	=			
78000400	THPL PVT MK LINE 6	FOOT	192.000 X	=			
78000650	THPL PVT MK LINE 24	FOOT	32.000 X	=			
TOTAL				\$			

NOTE:
 *** PLEASE TURN PAGE FOR IMPORTANT NOTES ***

FAS 1464
09-00023-00-RS DELAVAN
TAZEWELL

ILLINOIS DEPARTMENT OF TRANSPORTATION
SCHEDULE OF PRICES
CONTRACT NUMBER - 89547

ECMS002 DTGECM03 ECMR003 PAGE 2
RUN DATE - 06/10/09
RUN TIME - 193315

NOTE:

1. EACH PAY ITEM SHOULD HAVE A UNIT PRICE AND A TOTAL PRICE.
2. THE UNIT PRICE SHALL GOVERN IF NO TOTAL PRICE IS SHOWN OR IF THERE IS A DISCREPANCY BETWEEN THE PRODUCT OF THE UNIT PRICE MULTIPLIED BY THE QUANTITY.
3. IF A UNIT PRICE IS OMITTED, THE TOTAL PRICE WILL BE DIVIDED BY THE QUANTITY IN ORDER TO ESTABLISH A UNIT PRICE.
4. A BID MAY BE DECLARED UNACCEPTABLE IF NEITHER A UNIT PRICE NOR A TOTAL PRICE IS SHOWN.

RETURN WITH BID

STATE REQUIRED ETHICAL STANDARDS GOVERNING CONTRACT PROCUREMENT: ASSURANCES, CERTIFICATIONS AND DISCLOSURES

I. GENERAL

A. Article 50 of the Illinois Procurement Code establishes the duty of all State chief procurement officers, State purchasing officers, and their designees to maximize the value of the expenditure of public moneys in procuring goods, services, and contracts for the State of Illinois and to act in a manner that maintains the integrity and public trust of State government. In discharging this duty, they are charged by law to use all available information, reasonable efforts, and reasonable actions to protect, safeguard, and maintain the procurement process of the State of Illinois.

B. In order to comply with the provisions of Article 50 and to carry out the duty established therein, all bidders are to adhere to ethical standards established for the procurement process, and to make such assurances, disclosures and certifications required by law. By execution of the Proposal Signature Sheet, the bidder indicates that each of the mandated assurances has been read and understood, that each certification is made and understood, and that each disclosure requirement has been understood and completed.

C. In addition to all other remedies provided by law, failure to comply with any assurance, failure to make any disclosure or the making of a false certification shall be grounds for termination of the contract and the suspension or debarment of the bidder.

II. ASSURANCES

A. The assurances hereinafter made by the bidder are each a material representation of fact upon which reliance is placed should the Department enter into the contract with the bidder. The Department may terminate the contract if it is later determined that the bidder rendered a false or erroneous assurance, and the surety providing the performance bond shall be responsible for the completion of the contract.

B. Felons

1. The Illinois Procurement Code provides:

Section 50-10. Felons. Unless otherwise provided, no person or business convicted of a felony shall do business with the State of Illinois or any state agency from the date of conviction until 5 years after the date of completion of the sentence for that felony, unless no person held responsible by a prosecutorial office for the facts upon which the conviction was based continues to have any involvement with the business.

2. The bidder assures the Department that the award and execution of the contract would not cause a violation of Section 50-10.

C. Conflicts of Interest

1. The Illinois Procurement Code provides in pertinent part:

Section 50-13. Conflicts of Interest.

(a) Prohibition. It is unlawful for any person holding an elective office in this State, holding a seat in the General Assembly, or appointed to or employed in any of the offices or agencies of state government and who receives compensation for such employment in excess of 60% of the salary of the Governor of the State of Illinois, or who is an officer or employee of the Capital Development Board or the Illinois Toll Highway Authority, or who is the spouse or minor child of any such person to have or acquire any contract, or any direct pecuniary interest in any contract therein, whether for stationery, printing, paper, or any services, materials, or supplies, that will be wholly or partially satisfied by the payment of funds appropriated by the General Assembly of the State of Illinois or in any contract of the Capital Development Board or the Illinois Toll Highway authority.

(b) Interests. It is unlawful for any firm, partnership, association or corporation, in which any person listed in subsection (a) is entitled to receive (i) more than 7 1/2% of the total distributable income or (ii) an amount in excess of the salary of the Governor, to have or acquire any such contract or direct pecuniary interest therein.

(c) Combined interests. It is unlawful for any firm, partnership, association, or corporation, in which any person listed in subsection (a) together with his or her spouse or minor children is entitled to receive (i) more than 15%, in the aggregate, of the total distributable income or (ii) an amount in excess of 2 times the salary of the Governor, to have or acquire any such contract or direct pecuniary interest therein.

(d) Securities. Nothing in this Section invalidates the provisions of any bond or other security previously offered or to be offered for sale or sold by or for the State of Illinois.

(e) Prior interests. This Section does not affect the validity of any contract made between the State and an officer or employee of the State or member of the General Assembly, his or her spouse, minor child or any combination of those persons if that contract was in existence before his or her election or employment as an officer, member, or employee. The contract is voidable, however, if it cannot be completed within 365 days after the officer, member, or employee takes office or is employed.

The current salary of the Governor is \$177,412.00. Sixty percent of the salary is \$106,447.20.

RETURN WITH BID

2. The bidder assures the Department that the award and execution of the contract would not cause a violation of Section 50-13, or that an effective exemption has been issued by the Board of Ethics to any individual subject to the Section 50-13 prohibitions pursuant to the provisions of Section 50-20 of the Code and Executive Order Number 3 (1998). Information concerning the exemption process is available from the Department upon request.

D. Negotiations

1. The Illinois Procurement Code provides in pertinent part:

Section 50-15. Negotiations.

(a) It is unlawful for any person employed in or on a continual contractual relationship with any of the offices or agencies of State government to participate in contract negotiations on behalf of that office or agency with any firm, partnership, association, or corporation with whom that person has a contract for future employment or is negotiating concerning possible future employment.

2. The bidder assures the Department that the award and execution of the contract would not cause a violation of Section 50-15, and that the bidder has no knowledge of any facts relevant to the kinds of acts prohibited therein.

E. Inducements

1. The Illinois Procurement Code provides:

Section 50-25. Inducement. Any person who offers or pays any money or other valuable thing to any person to induce him or her not to bid for a State contract or as recompense for not having bid on a State contract is guilty of a Class 4 felony. Any person who accepts any money or other valuable thing for not bidding for a State contract or who withholds a bid in consideration of the promise for the payment of money or other valuable thing is guilty of a Class 4 felony.

2. The bidder assures the Department that the award and execution of the contract would not cause a violation of Section 50-25, and that the bidder has no knowledge of any facts relevant to the kinds of acts prohibited therein.

F. Revolving Door Prohibition

1. The Illinois Procurement Code provides:

Section 50-30. Revolving door prohibition. Chief procurement officers, associate procurement officers, State purchasing officers, their designees whose principal duties are directly related to State procurement, and executive officers confirmed by the Senate are expressly prohibited for a period of 2 years after terminating an affected position from engaging in any procurement activity relating to the State agency most recently employing them in an affected position for a period of at least 6 months. The prohibition includes, but is not limited to: lobbying the procurement process; specifying; bidding; proposing bid, proposal, or contract documents; on their own behalf or on behalf of any firm, partnership, association, or corporation. This Section applies only to persons who terminate an affected position on or after January 15, 1999.

2. The bidder assures the Department that the award and execution of the contract would not cause a violation of Section 50-30, and that the bidder has no knowledge of any facts relevant to the kinds of acts prohibited therein.

G. Reporting Anticompetitive Practices

1. The Illinois Procurement Code provides:

Section 50-40. Reporting anticompetitive practices. When, for any reason, any vendor, bidder, contractor, chief procurement officer, State purchasing officer, designee, elected official, or State employee suspects collusion or other anticompetitive practice among any bidders, offerors, contractors, proposers, or employees of the State, a notice of the relevant facts shall be transmitted to the Attorney General and the chief procurement officer.

2. The bidder assures the Department that it has not failed to report any relevant facts concerning the practices addressed in Section 50-40 which may involve the contract for which the bid is submitted.

H. Confidentiality

1. The Illinois Procurement Code provides:

Section 50-45. Confidentiality. Any chief procurement officer, State purchasing officer, designee, or executive officer who willfully uses or allows the use of specifications, competitive bid documents, proprietary competitive information, proposals, contracts, or selection information to compromise the fairness or integrity of the procurement, bidding, or contract process shall be subject to immediate dismissal, regardless of the Personnel code, any contract, or any collective bargaining agreement, and may in addition be subject to criminal prosecution.

2. The bidder assures the Department that it has no knowledge of any fact relevant to the practices addressed in Section 50-45 which may involve the contract for which the bid is submitted.

RETURN WITH BID

I. Insider Information

1. The Illinois Procurement Act provides:

Section 50-50. Insider information. It is unlawful for any current or former elected or appointed State official or State employee to knowingly use confidential information available only by virtue of that office or employment for actual or anticipated gain for themselves or another person.

2. The bidder assures the Department that it has no knowledge of any facts relevant to the practices addressed in Section 50-50 which may involve the contract for which the bid is submitted.

III. CERTIFICATIONS

A. The certifications hereinafter made by the bidder are each a material representation of fact upon which reliance is placed should the Department enter into the contract with the bidder. The Department may terminate the contract if it is later determined that the bidder rendered a false or erroneous certification, and the surety providing the performance bond shall be responsible for completion of the contract.

B. Bribery

1. The Illinois Procurement Code provides:

Section 50-5. Bribery.

- (a) Prohibition. No person or business shall be awarded a contract or subcontract under this Code who:

- (1) has been convicted under the laws of Illinois or any other state of bribery or attempting to bribe an officer or employee of the State of Illinois or any other state in that officer's or employee's official capacity; or

- (2) has made an admission of guilt of that conduct that is a matter of record but has not been prosecuted for that conduct.

- (b) Businesses. No business shall be barred from contracting with any unit of State or local government as a result of a conviction under this Section of any employee or agent of the business if the employee or agent is no longer employed by the business and:

- (1) the business has been finally adjudicated not guilty; or

- (2) the business demonstrates to the governmental entity with which it seeks to contract, and that entity finds that the commission of the offense was not authorized, requested, commanded, or performed by a director, officer, or high managerial agent on behalf of the business as provided in paragraph (2) of subsection (a) of Section 5-4 of the Criminal Code of 1961.

- (c) Conduct on behalf of business. For purposes of this Section, when an official, agent, or employee of a business committed the bribery or attempted bribery on behalf of the business and in accordance with the direction or authorization of a responsible official of the business, the business shall be chargeable with the conduct.

- (d) Certification. Every bid submitted to and contract executed by the State shall contain a certification by the contractor that the contractor is not barred from being awarded a contract or subcontract under this Section. A contractor who makes a false statement, material to the certification, commits a Class 3 felony.

2. The bidder certifies that it is not barred from being awarded a contract under Section 50.5.

C. Educational Loan

1. Section 3 of the Educational Loan Default Act provides:

§ 3. No State agency shall contract with an individual for goods or services if that individual is in default, as defined in Section 2 of this Act, on an educational loan. Any contract used by any State agency shall include a statement certifying that the individual is not in default on an educational loan as provided in this Section.

2. The bidder, if an individual as opposed to a corporation, partnership or other form of business organization, certifies that the bidder is not in default on an educational loan as provided in Section 3 of the Act.

D. Bid-Rigging/Bid Rotating

1. Section 33E-11 of the Criminal Code of 1961 provides:

§ 33E-11. (a) Every bid submitted to and public contract executed pursuant to such bid by the State or a unit of local government shall contain a certification by the prime contractor that the prime contractor is not barred from contracting with any unit of State or local government as a result of a violation of either Section 33E-3 or 33E-4 of this Article. The State and units of local government shall provide the appropriate forms for such certification.

RETURN WITH BID

(b) A contractor who makes a false statement, material to the certification, commits a Class 3 felony.

A violation of Section 33E-3 would be represented by a conviction of the crime of bid-rigging which, in addition to Class 3 felony sentencing, provides that any person convicted of this offense or any similar offense of any state or the United States which contains the same elements as this offense shall be barred for 5 years from the date of conviction from contracting with any unit of State or local government. No corporation shall be barred from contracting with any unit of State or local government as a result of a conviction under this Section of any employee or agent of such corporation if the employee so convicted is no longer employed by the corporation and: (1) it has been finally adjudicated not guilty or (2) if it demonstrates to the governmental entity with which it seeks to contract and that entity finds that the commission of the offense was neither authorized, requested, commanded, nor performed by a director, officer or a high managerial agent in behalf of the corporation.

A violation of Section 33E-4 would be represented by a conviction of the crime of bid-rotating which, in addition to Class 2 felony sentencing, provides that any person convicted of this offense or any similar offense of any state or the United States which contains the same elements as this offense shall be permanently barred from contracting with any unit of State or local government. No corporation shall be barred from contracting with any unit of State or local government as a result of a conviction under this Section of any employee or agent of such corporation if the employee so convicted is no longer employed by the corporation and: (1) it has been finally adjudicated not guilty or (2) if it demonstrates to the governmental entity with which it seeks to contract and that entity finds that the commission of the offense was neither authorized, requested, commanded, nor performed by a director, officer or a high managerial agent in behalf of the corporation.

2. The bidder certifies that it is not barred from contracting with the Department by reason of a violation of either Section 33E-3 or Section 33E-4.

E. International Anti-Boycott

1. Section 5 of the International Anti-Boycott Certification Act provides:

§ 5. State contracts. Every contract entered into by the State of Illinois for the manufacture, furnishing, or purchasing of supplies, material, or equipment or for the furnishing of work, labor, or services, in an amount exceeding the threshold for small purchases according to the purchasing laws of this State or \$10,000.00, whichever is less, shall contain certification, as a material condition of the contract, by which the contractor agrees that neither the contractor nor any substantially-owned affiliated company is participating or shall participate in an international boycott in violation of the provisions of the U.S. Export Administration Act of 1979 or the regulations of the U.S. Department of Commerce promulgated under that Act.

2. The bidder makes the certification set forth in Section 5 of the Act.

F. Drug Free Workplace

1. The Illinois "Drug Free Workplace Act" applies to this contract and it is necessary to comply with the provisions of the "Act" if the contractor is a corporation, partnership, or other entity (including a sole proprietorship) which has 25 or more employees.

2. The bidder certifies that if awarded a contract in excess of \$5,000 it will provide a drug free workplace by:

(a) Publishing a statement notifying employees that the unlawful manufacture, distribution, dispensation, possession or use of a controlled substance, including cannabis, is prohibited in the contractor's workplace; specifying the actions that will be taken against employees for violations of such prohibition; and notifying the employee that, as a condition of employment on such contract, the employee shall abide by the terms of the statement, and notify the employer of any criminal drug statute conviction for a violation occurring in the workplace no later than five (5) days after such conviction.

(b) Establishing a drug free awareness program to inform employees about the dangers of drug abuse in the workplace; the contractor's policy of maintaining a drug free workplace; any available drug counseling, rehabilitation, and employee assistance programs; and the penalties that may be imposed upon employees for drug violations.

(c) Providing a copy of the statement required by subparagraph (1) to each employee engaged in the performance of the contract and to post the statement in a prominent place in the workplace.

(d) Notifying the Department within ten (10) days after receiving notice from an employee or otherwise receiving actual notice of the conviction of an employee for a violation of any criminal drug statute occurring in the workplace.

(e) Imposing or requiring, within 30 days after receiving notice from an employee of a conviction or actual notice of such a conviction, an appropriate personnel action, up to and including termination, or the satisfactory participation in a drug abuse assistance or rehabilitation program approved by a federal, state or local health, law enforcement or other appropriate agency.

(f) Assisting employees in selecting a course of action in the event drug counseling, treatment, and rehabilitation is required and indicating that a trained referral team is in place.

(g) Making a good faith effort to continue to maintain a drug free workplace through implementation of the actions and efforts stated in this certification.

RETURN WITH BID

G. Debt Delinquency

1. The Illinois Procurement Code provides:

Section 50-11 and 50-12. Debt Delinquency.

The contractor or bidder certifies that it, or any affiliate, is not barred from being awarded a contract under 30 ILCS 500. Section 50-11 prohibits a person from entering into a contract with a State agency if it knows or should know that it, or any affiliate, is delinquent in the payment of any debt to the State as defined by the Debt Collection Board. Section 50-12 prohibits a person from entering into a contract with a State agency if it, or any affiliate, has failed to collect and remit Illinois Use Tax on all sales of tangible personal property into the State of Illinois in accordance with the provisions of the Illinois Use Tax Act. The contractor further acknowledges that the contracting State agency may declare the contract void if this certification is false or if the contractor, or any affiliate, is determined to be delinquent in the payment of any debt to the State during the term of the contract.

H. Sarbanes-Oxley Act of 2002

1. The Illinois Procurement Code, Section 50-60(c), provides:

The contractor certifies in accordance with 30 ILCS 500/50-10.5 that no officer, director, partner or other managerial agent of the contracting business has been convicted of a felony under the Sarbanes-Oxley Act of 2002 or a Class 3 or Class 2 felony under the Illinois Securities Law of 1953 for a period of five years prior to the date of the bid or contract. The contractor acknowledges that the contracting agency shall declare the contract void if this certification is false.

I. Addenda

The contractor or bidder certifies that all relevant addenda have been incorporated in to this contract. Failure to do so may cause the bid to be declared unacceptable.

J. Section 42 of the Environmental Protection Act

The contractor certifies in accordance with 30 ILCS 500/50-12 that the bidder or contractor is not barred from being awarded a contract under this Section which prohibits the bidding on or entering into contracts with the State of Illinois or a State agency by a person or business found by a court or the Pollution Control Board to have committed a willful or knowing violation of Section 42 of the Environmental Protection Act for a period of five years from the date of the order. The contractor acknowledges that the contracting agency may declare the contract void if this certification is false.

K. Apprenticeship and Training Certification (Does not apply to federal aid projects)

In accordance with the provisions of Section 30-22 (6) of the Illinois Procurement Code, the bidder certifies that it is a participant, either as an individual or as part of a group program, in the approved apprenticeship and training programs applicable to each type of work or craft that the bidder will perform with its own forces. The bidder further certifies for work that will be performed by subcontract that each of its subcontractors submitted for approval either (a) is, at the time of such bid, participating in an approved, applicable apprenticeship and training program; or (b) will, prior to commencement of performance of work pursuant to this contract, begin participation in an approved apprenticeship and training program applicable to the work of the subcontract. The Department, at any time before or after award, may require the production of a copy of each applicable Certificate of Registration issued by the United States Department of Labor evidencing such participation by the contractor and any or all of its subcontractors. Applicable apprenticeship and training programs are those that have been approved and registered with the United States Department of Labor. The bidder shall list in the space below, the official name of the program sponsor holding the Certificate of Registration for all of the types of work or crafts in which the bidder is a participant and that will be performed with the bidder's forces. Types of work or craft work that will be subcontracted shall be included and listed as subcontract work. The list shall also indicate any type of work or craft job category that does not have an applicable apprenticeship or training program. **The bidder is responsible for making a complete report and shall make certain that each type of work or craft job category that will be utilized on the project as reported on the Construction Employee Workforce Projection (Form BC-1256) and returned with the bid is accounted for and listed.**

NA - FEDERAL

The requirements of this certification and disclosure are a material part of the contract, and the contractor shall require this certification provision to be included in all approved subcontracts. In order to fulfill this requirement, it shall not be necessary that an applicable program sponsor be currently taking or that it will take applications for apprenticeship, training or employment during the performance of the work of this contract.

L. Executive Order Number 1 (2007) Regarding Lobbying on Government Procurements

The bidder hereby warrants and certifies that they have complied and will comply with the requirements set forth in this Order. The requirements of this warrant and certification are a material part of the contract, and the contractor shall require this warrant and certification provision to be included in all approved subcontracts.

RETURN WITH BID

M. Disclosure of Business Operations in Iran

Section 50-36 of the Illinois Procurement Code, 30ILCS 500/50-36 provides that each bid, offer, or proposal submitted for a State contract shall include a disclosure of whether or not the Company acting as the bidder, offer or, or proposing entity, or any of its corporate parents or subsidiaries, within the 24 months before submission of the bid, offer, or proposal had business operations that involved contracts with or provision of supplies or services to the Government of Iran, companies in which the Government of Iran has any direct or indirect equity share, consortiums or projects commissioned by the Government of Iran, or companies involved in consortiums or projects commissioned by the Government of Iran and either of the following conditions apply:

- (1) More than 10% of the Company's revenues produced in or assets located in Iran involve oil-related activities or mineral-extraction activities; less than 75% of the Company's revenues produced in or assets located in Iran involve contracts with or provision of oil-related or mineral-extraction products or services to the Government of Iran or a project or consortium created exclusively by that government; and the Company has failed to take substantial action.
- (2) The Company has, on or after August 5, 1996, made an investment of \$20 million or more, or any combination of investments of at least \$10 million each that in the aggregate equals or exceeds \$20 million in any 12-month period, which directly or significantly contributes to the enhancement of Iran's ability to develop petroleum resources of Iran.

The terms "Business operations", "Company", "Mineral-extraction activities", "Oil-related activities", "Petroleum resources", and "Substantial action" are all defined in the Code.

Failure to make the disclosure required by the Code shall cause the bid, offer or proposal to be considered not responsive. The disclosure will be considered when evaluating the bid, offer, or proposal or awarding the contract. The name of each Company disclosed as doing business or having done business in Iran will be provided to the State Comptroller.

Check the appropriate statement:

Company has no business operations in Iran to disclose.

Company has business operations in Iran as disclosed the attached document.

N. Political Contributions and Registration with the State Board of Elections

Sections 20-160 and 50-37 of the Illinois Procurement Code regulate political contributions from business entities and any affiliated entities or affiliated persons bidding on or contracting with the state. Generally under Section 50-37, any business entity, and any affiliated entity or affiliated person of the business entity, whose current year contracts with all state agencies exceed an awarded value of \$50,000, are prohibited from making any contributions to any political committees established to promote the candidacy of the officeholder responsible for the awarding of the contracts or any other declared candidate for that office for the duration of the term of office of the incumbent officeholder or a period 2 years after the termination of the contract, whichever is longer. Any business entity and affiliated entities or affiliated persons whose state contracts in the current year do not exceed an awarded value of \$50,000, but whose aggregate pending bids and proposals on state contracts exceed \$50,000, either alone or in combination with contracts not exceeding \$50,000, are prohibited from making any political contributions to any political committee established to promote the candidacy of the officeholder responsible for awarding the pending contract during the period beginning on the date the invitation for bids or request for proposals is issued and ending on the day after the date of award or selection if the entity was not awarded or selected. Section 20-160 requires certification of registration of affected business entities in accordance with procedures found in Section 9-35 of The Election Code.

By submission of a bid, the contractor business entity acknowledges and agrees that it has read and understands Sections 20-160 and 50-37 of the Illinois Procurement Code, and that it makes the following certification:

The undersigned business entity certifies that it has registered as a business with the State Board of Elections and acknowledges a continuing duty to update the registration in accordance with the above referenced statutes. A copy of the certificate of registration shall be submitted with the bid. The bidder is cautioned that the Department will not award a contract without submission of the certificate of registration.

These requirements and compliance with the above referenced statutory sections are a material part of the contract, and any breach thereof shall be cause to void the contract under Section 50-60 of the Illinois Procurement Code. This provision does not apply to Federal-aid contracts.

TO BE RETURNED WITH BID

IV. DISCLOSURES

A. The disclosures hereinafter made by the bidder are each a material representation of fact upon which reliance is placed should the Department enter into the contract with the bidder. The Department may terminate the contract if it is later determined that the bidder rendered a false or erroneous disclosure, and the surety providing the performance bond shall be responsible for completion of the contract.

B. Financial Interests and Conflicts of Interest

1. Section 50-35 of the Illinois Procurement Code provides that all bids of more than \$10,000 shall be accompanied by disclosure of the financial interests of the bidder. This disclosed information for the successful bidder, will be maintained as public information subject to release by request pursuant to the Freedom of Information Act.

The financial interests to be disclosed shall include ownership or distributive income share that is in excess of 5%, or an amount greater than 60% of the annual salary of the Governor, of the bidding entity or its parent entity, whichever is less, unless the contractor or bidder is a publicly traded entity subject to Federal 10K reporting, in which case it may submit its 10K disclosure in place of the prescribed disclosure. If a bidder is a privately held entity that is exempt from Federal 10K reporting, but has more than 400 shareholders, it may submit the information that Federal 10K companies are required to report, and list the names of any person or entity holding any ownership share that is in excess of 5%. The disclosure shall include the names, addresses, and dollar or proportionate share of ownership of each person making the disclosure, their instrument of ownership or beneficial relationship, and notice of any potential conflict of interest resulting from the current ownership or beneficial interest of each person making the disclosure having any of the relationships identified in Section 50-35 and on the disclosure form.

In addition, all disclosures shall indicate any other current or pending contracts, proposals, leases, or other ongoing procurement relationships the bidding entity has with any other unit of state government and shall clearly identify the unit and the contract, proposal, lease, or other relationship.

2. Disclosure Forms. Disclosure Form A is attached for use concerning the individuals meeting the above ownership or distributive share requirements. Subject individuals should be covered each by one form. In addition, a second form (Disclosure Form B) provides for the disclosure of current or pending procurement relationships with other (non-IDOT) state agencies. **The forms must be included with each bid or incorporated by reference.**

C. Disclosure Form Instructions

Form A: For bidders that have previously submitted the information requested in Form A

The Department has retained the Form A disclosures submitted by all bidders responding to these requirements for the April 24, 1998 or any subsequent letting conducted by the Department. The bidder has the option of submitting the information again or the bidder may check the following certification statement indicating that the information previously submitted by the bidder is, as of the date of submission, current and accurate. Before checking this certification, the bidder should carefully review its prior submissions to ensure the Certification is correct. If the Bidder checks the Certification, the Bidder should proceed to Form B instructions.

CERTIFICATION STATEMENT

I have determined that the Form A disclosure information previously submitted is current and accurate, and all forms are hereby incorporated by reference in this bid. Any necessary additional forms or amendments to previously submitted forms are attached to this bid.

(Bidding Company)



Signature of Authorized Representative

Date

Form A: For bidders who have NOT previously submitted the information requested in Form A

If the bidder is a publicly traded entity subject to Federal 10K reporting, the 10K Report may be submitted to meet the requirements of Form A. If a bidder is a privately held entity that is exempt from Federal 10K reporting, but has more than 400 shareholders, it may submit the information that Federal 10K companies are required to report, and list the names of any person or entity holding any ownership share that is in excess of 5%. If a bidder is not subject to Federal 10K reporting, the bidder must determine if any individuals are required by law to complete a financial disclosure form. To do this, the bidder should answer each of the following questions. A "YES" answer indicates Form A must be completed. If the answer to each of the following questions is "NO", then the NOT APPLICABLE STATEMENT on the second page of Form A must be signed and dated by a person that is authorized to execute contracts for the bidding company. Note: These questions are for assistance only and are not required to be completed.

1. Does anyone in your organization have a direct or beneficial ownership share of greater than 5% of the bidding entity or parent entity? YES ___ NO ___
2. Does anyone in your organization have a direct or beneficial ownership share of less than 5%, but which has a value greater than \$102,600.00? YES ___ NO ___
3. Does anyone in your organization receive more than \$106,447.20 of the bidding entity's or parent entity's distributive income? (Note: Distributive income is, for these purposes, any type of distribution of profits. An annual salary is not distributive income.) YES ___ NO ___
4. Does anyone in your organization receive greater than 5% of the bidding entity's or parent entity's total distributive income, but which is less than \$106,447.20? YES ___ NO ___
(Note: Only one set of forms needs to be completed per person per bid even if a specific individual would require a yes answer to more than one question.)

A "YES" answer to any of these questions requires the completion of Form A. The bidder must determine each individual in the bidding entity or the bidding entity's parent company that would cause the questions to be answered "Yes". Each form must be signed and dated by a person that is authorized to execute contracts for your organization. **Photocopied or stamped signatures are not acceptable.** The person signing can be, but does not have to be, the person for which the form is being completed. The bidder is responsible for the accuracy of any information provided.

If the answer to each of the above questions is "NO", then the NOT APPLICABLE STATEMENT on page 2 of Form A must be signed and dated by a person that is authorized to execute contracts for your company.

Form B: Identifying Other Contracts & Procurement Related Information Disclosure Form B must be completed for each bid submitted by the bidding entity. Note: *Checking the NOT APPLICABLE STATEMENT on Form A does not allow the bidder to ignore Form B. Form B must be completed, checked, and dated or the bidder may be considered nonresponsive and the bid will not be accepted.*

The Bidder shall identify, by checking Yes or No on Form B, whether it has any pending contracts (including leases), bids, proposals, or other ongoing procurement relationship with any other (non-IDOT) State of Illinois agency. If "No" is checked, the bidder only needs to complete the check box on the bottom of Form B. If "Yes" is checked, the bidder must do one of the following:

Option I: If the bidder did not submit an Affidavit of Availability to obtain authorization to bid, the bidder must list all non-IDOT State of Illinois agency pending contracts, leases, bids, proposals, and other ongoing procurement relationships. These items may be listed on Form B or on an attached sheet(s). Do not include IDOT contracts. Contracts with cities, counties, villages, etc. are not considered State of Illinois agency contracts and are not to be included. Contracts with other State of Illinois agencies such as the Department of Natural Resources or the Capital Development Board must be included. Bidders who submit Affidavits of Availability are suggested to use Option II.

Option II: If the bidder is required and has submitted an Affidavit of Availability in order to obtain authorization to bid, the bidder may write or type "See Affidavit of Availability" which indicates that the Affidavit of Availability is incorporated by reference and includes all non-IDOT State of Illinois agency pending contracts, leases, bids, proposals, and other ongoing procurement relationships. For any contracts that are not covered by the Affidavit of Availability, the bidder must identify them on Form B or on an attached sheet(s). These might be such things as leases.

D. Bidders Submitting More Than One Bid

Bidders submitting multiple bids may submit one set of forms consisting of all required Form A disclosures and one Form B for use with all bids. Please indicate in the space provided below the bid item that contains the original disclosure forms and the bid items which incorporate the forms by reference.

- The bid submitted for letting item _____ contains the Form A disclosures or Certification Statement and the Form B disclosures. The following letting items incorporate the said forms by reference:

RETURN WITH BID/OFFER

**ILLINOIS DEPARTMENT
OF TRANSPORTATION**

**Form A
Financial Information &
Potential Conflicts of Interest
Disclosure**

Contractor Name		
Legal Address		
City, State, Zip		
Telephone Number	Email Address	Fax Number (if available)

Disclosure of the information contained in this Form is required by the Section 50-35 of the Illinois Procurement Code (30 ILCS 500). Vendors desiring to enter into a contract with the State of Illinois must disclose the financial information and potential conflict of interest information as specified in this Disclosure Form. This information shall become part of the publicly available contract file. This Form A must be completed for bids in excess of \$10,000, and for all open-ended contracts. **A publicly traded company may submit a 10K disclosure (or equivalent if applicable) in satisfaction of the requirements set forth in Form A. See Disclosure Form Instructions.**

DISCLOSURE OF FINANCIAL INFORMATION

1. Disclosure of Financial Information. The individual named below has an interest in the BIDDER (or its parent) in terms of ownership or distributive income share in excess of 5%, or an interest which has a value of more than \$106,447.20 (60% of the Governor's salary as of 3/1/09). **(Make copies of this form as necessary and attach a separate Disclosure Form A for each individual meeting these requirements)**

FOR INDIVIDUAL (type or print information)

NAME: _____

ADDRESS _____

Type of ownership/distributable income share:

stock _____ sole proprietorship _____ Partnership _____ other: (explain on separate sheet):
% or \$ value of ownership/distributable income share: _____

2. Disclosure of Potential Conflicts of Interest. Check "Yes" or "No" to indicate which, if any, of the following potential conflict of interest relationships apply. If the answer to any question is "Yes", please attach additional pages and describe.

(a) State employment, currently or in the previous 3 years, including contractual employment of services.
Yes ___ No ___

If your answer is yes, please answer each of the following questions.

- Are you currently an officer or employee of either the Capitol Development Board or the Illinois Toll Highway Authority? Yes ___ No ___
- Are you currently appointed to or employed by any agency of the State of Illinois? If you are currently appointed to or employed by any agency of the State of Illinois, and your annual salary exceeds \$106,447.20, (60% of the Governor's salary as of 3/1/09) provide the name the State agency for which you are employed and your annual salary. _____

RETURN WITH BID/OFFER

- 3. If you are currently appointed to or employed by any agency of the State of Illinois, and your annual salary exceeds \$106,447.20, (60% of the Governor's salary as of 3/1/09) are you entitled to receive (i) more than 7 1/2% of the total distributable income of your firm, partnership, association or corporation, or (ii) an amount in excess of the salary of the Governor? Yes ___ No ___

- 4. If you are currently appointed to or employed by any agency of the State of Illinois, and your annual salary exceeds \$106,447.20, (60% of the Governor's salary as of 3/1/09) are you and your spouse or minor children entitled to receive (i) more than 15% in aggregate of the total distributable income of your firm, partnership, association or corporation, or (ii) an amount in excess of 2 times the salary of the Governor? Yes ___ No ___

(b) State employment of spouse, father, mother, son, or daughter, including contractual employment for services in the previous 2 years.

Yes ___ No ___

If your answer is yes, please answer each of the following questions.

- 1. Is your spouse or any minor children currently an officer or employee of the Capitol Development Board or the Illinois Toll Highway Authority? Yes ___ No ___

- 2. Is your spouse or any minor children currently appointed to or employed by any agency of the State of Illinois? If your spouse or minor children is/are currently appointed to or employed by any agency of the State of Illinois, and his/her annual salary exceeds \$106,447.20, (60% of the Governor's salary as of 3/1/09) provide the name of the spouse and/or minor children, the name of the State agency for which he/she is employed and his/her annual salary. _____

- 3. If your spouse or any minor children is/are currently appointed to or employed by any agency of the State of Illinois, and his/her annual salary exceeds \$106,447.20.00, (60% of the salary of the Governor as of 3/1/09) are you entitled to receive (i) more than 7 1/2% of the total distributable income of your firm, partnership, association or corporation, or (ii) an amount in excess of the salary of the Governor? Yes ___ No ___

- 4. If your spouse or any minor children are currently appointed to or employed by any agency of the State of Illinois, and his/her annual salary exceeds \$106,447.20, (60% of the Governor's salary as of 3/1/09) are you and your spouse or any minor children entitled to receive (i) more than 15% in the aggregate of the total distributable income from your firm, partnership, association or corporation, or (ii) an amount in excess of 2 times the salary of the Governor? Yes ___ No ___

(c) Elective status; the holding of elective office of the State of Illinois, the government of the United States, any unit of local government authorized by the Constitution of the State of Illinois or the statutes of the State of Illinois currently or in the previous 3 years.

Yes ___ No ___

(d) Relationship to anyone holding elective office currently or in the previous 2 years; spouse, father, mother, son, or daughter.

Yes ___ No ___

(e) Appointive office; the holding of any appointive government office of the State of Illinois, the United State of America, or any unit of local government authorized by the Constitution of the State of Illinois or the statutes of the State of Illinois, which office entitles the holder to compensation in excess of the expenses incurred in the discharge of that office currently or in the previous 3 years.

Yes ___ No ___

(f) Relationship to anyone holding appointive office currently or in the previous 2 years; spouse, father, mother, son, or daughter.

Yes ___ No ___

(g) Employment, currently or in the previous 3 years, as or by any registered lobbyist of the State government.

Yes ___ No ___

RETURN WITH BID/OFFER

(h) Relationship to anyone who is or was a registered lobbyist in the previous 2 years; spouse, father, mother, son, or daughter. Yes ___ No ___

(i) Compensated employment, currently or in the previous 3 years, by any registered election or reelection committee registered with the Secretary of State or any county clerk of the State of Illinois, or any political action committee registered with either the Secretary of State or the Federal Board of Elections. Yes ___ No ___

(j) Relationship to anyone; spouse, father, mother, son, or daughter; who was a compensated employee in the last 2 years by any registered election or re-election committee registered with the Secretary of State or any county clerk of the State of Illinois, or any political action committee registered with either the Secretary of State or the Federal Board of Elections. Yes ___ No ___

APPLICABLE STATEMENT

This Disclosure Form A is submitted on behalf of the INDIVIDUAL named on previous page.

Completed by: _____ Date _____
Signature of Individual or Authorized Representative

NOT APPLICABLE STATEMENT

I have determined that no individuals associated with this organization meet the criteria that would require the completion of this Form A.

This Disclosure Form A is submitted on behalf of the CONTRACTOR listed on the previous page.

_____ Date _____
Signature of Authorized Representative

RETURN WITH BID/OFFER

**ILLINOIS DEPARTMENT
OF TRANSPORTATION**

**Form B
Other Contracts &
Procurement Related Information
Disclosure**

Contractor Name		
Legal Address		
City, State, Zip		
Telephone Number	Email Address	Fax Number (if available)

Disclosure of the information contained in this Form is required by the Section 50-35 of the Illinois Procurement Act (30 ILCS 500). This information shall become part of the publicly available contract file. This Form B must be completed for bids in excess of \$10,000, and for all open-ended contracts.

DISCLOSURE OF OTHER CONTRACTS AND PROCUREMENT RELATED INFORMATION

1. Identifying Other Contracts & Procurement Related Information. The BIDDER shall identify whether it has any pending contracts (including leases), bids, proposals, or other ongoing procurement relationship with any other State of Illinois agency: Yes ___ No ___

If "No" is checked, the bidder only needs to complete the signature box on the bottom of this page.

2. If "Yes" is checked. Identify each such relationship by showing State of Illinois agency name and other descriptive information such as bid or project number (attach additional pages as necessary). SEE DISCLOSURE FORM INSTRUCTIONS:

THE FOLLOWING STATEMENT MUST BE CHECKED

<input type="checkbox"/>	_____	_____
	Signature of Authorized Representative	Date

RETURN WITH BID

SPECIAL NOTICE TO CONTRACTORS

The following requirements of the Illinois Department of Human Rights' Rules and Regulations are applicable to bidders on all construction contracts advertised by the Illinois Department of Transportation:

CONSTRUCTION EMPLOYEE UTILIZATION PROJECTION

- (a) All bidders on construction contracts shall complete and submit, along with and as part of their bids, a Bidder's Employee Utilization Form (Form BC-1256) setting forth a projection and breakdown of the total workforce intended to be hired and/or allocated to such contract work by the bidder including a projection of minority and female employee utilization in all job classifications on the contract project.
- (b) The Department of Transportation shall review the Employee Utilization Form, and workforce projections contained therein, of the contract awardee to determine if such projections reflect an underutilization of minority persons and/or women in any job classification in accordance with the Equal Employment Opportunity Clause and Section 7.2 of the Illinois Department of Human Rights' Rules and Regulations for Public Contracts adopted as amended on September 17, 1980. If it is determined that the contract awardee's projections reflect an underutilization of minority persons and/or women in any job classification, it shall be advised in writing of the manner in which it is underutilizing and such awardee shall be considered to be in breach of the contract unless, prior to commencement of work on the contract project, it submits revised satisfactory projections or an acceptable written affirmative action plan to correct such underutilization including a specific timetable geared to the completion stages of the contract.
- (c) The Department of Transportation shall provide to the Department of Human Rights a copy of the contract awardee's Employee Utilization Form, a copy of any required written affirmative action plan, and any written correspondence related thereto. The Department of Human Rights may review and revise any action taken by the Department of Transportation with respect to these requirements.

RETURN WITH BID

**Contract No. 89547
TAZEWELL County
Section 09-00023-00-RS (DeLavan)
Project ARA-1464(103)
Route FAS 1464 (Locust Street)
District 4 Construction Funds**

PART II. WORKFORCE PROJECTION - continued

- B. Included in "Total Employees" under Table A is the total number of **new hires** that would be employed in the event the undersigned bidder is awarded this contract.

The undersigned bidder projects that: (number) _____ new hires would be recruited from the area in which the contract project is located; and/or (number) _____ new hires would be recruited from the area in which the bidder's principal office or base of operation is located.

- C. Included in "Total Employees" under Table A is a projection of numbers of persons to be employed directly by the undersigned bidder as well as a projection of numbers of persons to be employed by subcontractors.

The undersigned bidder estimates that (number) _____ persons will be directly employed by the prime contractor and that (number) _____ persons will be employed by subcontractors.

PART III. AFFIRMATIVE ACTION PLAN

- A. The undersigned bidder understands and agrees that in the event the foregoing minority and female employee utilization projection included under **PART II** is determined to be an underutilization of minority persons or women in any job category, and in the event that the undersigned bidder is awarded this contract, he/she will, prior to commencement of work, develop and submit a written Affirmative Action Plan including a specific timetable (geared to the completion stages of the contract) whereby deficiencies in minority and/or female employee utilization are corrected. Such Affirmative Action Plan will be subject to approval by the contracting agency and the **Department of Human Rights**.
- B. The undersigned bidder understands and agrees that the minority and female employee utilization projection submitted herein, and the goals and timetable included under an Affirmative Action Plan if required, are deemed to be part of the contract specifications.

Company _____ Telephone Number _____

Address _____

NOTICE REGARDING SIGNATURE

The Bidder's signature on the Proposal Signature Sheet will constitute the signing of this form. The following signature block needs to be completed only if revisions are required.

Signature: _____ Title: _____ Date: _____

Instructions: All tables must include subcontractor personnel in addition to prime contractor personnel.

Table A - Include both the number of employees that would be hired to perform the contract work and the total number currently employed (Table B) that will be allocated to contract work, and include all apprentices and on-the-job trainees. The "Total Employees" column should include all employees including all minorities, apprentices and on-the-job trainees to be employed on the contract work.

Table B - Include all employees currently employed that will be allocated to the contract work including any apprentices and on-the-job trainees currently employed.

Table C - Indicate the racial breakdown of the total apprentices and on-the-job trainees shown in Table A.

RETURN WITH BID

ADDITIONAL FEDERAL REQUIREMENTS

In addition to the Required Contract Provisions for Federal-Aid Construction Contracts (FHWA 1273), all bidders make the following certifications.

- A. By the execution of this proposal, the signing bidder certifies that the bidding entity has not, either directly or indirectly, entered into any agreement, participated in any collusion, or otherwise taken any action, in restraint of free competitive bidding in connection with the submitted bid. This statement made by the undersigned bidder is true and correct under penalty of perjury under the laws of the United States.
- B. CERTIFICATION, EQUAL EMPLOYMENT OPPORTUNITY:
1. Have you participated in any previous contracts or subcontracts subject to the equal opportunity clause. YES _____ NO _____
 2. If answer to #1 is yes, have you filed with the Joint Reporting Committee, the Director of OFCC, any Federal agency, or the former President's Committee on Equal Employment Opportunity, all reports due under the applicable filing requirements of those organizations? YES _____ NO _____

RETURN WITH BID

**Contract No. 89547
TAZEWELL County
Section 09-0023-00-RS (DeLavan)
Project ARA-1464(103)
Route FAS 1464 (Locust Street)
District 4 Construction Funds**

PROPOSAL SIGNATURE SHEET

The undersigned bidder hereby makes and submits this bid on the subject Proposal, thereby assuring the Department that all requirements of the Invitation for Bids and rules of the Department have been met, that there is no misunderstanding of the requirements of paragraph 3 of this Proposal, and that the contract will be executed in accordance with the rules of the Department if an award is made on this bid.

(IF AN INDIVIDUAL)

Firm Name _____
Signature of Owner _____
Business Address _____

(IF A CO-PARTNERSHIP)

Firm Name _____
By _____
Business Address _____
Name and Address of All Members of the Firm: _____

(IF A CORPORATION)

Corporate Name _____
By _____
Signature of Authorized Representative _____
Typed or printed name and title of Authorized Representative _____

(IF A JOINT VENTURE, USE THIS SECTION FOR THE MANAGING PARTY AND THE SECOND PARTY SHOULD SIGN BELOW)

Attest _____
Signature _____
Business Address _____

(IF A JOINT VENTURE)

Corporate Name _____
By _____
Signature of Authorized Representative _____
Typed or printed name and title of Authorized Representative _____

Attest _____
Signature _____
Business Address _____

If more than two parties are in the joint venture, please attach an additional signature sheet.



Return with Bid

Division of Highways
Proposal Bid Bond
(Effective November 1, 1992)

Item No. _____

Letting Date _____

KNOW ALL MEN BY THESE PRESENTS, That We _____

as PRINCIPAL, and _____

_____ as SURETY, are held jointly, severally and firmly bound unto the STATE OF ILLINOIS in the penal sum of 5 percent of the total bid price, or for the amount specified in Article 102.09 of the "Standard Specifications for Road and Bridge Construction" in effect on the date of invitation for bids, whichever is the lesser sum, well and truly to be paid unto said STATE OF ILLINOIS, for the payment of which we bind ourselves, our heirs, executors, administrators, successors and assigns.

THE CONDITION OF THE FOREGOING OBLIGATION IS SUCH, that whereas, the PRINCIPAL has submitted a bid proposal to the STATE OF ILLINOIS, acting through the Department of Transportation, for the improvement designated by the Transportation Bulletin Item Number and Letting Date indicated above.

NOW, THEREFORE, if the Department shall accept the bid proposal of the PRINCIPAL; and if the PRINCIPAL shall, within the time and as specified in the bidding and contract documents, submit a DBE Utilization Plan that is accepted and approved by the Department; and if, after award by the Department, the PRINCIPAL shall enter into a contract in accordance with the terms of the bidding and contract documents including evidence of the required insurance coverages and providing such bond as specified with good and sufficient surety for the faithful performance of such contract and for the prompt payment of labor and material furnished in the prosecution thereof; or if, in the event of the failure of the PRINCIPAL to make the required DBE submission or to enter into such contract and to give the specified bond, the PRINCIPAL pays to the Department the difference not to exceed the penalty hereof between the amount specified in the bid proposal and such larger amount for which the Department may contract with another party to perform the work covered by said bid proposal, then this obligation shall be null and void, otherwise, it shall remain in full force and effect.

IN THE EVENT the Department determines the PRINCIPAL has failed to comply with any requirement as set forth in the preceding paragraph, then Surety shall pay the penal sum to the Department within fifteen (15) days of written demand therefor. If Surety does not make full payment within such period of time, the Department may bring an action to collect the amount owed. Surety is liable to the Department for all its expenses, including attorney's fees, incurred in any litigation in which it prevails either in whole or in part.

In TESTIMONY WHEREOF, the said PRINCIPAL and the said SURETY have caused this instrument to be signed by

their respective officers this _____ day of _____ A.D., _____ .

PRINCIPAL

SURETY

(Company Name)

(Company Name)

By _____
(Signature & Title)

By: _____
(Signature of Attorney-in-Fact)

Notary Certification for Principal and Surety

STATE OF ILLINOIS,
County of _____

I, _____, a Notary Public in and for said County, do hereby certify that

_____ and _____
(Insert names of individuals signing on behalf of PRINCIPAL & SURETY)

who are each personally known to me to be the same persons whose names are subscribed to the foregoing instrument on behalf of PRINCIPAL and SURETY, appeared before me this day in person and acknowledged respectively, that they signed and delivered said instrument as their free and voluntary act for the uses and purposes therein set forth.

Given under my hand and notarial seal this _____ day of _____ A.D. _____

My commission expires _____

Notary Public

In lieu of completing the above section of the Proposal Bid Form, the Principal may file an Electronic Bid Bond. By signing the proposal and marking the check box next to the Signature and Title line below, the Principal is ensuring the identified electronic bid bond has been executed and the Principal and Surety are firmly bound unto the State of Illinois under the conditions of the bid bond as shown above.

Electronic Bid Bond ID# _____

Company / Bidder Name _____



Signature and Title _____

PROPOSAL ENVELOPE



PROPOSALS

for construction work advertised for bids by the
Illinois Department of Transportation

Item No.	Item No.	Item No.

Submitted By:

Name:
Address:
Phone No.

Bidders should use an IDOT proposal envelope or affix this form to the front of a 10" x 13" envelope for the submittal of bids. If proposals are mailed, they should be enclosed in a second or outer envelope addressed to:

Engineer of Design and Environment - Room 326
Illinois Department of Transportation
2300 South Dirksen Parkway
Springfield, Illinois 62764

NOTICE

Individual bids, including Bid Bond and/or supplemental information if required, should be securely stapled.

CONTRACTOR OFFICE COPY OF CONTRACT SPECIFICATIONS

NOTICE

None of the following material needs to be returned with the bid package unless the special provisions require documentation and/or other information to be submitted.

**Contract No. 89547
TAZEWELL County
Section 09-00023-00-RS (DeLavan)
Project ARA-1464(103)
Route FAS 1464 (Locust Street)
District 4 Construction Funds**



Illinois Department of Transportation



NOTICE TO BIDDERS

- 1. TIME AND PLACE OF OPENING BIDS.** Sealed proposals for the improvement described herein will be received by the Department of Transportation at the Harry R. Hanley Building, 2300 South Dirksen Parkway, in Springfield, Illinois until 10:00 o'clock a.m., July 31, 2009. All bids will be gathered, sorted, publicly opened and read in the auditorium at the Department of Transportation's Harry R. Hanley Building shortly after the 10:00 a.m. cut off time.
- 2. DESCRIPTION OF WORK.** The proposed improvement is identified and advertised for bids in the Invitation for Bids as:

**Contract No. 89547
TAZEWELL County
Section 09-00023-00-RS (DeLavan)
Project ARA-1464(103)
Route FAS 1464 (Locust Street)
District 4 Construction Funds**

Project consists of 0.41 mile of HMA surface removal, HMA resurfacing and thermoplastic pavement marking on FAS Route 1464 (Locust Street) from Ninth Street to Fifth Street in Delavan.

- 3. INSTRUCTIONS TO BIDDERS.** (a) This Notice, the invitation for bids, proposal and letter of award shall, together with all other documents in accordance with Article 101.09 of the Standard Specifications for Road and Bridge Construction, become part of the contract. Bidders are cautioned to read and examine carefully all documents, to make all required inspections, and to inquire or seek explanation of the same prior to submission of a bid.

(b) State law, and, if the work is to be paid wholly or in part with Federal-aid funds, Federal law requires the bidder to make various certifications as a part of the proposal and contract. By execution and submission of the proposal, the bidder makes the certification contained therein. A false or fraudulent certification shall, in addition to all other remedies provided by law, be a breach of contract and may result in termination of the contract.
- 4. AWARD CRITERIA AND REJECTION OF BIDS.** This contract will be awarded to the lowest responsive and responsible bidder considering conformity with the terms and conditions established by the Department in the rules, Invitation for Bids and contract documents. The issuance of plans and proposal forms for bidding based upon a prequalification rating shall not be the sole determinant of responsibility. The Department reserves the right to determine responsibility at the time of award, to reject any or all proposals, to readvertise the proposed improvement, and to waive technicalities.

By Order of the
Illinois Department of Transportation

Gary Hannig,
Acting Secretary

INDEX
FOR
SUPPLEMENTAL SPECIFICATIONS
AND RECURRING SPECIAL PROVISIONS

Adopted January 1, 2009

This index contains a listing of SUPPLEMENTAL SPECIFICATIONS and frequently used RECURRING SPECIAL PROVISIONS.

ERRATA Standard Specifications for Road and Bridge Construction (Adopted 1-1-07) (Revised 1-1-09)

SUPPLEMENTAL SPECIFICATIONS

<u>Std. Spec. Sec.</u>	<u>Page No.</u>
201 Clearing, Tree Removal and Protection	1
205 Embankment	2
251 Mulch	3
253 Planting Woody Plants	4
280 Temporary Erosion Control	6
443 Reflective Crack Control Treatment	7
502 Excavation for Structures	10
503 Concrete Structures	11
504 Precast Concrete Structures	12
505 Steel Structures	13
540 Box Culverts	14
581 Waterproofing Membrane System	15
633 Removing and Reerecting Guardrail and Terminals	16
669 Removal and Disposal of Regulated Substances	17
672 Sealing Abandoned Water Wells	18
701 Work Zone Traffic Control and Protection	19
733 Overhead Sign Structures	20
783 Pavement Marking and Marker Removal	21
801 Electrical Requirements	22
805 Electrical Service Installation – Traffic Signals	23
836 Pole Foundation	24
838 Breakaway Devices	25
862 Uninterruptable Power Supply	26
873 Electric Cable	28
878 Traffic Signal Concrete Foundation	30
1004 Coarse Aggregates	31
1008 Structural Steel Coatings	32
1010 Finely Divided Materials	33
1020 Portland Cement Concrete	34
1022 Concrete Curing Materials	43
1024 Nonshrink Grout	44
1042 Precast Concrete Products	45
1062 Reflective Crack Control System	47
1069 Pole and Tower	49
1074 Control Equipment	52
1076 Wire and Cable	57
1081 Materials for Planting	58
1083 Elastomeric Bearings	60
1094 Overhead Sign Structures	61
1101 General Equipment	62
1102 Hot-Mix Asphalt Equipment	63
1106 Work Zone Traffic Control Devices	64

RECURRING SPECIAL PROVISIONS

The following RECURRING SPECIAL PROVISIONS indicated by an "X" are applicable to this contract and are included by reference:

<u>CHECK SHEET #</u>		<u>PAGE NO.</u>
1	<input checked="" type="checkbox"/> Additional State Requirements For Federal-Aid Construction Contracts (Eff. 2-1-69) (Rev. 1-1-07)	65
2	<input checked="" type="checkbox"/> Subletting of Contracts (Federal-Aid Contracts) (Eff. 1-1-88) (Rev. 5-1-93)	67
3	<input checked="" type="checkbox"/> EEO (Eff. 7-21-78) (Rev. 11-18-80)	68
4	<input type="checkbox"/> Specific Equal Employment Opportunity Responsibilities Non Federal-Aid Contracts (Eff. 3-20-69) (Rev. 1-1-94)	78
5	<input type="checkbox"/> Required Provisions - State Contracts (Eff. 4-1-65) (Rev. 1-1-07)	83
6	<input type="checkbox"/> Reserved	88
7	<input type="checkbox"/> Reserved	89
8	<input type="checkbox"/> Haul Road Stream Crossings, Other Temporary Stream Crossings, and In-Stream Work Pads (Eff. 1-2-92) (Rev. 1-1-98)	90
9	<input type="checkbox"/> Construction Layout Stakes Except for Bridges (Eff. 1-1-99) (Rev. 1-1-07)	91
10	<input type="checkbox"/> Construction Layout Stakes (Eff. 5-1-93) (Rev. 1-1-07)	94
11	<input type="checkbox"/> Use of Geotextile Fabric for Railroad Crossing (Eff. 1-1-95) (Rev. 1-1-07)	97
12	<input type="checkbox"/> Subsealing of Concrete Pavements (Eff. 11-1-84) (Rev. 1-1-07)	99
13	<input type="checkbox"/> Hot-Mix Asphalt Surface Correction (Eff. 11-1-87) (Rev. 1-1-09)	103
14	<input type="checkbox"/> Pavement and Shoulder Resurfacing (Eff. 2-1-00) (Rev. 1-1-09)	105
15	<input type="checkbox"/> PCC Partial Depth Hot-Mix Asphalt Patching (Eff. 1-1-98) (Rev. 1-1-07)	106
16	<input type="checkbox"/> Patching with Hot-Mix Asphalt Overlay Removal (Eff. 10-1-95) (Rev. 1-1-07)	108
17	<input type="checkbox"/> Polymer Concrete (Eff. 8-1-95) (Rev. 1-1-08)	109
18	<input type="checkbox"/> PVC Pipeliner (Eff. 4-1-04) (Rev. 1-1-07)	111
19	<input type="checkbox"/> Pipe Underdrains (Eff. 9-9-87) (Rev. 1-1-07)	112
20	<input type="checkbox"/> Guardrail and Barrier Wall Delineation (Eff. 12-15-93) (Rev. 1-1-97)	113
21	<input type="checkbox"/> Bicycle Racks (Eff. 4-1-94) (Rev. 1-1-07)	117
22	<input type="checkbox"/> Temporary Modular Glare Screen System (Eff. 1-1-00) (Rev. 1-1-07)	119
23	<input type="checkbox"/> Temporary Portable Bridge Traffic Signals (Eff. 8-1-03) (Rev. 1-1-07)	121
24	<input type="checkbox"/> Work Zone Public Information Signs (Eff. 9-1-02) (Rev. 1-1-07)	123
25	<input type="checkbox"/> Night Time Inspection of Roadway Lighting (Eff. 5-1-96)	124
26	<input type="checkbox"/> English Substitution of Metric Bolts (Eff. 7-1-96)	125
27	<input type="checkbox"/> English Substitution of Metric Reinforcement Bars (Eff. 4-1-96) (Rev. 1-1-03)	126
28	<input type="checkbox"/> Calcium Chloride Accelerator for Portland Cement Concrete (Eff. 1-1-01)	127
29	<input type="checkbox"/> Reserved	128
30	<input type="checkbox"/> Quality Control of Concrete Mixtures at the Plant (Eff. 8-1-00) (Rev. 1-1-09)	129
31	<input type="checkbox"/> Quality Control/Quality Assurance of Concrete Mixtures (Eff. 4-1-92) (Rev. 1-1-09)	137
32	<input type="checkbox"/> Asbestos Bearing Pad Removal (Eff. 11-1-03)	149
33	<input type="checkbox"/> Asbestos Hot-Mix Asphalt Surface Removal (Eff. 6-1-89) (Rev. 1-1-09)	150
LRS 1	<input type="checkbox"/> Reserved	152
LRS 2	<input type="checkbox"/> Furnished Excavation (Eff. 1-1-99) (Rev. 1-1-07)	153
LRS 3	<input checked="" type="checkbox"/> Work Zone Traffic Control (Eff. 1-1-99) (Rev. 1-1-07).....	154
LRS 4	<input checked="" type="checkbox"/> Flaggers in Work Zones (Eff. 1-1-99) (Rev 1-1-07).....	155
LRS 5	<input type="checkbox"/> Contract Claims (Eff. 1-1-02) (Rev. 1-1-07).....	156
LRS 6	<input type="checkbox"/> Bidding Requirements and Conditions for Contract Proposals (Eff. 1-1-02).....	157
LRS 7	<input type="checkbox"/> Bidding Requirements and Conditions for Material Proposals (Eff. 1-1-02) (Rev. 1-1-03).....	163
LRS 8	<input type="checkbox"/> Failure to Complete the Work on Time (Eff. 1-1-99).....	169
LRS 9	<input type="checkbox"/> Bituminous Surface Treatments (Eff. 1-1-99)	170
LRS 10	<input type="checkbox"/> Reflective Sheeting Type C (Eff. 1-1-99) (Rev. 1-1-02)	171
LRS 11	<input type="checkbox"/> Employment Practices (Eff. 1-1-99)	172
LRS 12	<input type="checkbox"/> Wages of Employees on Public Works (Eff. 1-1-99) (Rev. 4-1-06).....	174
LRS 13	<input type="checkbox"/> Selection of Labor (Eff. 1-1-99)	175
LRS 14	<input type="checkbox"/> Paving Brick and Concrete Paver Pavements and Sidewalks (Eff. 1-1-04) (Rev. 1-1-09).....	176
LRS 15	<input type="checkbox"/> Partial Payments (Eff. 1-1-07)	179

INDEX OF SPECIAL PROVISION

SPECIAL PROVISIONS	PAGE NO.
DESCRIPTION OF PROJECT.....	1
PLACEMENT OF HOT-MIX ASPHALT SURFACE COURSES.....	1
HOT-MIX ASPHALT SURFACE COURSE SURFACE TESTS.....	1
STATUS OF UTILITIES / UTILITIES TO BE ADJUSTED.....	2

INDEX LOCAL ROADS AND STREETS SPECIAL PROVISIONS

LR #	Pg #	Special Provision Title	Effective	Revised
LR SD 12		<input type="checkbox"/> Slab Movement Detection Device	Nov. 11, 1984	Jan. 1, 2007
LR SD 13		<input type="checkbox"/> Required Cold Milled Surface Texture	Nov. 1, 1987	Jan. 1, 2007
LR 102		<input type="checkbox"/> Protests on Local Lettings	Jan. 1, 2007	
LR 105		<input type="checkbox"/> Cooperation with Utilities	Jan. 1, 1999	Jan. 1, 2007
LR 107-2		<input type="checkbox"/> Railroad Protective Liability Insurance for Local Lettings	Mar. 1, 2005	Jan. 1, 2006
LR 107-3		<input type="checkbox"/> Disadvantaged Business Enterprise Participation	Jan. 1, 2007	Nov. 1, 2008
LR 107-4	3	<input checked="" type="checkbox"/> Insurance	Feb. 1, 2007	Aug. 1, 2007
LR 107-5		<input type="checkbox"/> Substance Abuse Prevention Program	Jan. 1, 2008	Jan. 8, 2008
LR 108		<input type="checkbox"/> Combination Bids	Jan. 1, 1994	Mar. 1, 2005
LR 212		<input type="checkbox"/> Shaping Roadway	Aug. 1, 1969	Jan. 1, 2002
LR 355-1		<input type="checkbox"/> Asphalt Stabilized Base Course, Road Mix or Traveling Plant Mix	Oct. 1, 1973	Jan. 1, 2007
LR 355-2		<input type="checkbox"/> Asphalt Stabilized Base Course, Plant Mix	Feb. 2, 1963	Jan. 1, 2007
LR 400-1		<input type="checkbox"/> Bituminous Treated Earth Surface	Jan. 1, 2008	
LR 400-2		<input type="checkbox"/> Bituminous Surface Mixture (Class B)	Jan. 1, 2008	
LR 400-3		<input type="checkbox"/> Pavement Rehabilitation by the Heat-Scarify-Overlay Method	Jan. 1, 2008	
LR 402		<input type="checkbox"/> Salt Stabilized Surface Course	Feb. 20, 1963	Jan. 1, 2007
LR 403-2		<input type="checkbox"/> Bituminous Hot Mix Sand Seal Coat	Aug. 1, 1969	Jan. 1, 2007
LR 406		<input type="checkbox"/> Filling HMA Core Holes with Non-shrink Grout	Jan. 1, 2008	
LR 420		<input type="checkbox"/> PCC Pavement (Special)	May 12, 1964	Jan. 2, 2007
LR 442		<input type="checkbox"/> Bituminous Patching Mixtures for Maintenance Use	Jan. 1, 2004	Jun. 1, 2007
LR 451		<input type="checkbox"/> Crack Filling Bituminous Pavement with Fiber-Asphalt	Oct. 1, 1991	Jan. 1, 2007
LR 503-1		<input type="checkbox"/> Furnishing Class SI Concrete	Oct. 1, 1973	Jan. 1, 2002
LR 503-2		<input type="checkbox"/> Furnishing Class SI Concrete (Short Load)	Jan. 1, 1989	Jan. 1, 2002
LR 542		<input type="checkbox"/> Pipe Culverts, Type _____ (Furnished)	Sep. 1, 1964	Jan. 1, 2007
LR 663		<input type="checkbox"/> Calcium Chloride Applied	Jun. 1, 1958	Jan. 1, 2007
LR 702		<input type="checkbox"/> Construction and Maintenance Signs	Jan. 1, 2004	Jun. 1, 2007
LR 1004		<input type="checkbox"/> Coarse Aggregate for Bituminous Surface Treatment	Jan. 1, 2002	Jan. 1, 2007
LR 1013		<input type="checkbox"/> Rock Salt (Sodium Chloride)	Aug. 1, 1969	Jan. 1, 2002
LR 1030	4	<input checked="" type="checkbox"/> Growth Curve	Mar. 1, 2008	
LR 1032-1		<input type="checkbox"/> Penetrating Emulsions	Jan. 1, 2007	Feb. 1, 2007
LR 1032-2		<input type="checkbox"/> Multigrade Cold Mix Asphalt	Jan. 1, 2007	Feb. 1, 2007
LR 1102		<input type="checkbox"/> Road Mix or Traveling Plan Mix Equipment	Jan. 1, 2007	

BDE SPECIAL PROVISIONS
For the July 31 and September 18, 2009 Lettings

The following special provisions indicated by an "X" are applicable to this contract. An * indicates a new or revised special provision for the letting.

File Name	Pg#		Special Provision Title	Effective	Revised
* 80240			Above Grade Inlet Protection	July 1, 2009	
80099			Accessible Pedestrian Signals (APS)	April 1, 2003	Jan. 1, 2007
80186			Alkali-Silica Reaction for Cast-in-Place Concrete	Aug. 1, 2007	Jan. 1, 2009
80213			Alkali-Silica Reaction for Precast and Precast Prestressed Concrete	Jan. 1, 2009	
* 80243	5	X	American Recovery and Reinvestment Act Provisions	April 1, 2009	
* 80236	6	X	American Recovery and Reinvestment Act Signing	April 1, 2009	April 15, 2009
80207	12	X	Approval of Proposed Borrow Areas, Use Areas, and/or Waste Areas Inside Illinois State Borders	Nov. 1, 2008	
80192			Automated Flagger Assistance Device	Jan. 1, 2008	
80173	13	X	Bituminous Materials Cost Adjustments	Nov. 2, 2006	April 1, 2009
* 80241			Bridge Demolition Debris	July 1, 2009	
50261			Building Removal-Case I (Non-Friable and Friable Asbestos)	Sept. 1, 1990	Jan. 1, 2007
50481			Building Removal-Case II (Non-Friable Asbestos)	Sept. 1, 1990	Jan. 1, 2007
50491			Building Removal-Case III (Friable Asbestos)	Sept. 1, 1990	Jan. 1, 2007
50531			Building Removal-Case IV (No Asbestos)	Sept. 1, 1990	Jan. 1, 2007
80166			Cement	Jan. 1, 2007	April 1, 2009
80198			Completion Date (via calendar days)	April 1, 2008	
80199			Completion Date (via calendar days) Plus Working Days	April 1, 2008	
80094			Concrete Admixtures	Jan. 1, 2003	April 1, 2009
80193			Concrete Barrier	Jan. 1, 2008	
80214			Concrete Gutter, Type A	Jan. 1, 2009	
80215			Concrete Joint Sealer	Jan. 1, 2009	
80226			Concrete Mix Designs	April 1, 2009	
* 80237	16	X	Construction Air Quality – Diesel Vehicle Emissions Control	April 1, 2009	July 1, 2009
* 80239	18	X	Construction Air Quality – Idling Restrictions	April 1, 2009	
80227			Determination of Thickness	April 1, 2009	
80177			Digital Terrain Modeling for Earthwork Calculations	April 1, 2007	
80029	20	X	Disadvantaged Business Enterprise Participation	Sept. 1, 2000	Nov. 1, 2008
80178			Dowel Bars	April 1, 2007	Jan. 1, 2008
80179			Engineer's Field Office Type A	April 1, 2007	Aug. 1, 2008
80205			Engineer's Field Office Type B	Aug. 1, 2008	
80175			Epoxy Pavement Markings	Jan. 1, 2007	
80189	28	X	Equipment Rental Rates	Aug. 2, 2007	Jan. 2, 2008
80228	30	X	Flagger at Side Roads and Entrances	April 1, 2009	
80229			Fuel Cost Adjustment	April 1, 2009	
* 80169			High Tension Cable Median Barrier	Jan. 1, 2007	April 1, 2009
80194			HMA – Hauling on Partially Completed Full-Depth Pavement	Jan. 1, 2008	
80181	31	X	Hot-Mix Asphalt – Field Voids in the Mineral Aggregate	April 1, 2007	April 1, 2008
80201	33	X	Hot-Mix Asphalt – Plant Test Frequency	April 1, 2008	
80202	35	X	Hot-Mix Asphalt – Transportation	April 1, 2008	
80136			Hot-Mix Asphalt Mixture IL-4.75	Nov. 1, 2004	Jan. 1, 2008
80195			Hot-Mix Asphalt Mixture IL-9.5L	Jan. 1, 2008	
80109			Impact Attenuators	Nov. 1, 2003	Nov. 1, 2008
80110			Impact Attenuators, Temporary	Nov. 1, 2003	Jan. 1, 2007
80230	36	X	Liquidated Damages	April 1, 2009	
80196			Mast Arm Assembly and Pole	Jan. 1, 2008	Jan. 1, 2009
80045			Material Transfer Device	June 15, 1999	Jan. 1, 2009
80203			Metal Hardware Cast into Concrete	April 1, 2008	April 1, 2009
80165			Moisture Cured Urethane Paint System	Nov. 1, 2006	Jan. 1, 2007
* 80238	37	X	Monthly Employment Report	April 1, 2009	
80082			Multilane Pavement Patching	Nov. 1, 2002	
80180			National Pollutant Discharge Elimination System / Erosion and Sediment Control Deficiency Deduction (NOTE: This special provision was previously named "Erosion and Sediment Control Deficiency Deduction".)	April 1, 2007	Nov. 1, 2008
80208			Nighttime Work Zone Lighting	Nov. 1, 2008	

<u>File Name</u>	<u>Pg#</u>		<u>Special Provision Title</u>	<u>Effective</u>	<u>Revised</u>
80129			Notched Wedge Longitudinal Joint	July 1, 2004	Jan. 1, 2007
80182			Notification of Reduced Width	April 1, 2007	
80069			Organic Zinc-Rich Paint System	Nov. 1, 2001	Jan. 1, 2008
80216			Partial Exit Ramp Closure for Freeway/Expressway	Jan. 1, 2009	
80231			Pavement Marking Removal	April 1, 2009	
80022	39	X	Payments to Subcontractors	June 1, 2000	Jan. 1, 2006
* 80235	41	X	Payrolls and Payroll Records	March 1, 2009	July 1, 2009
80209	43	X	Personal Protective Equipment	Nov. 1, 2008	
80232			Pipe Culverts	April 1, 2009	
80134			Plastic Blockouts for Guardrail	Nov. 1, 2004	Jan. 1, 2007
80119			Polyurea Pavement Marking	April 1, 2004	Jan. 1, 2009
80210			Portland Cement Concrete Inlay or Overlay	Nov. 1, 2008	
80170			Portland Cement Concrete Plants	Jan. 1, 2007	
80217			Post Clips for Extruded Aluminum Signs	Jan. 1, 2009	
80171			Precast Handling Holes	Jan. 1, 2007	
80218			Preventive Maintenance – Bituminous Surface Treatment	Jan. 1, 2009	April 1, 2009
80219			Preventive Maintenance – Cape Seal	Jan. 1, 2009	April 1, 2009
80220			Preventive Maintenance – Micro-Surfacing	Jan. 1, 2009	
80221			Preventive Maintenance – Slurry Seal	Jan. 1, 2009	
80211			Prismatic Curb Reflectors	Nov. 1, 2008	
80015			Public Convenience and Safety	Jan. 1, 2000	
34261			Railroad Protective Liability Insurance	Dec. 1, 1986	Jan. 1, 2006
80157	44	X	Railroad Protective Liability Insurance (5 and 10)	Jan. 1, 2006	
80223			Ramp Closure for Freeway/Expressway	Jan. 1, 2009	
80172			Reclaimed Asphalt Pavement (RAP)	Jan. 1, 2007	April 1, 2009
80183			Reflective Sheeting on Channelizing Devices	April 1, 2007	Nov. 1, 2008
80151			Reinforcement Bars	Nov. 1, 2005	April 1, 2009
80206			Reinforcement Bars – Storage and Protection	Aug. 1, 2008	April 1, 2009
80224			Restoring Bridge Approach Pavements Using High-Density Foam	Jan. 1, 2009	
80184			Retroreflective Sheeting, Nonreflective Sheeting, and Translucent Overlay Film for Highway Signs	April 1, 2007	
* 80131			Seeding	July 1, 2004	July 1, 2009
80152			Self-Consolidating Concrete for Cast-In-Place Construction	Nov. 1, 2005	Jan. 1, 2009
80132			Self-Consolidating Concrete for Precast Products	July 1, 2004	Jan. 1, 2007
80212			Sign Panels and Sign Panel Overlays	Nov. 1, 2008	
80197			Silt Filter Fence	Jan. 1, 2008	
80127			Steel Cost Adjustment	April 2, 2004	April 1, 2009
80153			Steel Plate Beam Guardrail	Nov. 1, 2005	Aug. 1, 2007
80191			Stone Gradation Testing	Nov. 1, 2007	
80234			Storm Sewers	April 1, 2009	
80143	46	X	Subcontractor Mobilization Payments	April 2, 2005	
80075			Surface Testing of Pavements	April 1, 2002	Jan. 1, 2007
80087			Temporary Erosion Control	Nov. 1, 2002	Jan. 1, 2008
80225			Temporary Raised Pavement Marker	Jan. 1, 2009	
80176			Thermoplastic Pavement Markings	Jan. 1, 2007	
20338			Training Special Provisions	Oct. 15, 1975	
80185			Type ZZ Retroreflective Sheeting, Nonreflective Sheeting, and Translucent Overlay Film for Highway Signs	April 1, 2007	
80149			Variable Spaced Tining	Aug. 1, 2005	Jan. 1, 2007
80071	47	X	Working Days	Jan. 1, 2002	
80204			Woven Wire Fence	April 1, 2008	

The following special provisions are in the 2009 Supplemental Specifications and Recurring Special Provisions:

<u>File Name</u>	<u>Special Provision Title</u>	<u>New Location</u>	<u>Effective</u>	<u>Revised</u>
80108	Asbestos Bearing Pad Removal	Check Sheet #32	Nov. 1, 2003	
72541	Asbestos Waterproofing Membrane and Asbestos Hot-Mix Asphalt Surface Removal	Check Sheet #33	June 1, 1989	Jan. 2, 2007
80167	Electrical Service Installation – Traffic Signals	Section 805	Jan. 1, 2007	
80164	Removal and Disposal of Regulated Substances	Section 669	Aug. 1, 2006	Jan. 1, 2007
80161	Traffic Signal Grounding	Sections 873 and 1076	April 1, 2006	Jan. 1, 2007

<u>File Name</u>	<u>Special Provision Title</u>	<u>New Location</u>	<u>Effective</u>	<u>Revised</u>
80162	Uninterruptable Power Supply (UPS)	Sections 801, 862 and 1074	April 1, 2006	Jan. 1, 2007
80163	Water Blaster with Vacuum Recovery	Articles 783.02 and 1101.12	April 1, 2006	Jan. 1, 2007

The following special provisions require additional information from the designer. The additional information needs to be included in a separate document attached to this check sheet. The Project Development and Implementation section will then include the information in the applicable special provision. The Special Provisions are:

- Building Removal-Case I
- Building Removal-Case II
- Building Removal-Case III
- Building Removal-Case IV
- Completion Date
- Completion Date Plus Working Days
- DBE Participation
- Material Transfer Device
- Railroad Protective Liability Insurance
- Right-of-Entry Permit
- Training Special Provisions
- Working Days



The following Special Provisions supplement the "Standard Specifications for Road and Bridge Construction", Adopted January 1, 2007, the latest edition of the "Manual on Uniform Traffic Control Devices for Streets and Highways", and the "Manual of Test Procedures of Materials" in effect on the date of invitation of bids, and the Supplemental Specifications and Recurring Special Provisions indicated on the Check Sheet included here in which apply to and govern the construction of Locust Street, Section 09-00023-00-RS, and in case of conflict with any part, or parts, of said Specifications, the said Special Provisions shall take precedence and shall govern.

Description of Project

This project shall consist of rotomilling and resurfacing Locust Street from Sta. 5+35 (360' south of Ninth Street) to Sta. 27+25 (north radius return at Fifth Street) and will include Hot-Mix Asphalt Surface Removal, Bituminous Concrete Surface Course, and all incidental and collateral work necessary to complete this project. The Contractor shall provide flaggers, construction signs, barricades, and cones as necessary to protect construction personnel, pedestrians, and vehicular traffic. The cost to provide these protective measures shall be included with the various items of work being measured for payment.

PLACEMENT OF HOT-MIX ASPHALT SURFACE COURSES

Effective: March 22, 2001 Revised: January 1, 2007

Placement of hot-mix asphalt surface courses shall not be allowed after October 15th of any calendar year. The contractor is responsible for scheduling construction activities to complete placement of surface courses prior to October 15th. If surface courses are not in place by October 15th, the contractor is responsible for implementing any measures needed to make the roadway suitable for winter traffic and snow plowing activities. Any additional costs associated with this provision shall be considered included in the cost of the unit prices bid for hot-mix asphalt surface course items.

HOT-MIX ASPHALT SURFACE COURSE SURFACE TESTS

Effective: November 1, 2003 Revised January 1, 2007

The Contractor shall provide a person to operate the straight edge in accordance with Article 406.11 of the Standard Specifications and communicate with IDOT personnel to minimize the surface course bumps. If surface course bumps cannot be removed at this time, IDOT personnel will record the locations and provide deductions as stated in Article 406.11.

STATUS OF UTILITIES/UTILITIES TO BE ADJUSTED

Effective: January 21, 2005

The following utilities are located within the project limits. For relocations, the utility companies have provided the estimated dates.

Name, Contact, Address And Phone Number of Utility	Type	Location	Relocation Needed	Estimated Date Relocation Completed
City of Delavan 219 Locust St. Delavan, IL 61734	Sewer Water	Locust St.	No	N/A
AmerenCilco 300 Liberty St. Peoria, IL 61602	Electric	Locust St.	No	N/A

The above represents the best information of the Department and is only included for the convenience of the bidder. The applicable provisions of Recurring Special Provisions LRS1, LRS6 and Articles 105.07, 107.20, 107.31 and 108.02 of the Standard Specifications for Road and Bridge Construction shall apply.

The estimated utility relocation dates should be part of the progress schedule submitted by the Contractor. If any utility adjustments or relocations have not been completed by the above dates specified and when required by the Contractor's operations after these dates, the Contractor should notify the Engineer in writing. A request for an extension of time will be considered to the extent the Contractor's critical path schedule is affected.

State of Illinois
Department of Transportation
Bureau of Local Roads and Streets

SPECIAL PROVISION
FOR
INSURANCE

Effective: February 1, 2007
Revised: August 1, 2007

All references to Sections or Articles in this specification shall be construed to mean specific Section or Article of the Standard Specifications for Road and Bridge Construction, adopted by the Department of Transportation.

The Contractor shall name the following entities as additional insured under the Contractor's general liability insurance policy in accordance with Article 107.27:

City of Delavan

Crawford, Murphy & Tilly, Inc.

The entities listed above and their officers, employees, and agents shall be indemnified and held harmless in accordance with Article 107.26.

State of Illinois
DEPARTMENT OF TRANSPORTATION
Bureau of Local Roads & Streets

SPECIAL PROVISION
FOR
GROWTH CURVE

Effective: March 1, 2008

All references to Sections and Articles in this Special Provision shall be construed to mean specific Sections and Articles in the Standard Specifications for Road and Bridge Construction adopted by the Department of Transportation.

The Contractor shall perform a growth curve at the beginning of placement of each type of mix and each lift. The growth curve for each type of mix and each lift shall be performed within the first 200 tons (180 metric tons). If an adjustment is made to the specific mix design, the Engineer reserves the right to request an additional growth curve and supporting tests at the Contractor's expense.

Compaction of the growth curve shall commence immediately after the course is placed and at a temperature of not less than 280 °F (140 °C). The growth curve, consisting of a plot of lb/cu ft (kg/cu m) vs. number of passes with the project breakdown roller, shall be developed. Roller speed during the growth curve testing shall be the same as the normal paving operation. This curve shall be established by use of a nuclear gauge. Tests shall be taken after each pass until the highest lb/cu ft (kg/cu m) is obtained. This value shall be the target density provided the HMA Gyratory air voids are within acceptable limits. If the HMA Gyratory air voids are not within the specified limits, corrective action shall be taken, and a new target density shall be established.

A new growth curve is required if the breakdown roller used on the growth curve is replaced with a new roller during production. The target density shall apply only to the specific gauge used. If additional gauges are to be used to determine density specification compliance, the Contractor shall establish a unique minimum allowable target density from the growth curve location for each gauge.

At least one core sample per day shall be taken at a location specified by the Engineer. Core densities will be determined using the Illinois-Modified AASHTO T 166 or T 275 procedure by the Department. The core density shall be according to Articles 1030.05(d)(4) and (d)(7). The QA Manager is responsible for assuring and documenting that the determined number of roller passes has been accomplished. The Engineer reserves the right to take core samples at any time to verify density from the nuclear gauge,

All lifts shall be compacted to an average nuclear gauge density of not less than 95 percent nor greater than 102 percent of the target density obtained on the growth curve. The average nuclear gauge density shall be based on tests representing one day's production.

Quality Control density tests shall be performed at randomly selected locations within 1/2 mile (800 m) intervals per lift per lane. In no case shall more than one half day's production be completed without density testing being performed.

If the Contractor is not controlling the compaction process and is making no effort to take corrective action, the operation shall stop as directed by the Engineer.

AMERICAN RECOVERY AND REINVESTMENT ACT PROVISIONS (BDE)

Effective: April 1, 2009

Required Contract Provision to Implement ARRA Section 902:

Section 902 of the American Recovery and Reinvestment Act (ARRA) of 2009 requires that each contract awarded using ARRA funds allow the U.S. Comptroller General and his representatives with the authority to:

- “(1) to examine any records of the Contractor or any of its subcontractors, or any State or local agency administering such contract, that directly pertain to, and involve transactions relating to, the contract or subcontract; and
- (2) to interview any officer or employee of the Contractor or any of its subcontractors, or of any State or local government agency administering the contract, regarding such transactions.”

Accordingly, the Comptroller General and his representatives shall have the authority and rights as provided under Section 902 of the ARRA with respect to this contract, which is funded with funds made available under the ARRA. Section 902 further states that nothing in this section shall be interpreted to limit or restrict in any way any existing authority of the Comptroller General.

Notification of the Authority of the Inspector General:

Section 1515(a) of the ARRA provides authority for any representatives of the Inspector General to examine any records or interview any employee or officers working on this contract. The Contractor is advised that representatives of the inspector general have the authority to examine any record and interview any employee or officer of the Contractor, its subcontractors or other firms working on this contract. Section 1515(b) further provides that nothing in this section shall be interpreted to limit or restrict in any way any existing authority of an inspector general.

80243

AMERICAN RECOVERY AND REINVESTMENT ACT SIGNING (BDE)

Effective: April 1, 2009

Revised: April 15, 2009

Description. This work shall consist of furnishing, fabricating and installing sign panels, complete with sign faces, legend, and supplemental panels according to Section 720 of the Standard Specifications and as specified herein.

Materials. The "Putting America to Work" sign shall be fabricated using Type AA or AZ fluorescent orange sheeting for the background material with black vinyl or black opaque ink legend, symbol and borders. The "American Recovery and Reinvestment Act" sign shall be fabricated using Type AP green sheeting for the background with Type AP white sheeting for the legend and border. A green translucent overlay film may also be used over white Type AP sheeting to fabricate the "American Recovery and Reinvestment Act" sign.

Sign Layout. See following attachment. The "Putting America to Work" sign shall be 84 in. x 18 in. The "American Recovery and Reinvestment Act" sign shall be 84 in x 60 in.

General. The signs shall be erected to applicable portions of Article 701.14 of the Standard Specifications. These signs shall be erected midway between the first and second warning signs as required by the traffic control plan and standards utilized for this project. If the second warning sign is defining a moving or intermittent operation, the sign may be maintained at a distance of 500 ft (150 m) beyond the first post mounted ROAD CONSTRUCTION AHEAD sign. The signs shall remain in place for the duration of the project. Upon completion of the project, the signs and posts shall be removed and shall remain the property of the Contractor.

Basis of Payment. This work will not be paid for separately but shall be included in the cost of Traffic Control items as shown on the plans.

80236

**PROJECT FUNDING SOURCE SIGN ASSEMBLY
AMERICAN RECOVERY AND REINVESTMENT ACT
SIGN LAYOUT DETAILS**



PROJECT FUNDING SOURCE
SIGN ASSEMBLY

PROJECT FUNDING SOURCE SIGN ASSEMBLY AMERICAN RECOVERY AND REINVESTMENT ACT SIGN LAYOUT DETAILS

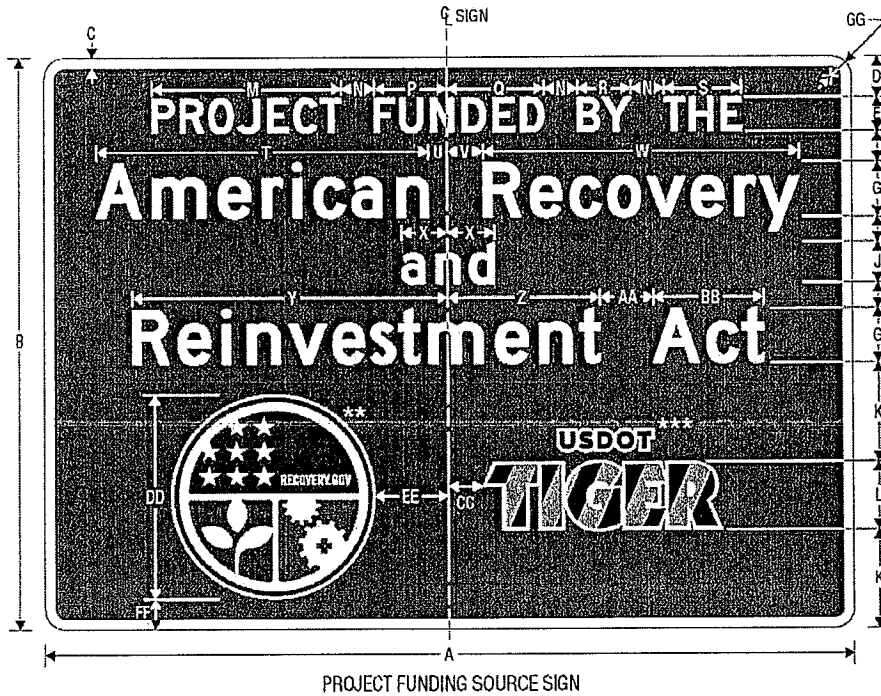

NOTE: SIGN SHALL NOT BE INSTALLED WITHOUT PROJECT FUNDING SOURCE PLAQUE

Dimensions in inches

A	B	C	D	E	F	G	H	J	K	L	M	N	P
120	84	1.5	6	5 D	4.5	8 D*	3.75	6 D (45 LC)	14.5	10	27.917	5	10.831
84	60	1	5	4 C	3.5	6 C*	3	4 D (3 LC)	9.25	7	19.047	4	7.362

Q	R	S	T	U	V	W	X	Y	Z	AA	BB	CC	DD
14.087	8.106	11.556	49.42	2.742	5.258	46.904	6.812	46.76	22.472	8	16.288	5	30
9.484	5.162	7.763	31.722	2.415	3.585	30.552	4.542	30.911	14.737	6	10.175	4	21

EE	FF	GG
11	4.5	3
7.5	2.25	2.25

* Increase character spacing 50%
** See Pictograph
*** See Pictograph

COLORS: LEGEND, BORDER - WHITE (RETROREFLECTIVE)
BACKGROUND - GREEN (RETROREFLECTIVE)

PROJECT FUNDING SOURCE SIGN ASSEMBLY AMERICAN RECOVERY AND REINVESTMENT ACT SIGN LAYOUT DETAILS

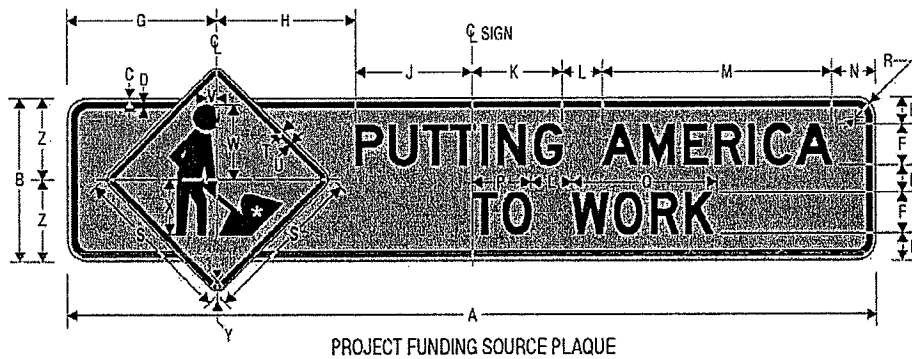

NOTE: PLAQUE SHALL NOT BE INSTALLED
WITHOUT SIGN

* See *Standard Highway Signs*
Page 6-59 for symbol design.

Dimensions in inches

A	B	C	D	E	F	G	H	J	K	L	M	N	P
120	24	0.625	0.875	4	6 D	22.349	20.370	17.281	13.28	6	34.22	6.5	8.765
84	18	0.375	0.625	3.5	4 D	16.607	15.686	9.707	10.667	4	22.813	5	5.843

Q	R	S	T	U	V	W	X	Y	Z
21.013	3	24	0.375	0.625	1.5	11	8	1.5	12
14.009	2.25	18	0.375	0.625	1	7	6	1.5	9

COLORS: LEGEND, BORDER — BLACK
BACKGROUND — ORANGE (RETROREFLECTIVE)

**PROJECT FUNDING SOURCE SIGN ASSEMBLY
AMERICAN RECOVERY AND REINVESTMENT ACT
SIGN LAYOUT DETAILS**



RECOVERY
Vector-Based, Vinyl-Ready Pictograph

COLORS: LEGEND, OUTLINE	- WHITE (RETROREFLECTIVE)
BORDER	- BLUE (RETROREFLECTIVE)
BACKGROUND (UPPER)	- BLUE (RETROREFLECTIVE)
BACKGROUND (LOWER RIGHT)	- RED (RETROREFLECTIVE)
BACKGROUND (LOWER LEFT)	- GREEN (RETROREFLECTIVE)

**PROJECT FUNDING SOURCE SIGN ASSEMBLY
AMERICAN RECOVERY AND REINVESTMENT ACT
SIGN LAYOUT DETAILS**

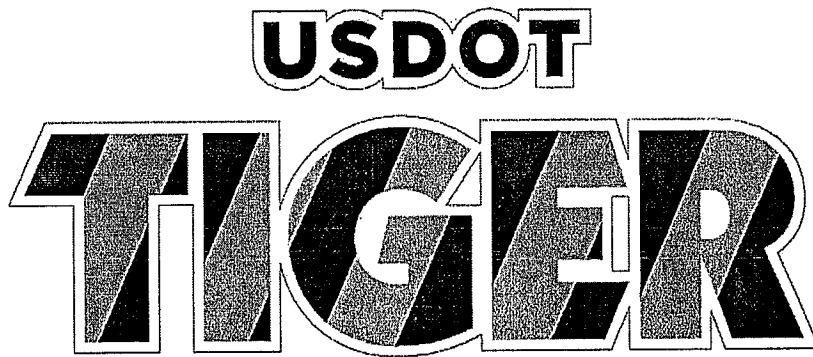

USDOT TIGER
Vector-Based, Vinyl-Ready Pictograph

COLORS: OUTLINE - WHITE (RETROREFLECTIVE)
USDOT LEGEND - BLACK
TIGER DIAGONALS - BLACK,
ORANGE (RETROREFLECTIVE)

**APPROVAL OF PROPOSED BORROW AREAS, USE AREAS, AND/OR WASTE AREAS
INSIDE ILLINOIS STATE BORDERS (BDE)**

Effective: November 1, 2008

Revise the title of Article 107.22 of the Standard Specifications to read:

"107.22 Approval of Proposed Borrow Areas, Use Areas, and/or Waste Areas Inside Illinois State Borders."

Add the following sentence to the end of the first paragraph of Article 107.22 of the Standard Specifications:

"Proposed borrow areas, use areas, and/or waste areas outside of Illinois shall comply with Article 107.01."

80207

BITUMINOUS MATERIALS COST ADJUSTMENTS (BDE) (RETURN FORM WITH BID)

Effective: November 2, 2006

Revised: April 1, 2009

Description. Bituminous material cost adjustments will be made to provide additional compensation to the Contractor, or credit to the Department, for fluctuations in the cost of bituminous materials when optioned by the Contractor. The adjustments shall apply to permanent and temporary hot-mix asphalt (HMA) mixtures, bituminous surface treatments (cover and seal coats), and pavement preservation type surface treatments. The adjustments shall not apply to bituminous prime coats, tack coats, crack filling/sealing, or joint filling/sealing.

The bidder shall indicate on the attached form whether or not this special provision will be part of the contract and submit the completed form with his/her bid. Failure to submit the form, or failure to fill out the form completely, shall make this contract exempt of bituminous materials cost adjustments.

Method of Adjustment. Bituminous materials cost adjustments will be computed as follows.

$$CA = (BPI_P - BPI_L) \times (\%AC_V / 100) \times Q$$

Where: CA = Cost Adjustment, \$.

BPI_P = Bituminous Price Index, as published by the Department for the month the work is performed, \$/ton (\$/metric ton).

BPI_L = Bituminous Price Index, as published by the Department for the month prior to the letting, \$/ton (\$/metric ton).

%AC_V = Percent of virgin Asphalt Cement in the Quantity being adjusted. For HMA mixtures, the % AC_V will be determined from the adjusted job mix formula. For bituminous materials applied, a performance graded or cutback asphalt will be considered to be 100% AC_V and undiluted emulsified asphalt will be considered to be 65% AC_V.

Q = Authorized construction Quantity, tons (metric tons) (see below).

For HMA mixtures measured in square yards: $Q, \text{ tons} = A \times D \times (G_{mb} \times 46.8) / 2000$. For HMA mixtures measured in square meters: $Q, \text{ metric tons} = A \times D \times (G_{mb} \times 24.99) / 1000$. When computing adjustments for full-depth HMA pavement, separate calculations will be made for the binder and surface courses to account for their different G_{mb} and % AC_V.

For bituminous materials measured in gallons: $Q, \text{ tons} = V \times 8.33 \text{ lb/gal} \times SG / 2000$

For bituminous materials measured in liters: $Q, \text{ metric tons} = V \times 1.0 \text{ kg/L} \times SG / 1000$

Where: A = Area of the HMA mixture, sq yd (sq m).

D = Depth of the HMA mixture, in. (mm).

G_{mb} = Average bulk specific gravity of the mixture, from the approved mix design.

V = Volume of the bituminous material, gal (L).

SG = Specific Gravity of bituminous material as shown on the bill of lading.

Basis of Payment. Bituminous materials cost adjustments may be positive or negative but will only be made when there is a difference between the BPI_L and BPI_P in excess of five percent, as calculated by:

$$\text{Percent Difference} = \{(BPI_L - BPI_P) \div BPI_L\} \times 100$$

Bituminous materials cost adjustments will be calculated for each calendar month in which applicable bituminous material is placed; and will be paid or deducted when all other contract requirements for the work placed during the month are satisfied. The adjustments shall not apply during contract time subject to liquidated damages for completion of the entire contract.

Return With Bid

**ILLINOIS DEPARTMENT
OF TRANSPORTATION**

**OPTION FOR
BITUMINOUS MATERIALS COST ADJUSTMENTS**

The bidder shall submit this completed form with his/her bid. Failure to submit the form, or failure to fill out the form completely, shall make this contract exempt of bituminous materials cost adjustments. After award, this form, when submitted, shall become part of the contract.

Contract No.: _____

Company Name: _____

Contractor's Option:

Is your company opting to include this special provision as part of the contract?

Yes No

Signature: _____ **Date:** _____

80173

CONSTRUCTION AIR QUALITY - DIESEL VEHICLE EMISSIONS CONTROL (BDE)

Effective: April 1, 2009

Revised: July 1, 2009

Diesel Vehicle Emissions Control. The reduction of construction air emissions shall be accomplished by using cleaner burning diesel fuel. The term "equipment" refers to any and all diesel fuel powered devices rated at 50 hp and above, to be used on the project site in excess of seven calendar days over the course of the construction period on the project site (including any "rental" equipment).

All equipment on the jobsite, with engine ratings of 50 hp and above, shall be required to: use Ultra Low Sulfur Diesel fuel (ULSD) exclusively (15 ppm sulfur content or less).

Diesel powered equipment in non-compliance will not be allowed to be used on the project site, and is also subject to a notice of non-compliance as outlined below.

The Contractor shall submit copies of monthly summary reports and include certified copies of the ULSD diesel fuel delivery slips for diesel fuel delivered to the jobsite for the reporting time period, noting the quantity of diesel fuel used.

If any diesel powered equipment is found to be in non-compliance with any portion of this specification, the Engineer will issue the Contractor a notice of non-compliance and identify an appropriate period of time, as outlined below under environmental deficiency deduction, in which to bring the equipment into compliance or remove it from the project site.

Any costs associated with bringing any diesel powered equipment into compliance with these diesel vehicle emissions controls shall be considered as included in the contract unit prices bid for the various items of work involved and no additional compensation will be allowed. The Contractor's compliance with this notice and any associated regulations shall also not be grounds for a claim.

Environmental Deficiency Deduction. When the Engineer is notified, or determines that an environmental control deficiency exists, he/she will notify the Contractor in writing, and direct the Contractor to correct the deficiency within a specified time period. The specified time-period, which begins upon Contractor notification, will be from 1/2 hour to 24 hours long, based on the urgency of the situation and the nature of the deficiency. The Engineer shall be the sole judge regarding the time period.

The deficiency will be based on lack of repair, maintenance and diesel vehicle emissions control.

If the Contractor fails to correct the deficiency within the specified time frame, a daily monetary deduction will be imposed for each calendar day or fraction thereof the deficiency continues to exist. The calendar day(s) will begin when the time period for correction is exceeded and end

with the Engineer's written acceptance of the correction. The daily monetary deduction will be \$1,000.00 for each deficiency identified.

If a Contractor or subcontractor accumulates three environmental deficiency deductions in a contract period, the Contractor will be shutdown until the deficiency is corrected. Such a shutdown will not be grounds for any extension of contract time, waiver of penalties, or be grounds for any claim.

80237

CONSTRUCTION AIR QUALITY - IDLING RESTRICTIONS (BDE)

Effective: April 1, 2009

Idling Restrictions. The Contractor shall establish truck-staging areas for all diesel powered vehicles that are waiting to load or unload material at the jobsite. Staging areas shall be located where the diesel emissions from the equipment will have a minimum impact on adjacent sensitive receptors. The Department will review the selection of staging areas, whether within or outside the existing highway right-of-way, to avoid locations near sensitive areas or populations to the extent possible. Sensitive receptors include, but are not limited to, hospitals, schools, residences, motels, hotels, daycare facilities, elderly housing and convalescent facilities. Diesel powered engines shall also be located as far away as possible from fresh air intakes, air conditioners, and windows. The Engineer will approve staging areas before implementation.

Diesel powered vehicle operators may not cause or allow the motor vehicle, when it is not in motion, to idle for more than a total of 10 minutes within any 60 minute period, except under any of the following circumstances:

- 1) The motor vehicle has a gross vehicle weight rating of less than 8000 lb (3630 kg).
- 2) The motor vehicle idles while forced to remain motionless because of on-highway traffic, an official traffic control device or signal, or at the direction of a law enforcement official.
- 3) The motor vehicle idles when operating defrosters, heaters, air conditioners, or other equipment solely to prevent a safety or health emergency.
- 4) A police, fire, ambulance, public safety, other emergency or law enforcement motor vehicle, or any motor vehicle used in an emergency capacity, idles while in an emergency or training mode and not for the convenience of the vehicle operator.
- 5) The primary propulsion engine idles for maintenance, servicing, repairing, or diagnostic purposes if idling is necessary for such activity.
- 6) A motor vehicle idles as part of a government inspection to verify that all equipment is in good working order, provided idling is required as part of the inspection.
- 7) When idling of the motor vehicle is required to operate auxiliary equipment to accomplish the intended use of the vehicle (such as loading, unloading, mixing, or processing cargo; controlling cargo temperature; construction operations, lumbering operations; oil or gas well servicing; or farming operations), provided that this exemption does not apply when the vehicle is idling solely for cabin comfort or to operate non-essential equipment such as air conditioning, heating, microwave ovens, or televisions.
- 8) When the motor vehicle idles due to mechanical difficulties over which the operator has no control.
- 9) The outdoor temperature is less than 32 °F (0 °C) or greater than 80 °F (26 °C).

When the outdoor temperature is greater than or equal to 32 °F (0 °C) or less than or equal to 80 °F (26 °C), a person who operates a motor vehicle operating on diesel fuel shall not cause or allow the motor vehicle to idle for a period greater than 30 minutes in any 60 minute period while waiting to weigh, load, or unload cargo or freight, unless the vehicle is in a line of vehicles that regularly and periodically moves forward.

The above requirements do not prohibit the operation of an auxiliary power unit or generator set as an alternative to idling the main engine of a motor vehicle operating on diesel fuel.

Environmental Deficiency Deduction. When the Engineer is notified, or determines that an environmental control deficiency exists based on non-compliance with the idling restrictions, he/she will notify the Contractor, and direct the Contractor to correct the deficiency.

If the Contractor fails to correct the deficiency a monetary deduction will be imposed. The monetary deduction will be \$1,000.00 for each deficiency identified.

80239

DISADVANTAGED BUSINESS ENTERPRISE PARTICIPATION (DBE)

Effective: September 1, 2000

Revised: November 1, 2008

FEDERAL OBLIGATION. The Department of Transportation, as a recipient of federal financial assistance, is required to take all necessary and reasonable steps to ensure nondiscrimination in the award and administration of contracts. Consequently, the federal regulatory provisions of 49 CFR part 26 apply to this contract concerning the utilization of disadvantaged business enterprises. For the purposes of this Special Provision, a disadvantaged business enterprise (DBE) means a business certified by the Department in accordance with the requirements of 49 CFR part 26 and listed in the Illinois Unified Certification Program (IL UCP) DBE Directory or most recent addendum.

STATE OBLIGATION. This Special Provision will also be used by the Department to satisfy the requirements of the Business Enterprise for Minorities, Females, and Persons with Disabilities Act, 30 ILCS 575. When this Special Provision is used to satisfy state law requirements on 100 percent state-funded contracts, the federal government has no involvement in such contracts (not a federal-aid contract) and no responsibility to oversee the implementation of this Special Provision by the Department on those contracts. DBE participation on 100 percent state-funded contracts will not be credited toward fulfilling the Department's annual overall DBE goal required by the US Department of Transportation to comply with the federal DBE program requirements.

CONTRACTOR ASSURANCE. The Contractor makes the following assurance and agrees to include the assurance in each subcontract that the Contractor signs with a subcontractor:

The Contractor, subrecipient, or subcontractor shall not discriminate on the basis of race, color, national origin, or sex in the performance of this contract. The Contractor shall carry out applicable requirements of 49 CFR part 26 in the award and administration of contracts funded in whole or in part with federal or state funds. Failure by the Contractor to carry out these requirements is a material breach of this contract, which may result in the termination of this contract or such other remedy as the recipient deems appropriate.

OVERALL GOAL SET FOR THE DEPARTMENT. As a requirement of compliance with 49 CFR part 26, the Department has set an overall goal for DBE participation in its federally assisted contracts. That goal applies to all federal-aid funds the Department will expend in its federally assisted contracts for the subject reporting fiscal year. The Department is required to make a good faith effort to achieve the overall goal. The dollar amount paid to all approved DBE companies performing work called for in this contract is eligible to be credited toward fulfillment of the Department's overall goal.

CONTRACT GOAL TO BE ACHIEVED BY THE CONTRACTOR. This contract includes a specific DBE utilization goal established by the Department. The goal has been included because the Department has determined that the work of this contract has subcontracting opportunities that may be suitable for performance by DBE companies. This determination is

based on an assessment of the type of work, the location of the work, and the availability of DBE companies to do a part of the work. The assessment indicates that, in the absence of unlawful discrimination, and in an arena of fair and open competition, DBE companies can be expected to perform 0% of the work. This percentage is set as the DBE participation goal for this contract. Consequently, in addition to the other award criteria established for this contract, the Department will award this contract to a bidder who makes a good faith effort to meet this goal of DBE participation in the performance of the work. A bidder makes a good faith effort for award consideration if either of the following is done in accordance with the procedures set forth in this Special Provision:

- (a) The bidder documents that firmly committed DBE participation has been obtained to meet the goal; or
- (b) The bidder documents that a good faith effort has been made to meet the goal, even though the effort did not succeed in obtaining enough DBE participation to meet the goal.

DBE LOCATOR REFERENCES. Bidders may consult the IL UCP DBE Directory as a reference source for DBE-certified companies. In addition, the Department maintains a letting and item specific DBE locator information system whereby DBE companies can register their interest in providing quotes on particular bid items advertised for letting. Information concerning DBE companies willing to quote work for particular contracts may be obtained by contacting the Department's Bureau of Small Business Enterprises at telephone number (217)785-4611, or by visiting the Department's web site at www.dot.il.gov.

BIDDING PROCEDURES. Compliance with the bidding procedures of this Special Provision is required prior to the award of the contract and the failure of the as-read low bidder to comply will render the bid not responsive.

- (a) In order to assure the timely award of the contract, the as-read low bidder shall submit a Disadvantaged Business Utilization Plan on Department form SBE 2026 within seven working days after the date of letting. To meet the seven day requirement, the bidder may send the Plan by certified mail or delivery service within the seven working day period. If a question arises concerning the mailing date of a Plan, the mailing date will be established by the U.S. Postal Service postmark on the original certified mail receipt from the U.S. Postal Service or the receipt issued by a delivery service. It is the responsibility of the bidder to ensure that the postmark or receipt date is affixed within the seven working days if the bidder intends to rely upon mailing or delivery to satisfy the submission day requirement. The Plan is to be submitted to the Department of Transportation, Bureau of Small Business Enterprises, Contract Compliance Section, 2300 South Dirksen Parkway, Room 319, Springfield, Illinois 62764 (Telefax: (217)785-1524). It is the responsibility of the bidder to obtain confirmation of telefax delivery. The Department will not accept a Utilization Plan if it does not meet the seven day submittal requirement and the bid will be declared not responsive. In the event the bid is declared not responsive due to a failure to submit a Plan or failure to comply with the bidding procedures set forth herein, the Department may elect to cause the forfeiture of the

penal sum of the bidder's proposal guaranty, and may deny authorization to bid the project if re-advertised for bids. The Department reserves the right to invite any other bidder to submit a Utilization Plan at any time for award consideration or to extend the time for award.

- (b) The Utilization Plan shall indicate that the bidder either has obtained sufficient DBE participation commitments to meet the contract goal or has not obtained enough DBE participation commitments in spite of a good faith effort to meet the goal. The Utilization Plan shall further provide the name, telephone number, and telefax number of a responsible official of the bidder designated for purposes of notification of plan approval or disapproval under the procedures of this Special Provision.
- (c) The Utilization Plan shall include a DBE Participation Commitment Statement, Department form SBE 2025, for each DBE proposed for the performance of work to achieve the contract goal. The signatures on these forms must be original signatures. All elements of information indicated on the said form shall be provided, including but not limited to the following:
 - (1) The name and address of each DBE to be used;
 - (2) A description, including pay item numbers, of the commercially useful work to be done by each DBE;
 - (3) The price to be paid to each DBE for the identified work specifically stating the quantity, unit price, and total subcontract price for the work to be completed by the DBE. If partial pay items are to be performed by the DBE, indicate the portion of each item, a unit price where appropriate and the subcontract price amount;
 - (4) A commitment statement signed by the bidder and each DBE evidencing availability and intent to perform commercially useful work on the project; and
 - (5) If the bidder is a joint venture comprised of DBE companies and non-DBE companies, the plan must also include a clear identification of the portion of the work to be performed by the DBE partner(s).
- (d) The contract will not be awarded until the Utilization Plan submitted by the bidder is approved. The Utilization Plan will be approved by the Department if the Plan commits sufficient commercially useful DBE work performance to meet the contract goal. The Utilization Plan will not be approved by the Department if the Plan does not commit sufficient DBE performance to meet the contract goal unless the bidder documents that it made a good faith effort to meet the goal. The good faith procedures of Section VIII of this special provision apply. If the Utilization Plan is not approved because it is deficient in a technical matter, unless waived by the Department, the bidder will be notified and will be allowed no less than a five working day period in order to cure the deficiency.

CALCULATING DBE PARTICIPATION. The Utilization Plan values represent work anticipated to be performed and paid for upon satisfactory completion. The Department is only able to count toward the achievement of the overall goal and the contract goal the value of payments made for the work actually performed by DBE companies. In addition, a DBE must perform a commercially useful function on the contract to be counted. A commercially useful function is generally performed when the DBE is responsible for the work and is carrying out its responsibilities by actually performing, managing, and supervising the work involved. The Department and Contractor are governed by the provisions of 49 CFR part 26.55(c) on questions of commercially useful functions as it affects the work. Specific counting guidelines are provided in 49 CFR part 26.55, the provisions of which govern over the summary contained herein.

- (a) DBE as the Contractor: 100 percent goal credit for that portion of the work performed by the DBE's own forces, including the cost of materials and supplies. Work that a DBE subcontracts to a non-DBE does not count toward the DBE goals.
- (b) DBE as a joint venture Contractor: 100 percent goal credit for that portion of the total dollar value of the contract equal to the distinct, clearly defined portion of the work performed by the DBE's own forces.
- (c) DBE as a subcontractor: 100 percent goal credit for the work of the subcontract performed by the DBE's own forces, including the cost of materials and supplies, excluding the purchase of materials and supplies or the lease of equipment by the DBE subcontractor from the prime Contractor or its affiliates. Work that a DBE subcontractor in turn subcontracts to a non-DBE does not count toward the DBE goal.
- (d) DBE as a trucker: 100 percent goal credit for trucking participation provided the DBE is responsible for the management and supervision of the entire trucking operation for which it is responsible. At least one truck owned, operated, licensed, and insured by the DBE must be used on the contract. Credit will be given for the full value of all such DBE trucks operated using DBE employed drivers. Goal credit will be limited to the value of the reasonable fee or commission received by the DBE if trucks are leased from a non-DBE company.
- (e) DBE as a material supplier:
 - (1) 60 percent goal credit for the cost of the materials or supplies purchased from a DBE regular dealer.
 - (2) 100 percent goal credit for the cost of materials or supplies obtained from a DBE manufacturer.
 - (3) 100 percent credit for the value of reasonable fees and commissions for the procurement of materials and supplies if not a regular dealer or manufacturer.

GOOD FAITH EFFORT PROCEDURES. If the bidder cannot obtain sufficient DBE commitments to meet the contract goal, the bidder must document in the Utilization Plan the good faith efforts made in the attempt to meet the goal. This means that the bidder must show that all necessary and reasonable steps were taken to achieve the contract goal. Necessary and reasonable steps are those which could reasonably be expected to obtain sufficient DBE participation. The Department will consider the quality, quantity, and intensity of the kinds of efforts that the bidder has made. Mere *pro forma* efforts are not good faith efforts; rather, the bidder is expected to have taken those efforts that would be reasonably expected of a bidder actively and aggressively trying to obtain DBE participation sufficient to meet the contract goal.

- (a) The following is a list of types of action that the Department will consider as part of the evaluation of the bidder's good faith efforts to obtain participation. These listed factors are not intended to be a mandatory checklist and are not intended to be exhaustive. Other factors or efforts brought to the attention of the Department may be relevant in appropriate cases, and will be considered by the Department.
- (1) Soliciting through all reasonable and available means (e.g. attendance at pre-bid meetings, advertising and/or written notices) the interest of all certified DBE companies that have the capability to perform the work of the contract. The bidder must solicit this interest within sufficient time to allow the DBE companies to respond to the solicitation. The bidder must determine with certainty if the DBE companies are interested by taking appropriate steps to follow up initial solicitations.
 - (2) Selecting portions of the work to be performed by DBE companies in order to increase the likelihood that the DBE goals will be achieved. This includes, where appropriate, breaking out contract work items into economically feasible units to facilitate DBE participation, even when the prime Contractor might otherwise prefer to perform these work items with its own forces.
 - (3) Providing interested DBE companies with adequate information about the plans, specifications, and requirements of the contract in a timely manner to assist them in responding to a solicitation.
 - (4) a. Negotiating in good faith with interested DBE companies. It is the bidder's responsibility to make a portion of the work available to DBE subcontractors and suppliers and to select those portions of the work or material needs consistent with the available DBE subcontractors and suppliers, so as to facilitate DBE participation. Evidence of such negotiation includes the names, addresses, and telephone numbers of DBE companies that were considered; a description of the information provided regarding the plans and specifications for the work selected for subcontracting; and evidence as to why additional agreements could not be reached for DBE companies to perform the work.

b. A bidder using good business judgment would consider a number of factors in negotiating with subcontractors, including DBE subcontractors, and would take a firm's price and capabilities as well as contract goals into consideration. However, the fact that there may be some additional costs involved in finding and

using DBE companies is not in itself sufficient reason for a bidder's failure to meet the contract DBE goal, as long as such costs are reasonable. Also, the ability or desire of a bidder to perform the work of a contract with its own organization does not relieve the bidder of the responsibility to make good faith efforts. Bidders are not, however, required to accept higher quotes from DBE companies if the price difference is excessive or unreasonable.

- (5) Not rejecting DBE companies as being unqualified without sound reasons based on a thorough investigation of their capabilities. The bidder's standing within its industry, membership in specific groups, organizations, or associations and political or social affiliations (for example union vs. non-union employee status) are not legitimate causes for the rejection or non-solicitation of bids in the bidder's efforts to meet the project goal.
 - (6) Making efforts to assist interested DBE companies in obtaining bonding, lines of credit, or insurance as required by the recipient or Contractor.
 - (7) Making efforts to assist interested DBE companies in obtaining necessary equipment, supplies, materials, or related assistance or services.
 - (8) Effectively using the services of available minority/women community organizations; minority/women contractors' groups; local, state, and federal minority/women business assistance offices; and other organizations as allowed on a case-by-case basis to provide assistance in the recruitment and placement of DBE companies.
- (b) If the Department determines that the bidder has made a good faith effort to secure the work commitment of DBE companies to meet the contract goal, the Department will award the contract provided that it is otherwise eligible for award. If the Department determines that a good faith effort has not been made, the Department will notify the bidder of that preliminary determination by contacting the responsible company official designated in the Utilization Plan. The preliminary determination shall include a statement of reasons why good faith efforts have not been found, and may include additional good faith efforts that the bidder could take. The notification will designate a five working day period during which the bidder shall take additional efforts. The bidder is not limited by a statement of additional efforts, but may take other action beyond any stated additional efforts in order to obtain additional DBE commitments. The bidder shall submit an amended Utilization Plan if additional DBE commitments to meet the contract goal are secured. If additional DBE commitments sufficient to meet the contract goal are not secured, the bidder shall report the final good faith efforts made in the time allotted. All additional efforts taken by the bidder will be considered as part of the bidder's good faith efforts. If the bidder is not able to meet the goal after taking additional efforts, the Department will make a pre-final determination of the good faith efforts of the bidder and will notify the designated responsible company official of the reasons for an adverse determination.
- (c) The bidder may request administrative reconsideration of a pre-final determination adverse to the bidder within the five working days after the notification date of the

determination by delivering the request to the Department of Transportation, Bureau of Small Business Enterprises, Contract Compliance Section, 2300 South Dirksen Parkway, Room 319, Springfield, Illinois 62764 (Telefax: (217)785-1524). Deposit of the request in the United States mail on or before the fifth business day shall not be deemed delivery. The pre-final determination shall become final if a request is not made and delivered. A request may provide additional written documentation and/or argument concerning the issue of whether an adequate good faith effort was made to meet the contract goal. In addition, the request shall be considered a consent by the bidder to extend the time for award. The request will be forwarded to the Department's Reconsideration Officer. The Reconsideration Officer will extend an opportunity to the bidder to meet in person in order to consider all issues of whether the bidder made a good faith effort to meet the goal. After the review by the Reconsideration Officer, the bidder will be sent a written decision within ten working days after receipt of the request for reconsideration, explaining the basis for finding that the bidder did or did not meet the goal or make adequate good faith efforts to do so. A final decision by the Reconsideration Officer that a good faith effort was made shall approve the Utilization Plan submitted by the bidder and shall clear the contract for award. A final decision that a good faith effort was not made shall render the bid not responsive.

CONTRACT COMPLIANCE. Compliance with this Special Provision is an essential part of the contract. The Department is prohibited by federal regulations from crediting the participation of a DBE included in the Utilization Plan toward either the contract goal or the Department's overall goal until the amount to be applied toward the goals has been paid to the DBE. The following administrative procedures and remedies govern the compliance by the Contractor with the contractual obligations established by the Utilization Plan. After approval of the Plan and award of the contract, the Utilization Plan and individual DBE Participation Statements become part of the contract. If the Contractor did not succeed in obtaining enough DBE participation to achieve the advertised contract goal, and the Utilization Plan was approved and contract awarded based upon a determination of good faith, the total dollar value of DBE work calculated in the approved Utilization Plan as a percentage of the awarded contract value shall become the amended contract goal.

- (a) No amendment to the Utilization Plan may be made without prior written approval from the Department's Bureau of Small Business Enterprises. All requests for amendment to the Utilization Plan shall be submitted to the Department of Transportation, Bureau of Small Business Enterprises, Contract Compliance Section, 2300 South Dirksen Parkway, Room 319, Springfield, Illinois 62764. Telephone number (217) 785-4611. Telefax number (217) 785-1524.
- (b) All work indicated for performance by an approved DBE shall be performed, managed, and supervised by the DBE executing the Participation Statement. The Contractor shall not terminate for convenience a DBE listed in the Utilization Plan and then perform the work of the terminated DBE with its own forces, those of an affiliate or those of another subcontractor, whether DBE or not, without first obtaining the written consent of the Bureau of Small Business Enterprises to amend the Utilization Plan. If a DBE listed in the Utilization Plan is terminated for reasons other than convenience, or fails to complete its work on the contract for any reason, the Contractor shall make good faith efforts to

find another DBE to substitute for the terminated DBE. The good faith efforts shall be directed at finding another DBE to perform at least the same amount of work under the contract as the DBE that was terminated, but only to the extent needed to meet the contract goal or the amended contract goal. The Contractor shall notify the Bureau of Small Business Enterprises of any termination for reasons other than convenience, and shall obtain approval for inclusion of the substitute DBE in the Utilization Plan. If good faith efforts following a termination of a DBE for cause are not successful, the Contractor shall contact the Bureau of Small Business Enterprises and provide a full accounting of the efforts undertaken to obtain substitute DBE participation. The Bureau of Small Business Enterprises will evaluate the good faith efforts in light of all circumstances surrounding the performance status of the contract, and determine whether the contract goal should be amended.

- (c) The Contractor shall maintain a record of payments for work performed to the DBE participants. The records shall be made available to the Department for inspection upon request. After the performance of the final item of work or delivery of material by a DBE and final payment therefor to the DBE by the Contractor, but not later than thirty calendar days after payment has been made by the Department to the Contractor for such work or material, the Contractor shall submit a DBE Payment Agreement on Department form SBE 2115 to the Regional Engineer. If full and final payment has not been made to the DBE, the DBE Payment Agreement shall indicate whether a disagreement as to the payment required exists between the Contractor and the DBE or if the Contractor believes that the work has not been satisfactorily completed. If the Contractor does not have the full amount of work indicated in the Utilization Plan performed by the DBE companies indicated in the Plan, the Department will deduct from contract payments to the Contractor the amount of the goal not achieved as liquidated and ascertained damages.
- (d) The Department reserves the right to withhold payment to the Contractor to enforce the provisions of this Special Provision. Final payment shall not be made on the contract until such time as the Contractor submits sufficient documentation demonstrating achievement of the goal in accordance with this Special Provision or after liquidated damages have been determined and collected.
- (e) Notwithstanding any other provision of the contract, including but not limited to Article 109.09 of the Standard Specifications, the Contractor may request administrative reconsideration of a decision to deduct the amount of the goal not achieved as liquidated damages. A request to reconsider shall be delivered to the Contract Compliance Section and shall be handled and considered in the same manner as set forth in paragraph (c) of "Good Faith Effort Procedures" of this Special Provision, except a final decision that a good faith effort was not made during contract performance to achieve the goal agreed to in the Utilization Plan shall be the final administrative decision of the Department.

EQUIPMENT RENTAL RATES (BDE)

Effective: August 2, 2007

Revised: January 2, 2008

Replace the second and third paragraphs of Article 105.07(b)(4)a. of the Standard Specifications with the following:

“Equipment idled which cannot be used on other work, and which is authorized to standby on the project site by the Engineer, will be paid for according to Article 109.04(b)(4).”

Replace Article 109.04(b)(4) of the Standard Specifications with the following:

“(4) Equipment. Equipment used for extra work shall be authorized by the Engineer. The equipment shall be specifically described, be of suitable size and capacity for the work to be performed, and be in good operating condition. For such equipment, the Contractor will be paid as follows.

- a. Contractor Owned Equipment. Contractor owned equipment will be paid for by the hour using the applicable FHWA hourly rate from the “Equipment Watch Rental Rate Blue Book” (Blue Book) in effect when the force account work begins. The FHWA hourly rate is calculated as follows.

$$\text{FHWA hourly rate} = (\text{monthly rate}/176) \times (\text{model year adj.}) \times (\text{Illinois adj.}) + \text{EOC}$$

Where: EOC = Estimated Operating Costs per hour (from the Blue Book)

The time allowed will be the actual time the equipment is operating on the extra work. For the time required to move the equipment to and from the site of the extra work and any authorized idle (standby) time, payment will be made at the following hourly rate: $0.5 \times (\text{FHWA hourly rate} - \text{EOC})$.

All time allowed shall fall within the working hours authorized for the extra work.

The rates above include the cost of fuel, oil, lubrication, supplies, small tools, necessary attachments, repairs, overhaul and maintenance of any kind, depreciation, storage, overhead, profits, insurance, and all incidentals. The rates do not include labor.

The Contractor shall submit to the Engineer sufficient information for each piece of equipment and its attachments to enable the Engineer to determine the proper equipment category. If a rate is not established in the Blue Book for a particular piece of equipment, the Engineer will establish a rate for that piece of equipment that is consistent with its cost and use in the industry.

- b. Rented Equipment. Whenever it is necessary for the Contractor to rent equipment to perform extra work, the rental and transportation costs of the equipment plus five percent for overhead will be paid. In no case shall the rental rates exceed those of established distributors or equipment rental agencies.

All prices shall be agreed to in writing before the equipment is used.”

80189

FLAGGER AT SIDE ROADS AND ENTRANCES (BDE)

Effective: April 1, 2009

Revise the second paragraph of Article 701.13(a) of the Standard Specifications to read:

"The Engineer will determine when a side road or entrance shall be closed to traffic. A flagger will be required at each side road or entrance remaining open to traffic within the operation where two-way traffic is maintained on one lane of pavement. The flagger shall be positioned as shown on the plans or as directed by the Engineer."

Revise the first and second paragraph of Article 701.20(i) of the Standard Specifications to read:

"Signs, barricades, or other traffic control devices required by the Engineer over and above those specified will be paid for according to Article 109.04. All flaggers required at side roads and entrances remaining open to traffic including those that are shown on the Highway Standards and/or additional barricades required by the Engineer to close side roads and entrances will be paid for according to Article 109.04."

80228

HOT-MIX ASPHALT - FIELD VOIDS IN THE MINERAL AGGREGATE (BDE)

Effective: April 1, 2007

Revised: April 1, 2008

Add the following to the table in Article 1030.05(d)(2)a. of the Standard Specifications:

"Parameter	Frequency of Tests	Frequency of Tests	Test Method See Manual of Test Procedures for Materials
	High ESAL Mixture Low ESAL Mixture	All Other Mixtures	
VMA Note 5.	Day's production ≥ 1200 tons: 1 per half day of production	N/A	Illinois-Modified AASHTO R 35
	Day's production < 1200 tons: 1 per half day of production for first 2 days and 1 per day thereafter (first sample of the day)		

Note 5. The G_{sb} used in the voids in the mineral aggregate (VMA) calculation shall be the same average G_{sb} value listed in the mix design."

Add the following to the Control Limits table in Article 1030.05(d)(4) of the Standard Specifications:

"CONTROL LIMITS			
Parameter	High ESAL Low ESAL	High ESAL Low ESAL	All Other
	Individual Test	Moving Avg. of 4	Individual Test
VMA	-0.7 % ^{2/}	-0.5 % ^{2/}	N/A

2/ Allowable limit below minimum design VMA requirement"

Add the following to the table in Article 1030.05(d)(5) of the Standard Specifications:

"CONTROL CHART REQUIREMENTS	High ESAL Low ESAL	All Other
	VMA"	

Revise the heading of Article 1030.05(d)(6)a.1. of the Standard Specifications to read:

"1. Voids, VMA, and Asphalt Binder Content."

Revise the first sentence of the first paragraph of Article 1030.05(d)(6)a.1.(a.) of the Standard Specifications to read:

"If the retest for voids, VMA, or asphalt binder content exceeds control limits, HMA production shall cease and immediate corrective action shall be instituted by the Contractor."

Revise the table in Article 1030.05(e) of the Standard Specifications to read:

"Test Parameter	Acceptable Limits of Precision
% Passing: ^{1/}	
1/2 in. (12.5 mm)	5.0 %
No. 4 (4.75 mm)	5.0 %
No. 8 (2.36 mm)	3.0 %
No. 30 (600 μm)	2.0 %
Total Dust Content No. 200 (75 μm) ^{1/}	2.2 %
Asphalt Binder Content	0.3 %
Maximum Specific Gravity of Mixture	0.026
Bulk Specific Gravity	0.030
VMA	1.4 %
Density (% Compaction)	1.0 % (Correlated)

1/ Based on washed ignition."

80181

HOT-MIX ASPHALT – PLANT TEST FREQUENCY (BDE)

Effective: April 1, 2008

Revise the table in Article 1030.05(d)(2)a. of the Standard Specifications to read:

"Parameter	Frequency of Tests	Frequency of Tests	Test Method See Manual of Test Procedures for Materials
	High ESAL Mixture Low ESAL Mixture	All Other Mixtures	
<p>Aggregate Gradation</p> <p>Hot bins for batch and continuous plants.</p> <p>Individual cold-feed or combined belt-feed for drier drum plants.</p> <p>% passing sieves: 1/2 in. (12.5 mm), No. 4 (4.75 mm), No. 8 (2.36 mm), No. 30 (600 μm) No. 200 (75 μm)</p> <p>Note 1.</p>	<p>1 dry gradation per day of production (either morning or afternoon sample). and 1 washed ignition oven test on the mix per day of production (conduct in the afternoon if dry gradation is conducted in the morning or vice versa).</p> <p>Note 3. Note 4.</p>	<p>1 gradation per day of production.</p> <p>The first day of production shall be a washed ignition oven test on the mix. Thereafter, the testing shall alternate between dry gradation and washed ignition oven test on the mix.</p> <p>Note 4.</p>	<p>Illinois Procedure</p>
<p>Asphalt Binder Content by Ignition Oven</p> <p>Note 2.</p>	<p>1 per half day of production</p>	<p>1 per day</p>	<p>Illinois-Modified AASHTO T 308</p>
<p>Air Voids</p> <p>Bulk Specific Gravity of Gyratory Sample</p>	<p>Day's production ≥ 1200 tons: 1 per half day of production</p> <p>Day's production < 1200 tons: 1 per half day of production for first 2 days and 1 per day thereafter (first sample of the day)</p>	<p>1 per day</p>	<p>Illinois-Modified AASHTO T 312</p>

"Parameter	Frequency of Tests High ESAL Mixture Low ESAL Mixture	Frequency of Tests All Other Mixtures	Test Method See Manual of Test Procedures for Materials
Maximum Specific Gravity of Mixture	Day's production \geq 1200 tons: 1 per half day of production	1 per day	Illinois-Modified AASHTO T 209"
	Day's production < 1200 tons: 1 per half day of production for first 2 days and 1 per day thereafter (first sample of the day)		

80201

HOT-MIX ASPHALT – TRANSPORTATION (BDE)

Effective: April 1, 2008

Revise Article 1030.08 of the Standard Specifications to read:

“1030.08 Transportation. Vehicles used in transporting HMA shall have clean and tight beds. The beds shall be sprayed with asphalt release agents from the Department’s approved list. In lieu of a release agent, the Contractor may use a light spray of water with a light scatter of manufactured sand (FA 20 or FA 21) evenly distributed over the bed of the vehicle. After spraying, the bed of the vehicle shall be in a completely raised position and it shall remain in this position until all excess asphalt release agent or water has been drained.

When the air temperature is below 60 °F (15 °C), the bed, including the end, endgate, sides and bottom shall be insulated with fiberboard, plywood or other approved insulating material and shall have a thickness of not less than 3/4 in (20 mm). When the insulation is placed inside the bed, the insulation shall be covered with sheet steel approved by the Engineer. Each vehicle shall be equipped with a cover of canvas or other suitable material meeting the approval of the Engineer which shall be used if any one of the following conditions is present.

- (a) Ambient air temperature is below 60 °F (15 °C).
- (b) The weather is inclement.
- (c) The temperature of the HMA immediately behind the paver screed is below 250 °F (120 °C).

The cover shall extend down over the sides and ends of the bed for a distance of approximately 12 in. (300 mm) and shall be fastened securely. The covering shall be rolled back before the load is dumped into the finishing machine.”

80202

LIQUIDATED DAMAGES (BDE)

Effective: April 1, 2009

Revise the table in Article 108.09 of the Standard Specifications to read:

"Schedule of Deductions for Each Day of Overrun in Contract Time			
Original Contract Amount		Daily Charges	
From More Than	To and Including	Calendar Day	Work Day
\$ 0	\$ 100,000	\$ 375	\$ 500
100,000	500,000	625	875
500,000	1,000,000	1,025	1,425
1,000,000	3,000,000	1,125	1,550
3,000,000	5,000,000	1,425	1,950
5,000,000	10,000,000	1,700	2,350
10,000,000	And over	3,325	4,650"

80230

MONTHLY EMPLOYMENT REPORT (BDE)

Effective: April 1, 2009

In addition to any other reporting required by the contract, the Contractor shall provide to the Engineer an employment summary for all employees working on the contract from the contract execution date to the last full pay period each month for the duration of the contract. The report may include but is not limited to:

- a) A listing of the total number of employees.
- b) The employee job classification.
- c) The total hours worked and payroll for each employee.

The report shall be completed by the Contractor and each subcontractor. Employee hours worked from home office or other off-site office hours worked related directly to this contract shall be included. Engineering consulting firms performing construction layout and material testing for the Contractor shall also be included.

Hours worked for material suppliers, services provided by purchase orders, Department employees or consulting firms performing inspection or testing for the Department shall not be included in the report.

The report shall contain all hours worked under the contract from the start of the month to the last full pay period each month and shall be submitted no later than 10 business days after the end of each month.

The report shall be submitted electronically in a format determined by the Engineer. See attachment for potential reporting format.

Any costs associated with complying with this provision shall be considered as included in the contract unit prices bid for the various items of work involved and no additional compensation will be allowed.

80238

Attachment

MONTHLY PRIME AND SUBCONTRACTOR EMPLOYMENT REPORT AMERICAN RECOVERY AND REINVESTMENT ACT			
1. First day of reporting period (mm/dd/yyyy):	2. Last day of reporting period (mm/dd/yyyy):	3. Notice to Proceed Date (mm/dd/yyyy)	
4. NAME AND ADDRESS OF FIRM		5. FEDERAL-AID PROJECT NUMBER	
		6. State Project Number or ID	
7. CONTRACTING AGENCY		8. STATE (or Federal Lands Region)	
Employment Data			
Direct, On-Project Jobs	TOTAL EMPLOYEES	TOTAL HOURS	TOTAL PAYROLL
CONSTRUCTION	NEW HIRES		
	EXISTING EMPLOYEES		
NON-CONSTRUCTION	NEW HIRES		
	EXISTING EMPLOYEES		
TOTAL			
10. PREPARED BY: <i>(Signature and Title)</i>			DATE
11. REVIEWED BY: <i>(Signature and Title of State Highway Official)</i>			DATE

This form is issued in association with the American Recovery and Reinvestment Act of 2009

PAYMENTS TO SUBCONTRACTORS (BDE)

Effective: June 1, 2000

Revised: January 1, 2006

Federal regulations found at 49 CFR §26.29 mandate the Department to establish a contract clause to require Contractors to pay subcontractors for satisfactory performance of their subcontracts and to set the time for such payments.

State law also addresses the timing of payments to be made to subcontractors and material suppliers. Section 7 of the Prompt Payment Act, 30 ILCS 540/7, requires that when a Contractor receives any payment from the Department, the Contractor shall make corresponding, proportional payments to each subcontractor and material supplier performing work or supplying material within 15 calendar days after receipt of the Department payment. Section 7 of the Act further provides that interest in the amount of two percent per month, in addition to the payment due, shall be paid to any subcontractor or material supplier by the Contractor if the payment required by the Act is withheld or delayed without reasonable cause. The Act also provides that the time for payment required and the calculation of any interest due applies to transactions between subcontractors and lower-tier subcontractors and material suppliers throughout the contracting chain.

This Special Provision establishes the required federal contract clause, and adopts the 15 calendar day requirement of the State Prompt Payment Act for purposes of compliance with the federal regulation regarding payments to subcontractors. This contract is subject to the following payment obligations.

When progress payments are made to the Contractor according to Article 109.07 of the Standard Specifications, the Contractor shall make a corresponding payment to each subcontractor and material supplier in proportion to the work satisfactorily completed by each subcontractor and for the material supplied to perform any work of the contract. The proportionate amount of partial payment due to each subcontractor and material supplier throughout the contracting chain shall be determined by the quantities measured or otherwise determined as eligible for payment by the Department and included in the progress payment to the Contractor. Subcontractors and material suppliers shall be paid by the Contractor within 15 calendar days after the receipt of payment from the Department. The Contractor shall not hold retainage from the subcontractors. These obligations shall also apply to any payments made by subcontractors and material suppliers to their subcontractors and material suppliers; and to all payments made to lower tier subcontractors and material suppliers throughout the contracting chain. Any payment or portion of a payment subject to this provision may only be withheld from the subcontractor or material supplier to whom it is due for reasonable cause.

This Special Provision does not create any rights in favor of any subcontractor or material supplier against the State or authorize any cause of action against the State on account of any payment, nonpayment, delayed payment, or interest claimed by application of the State Prompt Payment Act. The Department will not approve any delay or postponement of the 15 day requirement except for reasonable cause shown after notice and hearing pursuant to Section

| 7(b) of the State Prompt Payment Act. State law creates other and additional remedies available to any subcontractor or material supplier, regardless of tier, who has not been paid for work properly performed or material furnished. These remedies are a lien against public funds set forth in Section 23(c) of the Mechanics Lien Act, 770 ILCS 60/23(c), and a recovery on the Contractor's payment bond according to the Public Construction Bond Act, 30 ILCS 550.

80022

PAYROLLS AND PAYROLL RECORDS (BDE)

Effective: March 1, 2009

Revised: July 1, 2009

FEDERAL AID CONTRACTS. Revise the following section of Check Sheet #1 of the Recurring Special Provisions to read:

"STATEMENTS AND PAYROLLS

The payroll records shall include each worker's name, address, telephone number, social security number, classification, rate of pay, number of hours worked each day, starting and ending times of work each day, total hours worked each week, itemized deductions made, and actual wages paid.

The Contractor and each subcontractor shall submit payroll records to the Engineer each week from the start to the completion of their respective work, except that full social security numbers and home addresses shall not be included on weekly transmittals. Instead the payrolls shall include an identification number for each employee (e.g., the last four digits of the employee's social security number.). In addition, starting and ending times of work each day may be omitted from the payroll records submitted to the Engineer. The submittals shall be on the Department's form SBE 48, or an approved facsimile. When there has been no activity during a work week, a payroll record shall still be submitted with the appropriate box ("No Work", "Suspended", or "Complete") checked on the form."

STATE CONTRACTS. Revise Section IV of Check Sheet #5 of the Recurring Special Provisions to read:

"IV.COMPLIANCE WITH THE PREVAILING WAGE ACT

1. Prevailing Wages. All wages paid by the Contractor and each subcontractor shall be in compliance with The Prevailing Wage Act (820 ILCS 130), as amended, except where a prevailing wage violates a federal law, order, or ruling, the rate conforming to the federal law, order, or ruling shall govern. The Contractor shall be responsible to notify each subcontractor of the wage rates set forth in this contract and any revisions thereto. If the Department of Labor revises the wage rates, the Contractor will not be allowed additional compensation on account of said revisions.
2. Payroll Records. The Contractor and each subcontractor shall make and keep, for a period of three years from the date of completion of this contract, records of the wages paid to his/her workers. The payroll records shall include each worker's name, address, telephone number, social security number, classification, rate of pay, number of hours worked each day, starting and ending times of work each day, total hours worked each week, itemized deductions made, and actual wages paid. Upon two business days' notice, these records shall be available, at all reasonable hours at a location within the State, for inspection by the Department or the Department of Labor.

3. Submission of Payroll Records. The Contractor and each subcontractor shall submit payroll records to the Engineer each week from the start to the completion of their respective work, except that full social security numbers and home addresses shall not be included on weekly transmittals. Instead the payrolls shall include an identification number for each employee (e.g., the last four digits of the employee's social security number). In addition, starting and ending times of work each day may be omitted from the payroll records submitted to the Engineer. The submittals shall be on the Department's form SBE 48, or an approved facsimile. When there has been no activity during a work week, a payroll record shall still be submitted with the appropriate box ("No Work", "Suspended", or "Complete") checked on the form.

Each submittal shall be accompanied by a statement signed by the Contractor or subcontractor which avers that: (i) such records are true and accurate; (ii) the hourly rate paid to each worker is not less than the general prevailing rate of hourly wages required by the Act; and (iii) the Contractor or subcontractor is aware that filing a payroll record that he/she knows to be false is a Class B misdemeanor.

4. Employee Interviews. The Contractor and each subcontractor shall permit his/her employees to be interviewed on the job, during working hours, by compliance investigators of the Department or the Department of Labor."

80235

PERSONAL PROTECTIVE EQUIPMENT (BDE)

Effective: November 1, 2008

Revise the first sentence of Article 701.12 of the Standard Specifications to read:

“All personnel on foot, excluding flaggers, within the highway right-of-way shall wear a fluorescent orange, fluorescent yellow/green, or a combination of fluorescent orange and fluorescent yellow/green vest meeting the requirements of ANSI/ISEA 107-2004 for Conspicuity Class 2 garments.”

80209

The Contractor will be advised when the Department has received approval of the insurance from the railroad(s). Before any work begins on railroad right-of-way, the Contractor shall submit to the Engineer evidence that the required insurance has been approved by the railroad(s). The Contractor shall also provide the Engineer with the expiration date of each required policy.

Basis of Payment. Providing Railroad Protective Liability and Property Damage Liability Insurance will be paid for at the contract unit price per Lump Sum for RAILROAD PROTECTIVE LIABILITY INSURANCE.

80157

SUBCONTRACTOR MOBILIZATION PAYMENTS (BDE)

Effective: April 2, 2005

To account for the preparatory work and operations necessary for the movement of subcontractor personnel, equipment, supplies, and incidentals to the project site and for all other work or operations that must be performed or costs incurred when beginning work approved for subcontracting in accordance with Article 108.01 of the Standard Specifications, the Contractor shall make a mobilization payment to each subcontractor.

This mobilization payment shall be made at least 14 days prior to the subcontractor starting work. The amount paid shall be equal to 3 percent of the amount of the subcontract reported on form BC 260A submitted for the approval of the subcontractor's work.

This provision shall be incorporated directly or by reference into each subcontract approved by the Department.

80143

WORKING DAYS (BDE)

Effective: January 1, 2002

The Contractor shall complete the work within 15 working days.

80071

CONTRACT NO. 89547

CITY OF DELAVAN
TAZEVELL COUNTY, ILLINOIS

PLANS FOR PROPOSED LOCUST STREET RESURFACING

SECTION NO. 09-00023-00-RS
FED. PROJ. NO. ARA-1464(103)
JOB NO. C-94-135-09

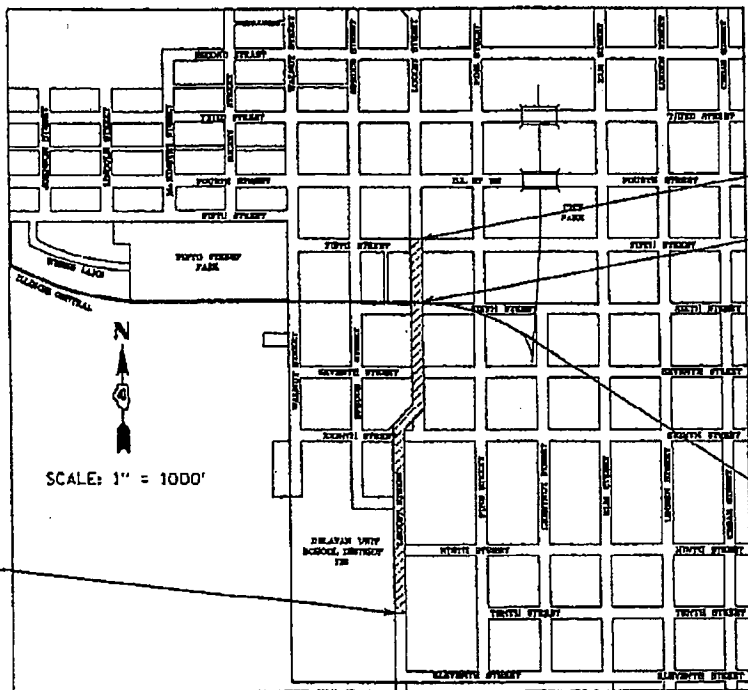
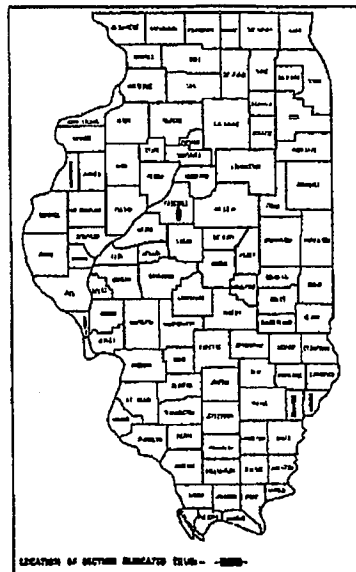

PROJECT LIMIT
STA. 27+25

RAILROAD CROSSING OMISSION
STA. 23+25 TO STA. 23+70

SCALE: 1" = 1000'

PROJECT LIMIT
STA. 5+35

INDEX OF SHEETS

- 1 COVER SHEET
- 2 SUMMARY OF QUANTITIES
- 3-4 SCHEDULE OF QUANTITIES
- 5 TYPICAL SECTIONS
- 6 PLAN SHEET

7-12 STANDARDS
701311-03
701901-01
780001-02

AD1 (2009)=1400
PV=88%, SU=7%, MU=5%
DESIGN SPEED=30 M.P.H.
HIGHWAY CLASS: MAJOR COLLECTOR

TOTAL LENGTH OF IMPROVEMENT: 2190 FT (0.415 MILES)
NET LENGTH OF IMPROVEMENT: 2145 FT (0.406 MILES)



Robert M. Markunas
ROBERT M. MARKUNAS

ILLINOIS REGISTERED
PROFESSIONAL ENGINEER
NO. 062-053696

CITY OF DELAVAN	
APPROVED	<i>May 29</i> 20 09
<i>Stephen J. ...</i> MAYOR OF DELAVAN	
PASSED	<i>5-29</i> 20 09
<i>David C. ...</i> DISTRICT FOUR ENGINEER OF LOCAL ROADS & STREETS	
Released For Bid Based on Limited Review	<i>MM 29</i> 20 09
<i>...</i> DEPUTY DIRECTOR OF HIGHWAYS, REGION THREE ENGINEER	
STATE OF ILLINOIS DEPARTMENT OF TRANSPORTATION	

exp. 11/30/09

SUMMARY OF QUANTITIES

CODE	ITEM	UNIT	QUANTITY
40600100	BITUMINOUS MATERIALS (PRIME COAT)	GAL	610
40600300	AGGREGATE (PRIME COAT)	TON	15.3
40600515	LEVELING BINDER (HAND METHOD), N30	TON	1
40603305	HOT-MIX ASPHALT SURFACE COURSE, MIX "C", N30	TON	854
44000157	HOT-MIX ASPHALT SURFACE REMOVAL, 2"	SQ YD	7627
67100100	MOBILIZATION	L SUM	1
* 78000200	THERMOPLASTIC PAVEMENT MARKING - LINE 4"	FOOT	4320
* 78000400	THERMOPLASTIC PAVEMENT MARKING - LINE 6"	FOOT	192
* 78000650	THERMOPLASTIC PAVEMENT MARKING - LINE 24"	FOOT	32
Z0048665	RAILROAD PROTECTIVE LIABILITY INSURANCE	L SUM	1

*** SPECIALTY ITEMS
 PAVEMENT DESIGN**

STRUCTURAL DESIGN TRAFFIC: Year 2019	
PV = 1232	(88%)
SU = 98	(7%)
MU = 70	(5%)
ROAD CLASSIFICATION: CLASS III	
TRAFFIC FACTOR: 0.5 (MIN.)	
BASIC SLAB THICKNESS:	6.5 in.
ADJUSTMENT FOR POOR SUBGRADE WITH GRANULAR SUBBASE:	NONE
ADJUSTMENT FOR OVERLOADS WITH TF OF 0.5:	+0.15 in.
ADJUSTMENT FOR HMA LAYER THICKNESS (2 in.):	+0.5 in.
FINAL SLAB THICKNESS:	7.15 in.
EXISTING 8 in. PCC BASE AND 2 in. HMA OVERLAY IS ADEQUATE	

89547
 TAZEWELL COUNTY
 FAS 1464
 SEC. 09-00023-00-RS
 ARA-1464(103)
 C-94-135-09

LOCUST STREET QUANTITY SCHEDULES

40600010 - BITUMINOUS MATERIALS (PRIME COAT)						
BEGIN STA.	END STA.	WIDTH (FT.)	AREA (SY)	RATE (GAL/SY)	APP. #	GALLONS
5+35	23+25	32	6364	0.08	1	509
23+70	27+25	32	1262	0.08	1	101
					TOTAL:	610

40600030 - AGGREGATE (PRIME COAT)						
BEGIN STA.	END STA.	WIDTH (FT.)	AREA (SY)	RATE (TON/SY)	APP. #	TONS
5+35	23+25	32	6364	0.002	1	12.7
23+70	27+25	32	1262	0.002	1	2.5
					TOTAL:	15.3

40603305 - HOT-MIX ASPHALT SURFACE COURSE, MIX "C", N30					
BEGIN STA.	END STA.	WIDTH (FT.)	THICKNESS (in.)	POUNDS	TONS
5+35	23+25	32	2	1425636	713
23+70	27+25	32	2	282738	141
				TOTAL:	854

44000157 - HOT-MIX ASPHALT SURFACE REMOVAL, 2"				
BEGIN STA.	END STA.	WIDTH (FT.)	AREA (SF)	AREA (SY)
5+35	23+25	32	57280	6364
23+70	27+25	32	11360	1262
			TOTAL:	7627

78000200 - THERMOPLASTIC PAVEMENT MARKING - LINE 4"				
EDGE LINES				
BEGIN STA.	END STA.	NET LENGTH	NUMBER	TOTAL LENGTH
5+35	8+80	345	2	690
9+30	15+30	600	2	1200
15+80	19+30	350	2	700
19+80	23+25	345	2	690
23+70	26+50	280	2	560
CENTER SKIP DASH (10' DASH - 30' SKIP)				
5+35	8+80	86	1	86.25
9+30	15+30	150	1	150
15+80	19+30	88	1	87.5
19+80	23+25	86	1	86.25
23+70	26+50	70	1	70
			TOTAL:	4320.0

89547
TAZEWELL COUNTY
FAS 1464
SEC. 09-00023-00-RS
ARA-1464(103)
C-94-135-09

LOCUST STREET QUANTITY SCHEDULES (cont.)

78000400 THERMOPLASTIC PAVEMENT MARKING - LINE 6"				
CROSSWALKS				
LOCATIONS	WIDTH (FT.)	LENGTH (FT.)		
3	32	192		

78000650 THERMOPLASTIC PAVEMENT MARKING - LINE 24"				
STOP BARS				
LOCATIONS	WIDTH (FT.)	LENGTH (FT.)		
2	16	32		

PATH:
 FILE:
 UPDATE BY:
 SURVEY BOOK #
 XREF DGN:
 XREF DGN:
 DATE:
 SEC. 09-00023-00-R5
 PROJ. ARA-1464(103)

REVISIONS

NUMBER	BY	DATE

CITY OF DELAVAN
LOCUST STREET RESURFACING
TYPICAL SECTION



CMT
 CRAWFORD, MURPHY & TILLY, INC.
 CONSULTING ENGINEERS
© Copyright CMT, Inc.

DESIGN BY:	RMM
DRAWN BY:	NDS
CHECKED BY:	RMM
APPROVED BY:	EJH
DATE:	5/27/09
JOB No:	09073-03-00

5

NOTE:
 LEVELING BINDER (HAND METHOD) SHALL BE USED TO FILL IN ANY CRACKS OR RUTS FOUND IN THE EXISTING PAVEMENT TO BE OVERLAID.

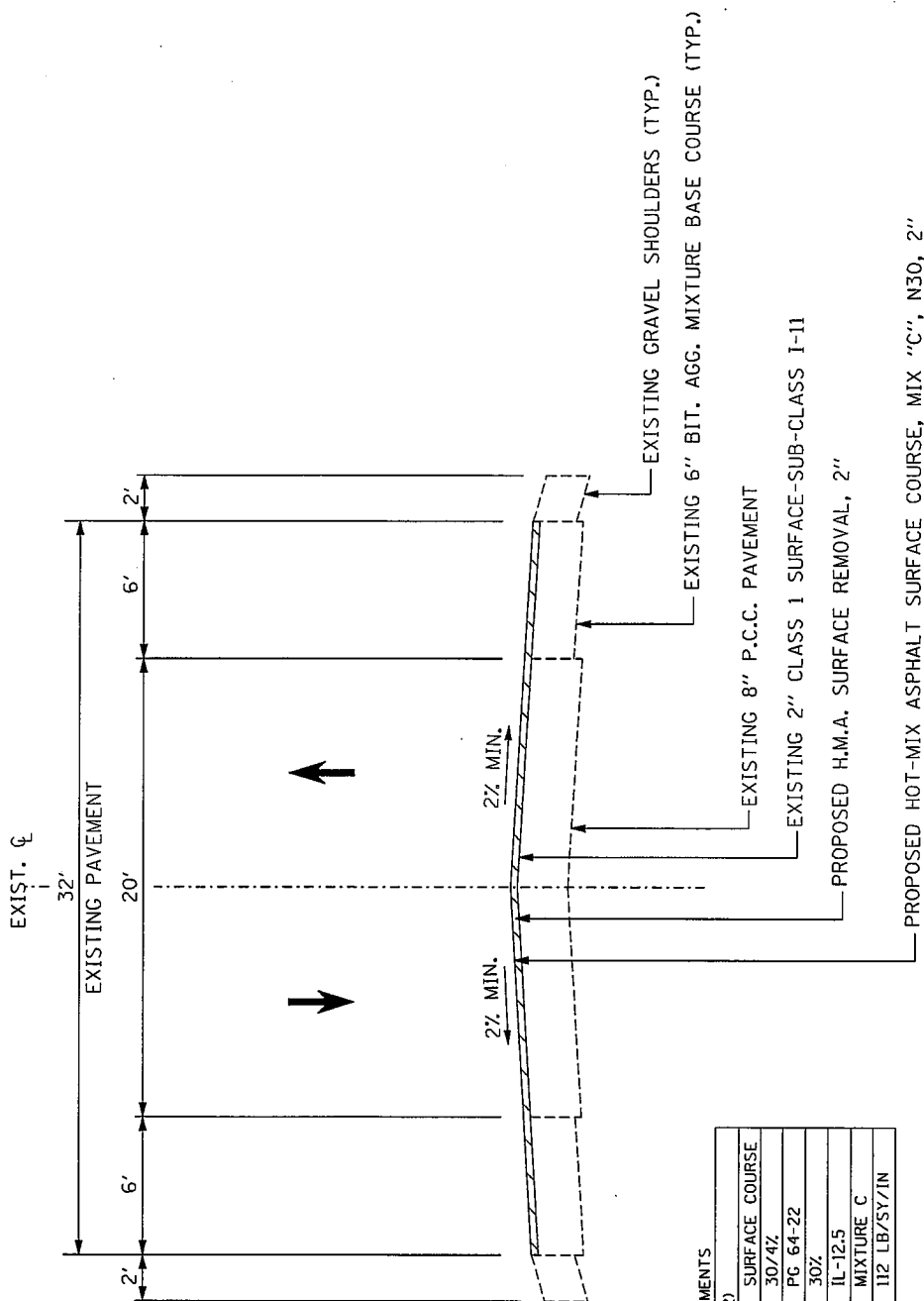

LOCUST STREET
 STA. 5+35 TO STA. 23+25
 STA. 23+70 TO STA. 27+25

SUPERPAVE BITUMINOUS REQUIREMENTS

LOCATION:	FAS 1464 - LOCUST STREET (CR-2)
MIXTURE USES:	LEVELING BINDER SURFACE COURSE
INDICES/AIR Voids	30/4%
PG:	PG 64-22
RAP %	30%
MIXTURE COMPOSITION	IL-9.5
FRICTION AGGREGATE	MIXTURE C
MIXTURE WEIGHT	112 LB/SY/IN

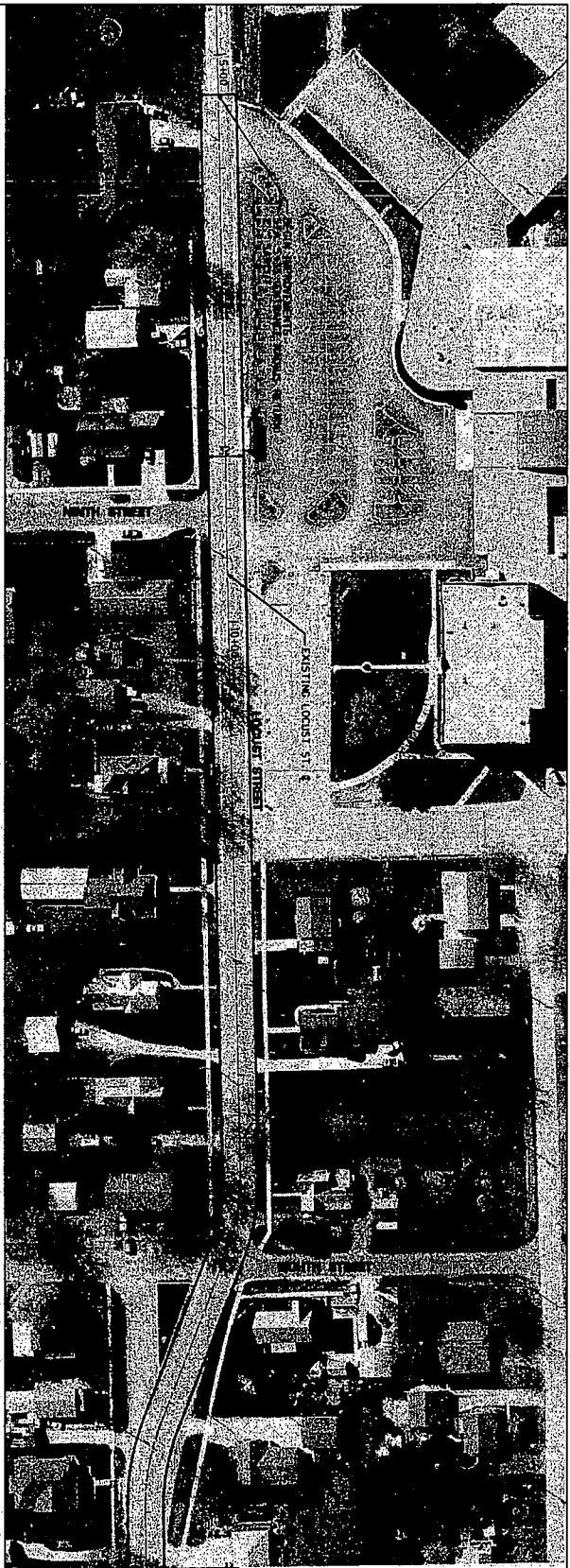
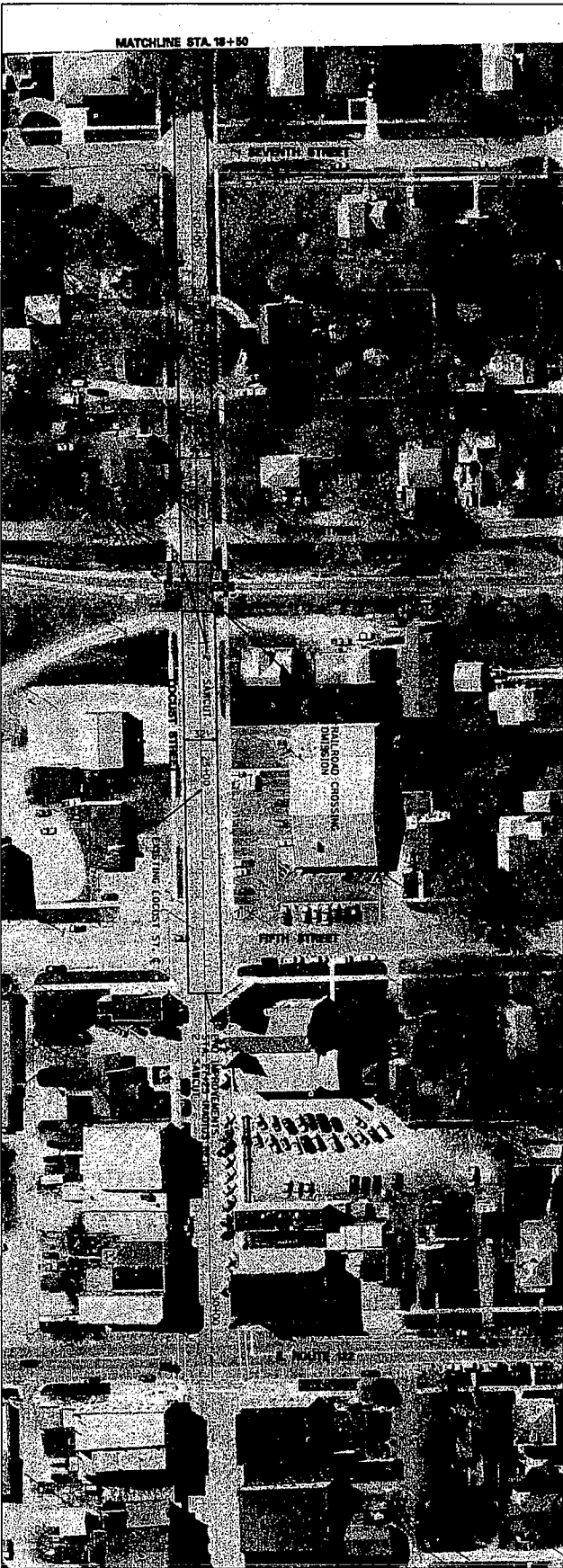

DESIGN BY:	MS
DRAWN BY:	MS
CHECKED BY:	EA/MLB
APPROVED BY:	EA
DATE:	5/27/08
JOB NO.:	09013-03-00

CMT
 CRAWFORD, MURPHY & TILLY, INC.
 CONSULTING ENGINEERS

CITY OF DELAVAN
LOCUST STREET
STA. 5+35 TO STA. 27+25

REVISIONS		
NUMBER	BY	DATE

FILED:
 SHEET BOOK:
 SHEET NO. 6
 DATE:
 PROJ. NO. 09-0003-00-05
 PROJ. MANAGER



CONTRACT NO. 89547

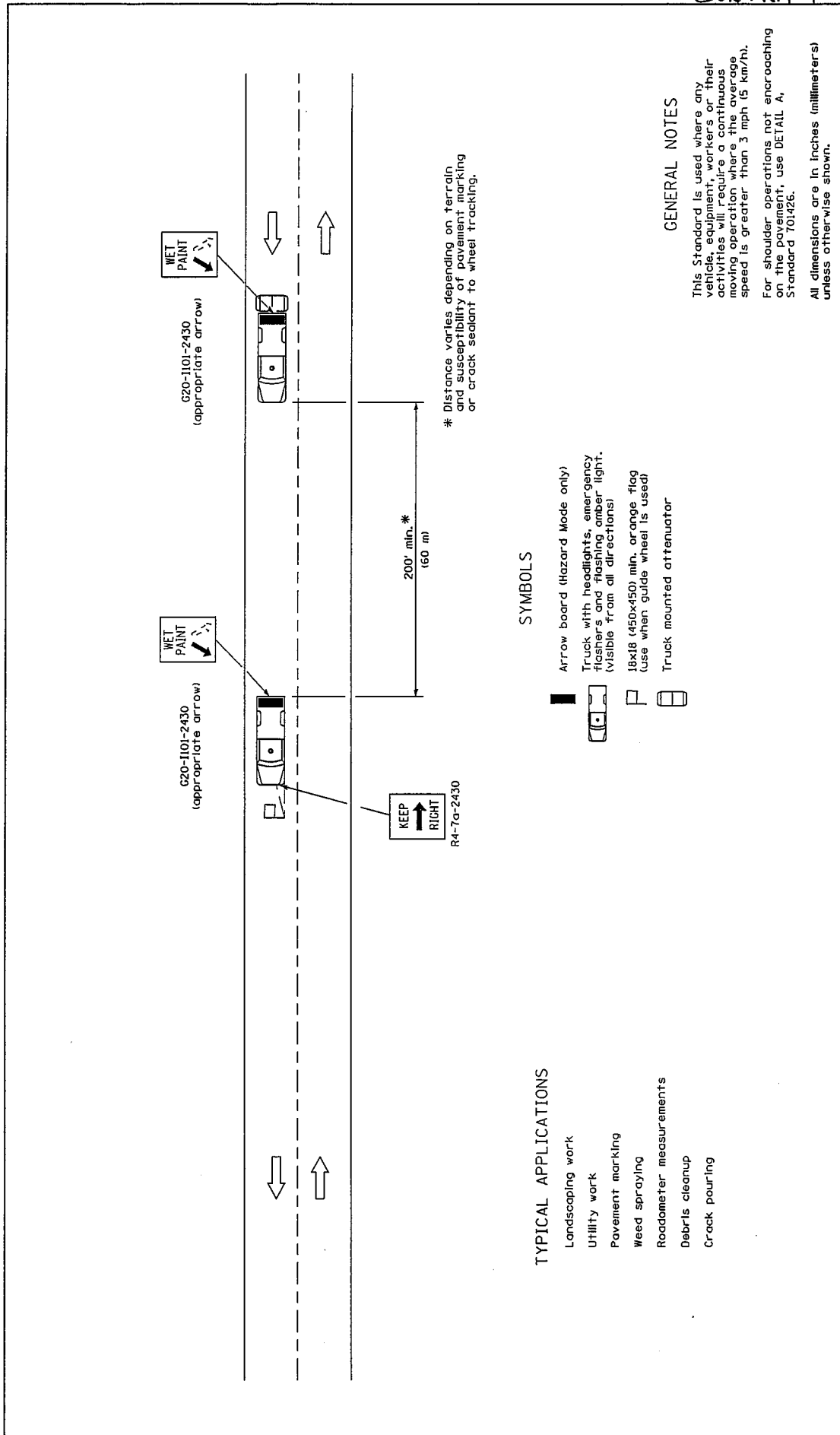

* Distance varies depending on terrain and susceptibility of pavement marking or crack sealant to wheel tracking.

SYMBOLS

- Arrow board (Hazard Mode only)
- Truck with headlights, emergency flashers and flashing amber light (visible from all directions)
- 18x18 (450x450) min. orange flag (use when guide wheel is used)
- Truck mounted attenuator

TYPICAL APPLICATIONS

- Landscaping work
- Utility work
- Pavement marking
- Weed spraying
- Roadometer measurements
- Debris cleanup
- Crack pouring

GENERAL NOTES

This Standard is used where any vehicle, equipment, workers or their activities will require a continuous moving operation where the average speed is greater than 3 mph (5 km/h).
 For shoulder operations not encroaching on the pavement, use DETAIL A, Standard 701426.
 All dimensions are in inches (millimeters) unless otherwise shown.

DATE	REVISIONS
1-1-09	Switched units to English (metric). Omitted Pass With Care sign.
1-1-00	Elim. speed restrictions in Standard title.

**LANE CLOSURE 2L, 2W
 MOVING OPERATIONS-DAY ONLY**

STANDARD 701311-03

Illinois Department of Transportation APPROVED _____ 2009 ENGINEER OF OPERATIONS APPROVED _____ 2009 ENGINEER OF DESIGN AND ENVIRONMENT	ISSUED 1-1-97
---	---------------

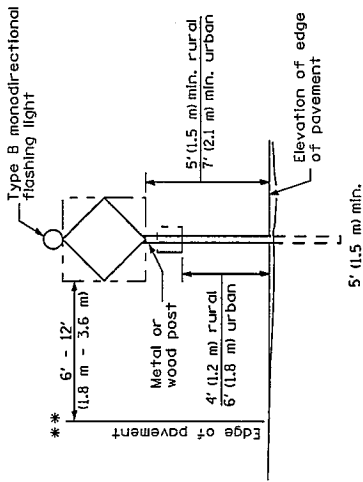

POST MOUNTED SIGNS

** When curb or paved shoulder are present this dimension shall be 24 (600) to the face of curb or 6' (1.8 m) to the outside edge of the paved shoulder.

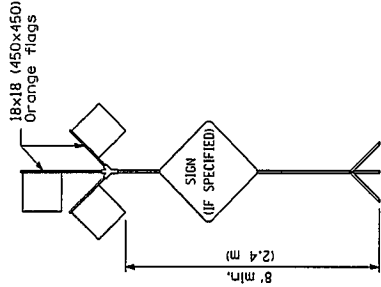

HIGH LEVEL WARNING DEVICE

ROAD CONSTRUCTION NEXT X MILES
G20-110)-6036

END CONSTRUCTION
G20-2a10)-6024

This signing is required for all projects 2 miles (3200 m) or more in length. ROAD CONSTRUCTION NEXT X MILES sign shall be placed 500' (150 m) in advance of project limits.

END CONSTRUCTION sign shall be erected at the end of the job unless another job is within 2 miles (3200 m).

Dual sign displays shall be utilized on multi-lane highways.

WORK LIMIT SIGNING

SIGNS ON TEMPORARY SUPPORTS

*** When work operations exceed four days, this dimension shall be 5' (1.5 m) min. If located behind other devices, the height shall be sufficient to be seen by motorists.

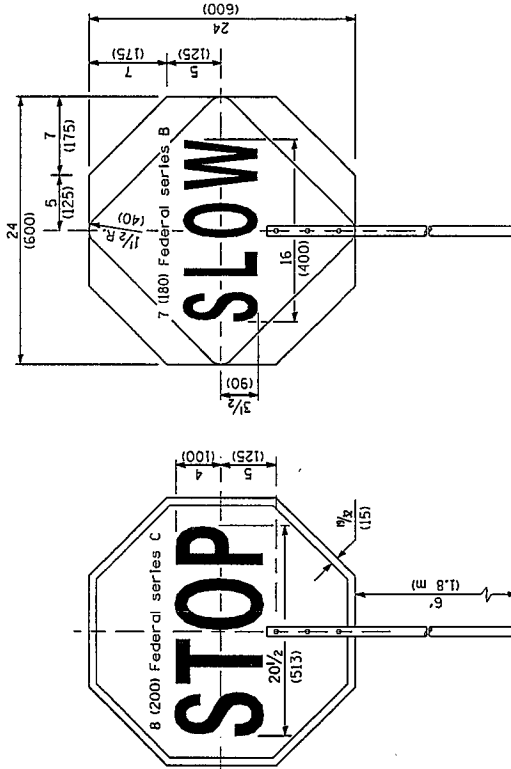
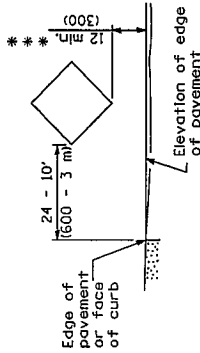

FLAGGER TRAFFIC CONTROL SIGN

All dimensions are in inches (millimeters) unless otherwise shown.

Illinois Department of Transportation
 APPROVED January 11, 2009
 ENGINEER OF DESIGN
 APPROVED 6/27/09
 ENGINEER OF DESIGN AND ENVIRONMENT

ISSUED 1-1-97

TRAFFIC CONTROL DEVICES
 (Sheet 2 of 3)

STANDARD 701901-01

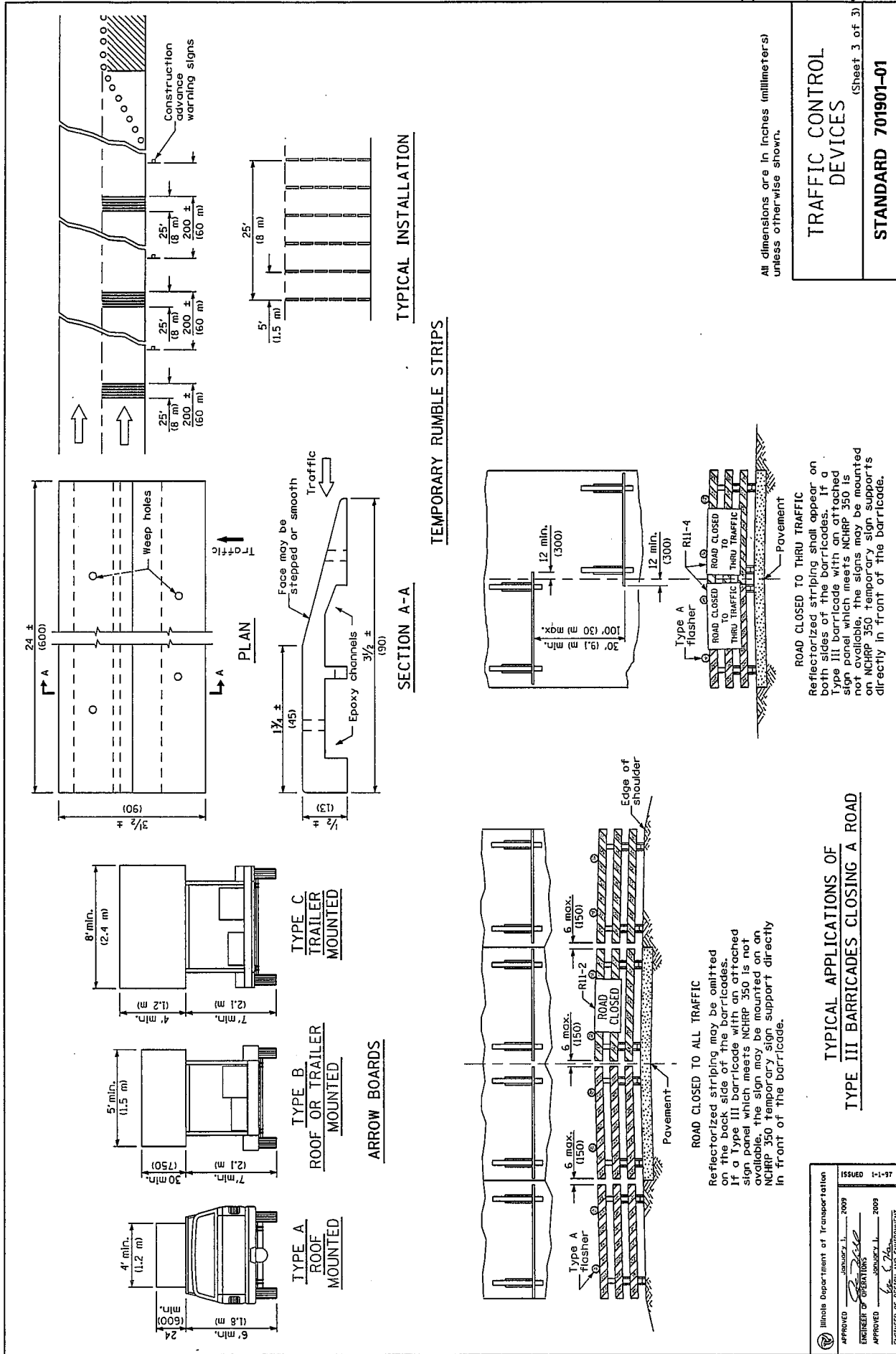

All dimensions are in inches (millimeters) unless otherwise shown.

TRAFFIC CONTROL DEVICES

(Sheet 3 of 3)

STANDARD 701901-01

Illinois Department of Transportation	ISSUED 1-1-97
APPROVED January 1, 2009	
ENGINEER OF OPERATIONS	
APPROVED January 1, 2009	
REGISTERED PROFESSIONAL ENGINEER	

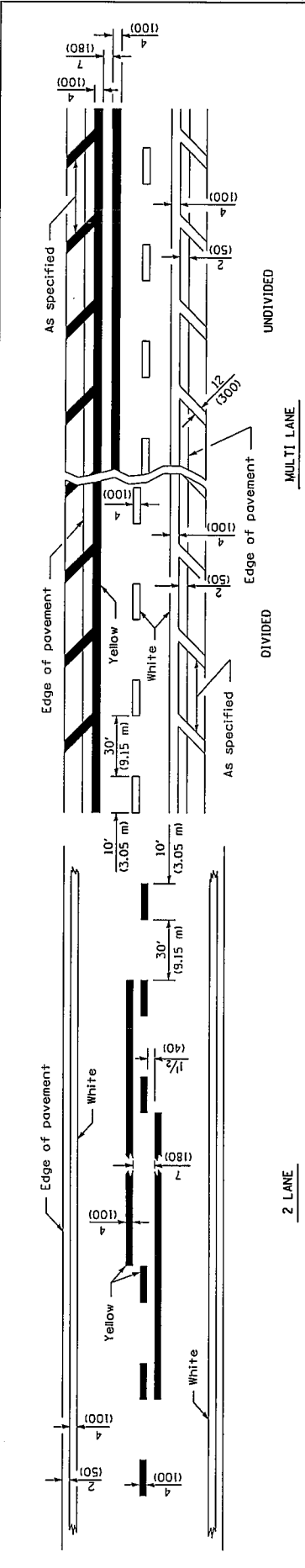

LANE AND EDGE LINES

Approximately 15' (4.5 m) or 8' (2.4 m) back from and parallel to gate, if present.

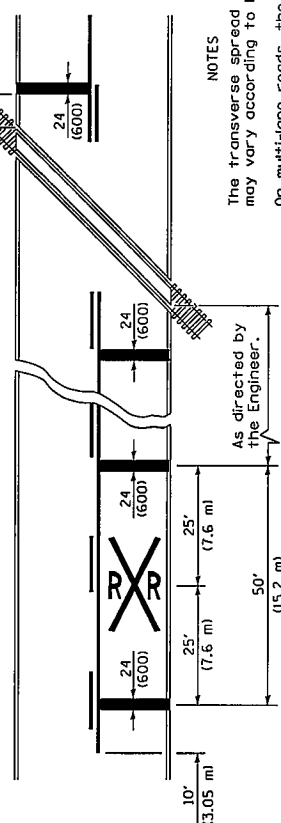

NOTES

The transverse spread of the "X" may vary according to lane width. On multi-lane roads, the stop lines shall extend across all approach lanes. Separate R/R symbols shall be placed adjacent to each other in each lane. When the pavement marking symbol is used, a portion of the symbol should be located directly adjacent to the Advance Warning Sign (W10-1) as placed by Table II-1, condition B of the MUTCD.

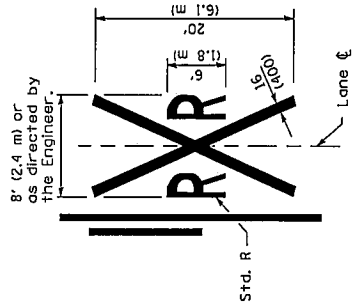

PAVEMENT MARKINGS AT RAILROAD-HIGHWAY GRADE CROSSING

All dimensions are in inches (millimeters) unless otherwise shown.

DATE	REVISIONS
1-1-09	Switched units to English (metric).
1-1-99	Rev. dimen. & added 3rd note to pav't markings
	⊕ RR-Hwy grade Xing.

Illinois Department of Transportation	ISSUED 1-1-97
APPROVED January 1, 2009	
ENGINEER OF OPERATIONS	
APPROVED June 1, 2009	
ENGINEER OF DESIGN AND ENVIRONMENT	

TYPICAL PAVEMENT MARKINGS

(Sheet 1 of 2)

STANDARD 780001-02

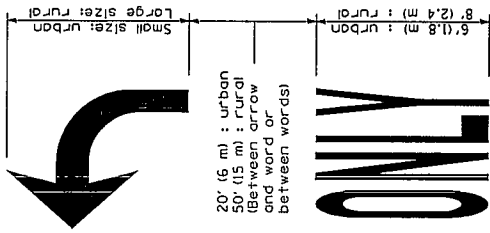
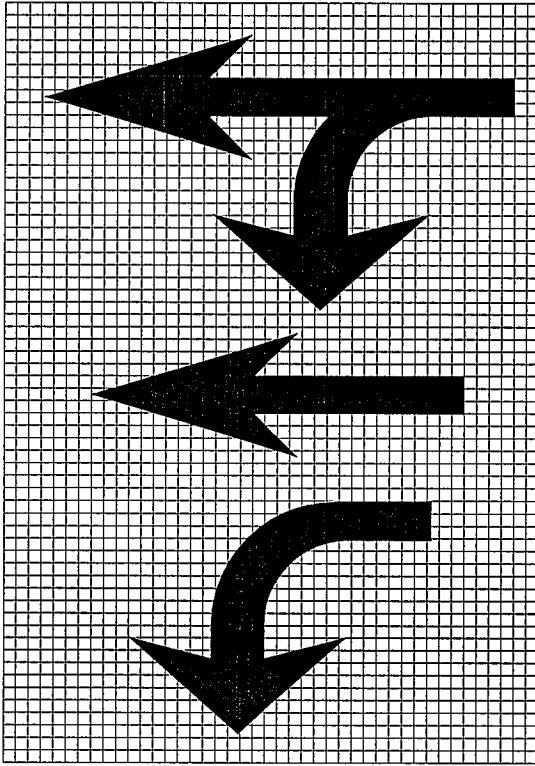
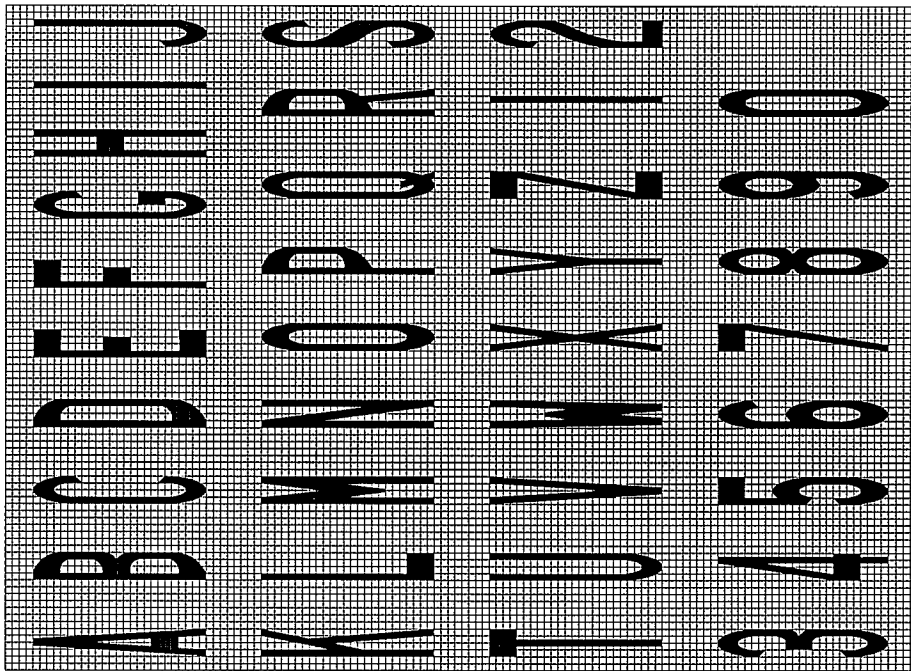

WORD AND ARROW LAYOUT

Legend Height	Arrow Size	a
6' (1.8 m)	Small	2.9 (74)
8' (2.4 m)	Large	3.8 (96)

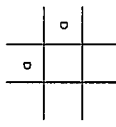

The space between adjacent letters or numerals should be approximately 3 (75) for 6' (1.8 m) legend and 4 (100) for 8' (2.4 m) legend.

LETTER AND ARROW GRID SCALE

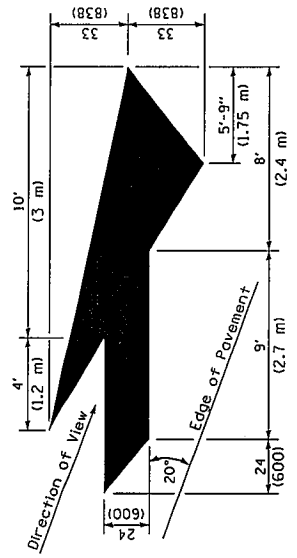

LANE DROP ARROW
Right lane drop arrow shown.
Use mirror image for left lane.

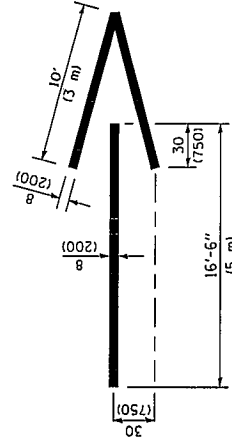

WRONG WAY ARROW

TYPICAL PAVEMENT MARKINGS
(Sheet 2 of 2)
STANDARD 780001-02

Illinois Department of Transportation
ISSUED 1-1-97
APPROVED [Signature] 2009
ENGINEER OF OPERATIONS
APPROVED [Signature] 2009
ENGINEER OF DESIGN AND ENVIRONMENT

**REQUIRED CONTRACT PROVISIONS
FEDERAL-AID CONSTRUCTION CONTRACTS**

	Page
I. General	1
II. Nondiscrimination	1
III. Nonsegregated Facilities	3
IV. Payment of Predetermined Minimum Wage.....	3
V. Statements and Payrolls	5
VI. Record of Materials, Supplies, and Labor.....	6
VII. Subletting or Assigning the Contract.....	6
VIII. Safety: Accident Prevention	7
IX. False Statements Concerning Highway Projects.....	7
X. Implementation of Clean Air Act and Federal Water Pollution Control Act	7
XI. Certification Regarding Debarment, Suspension, Ineligibility, and Voluntary Exclusion	8
XII. Certification Regarding Use of Contract Funds for Lobbying	9

ATTACHMENTS

**A. Employment Preference for Appalachian Contracts
(included in Appalachian contracts only)**

I. GENERAL

1. These contract provisions shall apply to all work performed on the contract by the contractor's own organization and with the assistance of workers under the contractor's immediate superintendence and to all work performed on the contract by piecework, station work, or by subcontract.
2. Except as otherwise provided for in each section, the contractor shall insert in each subcontract all of the stipulations contained in these Required Contract Provisions, and further require their inclusion in any lower tier subcontract or purchase order that may in turn be made. The Required Contract Provisions shall not be incorporated by reference in any case. The prime contractor shall be responsible for compliance by any subcontractor or lower tier subcontractor with these Required Contract Provisions.
3. A breach of any of the stipulations contained in these Required Contract Provisions shall be sufficient grounds for termination of the contract.
4. A breach of the following clauses of the Required Contract Provisions may also be grounds for debarment as provided in 29 CFR 5.12:

Section I, paragraph 2;
Section IV, paragraphs 1, 2, 3, 4 and 7;
Section V, paragraphs 1 and 2a through 2g.

5. Disputes arising out of the labor standards provisions of Section IV (except paragraph 5) and Section V of these Required Contract Provisions shall not be subject to the general disputes clause of this contract. Such disputes shall be resolved in accordance with the procedures of the U.S. Department of Labor (DOL) as set forth in 29 CFR 5, 6 and 7. Disputes within the meaning of this clause include disputes between the contractor (or any of its subcontractors) and the contracting agency, the DOL, or the contractor's employees or their representatives.

6. Selection of Labor: During the performance of this contract, the contractor shall not:

- a. Discriminate against labor from any other State, possession, or territory of the United States (except for employment preference for Appalachian contracts, when applicable, as specified in Attachment A), or

- b. Employ convict labor for any purpose within the limits of the project unless it is labor performed by convicts who are on parole, supervised release, or probation.

II. NONDISCRIMINATION

(Applicable to all Federal-aid construction contracts and to all related subcontracts of \$10,000 or more.)

1. Equal Employment Opportunity: Equal employment opportunity (EEO) requirements not to discriminate and to take affirmative action to assure equal opportunity as set forth under laws, executive orders, rules, regulations (28 CFR 35, 29 CFR 1630 and 41 CFR 60 (and orders of the Secretary of Labor as modified by the provisions prescribed herein, and imposed pursuant to 23 U.S.C. 140 shall constitute the EEO and specific affirmative action standards for the contractor's project activities under this contract. The Equal Opportunity Construction Contract Specifications set forth under 41 CFR 60-4.3 and the provisions of the American Disabilities Act of 1990 (42 U.S.C. 12101 et seq.) set forth under 28 CFR 35 and 29 CFR 1630 are incorporated by reference in this contract. In the execution of this contract, the contractor agrees to comply with the following minimum specific requirement activities of EEO:

a. The contractor will work with the State highway agency (SHA) and the Federal Government in carrying out EEO obligations and in their

review of his/her activities under the contract.

b. The contractor will accept as his operating policy the following

statement: "It is the policy of this Company to assure that applicants are employed, and that employees are treated during employment, without regard to their race, religion, sex, color, national origin, age or disability. Such action shall include: employment, upgrading, demotion, or transfer; recruitment or recruitment advertising; layoff or termination; rates of pay or other forms of compensation; and selection for training, including apprenticeship, preapprenticeship, and/or on-the-job-training."

2. EEO Officer: The contractor will designate and make known to the SHA contracting officers an EEO Officer who will have the responsibility for an must be capable of effectively administering and promoting an active contractor program of EEO and who must be assigned adequate authority and responsibility to do so.

3. Dissemination of Policy: All members of the contractor's staff who are authorized to hire, supervise, promote, and discharge employees, or who recommend such action, or who are substantially involved in such action, will be made fully cognizant of, and will implement, the contractor's EEO policy and contractual responsibilities to provide EEO in each grade and classification of employment. To ensure that the above agreement will be met, the following actions will be taken as a minimum:

a. Periodic meetings of supervisory and personnel office employees will be conducted before the start of work and then not less often than once every six months, at which time the contractor's EEO policy and its implementation will be reviewed and explained. The meetings will be conducted by the EEO Officer.

b. All new supervisory or personnel office employees will be given a thorough indoctrination by the EEO Officer, covering all major aspects of the contractor's EEO obligations within thirty days following their reporting for duty with the contractor.

c. All personnel who are engaged in direct recruitment for the project will be instructed by the EEO Officer in the contractor's procedures for locating and hiring minority group employees.

d. Notices and posters setting forth the contractor's EEO policy will be placed in areas readily accessible to employees,

applicants for employment and potential employees.

e. The contractor's EEO policy and the procedures to implement such policy will be brought to the attention of employees by means of meetings, employee handbooks, or other appropriate means.

4. Recruitment: When advertising for employees, the contractor will include in all advertisements for employees the notation: "An Equal Opportunity Employer." All such advertisements will be placed in publications having a large circulation among minority groups in the area from which the project work force would normally be derived.

a. The contractor will, unless precluded by a valid bargaining agreement, conduct systematic and direct recruitment through public and private employees referral sources likely to yield qualified minority group applicants. To meet this requirement, the contractor will identify sources of potential minority group employees, and establish which such identified sources procedures whereby minority group applicants may be referred to the contractor for employment consideration.

b. In the event the contractor has a valid bargaining agreement providing for exclusive hiring hall referrals, he is expected to observe the provisions of that agreement to the extent that the system permits the contractor's compliance with EEO contract provisions. (The DOL has held that where implementation of such agreements have the effect of discriminating against minorities or women, or obligates the contractor to do the same, such implementation violates Executive Order 11246, as amended.)

c. The contractor will encourage his present employees to refer minority group applicants for employment. Information and procedures with regard to referring minority group applicants will be discussed with employees.

5. Personnel Actions: Wages, working conditions, and employee benefits shall be established and administered, and personnel actions of every type, including hiring, upgrading, promotion, transfer, demotion, layoff, and termination, shall be taken without regard to race, color, religion, sex, national origin, age or disability. The following procedures shall be followed:

a. The contractor will conduct periodic inspections of project sites to insure that working conditions and employee facilities do not indicate discriminatory treatment of project site personnel.

b. The contractor will periodically evaluate the spread of wages paid within each classification to determine any evidence of discriminatory wage practices.

c. The contractor will periodically review selected personnel actions in depth to determine whether there is evidence of discrimination. Where evidence is found, the contractor will promptly take corrective action. If the review indicates that the discrimination may extend beyond the actions reviewed, such corrective action shall include all affected persons.

d. The contractor will promptly investigate all complaints of alleged discrimination made to the contractor in connection with his obligations under this contract, will attempt to resolve such complaints, and will take appropriate corrective action within a reasonable time. If the investigation indicates that the discrimination may affect persons other than the complainant, such corrective action shall include such other persons. Upon completion of each investigation, the contractor will inform every complainant of all of his avenues of appeal.

6. Training and Promotion:

a. The contractor will assist in locating, qualifying, and increasing the skills of minority group and women employees, and applicants for employment.

b. Consistent with the contractor's work force requirements and as permissible under Federal and State regulations, the contractor shall make full use of training programs, i.e., apprenticeship, and on-the-job training programs for the geographical area of contract performance. Where feasible, 25 percent of apprentices or trainees in each occupation shall be

in their first year of apprenticeship or training. In the event a special provision for training is provided under this contract, this subparagraph will be superseded as indicated in the special provision.

c. The contractor will advise employees and applicants for employment of available training programs and entrance requirements for each.

d. The contractor will periodically review the training and promotion potential of minority group and women employees and will encourage eligible employees to apply for such training and promotion.

7. Unions: If the contractor relies in whole or in part upon unions as a source of employees, the contractor will use his/her best efforts to obtain the cooperation of such unions to increase opportunities for minority groups and women within the unions, and to effect referrals by such unions of minority and female employees. Actions by the contractor either directly or through a contractor's association acting as agent will include the procedures set forth below:

a. The contractor will use best efforts to develop, in cooperation with the unions, joint training programs aimed toward qualifying more minority group members and women for membership in the unions and increasing the skills of minority group employees and women so that they may qualify for higher paying employment.

b. The contractor will use best efforts to incorporate an EEO clause into each union agreement to the end that such union will be contractually bound to refer applicants without regard to their race, color, religion, sex, national origin, age or disability.

c. The contractor is to obtain information as to the referral practices and policies of the labor union except that to the extent such information is within the exclusive possession of the labor union and such labor union refuses to furnish such information to the contractor, the contractor shall so certify to the SHA and shall set forth what efforts have been made to obtain such information.

d. In the event the union is unable to provide the contractor with a reasonable flow of minority and women referrals within the time limit set forth in the collective bargaining agreement, the contractor will, through independent recruitment efforts, fill the employment vacancies without regard to race, color, religion, sex, national origin, age or disability; making full efforts to obtain qualified and/or qualifiable minority group persons and women. (The DOL has held that it shall be no excuse that the union with which the contractor has a collective bargaining agreement providing for exclusive referral failed to refer minority employees.) In the event the union referral practice prevents the contractor from meeting the obligations pursuant to Executive Order 11246, as amended, and these special provisions, such contractor shall immediately notify the SHA.

8. Selection of Subcontractors, Procurement of Materials and Leasing of Equipment: The contractor shall not discriminate on the grounds of race, color, religion, sex, national origin, age or disability in the selection and retention of subcontractors, including procurement of materials and leases of equipment.

a. The contractor shall notify all potential subcontractors and suppliers of his/her EEO obligations under this contract.

b. Disadvantaged business enterprises (DBE), as defined in 49 CFR 23, shall have equal opportunity to compete for and perform subcontracts which the contractor enters into pursuant to this contract. The contractor will use his best efforts to solicit bids from

and to utilize DBE subcontractors or subcontractors with meaningful

minority group and female representation among their employees.

Contractors shall obtain lists of DBE construction firms from SHA

personnel.

c. The contractor will use his best efforts to ensure subcontractor compliance with their EEO obligations.

9. Records and Reports: The contractor shall keep such records as necessary to document compliance with the EEO requirements. Such records shall be retained for a period of three years following completion of the contract work and shall be available at reasonable times and places for inspection by authorized representatives of the SHA and the FHWA.

a. The records kept by the contractor shall document the following:

(1) The number of minority and non-minority group members and women employed in each work classification on the project;

(2) The progress and efforts being made in cooperation with unions, when applicable, to increase employment opportunities for minorities and women;

(3) The progress and efforts being made in locating, hiring, training,

qualifying, and upgrading minority and female employees; and

(4) The progress and efforts being made in securing the services of

DBE subcontractors or subcontractors with meaningful minority and

female representation among their employees.

b. The contractors will submit an annual report to the SHA each July for the duration of the project, indicating the number of minority, women, and non-minority group employees currently engaged in each work classification required by the contract work. This information is to be reported on Form FHWA-1391. If on-the-job training is being required by special provision, the contractor will be required to collect and report training data.

III. NONSEGREGATED FACILITIES

(Applicable to all Federal-aid construction contracts and to all related subcontracts of \$10,000 or more.)

a. By submission of this bid, the execution of this contract or subcontract, or the consummation of this material supply agreement or purchase order, as appropriate, the bidder, Federal-aid construction contractor, subcontractor, material supplier, or vendor, as appropriate, certifies that the firm does not maintain or provide for its employees any segregated facilities at any of its establishments, and that the firm does not permit its employees to perform their services at any location, under its control, where segregated facilities are maintained. The firm agrees that a breach of this certification is a violation of the EEO provisions of this contract. The firm further certifies that no employee will be denied access to adequate facilities on the basis of sex or disability.

b. As used in this certification, the term "segregated facilities" means any waiting rooms, work areas, restrooms and washrooms, restaurants and other eating areas, timeclocks, locker rooms, and other storage or dressing areas, parking lots, drinking fountains, recreation or entertainment areas, transportation, and housing facilities provided for employees which are segregated by explicit directive, or are, in fact, segregated on the basis of race, color, religion, national origin, age or disability, because of habit, local custom, or otherwise. The only exception will be for the disabled when the demands for accessibility override (e.g. disabled parking).

c. The contractor agrees that it has obtained or will obtain identical certification from proposed subcontractors or material suppliers prior to award of subcontracts or consummation of material supply agreements of \$10,000 or more and that it will retain such certifications in its files.

IV. PAYMENT OF PREDETERMINED MINIMUM WAGE

(Applicable to all Federal-aid construction contracts exceeding \$2,000 and to all related subcontracts, except for projects located

on roadways classified as local roads or rural minor collectors, which are exempt.)

1. General:

a. All mechanics and laborers employed or working upon the site of the work will be paid unconditionally and not less often than once a week and without subsequent deduction or rebate on any account [except such payroll deductions as are permitted by regulations (29 CFR 3) issued by the Secretary of Labor under the Copeland Act (40 U.S.C. 276c)] the full amounts of wages and bona fide fringe benefits (or cash equivalents thereof) due at time of payment. The payment shall be computed at wage rates not less than those contained in the wage determination of the Secretary of Labor (hereinafter "the wage determination") which is attached hereto and made a part hereof, regardless of any contractual relationship which may be alleged to exist between the contractor or its subcontractors and such laborers and mechanics. The wage determination (including any additional classifications and wage rates conformed under paragraph 2 of this Section IV and the DOL poster (WH-1321) or Form FHWA-1495) shall be posted at all times by the contractor and its subcontractors at the site of the work in a prominent and accessible place where it can be easily seen by the workers. For the purpose of this Section, contributions made or costs reasonably anticipated for bona fide fringe benefits under Section 1(b)(2) of the Davis-Bacon Act (40 U.S.C. 276a) on behalf of laborers or mechanics are considered wages paid to such laborers or mechanics, subject to the provisions of Section IV, paragraph 3b, hereof. Also, for the purpose of this Section, regular contributions made or costs incurred for more than a weekly period (but not less often than quarterly) under plans, funds, or programs, which cover the particular weekly period, are deemed to be constructively made or incurred during such weekly period. Such laborers and mechanics shall be paid the appropriate wage rate and fringe benefits on the wage determination for the classification of work actually performed, without regard to skill, except as provided in paragraphs 4 and 5 of this Section IV.

b. Laborers or mechanics performing work in more than one classification may be compensated at the rate specified for each classification for the time actually worked therein, provided, that the employer's payroll records accurately set forth the time spent in each classification in which work is performed.

c. All rulings and interpretations of the Davis-Bacon Act and related acts contained in 29 CFR 1, 3, and 5 are herein incorporated by reference in this contract.

2. Classification:

a. The SHA contracting officer shall require that any class of laborers or mechanics employed under the contract, which is not listed in the wage determination, shall be classified in conformance with the wage determination.

b. The contracting officer shall approve an additional classification, wage rate and fringe benefits only when the following criteria have been met:

(1) the work to be performed by the additional classification requested is not performed by a classification in the wage determination;

(2) the additional classification is utilized in the area by the construction industry;

(3) the proposed wage rate, including any bona fide fringe benefits, bears a reasonable relationship to the wage rates contained in the wage determination; and

(4) with respect to helpers, when such a classification prevails in the area in which the work is performed.

c. If the contractor or subcontractors, as appropriate, the laborers and mechanics (if known) to be employed in the additional classification or their representatives, and the

contracting officer agree on the classification and wage rate (including the amount designated for fringe benefits where appropriate), a report of the action taken shall be sent by the contracting officer to the DOL, Administrator of the Wage and Hour Division, Employment Standards Administration, Washington, D.C. 20210. The Wage and Hour Administrator, or an authorized representative, will approve, modify, or disapprove every additional classification action within 30 days of receipt and so advise the contracting officer or will notify the contracting officer within the 30-day period that additional time is necessary.

d. In the event the contractor or subcontractors, as appropriate, the laborers or mechanics to be employed in the additional classification or their representatives, and the contracting officer do not agree on the proposed classification and wage rate (including the amount designated for fringe benefits, where appropriate), the contracting officer shall refer the question, including the views of all interested parties and the recommendation of the contracting officer, to the Wage and Hour Administrator for determination. Said Administrator, or an authorized representative, will issue a determination within 30 days of receipt and so advised the contracting officer or will notify the contracting officer within the 30-day period that additional time is necessary.

e. The wage rate (including fringe benefits where appropriate) determined pursuant to paragraph 2c or 2d of this Section IV shall be paid to all workers performing work in the additional classification from the first day on which work is performed in the classification.

3. Payment of Fringe Benefits:

a. Whenever the minimum wage rate prescribed in the contract for a class of laborers or mechanics includes a fringe benefit which is not expressed as an hourly rate, the contractor or subcontractors, as appropriate, shall either pay the benefit as stated in the wage determination or shall pay another bona fide fringe benefit or an hourly case equivalent thereof.

b. If the contractor or subcontractor, as appropriate, does not make payments to a trustee or other third person, he/she may consider as a part of the wages of any laborer or mechanic the amount of any cost reasonably anticipated in providing bona fide fringe benefits under a plan or program, provided that the Secretary of Labor has found, upon the written request of the contractor, that the applicable standards of the Davis-Bacon Act have been met. The Secretary of Labor may require the contractor to set aside in a separate account assets for the meeting of obligations under the plan or program.

4. Apprentices and Trainees (Programs of the U.S. DOL) and Helpers:

a. Apprentices:

(1) Apprentices will be permitted to work at less than the predetermined rate for the work they performed when they are employed pursuant to and individually registered in a bona fide apprenticeship program registered with the DOL, Employment and Training Administration, Bureau of Apprenticeship and Training, or with a State apprenticeship agency recognized by the Bureau, or if a person is employed in his/her first 90 days of probationary employment as an apprentice in such an apprenticeship program, who is not individually registered in the program, but who has been certified by the Bureau of Apprenticeship and Training or a State apprenticeship agency (where appropriate) to be eligible for probationary employment as an apprentice.

(2) The allowable ratio of apprentices to journeyman-level employees on the job site in any craft classification shall not be greater than the ratio permitted to the contractor as to the entire work force under the registered program. Any

employee listed on a payroll at an apprentice wage rate, who is not registered or otherwise employed as stated above, shall be paid not less than the applicable wage rate listed in the wage determination for the classification of work actually performed. In addition, any apprentice performing work on the job site in excess of the ratio permitted under the registered program shall be paid not less than the applicable wage rate on the wage determination for the work actually performed. Where a contractor or subcontractor is performing construction on a project in a locality other than that in which its program is registered, the ratios and wage rates (expressed in percentages of the journeyman-level hourly rate) specified in the contractor's or subcontractor's registered program shall be observed.

(3) Every apprentice must be paid at not less than the rate specified in the registered program for the apprentice's level of progress, expressed as a percentage of the journeyman-level hourly rate specified in the applicable wage determination. Apprentices shall be paid fringe benefits in accordance with the provisions of the apprenticeship program. If the apprenticeship program does not specify fringe benefits, apprentices must be paid

the full amount of fringe benefits listed on the wage determination

for the applicable classification. If the Administrator for the Wage

and Hour Division determines that a different practice prevails for

the applicable apprentice classification, fringes shall be paid in accordance with that determination.

(4) In the event the Bureau of Apprenticeship and Training, or a State apprenticeship agency recognized by the Bureau, withdraws approval of an apprenticeship program, the contractor or subcontractor will no longer be permitted to utilize apprentices at less than the applicable predetermined rate for the comparable work performed by regular employees until an acceptable program is approved.

b. Trainees:

(1) Except as provided in 29 CFR 5.16, trainees will not be permitted to work at less than the predetermined rate for the work performed unless they are employed pursuant to and individually registered in a program which has received prior approval, evidenced by formal certification by the DOL, Employment and Training Administration.

(2) The ratio of trainees to journeyman-level employees on the job site shall not be greater than permitted under the plan approved by the Employment and Training Administration. Any employee listed on the payroll at a trainee rate who is not registered and participating in a training plan approved by the Employment and Training Administration shall be paid not less than the applicable wage rate on the wage determination for the classification of work actually performed. In addition, any trainee performing work on the job site in excess of the ratio permitted under the registered program shall be paid not less than the applicable wage rate on the wage determination for the work actually performed.

(3) Every trainee must be paid at not less than the rate specified in the approved program for his/her level of progress, expressed as a percentage of the journeyman-level hourly rate specified in the applicable wage determination. Trainees shall be paid fringe benefits in accordance with the provisions of the trainee program. If the trainee program does not mention fringe benefits, trainees shall be paid the full amount of fringe benefits listed on the wage determination unless the Administrator of the Wage and Hour Division determines that there is an apprenticeship program associated with the corresponding journeyman-level wage rate on the wage determination which provides for less than full fringe benefits for apprentices, in which cases such trainees shall receive the same fringe benefits as apprentices.

(4) In the event the Employment and Training Administration

withdraws approval of a training program, the contractor or subcontractor will no longer be permitted to utilize trainees at less than the applicable predetermined rate for the work performed until an acceptable program is approved.

c. Helpers:

Helpers will be permitted to work on a project if the helper classification is specified and defined on the applicable wage determination or is approved pursuant to the conformance procedure set forth in Section IV. 2. Any worker listed on a payroll at a helper wage rate, who is not a helper under a approved definition, shall be paid not less than the applicable wage rate on the wage determination for the classification of work actually performed.

5. Apprentices and Trainees (Programs of the U.S. DOT):

Apprentices and trainees working under apprenticeship and skill training programs which have been certified by the Secretary of Transportation as promoting EEO in connection with Federal-aid highway construction programs are not subject to the requirements of paragraph 4 of this Section IV. The straight time hourly wage rates for apprentices and trainees under such programs will be established by the particular programs. The ratio of apprentices and trainees to journeymen shall not be greater than permitted by the terms of the particular program.

6. Withholding:

The SHA shall upon its own action or upon written request of an authorized representative of the DOL withhold, or cause to be withheld, from the contractor or subcontractor under this contract or any other Federal contract with the same prime contractor or any other Federally-assisted contract subject to Davis-Bacon prevailing wage requirements which is held by the same prime contractor, as much of the accrued payments or advances as may be considered necessary to pay laborers and mechanics, including apprentices, trainee's and helpers, employed by the contractor or any subcontractor the full amount of wages required by the contract. In the event of failure to pay any laborer or mechanic, including any apprentice, trainee, or helper, employed or working on the site of the work, all or part of the wages required by the contract, the SHA contracting officer may, after written notice to the contractor, take such action as may be necessary to cause the suspension of any further payment, advance, or guarantee of funds until such violations have ceased.

7. Overtime Requirements:

No contractor or subcontractor contracting for any part of the contract work which may require or involve the employment of laborers, mechanics, watchmen, or guards (including apprentices, trainees, and helpers described in paragraphs 4 and 5 above) shall require or permit any laborer, mechanic, watchman, or guard in any workweek in which he/she is employed on such work, to work in excess of 40 hours in such workweek unless such laborer, mechanic, watchman, or guard receives compensation at a rate not less than one-and-one-half times his/her basic rate of pay for all hours worked in excess of 40 hours in such workweek.

8. Violation:

Liability for Unpaid Wages; Liquidated Damages: In the event of any violation of the clause set forth in paragraph 7 above, the contractor and any subcontractor responsible thereof shall be liable to the affected employee for his/her unpaid wages. In addition, such contractor and subcontractor shall be liable to the United States (in the case of work done under contract for the District of Columbia or a territory, to such District or to such territory) for liquidated damages. Such liquidated damages shall be computed with respect to each individual laborer, mechanic, watchman, or guard employed in violation of the clause set forth in paragraph 7, in the sum of \$10 for each calendar day on which such employee was required or

permitted to work in excess of the standard work week of 40 hours without payment of the overtime wages required by the clause set forth in paragraph 7.

9. Withholding for Unpaid Wages and Liquidated Damages:

The SHA shall; upon its own action or upon written request of any authorized representative of the DOL withhold, or cause to be withheld, from any monies payable on account of work performed by the contractor or subcontractor under any such contract or any other Federal contract with the same prime contractor, or any other Federally-assisted contract subject to the Contract Work Hours and Safety Standards Act, which is held by the same prime contractor, such sums as may be determined to be necessary to satisfy any liabilities of such contractor or subcontractor for unpaid wages and liquidated damages as provided in the clause set forth in paragraph 8 above.

V. STATEMENTS AND PAYROLLS

(Applicable to all Federal-aid construction contracts exceeding \$2,000 and to all related subcontracts, except for projects located on roadways classified as local roads or rural collectors, which are exempt.)

1. Compliance with Copeland Regulations (29 CFR 3):

The contractor shall comply with the Copeland Regulations of the Secretary of Labor which are herein incorporated by reference.

2. Payrolls and Payroll Records:

- a. Payrolls and basic records relating thereto shall be maintained by the contractor and each subcontractor during the course of the work and preserved for a period of 3 years from the date of completion of the contract for all laborers, mechanics, apprentices, trainees, watchmen, helpers, and guards working at the site of the work.
- b. The payroll records shall contain the name, social security number, and address of each such employee; his or her correct classification; hourly rates of wages paid (including rates of contributions or costs anticipated for bona fide fringe benefits or cash equivalent thereof the types described in Section 1(b)(2)(B) of the Davis Bacon Act); daily and weekly number of hours worked; deductions made; and actual wages paid. In addition, for Appalachian contracts, the payroll records shall contain a notation indicating whether the employee does, or does not, normally reside in the labor area as defined in Attachment A, paragraph 1. Whenever the Secretary of Labor, pursuant to Section IV, paragraph 3b, has found that the wages of any laborer or mechanic include the amount of any costs reasonably anticipated in providing benefits under a plan or program described in Section 1(b)(2)(B) of the Davis Bacon Act, the contractor and each subcontractor shall maintain records which show that the commitment to provide such benefits is enforceable, that the plan or program is financially responsible, that the plan or program has been communicated in writing to the laborers or mechanics affected, and show the cost anticipated or the actual cost incurred in providing benefits. Contractors or subcontractors employing apprentices or trainees under approved programs shall maintain written evidence of the registration of apprentices and trainees, and ratios and wage rates prescribed in the applicable programs.
- c. Each contractor and subcontractor shall furnish, each week in which any contract work is performed, to the SHA resident engineer a payroll of wages paid each of its employees (including apprentices trainees, and helpers, described in Section IV, paragraphs 4 and 5, and watchmen and guards engaged on work during the preceding weekly payroll period). The payroll submitted shall set out accurately and completely

all of the information required to be maintained under paragraph 2b of this Section V. This information may be submitted in any form desired. Optional Form WH-347 is available for this purpose and may be purchased from the Superintendent of Documents (Federal stock number 029-005-0014-1), U.S. Government Printing Office, Washington, D.C. 20402. The prime contractor is responsible for submitting payroll copies of all subcontractors.

d. Each payroll submitted shall be accompanied by a "Statement of Compliance," signed by the Contractor or subcontractor or his/her agent who pays or supervises the payment of the persons employed under the contract and shall certify the following:

- (1) that the payroll for the payroll period contains the information required to be maintained under paragraph 2b of this Section V and that such information is correct and complete;
- (2) that such laborer or mechanic (including each helper, apprentice, and trainee) employed on the contract during the payroll period has been paid the full weekly wages earned, without rebate, either directly or indirectly, and that no deductions have been made either directly or indirectly from the full wages earned, other than permissible deductions as set forth in the Regulations, 29 CFR 3;
- (3) that each laborer or mechanic has been paid not less than the applicable wage rate and fringe benefits or cash equivalent for the classification of work performed, as specified in the applicable wage determination incorporated into the contract.

e. The weekly submission of a properly executed certification set forth on the reverse side of Optional Form WH-347 shall satisfy the requirement for submission of the "Statement of Compliance" required by paragraph 2d of this Section V.

f. The falsification of any of the above certifications may subject the contractor to civil or criminal prosecution under 18 U.S. C. 1001 and 31 U.S.C. 231.

g. The contractor or subcontractor shall make the records required under paragraph 2b of this Section V available for inspection, copying, or transcription by authorized representatives of the SHA, the FHWA, or the DOL, and shall permit such representatives to interview employees during working hours on the job. If the contractor or subcontractor fails to submit the required records or to make them available, the SHA, the FHWA, the DOL, or all may, after written notice to the contractor, sponsor, applicant, or owner, take such actions as may be necessary to cause the suspension of any further payment, advance, or guarantee of funds. Furthermore, failure to submit the required records upon request or to make such records available may be grounds for debarment action pursuant to 29 CFR 5.12.

VI. RECORD OF MATERIALS, SUPPLIES, AND LABOR

1. On all federal-aid contracts on the national highway system, except those which provide solely for the installation of protective devices at railroad grade crossings, those which are constructed on a force account or direct labor basis, highway beautification contracts, and contracts for which the total final construction cost for roadway and bridge is less than \$1,000,000 (23 CFR 635) the contractor shall:

- a. Become familiar with the list of specific materials and supplies contained in Form FHWA-47, "Statement of Materials and Labor Used by Contractor of Highway Construction Involving Federal Funds," prior to the commencement of work under this contract.
- b. Maintain a record of the total cost of all materials and supplies purchased for and incorporated in the work, and also of the quantities of those specific materials and supplies listed on Form FHWA-47, and in the units shown on Form FHWA-47.
- c. Furnish, upon the completion of the contract, to the SHA resident engineer on Form FHWA-47 together with the data

required in paragraph 1b relative to materials and supplies, a final labor summary of all contract work indicating the total hours worked and the total amount earned.

2. At the prime contractor's option, either a single report covering all contract work or separate reports for the contractor and for each subcontract shall be submitted.

VII. SUBLETTING OR ASSIGNING THE CONTRACT

1. The contractor shall perform with its own organization contract work amounting to not less than 30 percent (or a greater percentage if specified elsewhere in the contract) of the total original contract price, excluding any specialty items designated by the State. Specialty items may be performed by subcontract and the amount of any such specialty items performed may be deducted from the total original contract price before computing the amount of work required to be performed by the contractors' own organization (23 CFR 635).

a. "Its own organization" shall be construed to include only workers employed and paid directly by the prime contractor and equipment owned or rented by the prime contractor, with or without operators. Such term does not include employees or equipment of a subcontractor, assignee, or agent of the prime contractor.

b. "Specialty Items" shall be construed to be limited to work that requires highly specialized knowledge, abilities, or equipment not ordinarily available in the type of contracting organizations qualified and expected to bid on the contract as a whole and in general are to be limited to minor components of the overall contract.

2. The contract amount upon which the requirements set forth in paragraph 1 of Section VII is computed includes the cost of material and manufactured products which are to be purchased or produced by the contractor under the contract provisions.

3. The contractor shall furnish (a) a competent superintendent or supervisor who is employed by the firm, has full authority to direct performance of the work in accordance with the contract requirements, and is in charge of all construction operations (regardless of who performs the work) and (b) such other of its own organizational resources (supervision, management, and engineering services) as the SHA contracting officer determines is necessary to assure the performance of the contract.

4. No portion of the contract shall be sublet, assigned or otherwise disposed of except with the written consent of the SHA contracting officer, or authorized representative, and such consent when given shall not be construed to relieve the contractor of any responsibility for the fulfillment of the contract. Written consent will be given only after the SHA has assured that each subcontract is evidenced in writing and that it contains all pertinent provisions and requirements of the prime contract.

VIII. SAFETY: ACCIDENT PREVENTION

1. In the performance of this contract the contractor shall comply with all applicable Federal, State, and local laws governing safety, health, and sanitation (23 CFR 635). The contractor shall provide all safeguards, safety devices and protective equipment and take any other needed actions as it determines, or as the SHA contracting officer may determine, to be reasonably necessary to protect the life and health of employees on the job and the safety of the public and to protect property in connection with the performance of the work covered by the contract.

2. It is a condition of this contract, and shall be made a condition of each subcontract, which the contractor enters into pursuant to this contract, that the contractor and any subcontractor shall not permit any employee, in performance of the contract, to work in

surroundings or under conditions which are unsanitary, hazardous or dangerous to his/her health or safety, as determined under construction safety and health standards (29 CFR 1926) promulgated by the Secretary of Labor, in accordance with Section 107 of the Contract Work Hours and Safety Standards Act (40 U.S.C. 333).

3. Pursuant to 29 CFR 1926.3, it is a condition of this contract that the Secretary of Labor or authorized representative thereof, shall have right of entry to any site of contract performance to inspect or investigate the matter of compliance with the construction safety and health standards and to carry out the duties of the Secretary under Section 107 of the Contract Work Hours and Safety Standards Act (40 U.S.C. 333).

IX. FALSE STATEMENTS CONCERNING HIGHWAY PROJECTS

In order to assure high quality and durable construction in conformity with approved plans and specifications and a high degree of reliability on statements and representations made by engineers, contractors, suppliers, and workers on Federal-aid highway projects, it is essential that all persons concerned with the project perform their functions as carefully, thoroughly, and honestly as possible. Willful falsification, distortion, or misrepresentation with respect to any facts related to the project is a violation of Federal law. To prevent any misunderstanding regarding the seriousness of these and similar acts, the following notice shall be posted on each Federal-aid highway project (23 CFR 635) in one or more places where it is readily available to all persons concerned with the project:

NOTICE TO ALL PERSONNEL ENGAGED ON FEDERAL-AID HIGHWAY PROJECTS

18 U.S.C. 1020 reads as follows:

“Whoever, being an officer, agent or employee of the United States, or of any State or Territory, or whoever, whether a person, association, firm, or corporation, knowingly makes any false statement, false representation, or false report as to the character, quality, quantity, or cost of the material used or to be used, or the quantity or quality of the work performed or to be performed, or the cost thereof in connection with the submission of plans, maps, specifications, contracts, or costs of construction on any highway or related project submitted for approval to the Secretary of Transportation; or

Whoever knowingly makes any false statement, false representation, false report or false claim with respect to the character, quality, quantity, or cost of any work performed or to be performed, or materials furnished or to be furnished, in connection with the construction of any highway or related project approved by the Secretary of Transportation; or

Whoever knowingly makes any false statement or false representation as to material fact in any statement, certificate, or report submitted pursuant to provisions of the Federal-aid Roads Act approved July 1, 1916, (39 Stat. 355), as amended and supplemented;

Shall be fined not more than \$10,000 or imprisoned not more than 5 years or both.”

X. IMPLEMENTATION OF CLEAN AIR ACT AND FEDERAL WATER POLLUTION CONTROL ACT

(Applicable to all Federal-aid construction contracts and to all related subcontracts of \$100,000 or more).

By submission of this bid or the execution of this contract, or

subcontract, as appropriate, the bidder, Federal-aid construction contractor, or subcontractor, as appropriate, will be deemed to have stipulated as follows:

1. That any facility that is or will be utilized in the performance of this contract, unless such contract is exempt under the Clean Air Act, as amended (42 U.S.C. 1857 *et seq.*, as amended by Pub.L. 91-604), and under the Federal Water Pollution Control Act, as amended (33 U.S.C. 1251 *et seq.*, as amended by Pub.L. 92-500), Executive Order 11738, and regulations in implementation thereof (40 CFR 15) is not listed, on the date of contract award, on the U.S. Environmental Protection Agency (EPA) List of Violating Facilities pursuant to 40 CFR 15.20.

2. That the firm agrees to comply and remain in compliance with all the requirements of Section 114 of the Clean Air Act and Section 308 of the Federal Water Pollution Control Act and all regulations and guidelines listed thereunder.

3. That the firm shall promptly notify the SHA of the receipt of any communication from the Director, Office of Federal Activities, EPA indicating that a facility that is or will be utilized for the contract is under consideration to be listed on the EPA List of Violating Facilities.

4. That the firm agrees to include or cause to be included the requirements of paragraph 1 through 4 of this Section X in every nonexempt subcontract, and further agrees to take such action as the government may direct as a means of enforcing such requirements.

XI. CERTIFICATION REGARDING DEBARMENT, SUSPENSION, INELIGIBILITY AND VOLUNTARY EXCLUSION

1. Instructions for Certification - Primary Covered Transactions:

(Applicable to all Federal-aid contracts - 49 CFR 29)

- a. By signing and submitting this proposal, the prospective primary participant is providing the certification set out below.
- b. The inability of a person to provide the certification set out below will not necessarily result in denial of participation in this covered transaction. The prospective participant shall submit an explanation of why it cannot provide the certification set out below. The certification or explanation will be considered in connection with the department or agency's determination whether to enter into this transaction. However, failure of the prospective primary participant to furnish a certification or an explanation shall disqualify such a person from participation in this transaction.
- c. The certification in this clause is a material representation of fact upon which reliance was placed when the department or agency determined to enter into this transaction. If it is later determined that the prospective primary participant knowingly rendered an erroneous certification, in addition to other remedies available to the Federal Government, the department or agency may terminate this transaction for cause of default.
- d. The prospective primary participant shall provide immediate written notice to the department or agency to whom this proposal is submitted if any time the prospective primary participant learns that its certification was erroneous when submitted or has become erroneous by reason of changed circumstances.
- e. The terms "covered transaction," "debarred," "suspended," "ineligible," "lower tier covered transaction," "participant," "person," "primary covered transaction," "principal," "proposal," and "voluntarily excluded," as used in this clause, have the meanings set out in the Definitions and Coverage sections of rules implementing Executive Order 12549. You may contact the department or agency to which this proposal

is submitted for assistance in obtaining a copy of those regulations.

f. The prospective primary participant agrees by submitting this proposal that, should the proposed covered transaction be entered into, it shall not knowingly enter into any lower tier covered transaction with a person who is debarred, suspended, declared ineligible, or voluntarily excluded from participation in this covered transaction, unless authorized by the department or agency entering into this transaction.

g. The prospective primary participant further agrees by submitting this proposal that it will include the clause titled "Certification Regarding Debarment, Suspension, Ineligibility and Voluntary Exclusion-Lower Tier Covered Transaction," provided by the department or agency entering into this covered transaction, without modification in all lower tier covered transactions

and in all solicitations for lower tier covered transactions.

h. A participant in a covered transaction may rely upon a certification of a prospective participant in a lower tier covered transaction that is not debarred, suspended, ineligible, or voluntarily excluded from the covered transaction, unless it knows that the certification is erroneous. A participant may decide the method and frequency by which it determines the eligibility of its principals. Each participant may, but is not required to, check the nonprocurement portion of the "Lists of Parties Excluded from Federal Procurement or Nonprocurement Programs" (Nonprocurement List) which is compiled by the General Services Administration.

i. Nothing contained in the foregoing shall be construed to require establishment of a system of records in order to render in good faith the certification required by this clause. The knowledge and information of participant is not required to exceed that which is normally possessed by a prudent person in the ordinary course of business dealings.

j. Except for transactions authorized under paragraph f of these instructions, if a participant in a covered transaction knowingly enters into a lower tier covered transaction with a person who is suspended, debarred, ineligible, or voluntarily excluded from participation in this transaction, in addition to other remedies available to the Federal Government, the department or agency may terminate this transaction for cause or default.

Certification Regarding Debarment, Suspension, Ineligibility and Voluntary Exclusion-Primary Covered Transactions

1. The prospective primary participant certifies to the best of its knowledge and belief, that it and its principals:

- a. Are not presently debarred, suspended, proposed for debarment, declared ineligible, or voluntarily excluded from covered transactions by any Federal department or agency;
- b. Have not within a 3-year period preceding this proposal been convicted of or had a civil judgment rendered against them for commission of fraud or a criminal offense in connection with obtaining, attempting to obtain, or performing a public (Federal, State or local) transaction or contract under a public transaction; violation of Federal or State antitrust statutes or commission of embezzlement, theft, forgery, bribery, falsification or destruction of records, making false statements, or receiving stolen property;
- c. Are not presently indicted for or otherwise criminally or civilly charged by a governmental entity (Federal, State or local) with commission of any of the offenses enumerated in paragraph 1b of this certification; and
- d. Have not within a 3-year period preceding this application/proposal had one or more public transactions (Federal, State or local) terminated for cause or default.

to any of the statements in this certification, such prospective participant shall attach an explanation to this proposal.

2. Instructions for Certification - Lower Tier Covered Transactions:

(Applicable to all subcontracts, purchase orders and other lower tier transactions of \$25,000 or more - 49 CFR 29)

a. By signing and submitting this proposal, the prospective lower tier is providing the certification set out below.

b. The certification in this clause is a material representation of fact upon which reliance was placed when this transaction was entered into. If it is later determined that the prospective lower tier participant knowingly rendered an erroneous certification, in addition to other remedies available to the Federal Government, the department, or agency with which this transaction originated may pursue available remedies, including suspension and/or debarment.

c. The prospective lower tier participant shall provide immediate written notice to the person to which this proposal is submitted if at any time the prospective lower tier participant learns that its certification was erroneous by reason of changed circumstances.

d. The terms "covered transaction," "debarred," "suspended," "ineligible," "primary covered transaction," "participant," "person," "principal," "proposal," and "voluntarily excluded," as used in this clause, have the meanings set out in the Definitions and Coverage sections of rules implementing Executive Order 12549. You may contact the person to which this proposal is submitted for assistance in obtaining a copy of those regulations.

e. The prospective lower tier participant agrees by submitting this proposal that, should the proposed covered transaction be entered into, it shall not knowingly enter into any lower tier covered transaction with a person who is debarred, suspended, declared ineligible, or voluntarily excluded from participation in this covered transaction, unless authorized by the department or agency with which this transaction originated.

f. The prospective lower tier participant further agrees by submitting this proposal that it will include this clause titled "Certification Regarding Debarment, Suspension, Ineligibility and Voluntary Exclusion-Lower Tier Covered Transaction," without modification, in all lower tier covered transactions and in all solicitations for lower tier covered transactions.

g. A participant in a covered transaction may rely upon a certification of a prospective participant in a lower tier covered transaction that is not debarred, suspended, ineligible, or voluntarily excluded from the covered transaction, unless it knows that the certification is erroneous. A participant may decide the method and frequency by which it determines the eligibility of its principals. Each participant may, but is not required to, check the Nonprocurement List.

h. Nothing contained in the foregoing shall be construed to require establishment of a system of records in order to render in good faith the certification required by this clause. The knowledge and information of participant is not required to exceed that which is normally possessed by a prudent person in the ordinary course of business dealing.

i. Except for transactions authorized under paragraph e of these instructions, if a participant in a covered transaction knowingly enters into a lower tier covered transaction with a person who is suspended, debarred, ineligible, or voluntarily excluded from participation in this transaction, in addition to other remedies available to the Federal Government, the department or agency with which this transaction originated may pursue available remedies, including suspension and/or debarment.

2. Where the prospective primary participant is unable to certify

**Certification Regarding Debarment, Suspension, Ineligibility And
Voluntary Exclusion-Lower Tier Covered Transactions:**

1. The prospective lower tier participant certifies, by submission of this proposal, that neither it nor its principals is presently debarred, suspended, proposed for debarment, declared ineligible, or voluntarily excluded from participation in this transaction by any Federal department or agency.

2. Where the prospective lower tier participant is unable to certify to any of the statements in this certification, such prospective participant shall attach an explanation to this proposal.

**XII. CERTIFICATION REGARDING USE OF CONTRACT FUNDS FOR
LOBBYING**

(Applicable to all Federal-aid construction contracts and to all related subcontracts which exceed \$100,000 - 49 CFR 20)

1. The prospective participant certifies, by signing and submitting this bid or proposal, to the best of his or her knowledge and belief, that:

a. No Federal appropriated funds have been paid or will be paid, by or on behalf of the undersigned, to any person for influencing or attempting to influence an officer or employee of any Federal agency, a Member of Congress, an officer or employee of Congress, or an employee of a Member of Congress in connection with the awarding of any Federal contract, the making of any Federal grant, the making of any Federal loan, the entering into of any cooperative agreement, and the extension, continuation, renewal, amendment, or modification of any Federal contract, grant, loan, or cooperative agreement.

b. If any funds other than Federal appropriated funds have been paid or will be paid to any person for influencing or attempting to influence an officer or employee of any Federal agency, a Member of Congress, an officer or employee of Congress, or an employee of a Member of Congress in connection with this Federal contract, grant, loan, or cooperative agreement, the undersigned shall complete and submit Standard Form-LLL, "Disclosure Form to Report Lobbying," in accordance with its instructions.

2. This certification is a material representation of fact upon which reliance was placed when this transaction was made or entered into. Submission of this certification is a prerequisite for making or entering into this transaction imposed by 31 U.S.C. 1352. Any person who fails to file the required certification shall be subject to a civil penalty of not less than \$10,000 and not more than \$100,000 for each such failure.

3. The prospective participant also agrees by submitting his or her bid or proposal that he or she shall require that the language of this certification be included in all lower tier subcontracts, which exceed \$100,000 and that all such recipients shall certify and disclose accordingly.

**MINIMUM WAGES FOR FEDERAL AND FEDERALLY
ASSISTED CONSTRUCTION CONTRACTS**

This project is funded, in part, with Federal-aid funds and, as such, is subject to the provisions of the Davis-Bacon Act of March 3, 1931, as amended (46 Sta. 1494, as amended, 40 U.S.C. 276a) and of other Federal statutes referred to in a 29 CFR Part 1, Appendix A, as well as such additional statutes as may from time to time be enacted containing provisions for the payment of wages determined to be prevailing by the Secretary of Labor in accordance with the Davis-Bacon Act and pursuant to the provisions of 29 CFR Part 1. The prevailing rates and fringe benefits shown in the General Wage Determination Decisions issued by the U.S. Department of Labor shall, in accordance with the provisions of the foregoing statutes, constitute the minimum wages payable on Federal and federally assisted construction projects to laborers and mechanics of the specified classes engaged on contract work of the character and in the localities described therein.

General Wage Determination Decisions, modifications and supersedes decisions thereto are to be used in accordance with the provisions of 29 CFR Parts 1 and 5. Accordingly, the applicable decision, together with any modifications issued, must be made a part of every contract for performance of the described work within the geographic area indicated as required by an applicable DBRA Federal prevailing wage law and 29 CFR Part 5. The wage rates and fringe benefits contained in the General Wage Determination Decision shall be the minimum paid by contractors and subcontractors to laborers and mechanics.

NOTICE

The most current **General Wage Determination Decisions** (wage rates) are available on the IDOT web site. They are located on the Letting and Bidding page at <http://www.dot.state.il.us/desenv/delett.html>.

In addition, ten (10) days prior to the letting, the applicable Federal wage rates will be e-mailed to subscribers. It is recommended that all contractors subscribe to the Federal Wage Rates List or the Contractor's Packet through IDOT's subscription service.

PLEASE NOTE: if you have already subscribed to the Contractor's Packet you will automatically receive the Federal Wage Rates.

The instructions for subscribing are at <http://www.dot.state.il.us/desenv/subsc.html>.

If you have any questions concerning the wage rates, please contact IDOT's Chief Contract Official at 217-782-7806.