

CITY OF AURORA AURORA, ILLINOIS

CONSTRUCTION PLANS FOR AURORA MUNICIPAL AIRPORT

REHABILITATE AIRFIELD SIGNAGE INCLUDING PAVEMENT MARKING UPDATES

ILLINOIS PROJECT: ARR-4421
 S.B.G. PROJECT: 3-17-SBGP-XX

JUNE 5, 2015

INDEX TO SHEETS

- 1 COVER SHEET
- 2 SITE PLAN/SUMMARY OF QUANTITIES
- 3 SEQUENCE OF CONSTRUCTION
- 4 SEQUENCE OF CONSTRUCTION GENERAL NOTES
- 5 SEQUENCE OF CONSTRUCTION DETAILS
- 6 INDEX TO AIRFIELD SIGNING
- 7 PROPOSED SIGNAGE PLAN - SHEET 1
- 8 PROPOSED SIGNAGE PLAN - SHEET 2
- 9 PROPOSED SIGNAGE PLAN - SHEET 3
- 10 ELECTRICAL DETAILS - SHEET 1
- 11 ELECTRICAL DETAILS - SHEET 2
- 12 AIRFIELD SIGNAGE SCHEDULE AND PAVEMENT MARKING DETAILS
- 13 STORMWATER POLLUTION PREVENTION NOTES AND DETAILS



Know what's below.
 Call before you dig.

J.U.L.I.E.
 JOINT UTILITY LOCATING
 INFORMATION FOR EXCAVATORS
 www.illinois1call.com

THE LOCATION, SIZE AND TYPE OF MATERIAL OF EXISTING UNDERGROUND UTILITIES INDICATED ON THE PLANS IS NOT REPRESENTED AS BEING ACCURATE, SUFFICIENT OR COMPLETE IT SHALL BE THE CONTRACTOR'S RESPONSIBILITY TO DETERMINE ACTUAL LOCATIONS OF ALL SUCH FACILITIES, INCLUDING SERVICE CONNECTIONS TO UNDERGROUND UTILITIES. PRIOR TO CONSTRUCTION, THE CONTRACTOR SHALL NOTIFY UTILITY COMPANIES OF HIS OPERATIONAL PLANS, OBTAIN FROM RESPECTIVE UTILITY COMPANIES DETAILED INFORMATION AND ASSISTANCE RELATIVE TO THE LOCATION OF THEIR FACILITIES AND THE WORKING SCHEDULE OF THE COMPANIES FOR REMOVAL OR ADJUSTMENT WHERE REQUIRED. IN THE EVENT AN UNEXPECTED UTILITY INTERFERENCE IS ENCOUNTERED DURING CONSTRUCTION, THE CONTRACTOR SHALL IMMEDIATELY NOTIFY THE UTILITY COMPANY OF JURISDICTION AND THE ONE-CALL NOTICE SYSTEM. THE ENGINEER SHALL ALSO BE IMMEDIATELY NOTIFIED. ANY SUCH UTILITY OR SERVICES SHALL BE RESTORED TO SERVICE AT ONCE AND PAID FOR BY THE CONTRACTOR AT NO ADDITIONAL COST TO THE CONTRACT.

CALL J.U.L.I.E BEFORE EXCAVATING
 AT 811

AURORA MUNICIPAL AIRPORT

SECTION: 17 AND 18 COUNTY: KANE
 RANGE: 7 EAST U.S. ROUTE 30
 TOWNSHIP: 38 NORTH SUGAR GROVE TOWNSHIP

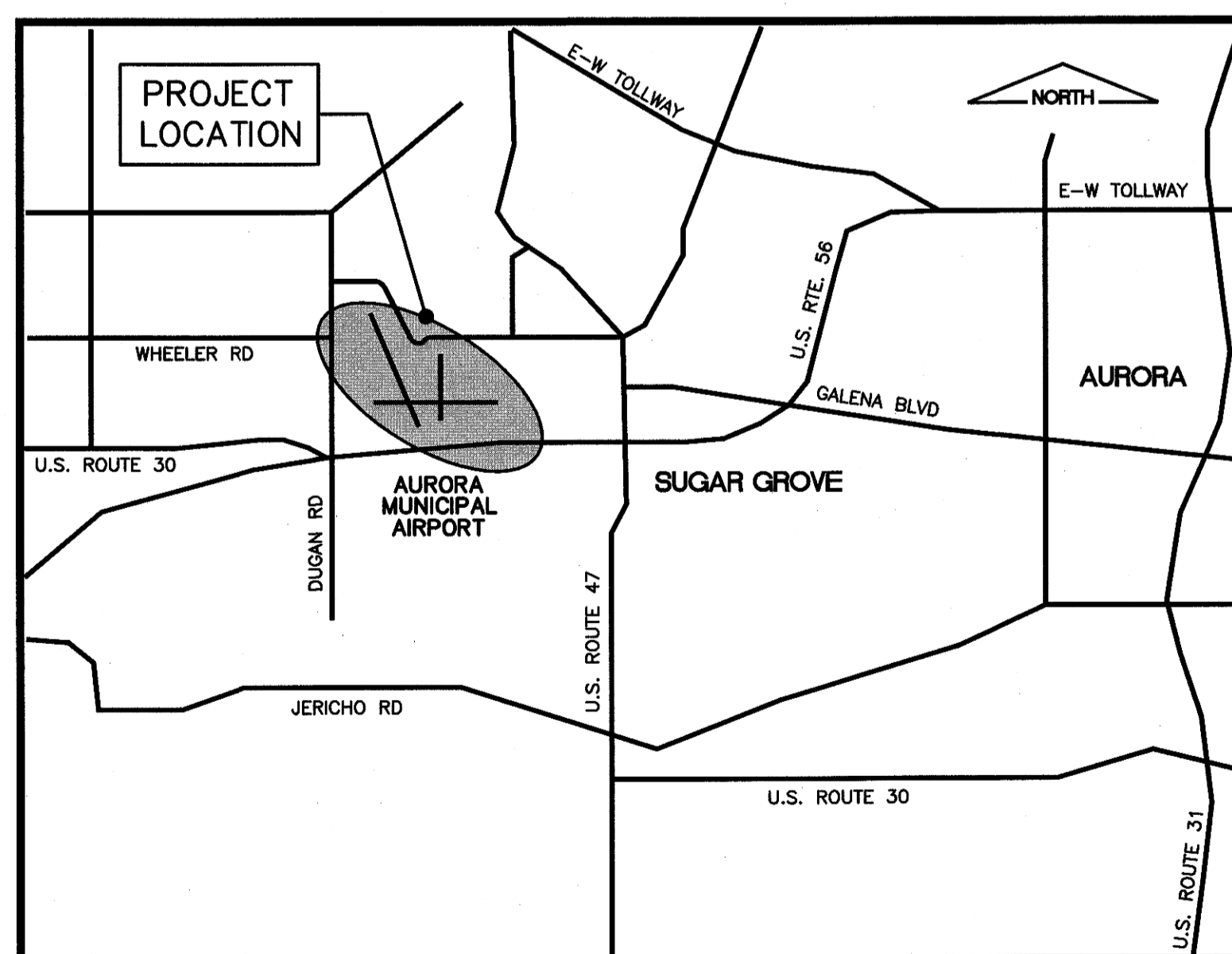

LOCATION MAP

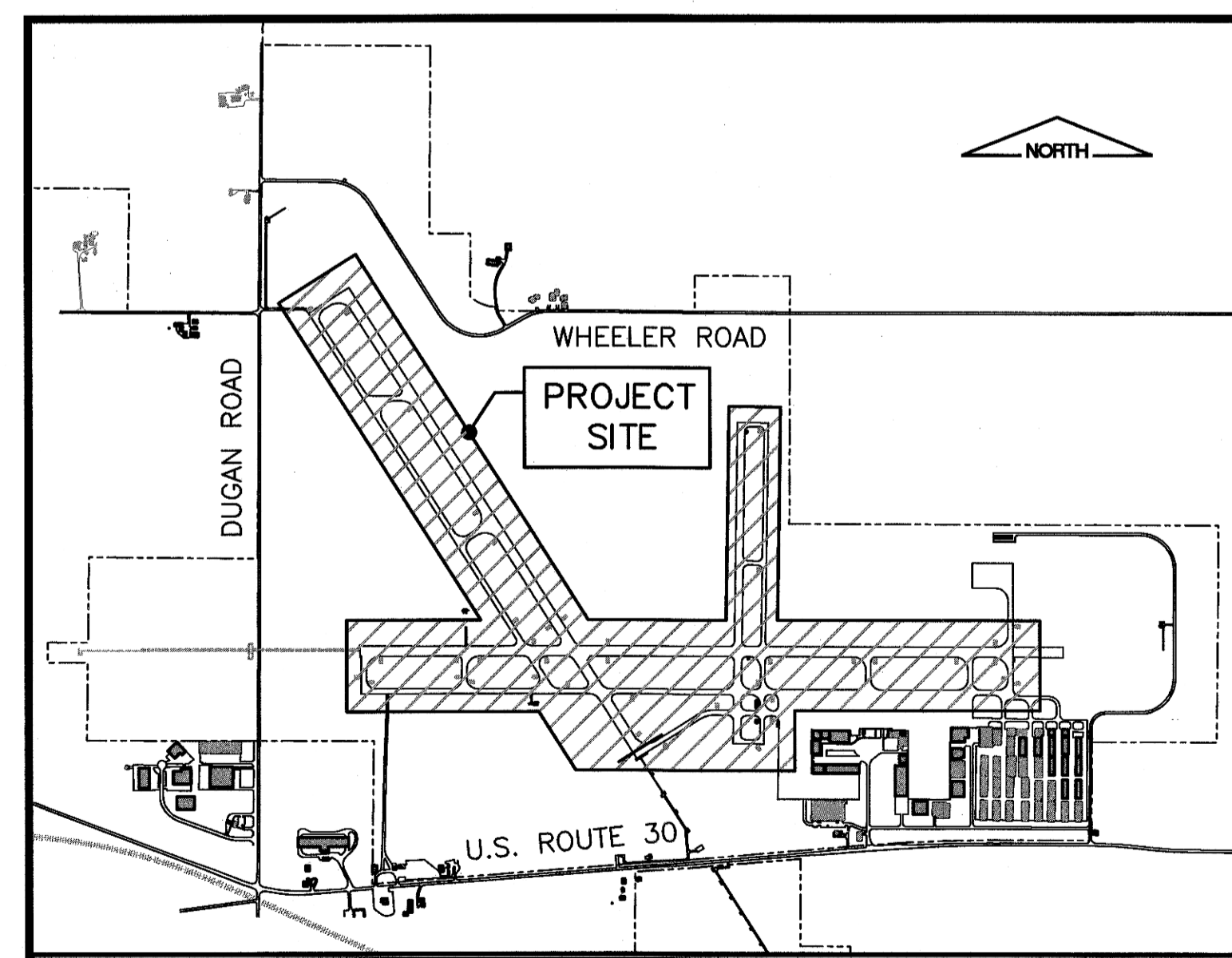

SITE PLAN



D. Kyle Peabody
 6-10-15
 EXPIRES 11-30-15

14285-02

CMT
 CRAWFORD, MURPHY & TILLY, INC.
 CONSULTING ENGINEERS
 License No. 184-000613

SPRINGFIELD, IL AURORA, IL CHICAGO, IL COLUMBUS, OH EDWARDSVILLE, IL
 INDIANAPOLIS, IN PEORIA, IL ROCKFORD, IL ST. LOUIS, MO SPRINGFIELD, MO

SUBMITTED BY *D. Kyle Peabody*
 D. KYLE PEABODY, P.E.

DATE June 10 2015

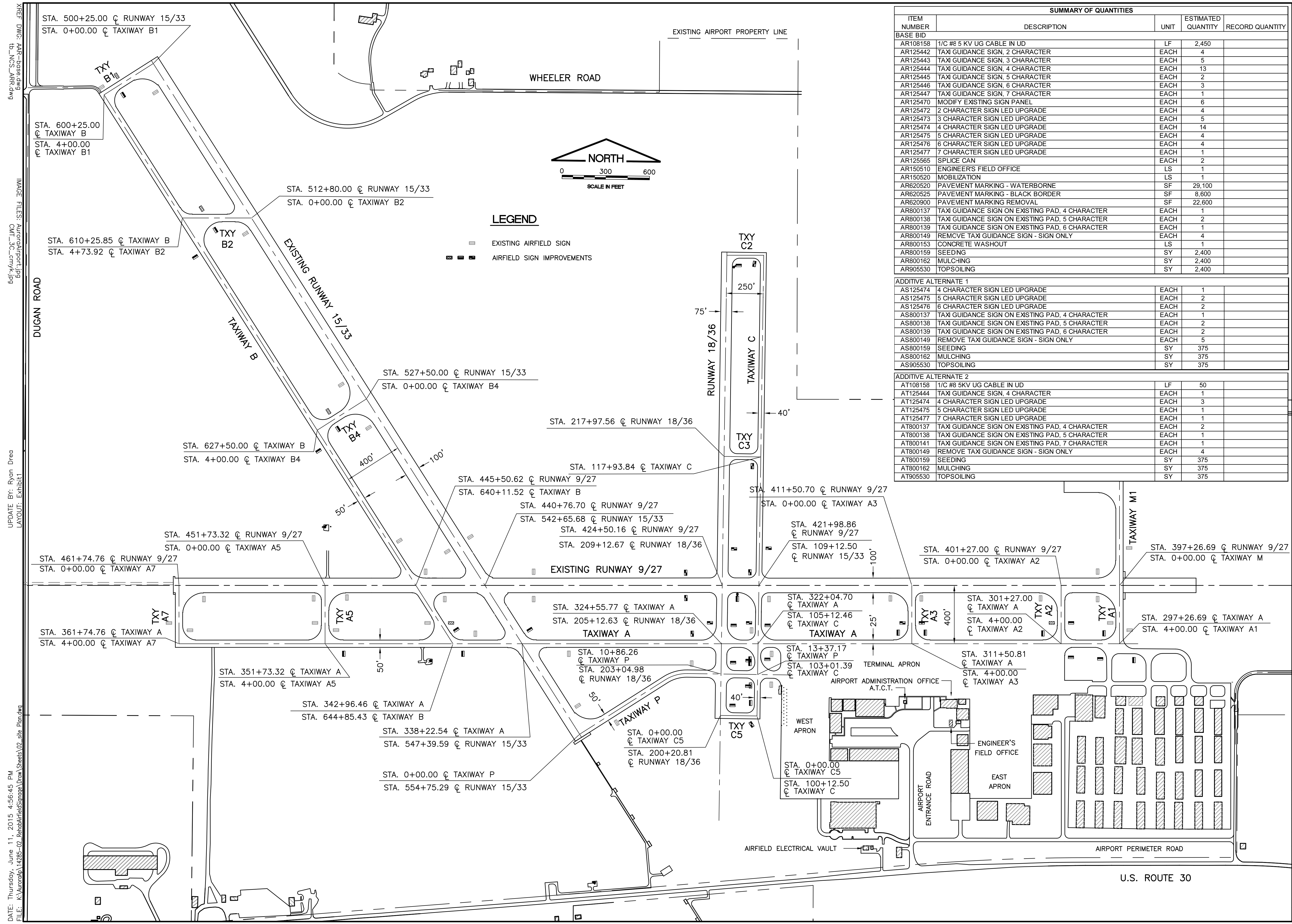

SUMMARY OF QUANTITIES				
ITEM NUMBER	DESCRIPTION	UNIT	ESTIMATED QUANTITY	RECORD QUANTITY
BASE BID				
AR108158	1/C #5 KV UG CABLE IN UD	LF	2,450	
AR125442	TAXI GUIDANCE SIGN, 2 CHARACTER	EACH	4	
AR125443	TAXI GUIDANCE SIGN, 3 CHARACTER	EACH	5	
AR125444	TAXI GUIDANCE SIGN, 4 CHARACTER	EACH	13	
AR125445	TAXI GUIDANCE SIGN, 5 CHARACTER	EACH	2	
AR125446	TAXI GUIDANCE SIGN, 6 CHARACTER	EACH	3	
AR125447	TAXI GUIDANCE SIGN, 7 CHARACTER	EACH	1	
AR125470	MODIFY EXISTING SIGN PANEL	EACH	6	
AR125472	2 CHARACTER SIGN LED UPGRADE	EACH	4	
AR125473	3 CHARACTER SIGN LED UPGRADE	EACH	5	
AR125474	4 CHARACTER SIGN LED UPGRADE	EACH	14	
AR125475	5 CHARACTER SIGN LED UPGRADE	EACH	4	
AR125476	6 CHARACTER SIGN LED UPGRADE	EACH	4	
AR125477	7 CHARACTER SIGN LED UPGRADE	EACH	1	
AR125565	SPLICE CAN	EACH	2	
AR150510	ENGINEER'S FIELD OFFICE	LS	1	
AR150520	MOBILIZATION	LS	1	
AR820520	PAVEMENT MARKING - WATERBORNE	SF	29,100	
AR820525	PAVEMENT MARKING - BLACK BORDER	SF	8,600	
AR820900	PAVEMENT MARKING REMOVAL	SF	22,600	
AR800137	TAXI GUIDANCE SIGN ON EXISTING PAD, 4 CHARACTER	EACH	1	
AR800138	TAXI GUIDANCE SIGN ON EXISTING PAD, 5 CHARACTER	EACH	2	
AR800139	TAXI GUIDANCE SIGN ON EXISTING PAD, 6 CHARACTER	EACH	1	
AR800149	REMOVE TAXI GUIDANCE SIGN - SIGN ONLY	EACH	4	
AR800153	CONCRETE WASHOUT	LS	1	
AR800159	SEEDING	SY	2,400	
AR800162	MULCHING	SY	2,400	
AR905530	TOPSOILING	SY	2,400	
ADDITIVE ALTERNATE 1				
AS125474	4 CHARACTER SIGN LED UPGRADE	EACH	1	
AS125475	5 CHARACTER SIGN LED UPGRADE	EACH	2	
AS125476	6 CHARACTER SIGN LED UPGRADE	EACH	2	
AS800137	TAXI GUIDANCE SIGN ON EXISTING PAD, 4 CHARACTER	EACH	1	
AS800138	TAXI GUIDANCE SIGN ON EXISTING PAD, 5 CHARACTER	EACH	2	
AS800139	TAXI GUIDANCE SIGN ON EXISTING PAD, 6 CHARACTER	EACH	2	
AS800149	REMOVE TAXI GUIDANCE SIGN - SIGN ONLY	EACH	5	
AS800159	SEEDING	SY	375	
AS800162	MULCHING	SY	375	
AS905530	TOPSOILING	SY	375	
ADDITIVE ALTERNATE 2				
AT108158	1/C #5 KV UG CABLE IN UD	LF	50	
AT125444	TAXI GUIDANCE SIGN, 4 CHARACTER	EACH	1	
AT125474	4 CHARACTER SIGN LED UPGRADE	EACH	3	
AT125475	5 CHARACTER SIGN LED UPGRADE	EACH	1	
AT125477	7 CHARACTER SIGN LED UPGRADE	EACH	1	
AT800137	TAXI GUIDANCE SIGN ON EXISTING PAD, 4 CHARACTER	EACH	2	
AT800138	TAXI GUIDANCE SIGN ON EXISTING PAD, 5 CHARACTER	EACH	1	
AT800141	TAXI GUIDANCE SIGN ON EXISTING PAD, 7 CHARACTER	EACH	1	
AT800149	REMOVE TAXI GUIDANCE SIGN - SIGN ONLY	EACH	4	
AT800159	SEEDING	SY	375	
AT800162	MULCHING	SY	375	
AT905530	TOPSOILING	SY	375	

IL. CONTRACT: **AU066**
 IL. LETTING ITEM: **2A**
 IL. PROJECT: **ARR-4421**
 S.B.G. PROJECT: **3-17-SBGP-XX**

SURVEY BOOK # BOOK #

REVISIONS

NUMBER	BY	DATE

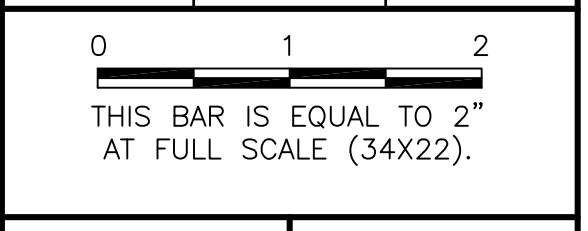

**AURORA MUNICIPAL AIRPORT
 AURORA, ILLINOIS
 REHABILITATE AIRFIELD SIGNAGE**

SITE PLAN / SUMMARY OF QUANTITIES

© Copyright CMT, Inc.

CMT
 CRAWFORD, MURPHY & TILLY, INC.
 CONSULTING ENGINEERS
 License No. 184-000613

CHICAGO
AURORA
 MUNICIPAL AIRPORT

DESIGN BY:	RD
DRAWN BY:	JRO
CHECKED BY:	DKP
APPROVED BY:	DKP
DATE:	06/05/15
JOB No:	14285-02
FINAL	
SHEET 2 OF 13 SHEETS	

DATE: Thursday, June 11, 2015, 4:56:45 PM
 FILE: K:\Aurora\14285-02_RehabAirfieldSignage\Draw\Sheets\02_Site Plan.dwg
 UPDATE BY: Ryan Drea
 LAYOUT: Exhibit1
 XREF DWG: ARR-base.dwg
 To: NCS_ARR.dwg
 IMAGE FILES: Aurora\port.jpg
 CMT_3c_cmyk.jpg

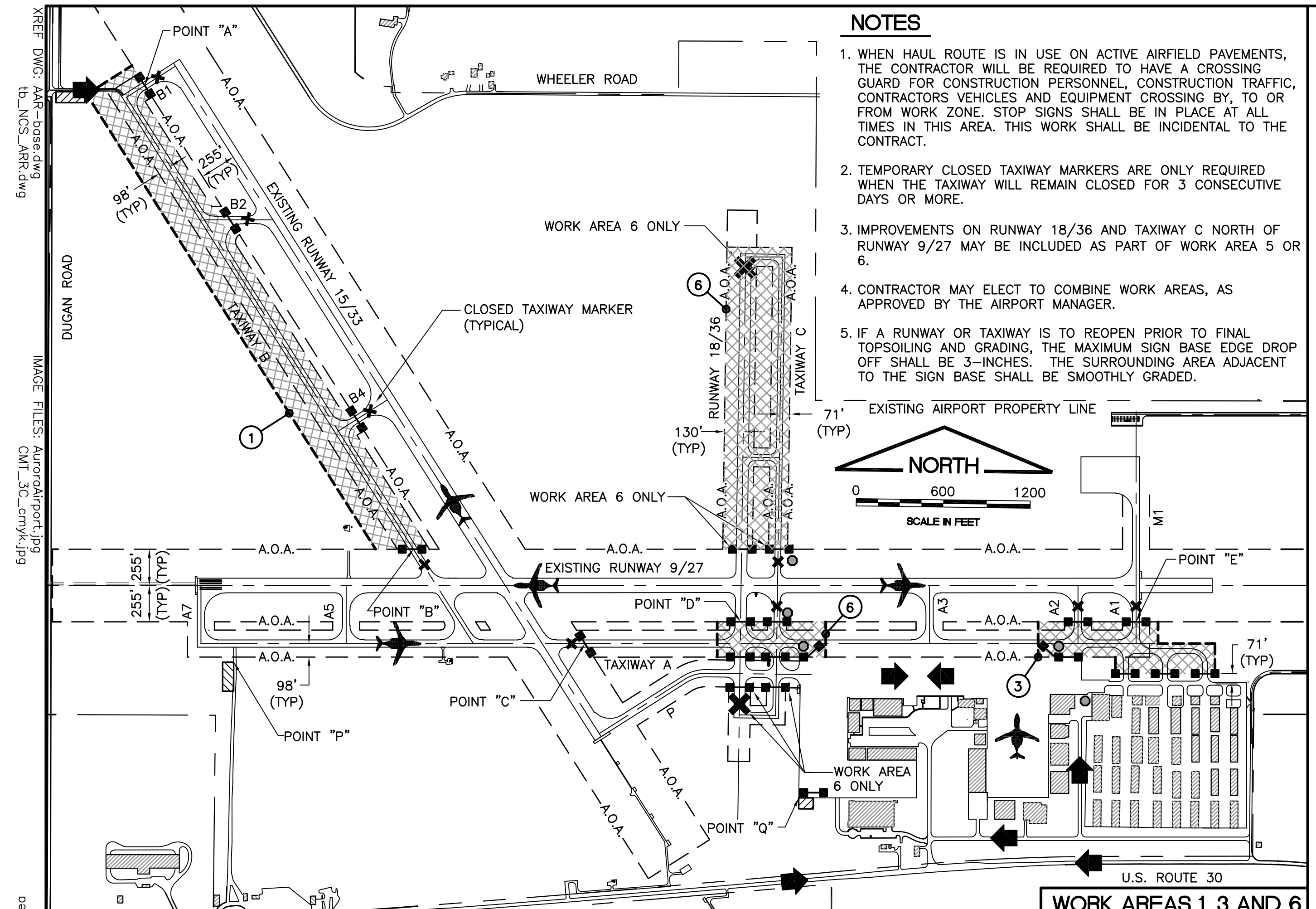

- NOTES**
1. WHEN HAUL ROUTE IS IN USE ON ACTIVE AIRFIELD PAVEMENTS, THE CONTRACTOR WILL BE REQUIRED TO HAVE A CROSSING GUARD FOR CONSTRUCTION PERSONNEL, CONSTRUCTION TRAFFIC, CONTRACTOR VEHICLES AND EQUIPMENT CROSSING BY, TO OR FROM WORK ZONE. STOP SIGNS SHALL BE IN PLACE AT ALL TIMES IN THIS AREA. THIS WORK SHALL BE INCIDENTAL TO THE CONTRACT.
 2. TEMPORARY CLOSED TAXIWAY MARKERS ARE ONLY REQUIRED WHEN THE TAXIWAY WILL REMAIN CLOSED FOR 3 CONSECUTIVE DAYS OR MORE.
 3. IMPROVEMENTS ON RUNWAY 18/36 AND TAXIWAY C NORTH OF RUNWAY 9/27 MAY BE INCLUDED AS PART OF WORK AREA 5 OR 6.
 4. CONTRACTOR MAY ELECT TO COMBINE WORK AREAS, AS APPROVED BY THE AIRPORT MANAGER.
 5. IF A RUNWAY OR TAXIWAY IS TO REOPEN PRIOR TO FINAL TOPSOILING AND GRADING, THE MAXIMUM SIGN BASE EDGE DROP OFF SHALL BE 3-INCHES. THE SURROUNDING AREA ADJACENT TO THE SIGN BASE SHALL BE SMOOTHLY GRADED.

WORK AREA	ALLOWABLE WORK PERIOD	OPERATION STATUS/RESTRICTIONS
1	NO RESTRICTIONS	RUNWAY 9/27, 15/33 AND 18/36 OPEN TAXIWAY B CLOSED NORTH OF RUNWAY 9/27 ALL OTHER TAXIWAYS OPEN
2A	NO RESTRICTIONS	RUNWAY 9/27, 15/33 AND 18/36 OPEN TAXIWAY B CLOSED BETWEEN RUNWAY 9/27 AND TAXIWAY A5 TAXIWAY A CLOSED BETWEEN RUNWAY 15/33 AND TAXIWAY A5 ALL OTHER TAXIWAYS OPEN
2B	WORK WITHIN AREA WILL BE EXPEDITED. ONLY 4 CALENDAR DAYS ALLOWED TO COMPLETE WORK	RUNWAY 15/33 CLOSED RUNWAY 9/27 AND 18/36 OPEN TAXIWAY B AND P CLOSED TAXIWAY A CLOSED FROM RUNWAY 18/36 TO TAXIWAY A5 ALL OTHER TAXIWAYS OPEN
3	NO RESTRICTIONS	RUNWAY 9/27, 15/33 AND 18/36 OPEN TAXIWAYS A1 AND A2 CLOSED TAXILANES FROM T-HANGARS TO TAXIWAY A CLOSED PARTIAL CLOSURE TAXIWAY A AT APRON EDGE BETWEEN TAXIWAY A1 TO TAXIWAY A2 ALL OTHER TAXIWAYS OPEN
4	NO RESTRICTIONS	RUNWAY 9/27, 15/33 AND 18/36 OPEN TAXIWAY A3 CLOSED PARTIAL CLOSURE OF TAXIWAY A AT APRON EDGE BETWEEN TAXIWAY A2 TO TAXIWAY C ALL OTHER TAXIWAYS OPEN
5	NO RESTRICTIONS	RUNWAY 18/36 CLOSED RUNWAY 9/27 AND 15/33 OPEN TAXIWAY P CLOSED TAXIWAY C CLOSED NORTH OF RUNWAY 9/27 AND SOUTH OF TAXIWAY A ALL OTHER TAXIWAYS OPEN
6	NO RESTRICTIONS	RUNWAY 18/36 CLOSED RUNWAY 9/27 AND 15/33 OPEN TAXIWAY C CLOSED TAXIWAY A CLOSED BETWEEN RUNWAY 15/33 TO TAXIWAY A3/MAIN APRON ALL OTHER TAXIWAYS OPEN
7	WORK WITHIN AREA WILL BE EXPEDITED. ONLY 4 CALENDAR DAYS ALLOWED TO COMPLETE WORK	RUNWAY 9/27 AND 18/36 CLOSED RUNWAY 15/33 OPEN TAXIWAYS A1, A2, A3, A5, A7 AND C CLOSED TAXIWAY A CLOSED WEST OF TAXIWAY B ALL OTHER TAXIWAYS OPEN

- SUGGESTED SEQUENCE OF CONSTRUCTION**
- NOTIFY RESIDENT ENGINEER/AIRPORT MANAGER 10 DAYS PRIOR TO THE START OF CONSTRUCTION TO ISSUE APPROPRIATE NOTAMS.
 - WORK AREAS 1 THRU 7
 - COORDINATE WITH RESIDENT ENGINEER AND AIRPORT MANAGER FOR REQUIRED PAVEMENT CLOSURES FOR WORK AREA.
 - PLACE REQUIRED BARRICADES AND PAVEMENT CLOSURE MARKERS.
 - MEGGER AIRFIELD CIRCUITS.
 - DE-ENERGIZE CIRCUITS FOR CLOSED RUNWAYS.
 - INSTALL TEMPORARY CABLING/DE-ENERGIZE TAXIWAY CIRCUIT OR COVER LIGHT FIXTURE IN SUCH A WAY TO PREVENT LIGHT LEAKAGE WITHIN WORK AREA LIMITS.
 - COMPLETE NEW SIGNAGE AND CABLING IMPROVEMENTS.
 - REMOVE TEMPORARY CABLING AND RE-ENERGIZE CIRCUITS WITHIN WORK AREA LIMITS AND RE-MEGGER AIRFIELD CIRCUITS.
 - COORDINATE WITH RESIDENT ENGINEER AND AIRPORT MANAGER PAVEMENT CLOSURES FOR NEXT WORK AREA.
 - CLEAN PAVEMENTS, RESTORE DISTURBED WORK AREAS AND REMOVE MISCELLANEOUS DEBRIS FROM WORK AREA.
 - RELOCATE BARRICADES AND PAVEMENT CLOSURE MARKERS FOR NEXT WORK AREA.
 - RESTORE STAGING AREAS.

LEGEND

- WORK AREA LIMITS
- A.O.A. AIR OPERATIONS AREA (A.O.A.)
 - 255' FROM CENTERLINE OF RUNWAY 9/27 AND 15/33
 - 130' FROM CENTERLINE OF RUNWAY 18/36
 - 98' FROM CENTERLINE OF TAXIWAY B, A, P, AND M1
 - 71' FROM CENTERLINE OF TAXIWAY C
- WORK AREA NUMBER
- TEMPORARY TYPE II BARRICADES WITH RED FLASHING LIGHT
- CONTRACTOR'S HAUL ROUTE
- TEMPORARY CLOSED RUNWAY MARKER
- TEMPORARY CLOSED TAXIWAY MARKER (SEE NOTE 2)
- AIRCRAFT MOVEMENT AREA
- CROSSING GUARD STOP-A.O.A. SIGN (SEE NOTE 1) OR CONTRACTOR'S ESCORT WITH RADIO
- CONTRACTOR'S EMPLOYEE PARKING, EQUIPMENT AND MATERIAL STORAGE LOCATION

IL. CONTRACT: **AU066**
 IL. LETTING ITEM: **2A**
 IL. PROJECT: **ARR-4421**
 S.B.G. PROJECT: **3-17-SBGP-XX**

SURVEY BOOK # BOOK #

REVISIONS		
NUMBER	BY	DATE

0 1 2
 THIS BAR IS EQUAL TO 2"
 AT FULL SCALE (34x22).

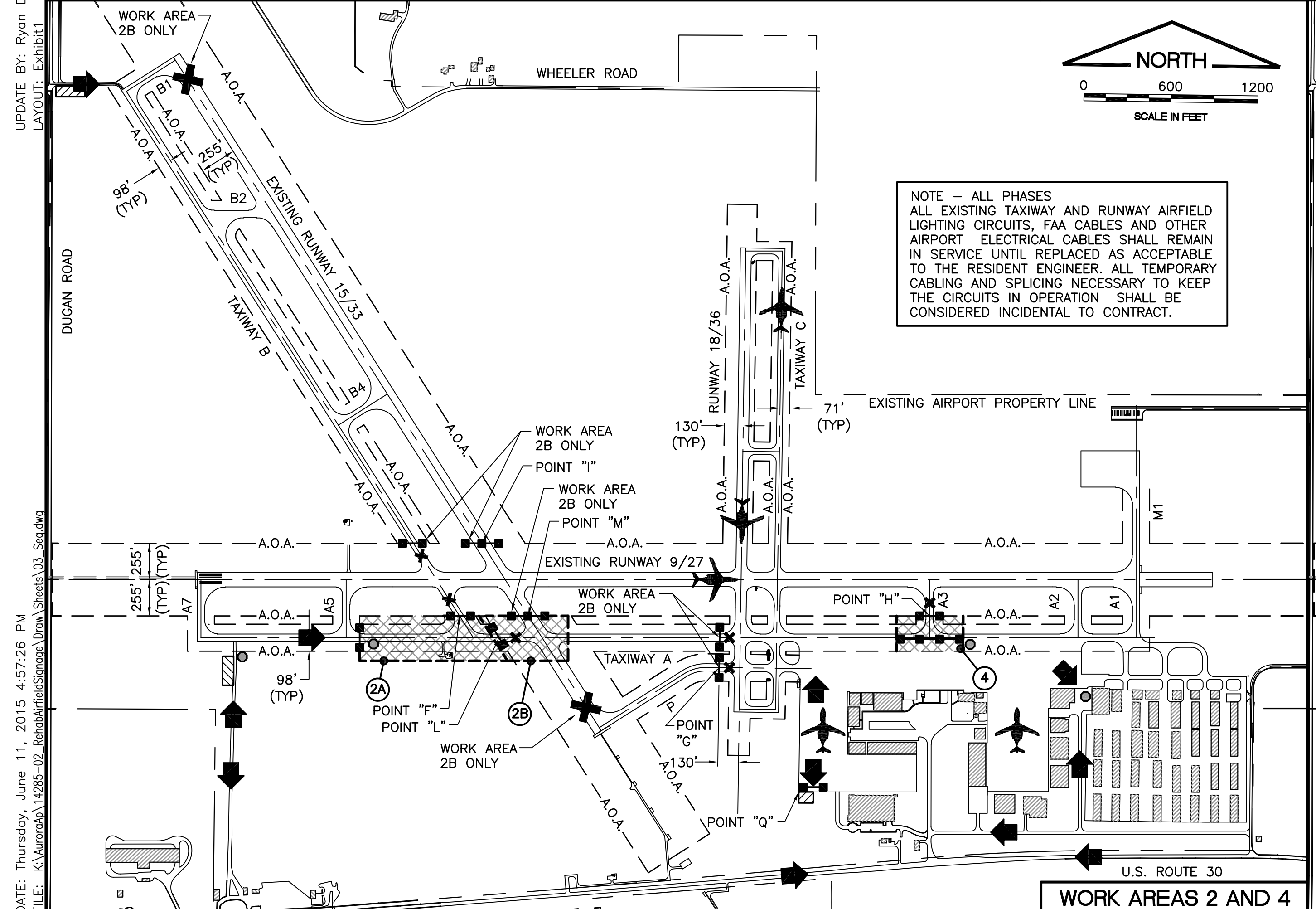

NOTE - ALL PHASES
 ALL EXISTING TAXIWAY AND RUNWAY AIRFIELD LIGHTING CIRCUITS, FAA CABLES AND OTHER AIRPORT ELECTRICAL CABLES SHALL REMAIN IN SERVICE UNTIL REPLACED AS ACCEPTABLE TO THE RESIDENT ENGINEER. ALL TEMPORARY CABLING AND SPLICING NECESSARY TO KEEP THE CIRCUITS IN OPERATION SHALL BE CONSIDERED INCIDENTAL TO CONTRACT.

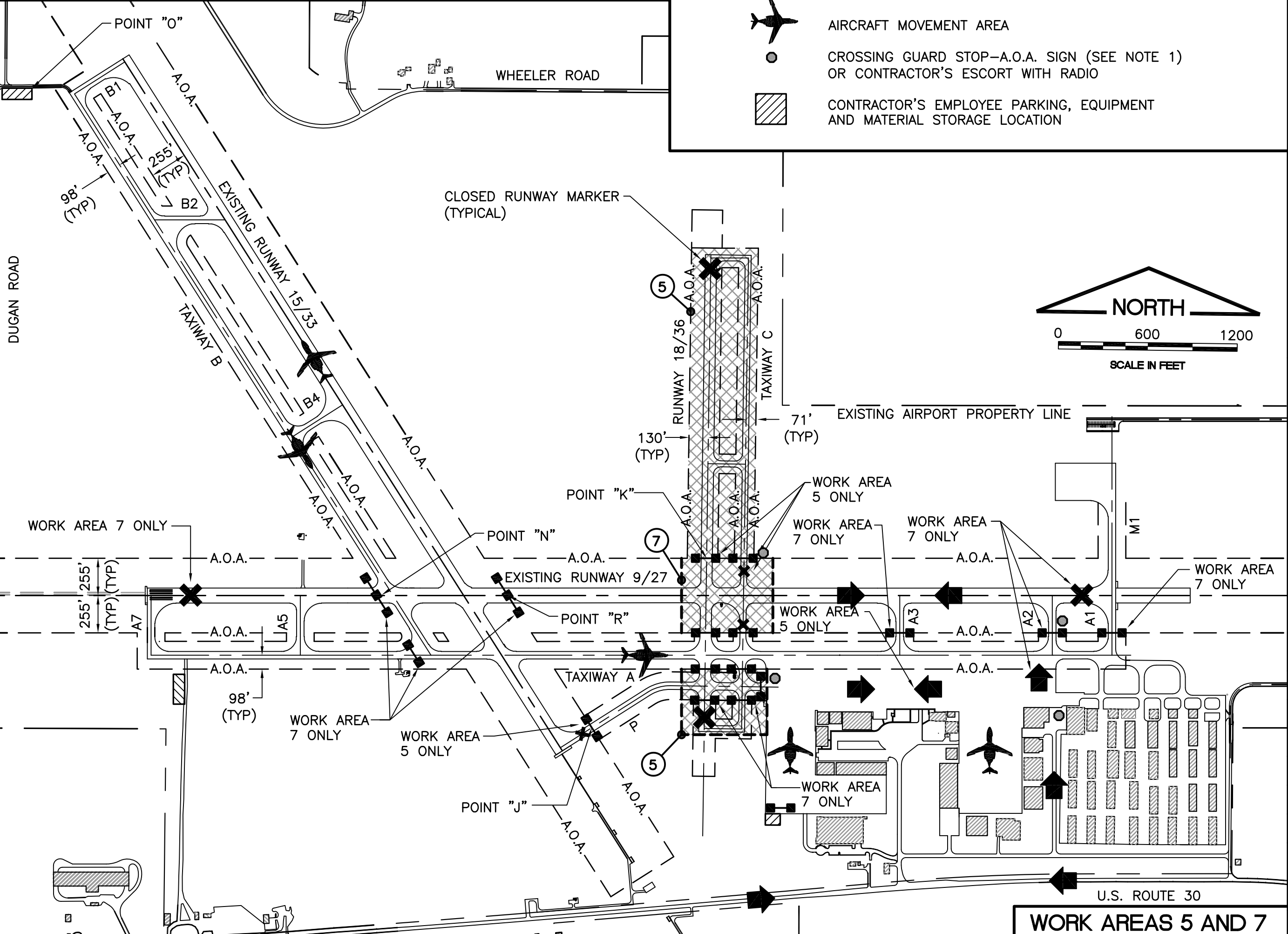

**AURORA MUNICIPAL AIRPORT
 AURORA, ILLINOIS
 REHABILITATE AIRFIELD SIGNAGE**

**SEQUENCE OF CONSTRUCTION
 PER AC/150-5370-2F (LATEST EDITION)**

© Copyright CMT, Inc.
CMT
 CRAIG FORD, MURPHY & TILLY, INC.
 CONSULTING ENGINEERS
 License No. 184-000613

CHICAGO
AURORA
 MUNICIPAL AIRPORT

DESIGN BY: ARM
 DRAWN BY: JRO
 CHECKED BY: ARM
 APPROVED BY: DKP
 DATE: 06/05/15
 JOB No: 14285-02

FINAL

SHEET 3 OF 13 SHEETS

XREF DWG: ARR-base.dwg
 To: NCS_ARR.dwg
 IMAGE FILES: AuroraAirport.jpg
 CM_150-5370-2F.dwg
 UPDATE BY: Ryan Drea
 LAYOUT: Exhibit1
 DATE: Thursday, June 11, 2015, 4:57:26 PM
 FILE: K:\Aurora\14285-02_RehabAirfieldSignage\Draw\Sheets\03_Seq.dwg

GENERAL NOTES

1. THE SUGGESTED SEQUENCE OF CONSTRUCTION SHOWN IS INTENDED TO ALLOW FOR THE ORDERLY CONSTRUCTION OF THE PROPOSED IMPROVEMENTS WHILE MAINTAINING AIRCRAFT ACCESS AT ALL TIMES. THE PHASING SHOWN IS A SUGGESTED SEQUENCE OF CONSTRUCTION ONLY. THIS SEQUENCE MAY BE MODIFIED HOWEVER, ALTERNATE STAGING PLANS MUST MAINTAIN AIRPORT OPERATIONS TO THE SATISFACTION OF THE AIRPORT DIRECTOR AND RESIDENT ENGINEER AND BE APPROVED BY THE DIVISION OF AERONAUTICS AND FEDERAL AVIATION ADMINISTRATION.
2. ALL OPERATIONS SHALL BE IN CONFORMANCE WITH AC 150/5370-2F (LATEST EDITION) **OPERATIONAL SAFETY ON AIRPORTS DURING CONSTRUCTION**.
3. CONTRACTOR'S EQUIPMENT SHALL BE STORED IN THE EQUIPMENT AND MATERIAL STORAGE/STAGING AREA WHEN CONSTRUCTION IS NOT IN PROGRESS.
4. THE AIRPORT DIRECTOR IN CONSULTATION WITH THE RESIDENT ENGINEER SHALL HAVE FINAL SAY IN THE APPROVAL OF THE CONSTRUCTION OPERATING SEQUENCE AS IT RELATES TO PEDESTRIAN, VEHICULAR AND AIRCRAFT SAFETY.
5. ALL EXISTING PAVEMENTS, DRIVES OR ANY OTHER AREAS USED AS A HAUL ROAD OR STORAGE AREA BY THE CONTRACTOR SHALL BE RESTORED IN KIND TO THEIR PRE-CONSTRUCTION CONDITION OR TO THE SATISFACTION OF THE RESIDENT ENGINEER AND AIRPORT DIRECTOR. THE COST OF MAINTAINING, REPAIRING OR CONSTRUCTING THESE PAVEMENTS AND AREAS SHALL BE INCIDENTAL TO THE CONTRACT. EXISTING AREAS OUTSIDE THE PROJECT LIMITS WHICH ARE DISTURBED BY THE CONTRACTOR'S OPERATIONS SHALL BE RESTORED BY HIM AT HIS EXPENSE TO THE SATISFACTION OF THE RESIDENT ENGINEER AND THE AIRPORT DIRECTOR.
6. THE CONTRACTOR SHALL KEEP ALL TRUCKS, EQUIPMENT AND MATERIALS OFF OF THE EXISTING TAXIWAYS, APRONS AND RUNWAYS OUTSIDE OF THE PROJECT LIMITS EXCEPT AS SHOWN OR WITH THE PRIOR PERMISSION OF THE AIRPORT MANAGER.
7. WORK PERFORMED BY THE CONTRACTOR OUTSIDE OF DAYLIGHT HOURS SHALL BE DONE UNDER SUFFICIENT ARTIFICIAL LIGHTING TO ALLOW FOR PROPER CONSTRUCTION METHODS AND INSPECTIONS. LIGHT SHALL CONSIST OF MOVABLE POLE MOUNTED FLOODLIGHTS AND/OR SPOTLIGHTS OF SUFFICIENT NUMBER TO ILLUMINATE THE WORK AREA. VEHICLE HEADLIGHTS WILL BE ALLOWED ONLY IN ADDITION TO OTHER LIGHTS MENTIONED ABOVE. LIGHTING SHALL BE AS APPROVED BY THE RESIDENT ENGINEER AND SHALL NOT BE USED IF THEY AFFECT FLIGHT SAFETY. CONTRACTOR'S WORK HOURS SHALL BE IN ACCORDANCE WITH LOCAL ORDINANCES.
8. THE CONTRACTOR SHALL PROVIDE PORTABLE FLOOD LIGHTING FOR NIGHTTIME CONSTRUCTION. SUFFICIENT UNITS SHALL BE PROVIDED SO THAT WORK AREAS ARE ILLUMINATED TO A LEVEL OF FIVE HORIZONTAL FOOT CANDLES. THE LIGHTING LEVELS SHALL BE CALCULATED AND MEASURED IN ACCORDANCE WITH THE CURRENT STANDARDS OF THE ILLUMINATION ENGINEERING SOCIETY. LIGHTS SHALL BE POSITIONED SO AS NOT TO INTERFERE WITH AIRPORT OPERATIONS.
9. THE CONTRACTOR WILL BE REQUIRED TO HAVE A SWEEPER AVAILABLE FOR USE AT ALL TIMES. WHEN ACTIVE AIRFIELD PAVEMENTS ARE UTILIZED AS HAUL ROADS BY THE CONTRACTOR, MATERIAL TRACKED ON TO THE PAVEMENT SHALL BE CONTINUALLY REMOVED WITH SAID SWEEPER. THIS SWEEPING SHALL NOT BE PAID FOR SEPARATELY BUT SHALL BE CONSIDERED INCIDENTAL TO THE CONTRACT.
10. MATERIALS REMOVED FROM THE PROJECT WILL BE DISPOSED OF OFF AIRPORT PROPERTY, UNLESS NOTED OTHERWISE.
11. PAYMENT FOR TRAFFIC CONTROL INCLUDING, BUT NOT LIMITED TO BARRICADES, SIGNING, TAXIWAY AND RUNWAY CLOSED MARKERS, AIR OPERATIONS AREA (A.O.A.) LATHE AND RIBBON, ETC. SHALL NOT BE PAID SEPARATELY, BUT SHALL BE CONSIDERED INCIDENTAL TO THE CONTRACT. BARRICADES SHALL BE PLACED AT THE LOCATIONS SHOWN ON THE PLANS OR AS DIRECTED BY THE ENGINEER. BARRICADES SHALL BE WEIGHTED TO PREVENT BLOWING OVER. BARRICADES SHALL HAVE A STEADY BURN OR FLASHING RED LIGHT. BARRICADE INSTALLATION WILL BE REQUIRED PRIOR TO ACCESS TO THE A.O.A. BY CONTRACTOR'S WORKERS, EQUIPMENT OR MATERIAL. SIGNS SHALL BE PLACED AT EACH TAXIWAY/RUNWAY CLOSURE LOCATION AND SHALL BE ATTACHED TO THE BARRICADES. EACH BARRICADE LOCATION SHALL CONSIST OF ONE "DO NOT ENTER" SIGN AND ONE "AIRCRAFT MOVEMENT AREA" SIGN. SIGNS SHALL BE CONSIDERED INCIDENTAL TO THE CONTRACT.
12. THE CONTRACTOR SHALL CONTACT THE AIRPORT DIRECTOR THROUGH THE RESIDENT ENGINEER TEN (10) WORKING DAYS IN ADVANCE OF THE START OF CONSTRUCTION SO THAT THE APPROPRIATE NOTAMS MAY BE ISSUED.
13. THE CONTRACTOR SHALL BE RESPONSIBLE FOR KEEPING ALL CONSTRUCTION ACCESS GATES CLOSED DURING NON WORKING HOURS. THE CONTRACTOR SHALL PROVIDE A SIGN AT THE ACCESS GATE SAYING "AUTHORIZED PERSONNEL ONLY". THE CONTRACTOR SHALL CLOSE AND LOCK THIS ACCESS GATE UPON LEAVING THE SITE. THROUGHOUT THE DURATION OF THE CONTRACT, ANY DAMAGES TO THE ACCESS ROAD, ACCESS GATE OR FENCING ADJACENT TO THE PROJECT SHALL BE REPAIRED BY THE CONTRACTOR TO THE SATISFACTION OF THE RESIDENT ENGINEER. ALL COST RELATING TO CONTRACTOR'S ACCESS AND SECURITY SHALL BE THE RESPONSIBILITY OF THE CONTRACTOR.
14. CONTRACTOR WILL BE REQUIRED TO PUT AIRPORT FLAGS AND HAVE BEACON LIGHTS ON ALL EQUIPMENT AT ALL TIMES DURING CONSTRUCTION. SEE FLAG DETAIL.
15. IN THE CASE OF AN EMERGENCY, CONTRACTOR SHALL NOTIFY AIRPORT MANAGER AND THE RESIDENT ENGINEER IMMEDIATELY.
16. DURING ADVERSE WEATHER, THE CONTRACTOR SHALL MAKE PROVISIONS FOR ACCESS TO THE WORK AT NO ADDITIONAL COST TO THE CONTRACT. NO EXTENSION OF CONTRACT TIME WILL BE CONSIDERED FOR DELAYS DUE TO LACK OF ADEQUATE ACCESS TO THE WORK.
17. THE TALLEST PIECE OF CONSTRUCTION EQUIPMENT IS ANTICIPATED TO BE AN ASPHALT/STONE TRUCK WHICH HAS A MAXIMUM HEIGHT OF 25 FEET IN A DUMP POSITION.
18. IF RUNWAY NUMERALS ARE PRESENT DURING CONSTRUCTION THEN CONTRACTOR SHALL PLACE CLOSED RUNWAY MARKER OVER NUMERALS AS DETAILED, OTHERWISE PLACE RUNWAY CLOSED MARKER IN TURF AT ENDS OF RUNWAY AS DETAILED.
19. AURORA MUNICIPAL AIRPORT WILL BE IN OPERATION DURING THE CONSTRUCTION OF THIS PROJECT. COORDINATION OF WORK WITH THE AIRPORT IS MANDATORY SO AS TO MINIMIZE IMPACTS ON AIRPORT OPERATIONS.
20. APPROXIMATE LOCATION OF HAUL ROUTES ON THE AIRPORT SITE ARE SHOWN ON THE GENERAL PROJECT LAYOUT AND THE PHASING PLANS. IT SHALL BE THE CONTRACTOR'S RESPONSIBILITY TO COORDINATE OFF-SITE HAUL ROUTES (STATE HIGHWAYS, COUNTY ROADS OR CITY STREETS) WITH THE APPROPRIATE OWNER WHO HAS JURISDICTION OVER THE AFFECTED ROUTE. ON-SITE ROADS USED AS HAUL ROUTES SHALL BE MAINTAINED BY THE CONTRACTOR AND SHALL BE RESTORED AT THE CONTRACTOR'S EXPENSE TO THEIR ORIGINAL CONDITION UPON COMPLETION OF BEING USED AS A HAUL ROUTE. THE BEFORE AND AFTER CONDITION OF ON-SITE HAUL ROUTES SHALL BE JOINTLY INSPECTED AND DETERMINED BY THE CONTRACTOR AND THE ENGINEER. FENCING, DRAINAGE, GRADING AND OTHER MISCELLANEOUS CONSTRUCTION REQUIRED TO CONSTRUCT TEMPORARY HAUL ROUTES OR ACCESS POINTS ON THE AIRPORT WILL BE THE CONTRACTOR'S TOTAL RESPONSIBILITY AND SHALL BE APPROVED BY THE ENGINEER PRIOR TO THE WORK. ALL ON-SITE ACCESS ROADS TO AIRPORT FACILITIES SHALL REMAIN OPEN AND MAINTAINED AT ALL TIMES.
21. MOBILIZATION/EQUIPMENT STORAGE AREA WILL BE MADE AVAILABLE FOR CONTRACTOR'S MOBILIZATION AND STORAGE AS SHOWN ON THE PLANS. THIS AREA SHALL BE RESTORED TO THE ORIGINAL CONDITION UPON COMPLETION OF THE PROJECT AT THE CONTRACTOR'S EXPENSE.

22. LOCATION OF KNOWN EXISTING AIRPORT UNDERGROUND CABLES ARE SHOWN ON THE PLANS AND MUST BE VERIFIED BY THE CONTRACTOR. REPAIR OF DAMAGED CABLE MUST BE STARTED IMMEDIATELY AND CONTINUED UNTIL COMPLETED. ALL SUCH REPAIRS SHALL BE IN ACCORDANCE WITH THE SPECIFICATIONS, OR AS DIRECTED BY THE OWNER OF THE CABLE OR FACILITY, AND SHALL BE AT THE CONTRACTOR'S EXPENSE. IF FAA CABLES ARE DAMAGED, REPAIRS SHALL BE DONE FROM PREVIOUS EXISTING TERMINATION POINT TO NEXT EXISTING TERMINATION POINT IN ACCORDANCE WITH FAA REQUIREMENTS AND IN THE PRESENCE OF A FAA REPRESENTATIVE. THE OWNER MAY ELECT TO HAVE THE REPAIR PERFORMED BY OTHERS IN WHICH CASE THE CONTRACTOR SHALL BE RESPONSIBLE FOR PAYING THE INCURRED COSTS OF REPAIRS.
23. COORDINATION MEETINGS - THE CONTRACTOR SHALL CONDUCT WEEKLY COORDINATION MEETINGS TO DISCUSS WORK AREAS AND SCHEDULING, ETC. WITH THE RESIDENT ENGINEER, AIRPORT OPERATIONS, FAA, AND OTHER APPROPRIATE OFFICIALS. MINUTES FROM THE WEEKLY MEETINGS SHALL BE PREPARED BY THE CONTRACTOR, FURNISHED TO ALL ATTENDEES PRIOR TO THE SUBSEQUENT MEETING, AND KEPT ON FILE AT THE FIELD OFFICE. THE COORDINATION MEETING COSTS SHALL BE CONSIDERED INCIDENTAL TO THE PROJECT.
24. THE CONTRACTOR SHALL PROVIDE THE PHONE NUMBERS OF THREE PERSONNEL, INCLUDING THE PROJECT SUPERINTENDENT, WHO MAY BE CONTACTED IN AN EMERGENCY. PERSONNEL SHALL BE ON CALL 24 HOURS PER DAY FOR MAINTAINING AIRPORT HAZARD LIGHTING AND BARRICADES.
25. DRAINAGE MODIFICATIONS SHALL BE SEQUENCED TO PROVIDE POSITIVE DRAINAGE AT ALL TIMES AT NO ADDITIONAL COST TO THE CONTRACT.
26. CONTRACTOR PERSONNEL, VEHICLES, EQUIPMENT AND BARRICADES SHALL NOT BE ALLOWED WITHIN THE TAXIWAY OBJECT FREE AREA (TOFA) OF ACTIVE TAXIWAYS AND THE RUNWAY SAFETY AREA (RSA) OF ACTIVE RUNWAYS UNLESS OTHERWISE APPROVED BY THE AIRPORT DIRECTOR IN CONSULTATION WITH THE RESIDENT ENGINEER.
27. CONTRACTOR SHALL STORE EQUIPMENT AND MATERIALS IN SUCH A MANNER AS NOT TO VIOLATE FEDERAL AVIATION ADMINISTRATION PART 77 IMAGINARY SURFACES OR RUNWAY AND TAXIWAY SAFETY AREAS.
28. ALL EXISTING TAXIWAY AND RUNWAY AIRFIELD LIGHTING CIRCUITS, FAA CABLES AND OTHER ELECTRICAL CABLES SHALL REMAIN IN SERVICE AT ALL TIMES. ALL EXISTING LIGHTING AND VAULT EQUIPMENT SHALL REMAIN IN SERVICE UNTIL PROPOSED IMPROVEMENTS ARE INSTALLED AND OPERATIONAL, UNLESS OTHERWISE APPROVED BY THE RESIDENT ENGINEER. ANY CABLES DAMAGED BY THE CONTRACTOR SHALL BE IMMEDIATELY REPAIRED AT HIS EXPENSE. ANY NECESSARY TEMPORARY JUMPER CABLES SHALL BE CONSIDERED INCIDENTAL TO THE CONTRACT.
29. COORDINATION BY THE CONTRACTOR WITH THE EXISTING UTILITIES SHALL BE COMPLETED BEFORE CONSTRUCTION IS STARTED. CONTRACTOR IS REFERRED TO SECTION 50-17 OF THE STANDARD SPECIFICATIONS AND THE SPECIAL PROVISIONS FOR SPECIFIC REQUIREMENTS. THE LOCATION OF UNDERGROUND UTILITIES AS INDICATED ON THE PLANS HAVE BEEN OBTAINED FROM EXISTING RECORDS. NEITHER THE OWNER OR THE DESIGN ENGINEER ASSUME ANY RESPONSIBILITY WHATSOEVER IN RESPECT TO THE ACCURACY, COMPLETENESS OR SUFFICIENCY OF THE INFORMATION. THERE IS NO GUARANTEE, EITHER EXPRESSED OR IMPLIED THAT THE LOCATIONS, SIZE AND TYPE MATERIAL OF EXISTING UNDERGROUND UTILITIES AS INDICATED ARE REPRESENTATIVE OF THOSE TO BE ENCOUNTERED DURING CONSTRUCTION. IT SHALL BE THE CONTRACTOR'S RESPONSIBILITY TO DETERMINE THE ACTUAL LOCATION OF ALL SUCH FACILITIES, INCLUDING SERVICE CONNECTIONS TO UNDERGROUND UTILITIES. PRIOR TO CONSTRUCTION, THE CONTRACTOR SHALL NOTIFY THE UTILITY COMPANY OF HIS OPERATIONAL PLANS. THE CONTRACTOR SHALL MAKE ARRANGEMENTS FOR DETAILED INFORMATION AND ASSISTANCE IN LOCATING UTILITIES. IN THE EVENT AN UNEXPECTED UTILITY INTERFERENCE IS ENCOUNTERED DURING CONSTRUCTION, THE CONTRACTOR SHALL IMMEDIATELY NOTIFY THE UTILITY COMPANY, THE RESIDENT ENGINEER AND THE AIRPORT DIRECTOR. ANY SUCH MAINS AND/OR SERVICES DISTURBED BY THE CONTRACTOR'S OPERATIONS SHALL BE RESTORED IMMEDIATELY AT HIS EXPENSE TO THE SATISFACTION OF THE RESIDENT ENGINEER AND AIRPORT DIRECTOR.
30. ALL AIRFIELD LIGHTING AND LIGHTING GUIDANCE SYSTEMS (NAVAIDS) LOCATED WITHIN AND IMMEDIATELY ADJACENT TO THE CONTRACTOR'S WORK ZONE SHALL BE CHECKED FOR OPERATIONAL CONDITION PRIOR TO THE DEPARTURE FROM THE AIRPORT WITH THE AIRPORT MANAGER. ANY DEFICIENCIES IN THESE SYSTEMS DUE TO THE ACTS OF CONTRACTOR OR HIS SUBCONTRACTORS, SUPPLIERS OR CONSULTANTS SHALL BE REPAIRED IMMEDIATELY.
31. CONTRACTOR SHALL OBTAIN ALL NECESSARY PERMITS AND TEMPORARY EASEMENTS FOR THE PUBLIC ACCESS ROAD(S) SHOWN AND SHALL COMPLY WITH ALL REQUIREMENTS, LOAD RESTRICTIONS AND TRAFFIC CONTROL SIGNAGE REQUIRED BY THE CITY, COUNTY, TOWNSHIP OR I.D.O.T..
32. THE AIRPORT SHALL HAVE AT LEAST ONE RUNWAY OPEN AT ALL TIMES. RUNWAY 9/27 AND RUNWAY 15/33 MAY NOT BE CLOSED AT THE SAME TIME, UNLESS IT IS DURING OFF PEAK HOURS OF 8:00 PM TO 5:00 AM. ALL NIGHTTIME CLOSURES ARE AT THE DISCRETION OF THE AIRPORT.
33. SHOULD ADDITIONAL WORK BE REQUIRED WITHIN THE RUNWAY SAFETY AREA FOR CABLE CONNECTION, SIGN PLACEMENT, LANDSCAPING, MARKINGS, ETC. AFTER THE ALLOWED CLOSURE, THE CONTRACTOR SHALL COMPLETE THE WORK AT NIGHT DURING OFF PEAK HOURS BETWEEN THE HOURS OF 8:00 PM TO 5:00 AM AT HIS EXPENSE. THE CONTRACTOR SHALL COORDINATE THE REQUIRED CLOSURES WITH THE RESIDENT ENGINEER AND AIRPORT MANAGER.

LIMITATIONS ON CONSTRUCTION WITHIN RUNWAY SAFETY AREA (RSA) AND TAXIWAY OBJECT FREE AREA (TOFA)

RUNWAYS:

THE CONTRACTOR SHALL NOTIFY THE RESIDENT ENGINEER AND AIRPORT DIRECTOR TEN (10) WORKING DAYS IN ADVANCE OF ANY PLANNED CONSTRUCTION WITHIN THESE LIMITS. WORK SHALL BE EXPEDITED IN THESE AREAS AND AT THE END OF EACH WORKING DAY THESE AREAS SHALL BE SMOOTHLY GRADED TO ALLOW THE RUNWAY TO BE REOPENED UNLESS OTHERWISE SHOWN ON THE PLANS. AT LEAST ONE OF THE RUNWAYS SHALL REMAIN IN OPERATION AT ALL TIMES UNLESS OTHERWISE APPROVED BY THE AIRPORT DIRECTOR IN CONSULTATION WITH THE RESIDENT ENGINEER. IF NECESSARY STEEL PLATES SHALL BE FURNISHED AND INSTALLED BY THE CONTRACTOR TO COVER ANY TRENCHES OR EXCAVATION WITHIN THE RSA IF DURING RUNWAY CLOSURE AN EMERGENCY IS DECLARED, THE CONTRACTOR SHALL IMMEDIATELY CLEAR THE RUNWAY OF ALL VEHICLES, MEN AND EQUIPMENT. REFERENCE TABLE ON PREVIOUS SHEET FOR SAFETY AREA WIDTHS.

TAXIWAYS:

ANY WORK WITHIN TAXIWAY OBJECT FREE AREA (TOFA) WILL REQUIRE A TAXIWAY CLOSURE. WORK WITHIN THE TOFA SHALL BE EXPEDITED. ANY DROP OFF SHALL BE ADEQUATELY LIGHTED, SIGNED AND BARRICADED. NO MATERIAL SHALL BE STOCKPILED WITHIN THE TOFA. SHOULD IT BE NECESSARY FOR THE CONTRACTOR TO TEMPORARILY RELOCATE EQUIPMENT TO ALLOW AIRCRAFT TO PASS, THEY SHALL DO SO AT NO EXTRA COST TO THE PROJECT. THE CONTRACTOR SHALL NOTIFY THE RESIDENT ENGINEER AND AIRPORT DIRECTOR FIVE (5) WORKING DAYS IN ADVANCE OF ANY PLANNED CONSTRUCTION WITHIN THESE LIMITS. REFERENCE TABLE ON PREVIOUS SHEET FOR OBJECT FREE AREA WIDTHS. NO DROP-OFFS OR OPEN EXCAVATIONS WILL BE ALLOWED WITHIN THE TAXIWAY SAFETY AREAS OF OPEN TAXIWAYS.

CONTRACTOR CROSSING RUNWAY/TAXIWAY/TAXILANE/APRON AIR OPERATIONS AREA (A.O.A.)

1. ANYTIME THE CONTRACTOR IS REQUIRED TO UTILIZE OR CROSS ACTIVE AIRFIELD PAVEMENTS FOR ACCESS TO AND FROM THE WORK ZONE, A FULL TIME CROSSING GUARD IN RADIO CONTACT WITH THE CONTROL TOWER SHALL BE FURNISHED BY THE CONTRACTOR FOR MOVEMENTS OF VEHICLES OR EQUIPMENT TO AND FROM THE WORK ZONE. THE RADIO OPERATOR SHALL BE FAMILIAR WITH AIRPORT GROUND CONTROL PROCEDURES AND DEMONSTRATE KNOWLEDGE OF SAME TO THE AIRPORT. THE AIRPORT RESERVES THE RIGHT TO APPROVE THE CROSSING GUARDS. THE CONTRACTOR SHALL PROVIDE THEIR OWN RADIOS. THIS COST SHALL BE CONSIDERED INCIDENTAL TO THE CONTRACT. THE CONTRACTOR SHALL BE RESPONSIBLE FOR PAYMENT OF MUNICIPAL FINES (\$500 PER OCCURRENCE) DUE TO AIRFIELD INCURSIONS BY HIS EMPLOYEES, SUBCONTRACTORS, SUPPLIERS, CONSULTANTS AND/OR AGENTS.
2. ANY PAVEMENT DAMAGED BY CONTRACTOR'S OPERATIONS SHALL BE REPAIRED IMMEDIATELY BY HIM TO THE SATISFACTION OF THE RESIDENT ENGINEER AND AIRPORT DIRECTOR AT NO ADDITIONAL COST TO THE OWNER. PAVEMENT SHALL BE CONTINUALLY SWEEPED TO PROVIDE DEBRIS FREE SURFACE DURING ALL HAUL ROAD OPERATIONS. THIS COST SHALL NOT BE PAID SEPARATELY BUT SHALL BE CONSIDERED INCIDENTAL TO THE CONTRACT.
3. WORK WITHIN THE A.O.A. SHALL BE EXPEDITED. ANY DROP OFF SHALL BE ADEQUATELY LIGHTED, SIGNED AND BARRICADED. NO MATERIAL SHALL BE STOCKPILED WITHIN THE A.O.A. SHOULD IT BE NECESSARY FOR THE CONTRACTOR TO TEMPORARILY RELOCATE MEN AND EQUIPMENT TO ALLOW AIRCRAFT TO PASS, THEY SHALL DO SO AT NO EXTRA COST TO THE PROJECT. THE CONTRACTOR SHALL NOTIFY THE RESIDENT ENGINEER AND AIRPORT DIRECTOR TEN (10) WORKING DAYS IN ADVANCE OF ANY PLANNED CONSTRUCTION WITHIN THESE LIMITS.

DESIGN AIRCRAFT APPROACH CATEGORY: D
DESIGN AIRPORT GROUP: III

GROUND CONTROL FREQUENCY: 121.70
AIR CONTROL FREQUENCY: 120.60
MAXIMUM ANTICIPATED HEIGHT OF CONSTRUCTION EQUIPMENT: 25'

CONSTRUCTION POINT TABLE				
POINT	NEAREST ACTIVE RUNWAY	LATITUDE	LONGITUDE	ELEVATION
A	CENTERLINE RUNWAY 15/33	41°46'46.56"	88°27'24.84"	709.7
B	CENTERLINE RUNWAY 9/27	41°46'15.24"	88°28'47.64"	694.8
C	CENTERLINE RUNWAY 15/33	41°46'09.12"	88°28'31.80"	693.9
D	CENTERLINE RUNWAY 9/27	41°46'10.56"	88°28'17.76"	702.4
E	CENTERLINE RUNWAY 9/27	41°46'10.92"	88°28'41.76"	703.4
F	CENTERLINE RUNWAY 9/27	41°46'10.20"	88°28'43.32"	691.8
G	CENTERLINE RUNWAY 18/36	41°46'06.96"	88°28'19.56"	698.8
H	CENTERLINE RUNWAY 9/27	41°46'10.92"	88°28'00.48"	704.0
I	CENTERLINE RUNWAY 9/27	41°46'15.24"	88°28'41.52"	696.1
J	CENTERLINE RUNWAY 15/33	41°46'04.44"	88°28'27.84"	695.5
K	CENTERLINE RUNWAY 18/36	41°46'15.60"	88°28'17.76"	701.7
L	CENTERLINE RUNWAY 15/33	41°46'08.76"	88°28'39.72"	692.5
M	CENTERLINE RUNWAY 9/27	41°46'10.20"	88°28'37.20"	694.9
N	CENTERLINE RUNWAY 15/33	41°46'12.72"	88°28'46.92"	695.1
O	CENTERLINE RUNWAY 15/33	41°46'46.20"	88°29'18.24"	708.4
P	CENTERLINE RUNWAY 9/27	41°46'07.32"	88°29'03.84"	702.0
Q	CENTERLINE RUNWAY 18/36 EXTENDED	41°45'58.68"	88°28'12.36"	699.3
R	CENTERLINE RUNWAY 15/33	41°46'13.08"	88°28'35.40"	695.9

IL. CONTRACT: **AU066**
IL. LETTING ITEM: **2A**
IL. PROJECT: **ARR-4421**
S.B.G. PROJECT: **3-17-SBGP-XX**

SURVEY BOOK # BOOK #

REVISIONS

NUMBER	BY	DATE

0 1 2
THIS BAR IS EQUAL TO 2"
AT FULL SCALE (34x22).

AURORA MUNICIPAL AIRPORT
AURORA, ILLINOIS
REHABILITATE AIRFIELD SIGNAGE
SEQUENCE OF CONSTRUCTION
GENERAL NOTES

© Copyright CMT, Inc.
CMT
CRAWFORD, MURPHY & TILLY, INC.
CONSULTING ENGINEERS
License No. 184-000613



DESIGN BY: ARM

DRAWN BY: JRO

CHECKED BY: ARM

APPROVED BY: DKP

DATE: 06/05/15

JOB No: 14285-02

FINAL

SHEET 4 OF 13 SHEETS

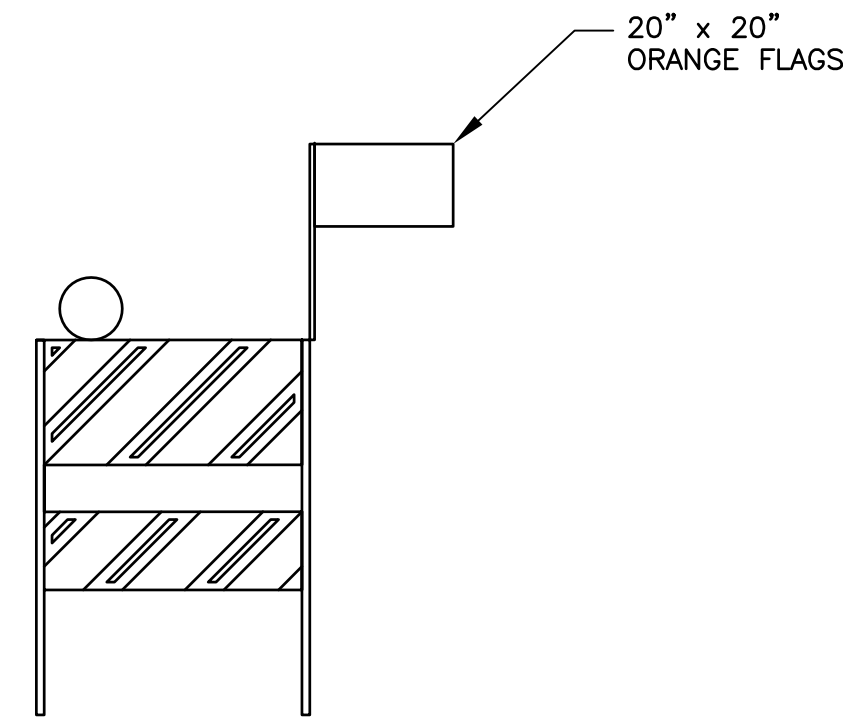

FLASHER BARRICADE DETAIL-IDOT TYPE 2
NOT TO SCALE

FLASHER BARRICADE NOTES

1. FLASHERS TO BE BATTERY OPERATED. LENS TO BE RED AND BE ABLE TO ROTATE 90 DEGREES.
2. SANDBAGS TO BE PLACED ON EACH SUPPORT BRACE AS REQUIRED TO PREVENT DISPLACEMENT BY WIND, JET OR PROP BLAST.
3. CONTRACTOR SHALL BE RESPONSIBLE FOR MAINTAINING BARRICADES AT ALL TIMES TO THE SATISFACTION OF THE AIRPORT.
4. NO SEPARATE PAYMENT WILL BE MADE FOR THIS ITEM. COSTS SHALL BE CONSIDERED INCIDENTAL TO THE PROJECT.
5. PLACE AT 10' INTERVALS.
6. ALTERNATE FLASHER LENSES SO THAT EVERY OTHER LENS IS ROTATED 90°.

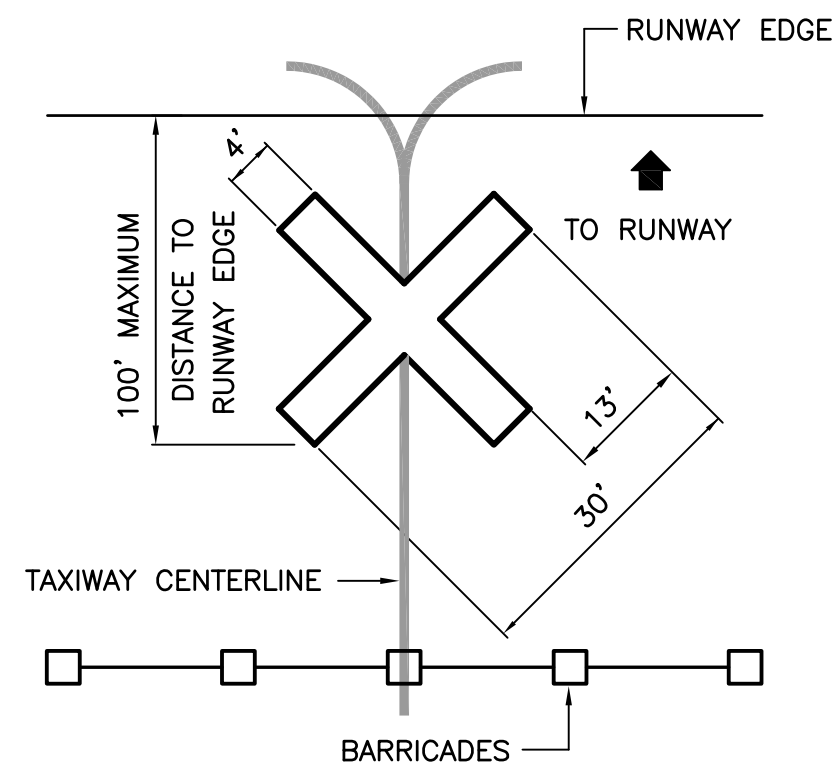

CLOSED TAXIWAY MARKER DETAIL
NOT TO SCALE

CLOSED TAXIWAY MARKER DETAIL NOTES

1. CLOSED TAXIWAY MARKERS SHALL BE PAINTED WITH TEMPORARY MARKING CAPABLE OF BEING REMOVED WITH LOW PRESSURE WATER BLASTING OR OTHER MATERIAL THAT DOES NOT VIOLATE THE OBJECT FREE AREA CRITERIA AND RUNWAY SAFETY AREA CRITERIA PER ADVISORY CIRCULAR 150/5300-13A (LATEST EDITION) AND ARE APPROVED BY THE AIRPORT.
2. CONTRACTOR SHALL MAINTAIN AND RELOCATE MARKERS AS SHOWN ON THE PLANS OR AS NEEDED TO FACILITATE CONSTRUCTION
3. COST OF FURNISHING, INSTALLING, MAINTAINING AND REMOVING MARKERS SHALL BE CONSIDERED INCIDENTAL TO THE CONTRACT.
4. PLACE MARKERS OVER TAXIWAY CENTERLINE.
5. MARKERS SHALL BE ADEQUATELY SECURED TO PREVENT MOVEMENT BY PROPELLER WASH, JET BLAST OR OTHER WIND CURRENTS.
6. MARKERS ARE ONLY REQUIRED FOR TAXIWAYS CLOSED THREE (3) CONSECUTIVE DAYS OR MORE.

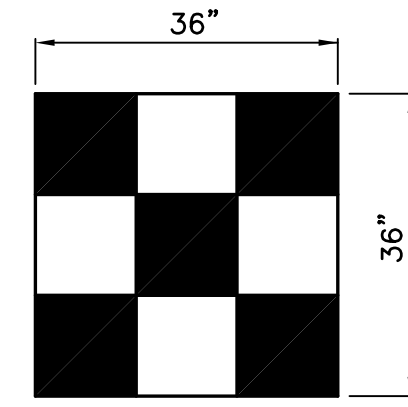

CONSTRUCTION EQUIPMENT AND TRUCK SIGNAL FLAG
NOT TO SCALE

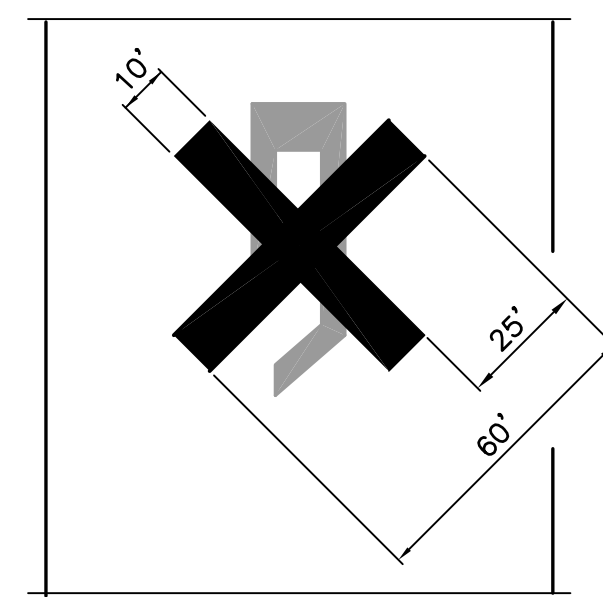

ON PAVEMENT CLOSED RUNWAY MARKER DETAIL
NOT TO SCALE

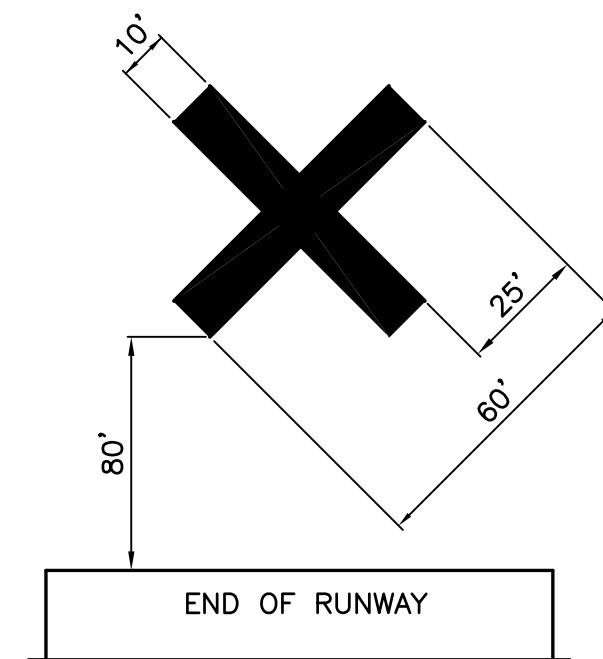

OFF PAVEMENT CLOSED RUNWAY MARKER DETAIL
NOT TO SCALE

CLOSED RUNWAY MARKER DETAIL NOTES

1. CLOSED RUNWAY MARKERS SHALL BE YELLOW.
2. MARKERS SHALL BE MATERIAL APPROVED BY THE ENGINEER.
3. CONTRACTOR SHALL MAINTAIN AND RELOCATE MARKERS AS SHOWN ON THE PLANS OR AS NEEDED TO FACILITATE CONSTRUCTION
4. MARKERS ON PAVEMENT SHALL BE PLACED OVER EXISTING RUNWAY NUMERALS AS SHOWN.
5. COST OF FURNISHING, INSTALLING, MAINTAINING AND REMOVING MARKERS SHALL BE CONSIDERED INCIDENTAL TO THE CONTRACT.
6. DURING VARIOUS PHASES OF WORK, IT WILL BE NECESSARY TO CLOSE RUNWAYS TO AIR TRAFFIC ON A TEMPORARY BASIS AS COORDINATED WITH THE AIRPORT AND TOWER PERSONNEL. THE CONTRACTOR SHALL MARK THE RUNWAYS TO BE CLOSED BY PLACING A YELLOW CROSS AT THE LOCATION AND DIMENSIONS DETAILED ON THIS SHEET. THE CROSSES ARE SHOWN ON THE RESPECTIVE RUNWAYS ACCORDING TO THE VARIOUS PHASES OF WORK AS DELINEATED IN THE SUGGESTED SEQUENCE OF CONSTRUCTION.

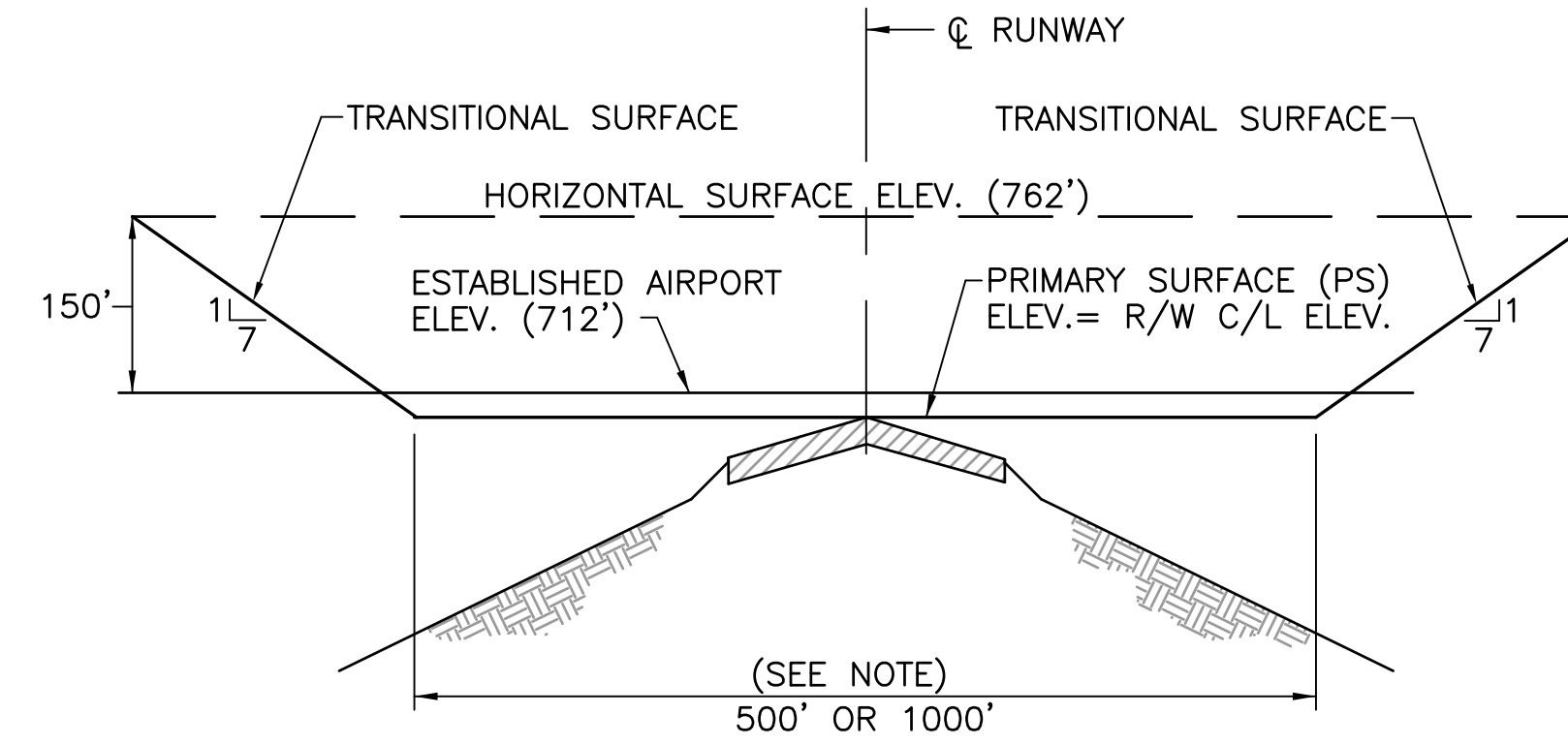

TYPICAL SECTION F.A.R. PART 77 IMAGINARY SURFACES
NO SCALE

NOTE:

IMAGINARY SURFACE REQUIREMENTS FOR EXISTING ACTIVE RUNWAYS (R/W) ARE SIMILAR EXCEPT PRIMARY SURFACE (PS) DIMENSIONS VARY
R/W 18-36 500' PS (250' LT & RT OF C)
R/W 9-27,15/33 1000' PS (500' LT & RT OF C)

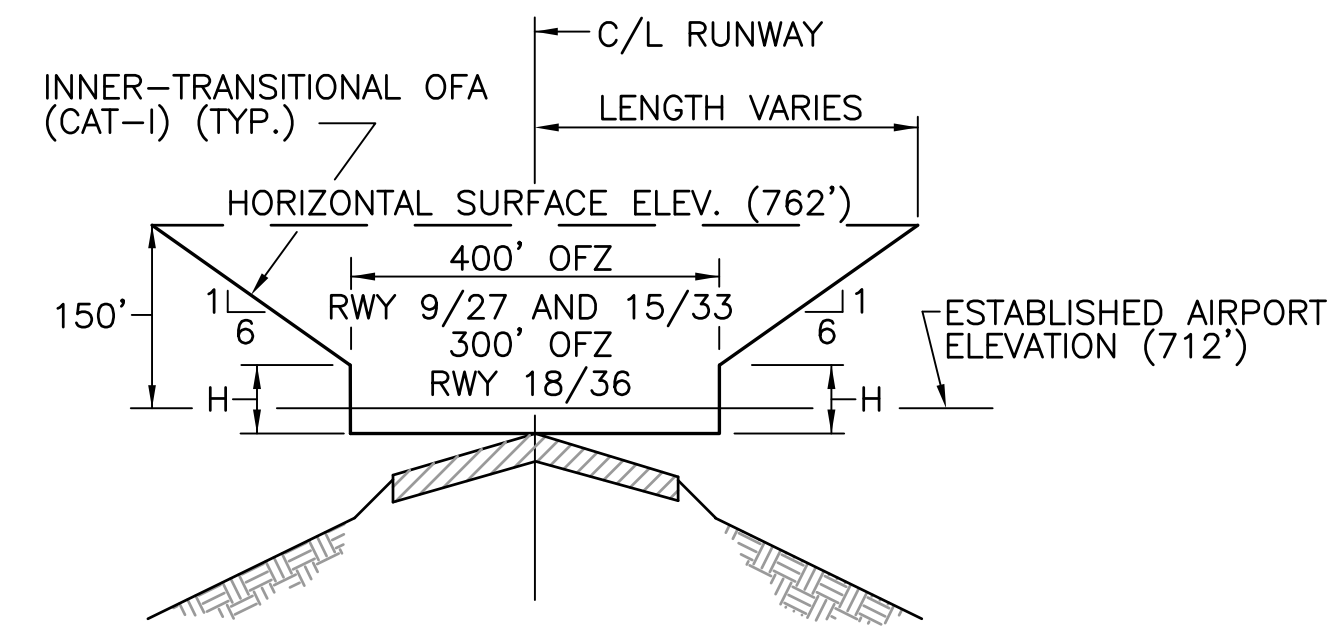

TYPICAL SECTION OBSTACLE FREE ZONE (OFZ)
NO SCALE

RUNWAY	TYPE OF RUNWAY	H (FEET)
9-27 15-33	PRECISION (CAT I)	43
18-36	VISUAL	150

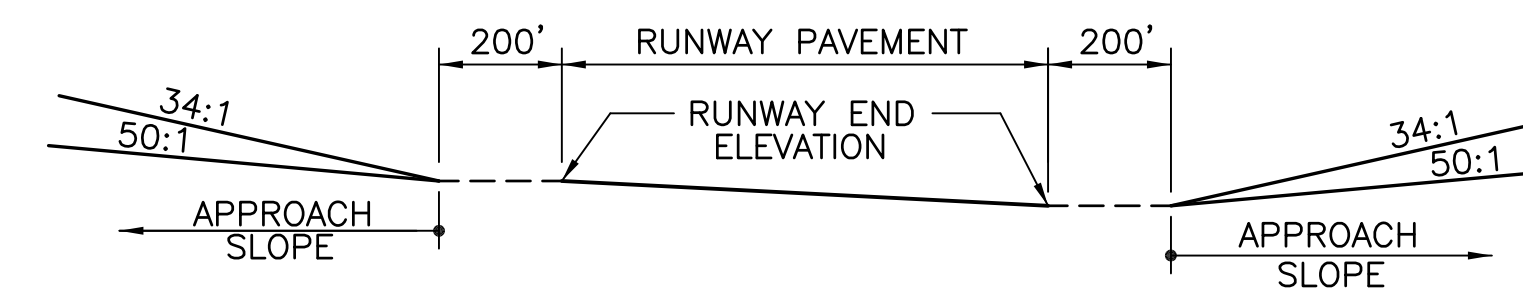

TYPICAL PROFILE F.A.R. PART 77 IMAGINARY SURFACES
NO SCALE

RUNWAY END	ELEVATION	APPROACH SLOPE
9	707	50:1
27	706	34:1
18	700	20:1
36	700	20:1
15	712	34:1
33	699	50:1

IL. CONTRACT: **AU066**
IL. LETTING ITEM: **2A**
IL. PROJECT: **ARR-4421**
S.B.G. PROJECT: **3-17-SBGP-XX**

SURVEY BOOK # BOOK #

REVISIONS		
NUMBER	BY	DATE

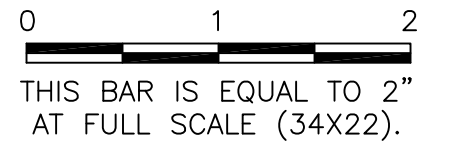

THIS BAR IS EQUAL TO 2" AT FULL SCALE (34x22).

AURORA MUNICIPAL AIRPORT
AURORA, ILLINOIS
REHABILITATE AIRFIELD SIGNAGE
SEQUENCE OF CONSTRUCTION DETAILS

© Copyright CMT, Inc.
CMT
 CRAWFORD, MURPHY & TILLY, INC.
 CONSULTING ENGINEERS
 License No. 184-000613



DESIGN BY:	ARM
DRAWN BY:	JRO
CHECKED BY:	ARM
APPROVED BY:	DKP
DATE:	06/05/15
JOB No:	14285-02

FINAL

DATE: Thursday, June 11, 2015, 4:58:47 PM
 FILE: K:\Aurora\14285-02_RehabAirfieldSignage\Draw\Sheets\06_Index To Airfield Signage.dwg
 UPDATE BY: Ryan Drea
 LAYOUT: SITEPLAN
 XREF DWG: AAR-base.dwg
 TO: NCS_ARR.dwg
 IMAGE FILES: AuroraAirport.jpg
 CMT_3c_cmyk.jpg

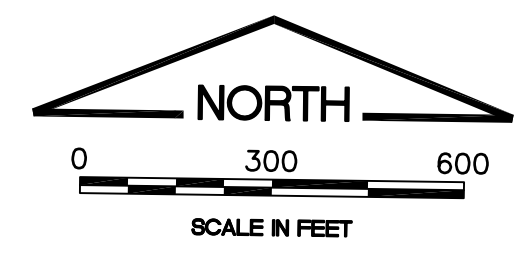
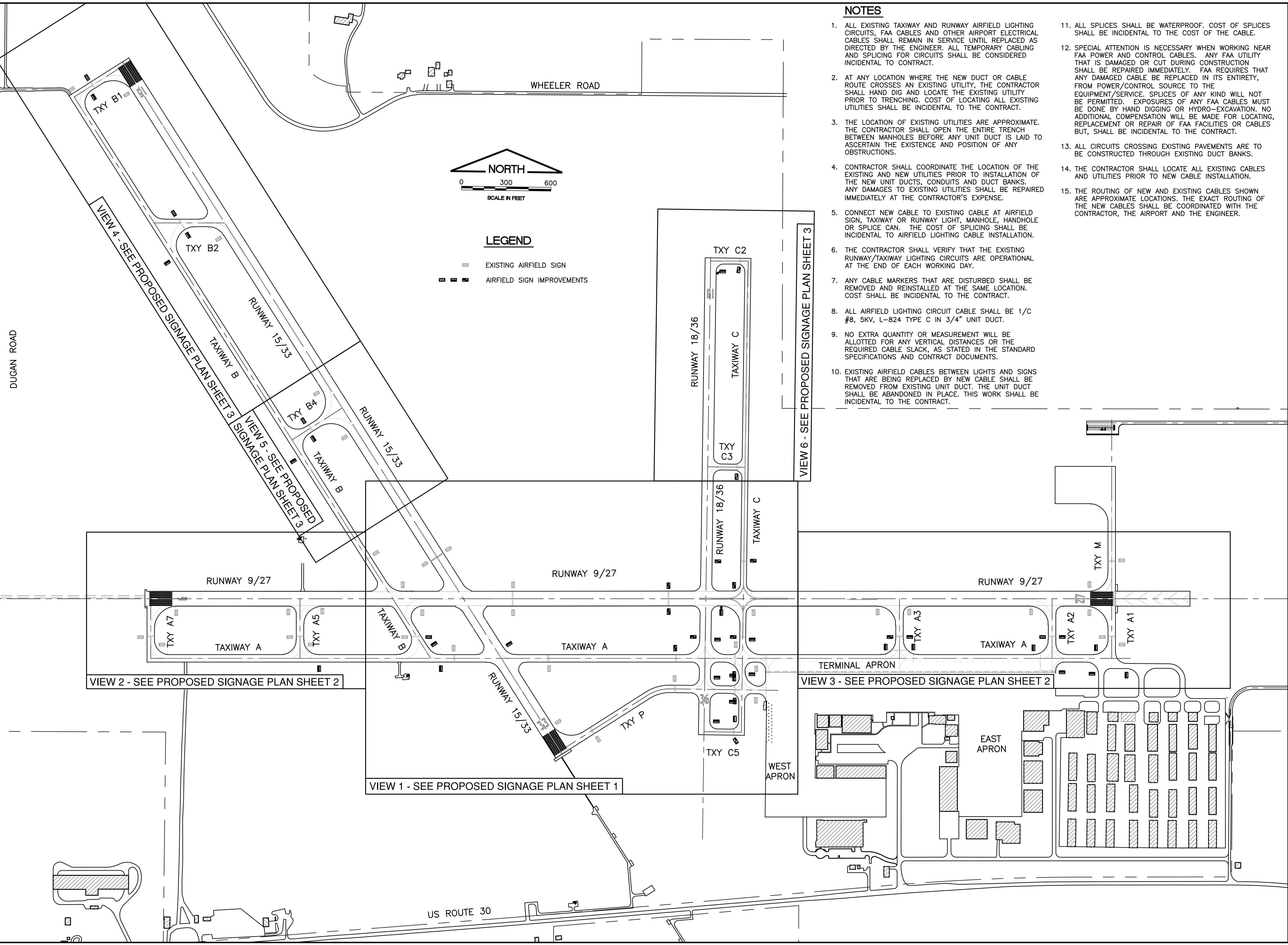

LEGEND

◻ EXISTING AIRFIELD SIGN

◻ ◻ AIRFIELD SIGN IMPROVEMENTS

NOTES

- ALL EXISTING TAXIWAY AND RUNWAY AIRFIELD LIGHTING CIRCUITS, FAA CABLES AND OTHER AIRPORT ELECTRICAL CABLES SHALL REMAIN IN SERVICE UNTIL REPLACED AS DIRECTED BY THE ENGINEER. ALL TEMPORARY CABLING AND SPLICING FOR CIRCUITS SHALL BE CONSIDERED INCIDENTAL TO CONTRACT.
- AT ANY LOCATION WHERE THE NEW DUCT OR CABLE ROUTE CROSSES AN EXISTING UTILITY, THE CONTRACTOR SHALL HAND DIG AND LOCATE THE EXISTING UTILITY PRIOR TO TRENCHING. COST OF LOCATING ALL EXISTING UTILITIES SHALL BE INCIDENTAL TO THE CONTRACT.
- THE LOCATION OF EXISTING UTILITIES ARE APPROXIMATE. THE CONTRACTOR SHALL OPEN THE ENTIRE TRENCH BETWEEN MANHOLES BEFORE ANY UNIT DUCT IS LAID TO ASCERTAIN THE EXISTENCE AND POSITION OF ANY OBSTRUCTIONS.
- CONTRACTOR SHALL COORDINATE THE LOCATION OF THE EXISTING AND NEW UTILITIES PRIOR TO INSTALLATION OF THE NEW UNIT DUCTS, CONDUITS AND DUCT BANKS. ANY DAMAGES TO EXISTING UTILITIES SHALL BE REPAIRED IMMEDIATELY AT THE CONTRACTOR'S EXPENSE.
- CONNECT NEW CABLE TO EXISTING CABLE AT AIRFIELD SIGN, TAXIWAY OR RUNWAY LIGHT, MANHOLE, HANDHOLE OR SPLICE CAN. THE COST OF SPLICING SHALL BE INCIDENTAL TO AIRFIELD LIGHTING CABLE INSTALLATION.
- THE CONTRACTOR SHALL VERIFY THAT THE EXISTING RUNWAY/TAXIWAY LIGHTING CIRCUITS ARE OPERATIONAL AT THE END OF EACH WORKING DAY.
- ANY CABLE MARKERS THAT ARE DISTURBED SHALL BE REMOVED AND REINSTALLED AT THE SAME LOCATION. COST SHALL BE INCIDENTAL TO THE CONTRACT.
- ALL AIRFIELD LIGHTING CIRCUIT CABLE SHALL BE 1/2" #8, 5KV, L-824 TYPE C IN 3/4" UNIT DUCT.
- NO EXTRA QUANTITY OR MEASUREMENT WILL BE ALLOTTED FOR ANY VERTICAL DISTANCES OR THE REQUIRED CABLE SLACK, AS STATED IN THE STANDARD SPECIFICATIONS AND CONTRACT DOCUMENTS.
- EXISTING AIRFIELD CABLES BETWEEN LIGHTS AND SIGNS THAT ARE BEING REPLACED BY NEW CABLE SHALL BE REMOVED FROM EXISTING UNIT DUCT. THE UNIT DUCT SHALL BE ABANDONED IN PLACE. THIS WORK SHALL BE INCIDENTAL TO THE CONTRACT.
- ALL SPLICES SHALL BE WATERPROOF. COST OF SPLICES SHALL BE INCIDENTAL TO THE COST OF THE CABLE.
- SPECIAL ATTENTION IS NECESSARY WHEN WORKING NEAR FAA POWER AND CONTROL CABLES. ANY FAA UTILITY THAT IS DAMAGED OR CUT DURING CONSTRUCTION SHALL BE REPAIRED IMMEDIATELY. FAA REQUIRES THAT ANY DAMAGED CABLE BE REPLACED IN ITS ENTIRETY, FROM POWER/CONTROL SOURCE TO THE EQUIPMENT/SERVICE. SPLICES OF ANY KIND WILL NOT BE PERMITTED. EXPOSURES OF ANY FAA CABLES MUST BE DONE BY HAND DIGGING OR HYDRO-EXCAVATION. NO ADDITIONAL COMPENSATION WILL BE MADE FOR LOCATING, REPLACEMENT OR REPAIR OF FAA FACILITIES OR CABLES BUT, SHALL BE INCIDENTAL TO THE CONTRACT.
- ALL CIRCUITS CROSSING EXISTING PAVEMENTS ARE TO BE CONSTRUCTED THROUGH EXISTING DUCT BANKS.
- THE CONTRACTOR SHALL LOCATE ALL EXISTING CABLES AND UTILITIES PRIOR TO NEW CABLE INSTALLATION.
- THE ROUTING OF NEW AND EXISTING CABLES SHOWN ARE APPROXIMATE LOCATIONS. THE EXACT ROUTING OF THE NEW CABLES SHALL BE COORDINATED WITH THE CONTRACTOR, THE AIRPORT AND THE ENGINEER.

IL. CONTRACT: **AU066**
 IL. LETTING ITEM: **2A**
 IL. PROJECT: **ARR-4421**
 S.B.G. PROJECT: **3-17-SBGP-XX**

SURVEY BOOK # BOOK #

REVISIONS		
NUMBER	BY	DATE

0 1 2
 THIS BAR IS EQUAL TO 2"
 AT FULL SCALE (34x22).

**AURORA MUNICIPAL AIRPORT
 AURORA, ILLINOIS
 REHABILITATE AIRFIELD SIGNAGE**

INDEX TO AIRFIELD SIGNING

© copyright CMT, Inc.

CMT
 CRAWFORD, MURPHY & TILLY, INC.
 CONSULTING ENGINEERS
 License No. 184-000613

CHICAGO
AURORA
 MUNICIPAL AIRPORT

DESIGN BY:	RMD
DRAWN BY:	JRO
CHECKED BY:	DKP
APPROVED BY:	DKP
DATE:	06/05/15
JOB No:	14285-02

FINAL

SHEET 6 OF 13 SHEETS

DATE: Thursday, June 11, 2015 4:59:28 PM
 FILE: K:\Aurora\14285-02_RehabAirfieldSignage\Draw\Sheets\07-09_Proc_Sign.dwg
 UPDATE BY: Ryan Drea
 LAYOUT: VIEW 1
 IMAGE FILES: Aurora\port.jpg
 CMT_3C_cmyk.jpg
 XREF DWG: AR-base.dwg
 TO: NCS_AIR.dwg

THE INFORMATION SHOWN ON THESE PLANS HAS BEEN OBTAINED FROM AVAILABLE RECORDS. NEITHER THE OWNER NOR THE ENGINEER ASSUMES ANY RESPONSIBILITY WHATSOEVER IN RESPECT TO THE ACCURACY OR SUFFICIENCY OF THE INFORMATION AND THERE IS NO GUARANTEE EITHER EXPRESSED OR IMPLIED THAT THE CONDITIONS INDICATED ARE REPRESENTATIVE OF THOSE TO BE ENCOUNTERED IN THE FIELD. IT SHALL BE THE CONTRACTOR'S RESPONSIBILITY TO VISIT THE SITE AND ACQUAINT HIMSELF WITH THE EXISTING CONDITIONS.

NEW LEGEND

- EXISTING SIGN TO BE REMOVED AND REPLACED WITH NEW SIGN (EXISTING FOUNDATION PAD TO REMAIN)
- NEW AIRFIELD SIGN ON NEW FOUNDATION PAD
- MODIFY EXISTING SIGN PANEL
- NEW SIGN NUMBER (SEE AIRFIELD SIGNAGE SCHEDULE SHEET)
- NEW 1/C #8, 5KV L-824, TYPE C, UNDERGROUND CABLE IN 3/4" UNIT DUCT (CIRCUIT # NOTED)
- NEW PAVEMENT MARKING
- EXISTING PAVEMENT MARKING TO BE REMOVED
- NEW SPLICE CAN

EXISTING CONDITIONS LEGEND

- EXISTING PAVEMENT MARKING
- EXISTING AIRFIELD SIGN TO REMAIN
- EXISTING BASE MOUNTED LIGHT
- EXISTING STAKE MOUNTED LIGHT
- EXISTING GRS CONDUIT
- EXISTING CONCRETE ENCASED DUCT BANK (NUMBER OF WAYS)
- EXISTING RUNWAY DESIGNATION CIRCUIT
- EXISTING LAHSO CIRCUIT
- EXISTING CENTERFIELD WEATHER
- EXISTING WIND TEE
- EXISTING BEACON
- EXISTING REIL CIRCUIT
- EXISTING FAA CABLE
- EXISTING PAPI CIRCUIT
- EXISTING UNDERGROUND ELECTRIC CABLE
- EXISTING COMMONWEALTH EDISON ELECTRIC CABLE
- EXISTING ELECTRIC CABLE
- EXISTING VASI CIRCUIT
- EXISTING 1/C #8, 5KV L-824, TYPE C UNDERGROUND CABLE IN 3/4" UNIT DUCT (CIRCUIT # NOTED)

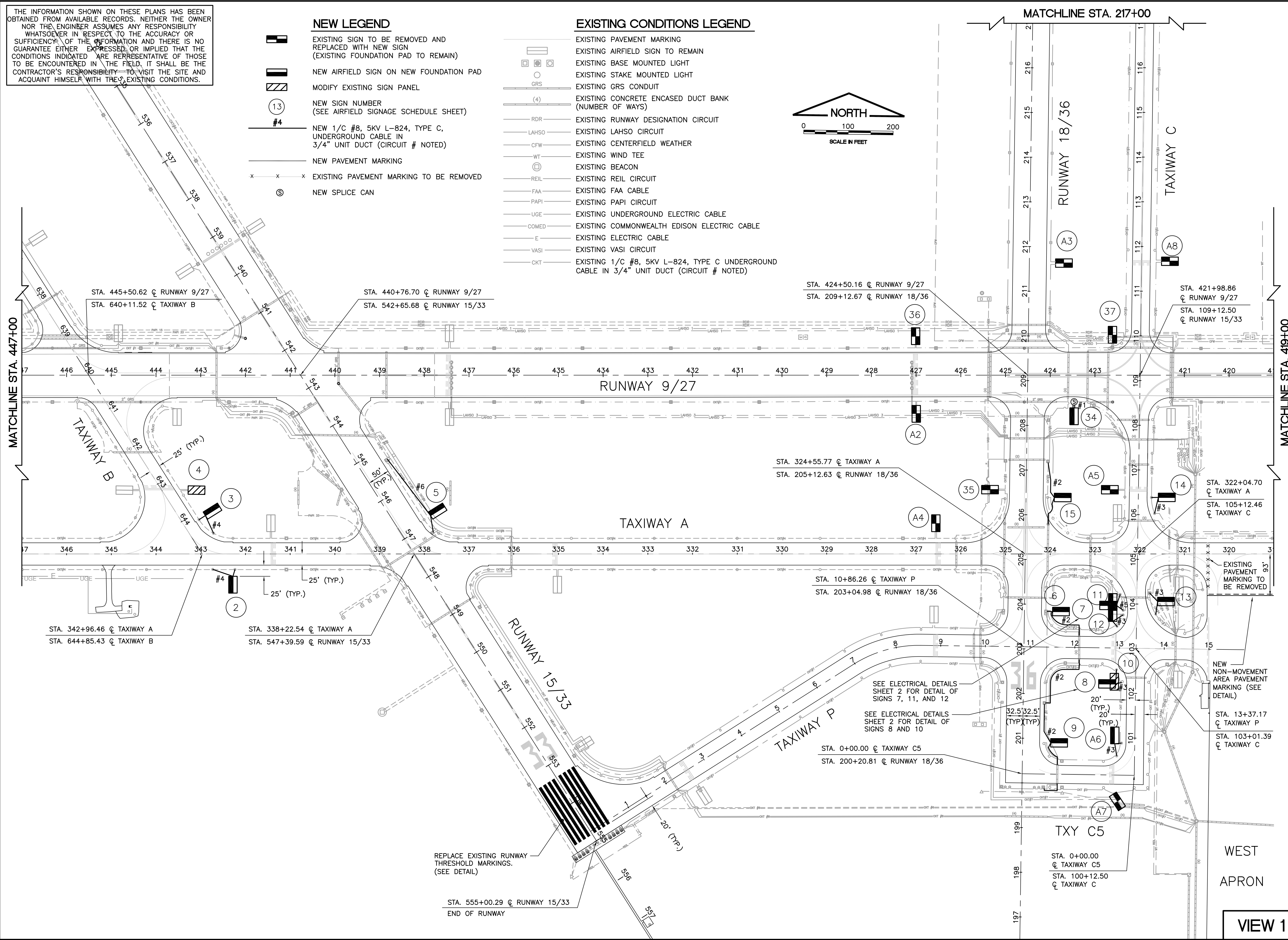
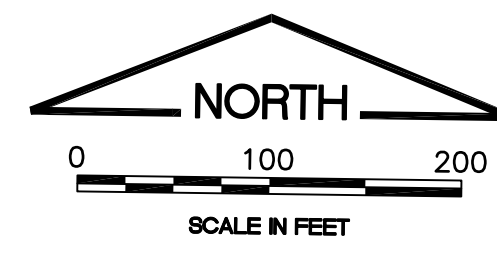

IL. CONTRACT: **AU066**
 IL. LETTING ITEM: **2A**
 IL. PROJECT: **ARR-4421**
 S.B.G. PROJECT: **3-17-SBGP-XX**

SURVEY BOOK # BOOK #

REVISIONS		
NUMBER	BY	DATE

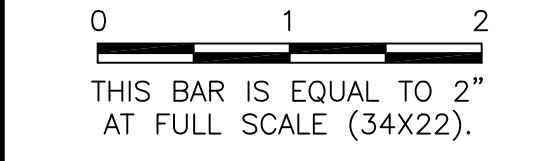

**AURORA MUNICIPAL AIRPORT
 AURORA, ILLINOIS
 REHABILITATE AIRFIELD SIGNAGE**

**PROPOSED SIGNAGE PLAN
 SHEET 1**

© Copyright CMT, Inc.

CMT
 CRAWFORD, MURPHY & TILLY, INC.
 CONSULTING ENGINEERS
 License No. 184-000613

DESIGN BY:	RMD
DRAWN BY:	JRO
CHECKED BY:	DKP
APPROVED BY:	DKP
DATE:	06/05/15
JOB No:	14285-02

FINAL

SHEET 7 OF 13 SHEETS

THE INFORMATION SHOWN ON THESE PLANS HAS BEEN OBTAINED FROM AVAILABLE RECORDS. NEITHER THE OWNER NOR THE ENGINEER ASSUMES ANY RESPONSIBILITY WHATSOEVER IN RESPECT TO THE ACCURACY OR SUFFICIENCY OF THE INFORMATION AND THERE IS NO GUARANTEE EITHER EXPRESSED OR IMPLIED THAT THE CONDITIONS INDICATED ARE REPRESENTATIVE OF THOSE TO BE ENCOUNTERED IN THE FIELD. IT SHALL BE THE CONTRACTOR'S RESPONSIBILITY TO VISIT THE SITE AND ACQUAINT HIMSELF WITH THE EXISTING CONDITIONS.

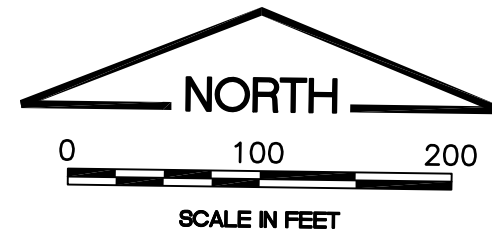

FOR EXISTING CONDITIONS LEGEND
SEE PROPOSED SIGNAGE PLAN SHEET 1

- NEW LEGEND**
- EXISTING SIGN TO BE REMOVED AND REPLACED WITH NEW SIGN (EXISTING FOUNDATION PAD TO REMAIN)
 - NEW AIRFIELD SIGN ON NEW FOUNDATION PAD
 - MODIFY EXISTING SIGN PANEL
 - NEW SIGN NUMBER (SEE AIRFIELD SIGNAGE SCHEDULE SHEET)
 - NEW 1/C #8, 5KV L-824, TYPE C, UNDERGROUND CABLE IN 3/4" UNIT DUCT (CIRCUIT # NOTED)
 - NEW PAVEMENT MARKING
 - EXISTING PAVEMENT MARKING TO BE REMOVED
 - NEW SPLICE CAN

IL. CONTRACT: **AU066**
IL. LETTING ITEM: **2A**
IL. PROJECT: **ARR-4421**
S.B.G. PROJECT: **3-17-SBGP-XX**

SURVEY BOOK # BOOK #

REVISIONS		
NUMBER	BY	DATE

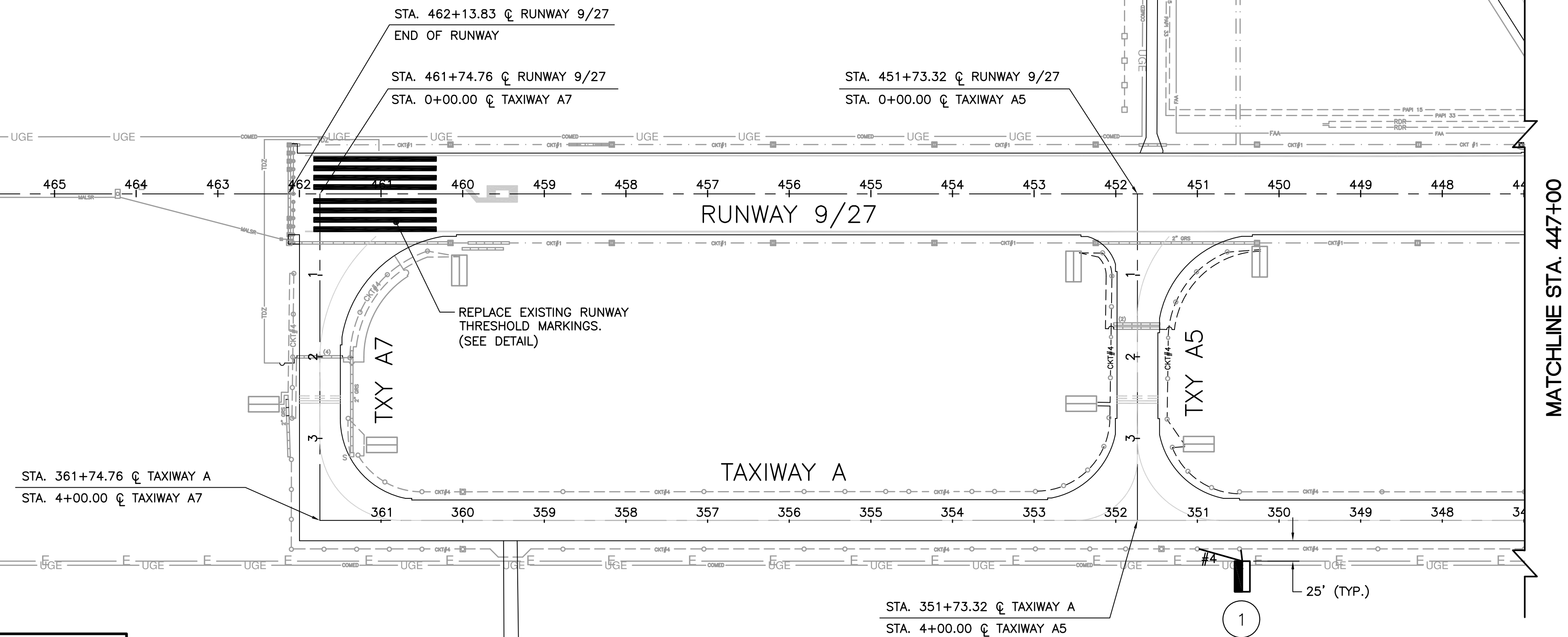
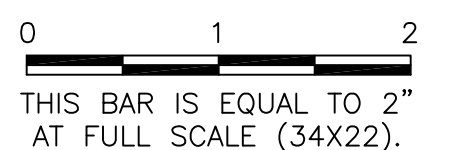

VIEW 2

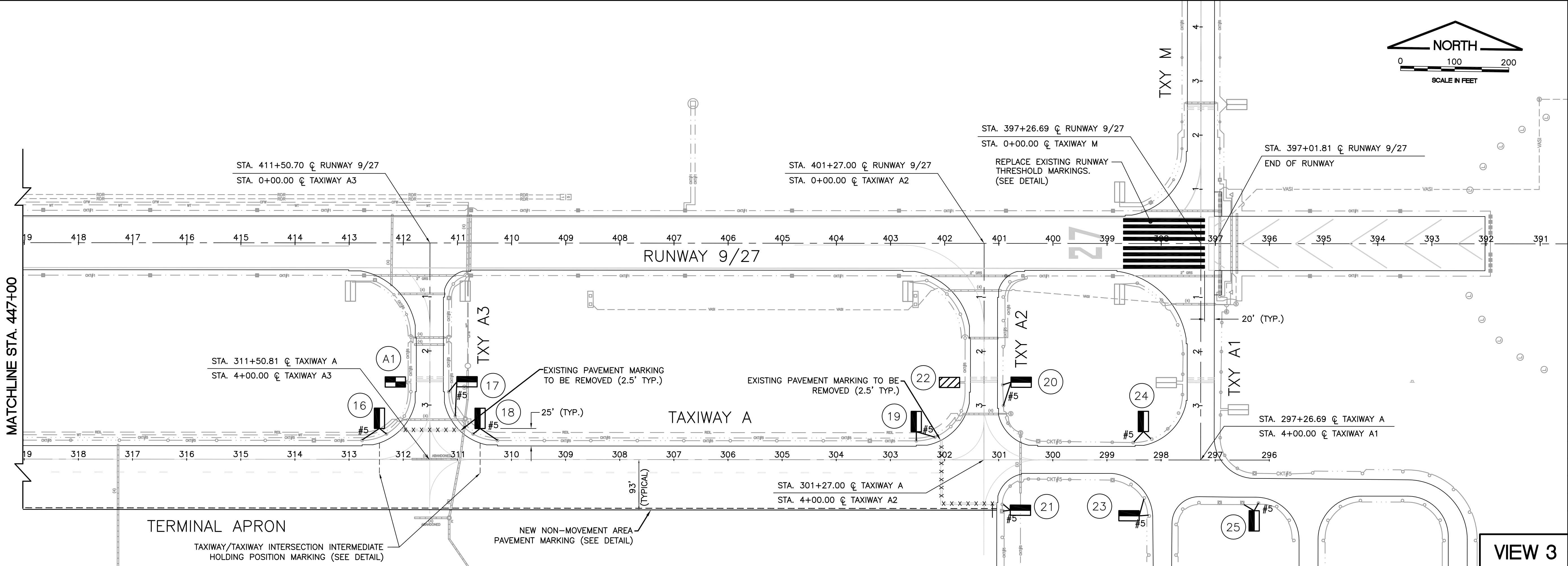

VIEW 3

**AURORA MUNICIPAL AIRPORT
AURORA, ILLINOIS
REHABILITATE AIRFIELD SIGNAGE**

**PROPOSED SIGNAGE PLAN
SHEET 2**

CMT
CRAWFORD, MURPHY & TILLY, INC.
CONSULTING ENGINEERS
License No. 184-000613

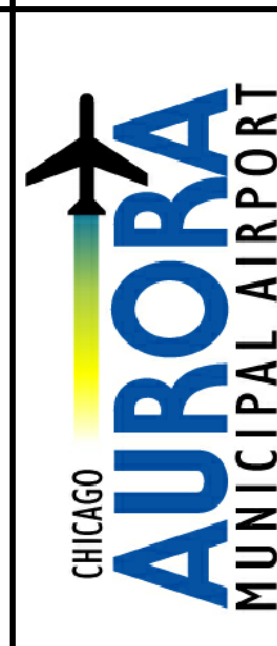

DESIGN BY: RMD
DRAWN BY: JRO
CHECKED BY: DKP
APPROVED BY: DKP
DATE: 06/05/15
JOB No: 14285-02

FINAL

SHEET 8 OF 13 SHEETS

XREF DWG: ARR-base.dwg
 IMAGE FILES: Auroradpport.jpg
 CM_3C_cmyk.jpg
 UPDATE BY: Ryan Drea
 LAYOUT: VIEW 2 AND 3
 DATE: Thursday, June 11, 2015 4:59:34 PM
 FILE: K:\Aurora\14285-02_RehabAirfieldSignage\Draw\Sheets\07-09_Sign.dwg
 MATCHLINE STA. 447+00

THE INFORMATION SHOWN ON THESE PLANS HAS BEEN OBTAINED FROM AVAILABLE RECORDS. NEITHER THE OWNER NOR THE ENGINEER ASSUMES ANY RESPONSIBILITY WHATSOEVER IN RESPECT TO THE ACCURACY OR SUFFICIENCY OF THE INFORMATION AND THERE IS NO GUARANTEE EITHER EXPRESSED OR IMPLIED THAT THE CONDITIONS INDICATED ARE REPRESENTATIVE OF THOSE TO BE ENCOUNTERED IN THE FIELD. IT SHALL BE THE CONTRACTOR'S RESPONSIBILITY TO VISIT THE SITE AND ACQUAINT HIMSELF WITH THE EXISTING CONDITIONS.

FOR EXISTING CONDITIONS LEGEND
SEE PROPOSED SIGNAGE PLAN SHEET 1

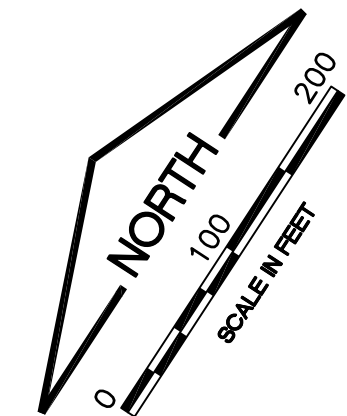

IL. CONTRACT: **AU066**
IL. LETTING ITEM: **2A**
IL. PROJECT: **ARR-4421**
S.B.G. PROJECT: **3-17-SBGP-XX**

SURVEY BOOK # BOOK #

REVISIONS		
NUMBER	BY	DATE

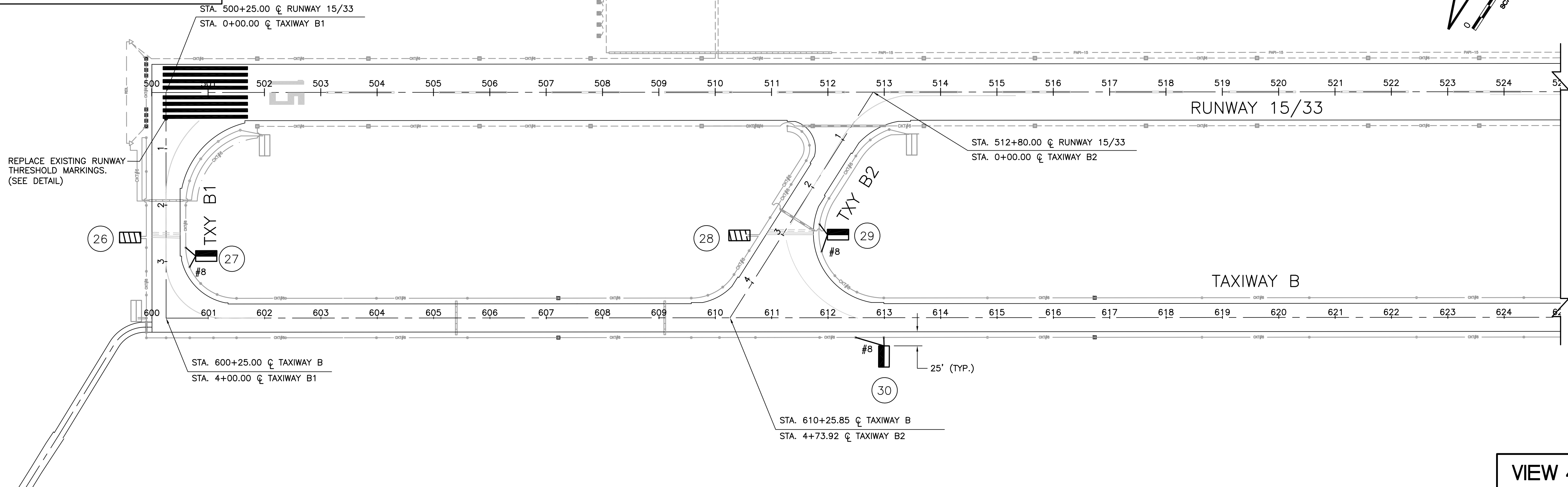
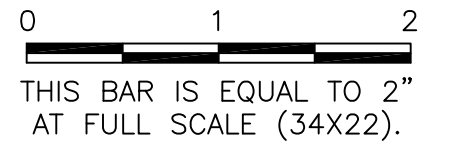

VIEW 4

XREF DWG: ARR-base.dwg
 IMAGE FILES: AuroraAirport.jpg
 UPDATE BY: Ryan Drea
 LAYOUT: VIEW 4 TO 6
 DATE: Thursday, June 11, 2015, 4:59:39 PM
 FILE: K:\Aurora\14285-02_Rehab\field\Signage\Draw_Sheets\07-09_Sign.dwg

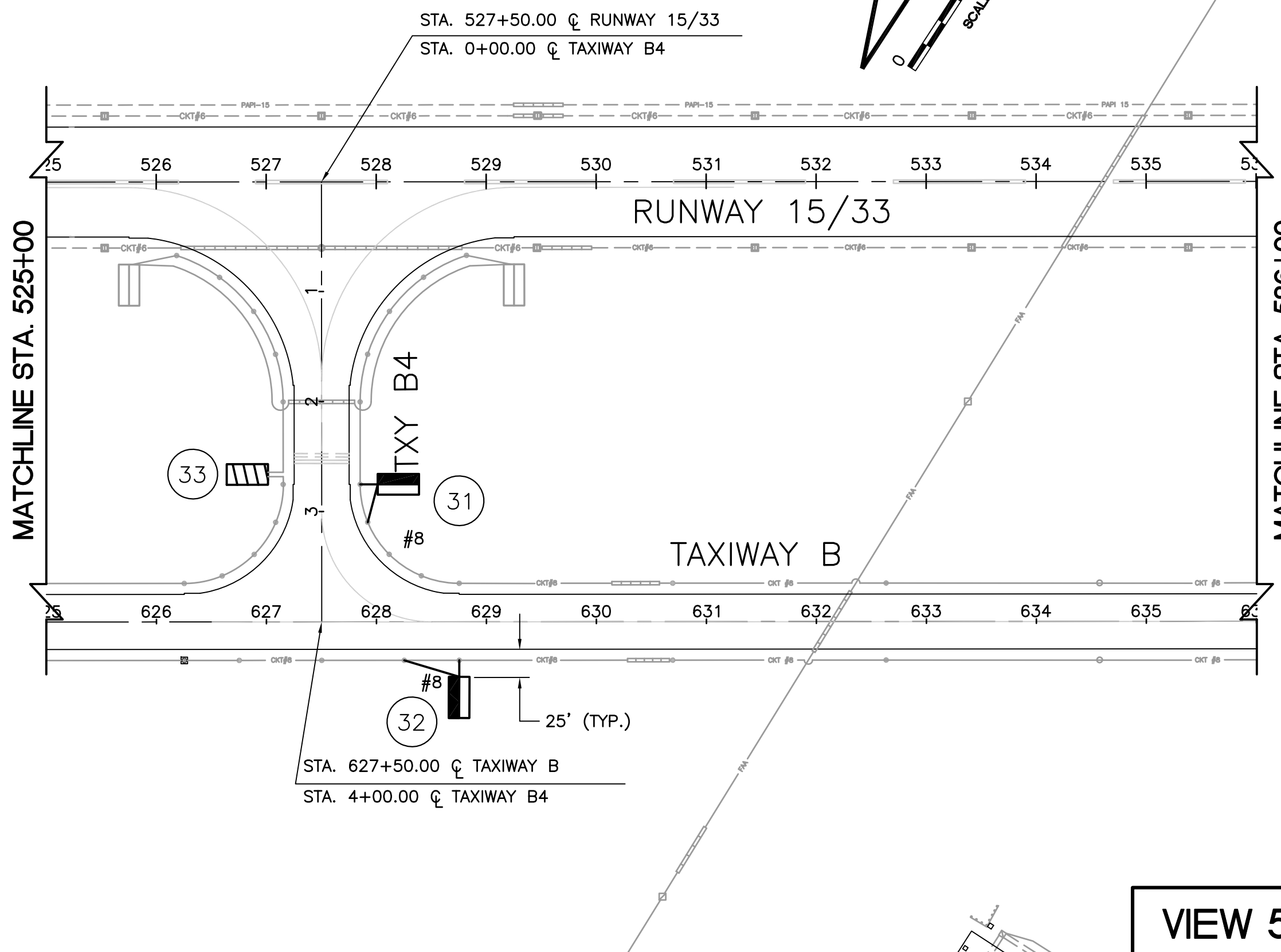

VIEW 5

NEW LEGEND

	EXISTING SIGN TO BE REMOVED AND REPLACED WITH NEW SIGN (EXISTING FOUNDATION PAD TO REMAIN)		NEW SIGN NUMBER (SEE AIRFIELD SIGNAGE SCHEDULE SHEET)
	NEW AIRFIELD SIGN ON NEW FOUNDATION PAD		NEW 1/C #8, 5KV L-824, TYPE C, UNDERGROUND CABLE IN 3/4" UNIT DUCT (CIRCUIT # NOTED)
	MODIFY EXISTING SIGN PANEL		NEW PAVEMENT MARKING
			EXISTING PAVEMENT MARKING TO BE REMOVED
			NEW SPLICE CAN

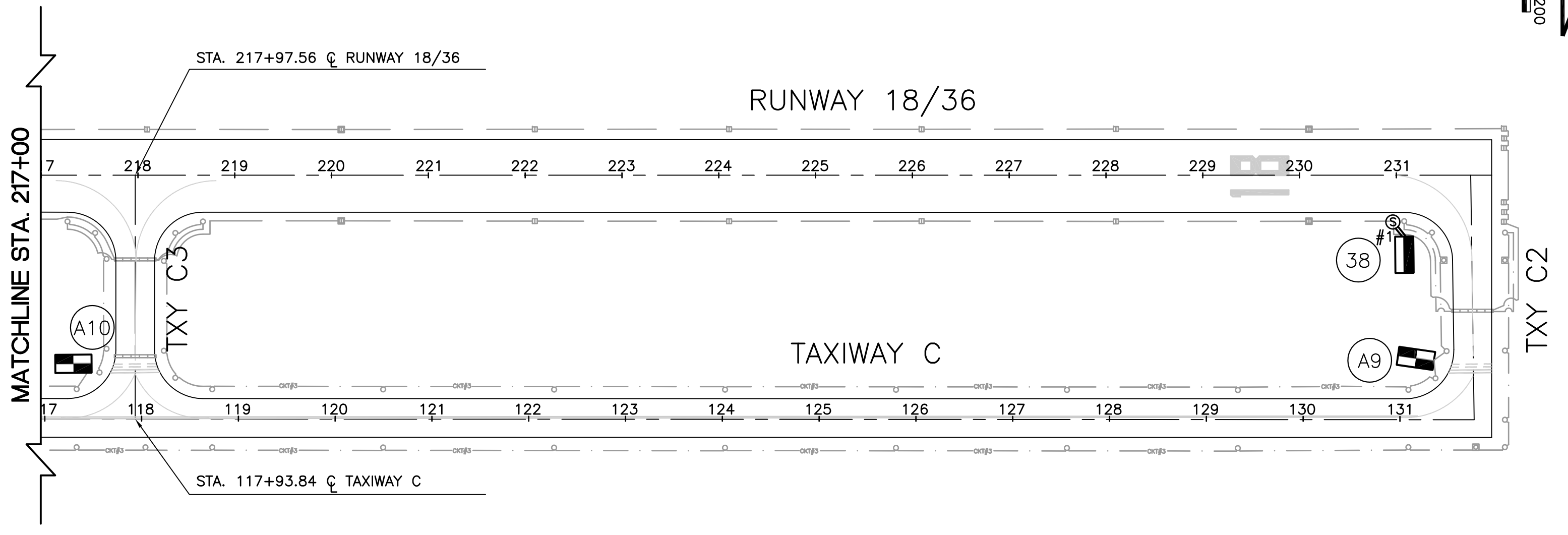
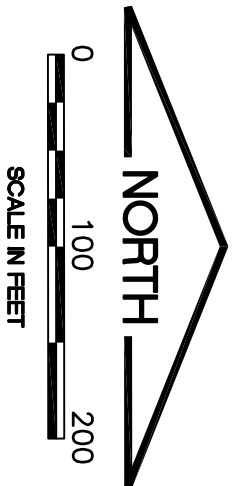

VIEW 6

AURORA MUNICIPAL AIRPORT
AURORA, ILLINOIS
REHABILITATE AIRFIELD SIGNAGE

PROPOSED SIGNAGE PLAN
SHEET 3

CMT
 CRAWFORD, MURPHY & TILLY, INC.
 CONSULTING ENGINEERS
 License No. 184-000613



DESIGN BY:	RMD
DRAWN BY:	JRO
CHECKED BY:	DKP
APPROVED BY:	DKP
DATE:	06/05/15
JOB No:	14285-02

FINAL

XREF DWG: 16-NCS-ARR-dwg
 IMAGE FILES: Auroara\Aurora\Draw\Sheets\10_Elec\11.dwg
 UPDATE BY: Ryan Drea
 LAYOUT: Layout1
 DATE: Thursday, June 11, 2015 4:59:58 PM
 FILE: K:\Aurora\14285-02_RehabAirfieldSignage\Draw\Sheets\10_Elec\11.dwg

NOTES

- ALL SIGNS ARE 2 - SIDED SIGNS.
- TRANSFORMER WATTAGE AS RECOMMENDED BY MANUFACTURER FOR LED SIGNS.
- LIGHTED SIGNS SHALL BE BASE MOUNTED ONLY.
- UNIT DUCT SHALL BE TERMINATED IN THE CAN AND SEALED TO THE CABLE WITH HEAT SHRINK AS SPECIFIED.
- ALL NEW SIGNS SHALL BE LED TYPE, L-858 APPROVED BY FAA.
- TYPICAL PERPENDICULAR DISTANCES FOR TAXIWAY INTERSECTION SIGNS FROM CENTERLINE OF CROSSING TAXIWAY IS 93' UNLESS OTHERWISE NOTED.
- TYPICAL DISTANCES FOR RUNWAY HOLD SIGNS FROM RUNWAY CENTERLINE ARE AS FOLLOWS:
 9/27 = 257'
 15/33 = 257'
 18/36 = 200'
- ALL SIGNS CONNECTED TO HIGH INTENSITY RUNWAY CIRCUIT 9/27 AND 15/33 AND ALL TAXIWAY HOLD SIGNS FOR RUNWAY 9/27 AND RUNWAY 15/33 (5-STEP) SHALL BE STYLE 3 (5-STEP).

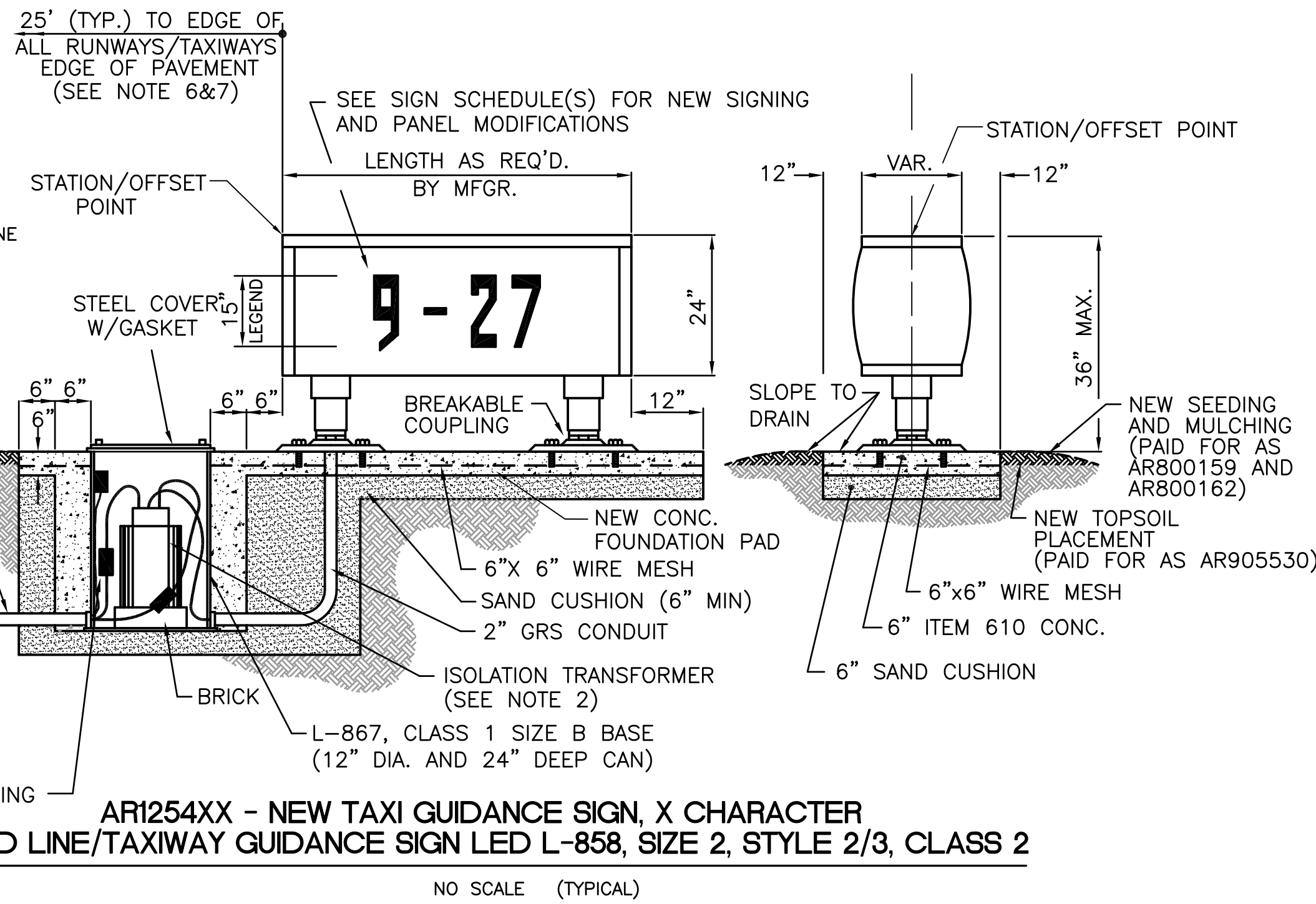

CONTRACTOR SHALL SUBMIT DETAILED SHOP DRAWING INCLUDING SIGN, COLOR, SIZE, PROPOSED LEGEND, IN ENOUGH DETAIL AND DETERMINE NEW SPACING AND OTHER INFORMATION REQUIRED BY SPECIAL PROVISIONS. CONTRACTOR TO VERIFY NEW SIGN LOCATIONS AND ORIENTATIONS WITH RESIDENT ENGINEER PRIOR TO INSTALLATION. SIGN SHALL BE FAA APPROVED LED TYPE SIGN.

NOTES

- ALL SIGNS ARE 2 - SIDED SIGNS.
- TRANSFORMER WATTAGE AS RECOMMENDED BY MANUFACTURER FOR LED SIGNS.
- LIGHTED SIGNS SHALL BE BASE MOUNTED ONLY.
- UNIT DUCT SHALL BE TERMINATED IN THE CAN AND SEALED TO THE CABLE WITH HEAT SHRINK AS SPECIFIED.
- ALL NEW SIGNS SHALL BE LED TYPE, L-858 APPROVED BY FAA.
- TYPICAL PERPENDICULAR DISTANCES FOR TAXIWAY INTERSECTION SIGNS FROM CENTERLINE OF CROSSING TAXIWAY IS 93' UNLESS OTHERWISE NOTED.
- TYPICAL DISTANCES FOR RUNWAY HOLD SIGNS FROM RUNWAY CENTERLINE ARE AS FOLLOWS:
 9/27 = 257'
 15/33 = 257'
 18/36 = 200'
- ANY DAMAGE DONE TO EXISTING CONCRETE PAD, CONDUIT OR LIGHT CAN COMPONENTS BY THE CONTRACTOR SHALL BE REPAIRED OR REPLACED AS DIRECTED BY THE ENGINEER AT NO ADDITIONAL COST TO THE CONTRACT.
- ALL NEW LIGHTING COMPONENTS SHALL BE PROVIDED BY THE CONTRACTOR AND SHALL BE INCLUDED IN PAY ITEM AR80013X UNLESS SPECIFIED OTHERWISE.
- ALL SIGNS CONNECTED TO HIGH INTENSITY RUNWAY CIRCUIT 9/27 AND 15/33 AND ALL TAXIWAY HOLD SIGNS FOR RUNWAY 9/27 AND RUNWAY 15/33 (5-STEP) SHALL BE STYLE 3 (5-STEP).

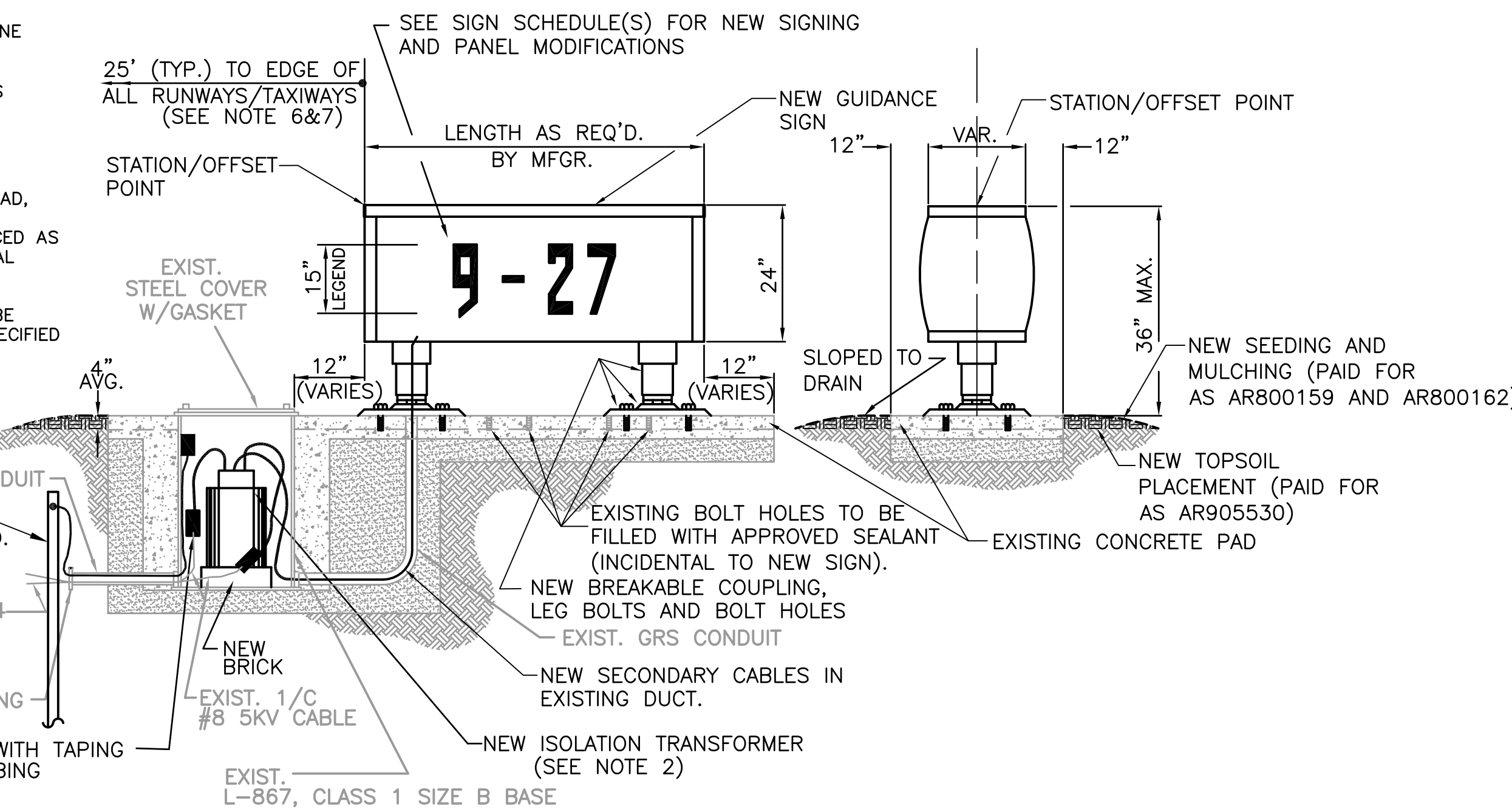

CONTRACTOR SHALL SUBMIT DETAILED SHOP DRAWING INCLUDING SIGN, COLOR, SIZE, PROPOSED LEGEND, IN ENOUGH DETAIL AND DETERMINE NEW SPACING AND OTHER INFORMATION REQUIRED BY SPECIAL PROVISIONS. CONTRACTOR TO VERIFY NEW SIGN LOCATIONS AND ORIENTATIONS WITH RESIDENT ENGINEER PRIOR TO INSTALLATION. SIGN SHALL BE FAA APPROVED LED TYPE SIGN.

GENERAL NOTES:

- THE CONCRETE BASE FOR BASE MTD. LIGHTS AND SIGNS SHALL BE TROWEL FINISHED WITH A 45° BEVELED EDGE. SLOPE TO DRAIN (610).
- TRANSFORMER HOLDER SHALL BE ANY COMMERCIALY AVAILABLE BRICK.
- BREAKING GROOVE COUPLINGS SHALL NOT BE OVER 1" ABOVE GROUND LINE.
- ISOLATION TRANSFORMERS COME WITH A FACTORY INSTALLED PLUG (TYPE 1, CLASS A, STYLE 2) AND RECEPTACLE (TYPE 1, CLASS A, STYLE 9). A TYPE 1, CLASS B, STYLE 3 PLUG AND TYPE 1, CLASS B, STYLE 10 RECEPTACLE SHALL BE INSTALLED ON THE 1/C, No. 8, 5000 V., L-824 TYPE C CABLES FOR CONNECTION TO EACH TRANSFORMER.
- TO FURTHER REDUCE THE POSSIBILITY OF WATER/MOISTURE ENTRANCE INTO THE CONNECTOR BETWEEN THE CABLE AND THE FIELD ATTACHED CONNECTOR, IT IS REQUIRED THAT A HEAT SHRINKABLE TUBING WITH INTERNAL ADHESIVE BE APPLIED OVER THE ENTIRE CABLE CONNECTOR.
- ALL SIGNS, LIGHTS, CABLES AND TRANSFORMERS TO BE REMOVED SHALL REMAIN THE PROPERTY OF THE AIRPORT. AT THE DISCRETION OF THE AIRPORT MANAGER, THE CONTRACTOR MAY BE REQUIRED TO DISPOSE OF THESE MATERIALS OFFSITE AT NO ADDITIONAL COST TO THE CONTRACT.
- CONTRACTOR SHALL HAVE THE OPTION TO TRENCH OR PLOW UNIT DUCT. NO ADDITIONAL PAYMENT SHALL BE MADE FOR TRENCHING.
- INSTALL SAFETY GROUND (1/C #6 AWG INSULATED GREEN GROUND JUMPER) TO EXISTING SIGNS AND L-867 CANS. ATTACH GROUND LUG TO EXISTING CAN AND INSTALL GROUND ROD AS SHOWN ON PLANS. COST INCIDENTAL TO CONTRACT.
- INSTALL 1/C #6 AWG INSULATED GREEN GROUND JUMPER CONNECTED TO GROUND LUG INSIDE BASE CAN OR STAKE AND EXOTHERMICALLY WELDED TO GROUND ROD. GROUND ROD AND GROUND WIRE SHALL BE INCIDENTAL TO CONTRACT.

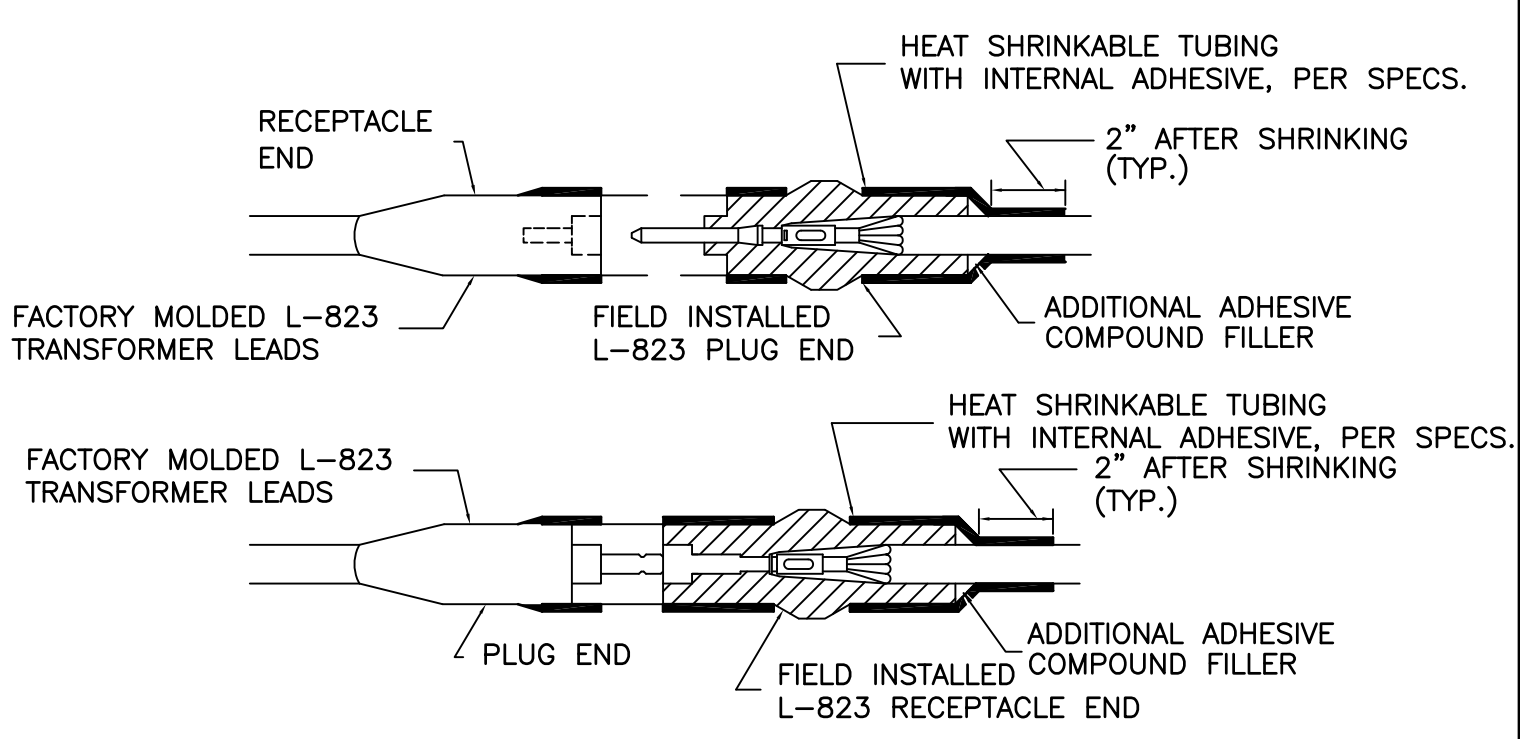
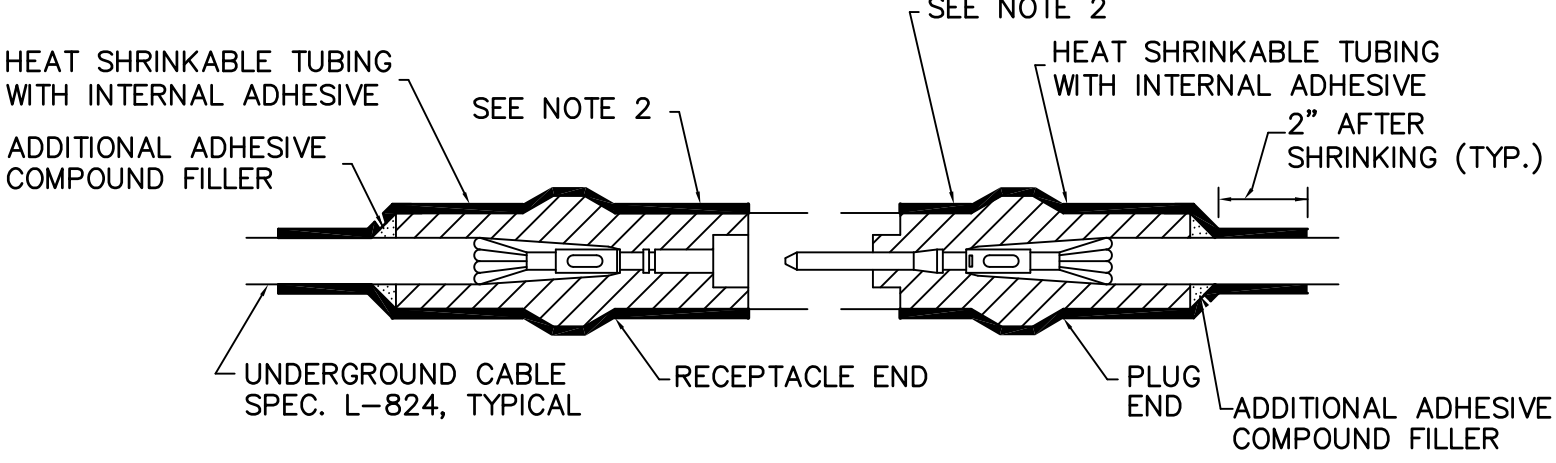
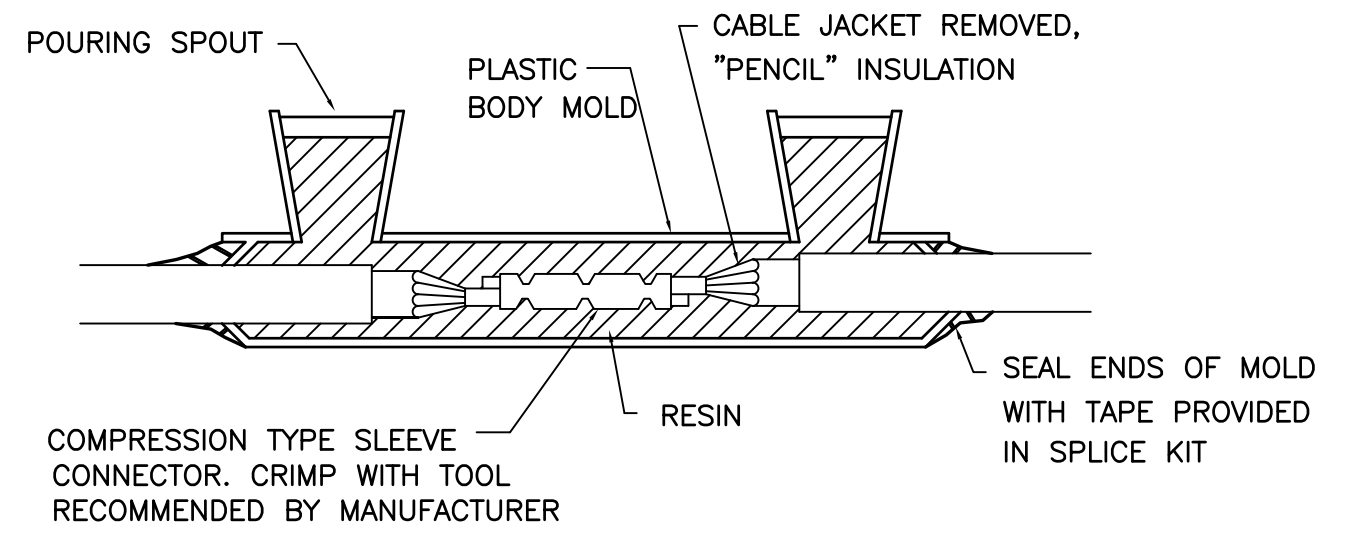

CABLE SPLICE NOTES

- INSIDE DIAMETER OF CONNECTOR SHALL PROPERLY MATCH THE OUTSIDE DIAMETER OF CABLE.
- WRAP WITH AT LEAST ONE LAYER OF RUBBER OR SYNTHETIC RUBBER TAPE AND ONE LAYER OF PLASTIC TAPE, ONE-HALF LAPPED, EXTENDING AT LEAST 1-1/2 INCHES ON EACH SIDE OF JOINT.
- THE COST OF FURNISHING AND INSTALLING ALL SPLICE MATERIALS SHALL BE INCIDENTAL TO THE ASSOCIATED CABLE ITEMS.
- THE CONTRACTOR SHALL HAVE A MINIMUM OF TWO (2) TYPE A SPLICE KITS ON THE JOB SITE AT ALL TIMES FOR EMERGENCY REPAIRS.

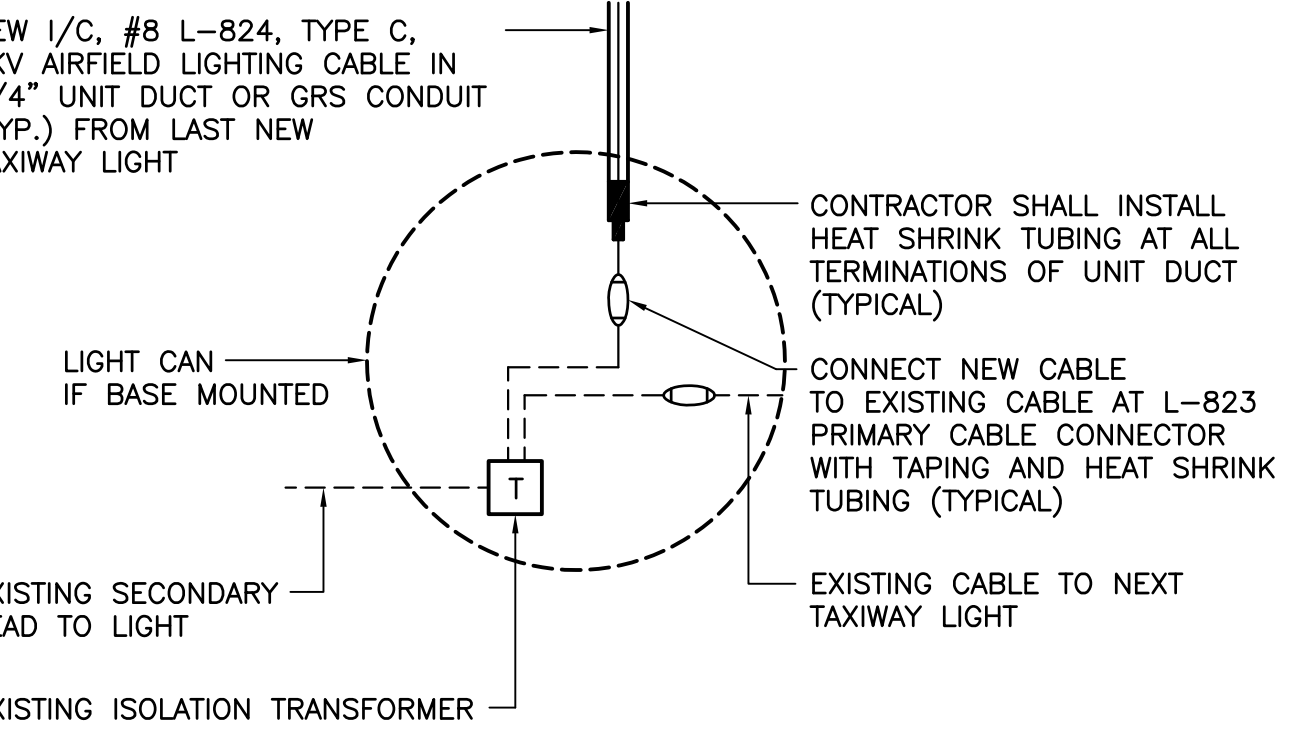

IL. CONTRACT: **AU066**
 IL. LETTING ITEM: **2A**
 IL. PROJECT: **ARR-4421**
 S.B.G. PROJECT: **3-17-SBGP-XX**

REVISIONS		
NUMBER	BY	DATE

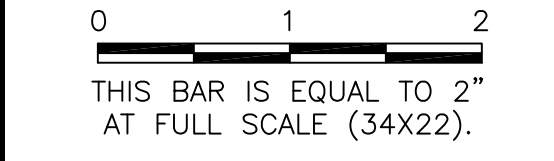

AURORA MUNICIPAL AIRPORT
AURORA, ILLINOIS
REHABILITATE AIRFIELD SIGNAGE
ELECTRICAL DETAILS - SHEET 1

© copyright CMT, Inc.

CMT
 CRAWFORD, MURPHY & TILLY, INC.
 CONSULTING ENGINEERS
 License No. 184-000613

CHICAGO
AURORA
 MUNICIPAL AIRPORT

DESIGN BY:	RD
DRAWN BY:	JRO
CHECKED BY:	DKP
APPROVED BY:	DKP
DATE:	06/05/15
JOB No:	14285-02

FINAL

SHEET 10 OF 13 SHEETS

XREF DWG: 1b_NCS_ARR.dwg
AAR-base.dwg

UPDATE BY: Ryan Drea
LAYOUT: Layout11

DATE: Thursday, June 11, 2015 5:00:30 PM
FILE: K:\Aurora\14285-02_RehabAirfieldSignage\Draw\Sheets\11_Elect\12.dwg

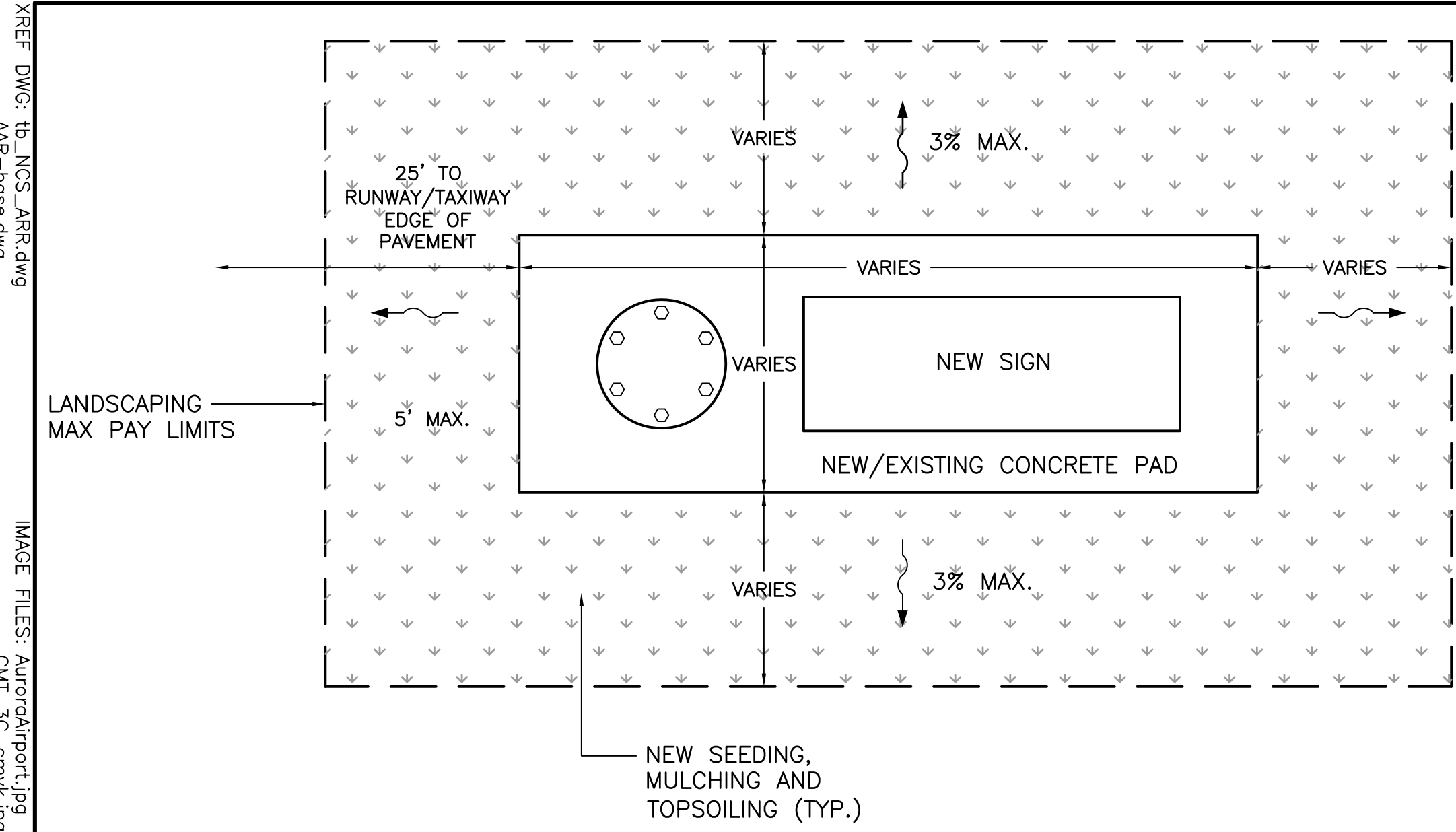

**TYPICAL LANDSCAPING FOR AR12544X / AR80013X
NEW SIGN / NEW SIGN ON EXISTING PAD**
NOT TO SCALE

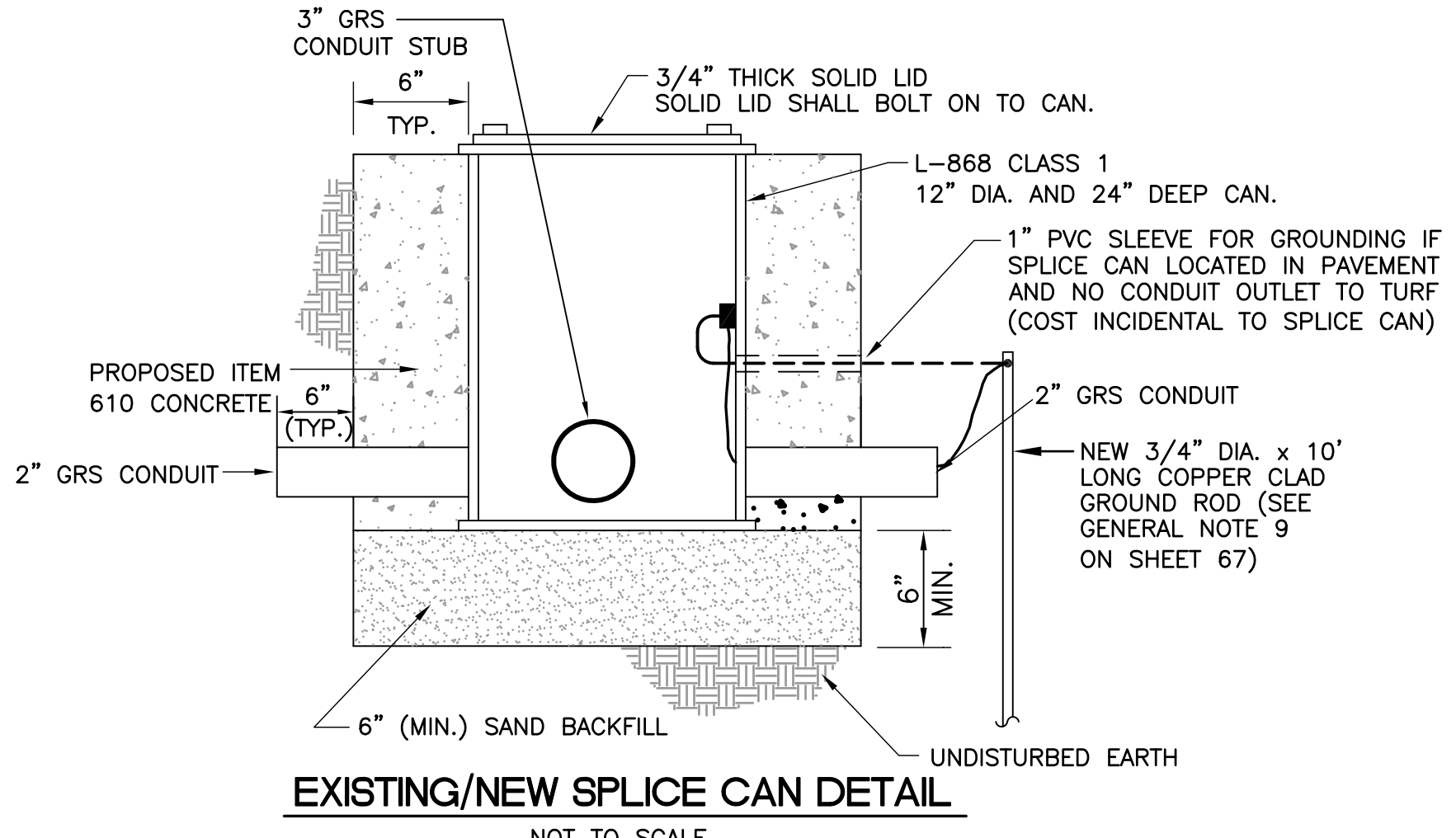

EXISTING/NEW SPLICE CAN DETAIL
NOT TO SCALE

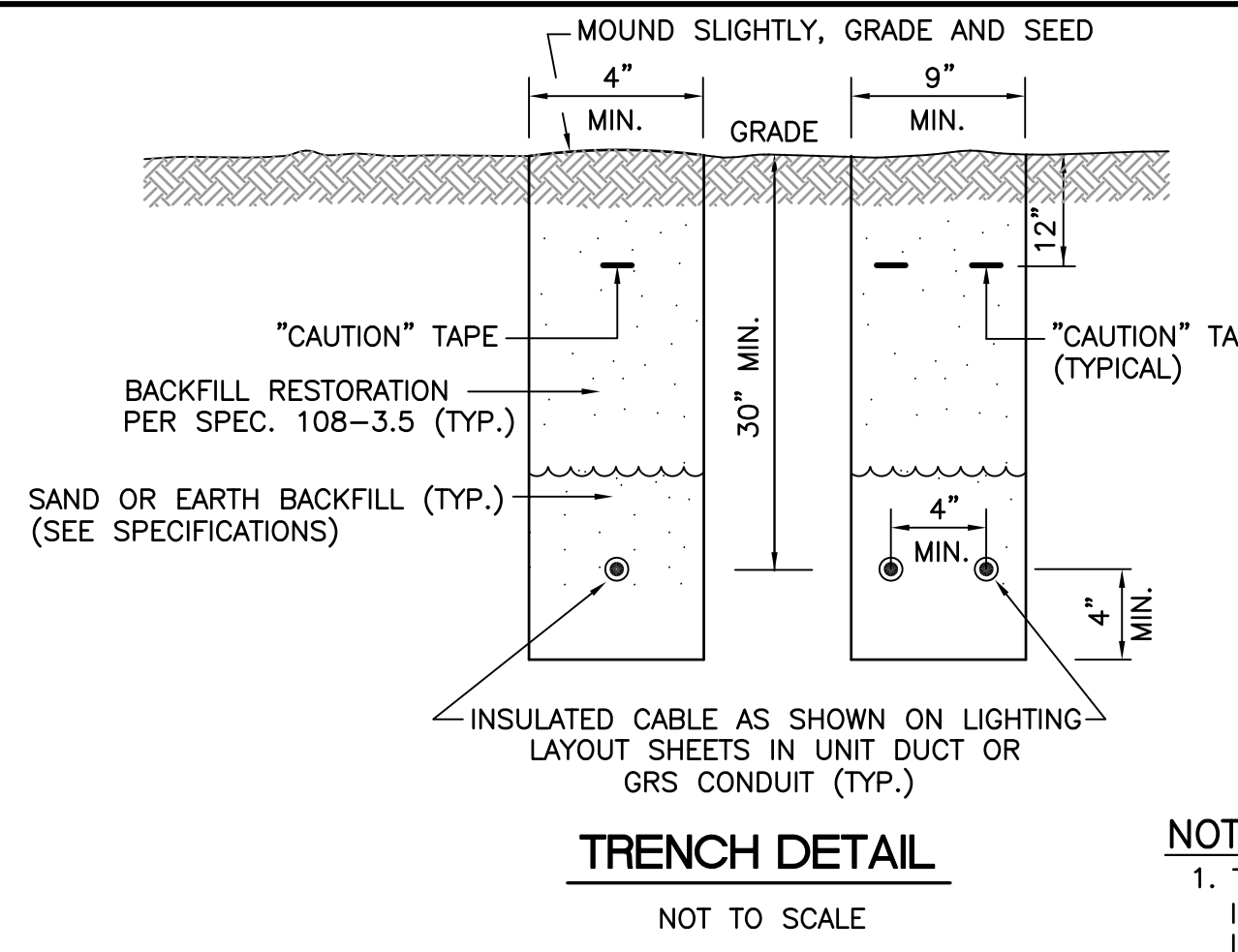

TRENCH DETAIL
NOT TO SCALE

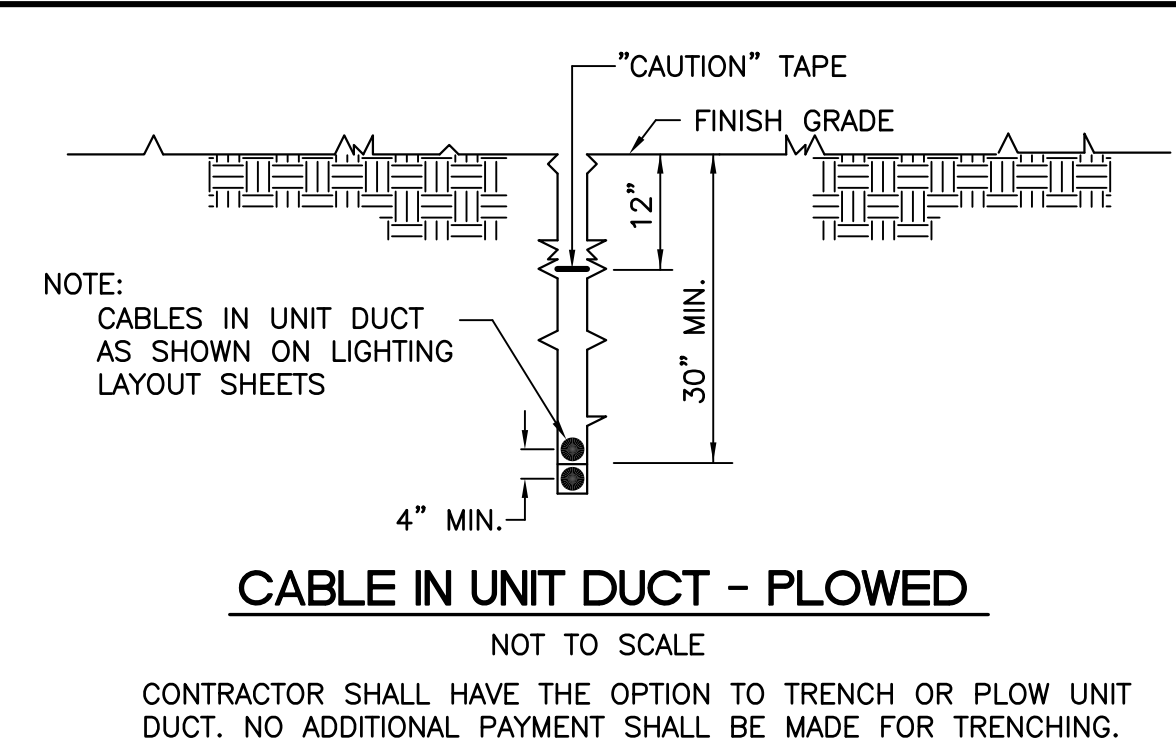

CABLE IN UNIT DUCT - PLOWED
NOT TO SCALE

- NOTES:**
- TRENCHES WITH MORE THAN 2 CABLES SHALL BE INCREASED 3" IN WIDTH FOR EACH ADDITIONAL CABLE. IF SPECIFIED ON PLANS, TWO PARALLEL TRENCHES MAY BE CONSTRUCTED.
 - DEPTH OF TRENCHES SHALL BE AS SHOWN UNLESS OTHERWISE SPECIFIED ON THE PLANS.
 - SAND BACKFILL SHALL BE USED IF THE EXISTING SOIL DOES NOT MEET THE BACKFILL REQUIREMENTS.
 - ALL DISTURBED SURFACES SHALL BE RESTORED TO THEIR ORIGINAL CONDITION. COST IS INCIDENTAL.

NOTE: AT CONTRACTOR'S OPTION, CABLE PLOWING MAY BE USED IN LIEU OF TRENCHING.

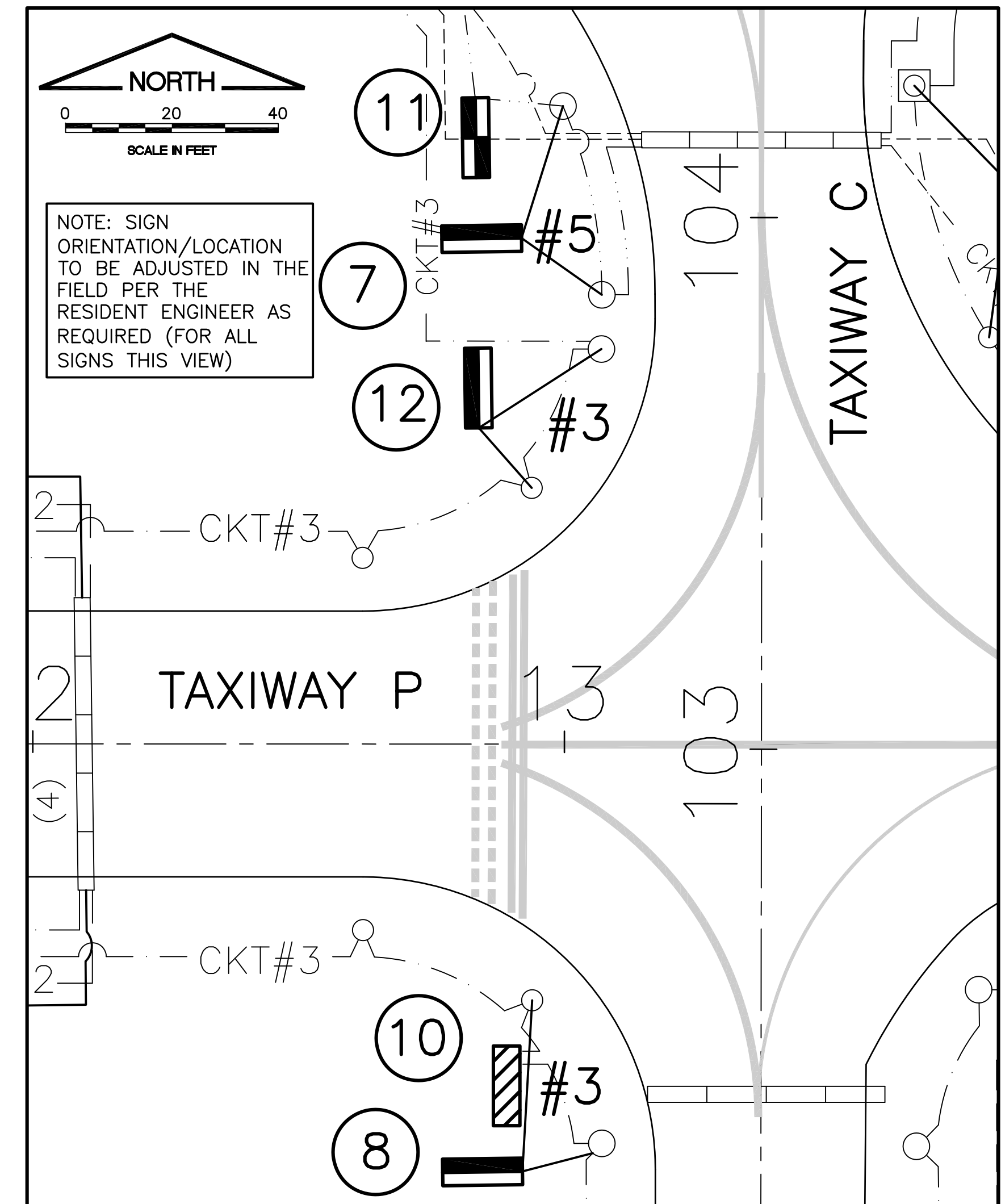

**DETAIL OF TAXIWAY P
AND TAXIWAY C INTERSECTION**
NOT TO SCALE

NOTE: SEE PROPOSED SIGNAGE PLAN SHEET 1 FOR LARGER VIEW

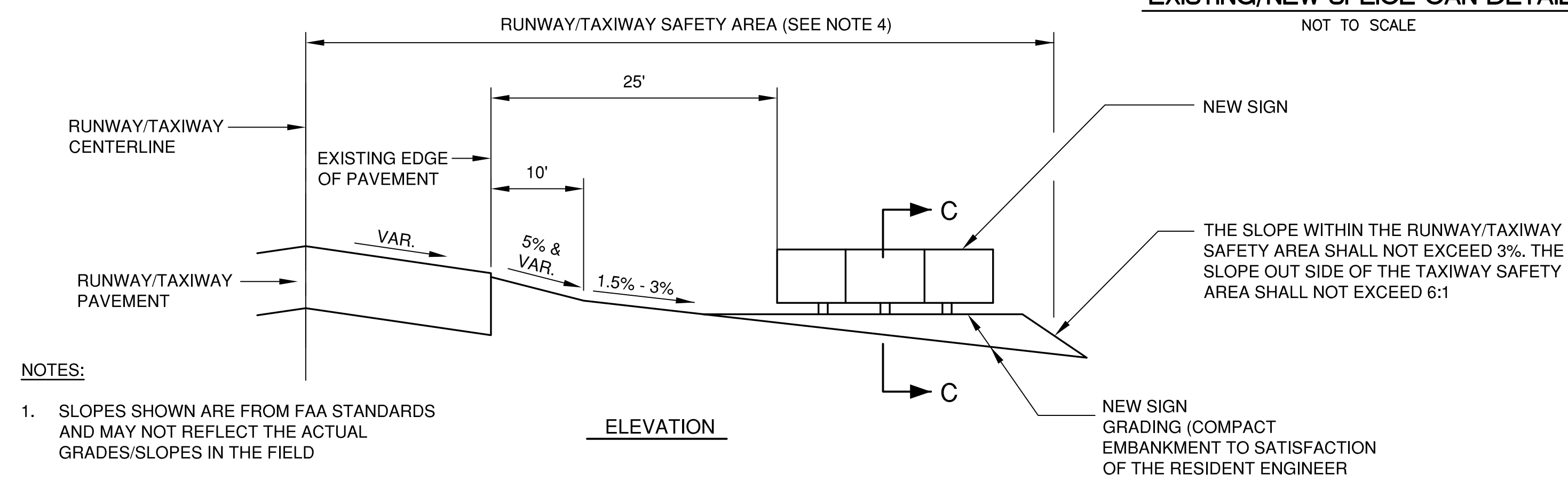

ELEVATION

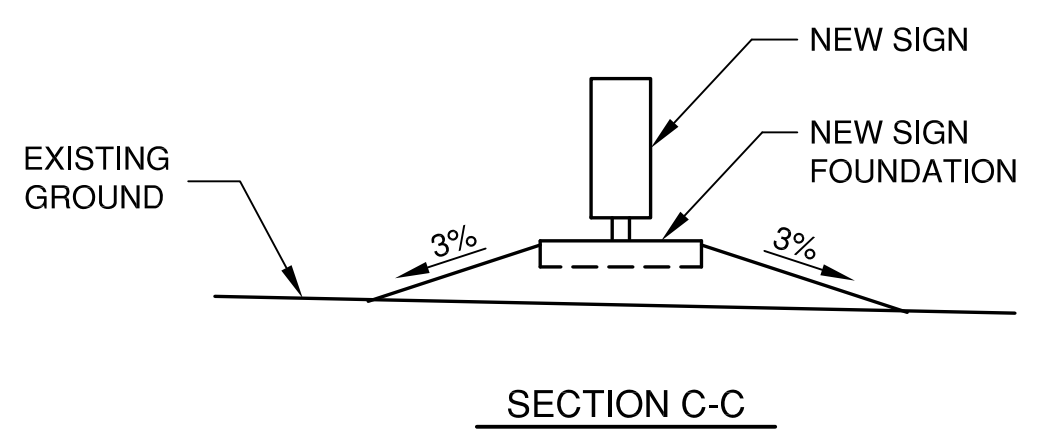

SECTION C-C

GRADING AIRFIELD SIGN DETAILS
N.T.S.

- NOTES:**
- SLOPES SHOWN ARE FROM FAA STANDARDS AND MAY NOT REFLECT THE ACTUAL GRADES/SLOPES IN THE FIELD
 - ESTIMATED 2 C.Y. OF EMBANKMENT MAY BE REQUIRED TO CONSTRUCT SIGN BASE FOUNDATION. ALL OFFSITE MATERIAL SHALL BE IN ACCORDANCE WITH ITEM 905-1.2 CLEAN CONSTRUCTION OR DEMOLITION DEBRIS FOR OFFSITE BORROW MATERIAL. COSTS TO CONSTRUCT SHALL BE INCIDENTAL TO SIGN PAY ITEM. ESTIMATED QUANTITY OF EMBANKMENT IS FOR INFORMATION ONLY. NO ADDITIONAL COST FOR ANY ADDITIONAL EMBANKMENT NEEDED.
 - ACTUAL LOCATION OF THE SIGN WITHIN THE TAXIWAY SAFETY AREA WILL VARY DUE TO PAVEMENT WIDTHS AND VARIANCES IN SIGN FOUNDATION LENGTHS.
 - DIMENSIONS:
RUNWAY 9/27 AND 15/33 = 250'
RUNWAY 18/36 = 75'
TAXIWAY C = 39.5'
ALL OTHER TAXIWAYS = 59'

IL. CONTRACT: **AU066**
IL. LETTING ITEM: **2A**
IL. PROJECT: **ARR-4421**
S.B.G. PROJECT: **3-17-SBGP-XX**

SURVEY BOOK # BOOK #

REVISIONS		
NUMBER	BY	DATE

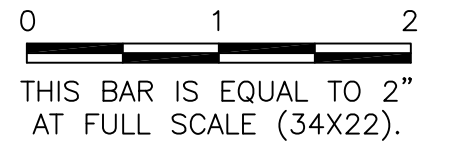

**AURORA MUNICIPAL AIRPORT
AURORA, ILLINOIS
REHABILITATE AIRFIELD SIGNAGE**

ELECTRICAL DETAILS - SHEET 2

© Copyright CMT, Inc.
CMT
CRAWFORD, MURPHY & TILLY, INC.
CONSULTING ENGINEERS
License No. 184-000613



DESIGN BY:	RD
DRAWN BY:	JRO
CHECKED BY:	DKP
APPROVED BY:	DKP
DATE:	06/05/15
JOB No:	14285-02

FINAL

DATE: Friday, June 12, 2015 11:33:16 AM
 FILE: K:\Aurora\14285-02_RenAirfieldSignage\Draw_Sheets\12_SignSchedule.dwg
 UPDATE BY: Jim Ohse
 LAYOUT: Layout3
 IMAGE FILES: Aurorairport.jpg
 CMT_30_cmyk.jpg
 XREF DWG: B:\NCS_ARR.dwg

AIRFIELD SIGNAGE SCHEDULE (BASE BID)										
SIGN IMPROVEMENT TYPE				SIGN NUMBER	NEW NUMBER OF CHARACTERS	SIGN SIDE	EXISTING SIGN LEGEND	NEW SIGN LEGEND	SIGN TYPE	SIGN LOCATION
MODIFY EXISTING SIGN PANEL AR125470	NEW SIGN ON NEW PAD AR12544X	REMOVE SIGN ONLY AR800149	NEW SIGN ON EXIST PAD AR80013X							
	✓			1	4	W E	N/A	[A] A5	0 2,3	STA. 350+44.98, 50' LT. Q TAXIWAY A
	✓			2	3	W E	N/A	[A] B	0 2,3	STA. 342+27.93, 50' LT. Q TAXIWAY A
	✓			3	3	N S	N/A	[B] V	2,3 0	STA. 644+17.05, 52' LT. Q TAXIWAY B
✓ (NORTH SIDE)				4	5	N S	[9-27] [B]	[9-27] [B]	2,0 1,2	AT EXISTING LOCATION
	✓			5	2	N S	N/A	[V] BLANK	3 0	STA. 546+87.09, 77' LT. Q RUNWAY 15/33
	✓			6	2	N S	N/A	[d] BLANK	3 0	STA. 203+84.18, 62.5' RT. Q RUNWAY 18/36
	✓			7	4	N S	N/A	[C] [A]	0 2,3	STA. 103+93.57, 45' LT. Q TAXIWAY C
	✓			8	4	N S	N/A	[XNY] [B] [P]	0 2,3	STA. 102+20.55, 45' LT. Q TAXIWAY C
	✓			9	3	N S	N/A	[C] [P]	3 0	STA. 200+90.48, 62.5' RT. Q RUNWAY 18/36
✓ (WEST SIDE)				10	6	W E	[d] [P] [36-18]	[XNY] [B] [d] [P] [36-18]	0,2 2,1	AT EXISTING LOCATION
		✓	✓	11	6	W E	[36-18] [A]	[XNY] [B] [A] [36-18]	0,2 2,1	AT EXISTING LOCATION
	✓			12	4	W E	N/A	[d] BLANK	3,2 0	STA. 12+83.88, 60' LT. Q TAXIWAY P
	✓			13	4	N S	N/A	[d] BLANK	3,2 0	STA. 104+6.38, 47' RT. Q TAXIWAY C
	✓			14	4	N S	N/A	[d] BLANK	3,2 0	STA. 106+39.24, 45' RT. Q TAXIWAY C
	✓			15	2	N S	N/A	[V] BLANK	3 0	STA. 206+39.34, 62.5' RT. Q RUNWAY 18/36
	✓			16	4	W E	N/A	[V] [d] BLANK	2,3 0	STA. 312+43.83, 57' RT. Q TAXIWAY A
	✓			17	6	N S	N/A	[9-27] [A3]	3,2 1,2	STA. 2+56.81, 50' LT. Q TAXIWAY A3
	✓			18	4	W E	N/A	[XNY] [B] [A] [A3]	0 2,3	STA. 310+57.94, 57' RT. Q TAXIWAY A
	✓			19	4	W E	N/A	[V] [Z] [A] BLANK	2,3 2,0	STA. 302+52.12, 52' RT. Q TAXIWAY A
	✓			20	6	N S	N/A	[9-27] [A2]	3,2 0	STA. 2+56.85, 50' LT. Q TAXIWAY A2
	✓			21	7	N S	N/A	[XNK] [A] [A2] [A]	0 3,3,3	STA. 300+78.43, 93' LT. Q TAXIWAY A
✓ (NORTH SIDE)				22	6	N S	[9-27] [A2]	[XNY] [B] [A2] [9-27]	0,2 2,1	AT EXISTING LOCATION
	✓			23	3	N S	N/A	[XNK] [A]	0 3	STA. 298+40.31, 103' LT. Q TAXIWAY A
	✓			24	4	W E	N/A	[V] [V] [B] BLANK	2,3 0	STA. 298+32.63, 52.5' RT. Q TAXIWAY A
✓ (EAST SIDE)				25	6	W E	N/A	[XNK] [B] [A1] [A1]	0 3,3	STA. 296+27.87, 94' LT. Q TAXIWAY A
	✓			26	4	W E	[S1] [B1]	[S1] [B1]	1,2 2,0	AT EXISTING LOCATION
	✓			27	4	W E	N/A	[XNK] [B] [B1]	0 3,2	STA. 2+90.33, 52.6' LT. Q TAXIWAY B1
✓ (EAST SIDE)				28	7	W E	[S1-S1] [B2]	[S1-S1] [B2]	1,2 2,0	AT EXISTING LOCATION
	✓			29	5	W E	N/A	[XNK] [B] [B2]	0 2,3	STA. 2+56.1, 67' LT. Q TAXIWAY B2
	✓			30	4	N S	N/A	[XNY] [B] [B] [B2]	0,2 2,3	STA. 612+99.18, 50' RT. Q TAXIWAY B
	✓			31	5	W E	N/A	[XNK] [B] [B4]	0 2,3	STA. 2+75.33, 51' LT. Q TAXIWAY B4
	✓			32	4	N S	N/A	[XNY] [B] [B] [B4]	0,2 2,3	STA. 628+75.29, 50' RT. Q TAXIWAY B
✓ (EAST SIDE)				33	7	W E	[S1-S1] [B4]	[S1-S1] [B4]	1,2 2,0	AT EXISTING LOCATION
	✓			34	2	W E	N/A	[d] BLANK	3 0	STA. 423+46.71, 73' LT. C RUNWAY 9/27
	✓			35	4	N S	N/A	[XNK] [B] [9-27]	0 1	AT EXISTING LOCATION
	✓			36	5	W E	[95-81] BLANK	[95-81] BLANK	1 0	AT EXISTING LOCATION
	✓			37	5	W E	[C] [36-18]	[XNK] [B] [36-18]	0 1	AT EXISTING LOCATION
	✓			38	3	N S	N/A	[XNK] [B] [C2]	0 3	STA. 231+8.10, 62.5' RT. Q RUNWAY 18/36
6	28	4	4	TOTAL						

NEW SIGN TYPE LEGEND

SIGN SIZE 2

- 0 — BLANK PANEL — BLACK
- 1 — RUNWAY/TAXIWAY HOLDLINE — WHITE LEGEND WITH BLACK TEXT BORDER ON RED BACKGROUND
- 2 — LOCATION SIGN — YELLOW LEGEND ON BLACK BACKGROUND WITH YELLOW BOX AROUND TEXT
- 3 — DIRECTION SIGN — BLACK LEGEND ON YELLOW BACKGROUND
- 4 — RUNWAY APPROACH AREA BOUNDARY SIGN — BLACK LEGEND ON YELLOW BACKGROUND

NEW AIRFIELD SIGNAGE SCHEDULE (ADDITIVE ALTERNATE NO. 1)										
SIGN IMPROVEMENT TYPE				SIGN NUMBER	NEW NUMBER OF CHARACTERS	SIGN FACE	EXISTING SIGN LEGEND	NEW SIGN LEGEND	SIGN TYPE	SIGN LOCATION
REMOVE SIGN AND PAD AR125904	NEW SIGN ON NEW PAD AR12544X	REMOVE SIGN ONLY AR800149	NEW SIGN ON EXIST PAD AR80013X							
		✓	✓	A1	6	N S	[9-27] [A3]	[9-27] [A3]	0,2 2,1	AT EXISTING LOCATION
		✓	✓	A2	5	W E	[BLANK]	[BLANK]	1 0	AT EXISTING LOCATION
		✓	✓	A3	4	N S	[6-Z2] [BLANK]	[6-Z2] [BLANK]	1 0	AT EXISTING LOCATION
		✓	✓	A4	6	W E	[95-81] [A]	[95-81] [A]	1,2 2,0	AT EXISTING LOCATION
		✓	✓	A5	5	N S	[XNY] [B] [C] [9-27]	[XNY] [B] [C] [9-27]	0,2 2,1	AT EXISTING LOCATION
0	0	5	5	TOTAL						

NEW AIRFIELD SIGNAGE SCHEDULE (ADDITIVE ALTERNATE NO. 2)										
SIGN IMPROVEMENT TYPE				SIGN NUMBER	NEW NUMBER OF CHARACTERS	SIGN FACE	EXISTING SIGN LEGEND	NEW SIGN LEGEND	SIGN TYPE	SIGN LOCATION
REMOVE SIGN AND PAD AR125904	NEW SIGN ON NEW PAD AR12544X	REMOVE SIGN ONLY AR800149	NEW SIGN ON EXIST PAD AR80013X							
	✓			A6	4	W E	N/A	[S] [C] [d]	2,3 0	STA. 100+86.57, 45' LT. Q TAXIWAY C
		✓	✓	A7	4	W E	[BLANK]	[XNK] [B] [S] [36]	0 2,1	AT EXISTING LOCATION
		✓	✓	A8	5	N S	[Z2-6] [C]	[Z2-6] [C]	1,2 2,0	AT EXISTING LOCATION
		✓	✓	A9	4	W E	[C] [18]	[C] [18]	0,2 2,1	AT EXISTING LOCATION
		✓	✓	A10	7	W E	[XNK] [B] [C] [36-18]	[XNK] [B] [C] [36-18]	0,2 2,1	AT EXISTING LOCATION
0	1	4	4	TOTAL						

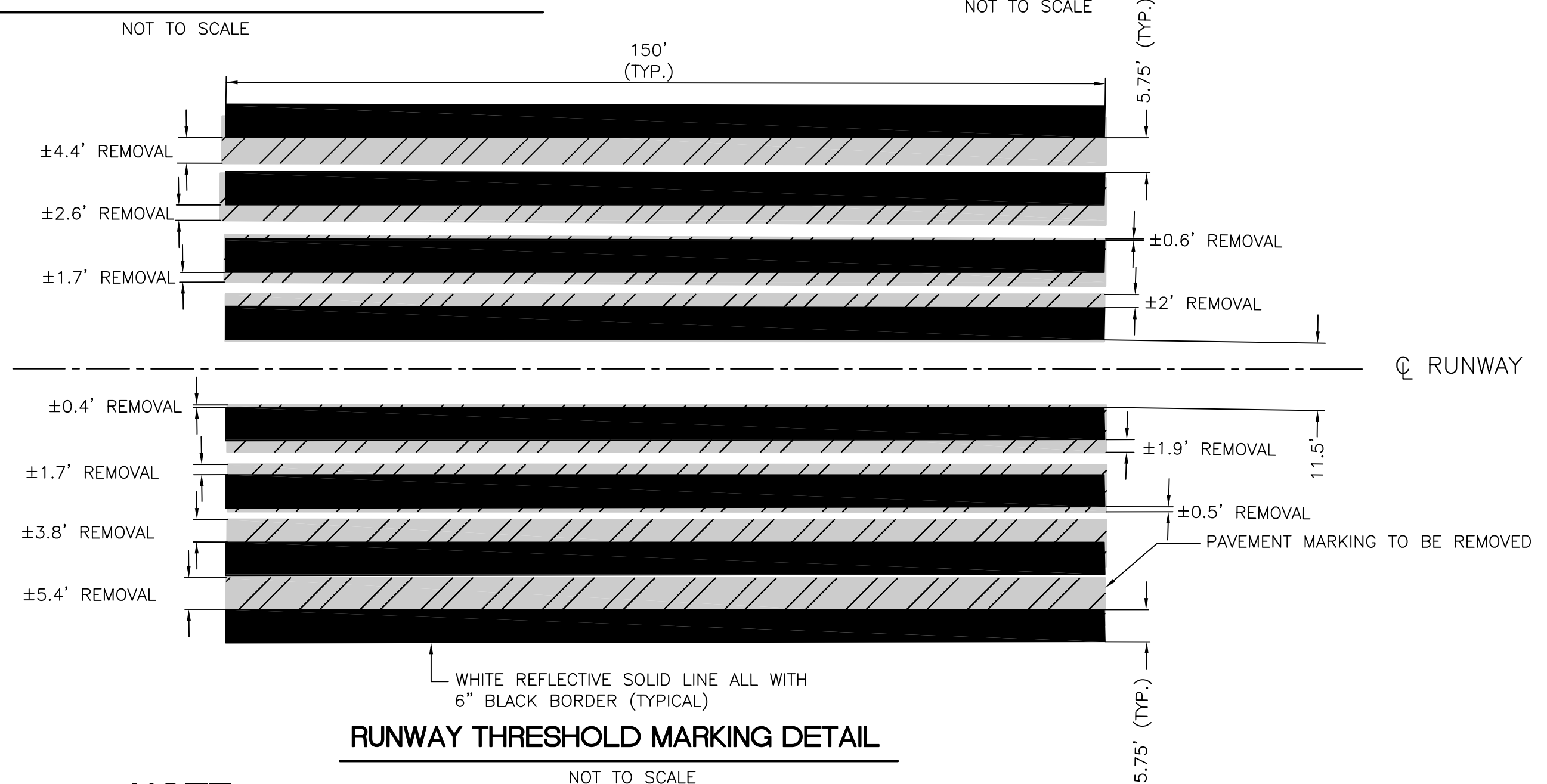
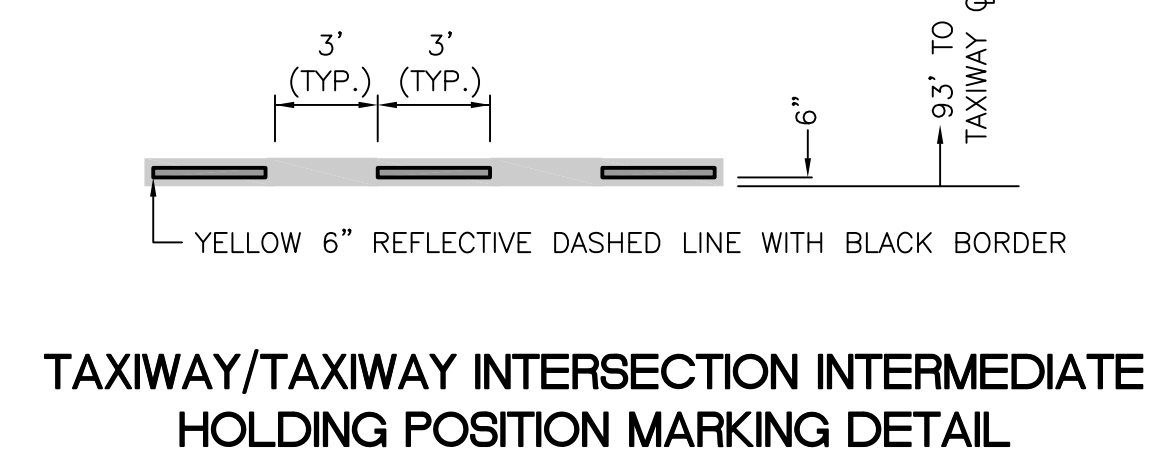
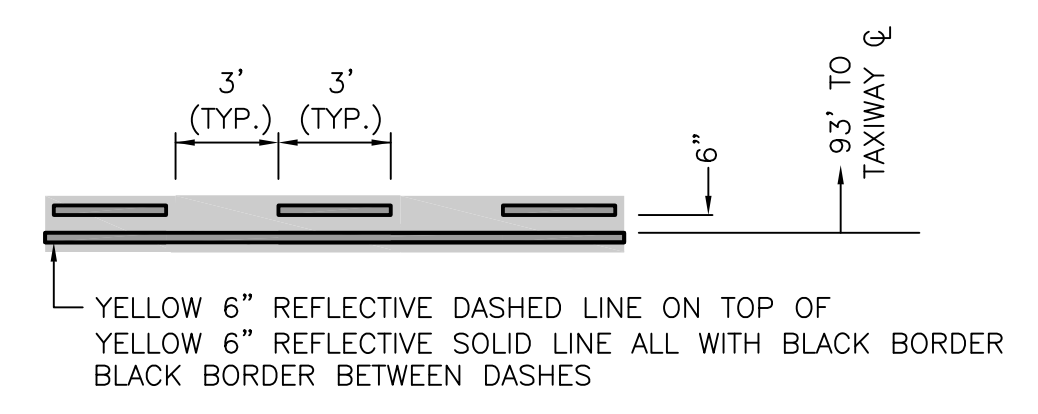

- NOTE:**
- ALL EXISTING BLACK BORDER TO BE REMOVED.
 - SURFACE PREPARATION FOR EXISTING WHITE PAVEMENT MARKING OVERLAPPING NEW WHITE PAVEMENT MARKING SHALL BE IN ACCORDANCE WITH SPECIFICATION ITEM 620 PAVEMENT MARKING (SECTION 620-3.3 SURFACE PREPARATION). CONTRACTOR SHALL CLEAN EXISTING MARKING SURFACE OF ANY DIRT AND LOOSE DEBRIS TO THE SATISFACTION OF THE RESIDENT ENGINEER.
 - PAVEMENT MARKING REMOVAL WIDTHS VARY AT EACH LOCATION.
 - RUNWAY MUST REMAIN CLOSED UNTIL THRESHOLD MARKING IS COMPLETELY REMOVED AND REPLACED.

IL. CONTRACT: **AU066**
 IL. LETTING ITEM: **2A**
 IL. PROJECT: **ARR-4421**
 S.B.G. PROJECT: **3-17-SBGP-XX**

REVISIONS

NUMBER	BY	DATE

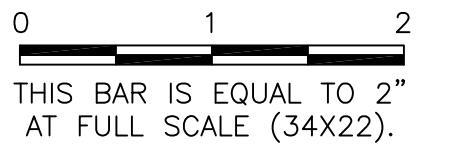

AURORA MUNICIPAL AIRPORT
AURORA, ILLINOIS
REHABILITATE AIRFIELD SIGNAGE
AIRFIELD SIGNAGE SCHEDULE
AND PAVEMENT MARKING DETAILS

© Copyright CMT, Inc.

CMT
 CRAWFORD, MURPHY & TILLY, INC.
 CONSULTING ENGINEERS
 License No. 184-00613

CHICAGO
AURORA
 MUNICIPAL AIRPORT

DESIGN BY:	RMD
DRAWN BY:	RMD
CHECKED BY:	DKP
APPROVED BY:	DKP
DATE:	06/05/15
JOB No:	14285-02

FINAL

SHEET 12 OF 13 SHEETS

STORM WATER POLLUTION PREVENTION NOTES

THE FOLLOWING IS TO ESTABLISHED BEST MANAGEMENT PRACTICES TO BE INCORPORATED IN THE PROJECT TO DIRECT THE CONTRACTOR IN THE PLACEMENT OF TEMPORARY EROSION CONTROL SYSTEMS AND TO PROVIDE A STORM WATER POLLUTION PREVENTION PLAN FOR COMPLIANCE WITH NPDES.

THE PURPOSE OF THIS PLAN IS TO MINIMIZE EROSION WITHIN THE CONSTRUCTION SITE AND TO LIMIT SEDIMENTS FROM LEAVING THE SITE BY UTILIZING PROPER TEMPORARY EROSION CONTROL SYSTEMS AND PROVIDING GROUND COVER WITHIN A REASONABLE AMOUNT OF TIME.

CERTAIN EROSION CONTROL FACILITIES SHALL BE INSTALLED BY THE CONTRACTOR AT THE BEGINNING OF CONSTRUCTION. OTHER ITEMS SHALL BE INSTALLED BY THE CONTRACTOR AS DIRECTED BY THE ENGINEER ON A CASE BY CASE SITUATION DEPENDING ON THE CONTRACTOR'S SEQUENCE OF ACTIVITIES, TIME OF YEAR, AND EXPECTED WEATHER CONDITIONS.

THE CONTRACTOR SHALL INSTALL PERMANENT EROSION CONTROL SYSTEMS AND SEEDING WITHIN A TIMEFRAME SPECIFIED HEREIN AND AS DIRECTED BY THE ENGINEER, THEREFORE MINIMIZING THE AMOUNT OF AREA SUSCEPTIBLE TO EROSION AND REDUCING THE AMOUNT OF TEMPORARY SEEDING, WHICH WILL BE THE CONTRACTOR'S COST. THE ENGINEER WILL DETERMINE IF ANY TEMPORARY EROSION CONTROL SYSTEMS SHOWN IN THE PLAN CAN BE DELETED AND IF ANY ADDITIONAL TEMPORARY EROSION CONTROL SYSTEMS, WHICH ARE NOT INCLUDED IN THIS PLAN, SHALL BE ADDED. THE CONTRACTOR SHALL PERFORM ALL WORK AS DIRECTED BY THE ENGINEER AND AS SHOWN ON THE PLANS.

SITE DESCRIPTION

THE FOLLOWING IS A DESCRIPTION OF THE CONSTRUCTION ACTIVITY WHICH IS THE SUBJECT OF THIS PLAN:

THIS PROJECT CONSISTS OF CONSTRUCTING A NEW AND REPLACEMENT GUIDANCE SIGNS AT AURORA MUNICIPAL AIRPORT.

THE FOLLOWING IS A DESCRIPTION OF THE INTENDED SEQUENCE OF MAJOR ACTIVITIES WHICH WILL DISTURB SOILS FOR MAJOR PORTIONS OF THE CONSTRUCTION SITE, SUCH AS EXCAVATION AND GRADING:

1. INSTALL CONCRETE WASHOUT AT CONTRACTOR STAGING AREA.
2. EXCAVATE NEW SIGN FOUNDATIONS.
3. INSTALL THE NEW SIGNS.
4. CABLE INSTALLATION.
5. FINAL GRADING AND OTHER MISCELLANEOUS ITEMS.
6. PLACEMENT OF PERMANENT EROSION CONTROL, SUCH AS SEEDING AND MULCH.

AREA OF CONSTRUCTION SITE

THE TOTAL AREA OF THE CONSTRUCTION SITE THAT WILL BE DISTURBED BY EXCAVATION, GRADING AND OTHER ACTIVITIES IS LESS THAN ONE (1) ACRE.

DRAINAGE TRIBUTARIES AND SENSITIVE AREAS RECEIVING RUNOFF FROM THIS CONSTRUCTION SITE:

THE CONSTRUCTION SITE DRAINS INTO STORM SEWERS THAT OUTLET INTO THE WELCH CREEK.

SEDIMENTATION AND EROSION CONTROL NOTES

THE RESIDENT ENGINEER WILL PERFORM PERIODIC INSPECTION OF THE SITE TO IDENTIFY POTENTIAL SEDIMENT AND EROSION ISSUES.

ALL SOIL EROSION AND SEDIMENT CONTROL PRACTICES ARE REFERENCED FROM THE ILLINOIS URBAN MANUAL, UNLESS OTHERWISE STATED.

THE DRAWINGS, SPECIFICATIONS AND SPECIAL PROVISIONS WILL ENSURE THAT EXISTING VEGETATION IS PRESERVED WHERE ATTAINABLE AND DISTURBED PORTIONS OF THE SITE WILL BE STABILIZED. STABILIZATION PRACTICES INCLUDE SEEDING AND MULCHING AS DIRECTED BY THE ENGINEER. STABILIZATION MEASURES SHALL BE INITIATED WITHIN SEVEN (7) DAYS OF DISTURBANCE.

DESCRIPTION OF STABILIZATION PRACTICES DURING CONSTRUCTION:

DURING CONSTRUCTION, AREAS OUTSIDE THE CONSTRUCTION LIMITS AS OUTLINED PREVIOUSLY HEREIN SHALL BE PROTECTED. THE CONTRACTOR SHALL NOT USE THIS AREA FOR STAGING (EXCEPT AS DESCRIBED ON THE PLANS AND DIRECTED BY THE ENGINEER), PARKING OF VEHICLES OR CONSTRUCTION EQUIPMENT, STORAGE OF MATERIALS, OR OTHER CONSTRUCTION RELATED ACTIVITIES.

WITHIN THE CONSTRUCTION LIMITS, AREAS WHICH MAY BE SUSCEPTIBLE TO EROSION AS DETERMINED BY THE ENGINEER SHALL REMAIN UNDISTURBED UNTIL FULL SCALE CONSTRUCTION IS UNDERWAY TO PREVENT UNNECESSARY SOIL EROSION.

EARTH STOCKPILES SHALL BE TEMPORARILY SEEDED, AT THE CONTRACTORS EXPENSE, IF THEY ARE TO REMAIN UNUSED FOR MORE THAN FOURTEEN DAYS.

AS CONSTRUCTION PROCEEDS, THE CONTRACTOR SHALL INSTITUTE THE FOLLOWING AS DIRECTED BY THE ENGINEER:

PLACE TEMPORARY EROSION CONTROL FACILITIES AT LOCATIONS SHOWN ON THE PLANS. A.

EXCAVATED AREAS AND EMBANKMENT AREAS SHALL BE PERMANENTLY SEEDED IMMEDIATELY AFTER FINAL GRADING. IF NOT, THEY SHALL BE TEMPORARILY SEEDED, AT THE CONTRACTOR'S COST, IF NO CONSTRUCTION ACTIVITY IN THE AREA IS PLANNED FOR SEVEN DAYS.

CONSTRUCTION EQUIPMENT SHALL BE STORED AND FUELED ONLY AT DESIGNATED LOCATIONS. ALL NECESSARY MEASURES SHALL BE TAKEN TO CONTAIN ANY FUEL OR POLLUTANT IN ACCORDANCE WITH EPA WATER QUALITY REGULATIONS. LEAKING EQUIPMENT OR SUPPLIES SHALL BE IMMEDIATELY REPAIRED OR REMOVED FROM THE SITE.

5. SEDIMENT COLLECTED DURING CONSTRUCTION OF THE VARIOUS TEMPORARY EROSION CONTROL SYSTEMS SHALL BE DISPOSED OF OFF SITE ON A REGULAR BASIS AS DIRECTED BY THE ENGINEER. THE COST OF THIS MAINTENANCE SHALL BE INCIDENTAL TO THE COST OF THE PROJECT.
6. THE TEMPORARY EROSION CONTROL SYSTEMS SHALL BE REMOVED AS DIRECTED BY THE ENGINEER AFTER USE IS NO LONGER NEEDED OR NO LONGER FUNCTIONING. THE COST OF THIS REMOVAL SHALL BE INCIDENTAL TO THE CONTRACT.

DESCRIPTION OF STRUCTURAL PRACTICES AFTER FINAL GRADING:

TEMPORARY EROSION CONTROL SYSTEMS SHALL BE LEFT IN PLACE WITH PROPER MAINTENANCE UNTIL PERMANENT EROSION CONTROL IS IN PLACE AND WORKING PROPERLY AND ALL PROPOSED TURF AREAS ARE SEEDED AND ESTABLISHED.

ONCE PERMANENT EROSION CONTROL SYSTEMS AS PROPOSED IN THE PLANS ARE FUNCTIONAL AND ESTABLISHED, TEMPORARY ITEMS SHALL BE REMOVED, CLEANED UP, AND DISTURBED TURF RESEEDED.

MAINTENANCE AFTER CONSTRUCTION

CONSTRUCTION IS COMPLETE AFTER FINAL ACCEPTANCE BY THE ILLINOIS DIVISION OF AERONAUTICS. MAINTENANCE UP TO THIS DATE WILL BE REQUIRED BY THE CONTRACTOR.

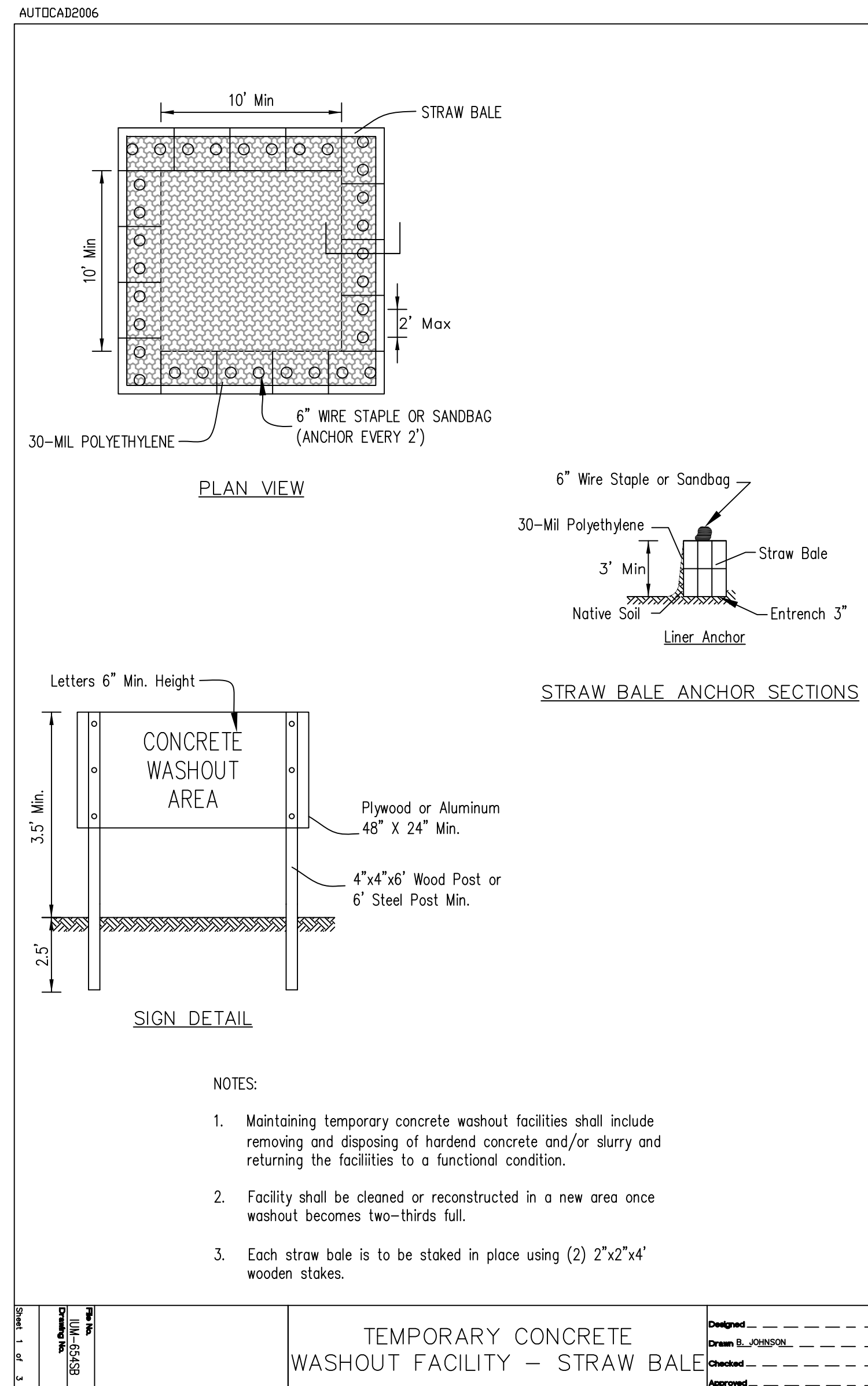

- NOTES:
1. Maintaining temporary concrete washout facilities shall include removing and disposing of hardened concrete and/or slurry and returning the facilities to a functional condition.
 2. Facility shall be cleaned or reconstructed in a new area once washout becomes two-thirds full.
 3. Each straw bale is to be staked in place using (2) 2"x2"x4' wooden stakes.

TEMPORARY CONCRETE WASHOUT FACILITY - STRAW BALE		Date
Designed	_____	_____
Drawn	_____	_____
Checked	_____	_____
Approved	_____	_____

IL. CONTRACT: **AU066**
 IL. LETTING ITEM: **2A**
 IL. PROJECT: **ARR-4421**
 S.B.G. PROJECT: **3-17-SBGP-XX**

SURVEY BOOK # BOOK #

REVISIONS		
NUMBER	BY	DATE

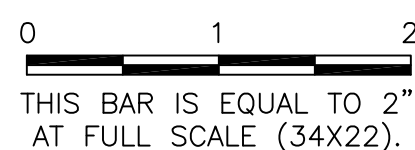

**AURORA MUNICIPAL AIRPORT
 AURORA, ILLINOIS
 REHABILITATE AIRFIELD SIGNAGE**

**STORMWATER POLLUTION PREVENTION
 NOTES AND DETAILS**

© Copyright CMT, Inc.

CMT
 CRAWFORD, MURPHY & TILLY, INC.
 CONSULTING ENGINEERS
 License No. 184-000613

CHICAGO
AURORA
 MUNICIPAL AIRPORT

DESIGN BY:	ARM
DRAWN BY:	JRO
CHECKED BY:	DKP
APPROVED BY:	DKP
DATE:	06/05/15
JOB No:	14285-02

FINAL

XREF DWG: I:\NCS\ARR.dwg
 IMAGE FILES: AuroraA1port.jpg
 CM1_3C_cmyk.jpg
 UPDATE BY: Ryan Drea
 LAYOUT: Layout1
 DATE: Thursday, June 11, 2015 5:01:07 PM
 FILE: K:\AuroraA1\14285-02_RehabAirfieldSignage\Draw\Sheets\SWPPP_Notes_And_Details.dwg