

\*REF-  
\*REF-  
\*REF-

PANEL SIGN DESIGN TYPE 1

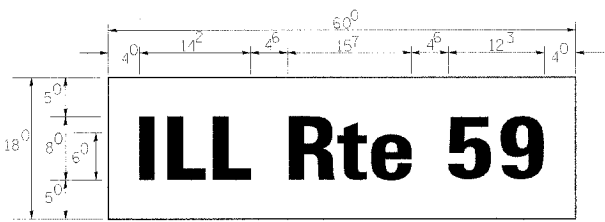

**ILL Rte 59**

\_\_\_ Sq. M. each  
7.5 Sq. Ft. each  
10 Required  
Design Series D

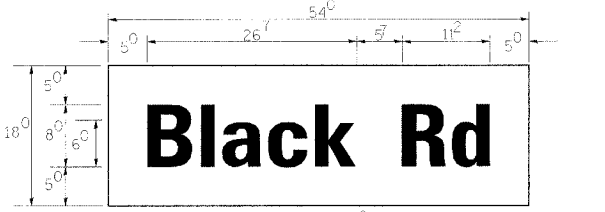

**Black Rd**

\_\_\_ Sq. M. each  
6.75 Sq. Ft. each  
2 Required  
Design Series D



**Vertin Blvd**

\_\_\_ Sq. M. each  
7.50 Sq. Ft. each  
2 Required  
Design Series D

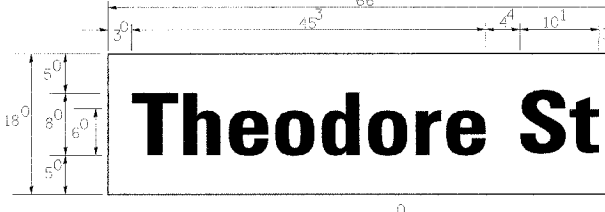

**Theodore St**

\_\_\_ Sq. M. each  
8.25 Sq. Ft. each  
2 Required  
Design Series D

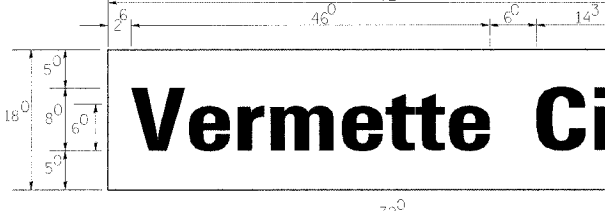

**Vermette Cir**

\_\_\_ Sq. M. each  
9 Sq. Ft. each  
2 Required  
Design Series D

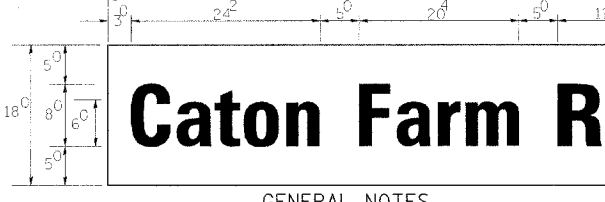

**Caton Farm Rd**

\_\_\_ Sq. M. each  
9 Sq. Ft. each  
2 Required  
Design Series C

GENERAL NOTES

- WHERE MAST ARM MOUNTED STREET NAME SIGNS ARE SPECIFIED, THE MAST ARM ASSEMBLY AND POLES SHALL BE DESIGNED TO SUPPORT THE LOADINGS CALLED FOR ON STANDARDS 834001, 834006 AND 834011, AS APPLICABLE, PLUS TWO (2) SIGN PANELS 2'-6" x 6'-0" MOUNTED AS SHOWN. THE DESIGN SHALL BE IN ACCORDANCE WITH THE REQUIREMENTS OF THE CURRENT "STANDARD SPECIFICATIONS FOR STRUCTURAL SUPPORTS FOR HIGHWAY SIGNS, LUMINAIRES, AND TRAFFIC SIGNALS" AS PUBLISHED BY THE AMERICAN ASSOCIATION OF STATE HIGHWAY AND TRANSPORTATION OFFICIALS FOR 80 M.P.H. WIND VELOCITY.
  - ALL SIGNS SHALL HAVE A WHITE REFLECTORIZED LEGEND AND BORDER ON A GREEN REFLECTORIZED BACKGROUND, TYPE A SHEETING.
  - THE SIGN LENGTH SHOULD BE INCREASED IN 6-INCH INCREMENTS, BUT THE OVERALL LENGTH SHOULD NOT EXCEED 6'-0".
  - ALL BORDERS SHALL BE 3/4" WIDE AND CORNER RADIUS SHALL BE 2-1/4".
  - SIGNFIX ALUMINUM CHANNEL FRAMING SYSTEM SHALL BE USED FOR ALL SIGNS ATTACHED TO SIGNAL POLES AND POSTS. LOCAL SUPPLIERS OF THE SIGNFIX ALUMINUM CHANNEL FRAMING SYSTEM ARE:
    - \* A.K.T. CORPORATION, SCHAMBURG, IL
    - \* AMERICAN FABRICATION CO., CHICAGO HEIGHTS, IL
    - \* TUCKER COMPANY, INC., WAUWATOSA, WI
    - \* WESTERN TRAFFIC CONTROL INC., CICERO, IL
- PARTS LISTING:  
SIGN CHANNEL: PART #HPN053 (MED. CHANNEL)  
SIGN SCREWS: 1/4" x 14 x 1" H.W.H. #3  
BRACKETS: PART #HPN034 (UNIVERSAL)  
CHANNEL CLAMPS WITH STAINLESS STEEL STRAPPING  
OTHER BRANDS OF MOUNTING HARDWARE ARE ACCEPTABLE, BASED UPON THE DEPARTMENT'S APPROVAL AND COMPATIBILITY WITH THE CHANNEL/BACKET OF THE ABOVE PRODUCT.

SUPPORTING CHANNELS

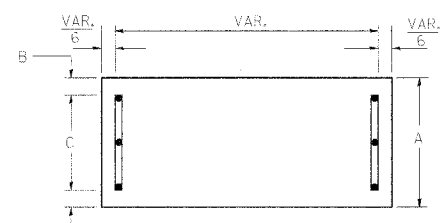

A	B	C
18"	2"	14"

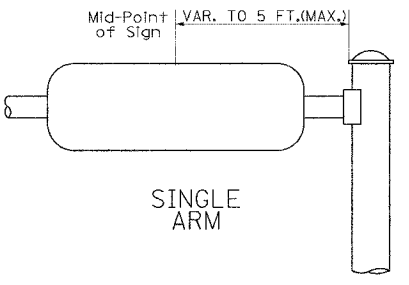

SUPPORTING CHANNELS

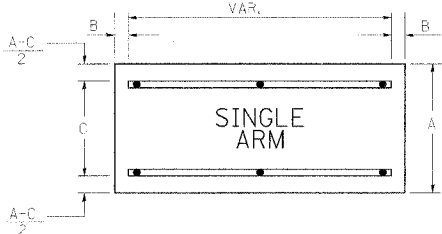

A	B	C
18"	2"	12"
30"	2"	22"

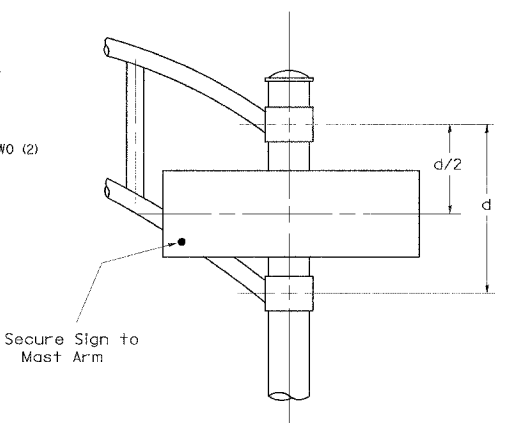

SIGNFIX ALUMINUM CHANNEL FRAMING SYSTEM Shall be used. See Note #5.

NOTE: SIGN DIMENSIONS ARE IN ENGLISH UNITS

Upper Case To Lower Case  
Spacing Chart 8-6 Inch Series "C & D"

EXAMPLE, 2<sup>3</sup> DENOTES 3 3/8

FIRST LETTER	SECOND LETTER															
	acde		bhikl		f w		j		s t		v y		x		z	
	C	D	C	D	C	D	C	D	C	D	C	D	C	D	C	D
A W X	12	14	14	15	12	14	06	10	11	14	06	10	11	12	12	14
B	14	15	20	21	14	15	11	12	14	15	12	14	12	14	16	17
C E G	14	15	20	21	12	14	06	10	12	14	12	14	14	15	14	15
D O Q R	14	15	20	21	14	15	06	10	12	14	12	14	14	15	14	15
F	05	06	14	15	06	10	05	06	06	10	06	10	06	10	11	12
H I M N	20	21	22	24	20	21	14	15	16	17	16	17	20	21	20	21
J U	20	21	20	21	16	17	14	15	16	17	16	17	16	17	20	21
K L	11	12	16	17	11	12	05	06	11	12	11	12	11	12	12	14
P	12	14	14	15	12	14	05	06	11	12	11	12	12	14	12	14
S	12	14	16	17	12	14	06	10	12	14	12	14	12	14	12	14
T	11	12	16	17	06	10	06	10	11	12	11	12	11	12	12	14
V	06	10	14	15	11	12	06	10	12	14	12	14	12	14	12	14
Y	05	06	14	15	06	10	05	06	05	07	05	06	06	10	11	12
Z	16	17	22	24	16	17	12	14	16	17	16	17	16	17	20	21

Lower Case To Lower Case  
Spacing Chart 6 Inch Series "C & D"

FIRST LETTER	SECOND LETTER															
	acde		bhikl		f w		j		s t		v y		x		z	
	C	D	C	D	C	D	C	D	C	D	C	D	C	D	C	D
ad h g l j	16	17	22	24	16	17	12	14	14	15	14	15	16	17	16	17
l m n q u	16	17	22	24	16	17	12	14	14	15	14	15	16	17	16	17
b f k o p s	12	14	16	17	11	12	05	06	11	12	11	12	12	14	12	14
c e	12	14	16	17	12	14	06	10	12	14	12	14	12	14	12	14
r	06	10	12	14	06	10	03	03	05	06	05	06	06	10	06	10
t z	12	14	16	17	12	14	06	10	11	12	11	12	12	14	12	14
v y	11	12	14	15	11	12	05	06	06	10	06	10	11	12	11	12
w	11	12	14	15	11	12	05	06	11	12	11	12	11	12	12	14
x	12	14	16	17	11	12	05	06	11	12	11	12	11	12	12	14

Number To Number  
Spacing Chart 8 Inch Series "C & D"

FIRST LETTER	SECOND NUMBER																			
	0		1		2		3		4		5		6		7		8		9	
	C	D	C	D	C	D	C	D	C	D	C	D	C	D	C	D	C	D	C	D
0 9	16	17	16	17	14	15	12	14	14	15	14	15	16	17	12	14	16	17	16	17
1	20	21	20	21	20	21	16	17	14	15	20	21	20	21	14	15	20	21	20	21
2 3 4	14	15	14	15	14	15	12	14	14	15	14	15	14	15	11	12	14	15	14	15
5	14	15	14	15	14	15	11	12	14	15	14	15	11	12	14	15	14	15	14	15
6	16	17	14	15	14	15	12	14	14	15	14	15	11	12	14	15	14	15	14	15
7	12	14	12	14	14	15	12	14	14	15	14	15	11	12	14	15	12	14	14	15
8	16	17	16	17	14	15	12	14	14	15	16	17	12	14	16	17	14	15	14	15

UPPER AND LOWER CASE LETTER WIDTHS

LETTERS	6 INCH UPPER CASE LETTERS				8 INCH UPPER CASE LETTERS				LETTERS	6 INCH LOWER CASE LETTERS	
	SERIES		SERIES		SERIES		SERIES			SERIES	
	C	D	C	D	C	D	C	D		C	D
A	36	50	50	65	a	35	42				
B	32	40	43	53	b	35	42				
C	32	40	43	53	c	35	41				
D	32	40	43	53	d	35	42				
E	30	35	40	47	e	35	42				
F	30	35	40	47	f	23	26				
G	32	40	43	53	g	35	42				
H	32	40	43	53	h	35	42				
I	07	07	11	12	i	11	11				
J	30	36	40	50	j	20	22				
K	32	41	43	54	k	35	42				
L	30	35	40	47	l	11	11				
M	37	45	51	61	m	60	70				
N	32	40	43	53	n	35	42				
O	34	42	45	55	o	36	43				
P	32	40	43	53	p	35	42				
Q	34	42	45	55	q	35	42				
R	32	40	43	53	r	26	32				
S	32	40	43	53	s	36	42				
T	30	35	40	47	t	27	32				
U	32	40	43	53	u	35	42				
V	35	44	47	60	v	42	47				
W	44	52	60	70	w	55	64				
X	34	40	45	53	x	44	51				
Y	36	50	50	66	y	46	53				
Z	32	40	43	53	z	36	43				

NUMBER	6 INCH SERIES		8 INCH SERIES	
	C	D	C	D
1	12	14	15	20
2	32	40	43	53
3	32	40	43	53
4	35	43	47	57
5	32	40	43	53
6	32	40	43	53
7	32	40	43	53
8	32	40	43	53
9	32	40	43	53
0	34	42	45	55

REVISIONS	
NAME	DATE
D.A.Z./D.A.G.	11/90
	6/98
CADD	10/00

Illinois Department of Transportation  
DISTRICT 1

MAST ARM MOUNTED STREET NAME SIGNS

SCALE: NONE  
DATE: 3/18/08

DRAWN BY: RBB  
DESIGNED BY: JHE  
CHECKED BY: DAD