

If you plan to submit a bid directly to the Department of Transportation

PREQUALIFICATION

Any contractor who desires to become pre-qualified to bid on work advertised by IDOT must submit the properly completed pre-qualification forms to the Bureau of Construction no later than 4:30 p.m. prevailing time twenty-one days prior to the letting of interest. This pre-qualification requirement applies to first time contractors, contractors renewing expired ratings, contractors maintaining continuous pre-qualification or contractors requesting revised ratings. To be eligible to bid, existing pre-qualification ratings must be effective through the date of letting.

REQUESTS FOR AUTHORIZATION TO BID

Contractors wanting to bid on items included in a particular letting must submit the properly completed "Request for Authorization to Bid/or Not For Bid Status" (BDE 124INT) and the ORIGINAL "Affidavit of Availability" (BC 57) to the proper office no later than 4:30 p.m. prevailing time, three (3) days prior to the letting date.

WHO CAN BID ?

Bids will be accepted from only those companies that request and receive written **Authorization to Bid** from IDOT's Central Bureau of Construction.

WHAT CONSTITUTES WRITTEN AUTHORIZATION TO BID?: When a prospective prime bidder submits a "Request for Authorization to Bid/or Not For Bid Status"(BDE 124INT) he/she must indicate at that time which items are being requested For Bidding purposes. Only those items requested For Bidding will be analyzed. After the request has been analyzed, the bidder will be issued a **Proposal Denial and/or Authorization Form**, approved by the Central Bureau of Construction, that indicates which items have been approved For Bidding. If **Authorization to Bid** cannot be approved, the **Proposal Denial and/or Authorization Form** will indicate the reason for denial.

ABOUT AUTHORIZATION TO BID: Firms that have not received an authorization form within a reasonable time of complete and correct original document submittal should contact the department as to status. This is critical in the week before the letting. These documents must be received three days before the letting date. Firms unsure as to authorization status should call the Prequalification Section of the Bureau of Construction at the number listed at the end of these instructions.

ADDENDA AND REVISIONS: It is the contractor's responsibility to determine which, if any, addenda or revisions pertain to any project they may be bidding. Failure to incorporate all relevant addenda or revisions may cause the bid to be declared unacceptable.

Each addendum will be placed with the contract number. Addenda and revisions will also be placed on the Addendum/Revision Checklist and each subscription service subscriber will be notified by e-mail of each addendum and revision issued.

The Internet is the Department's primary way of doing business. The subscription server e-mails are an added courtesy the Department provides. It is suggested that bidders check IDOT's website at <http://www.dot.il.gov/desenv/delett.html> before submitting final bid information.

IDOT IS NOT RESPONSIBLE FOR ANY E-MAIL FAILURES.

Addenda Questions may be directed to the Contracts Office at (217)782-7806 or D&Econtracts@dot.il.gov

Technical Questions about downloading these files may be directed to Tim Garman (217)524-1642 or Timothy.Garman@illinois.gov.

WHAT MUST BE INCLUDED WHEN BIDS ARE SUBMITTED?: Bidders need not return the entire proposal when bids are submitted. That portion of the proposal that must be returned includes the following:

1. All documents from the Proposal Cover Sheet through the Proposal Bid Bond
2. Other special documentation and/or information that may be required by the contract special provisions

All proposal documents, including Proposal Guaranty Checks or Proposal Bid Bonds, should be stapled together to prevent loss when bids are processed by IDOT personnel.

ABOUT SUBMITTING BIDS: It is recommended that bidders deliver bids in person to insure they arrive at the proper location prior to the time specified for the receipt of bids. Any bid received at the place of letting after the time specified will not be accepted.

WHO SHOULD BE CALLED IF ASSISTANCE IS NEEDED?

Questions Regarding	Call
Prequalification and/or Authorization to Bid	217/782-3413
Preparation and submittal of bids	217/782-7806
Mailing of plans and proposals	217/782-7806

ADDENDUMS AND REVISIONS TO THE PROPOSAL FORMS

Planholders should verify that they have received and incorporated any addendum and/or revision prior to submitting their bid. Failure by the bidder to include an addendum or revision could result in a bid being rejected as irregular.

62

RETURN WITH BID

Proposal Submitted By
Name
Address
City

Letting August 1, 2008

BIDDERS NEED NOT RETURN THE ENTIRE PROPOSAL
(See instructions inside front cover)

NOTICE TO PROSPECTIVE BIDDERS

This proposal can be used for bidding purposes by only those companies that request and receive written AUTHORIZATION TO BID from IDOT's Central Bureau of Construction.

(SEE INSTRUCTIONS ON THE INSIDE OF COVER)

Notice To Bidders, Specifications, Proposal, Contract and Contract Bond



**Illinois Department
of Transportation**

Springfield, Illinois 62764

**Contract No. 99326
WILLIAMSON County
Section 07-00118-00-SP
Route FAS 905 (CH 18)
Project HRR-0199(031)
District 9 Construction Funds**

PLEASE MARK THE APPROPRIATE BOX BELOW:

- A Bid Bond is included.
- A Cashier's Check or a Certified Check is included

Plans Included
Herein

Prepared by

F

Checked by

(Printed by authority of the State of Illinois)

INSTRUCTIONS

ABOUT IDOT PROPOSALS: All proposals issued by IDOT are potential bidding proposals. Each proposal contains all Certifications and Affidavits, a Proposal Signature Sheet and a Proposal Bid Bond required for Prime Contractors to submit a bid after written **Authorization to Bid** has been issued by IDOT's Central Bureau of Construction.

WHO CAN BID?: Bids will be accepted from only those companies that request and receive written **Authorization to Bid** from IDOT's Central Bureau of Construction. To request authorization, a potential bidder must complete and submit Part B of the Request for Authorization to Bid/or Not For Bid Status form (BDE 124 INT) and submit an original Affidavit of Availability (BC 57).

WHAT CONSTITUTES WRITTEN AUTHORIZATION TO BID?: When a prospective prime bidder submits a "Request for Proposal Forms and Plans" he/she must indicate at that time which items are being requested For Bidding purposes. Only those items requested For Bidding will be analyzed. After the request has been analyzed, the bidder will be issued a **Proposal Denial and/or Authorization Form**, approved by the Central Bureau of Construction, that indicates which items have been approved For Bidding. If **Authorization to Bid** cannot be approved, the **Proposal Denial and/or Authorization Form** will indicate the reason for denial. If a contractor has requested to bid but has not received a **Proposal Denial and/or Authorization Form**, they should contact the Central Bureau of Construction in advance of the letting date.

WHAT MUST BE INCLUDED WHEN BIDS ARE SUBMITTED?: Bidders need not return the entire proposal when bids are submitted. That portion of the proposal that must be returned includes the following:

1. All documents from the Proposal Cover Sheet through the Proposal Bid Bond
2. Other special documentation and/or information that may be required by the contract special provisions

All proposal documents, including Proposal Guaranty Checks or Proposal Bid Bonds, should be stapled together to prevent loss when bids are processed by IDOT personnel.

ABOUT SUBMITTING BIDS: It is recommended that bidders deliver bids in person to insure they arrive at the proper location prior to the time specified for the receipt of bids. Any bid received at the place of letting after the time specified will not be accepted.

WHO SHOULD BE CALLED IF ASSISTANCE IS NEEDED?

Questions Regarding	Call
Prequalification and/or Authorization to Bid	217/782-3413
Preparation and submittal of bids	217/782-7806
Mailing of CD-ROMS	217/782-7806

RETURN WITH BID



PROPOSAL

TO THE DEPARTMENT OF TRANSPORTATION

1. Proposal of _____

Taxpayer Identification Number (Mandatory) _____

for the improvement identified and advertised for bids in the Invitation for Bids as:

**Contract No. 99326
WILLIAMSON County
Section 07-00118-00-SP
Project HRR-0199(031)
Route FAS 905 (CH 18)
District 9 Construction Funds**

Improvement consists of constructing an 8-inch HMA shoulder with rumble strips, tree removal from within the existing right-of-way, guardrail removal and replacement, signing and pavement marking from Crab Orchard Road south for 8.19 miles to IL Route 166.

2. The undersigned bidder will furnish all labor, material and equipment to complete the above described project in a good and workmanlike manner as provided in the contract documents provided by the Department of Transportation. This proposal will become part of the contract and the terms and conditions contained in the contract documents shall govern performance and payments.

RETURN WITH BID

3. **ASSURANCE OF EXAMINATION AND INSPECTION/WAIVER.** The undersigned further declares that he/she has carefully examined the proposal, plans, specifications, form of contract and contract bond, and special provisions, and that he/she has inspected in detail the site of the proposed work, and that he/she has familiarized themselves with all of the local conditions affecting the contract and the detailed requirements of construction, and understands that in making this proposal he/she waives all right to plead any misunderstanding regarding the same.

4. **EXECUTION OF CONTRACT AND CONTRACT BOND.** The undersigned further agrees to execute a contract for this work and present the same to the department within fifteen (15) days after the contract has been mailed to him/her. The undersigned further agrees that he/she and his/her surety will execute and present within fifteen (15) days after the contract has been mailed to him/her contract bond satisfactory to and in the form prescribed by the Department of Transportation, in the penal sum of the full amount of the contract, guaranteeing the faithful performance of the work in accordance with the terms of the contract.

5. **PROPOSAL GUARANTY.** Accompanying this proposal is either a bid bond on the department form, executed by a corporate surety company satisfactory to the department, or a proposal guaranty check consisting of a bank cashier's check or a properly certified check for not less than 5 per cent of the amount bid or for the amount specified in the following schedule:

<u>Amount of Bid</u>		<u>Proposal Guaranty</u>		<u>Amount of Bid</u>		<u>Proposal Guaranty</u>	
Up to	\$5,000	\$150		\$2,000,000	to	\$3,000,000	\$100,000
\$5,000	to \$10,000	\$300		\$3,000,000	to	\$5,000,000	\$150,000
\$10,000	to \$50,000	\$1,000		\$5,000,000	to	\$7,500,000	\$250,000
\$50,000	to \$100,000	\$3,000		\$7,500,000	to	\$10,000,000	\$400,000
\$100,000	to \$150,000	\$5,000		\$10,000,000	to	\$15,000,000	\$500,000
\$150,000	to \$250,000	\$7,500		\$15,000,000	to	\$20,000,000	\$600,000
\$250,000	to \$500,000	\$12,500		\$20,000,000	to	\$25,000,000	\$700,000
\$500,000	to \$1,000,000	\$25,000		\$25,000,000	to	\$30,000,000	\$800,000
\$1,000,000	to \$1,500,000	\$50,000		\$30,000,000	to	\$35,000,000	\$900,000
\$1,500,000	to \$2,000,000	\$75,000		over		\$35,000,000	\$1,000,000

Bank cashier's checks or properly certified checks accompanying proposals shall be made payable to the Treasurer, State of Illinois, when the state is awarding authority; the county treasurer, when a county is the awarding authority; or the city, village, or town treasurer, when a city, village, or town is the awarding authority.

If a combination bid is submitted, the proposal guaranties which accompany the individual proposals making up the combination will be considered as also covering the combination bid.

The amount of the proposal guaranty check is _____ \$(_____). If this proposal is accepted and the undersigned shall fail to execute a contract bond as required herein, it is hereby agreed that the amount of the proposal guaranty shall become the property of the State of Illinois, and shall be considered as payment of damages due to delay and other causes suffered by the State because of the failure to execute said contract and contract bond; otherwise, the bid bond shall become void or the proposal guaranty check shall be returned to the undersigned.

Attach Cashier's Check or Certified Check Here

In the event that one proposal guaranty check is intended to cover two or more proposals, the amount must be equal to the sum of the proposal guaranties which would be required for each individual proposal. If the guaranty check is placed in another proposal, state below where it may be found.

The proposal guaranty check will be found in the proposal for:

Item _____

Section No. _____

County _____

Mark the proposal cover sheet as to the type of proposal guaranty submitted.

RETURN WITH BID

6. **COMBINATION BIDS.** The undersigned further agrees that if awarded the contract for the sections contained in the following combination, he/she will perform the work in accordance with the requirements of each individual proposal comprising the combination bid specified in the schedule below, and that the combination bid shall be prorated against each section in proportion to the bid submitted for the same. If an error is found to exist in the gross sum bid for one or more of the individual sections included in a combination, the combination bid shall be corrected as provided in the specifications.

When a combination bid is submitted, the schedule below must be completed in each proposal comprising the combination.

If alternate bids are submitted for one or more of the sections comprising the combination, a combination bid must be submitted for each alternate.

Schedule of Combination Bids

Combination No.	Sections Included in Combination	Combination Bid	
		Dollars	Cents

7. **SCHEDULE OF PRICES.** The undersigned bidder submits herewith, in accordance with the rules and instructions, a schedule of prices for the items of work for which bids are sought. The unit prices bid are in U.S. dollars and cents, and all extensions and summations have been made. The bidder understands that the quantities appearing in the bid schedule are approximate and are provided for the purpose of obtaining a gross sum for the comparison of bids. If there is an error in the extension of the unit prices, the unit prices shall govern. Payment to the contractor awarded the contract will be made only for actual quantities of work performed and accepted or materials furnished according to the contract. The scheduled quantities of work to be done and materials to be furnished may be increased, decreased or omitted as provided elsewhere in the contract.
8. **CERTIFICATE OF AUTHORITY.** The undersigned bidder, if a business organized under the laws of another State, assures the Department that it will furnish a copy of its certificate of authority to do business in the State of Illinois with the return of the executed contract and bond. Failure to furnish the certificate within the time provided for execution of an awarded contract may be cause for cancellation of the award and forfeiture of the proposal guaranty to the State.

STATE JOB # - C-99-501-08
 PPS NBR - 0-01670-0000

ILLINOIS DEPARTMENT OF TRANSPORTATION
 SCHEDULE OF PRICES
 CONTRACT NUMBER - 99326

ECMS002 DTGECM03 ECMR003 PAGE 1
 RUN DATE - 06/25/08
 RUN TIME - 185543

COUNTY NAME	CODE	DIST	SECTION NUMBER	PROJECT NUMBER	ROUTE
WILLIAMSON	199	09	07-00118-00-SP	HRR-0199/031/000	FAS 905

ITEM NUMBER	PAY ITEM DESCRIPTION	UNIT OF MEASURE	QUANTITY	UNIT PRICE		TOTAL PRICE
				DOLLARS	CENTS	
20100500	TREE REMOV ACRES	ACRE	0.100			
20101300	TREE PRUN 1-10	EACH	24.000			
20101350	TREE PRUN OVER 10	EACH	55.000			
48203029	HMA SHOULDERS 8	SQ YD	19,200.000			
63000000	SPBGR TY A	FOOT	587.500			
63100075	TRAF BAR TERM T5A	EACH	8.000			
63100167	TR BAR TRM T1 SPL TAN	EACH	14.000			
63200310	GUARDRAIL REMOV	FOOT	724.000			
64200105	SHOULDER RUMBLE STRIP	FOOT	85,100.000			
67100100	MOBILIZATION	L SUM	1.000			
72000100	SIGN PANEL T1	SQ FT	1,526.000			
72900200	METAL POST TY B	FOOT	1,937.000			
78001110	PAINT PVT MK LINE 4	FOOT	165,000.000			
78100100	RAISED REFL PAVT MKR	EACH	540.000			

TOTAL \$

NOTE:
 *** PLEASE TURN PAGE FOR IMPORTANT NOTES ***

FAS 905
07-00118-00-SP
WILLIAMSON

ILLINOIS DEPARTMENT OF TRANSPORTATION
SCHEDULE OF PRICES
CONTRACT NUMBER - 99326

ECMS002 DTGECM03 ECMR003 PAGE
RUN DATE - 06/25/08
RUN TIME - 185543

NOTE:

1. EACH PAY ITEM SHOULD HAVE A UNIT PRICE AND A TOTAL PRICE.
2. THE UNIT PRICE SHALL GOVERN IF NO TOTAL PRICE IS SHOWN OR IF THERE IS A DISCREPANCY BETWEEN THE PRODUCT OF THE UNIT PRICE MULTIPLIED BY THE QUANTITY.
3. IF A UNIT PRICE IS OMITTED, THE TOTAL PRICE WILL BE DIVIDED BY THE QUANTITY IN ORDER TO ESTABLISH A UNIT PRICE.
4. A BID MAY BE DECLARED UNACCEPTABLE IF NEITHER A UNIT PRICE NOR A TOTAL PRICE IS SHOWN.

RETURN WITH BID

STATE REQUIRED ETHICAL STANDARDS GOVERNING CONTRACT PROCUREMENT: ASSURANCES, CERTIFICATIONS AND DISCLOSURES

I. GENERAL

A. Article 50 of the Illinois Procurement Code establishes the duty of all State chief procurement officers, State purchasing officers, and their designees to maximize the value of the expenditure of public moneys in procuring goods, services, and contracts for the State of Illinois and to act in a manner that maintains the integrity and public trust of State government. In discharging this duty, they are charged by law to use all available information, reasonable efforts, and reasonable actions to protect, safeguard, and maintain the procurement process of the State of Illinois.

B. In order to comply with the provisions of Article 50 and to carry out the duty established therein, all bidders are to adhere to ethical standards established for the procurement process, and to make such assurances, disclosures and certifications required by law. By execution of the Proposal Signature Sheet, the bidder indicates that each of the mandated assurances has been read and understood, that each certification is made and understood, and that each disclosure requirement has been understood and completed.

C. In addition to all other remedies provided by law, failure to comply with any assurance, failure to make any disclosure or the making of a false certification shall be grounds for termination of the contract and the suspension or debarment of the bidder.

II. ASSURANCES

A. The assurances hereinafter made by the bidder are each a material representation of fact upon which reliance is placed should the Department enter into the contract with the bidder. The Department may terminate the contract if it is later determined that the bidder rendered a false or erroneous assurance, and the surety providing the performance bond shall be responsible for the completion of the contract.

B. Felons

1. The Illinois Procurement Code provides:

Section 50-10. Felons. Unless otherwise provided, no person or business convicted of a felony shall do business with the State of Illinois or any state agency from the date of conviction until 5 years after the date of completion of the sentence for that felony, unless no person held responsible by a prosecutorial office for the facts upon which the conviction was based continues to have any involvement with the business.

2. The bidder assures the Department that the award and execution of the contract would not cause a violation of Section 50-10.

C. Conflicts of Interest

1. The Illinois Procurement Code provides in pertinent part:

Section 50-13. Conflicts of Interest.

(a) Prohibition. It is unlawful for any person holding an elective office in this State, holding a seat in the General Assembly, or appointed to or employed in any of the offices or agencies of state government and who receives compensation for such employment in excess of 60% of the salary of the Governor of the State of Illinois, or who is an officer or employee of the Capital Development Board or the Illinois Toll Highway Authority, or who is the spouse or minor child of any such person to have or acquire any contract, or any direct pecuniary interest in any contract therein, whether for stationery, printing, paper, or any services, materials, or supplies, that will be wholly or partially satisfied by the payment of funds appropriated by the General Assembly of the State of Illinois or in any contract of the Capital Development Board or the Illinois Toll Highway authority.

(b) Interests. It is unlawful for any firm, partnership, association or corporation, in which any person listed in subsection (a) is entitled to receive (i) more than 7 1/2% of the total distributable income or (ii) an amount in excess of the salary of the Governor, to have or acquire any such contract or direct pecuniary interest therein.

(c) Combined interests. It is unlawful for any firm, partnership, association, or corporation, in which any person listed in subsection (a) together with his or her spouse or minor children is entitled to receive (i) more than 15%, in the aggregate, of the total distributable income or (ii) an amount in excess of 2 times the salary of the Governor, to have or acquire any such contract or direct pecuniary interest therein.

(d) Securities. Nothing in this Section invalidates the provisions of any bond or other security previously offered or to be offered for sale or sold by or for the State of Illinois.

(e) Prior interests. This Section does not affect the validity of any contract made between the State and an officer or employee of the State or member of the General Assembly, his or her spouse, minor child or any combination of those persons if that contract was in existence before his or her election or employment as an officer, member, or employee. The contract is voidable, however, if it cannot be completed within 365 days after the officer, member, or employee takes office or is employed.

The current salary of the Governor is \$171,000.00. Sixty percent of the salary is \$102,600.00.

RETURN WITH BID

2. The bidder assures the Department that the award and execution of the contract would not cause a violation of Section 50-13, or that an effective exemption has been issued by the Board of Ethics to any individual subject to the Section 50-13 prohibitions pursuant to the provisions of Section 50-20 of the Code and Executive Order Number 3 (1998). Information concerning the exemption process is available from the Department upon request.

D. Negotiations

1. The Illinois Procurement Code provides in pertinent part:

Section 50-15. Negotiations.

(a) It is unlawful for any person employed in or on a continual contractual relationship with any of the offices or agencies of State government to participate in contract negotiations on behalf of that office or agency with any firm, partnership, association, or corporation with whom that person has a contract for future employment or is negotiating concerning possible future employment.

2. The bidder assures the Department that the award and execution of the contract would not cause a violation of Section 50-15, and that the bidder has no knowledge of any facts relevant to the kinds of acts prohibited therein.

E. Inducements

1. The Illinois Procurement Code provides:

Section 50-25. Inducement. Any person who offers or pays any money or other valuable thing to any person to induce him or her not to bid for a State contract or as recompense for not having bid on a State contract is guilty of a Class 4 felony. Any person who accepts any money or other valuable thing for not bidding for a State contract or who withholds a bid in consideration of the promise for the payment of money or other valuable thing is guilty of a Class 4 felony.

2. The bidder assures the Department that the award and execution of the contract would not cause a violation of Section 50-25, and that the bidder has no knowledge of any facts relevant to the kinds of acts prohibited therein.

F. Revolving Door Prohibition

1. The Illinois Procurement Code provides:

Section 50-30. Revolving door prohibition. Chief procurement officers, associate procurement officers, State purchasing officers, their designees whose principal duties are directly related to State procurement, and executive officers confirmed by the Senate are expressly prohibited for a period of 2 years after terminating an affected position from engaging in any procurement activity relating to the State agency most recently employing them in an affected position for a period of at least 6 months. The prohibition includes, but is not limited to: lobbying the procurement process; specifying; bidding; proposing bid, proposal, or contract documents; on their own behalf or on behalf of any firm, partnership, association, or corporation. This Section applies only to persons who terminate an affected position on or after January 15, 1999.

2. The bidder assures the Department that the award and execution of the contract would not cause a violation of Section 50-30, and that the bidder has no knowledge of any facts relevant to the kinds of acts prohibited therein.

G. Reporting Anticompetitive Practices

1. The Illinois Procurement Code provides:

Section 50-40. Reporting anticompetitive practices. When, for any reason, any vendor, bidder, contractor, chief procurement officer, State purchasing officer, designee, elected official, or State employee suspects collusion or other anticompetitive practice among any bidders, offerors, contractors, proposers, or employees of the State, a notice of the relevant facts shall be transmitted to the Attorney General and the chief procurement officer.

2. The bidder assures the Department that it has not failed to report any relevant facts concerning the practices addressed in Section 50-40 which may involve the contract for which the bid is submitted.

H. Confidentiality

1. The Illinois Procurement Code provides:

Section 50-45. Confidentiality. Any chief procurement officer, State purchasing officer, designee, or executive officer who willfully uses or allows the use of specifications, competitive bid documents, proprietary competitive information, proposals, contracts, or selection information to compromise the fairness or integrity of the procurement, bidding, or contract process shall be subject to immediate dismissal, regardless of the Personnel code, any contract, or any collective bargaining agreement, and may in addition be subject to criminal prosecution.

2. The bidder assures the Department that it has no knowledge of any fact relevant to the practices addressed in Section 50-45 which may involve the contract for which the bid is submitted.

RETURN WITH BID

I. Insider Information

1. The Illinois Procurement Act provides:

Section 50-50. Insider information. It is unlawful for any current or former elected or appointed State official or State employee to knowingly use confidential information available only by virtue of that office or employment for actual or anticipated gain for themselves or another person.

2. The bidder assures the Department that it has no knowledge of any facts relevant to the practices addressed in Section 50-50 which may involve the contract for which the bid is submitted.

III. CERTIFICATIONS

A. The certifications hereinafter made by the bidder are each a material representation of fact upon which reliance is placed should the Department enter into the contract with the bidder. The Department may terminate the contract if it is later determined that the bidder rendered a false or erroneous certification, and the surety providing the performance bond shall be responsible for completion of the contract.

B. Bribery

1. The Illinois Procurement Code provides:

Section 50-5. Bribery.

(a) Prohibition. No person or business shall be awarded a contract or subcontract under this Code who:

(1) has been convicted under the laws of Illinois or any other state of bribery or attempting to bribe an officer or employee of the State of Illinois or any other state in that officer's or employee's official capacity; or

(2) has made an admission of guilt of that conduct that is a matter of record but has not been prosecuted for that conduct.

(b) Businesses. No business shall be barred from contracting with any unit of State or local government as a result of a conviction under this Section of any employee or agent of the business if the employee or agent is no longer employed by the business and:

(1) the business has been finally adjudicated not guilty; or

(2) the business demonstrates to the governmental entity with which it seeks to contract, and that entity finds that the commission of the offense was not authorized, requested, commanded, or performed by a director, officer, or high managerial agent on behalf of the business as provided in paragraph (2) of subsection (a) of Section 5-4 of the Criminal Code of 1961.

(c) Conduct on behalf of business. For purposes of this Section, when an official, agent, or employee of a business committed the bribery or attempted bribery on behalf of the business and in accordance with the direction or authorization of a responsible official of the business, the business shall be chargeable with the conduct.

(d) Certification. Every bid submitted to and contract executed by the State shall contain a certification by the contractor that the contractor is not barred from being awarded a contract or subcontract under this Section. A contractor who makes a false statement, material to the certification, commits a Class 3 felony.

2. The bidder certifies that it is not barred from being awarded a contract under Section 50.5.

C. Educational Loan

1. Section 3 of the Educational Loan Default Act provides:

§ 3. No State agency shall contract with an individual for goods or services if that individual is in default, as defined in Section 2 of this Act, on an educational loan. Any contract used by any State agency shall include a statement certifying that the individual is not in default on an educational loan as provided in this Section.

2. The bidder, if an individual as opposed to a corporation, partnership or other form of business organization, certifies that the bidder is not in default on an educational loan as provided in Section 3 of the Act.

D. Bid-Rigging/Bid Rotating

1. Section 33E-11 of the Criminal Code of 1961 provides:

§ 33E-11. (a) Every bid submitted to and public contract executed pursuant to such bid by the State or a unit of local government shall contain a certification by the prime contractor that the prime contractor is not barred from contracting with any unit of State or local government as a result of a violation of either Section 33E-3 or 33E-4 of this Article. The State and units of local government shall provide the appropriate forms for such certification.

RETURN WITH BID

(b) A contractor who makes a false statement, material to the certification, commits a Class 3 felony.

A violation of Section 33E-3 would be represented by a conviction of the crime of bid-rigging which, in addition to Class 3 felony sentencing, provides that any person convicted of this offense or any similar offense of any state or the United States which contains the same elements as this offense shall be barred for 5 years from the date of conviction from contracting with any unit of State or local government. No corporation shall be barred from contracting with any unit of State or local government as a result of a conviction under this Section of any employee or agent of such corporation if the employee so convicted is no longer employed by the corporation and: (1) it has been finally adjudicated not guilty or (2) if it demonstrates to the governmental entity with which it seeks to contract and that entity finds that the commission of the offense was neither authorized, requested, commanded, nor performed by a director, officer or a high managerial agent in behalf of the corporation.

A violation of Section 33E-4 would be represented by a conviction of the crime of bid-rotating which, in addition to Class 2 felony sentencing, provides that any person convicted of this offense or any similar offense of any state or the United States which contains the same elements as this offense shall be permanently barred from contracting with any unit of State or local government. No corporation shall be barred from contracting with any unit of State or local government as a result of a conviction under this Section of any employee or agent of such corporation if the employee so convicted is no longer employed by the corporation and: (1) it has been finally adjudicated not guilty or (2) if it demonstrates to the governmental entity with which it seeks to contract and that entity finds that the commission of the offense was neither authorized, requested, commanded, nor performed by a director, officer or a high managerial agent in behalf of the corporation.

2. The bidder certifies that it is not barred from contracting with the Department by reason of a violation of either Section 33E-3 or Section 33E-4.

E. International Anti-Boycott

1. Section 5 of the International Anti-Boycott Certification Act provides:

§ 5. State contracts. Every contract entered into by the State of Illinois for the manufacture, furnishing, or purchasing of supplies, material, or equipment or for the furnishing of work, labor, or services, in an amount exceeding the threshold for small purchases according to the purchasing laws of this State or \$10,000.00, whichever is less, shall contain certification, as a material condition of the contract, by which the contractor agrees that neither the contractor nor any substantially-owned affiliated company is participating or shall participate in an international boycott in violation of the provisions of the U.S. Export Administration Act of 1979 or the regulations of the U.S. Department of Commerce promulgated under that Act.

2. The bidder makes the certification set forth in Section 5 of the Act.

F. Drug Free Workplace

1. The Illinois "Drug Free Workplace Act" applies to this contract and it is necessary to comply with the provisions of the "Act" if the contractor is a corporation, partnership, or other entity (including a sole proprietorship) which has 25 or more employees.

2. The bidder certifies that if awarded a contract in excess of \$5,000 it will provide a drug free workplace by:

(a) Publishing a statement notifying employees that the unlawful manufacture, distribution, dispensation, possession or use of a controlled substance, including cannabis, is prohibited in the contractor's workplace; specifying the actions that will be taken against employees for violations of such prohibition; and notifying the employee that, as a condition of employment on such contract, the employee shall abide by the terms of the statement, and notify the employer of any criminal drug statute conviction for a violation occurring in the workplace no later than five (5) days after such conviction.

(b) Establishing a drug free awareness program to inform employees about the dangers of drug abuse in the workplace; the contractor's policy of maintaining a drug free workplace; any available drug counseling, rehabilitation, and employee assistance programs; and the penalties that may be imposed upon employees for drug violations.

(c) Providing a copy of the statement required by subparagraph (1) to each employee engaged in the performance of the contract and to post the statement in a prominent place in the workplace.

(d) Notifying the Department within ten (10) days after receiving notice from an employee or otherwise receiving actual notice of the conviction of an employee for a violation of any criminal drug statute occurring in the workplace.

(e) Imposing or requiring, within 30 days after receiving notice from an employee of a conviction or actual notice of such a conviction, an appropriate personnel action, up to and including termination, or the satisfactory participation in a drug abuse assistance or rehabilitation program approved by a federal, state or local health, law enforcement or other appropriate agency.

(f) Assisting employees in selecting a course of action in the event drug counseling, treatment, and rehabilitation is required and indicating that a trained referral team is in place.

(g) Making a good faith effort to continue to maintain a drug free workplace through implementation of the actions and efforts stated in this certification.

RETURN WITH BID

G. Debt Delinquency

1. The Illinois Procurement Code provides:

Section 50-11 and 50-12. Debt Delinquency.

The contractor or bidder certifies that it, or any affiliate, is not barred from being awarded a contract under 30 ILCS 500. Section 50-11 prohibits a person from entering into a contract with a State agency if it knows or should know that it, or any affiliate, is delinquent in the payment of any debt to the State as defined by the Debt Collection Board. Section 50-12 prohibits a person from entering into a contract with a State agency if it, or any affiliate, has failed to collect and remit Illinois Use Tax on all sales of tangible personal property into the State of Illinois in accordance with the provisions of the Illinois Use Tax Act. The contractor further acknowledges that the contracting State agency may declare the contract void if this certification is false or if the contractor, or any affiliate, is determined to be delinquent in the payment of any debt to the State during the term of the contract.

H. Sarbanes-Oxley Act of 2002

1. The Illinois Procurement Code, Section 50-60(c), provides:

The contractor certifies in accordance with 30 ILCS 500/50-10.5 that no officer, director, partner or other managerial agent of the contracting business has been convicted of a felony under the Sarbanes-Oxley Act of 2002 or a Class 3 or Class 2 felony under the Illinois Securities Law of 1953 for a period of five years prior to the date of the bid or contract. The contractor acknowledges that the contracting agency shall declare the contract void if this certification is false.

I. Addenda

The contractor or bidder certifies that all relevant addenda have been incorporated in to this contract. Failure to do so may cause the bid to be declared unacceptable.

J. Section 42 of the Environmental Protection Act

The contractor certifies in accordance with 30 ILCS 500/50-12 that the bidder or contractor is not barred from being awarded a contract under this Section which prohibits the bidding on or entering into contracts with the State of Illinois or a State agency by a person or business found by a court or the Pollution Control Board to have committed a willful or knowing violation of Section 42 of the Environmental Protection Act for a period of five years from the date of the order. The contractor acknowledges that the contracting agency may declare the contract void if this certification is false.

K. Apprenticeship and Training Certification (Does not apply to federal aid projects)

In accordance with the provisions of Section 30-22 (6) of the Illinois Procurement Code, the bidder certifies that it is a participant, either as an individual or as part of a group program, in the approved apprenticeship and training programs applicable to each type of work or craft that the bidder will perform with its own forces. The bidder further certifies for work that will be performed by subcontract that each of its subcontractors submitted for approval either (a) is, at the time of such bid, participating in an approved, applicable apprenticeship and training program; or (b) will, prior to commencement of performance of work pursuant to this contract, begin participation in an approved apprenticeship and training program applicable to the work of the subcontract. The Department, at any time before or after award, may require the production of a copy of each applicable Certificate of Registration issued by the United States Department of Labor evidencing such participation by the contractor and any or all of its subcontractors. Applicable apprenticeship and training programs are those that have been approved and registered with the United States Department of Labor. The bidder shall list in the space below, the official name of the program sponsor holding the Certificate of Registration for all of the types of work or crafts in which the bidder is a participant and that will be performed with the bidder's forces. Types of work or craft work that will be subcontracted shall be included and listed as subcontract work. The list shall also indicate any type of work or craft job category that does not have an applicable apprenticeship or training program. **The bidder is responsible for making a complete report and shall make certain that each type of work or craft job category that will be utilized on the project as reported on the Construction Employee Workforce Projection (Form BC-1256) and returned with the bid is accounted for and listed.**

NA - FEDERAL

The requirements of this certification and disclosure are a material part of the contract, and the contractor shall require this certification provision to be included in all approved subcontracts. In order to fulfill this requirement, it shall not be necessary that an applicable program sponsor be currently taking or that it will take applications for apprenticeship, training or employment during the performance of the work of this contract.

L. Executive Order Number 1 (2007) Regarding Lobbying on Government Procurements

The bidder hereby warrants and certifies that they have complied and will comply with the requirements set forth in this Order. The requirements of this warrant and certification are a material part of the contract, and the contractor shall require this warrant and certification provision to be included in all approved subcontracts.

RETURN WITH BID

M. Disclosure of Business Operations in Iran

Public Act 95-0616 provides that each bid, offer, or proposal submitted for a State contract shall include a disclosure of whether or not the Company acting as the bidder, offer or, or proposing entity, or any of its corporate parents or subsidiaries, within the 24 months before submission of the bid, offer, or proposal had business operations that involved contracts with or provision of supplies or services to the Government of Iran, companies in which the Government of Iran has any direct or indirect equity share, consortiums or projects commissioned by the Government of Iran, or companies involved in consortiums or projects commissioned by the Government of Iran and either of the following conditions apply:

- (1) More than 10% of the Company's revenues produced in or assets located in Iran involve oil-related activities or mineral-extraction activities; less than 75% of the Company's revenues produced in or assets located in Iran involve contracts with or provision of oil-related or mineral-extraction products or services to the Government of Iran or a project or consortium created exclusively by that government; and the Company has failed to take substantial action.
- (2) The Company has, on or after August 5, 1996, made an investment of \$20 million or more, or any combination of investments of at least \$10 million each that in the aggregate equals or exceeds \$20 million in any 12-month period, which directly or significantly contributes to the enhancement of Iran's ability to develop petroleum resources of Iran.

The terms "Business operations", "Company", "Mineral-extraction activities", "Oil-related activities", "Petroleum resources", and "Substantial action" are all defined in the Act.

Failure to make the disclosure required by the Act shall cause the bid, offer or proposal to be considered not responsive. The disclosure will be considered when evaluating the bid, offer, or proposal or awarding the contract. The name of each Company disclosed as doing business or having done business in Iran will be provided to the State Comptroller.

Check the appropriate statement:

Company has no business operations in Iran to disclose.

Company has business operations in Iran as disclosed the attached document.

TO BE RETURNED WITH BID

IV. DISCLOSURES

A. The disclosures hereinafter made by the bidder are each a material representation of fact upon which reliance is placed should the Department enter into the contract with the bidder. The Department may terminate the contract if it is later determined that the bidder rendered a false or erroneous disclosure, and the surety providing the performance bond shall be responsible for completion of the contract.

B. Financial Interests and Conflicts of Interest

1. Section 50-35 of the Illinois Procurement Code provides that all bids of more than \$10,000 shall be accompanied by disclosure of the financial interests of the bidder. This disclosed information for the successful bidder, will be maintained as public information subject to release by request pursuant to the Freedom of Information Act.

The financial interests to be disclosed shall include ownership or distributive income share that is in excess of 5%, or an amount greater than 60% of the annual salary of the Governor, of the bidding entity or its parent entity, whichever is less, unless the contractor or bidder is a publicly traded entity subject to Federal 10K reporting, in which case it may submit its 10K disclosure in place of the prescribed disclosure. If a bidder is a privately held entity that is exempt from Federal 10K reporting, but has more than 400 shareholders, it may submit the information that Federal 10K companies are required to report, and list the names of any person or entity holding any ownership share that is in excess of 5%. The disclosure shall include the names, addresses, and dollar or proportionate share of ownership of each person making the disclosure, their instrument of ownership or beneficial relationship, and notice of any potential conflict of interest resulting from the current ownership or beneficial interest of each person making the disclosure having any of the relationships identified in Section 50-35 and on the disclosure form.

In addition, all disclosures shall indicate any other current or pending contracts, proposals, leases, or other ongoing procurement relationships the bidding entity has with any other unit of state government and shall clearly identify the unit and the contract, proposal, lease, or other relationship.

2. **Disclosure Forms.** Disclosure Form A is attached for use concerning the individuals meeting the above ownership or distributive share requirements. Subject individuals should be covered each by one form. In addition, a second form (Disclosure Form B) provides for the disclosure of current or pending procurement relationships with other (non-IDOT) state agencies. **The forms must be included with each bid or incorporated by reference.**

C. Disclosure Form Instructions

Form A: For bidders that have previously submitted the information requested in Form A

The Department has retained the Form A disclosures submitted by all bidders responding to these requirements for the April 24, 1998 or any subsequent letting conducted by the Department. The bidder has the option of submitting the information again or the bidder may check the following certification statement indicating that the information previously submitted by the bidder is, as of the date of submission, current and accurate. Before checking this certification, the bidder should carefully review its prior submissions to ensure the Certification is correct. If the Bidder checks the Certification, the Bidder should proceed to Form B instructions.

CERTIFICATION STATEMENT

I have determined that the Form A disclosure information previously submitted is current and accurate, and all forms are hereby incorporated by reference in this bid. Any necessary additional forms or amendments to previously submitted forms are attached to this bid.

(Bidding Company)



Signature of Authorized Representative

Date

Form A: For bidders who have NOT previously submitted the information requested in Form A

If the bidder is a publicly traded entity subject to Federal 10K reporting, the 10K Report may be submitted to meet the requirements of Form A. If a bidder is a privately held entity that is exempt from Federal 10K reporting, but has more than 400 shareholders, it may submit the information that Federal 10K companies are required to report, and list the names of any person or entity holding any ownership share that is in excess of 5%. If a bidder is not subject to Federal 10K reporting, the bidder must determine if any individuals are required by law to complete a financial disclosure form. To do this, the bidder should answer each of the following questions. A "YES" answer indicates Form A must be completed. If the answer to each of the following questions is "NO", then the NOT APPLICABLE STATEMENT on the second page of Form A must be signed and dated by a person that is authorized to execute contracts for the bidding company. Note: These questions are for assistance only and are not required to be completed.

1. Does anyone in your organization have a direct or beneficial ownership share of greater than 5% of the bidding entity or parent entity? YES ___ NO ___
2. Does anyone in your organization have a direct or beneficial ownership share of less than 5%, but which has a value greater than \$102,600.00? YES ___ NO ___
3. Does anyone in your organization receive more than \$102,600.00 of the bidding entity's or parent entity's distributive income? (Note: Distributive income is, for these purposes, any type of distribution of profits. An annual salary is not distributive income.) YES ___ NO ___
4. Does anyone in your organization receive greater than 5% of the bidding entity's or parent entity's total distributive income, but which is less than \$102,600.00? YES ___ NO ___
(Note: Only one set of forms needs to be completed per person per bid even if a specific individual would require a yes answer to more than one question.)

A "YES" answer to any of these questions requires the completion of Form A. The bidder must determine each individual in the bidding entity or the bidding entity's parent company that would cause the questions to be answered "Yes". Each form must be signed and dated by a person that is authorized to execute contracts for your organization. **Photocopied or stamped signatures are not acceptable.** The person signing can be, but does not have to be, the person for which the form is being completed. The bidder is responsible for the accuracy of any information provided.

If the answer to each of the above questions is "NO", then the NOT APPLICABLE STATEMENT on page 2 of Form A must be signed and dated by a person that is authorized to execute contracts for your company.

Form B: Identifying Other Contracts & Procurement Related Information Disclosure Form B must be completed for each bid submitted by the bidding entity. Note: *Checking the NOT APPLICABLE STATEMENT on Form A does not allow the bidder to ignore Form B. Form B must be completed, checked, and dated or the bidder may be considered nonresponsive and the bid will not be accepted.*

The Bidder shall identify, by checking Yes or No on Form B, whether it has any pending contracts (including leases), bids, proposals, or other ongoing procurement relationship with any other (non-IDOT) State of Illinois agency. If "No" is checked, the bidder only needs to complete the check box on the bottom of Form B. If "Yes" is checked, the bidder must do one of the following:

Option I: If the bidder did not submit an Affidavit of Availability to obtain authorization to bid, the bidder must list all non-IDOT State of Illinois agency pending contracts, leases, bids, proposals, and other ongoing procurement relationships. These items may be listed on Form B or on an attached sheet(s). Do not include IDOT contracts. Contracts with cities, counties, villages, etc. are not considered State of Illinois agency contracts and are not to be included. Contracts with other State of Illinois agencies such as the Department of Natural Resources or the Capital Development Board must be included. Bidders who submit Affidavits of Availability are suggested to use Option II.

Option II: If the bidder is required and has submitted an Affidavit of Availability in order to obtain authorization to bid, the bidder may write or type "See Affidavit of Availability" which indicates that the Affidavit of Availability is incorporated by reference and includes all non-IDOT State of Illinois agency pending contracts, leases, bids, proposals, and other ongoing procurement relationships. For any contracts that are not covered by the Affidavit of Availability, the bidder must identify them on Form B or on an attached sheet(s). These might be such things as leases.

D. Bidders Submitting More Than One Bid

Bidders submitting multiple bids may submit one set of forms consisting of all required Form A disclosures and one Form B for use with all bids. Please indicate in the space provided below the bid item that contains the original disclosure forms and the bid items which incorporate the forms by reference.

- The bid submitted for letting item _____ contains the Form A disclosures or Certification Statement and the Form B disclosures. The following letting items incorporate the said forms by reference:

RETURN WITH BID/OFFER

ILLINOIS DEPARTMENT OF TRANSPORTATION

Form A Financial Information & Potential Conflicts of Interest Disclosure

Contractor Name, Legal Address, City, State, Zip, Telephone Number, Email Address, Fax Number (if available)

Disclosure of the information contained in this Form is required by the Section 50-35 of the Illinois Procurement Code (30 ILCS 500). Vendors desiring to enter into a contract with the State of Illinois must disclose the financial information and potential conflict of interest information as specified in this Disclosure Form. This information shall become part of the publicly available contract file. This Form A must be completed for bids in excess of \$10,000, and for all open-ended contracts. A publicly traded company may submit a 10K disclosure (or equivalent if applicable) in satisfaction of the requirements set forth in Form A. See Disclosure Form Instructions.

DISCLOSURE OF FINANCIAL INFORMATION

1. Disclosure of Financial Information. The individual named below has an interest in the BIDDER (or its parent) in terms of ownership or distributive income share in excess of 5%, or an interest which has a value of more than \$102,600.00 (60% of the Governor's salary as of 7/1/07). (Make copies of this form as necessary and attach a separate Disclosure Form A for each individual meeting these requirements)

FOR INDIVIDUAL (type or print information)

NAME:

ADDRESS

Type of ownership/distributable income share:

stock sole proprietorship Partnership other: (explain on separate sheet): % or \$ value of ownership/distributable income share:

2. Disclosure of Potential Conflicts of Interest. Check "Yes" or "No" to indicate which, if any, of the following potential conflict of interest relationships apply. If the answer to any question is "Yes", please attach additional pages and describe.

(a) State employment, currently or in the previous 3 years, including contractual employment of services.

Yes ___ No ___

If your answer is yes, please answer each of the following questions.

- 1. Are you currently an officer or employee of either the Capitol Development Board or the Illinois Toll Highway Authority? Yes ___ No ___
2. Are you currently appointed to or employed by any agency of the State of Illinois? If you are currently appointed to or employed by any agency of the State of Illinois, and your annual salary exceeds \$102,600.00, (60% of the Governor's salary as of 7/1/07) provide the name the State agency for which you are employed and your annual salary.

RETURN WITH BID/OFFER

- 3. If you are currently appointed to or employed by any agency of the State of Illinois, and your annual salary exceeds \$102,600.00, (60% of the Governor's salary as of 7/1/07) are you entitled to receive (i) more than 7 1/2% of the total distributable income of your firm, partnership, association or corporation, or (ii) an amount in excess of the salary of the Governor? Yes ___ No ___

- 4. If you are currently appointed to or employed by any agency of the State of Illinois, and your annual salary exceeds \$102,600.00, (60% of the Governor's salary as of 7/1/07) are you and your spouse or minor children entitled to receive (i) more than 15% in aggregate of the total distributable income of your firm, partnership, association or corporation, or (ii) an amount in excess of 2 times the salary of the Governor? Yes ___ No ___

(b) State employment of spouse, father, mother, son, or daughter, including contractual employment for services in the previous 2 years.

Yes ___ No ___

If your answer is yes, please answer each of the following questions.

- 1. Is your spouse or any minor children currently an officer or employee of the Capitol Development Board or the Illinois Toll Highway Authority? Yes ___ No ___

- 2. Is your spouse or any minor children currently appointed to or employed by any agency of the State of Illinois? If your spouse or minor children is/are currently appointed to or employed by any agency of the State of Illinois, and his/her annual salary exceeds \$102,600.00, (60% of the Governor's salary as of 7/1/07) provide the name of the spouse and/or minor children, the name of the State agency for which he/she is employed and his/her annual salary. _____

- 3. If your spouse or any minor children is/are currently appointed to or employed by any agency of the State of Illinois, and his/her annual salary exceeds \$102,600.00, (60% of the salary of the Governor as of 7/1/07) are you entitled to receive (i) more than 7 1/2% of the total distributable income of your firm, partnership, association or corporation, or (ii) an amount in excess of the salary of the Governor? Yes ___ No ___

- 4. If your spouse or any minor children are currently appointed to or employed by any agency of the State of Illinois, and his/her annual salary exceeds \$102,600.00, (60% of the Governor's salary as of 7/1/07) are you and your spouse or any minor children entitled to receive (i) more than 15% in the aggregate of the total distributable income from your firm, partnership, association or corporation, or (ii) an amount in excess of 2 times the salary of the Governor? Yes ___ No ___

(c) Elective status; the holding of elective office of the State of Illinois, the government of the United States, any unit of local government authorized by the Constitution of the State of Illinois or the statutes of the State of Illinois currently or in the previous 3 years.

Yes ___ No ___

(d) Relationship to anyone holding elective office currently or in the previous 2 years; spouse, father, mother, son, or daughter.

Yes ___ No ___

(e) Appointive office; the holding of any appointive government office of the State of Illinois, the United State of America, or any unit of local government authorized by the Constitution of the State of Illinois or the statutes of the State of Illinois, which office entitles the holder to compensation in excess of the expenses incurred in the discharge of that office currently or in the previous 3 years.

Yes ___ No ___

(f) Relationship to anyone holding appointive office currently or in the previous 2 years; spouse, father, mother, son, or daughter.

Yes ___ No ___

(g) Employment, currently or in the previous 3 years, as or by any registered lobbyist of the State government.

Yes ___ No ___

RETURN WITH BID/OFFER

(h) Relationship to anyone who is or was a registered lobbyist in the previous 2 years; spouse, father, mother, son, or daughter. Yes ___ No ___

(i) Compensated employment, currently or in the previous 3 years, by any registered election or reelection committee registered with the Secretary of State or any county clerk of the State of Illinois, or any political action committee registered with either the Secretary of State or the Federal Board of Elections. Yes ___ No ___

(j) Relationship to anyone; spouse, father, mother, son, or daughter; who was a compensated employee in the last 2 years by any registered election or re-election committee registered with the Secretary of State or any county clerk of the State of Illinois, or any political action committee registered with either the Secretary of State or the Federal Board of Elections. Yes ___ No ___

APPLICABLE STATEMENT

This Disclosure Form A is submitted on behalf of the INDIVIDUAL named on previous page.

Completed by: _____
Signature of Individual or Authorized Representative Date

NOT APPLICABLE STATEMENT

I have determined that no individuals associated with this organization meet the criteria that would require the completion of this Form A.

This Disclosure Form A is submitted on behalf of the CONTRACTOR listed on the previous page.

Signature of Authorized Representative Date

RETURN WITH BID/OFFER

**ILLINOIS DEPARTMENT
OF TRANSPORTATION**

**Form B
Other Contracts &
Procurement Related Information
Disclosure**

Contractor Name		
Legal Address		
City, State, Zip		
Telephone Number	Email Address	Fax Number (if available)

Disclosure of the information contained in this Form is required by the Section 50-35 of the Illinois Procurement Act (30 ILCS 500). This information shall become part of the publicly available contract file. This Form B must be completed for bids in excess of \$10,000, and for all open-ended contracts.

DISCLOSURE OF OTHER CONTRACTS AND PROCUREMENT RELATED INFORMATION

1. Identifying Other Contracts & Procurement Related Information. The BIDDER shall identify whether it has any pending contracts (including leases), bids, proposals, or other ongoing procurement relationship with any other State of Illinois agency: Yes ___ No ___

If "No" is checked, the bidder only needs to complete the signature box on the bottom of this page.

2. If "Yes" is checked. Identify each such relationship by showing State of Illinois agency name and other descriptive information such as bid or project number (attach additional pages as necessary). SEE DISCLOSURE FORM INSTRUCTIONS:

THE FOLLOWING STATEMENT MUST BE CHECKED

<input type="checkbox"/>	_____	_____
	Signature of Authorized Representative	Date

RETURN WITH BID

SPECIAL NOTICE TO CONTRACTORS

The following requirements of the Illinois Department of Human Rights' Rules and Regulations are applicable to bidders on all construction contracts advertised by the Illinois Department of Transportation:

CONSTRUCTION EMPLOYEE UTILIZATION PROJECTION

- (a) All bidders on construction contracts shall complete and submit, along with and as part of their bids, a Bidder's Employee Utilization Form (Form BC-1256) setting forth a projection and breakdown of the total workforce intended to be hired and/or allocated to such contract work by the bidder including a projection of minority and female employee utilization in all job classifications on the contract project.
- (b) The Department of Transportation shall review the Employee Utilization Form, and workforce projections contained therein, of the contract awardee to determine if such projections reflect an underutilization of minority persons and/or women in any job classification in accordance with the Equal Employment Opportunity Clause and Section 7.2 of the Illinois Department of Human Rights' Rules and Regulations for Public Contracts adopted as amended on September 17, 1980. If it is determined that the contract awardee's projections reflect an underutilization of minority persons and/or women in any job classification, it shall be advised in writing of the manner in which it is underutilizing and such awardee shall be considered to be in breach of the contract unless, prior to commencement of work on the contract project, it submits revised satisfactory projections or an acceptable written affirmative action plan to correct such underutilization including a specific timetable geared to the completion stages of the contract.
- (c) The Department of Transportation shall provide to the Department of Human Rights a copy of the contract awardee's Employee Utilization Form, a copy of any required written affirmative action plan, and any written correspondence related thereto. The Department of Human Rights may review and revise any action taken by the Department of Transportation with respect to these requirements.

RETURN WITH BID

**Contract No. 99326
WILLIAMSON County
Section 07-00118-00-SP
Project HRR-0199(031)
Route FAS 905 (CH 18)
District 9 Construction Funds**

PART II. WORKFORCE PROJECTION - continued

- B. Included in "Total Employees" under Table A is the total number of **new hires** that would be employed in the event the undersigned bidder is awarded this contract.

The undersigned bidder projects that: (number) _____ new hires would be recruited from the area in which the contract project is located; and/or (number) _____ new hires would be recruited from the area in which the bidder's principal office or base of operation is located.

- C. Included in "Total Employees" under Table A is a projection of numbers of persons to be employed directly by the undersigned bidder as well as a projection of numbers of persons to be employed by subcontractors.

The undersigned bidder estimates that (number) _____ persons will be directly employed by the prime contractor and that (number) _____ persons will be employed by subcontractors.

PART III. AFFIRMATIVE ACTION PLAN

- A. The undersigned bidder understands and agrees that in the event the foregoing minority and female employee utilization projection included under **PART II** is determined to be an underutilization of minority persons or women in any job category, and in the event that the undersigned bidder is awarded this contract, he/she will, prior to commencement of work, develop and submit a written Affirmative Action Plan including a specific timetable (geared to the completion stages of the contract) whereby deficiencies in minority and/or female employee utilization are corrected. Such Affirmative Action Plan will be subject to approval by the contracting agency and the **Department of Human Rights**.
- B. The undersigned bidder understands and agrees that the minority and female employee utilization projection submitted herein, and the goals and timetable included under an Affirmative Action Plan if required, are deemed to be part of the contract specifications.

Company _____ Telephone Number _____

Address _____

NOTICE REGARDING SIGNATURE

The Bidder's signature on the Proposal Signature Sheet will constitute the signing of this form. The following signature block needs to be completed only if revisions are required.

Signature: _____ Title: _____ Date: _____

Instructions: All tables must include subcontractor personnel in addition to prime contractor personnel.

Table A - Include both the number of employees that would be hired to perform the contract work and the total number currently employed (Table B) that will be allocated to contract work, and include all apprentices and on-the-job trainees. The "Total Employees" column should include all employees including all minorities, apprentices and on-the-job trainees to be employed on the contract work.

Table B - Include all employees currently employed that will be allocated to the contract work including any apprentices and on-the-job trainees currently employed.

Table C - Indicate the racial breakdown of the total apprentices and on-the-job trainees shown in Table A.

RETURN WITH BID

ADDITIONAL FEDERAL REQUIREMENTS

In addition to the Required Contract Provisions for Federal-Aid Construction Contracts (FHWA 1273), all bidders make the following certifications.

- A. By the execution of this proposal, the signing bidder certifies that the bidding entity has not, either directly or indirectly, entered into any agreement, participated in any collusion, or otherwise taken any action, in restraint of free competitive bidding in connection with the submitted bid. This statement made by the undersigned bidder is true and correct under penalty of perjury under the laws of the United States.
- B. CERTIFICATION, EQUAL EMPLOYMENT OPPORTUNITY:
1. Have you participated in any previous contracts or subcontracts subject to the equal opportunity clause. YES _____ NO _____
 2. If answer to #1 is yes, have you filed with the Joint Reporting Committee, the Director of OFCC, any Federal agency, or the former President's Committee on Equal Employment Opportunity, all reports due under the applicable filing requirements of those organizations? YES _____ NO _____

RETURN WITH BID

**Contract No. 99326
WILLIAMSON County
Section 07-00118-00-SP
Project HRR-0199(031)
Route FAS 905 (CH 18)
District 9 Construction Funds**

PROPOSAL SIGNATURE SHEET

The undersigned bidder hereby makes and submits this bid on the subject Proposal, thereby assuring the Department that all requirements of the Invitation for Bids and rules of the Department have been met, that there is no misunderstanding of the requirements of paragraph 3 of this Proposal, and that the contract will be executed in accordance with the rules of the Department if an award is made on this bid.

(IF AN INDIVIDUAL) Firm Name _____
Signature of Owner _____
Business Address _____

(IF A CO-PARTNERSHIP) Firm Name _____
By _____
Business Address _____
Name and Address of All Members of the Firm: _____

(IF A CORPORATION) Corporate Name _____
By _____
Signature of Authorized Representative _____
Typed or printed name and title of Authorized Representative _____

(IF A JOINT VENTURE, USE THIS SECTION FOR THE MANAGING PARTY AND THE SECOND PARTY SHOULD SIGN BELOW) Attest _____
Signature _____
Business Address _____

(IF A JOINT VENTURE) Corporate Name _____
By _____
Signature of Authorized Representative _____
Typed or printed name and title of Authorized Representative _____

Attest _____
Signature _____
Business Address _____

If more than two parties are in the joint venture, please attach an additional signature sheet.



Return with Bid

Division of Highways
Proposal Bid Bond
(Effective November 1, 1992)

Item No. _____

Letting Date _____

KNOW ALL MEN BY THESE PRESENTS, That We _____

as PRINCIPAL, and _____

_____ as SURETY, are held jointly, severally and firmly bound unto the STATE OF ILLINOIS in the penal sum of 5 percent of the total bid price, or for the amount specified in Article 102.09 of the "Standard Specifications for Road and Bridge Construction" in effect on the date of invitation for bids, whichever is the lesser sum, well and truly to be paid unto said STATE OF ILLINOIS, for the payment of which we bind ourselves, our heirs, executors, administrators, successors and assigns.

THE CONDITION OF THE FOREGOING OBLIGATION IS SUCH, that whereas, the PRINCIPAL has submitted a bid proposal to the STATE OF ILLINOIS, acting through the Department of Transportation, for the improvement designated by the Transportation Bulletin Item Number and Letting Date indicated above.

NOW, THEREFORE, if the Department shall accept the bid proposal of the PRINCIPAL; and if the PRINCIPAL shall, within the time and as specified in the bidding and contract documents, submit a DBE Utilization Plan that is accepted and approved by the Department; and if, after award by the Department, the PRINCIPAL shall enter into a contract in accordance with the terms of the bidding and contract documents including evidence of the required insurance coverages and providing such bond as specified with good and sufficient surety for the faithful performance of such contract and for the prompt payment of labor and material furnished in the prosecution thereof; or if, in the event of the failure of the PRINCIPAL to make the required DBE submission or to enter into such contract and to give the specified bond, the PRINCIPAL pays to the Department the difference not to exceed the penalty hereof between the amount specified in the bid proposal and such larger amount for which the Department may contract with another party to perform the work covered by said bid proposal, then this obligation shall be null and void, otherwise, it shall remain in full force and effect.

IN THE EVENT the Department determines the PRINCIPAL has failed to comply with any requirement as set forth in the preceding paragraph, then Surety shall pay the penal sum to the Department within fifteen (15) days of written demand therefor. If Surety does not make full payment within such period of time, the Department may bring an action to collect the amount owed. Surety is liable to the Department for all its expenses, including attorney's fees, incurred in any litigation in which it prevails either in whole or in part.

In TESTIMONY WHEREOF, the said PRINCIPAL and the said SURETY have caused this instrument to be signed by

their respective officers this _____ day of _____ A.D., _____ .

PRINCIPAL

(Company Name)

(Company Name)

By: _____
(Signature & Title)

By: _____
(Signature of Attorney-in-Fact)

Notary Certification for Principal and Surety

STATE OF ILLINOIS,

County of _____

I, _____, a Notary Public in and for said County, do hereby certify that

_____ and _____
(Insert names of individuals signing on behalf of PRINCIPAL & SURETY)

who are each personally known to me to be the same persons whose names are subscribed to the foregoing instrument on behalf of PRINCIPAL and SURETY, appeared before me this day in person and acknowledged respectively, that they signed and delivered said instrument as their free and voluntary act for the uses and purposes therein set forth.

Given under my hand and notarial seal this _____ day of _____ A.D. _____

My commission expires _____

Notary Public

In lieu of completing the above section of the Proposal Bid Form, the Principal may file an Electronic Bid Bond. By signing the proposal and marking the check box next to the Signature and Title line below, the Principal is ensuring the identified electronic bid bond has been executed and the Principal and Surety are firmly bound unto the State of Illinois under the conditions of the bid bond as shown above.

Electronic Bid Bond ID# _____

Company / Bidder Name _____



Signature and Title _____

PROPOSAL ENVELOPE



PROPOSALS

for construction work advertised for bids by the Illinois Department of Transportation

Item No.	Item No.	Item No.

Submitted By:

Name:
Address:
Phone No.

Bidders should use an IDOT proposal envelope or affix this form to the front of a 10" x 13" envelope for the submittal of bids. If proposals are mailed, they should be enclosed in a second or outer envelope addressed to:

Engineer of Design and Environment - Room 326
Illinois Department of Transportation
2300 South Dirksen Parkway
Springfield, Illinois 62764

NOTICE

Individual bids, including Bid Bond and/or supplemental information if required, should be securely stapled.

CONTRACTOR OFFICE COPY OF CONTRACT SPECIFICATIONS

NOTICE

None of the following material needs to be returned with the bid package unless the special provisions require documentation and/or other information to be submitted.

**Contract No. 99326
WILLIAMSON County
Section 07-00118-00-SP
Project HRR-0199(031)
Route FAS 905 (CH 18)
District 9 Construction Funds**



Illinois Department of Transportation



NOTICE TO BIDDERS

- 1. TIME AND PLACE OF OPENING BIDS.** Sealed proposals for the improvement described herein will be received by the Department of Transportation at the Harry R. Hanley Building, 2300 South Dirksen Parkway, in Springfield, Illinois until 10:00 o'clock a.m., August 1, 2008. All bids will be gathered, sorted, publicly opened and read in the auditorium at the Department of Transportation's Harry R. Hanley Building shortly after the 10:00 a.m. cut off time.
- 2. DESCRIPTION OF WORK.** The proposed improvement is identified and advertised for bids in the Invitation for Bids as:

**Contract No. 99326
WILLIAMSON County
Section 07-00118-00-SP
Project HRR-0199(031)
Route FAS 905 (CH 18)
District 9 Construction Funds**

Improvement consists of constructing an 8-inch HMA shoulder with rumble strips, tree removal from within the existing right-of-way, guardrail removal and replacement, signing and pavement marking from Crab Orchard Road south for 8.19 miles to IL Route 166.

- 3. INSTRUCTIONS TO BIDDERS.** (a) This Notice, the invitation for bids, proposal and letter of award shall, together with all other documents in accordance with Article 101.09 of the Standard Specifications for Road and Bridge Construction, become part of the contract. Bidders are cautioned to read and examine carefully all documents, to make all required inspections, and to inquire or seek explanation of the same prior to submission of a bid.

(b) State law, and, if the work is to be paid wholly or in part with Federal-aid funds, Federal law requires the bidder to make various certifications as a part of the proposal and contract. By execution and submission of the proposal, the bidder makes the certification contained therein. A false or fraudulent certification shall, in addition to all other remedies provided by law, be a breach of contract and may result in termination of the contract.
- 4. AWARD CRITERIA AND REJECTION OF BIDS.** This contract will be awarded to the lowest responsive and responsible bidder considering conformity with the terms and conditions established by the Department in the rules, Invitation for Bids and contract documents. The issuance of plans and proposal forms for bidding based upon a prequalification rating shall not be the sole determinant of responsibility. The Department reserves the right to determine responsibility at the time of award, to reject any or all proposals, to readvertise the proposed improvement, and to waive technicalities.

By Order of the
Illinois Department of Transportation

Milton R. Sees, Secretary

BD 351 (Rev. 01/2003)

INDEX
FOR
SUPPLEMENTAL SPECIFICATIONS
AND RECURRING SPECIAL PROVISIONS

Adopted January 1, 2008

This index contains a listing of SUPPLEMENTAL SPECIFICATIONS and frequently used RECURRING SPECIAL PROVISIONS.

ERRATA Standard Specifications for Road and Bridge Construction (Adopted 1-1-07) (Revised 1-1-08)

SUPPLEMENTAL SPECIFICATIONS

<u>Std. Spec. Sec.</u>	<u>Page No.</u>
205 Embankment	1
251 Mulch	2
253 Planting Woody Plants	3
280 Temporary Erosion Control	5
443 Reflective Crack Control Treatment	6
502 Excavation for Structures	9
503 Concrete Structures	10
505 Steel Structures	11
540 Box Culverts	12
633 Removing and Reerecting Guardrail and Terminals	13
672 Sealing Abandoned Water Wells	14
701 Work Zone Traffic Control and Protection	15
838 Breakaway Devices	16
1004 Coarse Aggregates	17
1020 Portland Cement Concrete	18
1022 Concrete Curing Materials	20
1042 Precast Concrete Products	21
1062 Reflective Crack Control System	22
1069 Pole and Tower	24
1081 Materials for Planting	27
1083 Elastomeric Bearings	29
1102 Hot-Mix Asphalt Equipment	30

RECURRING SPECIAL PROVISIONS

The following RECURRING SPECIAL PROVISIONS indicated by an "X" are applicable to this contract and are included by reference:

<u>CHECK SHEET #</u>	<u>PAGE NO.</u>
1 X Additional State Requirements For Federal-Aid Construction Contracts (Eff. 2-1-69) (Rev. 1-1-07)	31
2 X Subletting of Contracts (Federal-Aid Contracts) (Eff. 1-1-88) (Rev. 5-1-93)	33
3 X EEO (Eff. 7-21-78) (Rev. 11-18-80)	34
4 Specific Equal Employment Opportunity Responsibilities Non Federal-Aid Contracts (Eff. 3-20-69) (Rev. 1-1-07)	44
5 Required Provisions - State Contracts (Eff. 4-1-65) (Rev. 1-1-07)	49
6 Reserved	54
7 Reserved	55
8 Haul Road Stream Crossings, Other Temporary Stream Crossings, and In-Stream Work Pads (Eff. 1-2-92) (Rev. 1-1-98)	56
9 Construction Layout Stakes Except for Bridges (Eff. 1-1-99) (Rev. 1-1-07)	57
10 Construction Layout Stakes (Eff. 5-1-93) (Rev. 1-1-07)	60
11 Use of Geotextile Fabric for Railroad Crossing (Eff. 1-1-95) (Rev. 1-1-07)	63
12 Subsealing of Concrete Pavements (Eff. 11-1-84) (Rev. 1-1-07)	65
13 Hot-Mix Asphalt Surface Removal (Cold Milling) (Eff. 11-1-87) (Rev. 1-1-07)	69
14 Pavement and Shoulder Resurfacing (Eff. 2-1-00) (Rev. 1-1-07)	71
15 PCC Partial Depth Hot-Mix Asphalt Patching (Eff. 1-1-98) (Rev. 1-1-07)	72
16 Patching with Hot-Mix Asphalt Overlay Removal (Eff. 10-1-95) (Rev. 1-1-07)	74
17 Polymer Concrete (Eff. 8-1-95) (Rev. 1-1-08)	75
18 PVC Pipeliner (Eff. 4-1-04) (Rev. 1-1-07)	77
19 Pipe Underdrains (Eff. 9-9-87) (Rev. 1-1-07)	78
20 X Guardrail and Barrier Wall Delineation (Eff. 12-15-93) (Rev. 1-1-97)	79
21 Bicycle Racks (Eff. 4-1-94) (Rev. 1-1-07)	83
22 Temporary Modular Glare Screen System (Eff. 1-1-00) (Rev. 1-1-07)	85
23 Temporary Portable Bridge Traffic Signals (Eff. 8-1-03) (Rev. 1-1-07)	87
24 Work Zone Public Information Signs (Eff. 9-1-02) (Rev. 1-1-07)	89
25 Night Time Inspection of Roadway Lighting (Eff. 5-1-96)	90
26 English Substitution of Metric Bolts (Eff. 7-1-96)	91
27 English Substitution of Metric Reinforcement Bars (Eff. 4-1-96) (Rev. 1-1-03)	92
28 Calcium Chloride Accelerator for Portland Cement Concrete (Eff. 1-1-01)	93
29 Quality Control of Concrete Mixtures at the Plant-Single A (Eff. 8-1-00) (Rev. 1-1-04)	94
30 Quality Control of Concrete Mixtures at the Plant-Double A (Eff. 8-1-00) (Rev. 1-1-04)	100
31 Quality Control/Quality Assurance of Concrete Mixtures (Eff. 4-1-92) (Rev. 1-1-07)	108
 LRS 1 Reserved	 121
LRS 2 <input type="checkbox"/> Furnished Excavation (Eff. 1-1-99) (Rev. 1-1-07)	122
LRS 3 <input checked="" type="checkbox"/> Work Zone Traffic Control (Eff. 1-1-99) (Rev. 1-1-07)	123
LRS 4 <input type="checkbox"/> Flaggers in Work Zones (Eff. 1-1-99) (Rev. 1-1-07)	124
LRS 5 <input type="checkbox"/> Contract Claims (Eff. 1-1-02) (Rev. 1-1-07)	125
LRS 6 <input type="checkbox"/> Bidding Requirements and Conditions for Contract Proposals (Eff. 1-1-02)	126
LRS 7 <input type="checkbox"/> Bidding Requirements and Conditions for Material Proposals (Eff. 1-1-02) (Rev. 1-1-03)	132
LRS 8 <input type="checkbox"/> Failure to Complete the Work on Time (Eff. 1-1-99)	138
LRS 9 <input type="checkbox"/> Bituminous Surface Treatments (Eff. 1-1-99)	139
LRS 10 <input type="checkbox"/> Reflective Sheeting Type C (Eff. 1-1-99) (Rev. 1-1-02)	140
LRS 11 <input type="checkbox"/> Employment Practices (Eff. 1-1-99)	141
LRS 12 <input type="checkbox"/> Wages of Employees on Public Works (Eff. 1-1-99) (Rev. 4-1-06)	143
LRS 13 <input type="checkbox"/> Selection of Labor (Eff. 1-1-99)	144
LRS 14 <input type="checkbox"/> Paving Brick and Concrete Paver Pavements and Sidewalks (Eff. 1-1-04) (Rev. 1-1-07)	145
LRS 15 <input type="checkbox"/> Partial Payments (Eff. 1-1-07)	148

07-00118-00-SP

INDEX OF SPECIAL PROVISIONS

	<u>Page No.</u>
References	1
Description of Work.	1
Traffic Control.	1
Tree Removal	2
Tree Pruning	2
Hot Mix Asphalt Shoulders ..	2
Steel Plate Beam Guardrail.	2
Shoulder Rumble Strip	3
Guardrail Removal	3
Sign Panel Type 1	3
Superpave Mix Design	3
Utilities.	3

INDEX LOCAL ROADS AND STREETS SPECIAL PROVISIONS

<u>LR #</u>	<u>Pg #</u>	<u>Special Provision Title</u>	<u>Effective</u>	<u>Revised</u>
LR SD 12		Slab Movement Detection Device	Nov. 11, 1984	Jan. 1, 2007
LR SD 13		Required Cold Milled Surface Texture	Nov. 1, 1987	Jan. 1, 2007
LR 102		Protests on Local Lettings	Jan. 1, 2007	
LR 105	4	X Cooperation with Utilities	Jan. 1, 1999	Jan. 1, 2007
LR 107-2		Railroad Protective Liability Insurance for Local Lettings	Mar. 1, 2005	Jan. 1, 2006
LR 107-3		Disadvantaged Business Enterprise Participation	Jan. 1, 2007	
LR 107-4	7	X Insurance	Feb. 1, 2007	Aug. 1, 2007
LR 108		Combination Bids	Jan. 1, 1994	Mar. 1, 2005
LR 212		Shaping Roadway	Aug. 1, 1969	Jan. 1, 2002
LR 355-1		Asphalt Stabilized Base Course, Road Mix or Traveling Plant Mix	Oct. 1, 1973	Jan. 1, 2007
LR 355-2		Asphalt Stabilized Base Course, Plant Mix	Feb. 2, 1963	Jan. 1, 2007
LR 400-1		Bituminous Treated Earth Surface	Jan. 1, 2008	
LR 400-2		Bituminous Surface Mixture (Class B)	Jan. 1, 2008	
LR 400-3		Pavement Rehabilitation by the Heat-Scarify-Overlay Method	Jan. 1, 2008	
LR 402		Salt Stabilized Surface Course	Feb. 20, 1963	Jan. 1, 2007
LR 403-2		Bituminous Hot Mix Sand Seal Coat	Aug. 1, 1969	Jan. 1, 2007
LR 406		Filling HMA Core Holes with Non-shrink Grout	Jan. 1, 2008	
LR 420		PCC Pavement (Special)	May 12, 1964	Jan. 2, 2007
LR 442		Bituminous Patching Mixtures for Maintenance Use	Jan. 1, 2004	Jun. 1, 2007
LR 451		Crack Filling Bituminous Pavement with Fiber-Asphalt	Oct. 1, 1991	Jan. 1, 2007
LR 503-1		Furnishing Class SI Concrete	Oct. 1, 1973	Jan. 1, 2002
LR 503-2		Furnishing Class SI Concrete (Short Load)	Jan. 1, 1989	Jan. 1, 2002
LR 542		Pipe Culverts, Type _____ (Furnished)	Sep. 1, 1964	Jan. 1, 2007
LR 663		Calcium Chloride Applied	Jun. 1, 1958	Jan. 1, 2007
LR 702		Construction and Maintenance Signs	Jan. 1, 2004	Jun. 1, 2007
LR 1004		Coarse Aggregate for Bituminous Surface Treatment	Jan. 1, 2002	Jan. 1, 2007
LR 1013		Rock Salt (Sodium Chloride)	Aug. 1, 1969	Jan. 1, 2002
LR 1032-1		Penetrating Emulsions	Jan. 1, 2007	Feb. 1, 2007
LR 1032-2		Multigrade Cold Mix Asphalt	Jan. 1, 2007	Feb. 1, 2007
LR 1102		Road Mix or Traveling Plan Mix Equipment	Jan. 1, 2007	

BDE SPECIAL PROVISIONS
For the August 1 and September 19, 2008 Lettings

The following special provisions indicated by an "x" are applicable to this contract. An * indicates a new or revised special provision for the letting.

<u>File Name</u>	<u>Pg#</u>	<u>Special Provision Title</u>	<u>Effective</u>	<u>Revised</u>
80099		Accessible Pedestrian Signals (APS)	April 1, 2003	Jan. 1, 2007
80186		Alkali-Silica Reaction for Cast-in-Place Concrete	Aug. 1, 2007	
80108		Asbestos Bearing Pad Removal	Nov. 1, 2003	
72541		Asbestos Waterproofing Membrane and Asbestos Hot-Mix Asphalt Surface Removal	June 1, 1989	Jan. 2, 2007
80192		Automated Flagger Assistance Device	Jan. 1, 2008	
80173		Bituminous Materials Cost Adjustments	Nov. 2, 2006	Jan. 2, 2007
50261		Building Removal-Case I (Non-Friable and Friable Asbestos)	Sept. 1, 1990	Jan. 1, 2007
50481		Building Removal-Case II (Non-Friable Asbestos)	Sept. 1, 1990	Jan. 1, 2007
50491		Building Removal-Case III (Friable Asbestos)	Sept. 1, 1990	Jan. 1, 2007
50531		Building Removal-Case IV (No Asbestos)	Sept. 1, 1990	Jan. 1, 2007
80166		Cement	Jan. 1, 2007	Nov. 1, 2007
80198		Completion Date (via calendar days)	April 1, 2008	
80199		Completion Date (via calendar days) Plus Working Days	April 1, 2008	
80193		Concrete Barrier	Jan. 1, 2008	
80177		Digital Terrain Modeling for Earthwork Calculations	April 1, 2007	
80029	8	X Disadvantaged Business Enterprise Participation	Sept. 1, 2000	Jan. 1, 2007
80178		Dowel Bars	April 1, 2007	Jan. 1, 2008
80167		Electrical Service Installation – Traffic Signals	Jan. 1, 2007	
* 80179		Engineer's Field Office Type A	April 1, 2007	Aug. 1, 2008
* 80205		Engineer's Field Office Type B	Aug. 1, 2008	
80175		Epoxy Pavement Markings	Jan. 1, 2007	
80189	16	X Equipment Rental Rates	Aug. 2, 2007	Jan. 2, 2008
80180		Erosion and Sediment Control Deficiency Deduction	April 1, 2007	
80169		High Tension Cable Median Barrier	Jan. 1, 2007	
80194		HMA – Hauling on Partially Completed Full-Depth Pavement	Jan. 1, 2008	
80181	18	X Hot-Mix Asphalt – Field Voids in the Mineral Aggregate	April 1, 2007	April 1, 2008
80201	20	X Hot Mix Asphalt – Plant Test Frequency	April 1, 2008	
80202	22	X Hot Mix Asphalt - Transportation	April 1, 2008	
80136		Hot-Mix Asphalt Mixture IL-4.75	Nov. 1, 2004	Jan. 1, 2008
80195		Hot-Mix Asphalt Mixture IL-9.5L	Jan. 1, 2008	
80109		Impact Attenuators	Nov. 1, 2003	Jan. 1, 2007
80110		Impact Attenuators, Temporary	Nov. 1, 2003	Jan. 1, 2007
80196		Mast Arm Assembly and Pole	Jan. 1, 2008	
80045		Material Transfer Device	June 15, 1999	Jan. 1, 2007
80165		Moisture Cured Urethane Paint System	Nov. 1, 2006	Jan. 1, 2007
80082		Multilane Pavement Patching	Nov. 1, 2002	
80129		Notched Wedge Longitudinal Joint	July 1, 2004	Jan. 1, 2007
80182		Notification of Reduced Width	April 1, 2007	
80069		Organic Zinc-Rich Paint System	Nov. 1, 2001	Jan. 1, 2008
80022	23	X Payments to Subcontractors	June 1, 2000	Jan. 1, 2006
80134	25	X Plastic Blockouts for Guardrail	Nov. 1, 2004	Jan. 1, 2007
80119		Polyurea Pavement Marking	April 1, 2004	Jan. 1, 2007
80170		Portland Cement Concrete Plants	Jan. 1, 2007	
80171		Precast Handling Holes	Jan. 1, 2007	
80015		Public Convenience and Safety	Jan. 1, 2000	

<u>File Name</u>	<u>Pg#</u>		<u>Special Provision Title</u>	<u>Effective</u>	<u>Revised</u>
3426I			Railroad Protective Liability Insurance	Dec. 1, 1986	Jan. 1, 2006
80157			Railroad Protective Liability Insurance (5 and 10)	Jan. 1, 2006	
80172	26	X	Reclaimed Asphalt Pavement (RAP)	Jan. 1, 2007	Aug. 1, 2007
80183	32	X	Reflective Sheeting on Channelizing Devices	April 1, 2007	
80151			Reinforcement Bars	Nov. 1, 2005	Jan. 2, 2008
* 80206			Reinforcement Bars – Storage and Protection	Aug. 1, 2008	
80164			Removal and Disposal of Regulated Substances	Aug. 1, 2006	Jan. 1, 2007
80184	33	X	Retroreflective Sheeting, Nonreflective Sheeting, and Translucent Overlay Film for Highway Signs	April 1, 2007	
80131			Seeding	July 1, 2004	Aug. 1, 2007
80152			Self-Consolidating Concrete for Cast-In-Place Construction	Nov. 1, 2005	Jan. 1, 2007
80132			Self-Consolidating Concrete for Precast Products	July 1, 2004	Jan. 1, 2007
80197			Silt Filter Fence	Jan. 1, 2008	
80127			Steel Cost Adjustment	April 2, 2004	April 1, 2007
80203			Steel Inserts and Brackets Cast into Concrete	April 1, 2008	
80153			Steel Plate Beam Guardrail	Nov. 1, 2005	Aug. 1, 2007
80191			Stone Gradation Testing	Nov. 1, 2007	
80143	39	X	Subcontractor Mobilization Payments	April 2, 2005	
80075			Surface Testing of Pavements	April 1, 2002	Jan. 1, 2007
80087			Temporary Erosion Control	Nov. 1, 2002	Jan. 1, 2008
80176			Thermoplastic Pavement Markings	Jan. 1, 2007	
80161			Traffic Signal Grounding	April 1, 2006	Jan. 1, 2007
20338			Training Special Provisions	Oct. 15, 1975	
80185			Type ZZ Retroreflective Sheeting, Nonreflective Sheeting, and Translucent Overlay Film for Highway Signs	April 1, 2007	
80162			Uninterruptable Power Supply (UPS)	April 1, 2006	Jan. 1, 2007
80149			Variable Spaced Tining	Aug. 1, 2005	Jan. 1, 2007
80163			Water Blaster with Vacuum Recovery	April 1, 2006	Jan. 1, 2007
80071	40	X	Working Days	Jan. 1, 2002	
80204			Woven Wire Fence	April 1, 2008	

The following special provisions have been **deleted** from use:

80187 Legal Requirements to be Observed

80190 Engineer's Field Office (Long Distance Bill) This special provision has been replaced by Engineer's Field Office Type A and Engineer's Field Office Type B.

The following special provisions are in the 2008 Supplemental Specifications and Recurring Special Provisions:

<u>File Name</u>	<u>Special Provision Title</u>	<u>New Location</u>	<u>Effective</u>	<u>Revised</u>
80168	Errata for the 2007 Standard Specifications	Supplemental	Jan. 1, 2007	Aug. 1, 2007
80142	Hot-Mix Asphalt Equipment, Spreading and Finishing Machine	Article 1102.3	Jan. 1, 2005	Jan. 1, 2007
80148	Planting Woody Plants	Section 253	Jan. 1, 2006	
80160	Reflective Crack Control Treatment	Section 443, Article 1062.04	April 1, 2006	Jan. 1, 2007
80154	Turf Reinforcement Mat	Section 251	Nov. 1, 2005	Jan. 1, 2007

STATE OF ILLINOIS
SPECIAL PROVISIONS

The following Special Provisions supplement the "Standard Specifications for Road and Bridge Construction", adopted January 1, 2007, the latest edition of the "Illinois Manual on Uniform Traffic Control Devices for Streets and Highways", and the "Manual of Test Procedures for Materials" in effect on the date of invitation for bids, and the "Supplemental Specifications and Recurring Special Provisions" indicated on the Check Sheet included herein which apply to and govern the proposed improvement of CH 12,18, Project HRR-0199(031), Section 07-00118-00-SP in Williamson County and in case of conflict with any part or parts of said specifications, the said Special Provisions shall take precedence and shall govern.

DESCRIPTION OF WORK:

This safety improvement work includes constructing a bituminous concrete shoulder, removing trees from the ROW, and upgrading traffic signs on 8.19 Miles of CH 12,18 (Saraville Road).

TRAFFIC CONTROL:

The contractor will be required to maintain one way traffic during the construction of the proposed improvement. Traffic Control shall be in accordance with the applicable section of the "Standard Specifications", the applicable guidelines in the Illinois Manual on Uniform Traffic Control Devices, these Special Provisions and Highway Standards contained herein. This road is low volume and exempt from requirements regarding temporary no-passing zone pavement markings.

At the preconstruction meeting, the contractor shall furnish the name of the individual in his direct employ who is to be responsible for the installation and maintenance of the traffic control for this project. If the actual installation and maintenance are to be accomplished by a subcontractor, consent shall be requested of the Engineer at the time of the preconstruction meeting in accordance with Article 108.01 of the "Standard Specifications". This shall not relieve the contractor of the foregoing requirement for a responsible individual in his direct employ. The Department will provide the contractor the name of its representative who will be responsible for the administration of the Traffic Control Plan.

Special attention is called to Articles 107.09 and 107.14 of the Standard Specifications and the following Highway Standards: 702001, 701001, 701006, 701011, 701301, 701306, and 701311.

During hours of darkness, lane closures will not be permitted and the contractor will be required to remove all equipment and materials from the roadway.

The cost for the materials, labor, and equipment necessary for Traffic Control in accordance with the above mentioned standards at each location will be included in the contract and no additional compensation will be allowed.

TREE REMOVAL, ACRES:

Tree removal area shall be defined as the area from the edge of pavement out to the ROW line at approximately 8 locations designated by the Engineer. All equipment to be used shall be approved by the Engineer and **no steel-tracked equipment will be allowed on the existing road or shoulders**. Trees shall be sawed off low and **all resulting stumps shall be ground down to 6" below existing grade**. This method will be utilized in order to minimize the impact of the tree removal on the existing ditch line and the adjacent private property.

This work will be paid for at the contract unit price bid per Acre for TREE REMOVAL and no additional compensation will be allowed for the above requirements.

TREE PRUNING:

At the designated locations and any others added by the Engineer, all tree limbs overhanging the road ROW shall be removed. Approved equipment shall be a bucket truck of sufficient size to reach all the limbs which are to be removed from over the ROW.

This work will be paid for at the contract unit price bid per Each for TREE PRUNING (1-10 and Over 10) and no additional compensation will be allowed for the above requirements.

HOT-MIX ASPHALT SHOULDERS, 8":

The bituminous mixture used shall be Hot Mix Asphalt.

The excavation for the bituminous shoulder shall be done with an approved, self-propelled milling machine. The excavated material shall be conveyored to trucks and stockpiled. A portion of the stockpiled material will be used to fill in areas needing a transition wedge between the proposed bituminous concrete shoulder and the existing shoulder as directed by the Engineer. Also, a portion of the excavated material will be used to widen the shoulder between Sta. 125+75 Rt. to 128+12.5 Rt. in order to accommodate the proposed guardrail which is to be installed. This wedge and shoulder widening shall be placed with a self-propelled road widener and compacted to the satisfaction of the Engineer. Any remaining stockpiled material shall be disposed of by the contractor.

This work will be paid for at the contract unit price bid per Sq. Yd. for HOT-MIX ASPHALT SHOULDERS, 8" and no additional compensation will be allowed for the above requirements.

STEEL PLATE BEAM GUARDRAIL:

All guardrail and end sections shall conform to the current 31 7/8 inch height requirement with 12" blockouts. See Standard 630001-07. This note is provided for clarification purposes.

This work will be paid for at the contract unit price bid per Foot for STEEL PLATE BEAM GUARDRAIL and no additional compensation will be allowed for the above requirement.

SHOULDER RUMBLE STRIP:

Shoulder rumble strips shall be constructed as shown on Std. 642001 except that the distance from the edge of pavement to the edge of the rumble strip shall be 4 inches.

This work will be paid for at the contract unit price bid per Foot for SHOULDER RUMBLE STRIP and no additional compensation will be allowed for the above requirement.

GUARDRAIL REMOVAL:

This item shall include removal of all the existing guardrail and end-sections within the project limits. The removed material shall be disassembled and the components stacked on the ROW for salvage by the Williamson County Highway Department.

This work will be paid for at the contract unit price bid per Foot for GUARDRAIL REMOVAL and no additional compensation will be allowed.

SIGN PANEL TYPE 1:

This item includes the removal of the existing signs and sign posts that are being replaced. The existing signs and sign posts shall be disassembled and the components shall be stockpiled at a location designated by the Engineer for salvage by the Williamson County Highway Department.

Sign panels shall be constructed with 3M Diamond Grade VIP Series 3990 sheeting or another manufacturer's equivalent sheeting which meets the reflectivity specification ASTM D 4956-04, Type IX.

This work will be paid for at the contract unit price bid per Square Foot for SIGN PANEL TYPE 1 and no additional compensation will be allowed for the above requirements.

BITUMINOUS CONCRETE MIXTURE REQUIREMENTS:

Location: Hot-Mix Asphalt Shoulders, 8"

Mixture Use: Hot Mix Asphalt

AC/PG: PG64-22

RAP%(Max.): 10

Design Air Voids: 4.0%, 70 Gyration Superpave Design

Mixture Composition: IL-9.5 mm or IL-12.5 mm

(Gradation Mixture)

Friction Aggregate: C Surface

UTILITIES:

Verizon Inc. and Coal Valley Water District have facilities within the limits of the improvement which will require preconstruction location. Arrangements for any needed adjustments will be made by Williamson County at no cost to the Contractor. The contractor is required to call J.U.L.I.E. (800-892-0123) prior to beginning any constructions operations. No additional compensation will be allowed for any delays or inconveniences in the adjustment of the utilities.

State of Illinois
Department of Transportation
Bureau of Local Roads and Streets

SPECIAL PROVISION
FOR
COOPERATION WITH UTILITIES

Effective: January 1, 1999
Revised: January 1, 2007

All references to Sections or Articles in this specification shall be construed to mean specific Section or Article of the Standard Specifications for Road and Bridge Construction, adopted by the Department of Transportation:

Replace Article 105.07 of the Standard Specifications with the following:

"105.07 Cooperation with Utilities. The adjustment of utilities consists of the relocation, removal, replacement, rearrangements, reconstruction, improvement, disconnection, connection, shifting, new installation or altering of an existing utility facility in any manner.

When the plans or special provisions include information pertaining to the location of underground utility facilities, such information represents only the opinion of the Department as to the location of such utilities and is only included for the convenience of the bidder. The Department assumes no responsibility in respect to the sufficiency or the accuracy of the information shown on the plans relative to the location of the underground utility facilities.

Utilities which are to be adjusted shall be adjusted by the utility owner or the owner's representative or by the Contractor as a contract item. Generally, arrangements for adjusting existing utilities will be made by the Department prior to project construction; however, utilities will not necessarily be adjusted in advance of project construction and, in some cases, utilities will not be removed from the proposed construction limits. When utility adjustments must be performed in conjunction with construction, the utility adjustment work will be shown on the plans and/or covered by Special Provisions.

When the Contractor discovers a utility has not been adjusted by the owner or the owner's representative as indicated in the contract documents, or the utility is not shown on the plans or described in the Special Provisions as to be adjusted in conjunction with construction, the Contractor shall not interfere with said utility, and shall take proper precautions to prevent damage or interruption of the utility and shall promptly notify the Engineer of the nature and location of said utility.

All necessary adjustments, as determined by the Engineer, of utilities not shown on the plans or not identified by markers, will be made at no cost to the Contractor except traffic structures, light poles, etc., that are normally located within the proposed construction limits as hereinafter defined will not be adjusted unless required by the proposed improvement.

- (a) Limits of Proposed Construction for Utilities Paralleling the Roadway. For the purpose of this Article, limits of proposed construction for utilities extending in the same longitudinal direction as the roadway, shall be defined as follows:
- (1) The horizontal limits shall be a vertical plane, outside of, parallel to, and 600 mm (2 ft) distant at right angles from the plan or revised slope limits.
- In cases where the limits of excavation for structures are not shown on the plans, the horizontal limits shall be a vertical plane 1.2 m (4 ft) outside the edges of structure footings or the structure where no footings are required.
- (2) The upper vertical limits shall be the regulations governing the roadbed clearance for the specific utility involved.
 - (3) The lower vertical limits shall be the top of the utility at the depth below the proposed grade as prescribed by the governing agency or the limits of excavation, whichever is less.
- (b) Limits of Proposed Construction for Utilities Crossing the Roadway. For the purpose of this Article, limits of proposed construction for utilities crossing the roadway in a generally transverse direction shall be defined as follows:
- (1) Utilities crossing excavations for structures that are normally made by trenching such as sewers, underdrains, etc. and all minor structures such as manholes, inlets, foundations for signs, foundations for traffic signals, etc., the limits shall be the space to be occupied by the proposed permanent construction unless otherwise required by the regulations governing the specific utility involved.
 - (2) For utilities crossing the proposed site of major structures such as bridges, sign trusses, etc., the limits shall be as defined above for utilities extending in the same general direction as the roadway.

The Contractor may make arrangements for adjustment of utilities outside of the limits of proposed construction provided the Contractor furnishes the Department with a signed agreement with the utility owner covering the adjustments to be made. The cost of any adjustments made outside the limits of proposed construction shall be the responsibility of the Contractor unless otherwise provided.

The Contractor shall request all utility owners to field locate their facilities according to Article 107.31. The Engineer may make the request for location from the utility after receipt of notice from the Contractor. On request, the Engineer will make an inspection to verify that the utility company has field located its facilities, but will not assume responsibility for the accuracy of such work. The Contractor shall be responsible for maintaining the excavations or markers provided by the utility owners. This field location procedure may be waived if the utility owner has stated in writing to the Department it is satisfied the construction plans are sufficiently accurate. If the utility owner does not submit such statement to the Department, and they do not field locate their facilities in both horizontal and vertical alignment, the Engineer will authorize the Contractor in writing to proceed to locate the facilities in the most economical and reasonable manner, subject to the approval of the Engineer, and be paid according to Article 109.04.

The Contractor shall coordinate with any planned utility adjustment or new installation and the Contractor shall take all precautions to prevent disturbance or damage to utility facilities. Any failure on the part of the utility owner, or their representative, to proceed with any planned utility adjustment or new installation shall be reported promptly by the Contractor to the Engineer orally and in writing.

The Contractor shall take all necessary precautions for the protection of the utility facilities. The Contractor shall be responsible for any damage or destruction of utility facilities resulting from neglect, misconduct, or omission in the Contractor's manner or method of execution or nonexecution of the work, or caused by defective work or the use of unsatisfactory materials. Whenever any damage or destruction of a utility facility occurs as a result of work performed by the Contractor, the utility company will be immediately notified. The utility company will make arrangements to restore such facility to a condition equal to that existing before any such damage or destruction was done.

It is understood and agreed that the Contractor has considered in the bid all of the permanent and temporary utilities in their present and/or adjusted positions.

No additional compensation will be allowed for any delays, inconvenience, or damage sustained by the Contractor due to any interference from the said utility facilities or the operation of relocating the said utility facilities.

State of Illinois
Department of Transportation
Bureau of Local Roads and Streets

SPECIAL PROVISION
FOR
INSURANCE

Effective: February 1, 2007
Revised: August 1, 2007

All references to Sections or Articles in this specification shall be construed to mean specific Section or Article of the Standard Specifications for Road and Bridge Construction, adopted by the Department of Transportation.

The Contractor shall name the following entities as additional insured under the Contractor's general liability insurance policy in accordance with Article 107.27:

The Williamson County Highway Department officers, employees, and any other personnel contracted by
the Williamson County Highway Department who may perform Resident Engineering duties.

The entities listed above and their officers, employees, and agents shall be indemnified and held harmless in accordance with Article 107.26.

DISADVANTAGED BUSINESS ENTERPRISE PARTICIPATION (DBE)

Effective: September 1, 2000

Revised: January 1, 2007

FEDERAL OBLIGATION. The Department of Transportation, as a recipient of federal financial assistance, is required to take all necessary and reasonable steps to ensure nondiscrimination in the award and administration of contracts. Consequently, the federal regulatory provisions of 49 CFR part 26 apply to this contract concerning the utilization of disadvantaged business enterprises. For the purposes of this Special Provision, a disadvantaged business enterprise (DBE) means a business certified by the Department in accordance with the requirements of 49 CFR part 26 and listed in the DBE Directory or most recent addendum.

STATE OBLIGATION. This Special Provision will also be used by the Department to satisfy the requirements of the Business Enterprise for Minorities, Females, and Persons with Disabilities Act, 30 ILCS 575. When this Special Provision is used to satisfy state law requirements on 100 percent state-funded contracts, the federal government has no involvement in such contracts (not a federal-aid contract) and no responsibility to oversee the implementation of this Special Provision by the Department on those contracts. DBE participation on 100 percent state-funded contracts will not be credited toward fulfilling the Department's annual overall DBE goal required by the US Department of Transportation to comply with the federal DBE program requirements.

CONTRACTOR ASSURANCE. The Contractor makes the following assurance and agrees to include the assurance in each subcontract that the Contractor signs with a subcontractor:

The Contractor, subrecipient, or subcontractor shall not discriminate on the basis of race, color, national origin, or sex in the performance of this contract. The Contractor shall carry out applicable requirements of 49 CFR part 26 in the award and administration of contracts funded in whole or in part with federal or state funds. Failure by the Contractor to carry out these requirements is a material breach of this contract, which may result in the termination of this contract or such other remedy as the recipient deems appropriate.

OVERALL GOAL SET FOR THE DEPARTMENT. As a requirement of compliance with 49 CFR part 26, the Department has set an overall goal for DBE participation in its federally assisted contracts. That goal applies to all federal-aid funds the Department will expend in its federally assisted contracts for the subject reporting fiscal year. The Department is required to make a good faith effort to achieve the overall goal. The dollar amount paid to all approved DBE firms performing work called for in this contract is eligible to be credited toward fulfillment of the Department's overall goal.

CONTRACT GOAL TO BE ACHIEVED BY THE CONTRACTOR. This contract includes a specific DBE utilization goal established by the Department. The goal has been included because the Department has determined that the work of this contract has subcontracting opportunities that may be suitable for performance by DBE companies. This determination is based on an assessment of the type of work, the location of the work, and the availability of

DBE companies to do a part of the work. The assessment indicates that, in the absence of unlawful discrimination, and in an arena of fair and open competition, DBE companies can be expected to perform 6 % of the work. This percentage is set as the DBE participation goal for this contract. Consequently, in addition to the other award criteria established for this contract, the Department will award this contract to a bidder who makes a good faith effort to meet this goal of DBE participation in the performance of the work. A bidder makes a good faith effort for award consideration if either of the following is done in accordance with the procedures set forth in this Special Provision:

- (a) The bidder documents that firmly committed DBE participation has been obtained to meet the goal; or
- (b) The bidder documents that a good faith effort has been made to meet the goal, even though the effort did not succeed in obtaining enough DBE participation to meet the goal.

DBE LOCATOR REFERENCES. Bidders may consult the DBE Directory as a reference source for DBE companies certified by the Department. In addition, the Department maintains a letting and item specific DBE locator information system whereby DBE companies can register their interest in providing quotes on particular bid items advertised for letting. Information concerning DBE companies willing to quote work for particular contracts may be obtained by contacting the Department's Bureau of Small Business Enterprises at telephone number (217)785-4611, or by visiting the Department's web site at www.dot.il.gov.

BIDDING PROCEDURES. Compliance with the bidding procedures of this Special Provision is required prior to the award of the contract and the failure of the as-read low bidder to comply will render the bid not responsive.

- (a) In order to assure the timely award of the contract, the as-read low bidder shall submit a Disadvantaged Business Utilization Plan on Department form SBE 2026 within seven working days after the date of letting. To meet the seven day requirement, the bidder may send the Plan by certified mail or delivery service within the seven working day period. If a question arises concerning the mailing date of a Plan, the mailing date will be established by the U.S. Postal Service postmark on the original certified mail receipt from the U.S. Postal Service or the receipt issued by a delivery service. It is the responsibility of the bidder to ensure that the postmark or receipt date is affixed within the seven working days if the bidder intends to rely upon mailing or delivery to satisfy the submission day requirement. The Plan is to be submitted to the Department of Transportation, Bureau of Small Business Enterprises, Contract Compliance Section, 2300 South Dirksen Parkway, Room 319, Springfield, Illinois 62764 (Telefax: (217)785-1524). It is the responsibility of the bidder to obtain confirmation of telefax delivery. The Department will not accept a Utilization Plan if it does not meet the seven day submittal requirement and the bid will be declared not responsive. In the event the bid is declared not responsive due to a failure to submit a Plan or failure to comply with the bidding procedures set forth herein, the Department may elect to cause the forfeiture of the penal sum of the bidder's proposal guaranty, and may deny authorization to bid the

project if re-advertised for bids. The Department reserves the right to invite any other bidder to submit a Utilization Plan at any time for award consideration or to extend the time for award.

- (b) The Utilization Plan shall indicate that the bidder either has obtained sufficient DBE participation commitments to meet the contract goal or has not obtained enough DBE participation commitments in spite of a good faith effort to meet the goal. The Utilization Plan shall further provide the name, telephone number, and telefax number of a responsible official of the bidder designated for purposes of notification of plan approval or disapproval under the procedures of this Special Provision.
- (c) The Utilization Plan shall include a DBE Participation Commitment Statement, Department form SBE 2025, for each DBE proposed for the performance of work to achieve the contract goal. The signatures on these forms must be original signatures. All elements of information indicated on the said form shall be provided, including but not limited to the following:
 - (1) The name and address of each DBE to be used;
 - (2) A description, including pay item numbers, of the commercially useful work to be done by each DBE;
 - (3) The price to be paid to each DBE for the identified work specifically stating the quantity, unit price, and total subcontract price for the work to be completed by the DBE. If partial pay items are to be performed by the DBE, indicate the portion of each item, a unit price where appropriate and the subcontract price amount;
 - (4) A commitment statement signed by the bidder and each DBE evidencing availability and intent to perform commercially useful work on the project; and
 - (5) If the bidder is a joint venture comprised of DBE firms and non-DBE firms, the plan must also include a clear identification of the portion of the work to be performed by the DBE partner(s).
- (d) The contract will not be awarded until the Utilization Plan submitted by the bidder is approved. The Utilization Plan will be approved by the Department if the Plan commits sufficient commercially useful DBE work performance to meet the contract goal. The Utilization Plan will not be approved by the Department if the Plan does not commit sufficient DBE performance to meet the contract goal unless the bidder documents that it made a good faith effort to meet the goal. The good faith procedures of Section VIII of this special provision apply. If the Utilization Plan is not approved because it is deficient in a technical matter, unless waived by the Department, the bidder will be notified and will be allowed no less than a five working day period in order to cure the deficiency.

CALCULATING DBE PARTICIPATION. The Utilization Plan values represent work anticipated to be performed and paid for upon satisfactory completion. The Department is only able to

count toward the achievement of the overall goal and the contract goal the value of payments made for the work actually performed by DBE companies. In addition, a DBE must perform a commercially useful function on the contract to be counted. A commercially useful function is generally performed when the DBE is responsible for the work and is carrying out its responsibilities by actually performing, managing, and supervising the work involved. The Department and Contractor are governed by the provisions of 49 CFR part 26.55(c) on questions of commercially useful functions as it affects the work. Specific counting guidelines are provided in 49 CFR part 26.55, the provisions of which govern over the summary contained herein.

- (a) DBE as the Contractor: 100 percent goal credit for that portion of the work performed by the DBE's own forces, including the cost of materials and supplies. Work that a DBE subcontracts to a non-DBE firm does not count toward the DBE goals.
- (b) DBE as a joint venture Contractor: 100 percent goal credit for that portion of the total dollar value of the contract equal to the distinct, clearly defined portion of the work performed by the DBE's own forces.
- (c) DBE as a subcontractor: 100 percent goal credit for the work of the subcontract performed by the DBE's own forces, including the cost of materials and supplies, excluding the purchase of materials and supplies or the lease of equipment by the DBE subcontractor from the prime Contractor or its affiliates. Work that a DBE subcontractor in turn subcontracts to a non-DBE firm does not count toward the DBE goal.
- (d) DBE as a trucker: 100 percent goal credit for trucking participation provided the DBE is responsible for the management and supervision of the entire trucking operation for which it is responsible. At least one truck owned, operated, licensed, and insured by the DBE must be used on the contract. Credit will be given for the full value of all such DBE trucks operated using DBE employed drivers. Goal credit will be limited to the value of the reasonable fee or commission received by the DBE if trucks are leased from a non-DBE company.
- (e) DBE as a material supplier:
 - (1) 60 percent goal credit for the cost of the materials or supplies purchased from a DBE regular dealer.
 - (2) 100 percent goal credit for the cost of materials or supplies obtained from a DBE manufacturer.
 - (3) 100 percent credit for the value of reasonable fees and commissions for the procurement of materials and supplies if not a regular dealer or manufacturer.

GOOD FAITH EFFORT PROCEDURES. If the bidder cannot obtain sufficient DBE commitments to meet the contract goal, the bidder must document in the Utilization Plan the good faith efforts made in the attempt to meet the goal. This means that the bidder must show

that all necessary and reasonable steps were taken to achieve the contract goal. Necessary and reasonable steps are those which could reasonably be expected to obtain sufficient DBE participation. The Department will consider the quality, quantity, and intensity of the kinds of efforts that the bidder has made. Mere *pro forma* efforts are not good faith efforts; rather, the bidder is expected to have taken those efforts that would be reasonably expected of a bidder actively and aggressively trying to obtain DBE participation sufficient to meet the contract goal.

(a) The following is a list of types of action that the Department will consider as part of the evaluation of the bidder's good faith efforts to obtain participation. These listed factors are not intended to be a mandatory checklist and are not intended to be exhaustive. Other factors or efforts brought to the attention of the Department may be relevant in appropriate cases, and will be considered by the Department.

(1) Soliciting through all reasonable and available means (e.g. attendance at pre-bid meetings, advertising and/or written notices) the interest of all certified DBE companies that have the capability to perform the work of the contract. The bidder must solicit this interest within sufficient time to allow the DBE companies to respond to the solicitation. The bidder must determine with certainty if the DBE companies are interested by taking appropriate steps to follow up initial solicitations.

(2) Selecting portions of the work to be performed by DBE companies in order to increase the likelihood that the DBE goals will be achieved. This includes, where appropriate, breaking out contract work items into economically feasible units to facilitate DBE participation, even when the prime Contractor might otherwise prefer to perform these work items with its own forces.

(3) Providing interested DBE companies with adequate information about the plans, specifications, and requirements of the contract in a timely manner to assist them in responding to a solicitation.

(4) a. Negotiating in good faith with interested DBE companies. It is the bidder's responsibility to make a portion of the work available to DBE subcontractors and suppliers and to select those portions of the work or material needs consistent with the available DBE subcontractors and suppliers, so as to facilitate DBE participation. Evidence of such negotiation includes the names, addresses, and telephone numbers of DBE companies that were considered; a description of the information provided regarding the plans and specifications for the work selected for subcontracting; and evidence as to why additional agreements could not be reached for DBE companies to perform the work.

b. A bidder using good business judgment would consider a number of factors in negotiating with subcontractors, including DBE subcontractors, and would take a firm's price and capabilities as well as contract goals into consideration. However, the fact that there may be some additional costs involved in finding and using DBE companies is not in itself sufficient reason for a bidder's failure to meet the contract DBE goal, as long as such costs are reasonable. Also, the

ability or desire of a bidder to perform the work of a contract with its own organization does not relieve the bidder of the responsibility to make good faith efforts. Bidders are not, however, required to accept higher quotes from DBE companies if the price difference is excessive or unreasonable.

- (5) Not rejecting DBE companies as being unqualified without sound reasons based on a thorough investigation of their capabilities. The bidder's standing within its industry, membership in specific groups, organizations, or associations and political or social affiliations (for example union vs. non-union employee status) are not legitimate causes for the rejection or non-solicitation of bids in the bidder's efforts to meet the project goal.
 - (6) Making efforts to assist interested DBE companies in obtaining bonding, lines of credit, or insurance as required by the recipient or Contractor.
 - (7) Making efforts to assist interested DBE companies in obtaining necessary equipment, supplies, materials, or related assistance or services.
 - (8) Effectively using the services of available minority/women community organizations; minority/women contractors' groups; local, state, and federal minority/women business assistance offices; and other organizations as allowed on a case-by-case basis to provide assistance in the recruitment and placement of DBE companies.
- (b) If the Department determines that the bidder has made a good faith effort to secure the work commitment of DBE companies to meet the contract goal, the Department will award the contract provided that it is otherwise eligible for award. If the Department determines that a good faith effort has not been made, the Department will notify the bidder of that preliminary determination by contacting the responsible company official designated in the Utilization Plan. The preliminary determination shall include a statement of reasons why good faith efforts have not been found, and may include additional good faith efforts that the bidder could take. The notification will designate a five working day period during which the bidder shall take additional efforts. The bidder is not limited by a statement of additional efforts, but may take other action beyond any stated additional efforts in order to obtain additional DBE commitments. The bidder shall submit an amended Utilization Plan if additional DBE commitments to meet the contract goal are secured. If additional DBE commitments sufficient to meet the contract goal are not secured, the bidder shall report the final good faith efforts made in the time allotted. All additional efforts taken by the bidder will be considered as part of the bidder's good faith efforts. If the bidder is not able to meet the goal after taking additional efforts, the Department will make a pre-final determination of the good faith efforts of the bidder and will notify the designated responsible company official of the reasons for an adverse determination.
- (c) The bidder may request administrative reconsideration of a pre-final determination adverse to the bidder within the five working days after the notification date of the determination by delivering the request to the Department of Transportation, Bureau of

Small Business Enterprises, Contract Compliance Section, 2300 South Dirksen Parkway, Room 319, Springfield, Illinois 62764 (Telefax: (217)785-1524). Deposit of the request in the United States mail on or before the fifth business day shall not be deemed delivery. The pre-final determination shall become final if a request is not made and delivered. A request may provide additional written documentation and/or argument concerning the issue of whether an adequate good faith effort was made to meet the contract goal. In addition, the request shall be considered a consent by the bidder to extend the time for award. The request will be forwarded to the Department's Reconsideration Officer. The Reconsideration Officer will extend an opportunity to the bidder to meet in person in order to consider all issues of whether the bidder made a good faith effort to meet the goal. After the review by the Reconsideration Officer, the bidder will be sent a written decision within ten working days after receipt of the request for reconsideration, explaining the basis for finding that the bidder did or did not meet the goal or make adequate good faith efforts to do so. A final decision by the Reconsideration Officer that a good faith effort was made shall approve the Utilization Plan submitted by the bidder and shall clear the contract for award. A final decision that a good faith effort was not made shall render the bid not responsive.

CONTRACT COMPLIANCE. Compliance with this Special Provision is an essential part of the contract. The Department is prohibited by federal regulations from crediting the participation of a DBE included in the Utilization Plan toward either the contract goal or the Department's overall goal until the amount to be applied toward the goals has been paid to the DBE. The following administrative procedures and remedies govern the compliance by the Contractor with the contractual obligations established by the Utilization Plan. After approval of the Plan and award of the contract, the Utilization Plan and individual DBE Participation Statements become part of the contract. If the Contractor did not succeed in obtaining enough DBE participation to achieve the advertised contract goal, and the Utilization Plan was approved and contract awarded based upon a determination of good faith, the total dollar value of DBE work calculated in the approved Utilization Plan as a percentage of the awarded contract value shall become the amended contract goal.

- (a) No amendment to the Utilization Plan may be made without prior written approval from the Department's Bureau of Small Business Enterprises. All requests for amendment to the Utilization Plan shall be submitted to the Department of Transportation, Bureau of Small Business Enterprises, Contract Compliance Section, 2300 South Dirksen Parkway, Room 319, Springfield, Illinois 62764. Telephone number (217) 785-4611. Telefax number (217) 785-1524.
- (b) All work indicated for performance by an approved DBE shall be performed, managed, and supervised by the DBE executing the Participation Statement. The Contractor shall not terminate for convenience a DBE listed in the Utilization Plan and then perform the work of the terminated DBE with its own forces, those of an affiliate or those of another subcontractor, whether DBE or not, without first obtaining the written consent of the Bureau of Small Business Enterprises to amend the Utilization Plan. If a DBE listed in the Utilization Plan is terminated for reasons other than convenience, or fails to complete its work on the contract for any reason, the Contractor shall make good faith efforts to

find another DBE to substitute for the terminated DBE. The good faith efforts shall be directed at finding another DBE to perform at least the same amount of work under the contract as the DBE that was terminated, but only to the extent needed to meet the contract goal or the amended contract goal. The Contractor shall notify the Bureau of Small Business Enterprises of any termination for reasons other than convenience, and shall obtain approval for inclusion of the substitute DBE in the Utilization Plan. If good faith efforts following a termination of a DBE for cause are not successful, the Contractor shall contact the Bureau and provide a full accounting of the efforts undertaken to obtain substitute DBE participation. The Bureau will evaluate the good faith efforts in light of all circumstances surrounding the performance status of the contract, and determine whether the contract goal should be amended.

- (c) The Contractor shall maintain a record of payments for work performed to the DBE participants. The records shall be made available to the Department for inspection upon request. After the performance of the final item of work or delivery of material by a DBE and final payment therefor to the DBE by the Contractor, but not later than thirty calendar days after payment has been made by the Department to the Contractor for such work or material, the Contractor shall submit a DBE Payment Report on Department form SBE 2115 to the Regional Engineer. If full and final payment has not been made to the DBE, the Report shall indicate whether a disagreement as to the payment required exists between the Contractor and the DBE or if the Contractor believes that the work has not been satisfactorily completed. If the Contractor does not have the full amount of work indicated in the Utilization Plan performed by the DBE companies indicated in the Plan, the Department will deduct from contract payments to the Contractor the amount of the goal not achieved as liquidated and ascertained damages.
- (d) The Department reserves the right to withhold payment to the Contractor to enforce the provisions of this Special Provision. Final payment shall not be made on the contract until such time as the Contractor submits sufficient documentation demonstrating achievement of the goal in accordance with this Special Provision or after liquidated damages have been determined and collected.
- (e) Notwithstanding any other provision of the contract, including but not limited to Article 109.09 of the Standard Specifications, the Contractor may request administrative reconsideration of a decision to deduct the amount of the goal not achieved as liquidated damages. A request to reconsider shall be delivered to the Contract Compliance Section and shall be handled and considered in the same manner as set forth in paragraph (c) of "Good Faith Effort Procedures" of this Special Provision, except a final decision that a good faith effort was not made during contract performance to achieve the goal agreed to in the Utilization Plan shall be the final administrative decision of the Department.

EQUIPMENT RENTAL RATES (BDE)

Effective: August 2, 2007

Revised: January 2, 2008

Replace the second and third paragraphs of Article 105.07(b)(4)a. of the Standard Specifications with the following:

"Equipment idled which cannot be used on other work, and which is authorized to standby on the project site by the Engineer, will be paid for according to Article 109.04(b)(4)."

Replace Article 109.04(b)(4) of the Standard Specifications with the following:

"(4) Equipment. Equipment used for extra work shall be authorized by the Engineer. The equipment shall be specifically described, be of suitable size and capacity for the work to be performed, and be in good operating condition. For such equipment, the Contractor will be paid as follows.

- a. Contractor Owned Equipment. Contractor owned equipment will be paid for by the hour using the applicable FHWA hourly rate from the "Equipment Watch Rental Rate Blue Book" (Blue Book) in effect when the force account work begins. The FHWA hourly rate is calculated as follows.

FHWA hourly rate = (monthly rate/176) x (model year adj.) x (Illinois adj.) + EOC

Where: EOC = Estimated Operating Costs per hour (from the Blue Book)

The time allowed will be the actual time the equipment is operating on the extra work. For the time required to move the equipment to and from the site of the extra work and any authorized idle (standby) time, payment will be made at the following hourly rate: $0.5 \times (\text{FHWA hourly rate} - \text{EOC})$.

All time allowed shall fall within the working hours authorized for the extra work.

The rates above include the cost of fuel, oil, lubrication, supplies, small tools, necessary attachments, repairs, overhaul and maintenance of any kind, depreciation, storage, overhead, profits, insurance, and all incidentals. The rates do not include labor.

The Contractor shall submit to the Engineer sufficient information for each piece of equipment and its attachments to enable the Engineer to determine the proper equipment category. If a rate is not established in the Blue Book for a particular piece of equipment, the Engineer will establish a rate for that piece of equipment that is consistent with its cost and use in the industry.

- b. Rented Equipment. Whenever it is necessary for the Contractor to rent equipment to perform extra work, the rental and transportation costs of the equipment plus five percent for overhead will be paid. In no case shall the rental rates exceed those of established distributors or equipment rental agencies.

All prices shall be agreed to in writing before the equipment is used."

80189

HOT-MIX ASPHALT - FIELD VOIDS IN THE MINERAL AGGREGATE (BDE)

Effective: April 1, 2007

Revised: April 1, 2008

Add the following to the table in Article 1030.05(d)(2)a. of the Standard Specifications:

"Parameter	Frequency of Tests	Frequency of Tests	Test Method See Manual of Test Procedures for Materials
	High ESAL Mixture Low ESAL Mixture	All Other Mixtures	
VMA	Day's production ≥ 1200 tons:	N/A	Illinois-Modified AASHTO R 35
Note 5.	1 per half day of production		
	Day's production < 1200 tons:		
	1 per half day of production for first 2 days and 1 per day thereafter (first sample of the day)		

Note 5. The G_{sb} used in the voids in the mineral aggregate (VMA) calculation shall be the same average G_{sb} value listed in the mix design."

Add the following to the Control Limits table in Article 1030.05(d)(4) of the Standard Specifications:

"CONTROL LIMITS			
Parameter	High ESAL Low ESAL	High ESAL Low ESAL	All Other
	Individual Test	Moving Avg. of 4	Individual Test
VMA	-0.7 % ^{2/}	-0.5 % ^{2/}	N/A

^{2/} Allowable limit below minimum design VMA requirement"

Add the following to the table in Article 1030.05(d)(5) of the Standard Specifications:

"CONTROL CHART REQUIREMENTS	High ESAL Low ESAL	All Other
	VMA"	

Revise the heading of Article 1030.05(d)(6)a.1. of the Standard Specifications to read:

"1. Voids, VMA, and Asphalt Binder Content."

Revise the first sentence of the first paragraph of Article 1030.05(d)(6)a.1.(a.) of the Standard Specifications to read:

"If the retest for voids, VMA, or asphalt binder content exceeds control limits, HMA production shall cease and immediate corrective action shall be instituted by the Contractor."

Revise the table in Article 1030.05(e) of the Standard Specifications to read:

"Test Parameter	Acceptable Limits of Precision
% Passing: ^{1/}	
1/2 in. (12.5 mm)	5.0 %
No. 4 (4.75 mm)	5.0 %
No. 8 (2.36 mm)	3.0 %
No. 30 (600 μm)	2.0 %
Total Dust Content No. 200 (75 μm) ^{1/}	2.2 %
Asphalt Binder Content	0.3 %
Maximum Specific Gravity of Mixture	0.026
Bulk Specific Gravity	0.030
VMA	1.4 %
Density (% Compaction)	1.0 % (Correlated)

^{1/} Based on washed ignition."

80181

HOT-MIX ASPHALT – PLANT TEST FREQUENCY (BDE)

Effective: April 1, 2008

Revise the table in Article 1030.05(d)(2)a. of the Standard Specifications to read:

"Parameter	Frequency of Tests	Frequency of Tests All Other Mixtures	Test Method See Manual of Test Procedures for Materials
	High ESAL Mixture Low ESAL Mixture		
<p>Aggregate Gradation</p> <p>Hot bins for batch and continuous plants.</p> <p>Individual cold-feed or combined belt-feed for drier drum plants.</p> <p>% passing sieves: 1/2 in. (12.5 mm), No. 4 (4.75 mm), No. 8 (2.36 mm), No. 30 (600 μm) No. 200 (75 μm)</p> <p>Note 1.</p>	<p>1 dry gradation per day of production (either morning or afternoon sample). and 1 washed ignition oven test on the mix per day of production (conduct in the afternoon if dry gradation is conducted in the morning or vice versa).</p> <p>Note 3. Note 4.</p>	<p>1 gradation per day of production.</p> <p>The first day of production shall be a washed ignition oven test on the mix. Thereafter, the testing shall alternate between dry gradation and washed ignition oven test on the mix.</p> <p>Note 4.</p>	<p>Illinois Procedure</p>
<p>Asphalt Binder Content by Ignition Oven</p> <p>Note 2.</p>	<p>1 per half day of production</p>	<p>1 per day</p>	<p>Illinois-Modified AASHTO T 308</p>
<p>Air Voids</p> <p>Bulk Specific Gravity of Gyrotory Sample</p>	<p>Day's production ≥ 1200 tons: 1 per half day of production</p> <p>Day's production < 1200 tons: 1 per half day of production for first 2 days and 1 per day thereafter (first sample of the day)</p>	<p>1 per day</p>	<p>Illinois-Modified AASHTO T 312</p>

"Parameter	Frequency of Tests	Frequency of Tests All Other Mixtures	Test Method See Manual of Test Procedures for Materials
	High ESAL Mixture Low ESAL Mixture		
Maximum Specific Gravity of Mixture	Day's production \geq 1200 tons: 1 per half day of production	1 per day	Illinois-Modified AASHTO T 209"
	Day's production < 1200 tons: 1 per half day of production for first 2 days and 1 per day thereafter (first sample of the day)		

80201

HOT-MIX ASPHALT – TRANSPORTATION (BDE)

Effective: April 1, 2008

Revise Article 1030.08 of the Standard Specifications to read:

"1030.08 Transportation. Vehicles used in transporting HMA shall have clean and tight beds. The beds shall be sprayed with asphalt release agents from the Department's approved list. In lieu of a release agent, the Contractor may use a light spray of water with a light scatter of manufactured sand (FA 20 or FA 21) evenly distributed over the bed of the vehicle. After spraying, the bed of the vehicle shall be in a completely raised position and it shall remain in this position until all excess asphalt release agent or water has been drained.

When the air temperature is below 60 °F (15 °C), the bed, including the end, endgate, sides and bottom shall be insulated with fiberboard, plywood or other approved insulating material and shall have a thickness of not less than 3/4 in (20 mm). When the insulation is placed inside the bed, the insulation shall be covered with sheet steel approved by the Engineer. Each vehicle shall be equipped with a cover of canvas or other suitable material meeting the approval of the Engineer which shall be used if any one of the following conditions is present.

- (a) Ambient air temperature is below 60 °F (15 °C).
- (b) The weather is inclement.
- (c) The temperature of the HMA immediately behind the paver screed is below 250 °F (120 °C).

The cover shall extend down over the sides and ends of the bed for a distance of approximately 12 in. (300 mm) and shall be fastened securely. The covering shall be rolled back before the load is dumped into the finishing machine."

80202

PAYMENTS TO SUBCONTRACTORS (BDE)

Effective: June 1, 2000

Revised: January 1, 2006

Federal regulations found at 49 CFR §26.29 mandate the Department to establish a contract clause to require Contractors to pay subcontractors for satisfactory performance of their subcontracts and to set the time for such payments.

State law also addresses the timing of payments to be made to subcontractors and material suppliers. Section 7 of the Prompt Payment Act, 30 ILCS 540/7, requires that when a Contractor receives any payment from the Department, the Contractor shall make corresponding, proportional payments to each subcontractor and material supplier performing work or supplying material within 15 calendar days after receipt of the Department payment. Section 7 of the Act further provides that interest in the amount of two percent per month, in addition to the payment due, shall be paid to any subcontractor or material supplier by the Contractor if the payment required by the Act is withheld or delayed without reasonable cause. The Act also provides that the time for payment required and the calculation of any interest due applies to transactions between subcontractors and lower-tier subcontractors and material suppliers throughout the contracting chain.

This Special Provision establishes the required federal contract clause, and adopts the 15 calendar day requirement of the State Prompt Payment Act for purposes of compliance with the federal regulation regarding payments to subcontractors. This contract is subject to the following payment obligations.

When progress payments are made to the Contractor according to Article 109.07 of the Standard Specifications, the Contractor shall make a corresponding payment to each subcontractor and material supplier in proportion to the work satisfactorily completed by each subcontractor and for the material supplied to perform any work of the contract. The proportionate amount of partial payment due to each subcontractor and material supplier throughout the contracting chain shall be determined by the quantities measured or otherwise determined as eligible for payment by the Department and included in the progress payment to the Contractor. Subcontractors and material suppliers shall be paid by the Contractor within 15 calendar days after the receipt of payment from the Department. The Contractor shall not hold retainage from the subcontractors. These obligations shall also apply to any payments made by subcontractors and material suppliers to their subcontractors and material suppliers; and to all payments made to lower tier subcontractors and material suppliers throughout the contracting chain. Any payment or portion of a payment subject to this provision may only be withheld from the subcontractor or material supplier to whom it is due for reasonable cause.

This Special Provision does not create any rights in favor of any subcontractor or material supplier against the State or authorize any cause of action against the State on account of any payment, nonpayment, delayed payment, or interest claimed by application of the State Prompt Payment Act. The Department will not approve any delay or postponement of the 15 day requirement except for reasonable cause shown after notice and hearing pursuant to Section

| 7(b) of the State Prompt Payment Act. State law creates other and additional remedies available to any subcontractor or material supplier, regardless of tier, who has not been paid for work properly performed or material furnished. These remedies are a lien against public funds set forth in Section 23(c) of the Mechanics Lien Act, 770 ILCS 60/23(c), and a recovery on the Contractor's payment bond according to the Public Construction Bond Act, 30 ILCS 550.

80022

PLASTIC BLOCKOUTS FOR GUARDRAIL (BDE)

Effective: November 1, 2004

Revised: January 1, 2007

Add the following to Article 630.02 of the Standard Specifications:

“(g) Plastic Blockouts (Note 1.)

Note 1. Plastic blockouts may be used in lieu of wood blockouts for steel plate beam guardrail. The plastic blockouts shall be the minimum dimensions shown on the plans and shall be on the Department’s approved list.”

80134

RECLAIMED ASPHALT PAVEMENT (RAP) (BDE)

Effective: January 1, 2007

Revised: August 1, 2007

In Article 1030.02(g), delete the last sentence of the first paragraph in (Note 2).

Revise Section 1031 of the Standard Specifications to read:

"SECTION 1031. RECLAIMED ASPHALT PAVEMENT

1031.01 Description. Reclaimed asphalt pavement (RAP) is reclaimed asphalt pavement resulting from cold milling or crushing of an existing dense graded hot-mix asphalt (HMA) pavement. The Contractor shall supply written documentation that the RAP originated from routes or airfields under federal, state, or local agency jurisdiction.

1031.02 Stockpiles. The Contractor shall construct individual, sealed RAP stockpiles meeting one of the following definitions. No additional RAP shall be added to the pile after the pile has been sealed. Stockpiles shall be sufficiently separated to prevent intermingling at the base. Stockpiles shall be identified by signs indicating the type as listed below (i.e. "Homogeneous Surface").

Prior to milling, the Contractor shall request the District to provide verification of the quality of the RAP to clarify appropriate stockpile.

- (a) Homogeneous. Homogeneous RAP stockpiles shall consist of RAP from Class I, Superpave (High ESAL), HMA (High ESAL), or equivalent mixtures and represent:
1) the same aggregate quality, but shall be at least C quality; 2) the same type of crushed aggregate (either crushed natural aggregate, ACBF slag, or steel slag); 3) similar gradation; and 4) similar asphalt binder content. If approved by the Engineer, combined single pass surface/binder millings may be considered "homogenous" with a quality rating dictated by the lowest coarse aggregate quality present in the mixture.
- (b) Conglomerate 5/8. Conglomerate 5/8 RAP stockpiles shall consist of RAP from Class I, Superpave (High ESAL), HMA (High ESAL), or equivalent mixtures. The coarse aggregate in this RAP shall be crushed aggregate and may represent more than one aggregate type and/or quality but shall be at least C quality. This RAP may have an inconsistent gradation and/or asphalt binder content prior to processing. All conglomerate 5/8 RAP shall be processed prior to testing by crushing to where all RAP shall pass the 5/8 in. (16 mm) or smaller screen. Conglomerate 5/8 RAP stockpiles shall not contain steel slag or other expansive material as determined by the Department.
- (c) Conglomerate 3/8. Conglomerate 3/8 RAP stockpiles shall consist of RAP from Class I, Superpave (High ESAL), HMA (High ESAL), or equivalent mixtures. The coarse aggregate in this RAP shall be crushed aggregate and may represent more than one aggregate type and/or quality but shall be at least B quality. This RAP may have an

inconsistent gradation and/or asphalt binder content prior to processing. All conglomerate 3/8 RAP shall be processed prior to testing by crushing to where all RAP shall pass the 3/8 in. (9.5 mm) or smaller screen. Conglomerate 3/8 RAP stockpiles shall not contain steel slag or other expansive material as determined by the Department.

(d) Conglomerate "D" Quality (DQ). Conglomerate DQ RAP stockpiles shall consist of RAP from Class I, Superpave (High or Low ESAL), HMA (High or Low ESAL), or equivalent mixtures. The coarse aggregate in this RAP may be crushed or round but shall be at least D quality. This RAP may have an inconsistent gradation and/or asphalt binder content. Conglomerate DQ RAP stockpiles shall not contain steel slag or other expansive material as determined by the Department.

(e) Non-Quality. RAP stockpiles that do not meet the requirements of the stockpile categories listed above shall be classified as "Non-Quality".

RAP containing contaminants, such as earth, brick, sand, concrete, sheet asphalt, bituminous surface treatment (i.e. chip seal), pavement fabric, joint sealants, etc., will be unacceptable unless the contaminants are removed to the satisfaction of the Engineer. Sheet asphalt shall be stockpiled separately.

1031.03 Testing. When used in HMA, the RAP shall be sampled and tested either during or after stockpiling.

For testing during stockpiling, washed extraction samples shall be run at the minimum frequency of one sample per 500 tons (450 metric tons) for the first 2000 tons (1800 metric tons) and one sample per 2000 tons (1800 metric tons) thereafter. A minimum of five tests shall be required for stockpiles less than 4000 tons (3600 metric tons).

For testing after stockpiling, the Contractor shall submit a plan for approval to the District proposing a satisfactory method of sampling and testing the RAP pile either in-situ or by restockpiling. The sampling plan shall meet the minimum frequency required above and detail the procedure used to obtain representative samples throughout the pile for testing.

Before extraction, each field sample shall be split to obtain two samples of test sample size. One of the two test samples from the final split shall be labeled and stored for Department use. The Contractor shall extract the other test sample according to Department procedure. The Engineer reserves the right to test any sample (split or Department-taken) to verify Contractor test results.

(a) Testing Conglomerate 3/8. In addition to the requirements above, conglomerate 3/8 RAP shall be tested for maximum theoretical specific gravity (G_{mm}) at a frequency of one sample per 500 tons (450 metric tons) for the first 2000 tons (1800 metric tons) and one sample per 2000 tons (1800 metric tons) thereafter. A minimum of five tests shall be required for stockpiles less than 4000 tons (3600 metric tons).

- (b) Evaluation of Test Results. All of the extraction results shall be compiled and averaged for asphalt binder content and gradation and, when applicable G_{mm} . Individual extraction test results, when compared to the averages, will be accepted if within the tolerances listed below.

Parameter	Homogeneous / Conglomerate	Conglomerate "D" Quality
1 in. (25 mm)		± 5 %
1/2 in. (12.5 mm)	± 8 %	± 15 %
No. 4 (4.75 mm)	± 6 %	± 13 %
No. 8 (2.36 mm)	± 5 %	
No. 16 (1.18 mm)		± 15 %
No. 30 (600 μm)	± 5 %	
No. 200 (75 μm)	± 2.0 %	± 4.0 %
Asphalt Binder	± 0.4 % ^{1/}	± 0.5 %
G_{mm}	± 0.02 ^{2/}	

1/ The tolerance for conglomerate 3/8 shall be ± 0.3 %.

2/ Applies only to conglomerate 3/8. When variation of the G_{mm} exceeds the ± 0.02 tolerance, a new conglomerate 3/8 stockpile shall be created which will also require an additional mix design.

If more than 20 percent of the individual sieves are out of the gradation tolerances, or if more than 20 percent of the asphalt binder content test results fall outside the appropriate tolerances, the RAP shall not be used in HMA unless the RAP representing the failing tests is removed from the stockpile. All test data and acceptance ranges shall be sent to the District for evaluation.

With the approval of the Engineer, the ignition oven may be substituted for extractions according to the Illinois Test Procedure, "Calibration of the Ignition Oven for the Purpose of Characterizing Reclaimed Asphalt Pavement (RAP)".

1031.04 Quality Designation of Aggregate in RAP. The quality of the RAP shall be set by the lowest quality of coarse aggregate in the RAP stockpile and are designated as follows.

- (a) RAP from Class I, Superpave (High ESAL), or HMA (High ESAL) surface mixtures are designated as containing Class B quality coarse aggregate.
- (b) RAP from Superpave (Low ESAL)/HMA (Low ESAL) IL-19.0L binder and IL-9.5L surface mixtures are designated as Class D quality coarse aggregate.
- (c) RAP from Class I, Superpave (High ESAL), or HMA (High ESAL) binder mixtures, bituminous base course mixtures, and bituminous base course widening mixtures are designated as containing Class C quality coarse aggregate.

- (d) RAP from bituminous stabilized subbase and BAM shoulders are designated as containing Class D quality coarse aggregate.

1031.05 Use of RAP in HMA. The use of RAP in HMA shall be as follows.

- (a) Coarse Aggregate Size. The coarse aggregate in all RAP shall be equal to or less than the nominal maximum size requirement for the HMA mixture to be produced.
- (b) Steel Slag Stockpiles. RAP stockpiles containing steel slag or other expansive material, as determined by the Department, shall be homogeneous and will be approved for use in HMA (High ESAL and Low ESAL) surface mixtures only.
- (c) Use in HMA Surface Mixtures (High and Low ESAL). RAP stockpiles for use in HMA surface mixtures (High and Low ESAL) shall be either homogeneous or conglomerate 3/8, in which the coarse aggregate is Class B quality or better.
- (d) Use in HMA Binder Mixtures (High and Low ESAL), HMA Base Course, and HMA Base Course Widening. RAP stockpiles for use in HMA binder mixtures (High and Low ESAL), HMA base course, and HMA base course widening shall be homogeneous, conglomerate 5/8, or conglomerate 3/8, in which the coarse aggregate is Class C quality or better.
- (e) Use in Shoulders and Subbase. RAP stockpiles for use in HMA shoulders and stabilized subbase (HMA) shall be homogeneous, conglomerate 5/8, conglomerate 3/8, or conglomerate DQ.
- (f) The use of RAP shall be a contractor's option when constructing HMA in all contracts. When the contractor chooses the RAP option, the percentage of RAP shall not exceed the amounts indicated in the table for a given N Design.

Max RAP Percentage

HMA MIXTURES ^{1/, 3/}	MAXIMUM % RAP		
	Ndesign	Binder/Leveling Binder	Surface
30	30	30	10
50	25	15	10
70	15 / 25 ^{2/}	10 / 15 ^{2/}	10
90	10	10	10
105	10	10	10

1/ For HMA Shoulder and Stabilized Sub-Base (HMA) N-30, the amount of RAP shall not exceed 50% of the mixture.

2/ Value of Max % RAP if 3/8 RAP is utilized.

- 3/ When RAP exceeds 20%, the high & low virgin asphalt binder grades shall each be reduced by one grade (i.e. 25% RAP would require a virgin asphalt binder grade of PG64-22 to be reduced to a PG58-28).

1031.06 HMA Mix Designs. At the Contractor's option, HMA mixtures may be constructed utilizing RAP material meeting the above detailed requirements.

RAP designs shall be submitted for volumetric verification. If additional RAP stockpiles are tested and found that no more than 20 percent of the results, as defined under "Testing" herein, are outside of the control tolerances set for the original RAP stockpile and HMA mix design, and meets all of the requirements herein, the additional RAP stockpiles may be used in the original mix design at the percent previously verified.

1031.07 HMA Production. The coarse aggregate in all RAP used shall be equal to or less than the nominal maximum size requirement for the HMA mixture being produced.

To remove or reduce agglomerated material, a scalping screen, crushing unit, or comparable sizing device approved by the Engineer shall be used in the RAP feed system to remove or reduce oversized material. If material passing the sizing device adversely affects the mix production or quality of the mix, the sizing device shall be set at a size specified by the Engineer.

If the RAP control tolerances or QC/QA test results require corrective action, the Contractor shall cease production of the mixture containing RAP and either switch to the virgin aggregate design or submit a new RAP design. When producing mixtures containing conglomerate 3/8 RAP, a positive dust control system shall be utilized.

HMA plants utilizing RAP shall be capable of automatically recording and printing the following information.

(a) Dryer Drum Plants.

- (1) Date, month, year, and time to the nearest minute for each print.
- (2) HMA mix number assigned by the Department.
- (3) Accumulated weight of dry aggregate (combined or individual) in tons (metric tons) to the nearest 0.1 ton (0.1 metric ton).
- (4) Accumulated dry weight of RAP in tons (metric tons) to the nearest 0.1 ton (0.1 metric ton).
- (5) Accumulated mineral filler in revolutions, tons (metric tons), etc. to the nearest 0.1 unit.

- (6) Accumulated asphalt binder in gallons (liters), tons (metric tons), etc. to the nearest 0.1 unit.
- (7) Residual asphalt binder in the RAP material as a percent of the total mix to the nearest 0.1 percent.
- (8) Aggregate and RAP moisture compensators in percent as set on the control panel. (Required when accumulated or individual aggregate and RAP are printed in wet condition.)

(b) Batch Plants.

- (1) Date, month, year, and time to the nearest minute for each print.
- (2) HMA mix number assigned by the Department.
- (3) Individual virgin aggregate hot bin batch weights to the nearest pound (kilogram).
- (4) Mineral filler weight to the nearest pound (kilogram).
- (5) RAP weight to the nearest pound (kilogram).
- (6) Virgin asphalt binder weight to the nearest pound (kilogram).
- (7) Residual asphalt binder in the RAP material as a percent of the total mix to the nearest 0.1 percent.

The printouts shall be maintained in a file at the plant for a minimum of one year or as directed by the Engineer and shall be made available upon request. The printing system will be inspected by the Engineer prior to production and verified at the beginning of each construction season thereafter.

1031.08 RAP in Aggregate Surface Course and Aggregate Shoulders. The use of RAP in aggregate surface course and aggregate shoulders shall be as follows.

- (a) Stockpiles and Testing. RAP stockpiles may be any of those listed in Article 1031.02, except "Other". The testing requirements of Article 1031.03 shall not apply.
- (b) Gradation. One hundred percent of the RAP material shall pass the 1 1/2 in. (37.5 mm) sieve. The RAP material shall be reasonably well graded from coarse to fine. RAP material that is gap-graded or single sized will not be accepted."

80172

REFLECTIVE SHEETING ON CHANNELIZING DEVICES (BDE)

Effective: April 1, 2007

Revise the seventh paragraph of Article 1106.02 of the Standard Specifications to read:

"At the time of manufacturing, the retroreflective prismatic sheeting used on channelizing devices shall meet or exceed the initial minimum coefficient of retroreflection as specified in the following table. Measurements shall be conducted according to ASTM E 810, without averaging. Sheeting used on cones, drums and flexible delineators shall be reboundable as tested according to ASTM D 4956. Prestriped sheeting for rigid substrates on barricades shall be white and orange.

Initial Minimum Coefficient of Retroreflection candelas/foot candle/sq ft (candelas/lux/sq m) of material				
Observation Angle (deg.)	Entrance Angle (deg.)	White	Orange	Fluorescent Orange
0.2	-4	365	160	150
0.2	+30	175	80	70
0.5	-4	245	100	95
0.5	+30	100	50	40"

Revise the first sentence of the first paragraph of Article 1106.02(c) of the Standard Specifications to read:

"Barricades and vertical panels shall have alternating white and orange stripes sloping downward at 45 degrees toward the side on which traffic will pass."

Revise the third sentence of the first paragraph of Article 1106.02(d) of the Standard Specifications to read:

"The bottom panels shall be 8 x 24 in. (200 x 600 mm) with alternating white and orange stripes sloping downward at 45 degrees toward the side on which traffic will pass."

80183

RETROREFLECTIVE SHEETING, NONREFLECTIVE SHEETING, AND TRANSLUCENT OVERLAY FILM FOR HIGHWAY SIGNS (BDE)

Effective: April 1, 2007

General. This special provision covers retroreflective sheeting and translucent overlay films intended for application on new or refurbished aluminum. The sheeting serves as the reflectorized background for sign messages and as cutout legends and symbols applied to the reflectorized background. Messages may be applied in opaque black or transparent colors.

This special provision also covers nonreflective sheeting for application on new or refurbished aluminum, and as material for cutout legends and symbols applied to the reflectorized background.

All material furnished under this specification shall have been manufactured within 18 months of the delivery date. All material shall be supplied by the same manufacturer.

Retroreflective Sheeting Properties. Retroreflective sheeting shall consist of a flexible, colored, prismatic, or glass lens elements adhered to a synthetic resin, encapsulated by a flexible, transparent plastic having a smooth outer surface and shall meet the following requirements.

Only suppliers whose products have been tested and approved in the Department's periodic Sheeting Study will be eligible to supply material. All individual batches and or lots of material shall be tested and approved by the Department. The Department reserves the right to sample and test delivered materials according to Federal Specification LS-300.

- (a) Adhesive. The sheeting shall have a Class 1, pre-coated, pressure sensitive adhesive according to ASTM D 4956. The adhesive shall have a protective liner that is easily removed when tested according to ASTM D 4956. The adhesive shall be capable of being applied to new or refurbished aluminum and reflectorized backgrounds without additional adhesive.
- (b) Color. The sheeting shall be uniform in color and devoid of streaks throughout the length of each roll. The color shall conform to the latest appropriate standard color tolerance chart issued by the U.S. Department of Transportation, Federal Highway Administration and to the daytime and nighttime color requirements of ASTM D 4956. Sheeting used for side by side overlay applications shall have a Hunter Lab Delta E of less than 3.
- (c) Coefficient of Retroreflection. When tested according to ASTM E 810, without averaging, the sheeting shall have a minimum coefficient of retroreflection as shown in the following tables. The brightness of the sheeting when totally wet shall be a minimum of 90 percent of the values shown when tested according to the standard rainfall test specified in Section 7.10.1 of AASHTO M 268-84.

Type A Sheeting
Minimum Coefficient of Retroreflection
candelas/foot candle/sq ft (candelas/lux/sq m) of material

Type A

Observation Angle (deg.)	Entrance Angle (deg.)	White	Yellow	Orange	Red	Green	Blue	Brown
0.2	-4	250	170	100	45	45	20	12
0.2	+30	150	100	60	25	25	12	8.5
0.5	-4	95	65	30	15	15	8	5
0.5	+30	75	50	25	10	10	5	3.5

Type AA Sheeting
Minimum Coefficient of Retroreflection
candelas/foot candle/sq ft (candelas/lux/sq m) of material

Type AA (0 and 90 degree rotation)

Observation Angle (deg.)	Entrance Angle (deg.)	White	Yellow	Red	Green	Blue	FO
0.2	-4	800	660	215	80	43	200
0.2	+30	400	340	100	35	20	120
0.5	-4	200	160	45	20	9.8	80
0.5	+30	100	85	26	10	5.0	50

Type AA (45 degree rotation)

Observation Angle (deg.)	Entrance Angle (deg.)	Yellow	FO
0.2	-4	550	165
0.2	+30	130	45
0.5	-4	145	70
0.5	+30	70	40

Type AP Sheeting
Minimum Coefficient of Retroreflection
candelas/foot candle/sq ft (candelas/lux/sq m) of material

Type AP

Observation Angle (deg.)	Entrance Angle (deg.)	White	Yellow	Red	Green	Blue	Brown	FO
0.2	-4	550	425	100	75	50	30	275
0.2	+30	200	150	40	35	25	15	90
0.5	-4	300	250	60	35	25	20	150
0.5	+30	100	70	20	20	10	5	50

Type AZ Sheeting
 Minimum Coefficient of Retroreflection
 candelas/foot candle/sq ft (candelas/lux/sq m) of material

Type AZ (0 degree rotation)

Observation Angle (deg.)	Entrance Angle (deg.)	White	Yellow	Red	Green	Blue	FYG	FY
0.2	-4	430	350	110	45	20	325	240
0.2	+30	235	140	60	24	11	200	150
0.5	-4	250	200	60	25	10	235	165
0.5	+30	170	135	40	19	7	105	75
1.0	-4	70	45	10	10	4	70	30
1.0	+30	30	20	7	5	2.5	45	15

Type AZ (90 degree rotation)

Observation Angle (deg.)	Entrance Angle (deg.)	White	Yellow	Red	Green	Blue	FYG	FY
0.2	-4	320	250	100	45	20	300	220
0.2	+30	235	140	40	24	11	200	150
0.5	-4	240	200	60	25	10	235	165
0.5	+30	100	85	20	10	7	80	75
1.0	-4	30	30	7	5	4	65	20
1.0	+30	15	15	5	2	2	30	10

- (d) Gloss. The sheeting surface shall exhibit a minimum 85 degree gloss-meter rating of 50 when tested according to ASTM D 523.
- (e) Durability. When processed and applied, the sheeting shall be weather resistant.

Accelerated weathering testing will be performed for 1000 hours (300 hours for orange/FO) according to ASTM G 151. The testing cycle will consist of 8 hours of light at 140 °F (60 °C), followed by 4 hours of condensation at 104 °F (40 °C). Following accelerated weathering, the sheeting shall exhibit a minimum of 80 percent of its initial minimum coefficient of retroreflection as listed in the previous tables.

Outdoor weathering will entail an annual evaluation of material placed in an outdoor rack with a 45 degree angle and a southern sun exposure. The sheeting will be evaluated for five years. Following weathering, the test specimens will be cleaned by immersing them in a five percent hydrochloric acid solution for 45 seconds, then rinsed with water and blotted dry with a soft clean cloth. Following cleaning, the applied sheeting shall show no appreciable discoloration, cracking, streaking, crazing, blistering, or dimensional change. The sheeting shall exhibit a Hunter Lab Delta E of 5 or less when compared to the original.

- (f) Shrinkage. When tested according to ASTM D 4956, the sheeting shall not shrink in any dimension more than 1/32 in. (0.8 mm) in ten minutes and not more than 1/8 in. (3 mm) in 24 hours.
- (g) Workability. The sheeting shall show no cracking, scaling, pitting, blistering, edge lifting, inter-film splitting, curling, or discoloration when processed and applied using mutually acceptable processing and application procedures.
- (h) Splices. A single roll of sheeting shall contain a maximum of four splices per 50 yd (45 m) length. The sheeting shall be overlapped a minimum of 3/16 in. (5 mm) at each splice.
- (i) Adhesive Bond. The sheeting shall form a durable bond to smooth, corrosion and weather-resistant surfaces and adhere securely when tested according to ASTM D 4956.
- (j) Positionability. Sheeting, with ASTM D 4956 Class 3 adhesive, used for manufacturing cutout legends and borders shall provide sufficient positionability during the fabrication process to permit removal and reapplication without damage to either the legend or sign background and shall have a plastic liner suitable for use on bed cutting machines. Thereafter, all other adhesive and bond requirements contained in the specification shall apply.

Positionability shall be verified by cutting 4 in. (100 mm) letters E, I, K, M, S, W, and Y out of the positionable material. The letters shall then be applied to a sheeted aluminum blank using a single pass of a two pound roller. The letters shall sit for five minutes and then a putty knife shall be used to lift a corner. The thumb and fore finger shall be used to slowly pull the lifted corner to lift letters away from the sheeted aluminum. The letters shall not tear or distort when removed.

- (k) Thickness. The thickness of the sheeting without the protective liner shall be less than or equal to 0.015 in. (0.4 mm), or 0.025 in. (0.6 mm) for prismatic material.
- (l) Processing. The sheeting shall permit cutting and color processing according to the sheeting manufacturer's specifications at temperatures of 60 to 100 °F (15 to 38 °C) and within a relative humidity range of 20 to 80 percent. The sheeting shall be heat resistant and permit forced curing without staining the applied or unapplied sheeting at temperatures recommended by the manufacturer. The sheeting shall be solvent resistant and capable of being cleaned with VM&P naphtha, mineral spirits, and turpentine.

Transparent color and opaque black inks shall be single component and low odor. The inks shall dry within eight hours and not require clear coating. After color processing on white sheeting, the sheeting shall show no appreciable discoloration, cracking, streaking, crazing, blistering, or dimensional change when tested for durability (e). The ink on the weathered, prepared panel shall exhibit a Hunter Lab Delta E of 5 or less when compared to the original.

Transparent color electronic cutting films shall be acrylic. After application to white sheeting, the films shall show no appreciable discoloration, cracking, streaking, crazing, blistering, or dimensional change when tested for durability (e). The films on the weathered, prepared panel shall exhibit a Hunter Lab Delta E of 5 or less when compared to the original.

Transparent colors screened, or transparent acrylic electronic cutting films, on white sheeting, shall have a minimum initial coefficient of retroreflection values of 50 percent for yellow and red, and a minimum 70 percent for green, blue, and brown of the 0.2 degree observation angle/-4.0 degree entrance angle values as listed in the previous tables for the color being applied. After durability testing, the colors shall retain a minimum 80 percent of the initial coefficient of retroreflection.

- (m) Identification. The sheeting shall have a distinctive overall pattern in the sheeting unique to the manufacturer. If material orientation is required for optimum retroreflectivity, permanent orientation marks shall be incorporated into the face of the sheeting. Neither the overall pattern nor the orientation marks shall interfere with the reflectivity of the sheeting.
- (n) Packaging. Both ends of each box shall be clearly labeled with the sheeting type, color, adhesive type, manufacturer's lot number, date of manufacture, and supplier's name. Material Safety Data Sheets and technical bulletins for all materials shall be furnished to the Department with each shipment.

Nonreflective Sheeting Properties. Nonreflective sheeting shall consist of a flexible, pigmented cast vinyl film having a smooth, flat outer surface and shall meet the following requirements.

The Department reserves the right to sample and test delivered materials according to Federal Specification LS-300.

- (a) Adhesive. The sheeting shall have a Class 1, pre-coated, pressure sensitive adhesive according to ASTM D 4956. The adhesive shall have a protective liner that is easily removed when tested according to ASTM D 4956. The adhesive shall be capable of being applied to new or refurbished aluminum and reflectorized backgrounds without additional adhesive.
- (b) Color. The sheeting shall be uniform in color and devoid of streaks throughout the length of each roll.
- (c) Gloss. The sheeting shall exhibit a minimum 85 degree gloss-meter rating of 40 when tested according to ASTM D 523.
- (d) Durability. Applied sheeting that has been vertically exposed to the elements for seven years shall show no appreciable discoloration, cracking, crazing, blistering, delamination, or loss of adhesion. A slight amount of chalking is permitted but the sheeting shall not support fungus growth.

(e) Testing. Test panels shall be prepared by applying the sheeting to 6 1/2 x 6 1/2 in. (165 x 165 mm) pieces of aluminum according to the manufacturer's specifications. The edges of the panel shall be trimmed evenly and aged 48 hours at 70 to 90 °F (21 to 32 °C). Shrinkage and immersion testing shall be as follows.

(1) Shrinkage. The sheeting shall not shrink more than 1/64 in. (0.4 mm) from any panel edge when subjected to a temperature of 150 °F (66 °C) for 48 hours and shall be sufficiently heat resistant to retain adhesion after one week at 150 °F (66 °C).

(2) Immersion Testing. The sheeting shall show no appreciable decrease in adhesion, color, or general appearance when examined one hour after being immersed to a depth of 2 or 3 in. (50 or 75 mm) in the following solutions at 70 to 90 °F (21 to 32 °C) for specified times.

Solution	Immersion Time (hours)
Reference Fuel (M I L-F-8799A) (15 parts xylol and 85 parts mineral spirits by weight)	1
Distilled Water	24
SAE No. 20 Motor Oil	24
Antifreeze (1/2 ethylene glycol, 1/2 distilled water)	24

(f) Adhesive Bond: The sheeting shall form a durable bond to smooth, corrosion and weather-resistant surfaces and adhere securely when tested according to ASTM D 4956.

(g) Thickness. The thickness of the sheeting without the protective liner shall be a maximum of 0.005 in. (0.13 mm).

(h) Cutting. Material used on bed cutting machines shall have a smooth plastic liner.

(i) Identification. The sheeting shall have a distinctive overall pattern in the sheeting unique to the manufacturer. If material orientation is required for optimum retroreflectivity, permanent orientation marks shall be incorporated into the face of the sheeting. Neither the overall pattern nor the orientation marks shall interfere with the reflectivity of the sheeting.

(j) Packaging. Both ends of each box shall be clearly labeled with the sheeting type, color, adhesive type, manufacturer's lot number, date of manufacture, and supplier's name. Material Safety Data Sheets and technical bulletins for all materials shall be furnished to the Department with each shipment.

SUBCONTRACTOR MOBILIZATION PAYMENTS (BDE)

Effective: April 2, 2005

To account for the preparatory work and operations necessary for the movement of subcontractor personnel, equipment, supplies, and incidentals to the project site and for all other work or operations that must be performed or costs incurred when beginning work approved for subcontracting in accordance with Article 108.01 of the Standard Specifications, the Contractor shall make a mobilization payment to each subcontractor.

This mobilization payment shall be made at least 14 days prior to the subcontractor starting work. The amount paid shall be equal to 3 percent of the amount of the subcontract reported on form BC 260A submitted for the approval of the subcontractor's work.

This provision shall be incorporated directly or by reference into each subcontract approved by the Department.

80143

WORKING DAYS (BDE)

Effective: January 1, 2002

The Contractor shall complete the work within 45 working days.

80071

STATE OF ILLINOIS
DEPARTMENT OF TRANSPORTATION
PLANS FOR
PROPOSED LOCAL AGENCY IMPROVEMENT
FEDERAL AID SAFETY PROJECT
FAS 905 and CH 18 SECTION 07-00118-00-SP
WILLIAMSON COUNTY
PROJECT HRR-0199(031) JOB NO. C-99-501-08

BEGIN PROJECT
STA. 0+00

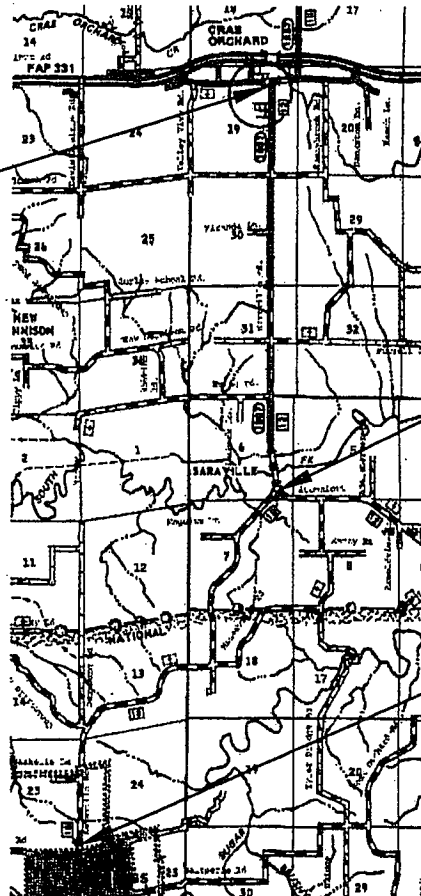

STATION EQUATION
STA. 197+50 BK
EQUALS
STA. 3+50 AH

END PROJECT
STA. 238+60

Call J.U.L.I.E.
1-800-892-0123

LOCATION MAP

T.9S., R.4E., 3rd P.M.

TOTAL LENGTH OF SECTION = 43,260 Ft = 8.19 Mi

CLASSIFICATION: COLLECTOR

ADT(08): 1250

DESIGN SPEED: 50 MPH

James Webb
JAMES WEBB, PE# 062-046528
County Engineer
Williamson County
11/30/09

Expiration Date

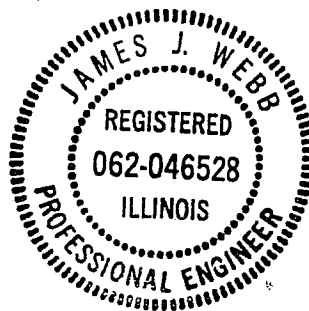

CONTRACT NO. 99326

STATE OF ILLINOIS DEPARTMENT OF TRANSPORTATION	
APPROVED	4-17, 20 08
<i>James Webb</i> COUNTY ENGINEER	
PASSED	5/21, 20 08
<i>Deni W. Hallett</i> DISTRICT 9 ENGINEER OF LOCAL ROADS AND STREETS	
Releasing for Bid Based on Limited Review	
5/22, 20 08 <i>Mary C. Lamie</i> MARY C. LAMIE, P.E. DEPUTY DIRECTOR OF HIGHWAYS REGION FIVE ENGINEER	

ROUTE NO.	SECTION	COUNTY	TOTAL SHEETS	SHEET NO.
CH 12.18	07-00118-00-SP	WILLIAMSON	8	2
FED. RD. DIST. NO. 7		ILL. PROJ.	HRR-0199(031)	
CONTRACT NO.			99326	

INDEX OF SHEETS

<u>SHEET NO.</u>	<u>CONTENTS</u>
1	COVER SHEET
2	INDEX OF SHEETS
3	SUMMARY OF QUANTITIES
4	BITUMINOUS SHOULDER TYPICAL
5	TREE REMOVAL LOCATIONS
6	GUARDRAIL LOCATIONS
7-8	SIGN INSTALLATION LOCATIONS
9-39	HIGHWAY STANDARDS

ROUTE NO.	SECTION	COUNTY	TOTAL SHEETS	SHEET NO.
CH 12,18	07-0011B-00-SP	WILLIAMSON	8	3
FED. RD. DIST. NO. 7		ILL. PROJ.	HRR-0199(031)	
CONTRACT NO.		99326		

SUMMARY OF QUANTITIES

SFTY-2A

Quantity	Unit	Item	
0.10	ACRE	TREE REMOVAL ACRES	20100500
24	EACH	TREE PRUNING. (1-10 INCH DIAMETER)	20101300
55	EACH	TREE PRUNING. (OVER 10 INCH DIAMETER)	20101350
19,200	SQ YD	HOT-MIX ASPHALT SHOULDERS, 8"	48203029
587.5	FOOT	STEEL PLATE BEAM GUARDRAIL, TY A	63000000
8	EACH	TRAFFIC BARRIER TERMINAL, TYPE 5A	63100075
14	EACH	TRAFFIC BARRIER TERMINAL, TYPE 1. (SPECIAL)TANGENT	63100167
724	FOOT	GUARDRAIL REMOVAL	63200310
85,100	FOOT	SHOULDER RUMBLE STRIP	64200105
1	L SUM	MOBILIZATION	67100100
1526	SQ FT	SIGN PANEL-TYPE 1	72000100
1937	FOOT	METAL POST-TYPE B	72900200
165,000	FOOT	PAINT PAVEMENT MARKING-LINE 4"	78001110
540	EACH	RAISED REFLECTIVE PAVEMENT MARKER	78100100

*
*
*
*
*
*

** SPECIALTY ITEMS*

ROUTE NO.	SECTION	COUNTY	TOTAL SHEETS	SHEET NO.
CH 12,18	07-00118-00-SP	WILLIAMSON	8	4
FED. RD. DIST. NO. 7		ILL. PROJ.	HRR-0199(031)	
CONTRACT NO.		99326		

HOT MIX ASPHALT SHOULDER TYPICAL SECTION

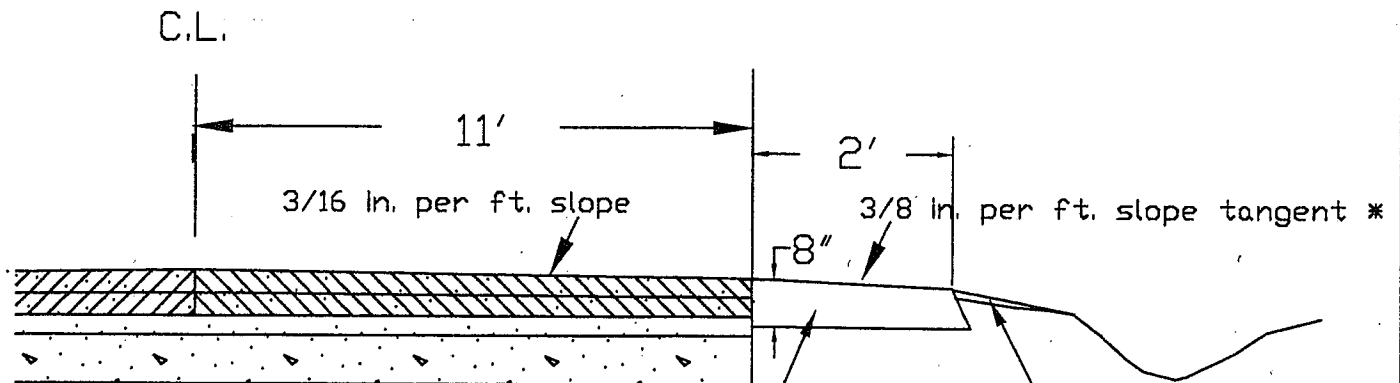

SHOULDER WEDGE
TO BE CONSTRUCTED FROM
SHOULDER EXCAVATION MATERIAL
WHERE NEEDED TO TRANSITION
DOWN TO EXISTING SHLDR.
(2' WIDE TYPICAL)

PROPOSED HOT MIX ASPHALT SHOULDER TO BE
CONSTRUCTED IN TWO LIFTS AS DIRECTED BY THE
ENGINEER. BOTH LIFTS TO BE HOT MIX ASPHALT
SURFACE MIX C.

* H. CURVE SHOULDER SLOPE SHALL BE
ADJUSTED SO THAT THE ALGEBRAIC
DIFFERENCE BETWEEN THE PAVEMENT
AND SHOULDER SLOPES DOES NOT
EXCEED 0.08 FT/FT.

ROUTE NO.	SECTION	COUNTY	TOTAL SHEETS	SHEET NO.
CH 12,18	07-00118-00-SP	WILLIAMSON	8	5
FED. RD. DIST. NO. 7		ILL. PROJ.	HRR-0199(031)	
CONTRACT NO.		29326		

07-00118-00-SP
TREE REMOVAL LOCATIONS

<u>TREE REMOVAL LOCATIONS</u>			
<u>BEGIN*</u>	<u>END</u>	<u>E.P. TO ROW LINE</u>	
North Zone			
35+90 Rt.	35+97 Rt.	19'	
63+12 Rt.	63+20 Rt.	19'	
77+83 Rt.	78+08 Rt.	19'	
181+99 Rt.	182+21 Rt.	19'	
South Zone			
72+21 Rt.	72+29 Rt.	19'	
81+00 Rt.	81+61 Rt.	19'	
126+83 Rt.	127+11 Rt.	19'	
146+68 Rt.	147+48 Rt.	19'	
<u>TREE PRUNING LOCATIONS</u>			
<u>BEGIN*</u>	<u>END</u>	<u>No. 1"-10"</u>	<u>No. Over 10"</u>
20+76 Rt.	21+57 Rt.		1
36+12 Rt.	42+04 Rt.	4	10
51+71 Rt.	52+02 Rt.		1
52+88 Rt.	53+46 Rt.	2	1
59+18 Rt.	59+39 Rt.		1
59+87 Rt.	60+12 Rt.	1	1
60+32 Rt.	61+14 Rt.		3
62+30 Rt.	62+81 Rt.		2
63+50 Rt.	65+11 Rt.	3	5
72+77 Rt.	74+26 Rt.	1	4
75+25 Rt.	77+52 Rt.	9	4
78+30 Rt.	78+54 Rt.		1
95+19 Rt.	96+53 Rt.		4
100+38 Rt.	100+82 Rt.		2
102+00 Rt.	102+52 Rt.	2	2
105+96 Rt.	106+27 Rt.		1
107+09 Rt.	107+91 Rt.		2
108+08 Rt.	108+37 Rt.		1
109+12 Rt.	111+22 Rt.	2	8
115+62 Rt.	115+86 Rt.		1
*Locations may be altered/added by the Engineer.			
These locations approximate the scope of work.			

ROUTE NO.	SECTION	COUNTY	TOTAL SHEETS	SHEET NO.
CH 12,18	07-00118-00-SP	WILLIAMSON	8	6
FED. RD. DIST. NO. 7		ILL. PROJ.	HRR-0199(031)	
CONTRACT NO.			99326	

07-00118-00-SP
GUARDRAIL LOCATIONS

SALINE RIVER OVERFLOW BRIDGE

Traffic Barrier Terminal Type 5A: 4 Each

(Each end of bridge rail)

180+63 Lt. and Rt.

181+36 Lt. and Rt.

Traffic Barrier Terminal Type 1, Special (Tangent): 4 Each

(Each end of Type 5A)

180+63 Lt. and Rt.

181+36 Lt. and Rt.

(These include, as incidental, the terminal end section marker decal.)

Guardrail Removal: 200 Foot

SALINE RIVER BRIDGE

Traffic Barrier Terminal Type 5A: 4 Each

(Each end of bridge rail)

187+30 Lt. and Rt.

188+95 Lt. and Rt.

Steel Plate Beam Guardrail

187+30 Lt. 37.5 Foot

187+30 Rt. 100 Foot

188+95 Lt. 100 Foot

188+95 Rt. 37.5 Foot

Traffic Barrier Terminal Type 1, Special (Tangent): 4 Each

187+30 Lt. and Rt.

188+95 Lt. and Rt.

(These include, as incidental, the terminal end section marker decal.)

Guardrail Removal: 524 Foot

BOX CULVERT AT STA. 17+45 SOUTH

Steel Plate Beam Guardrail Type A: 75 Foot

(37.5 Foot Lt. and Rt. Sides of Sta. 17+45)

(Guardrail Attached to culvert)

Traffic Barrier Terminal Type 1, Special (Tangent): 4 Each

Each end of proposed guardrail

(These include, as incidental, the terminal end section marker decal.)

STEEP SLOPE AT 127+00 SOUTH

Steel Plate Beam Guardrail Type A: 237.5 Foot

125+75 Rt. to 128+12.5 Rt.

Traffic Barrier Terminal Type 1, Special (Tangent): 2 Each

Each end of proposed guardrail

(These include, as incidental, the terminal end section marker decal.)

ROUTE NO.	SECTION	COUNTY	TOTAL SHEETS	SHEET NO.
CH 121B	07-00118-00-SP	WILLIAMSON	8	7
FED. RD. DIST. NO. 7		ILL. PROJ.	HRR-0199(031)	
CONTRACT NO.		99326		

**07-00118-00-SP
SIGN LOCATIONS**

<u>STATION</u>	<u>SIGN</u>	<u>SIZE</u>	<u>DESCRIPTION</u>	<u>NOTES</u>
0+13Lt.	R1-1	36"x36"	Stop	
2+03Rt.	R2-1	24"x30"	Speed Limit 45	
7+29Lt.	W3-1	36"x36"	Stop Ahead	
10+26Rt.	R1-1	36"x36"	Stop	Cory Bailey Rd.
10+26Rt.	W3-1	36"x36"	Stop Ahead	Cory Bailey Rd.
13+47Rt.	R1-1	36"x36"	Stop	Academy St.
13+47Rt.	W3-1	36"x36"	Stop Ahead	Academy St.
16+64Rt.	R1-1	36"x36"	Stop	Lupus St.
16+64Rt.	W3-1	36"x36"	Stop Ahead	Lupus St.
30+25Lt.	R2-1	24"x30"	Speed Limit 45	
36+75Lt.	R2-5A	24"x30"	Reduced Speed Ahead	
36+75Lt.	W13-1	24"x24"	45 M.P.H.	
45+46Rt.	R1-1	36"x36"	Stop	Shed Church Rd.
45+46Rt.	W3-1	36"x36"	Stop Ahead	Shed Church Rd.
45+46Lt.	R1-1	36"x36"	Stop	Shed Church Rd.
45+46Lt.	W3-1	36"x36"	Stop Ahead	Shed Church Rd.
51+31Lt.	W2-1	30"x30"	Intersection	
125+42Rt.	R1-1	36"x36"	Stop	Ferrell Church Rd.
125+42Rt.	W3-1	36"x36"	Stop Ahead	Ferrell Church Rd.
125+42Lt.	R1-1	36"x36"	Stop	Ferrell Church Rd.
125+42Lt.	W3-1	36"x36"	Stop Ahead	Ferrell Church Rd.
152+28Rt.	R1-1	36"x36"	Stop	Ewing Rd.
152+28Rt.	W3-1	36"x36"	Stop Ahead	Ewing Rd.
3+88Lt.	R1-1	36"x36"	Stop	
8+60Lt.	W3-1	36"x36"	Stop Ahead	
13+32Lt.	W1-2L	36"x36"	Curve Left	
35+67Rt.	W1-2R	36"x36"	Curve Right	
35+67Rt.	W13-1	24"x24"	50 M.P.H.	
53+61Lt.	W1-2L	36"x36"	Curve Left	
53+61Lt.	W13-1	24"x24"	50 M.P.H.	
65+53Rt.	W1-4R	36"x36"	Reverse Curve Right	
65+53Rt.	W13-1	24"x24"	50 M.P.H.	
87+05Lt.	W1-2R	36"x36"	Curve Right	
87+05Lt.	W13-1	24"x24"	50 M.P.H.	
91+44Rt.	W1-2R	36"x36"	Curve Right	
100+41Lt.	R1-1	36"x36"	Stop	Mauseyville Rd.
100+41Lt.	W3-1	36"x36"	Stop Ahead	Mauseyville Rd.
110+88Lt.	W1-2L	36"x36"	Curve Left	
113+12Rt.	W1-4L	36"x36"	Reverse Curve Left	
113+12Rt.	W13-1	24"x24"	35 M.P.H.	

ROUTE NO.	SECTION	COUNTY	TOTAL SHEETS	SHEET NO.
CH. 1218	07-00118-00-SP	WILLIAMSON	8	8
FED. RD. DIST. NO. 7		ILL. PROJ.	HRR-0199(031)	
CONTRACT NO.			99326	

**07-00118-00-SP
SIGN LOCATIONS**

<u>STATION</u>	<u>SIGN</u>	<u>SIZE</u>	<u>DESCRIPTION</u>	<u>NOTES</u>
148+35Lt.	W1-4R	36"x36"	Reverse Curve Right	
148+35Lt.	W13-1	24"x24"	35 M.P.H.	
156+90Rt.	W1-2L	36"x36"	Curve Left	
174+31Rt.	W1-2L	36"x36"	Curve Left	
177+00Lt.	W1-2R	36"x36"	Curve Right	
178+86Rt.	R1-1	36"x36"	Stop	Canaville Rd.
178+86Rt.	W3-1	36"x36"	Stop Ahead	Canaville Rd.
192+17Lt.	W1-2R	36"x36"	Curve Right	
204+79Rt.	R1-1	36"x36"	Stop	Gaskells Ln.
204+79Rt.	W3-1	36"x36"	Stop Ahead	Gaskells Ln.
236+58Rt.	R2-1	24"x30"	Speed Limit 30	

All the following chevrons are on the South portion Stationing

27+80 Rt. to 34+60 Rt.	(11) W1-8	24"x30"	Chevron (Both Sides of Post)	Outside of Curve 70' Spacing
41+50 Lt. to 50+00 Lt.	(13) W1-8	24"x30"	Chevron (Both Sides of Post)	Outside of Curve 70' Spacing
59+70 Rt. to 65+80 Rt.	(9) W1-8	24"x30"	Chevron (Both Sides of Post)	Outside of Curve 70' Spacing
70+25 Rt. to 76+00 Rt.	(10) W1-8	24"x30"	Chevron (Both Sides of Post)	Outside of Curve 70' Spacing
97+00 Lt. to 104+60 Lt.	(12) W1-8	24"x30"	Chevron (Both Sides of Post)	Outside of Curve 70' Spacing
117+40 Rt. to 132+50 Rt.	(23) W1-8	24"x30"	Chevron (Both Sides of Post)	Outside of Curve 70' Spacing
134+00 Lt. to 141+80 Lt.	(12) W1-8	24"x30"	Chevron (Both Sides of Post)	Outside of Curve 70' Spacing
162+30 Rt. to 170+80 Rt.	(13) W1-8	24"x30"	Chevron (Both Sides of Post)	Outside of Curve 70' Spacing
179+20 Rt. to 185+90 Rt.	(11) W1-8	24"x30"	Chevron (Both Sides of Post)	Outside of Curve 70' Spacing

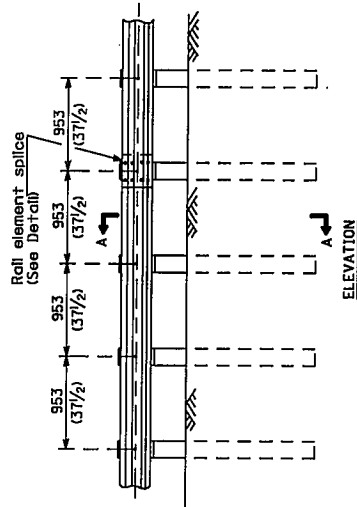

ELEVATION

TYPE B
953 (37 1/2) Closed post spacing

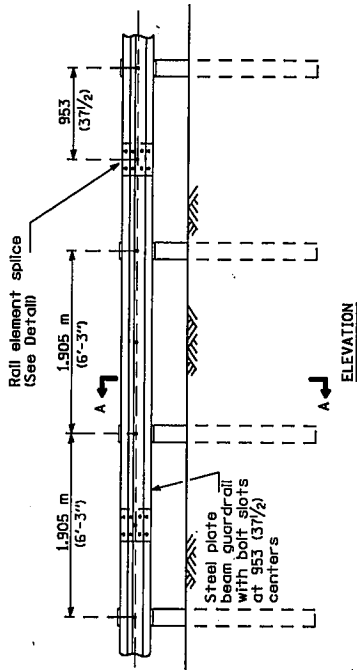

ELEVATION

TYPE A
1,905 m (6'-3 1/2") Typical post spacing

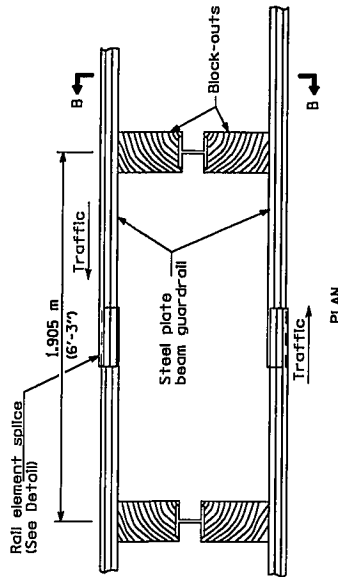

PLAN

TYPE D
Double steel plate beam guardrail
1,905 m (6'-3 1/2") Typical post spacing

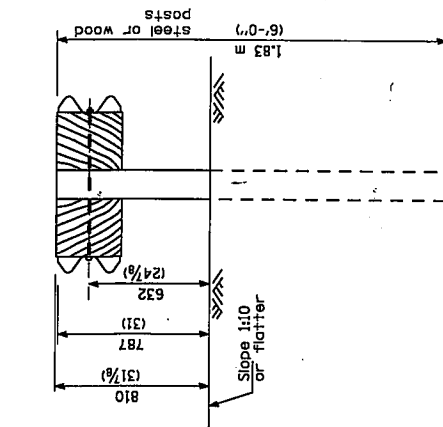

SECTION B-B

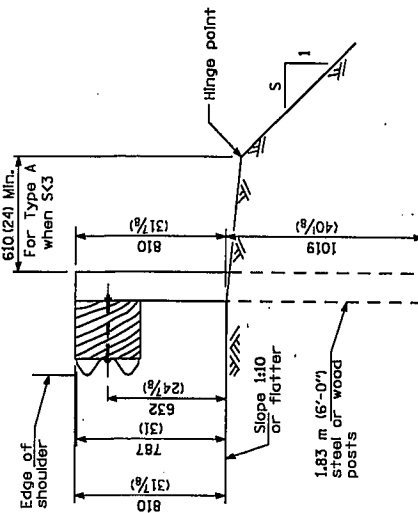

SECTION A-A

GENERAL NOTES

All slope ratios are expressed as units of vertical displacement to units of horizontal displacement (V:H).
All dimensions are in millimeters (inches) unless otherwise shown.

DATE	REVISIONS
1-1-07	Changes adopted to Implement the Midwest Guardrail System.
4-1-06	Deleted plate washer F.

Illinois Department of Transportation
 PASSED January 1, 2007
 ENGINEER OF POLICY AND PROCEDURES
 APPROVED January 1, 2007
 ENGINEER OF DESIGN AND ENVIRONMENT

STEEL PLATE BEAM GUARDRAIL

(Sheet 1 of 4)

STANDARD 630001-07

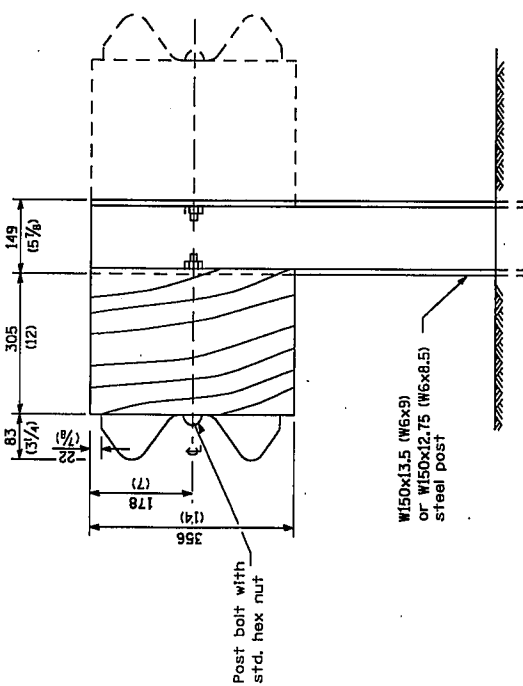

STEEL POST CONSTRUCTION

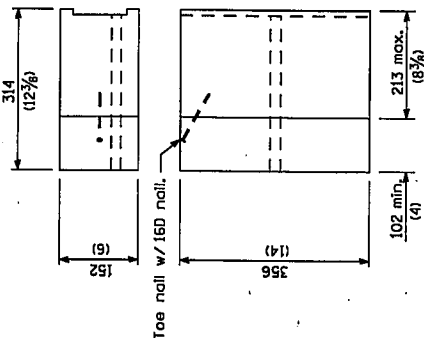

TWO-PIECE WOOD BLOCKOUT OPTION

Illinois Department of Transportation
 PASSED: JUNE 27, 2007
 ENGINEER OF POLICY AND PROCEDURES: [Signature]
 APPROVED: JUNE 27, 2007
 ENGINEER OF DESIGN AND ENVIRONMENT: [Signature]

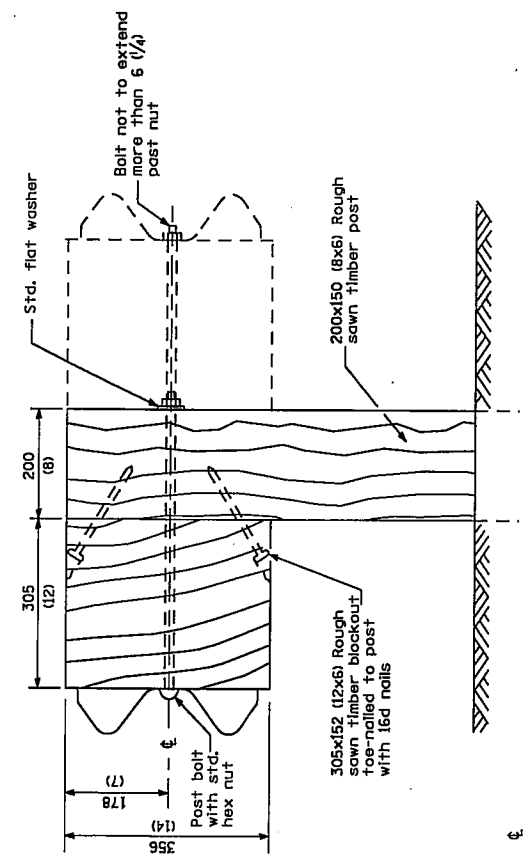

WOOD POST CONSTRUCTION

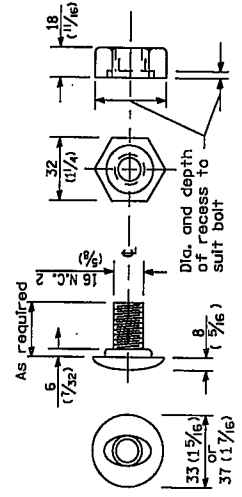

POST OR SPLICE BOLT & NUT

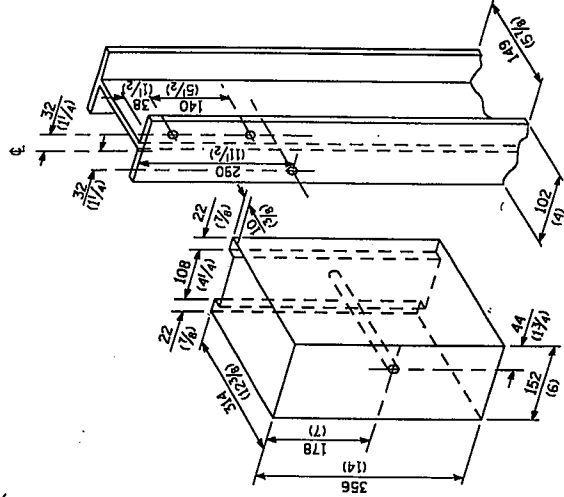

WOOD BLOCK-OUT AND STEEL POST DETAILS

Note: All holes 20 (3/4) dia.

STEEL PLATE BEAM GUARDRAIL
 STANDARD 630001-07
 (Sheet 2 of 4)

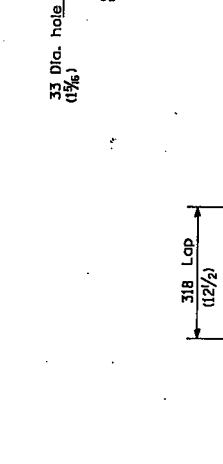
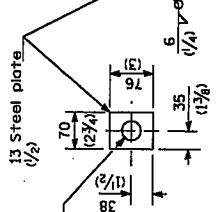
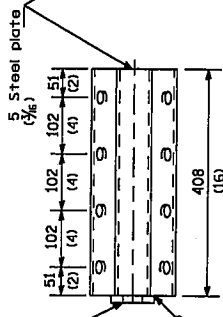
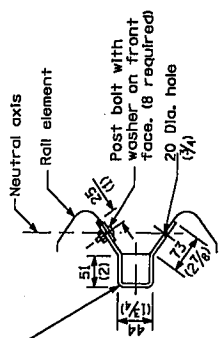

NOTE
Anchor plate T shall be used to attach cable assembly to guard-rail when required on traffic barrier terminals.

ANCHOR PLATE T DETAILS

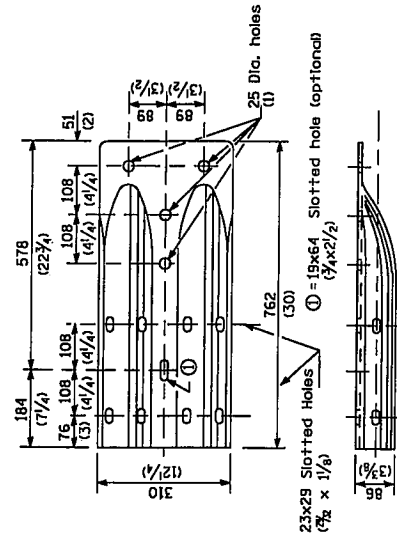

ALTERNATE END SHOE

RAIL ELEMENT SPLICE

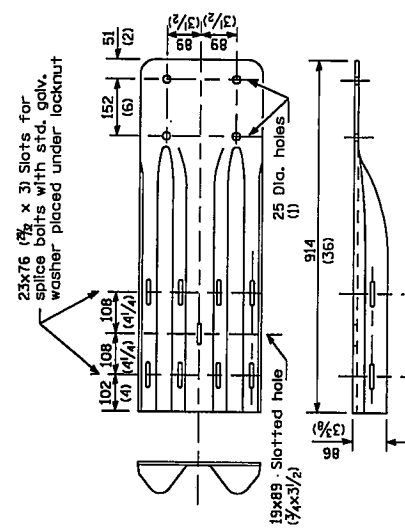

NOTE

When end shoe is attached to a bridge parapet which has an expansion joint, the bolts shall be provided with a locknut or double nut and shall be tightened only to a point that will allow guard-rail movement. The standard end shoe shall be attached to the concrete with pre-drilled or self-drilling anchor bolts. The anchor cone shall be set flush with the surface of the concrete.

Externally threaded studs protruding from the surface of the concrete will not be permitted.

END SHOE

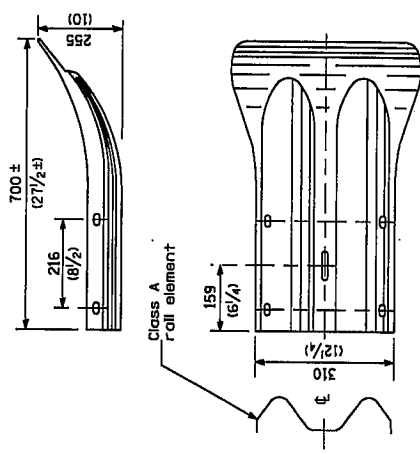

END SECTION

**STEEL PLATE BEAM
GUARDRAIL**
(Sheet 3 of 4)

STANDARD 630001-07

Illinois Department of Transportation
 ISSUED 1-1-97
 PASSED January 1, 2007
 ENGINEER OF POLICY AND PROCEDURES
 APPROVED January 1, 2007
 ENGINEER OF DESIGN AND ENVIRONMENT

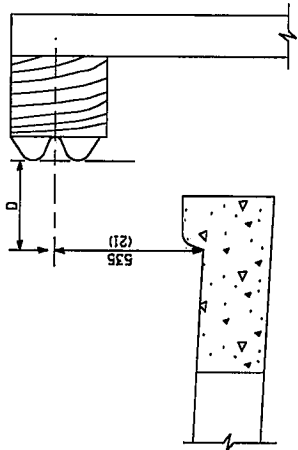

Note:
If it is necessary for D to be more than 300 (12) and less than 3.0 m (10'-0"), types M-5 (M-2) curb and gutter (Std. 606001) shall be used in front of and in advance of the guardrail.

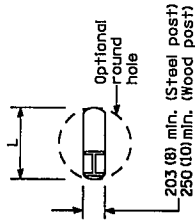

PLAN

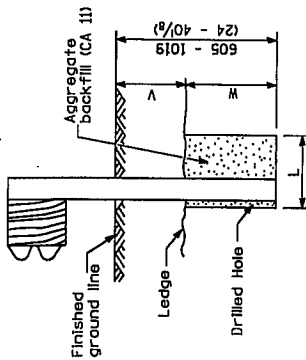

Note:
Ledge line is top of rock ledge or hard slag fill.

ELEVATION

FOOTING FOR POST WHEN IMPERVIOUS MATERIAL IS ENCOUNTERED

GUARDRAIL PLACED BEHIND CURB

D = 0 minimum to 300 (12) maximum and desirable

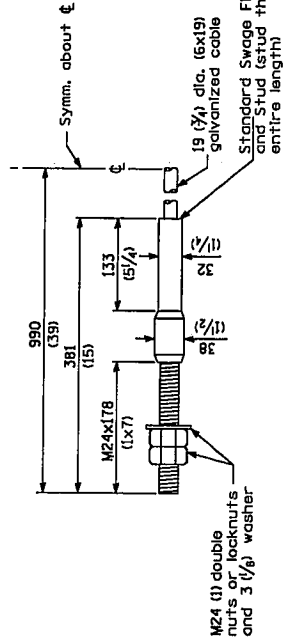

CABLE ASSEMBLY

(18,100 kg (40,000 lbs.) min. breaking strength)
Tighten to taut tension.

V	W	L	
		Steel Post	Wood Post
0 - 410 (0 - 16 1/8)	610 (24)	530 (21)	580 (23)
>410 - 714 (16 1/8 - 28 1/8)	305 (12)	203 (8)	250 (10)
>714 - 1019 (28 1/8 - 40 1/8)	305 - 0 (12 - 0)	203 (8)	250 (10)

Illinois Department of Transportation
 PASSED JANUARY 1, 2007
 ENGINEER OF POLICY AND PROCEDURES
 APPROVED [Signature] JANUARY 1, 2007
 ENGINEER OF DESIGN AND ENVIRONMENT

**STEEL PLATE BEAM
 GUARDRAIL**
 (Sheet 4 of 4)
STANDARD 630001-07

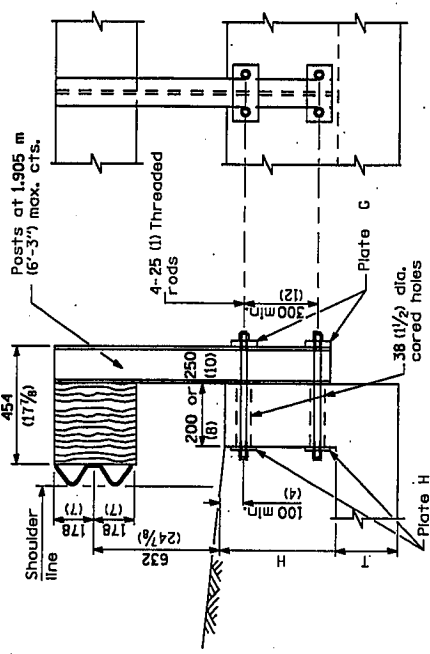

CROSS SECTION
CONDITION H > 450 (18)

ELEVATION

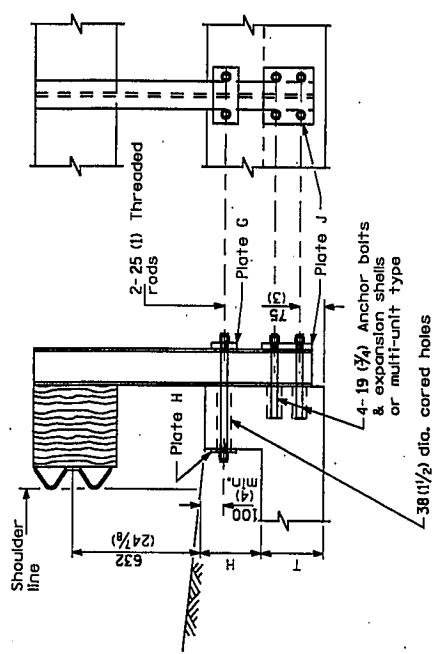

CROSS SECTION
CONDITION H < 450 (18) & H+T ≥ 510 (20)

ELEVATION

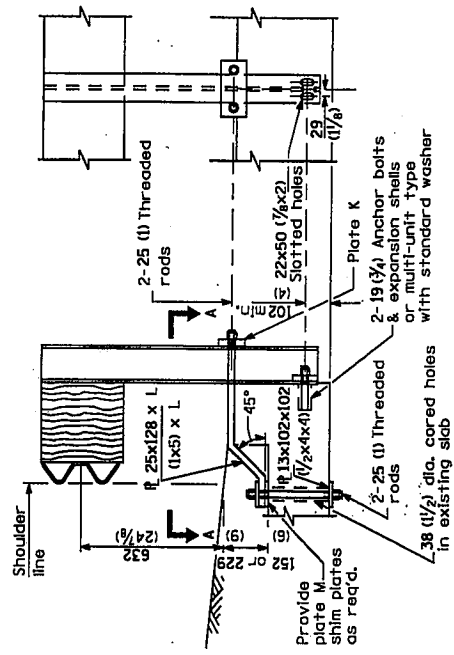

CROSS SECTION

ELEVATION

CASE II
MOUNTED ON TOP HEADWALL
WITH SQUARE TIP

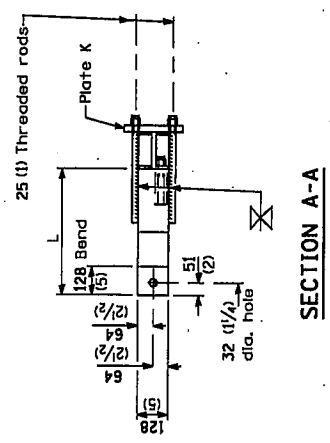

SECTION A-A

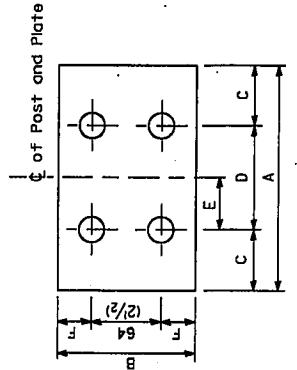

PLATE TYPE J

Type	A	B	C	D	E	F	Hole Dia.	Thick-ness
G	230 (9)	100 (4)	40 (1 1/2)	150 (6)	75 (3)	50 (2)	29 (1 1/8)	25 (1)
H	230 (9)	100 (4)	40 (1 1/2)	150 (6)	75 (3)	50 (2)	29 (1 1/8)	13 (1/2)
J	230 (9)	126 (5)	40 (1 1/2)	150 (6)	75 (3)	31 (1 1/4)	22 (1 1/4)	25 (1)
K	230 (9)	100 (4)	40 (1 1/2)	150 (6)	75 (3)	50 (2)	29 (1 1/8)	32 (1 1/4)
M	100 (4)	100 (4)	50 (2)	N/A	N/A	50 (2)	32 (1 1/4)	13 (1/2)

GENERAL NOTES

Except as noted, dimensions and notes specified for case II, III, and IV are the same as specified for case I.
 For details of guard-rail elements not shown, see Standard 630001.
 All threaded rods shall be installed with heavy hex nuts and standard washers.

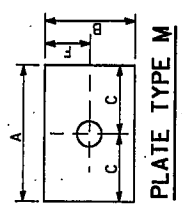

PLATE TYPE M

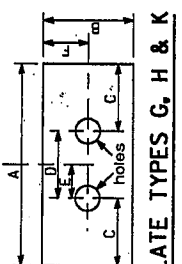

PLATE TYPES G, H & K

GUARDRAIL MOUNTED ON EXISTING CULVERTS
 (Sheet 1 of 2)
STANDARD 630101-07

DATE	REVISIONS
1-1-07	Changes adopted to implement the Midwest Guardrail System.
4-1-06	Corrected bolt hole spacing for base plate of Case IV.

CASE I
MOUNTED ON RAISED HEADWALL

Illinois Department of Transportation
 PASSED January 1, 2007
 ENGINEER OF POLICY AND PROCEDURES
 APPROVED [Signature]
 ENGINEER OF DESIGN AND ENVIRONMENT

ISSUED 1-1-97

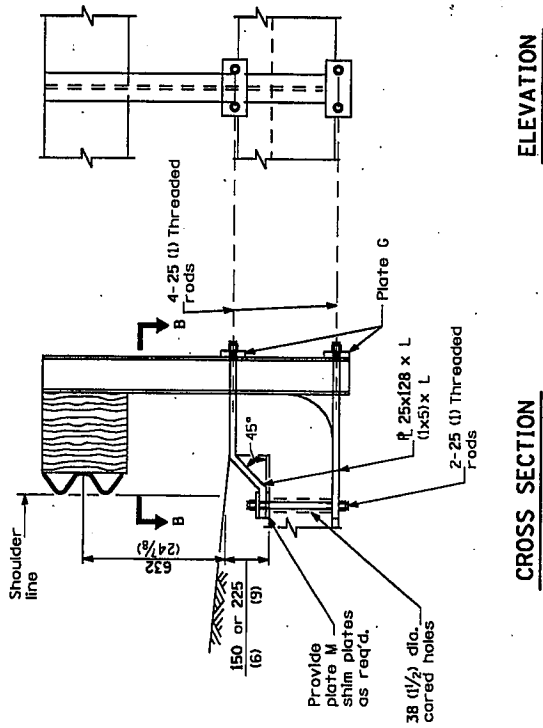

CROSS SECTION

ELEVATION

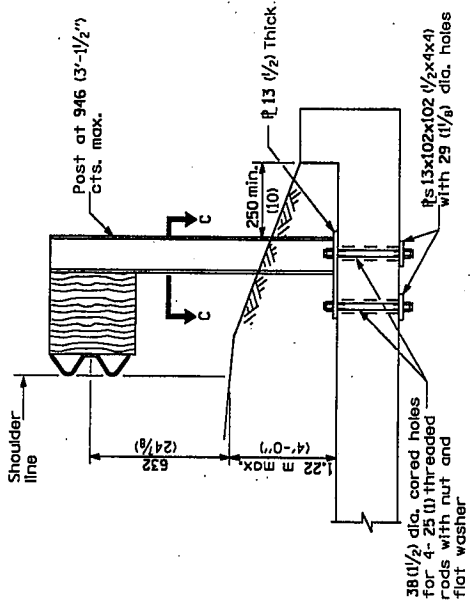

CROSS SECTION

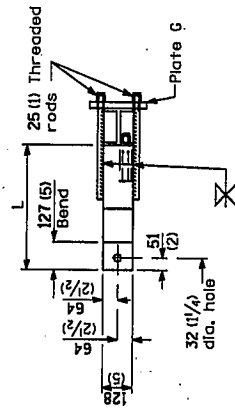

SECTION B-B

**CASE III
MOUNTED ON HEADWALL
WITH CURVED OR DEMOLISHED TIP**

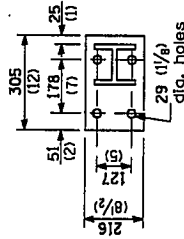

SECTION C-C

**CASE IV
MOUNTED ON SLAB**

All dimensions are in millimeters (inches) unless otherwise shown.

GUARDRAIL MOUNTED ON EXISTING CULVERTS

(Sheet 2 of 2)

STANDARD 630101-07

Illinois Department of Transportation PASSED APPROVED APPROVED APPROVED	APPROVED <i>[Signature]</i> ENGINEER IN CHARGE	ISSUED 1-1-87
	APPROVED <i>[Signature]</i> ENGINEER IN CHARGE	2007
	APPROVED <i>[Signature]</i> ENGINEER IN CHARGE	2007
	APPROVED <i>[Signature]</i> ENGINEER IN CHARGE	2007

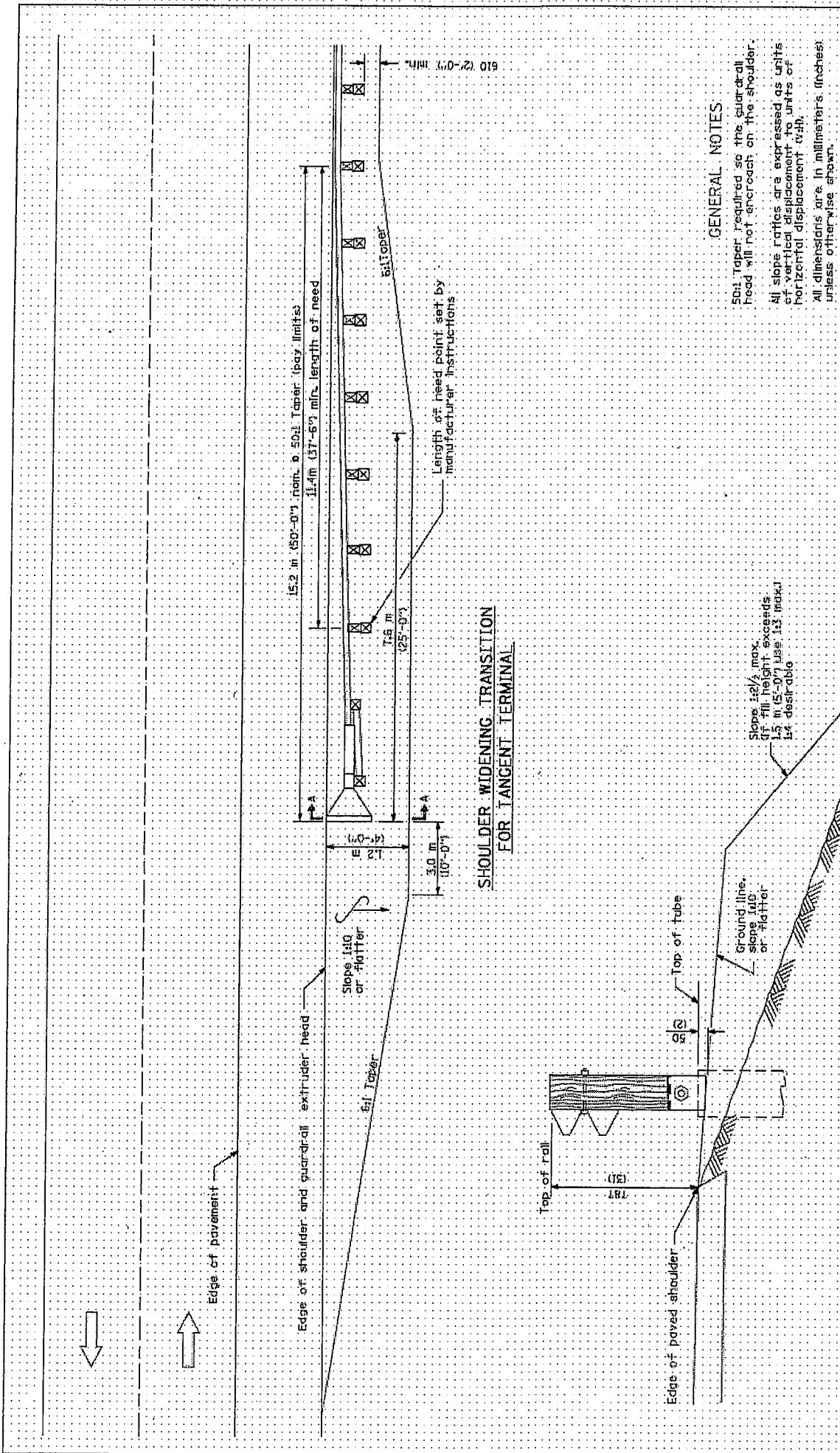

**SHOULDER WIDENING TRANSITION
FOR TANGENT TERMINAL**

GENERAL NOTES

- 50.1 Taper required so the guardrail head will not encroach on the shoulder.
- All slope ratios are expressed as units of vertical displacement to units of horizontal displacement (v:h).
- All dimensions are in millimeters (inches) unless otherwise shown.

**SHOULDER WIDENING FOR
TYPE 1 (SPECIAL)
GUARDRAIL TERMINALS**
(Sheet 1 of 2)
STANDARD 630301-04

DATE	REVISIONS
1-1-07	Changes adopted to Implement the Midwest Guardrail System.
1-1-08	Corrected ground line in Section A-A.

SECTION A-A
Impact Head omitted for clarity

Illinois Department of Transportation	0-1-1
PASSED	JANUARY 1, 2007
APPROVED	JANUARY 2, 2007
REVISIONS	

SHOULDER WIDENING FOR TYPE 1 (SPECIAL) GUARDRAIL TERMINALS
 (Sheet 2 of 2)
STANDARD 630301-04

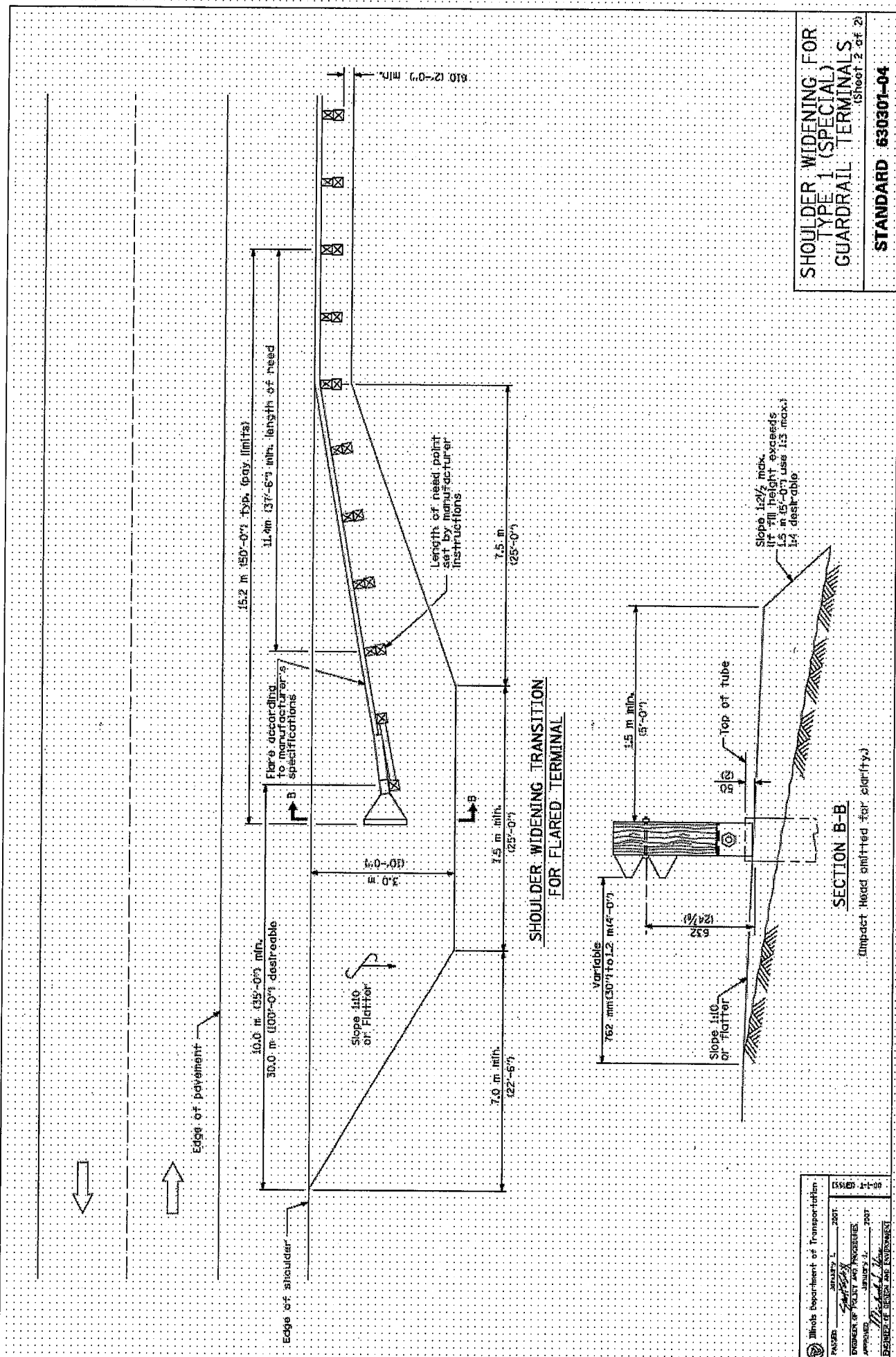

Illinois Department of Transportation
 PROJECT: *SH-10* 2007
 NUMBER OF PAGES AND FIGURES: *2*
 APPROVED: *[Signature]* 2007
 DRAWN BY: *[Signature]*
 CHECKED BY: *[Signature]*

SPACING FOR DELINEATORS ON HORIZONTAL CURVES				
Radius of Curve m (feet)	Spacing on Curve m (feet)	Spacing in Advances and Beyond Curve (feet)		
		1st. Space	2nd. Space	3rd. Space
Less than 30	5	10	20	40
30 - 54	(20)	(40)	(65)	(125)
54 - 100	10	20	25	55
100 - 174	(30)	(60)	(90)	(180)
174 - 224	10	20	35	60
224 - 274	(40)	(80)	(110)	(200)
274 - 319	10	20	40	60
319 - 349	(50)	(100)	(145)	(200)
349 - 449	15	35	50	60
449 - 549	(55)	(110)	(170)	(200)
549 - 609	20	40	60	60
609 - 659	(65)	(125)	(190)	(200)
659 - 749	20	45	60	60
749 - 849	(70)	(140)	(200)	(200)
849 - 949	25	50	60	60
949 - 1049	(75)	(150)	(200)	(200)
1049 - 1149	25	50	60	60
1149 - 1249	(80)	(165)	(200)	(200)
1249 - 1349	25	55	60	60
1349 - 1449	(85)	(175)	(200)	(200)
1449 - 1549	25	55	60	60
1549 - 1649	(90)	(185)	(200)	(200)
1649 - 1749	30	60	60	60
1749 - 1849	(100)	(200)	(200)	(200)
1849 - 1949	40	60	60	60
1949 - 2000	(125)	(200)	(200)	(300)
2000 - 2999	45	60	60	90
2999 - 3999	55	60	90	90
3999 - 4999	60	90	120	120
4999 - 6000	120 or greater	(400)	(400)	(400)

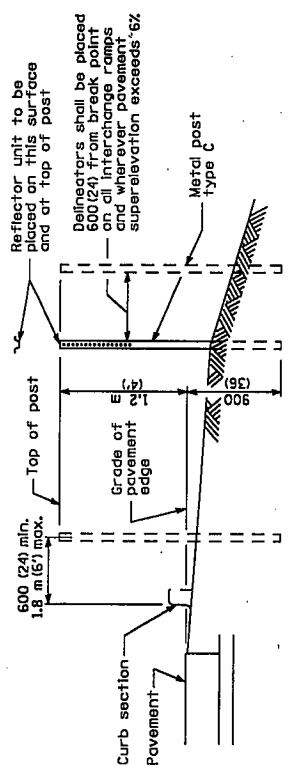

SECTIONAL VIEW

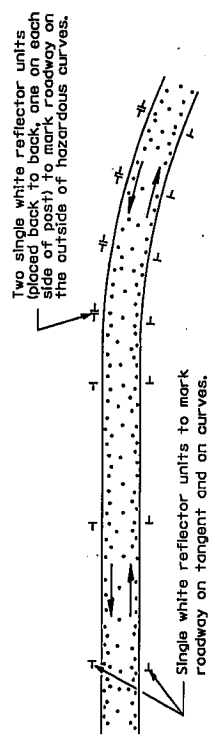

PLAN - TWO-WAY ROADWAYS

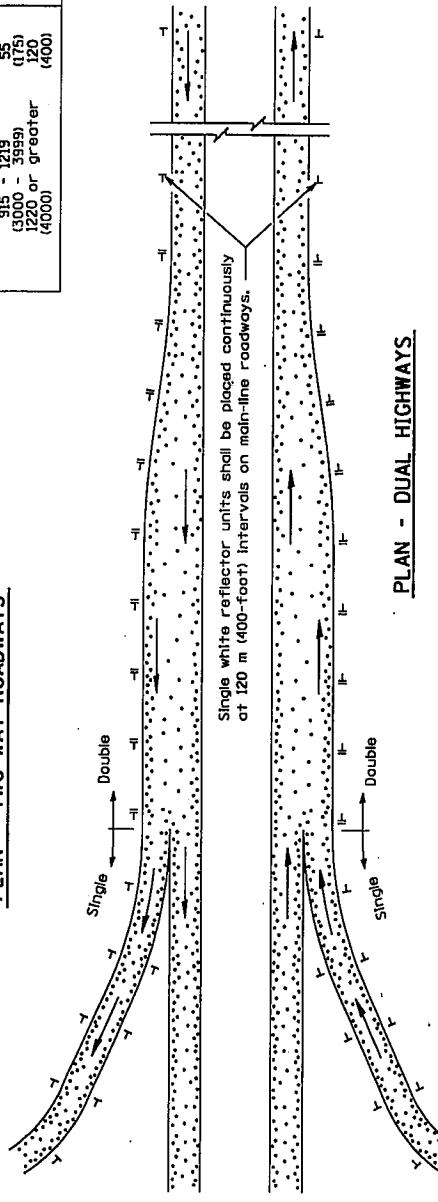

PLAN - DUAL HIGHWAYS

GENERAL NOTES

Delineators on tangent sections of main line roadways shall be placed at 120 m (400') spacing. Delineators on ramps and acceleration and deceleration lanes shall be placed at a maximum spacing of 30 m (100'). Refer to Standard 720011 for details of metal post.

Double white reflector units shall be used to mark the right side of all acceleration and deceleration lanes (double amber for the left side of left-hand acceleration and deceleration lanes). Single delineators shall be used to mark ramps, white on the right side and yellow on the left. Delineators shall be used on ramps to mark the outside of all curved sections.

All dimensions are in millimeters (inches) unless otherwise shown.

DATE	REVISIONS
1-1-97	Renum. Standard 2149-12.
6-15-94	Moved G.N. to Specs. Added metric.

DELINEATORS

STANDARD 635001

Illinois Department of Transportation
 PASSED
 APPROVED 1-1-97
 ENGINEER OF SAFETY AND PREVENTION
 APPROVED 1-1-97
 ENGINEER OF DESIGN AND ENVIRONMENT

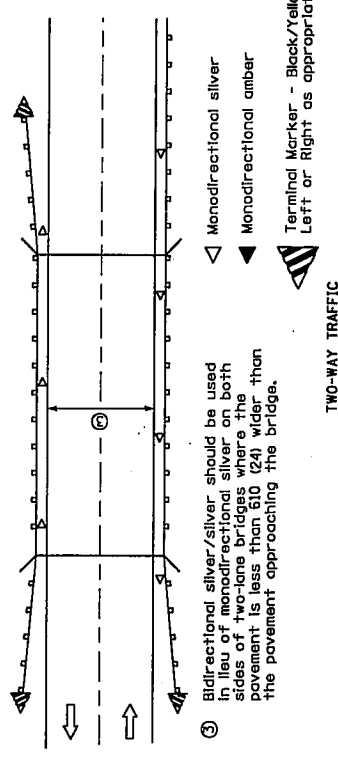
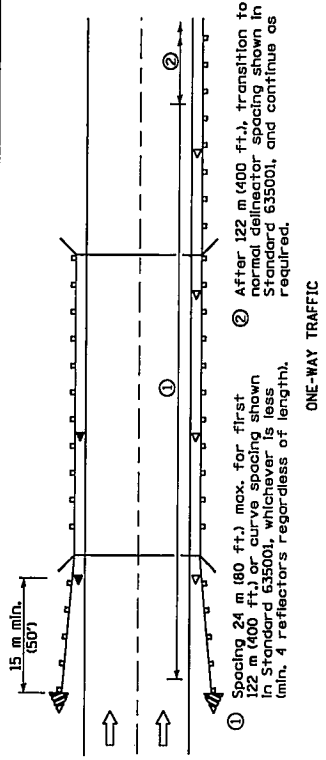

**GUARDRAIL / BARRIER WALL /
BRIDGE RAIL REFLECTORS**

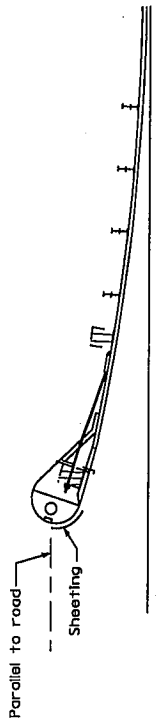

SHEETING POSITION: CASE II

All dimensions are in millimeters (inches) unless otherwise shown.

DATE	REVISIONS
I-1-02	Revise Case I Dimension and removed alternate detail.
I-1-01	Reverse direction arrow for two-way traffic view.

REFLECTOR AND TERMINAL MARKER PLACEMENT

STANDARD 635006-02

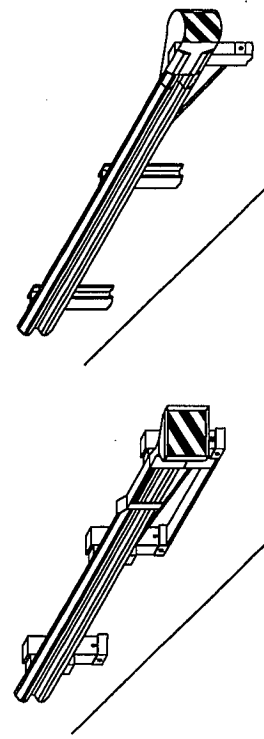

RIGHT

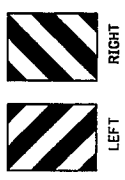

DIMENSION	CASE I	CASE II
a	*	450 (18)
b	*	406 (16)

* The width and height (a, b) of the terminal marker shall be within approximately 25 mm (1 inch) of the outer edge of the terminal end, with a minimum reflective area of 0.18 m² (288 sq. in.)

TERMINAL MARKER DETAILS
Color: Black / Yellow reflectorized

Illinois Department of Transportation

APPROVED: *[Signature]* January 1, 2002

ENGINEER OF PUBLIC WORKS

APPROVED: *[Signature]* January 1, 2002

ENGINEER OF DESIGN AND ENVIRONMENT

ISSUED 1-1-2000

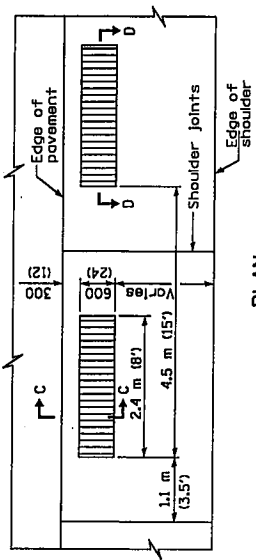

PLAN
(Formed Alternate for PCC Shoulders)

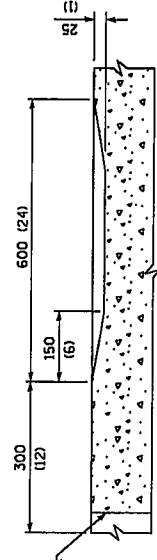

SECTION C-C

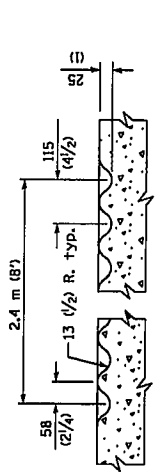

SECTION D-D

GENERAL NOTES
 On Portland cement concrete shoulders, no shoulder rumble strip shall be located closer than 150 mm (6") to a transverse joint.
 Omit shoulder rumble strips across structures.
 All dimensions are in millimeters (inches) unless otherwise shown.

DATE	REVISIONS
1-1-03	Revised rumble strip design and renumbered Std. 402101
1-1-97	Renumbered Std. 2438-1

SHOULDER RUMBLE STRIPS
STANDARD 642001

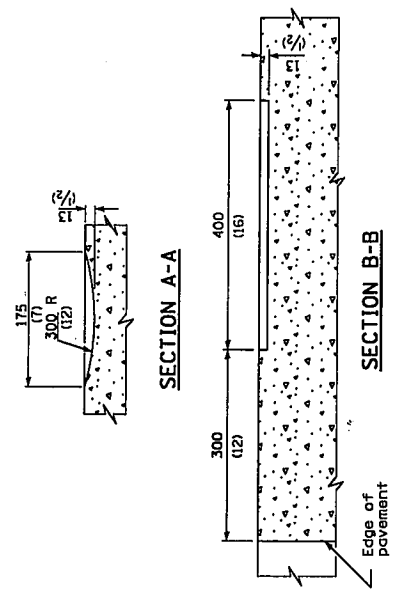

SECTION A-A

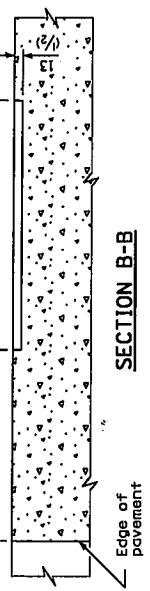

SECTION B-B

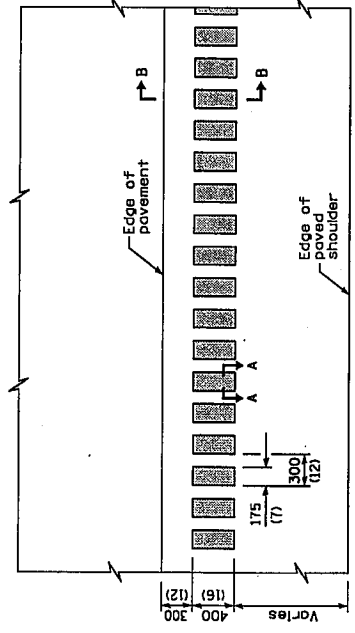

PLAN

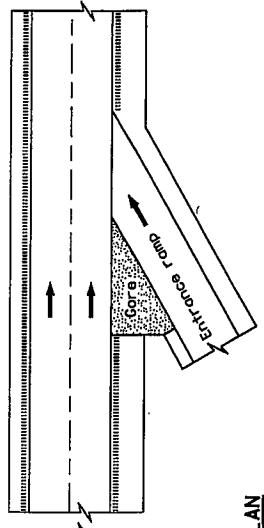

HALF PLAN
 TYPICAL APPLICATION AT AN INTERCHANGE

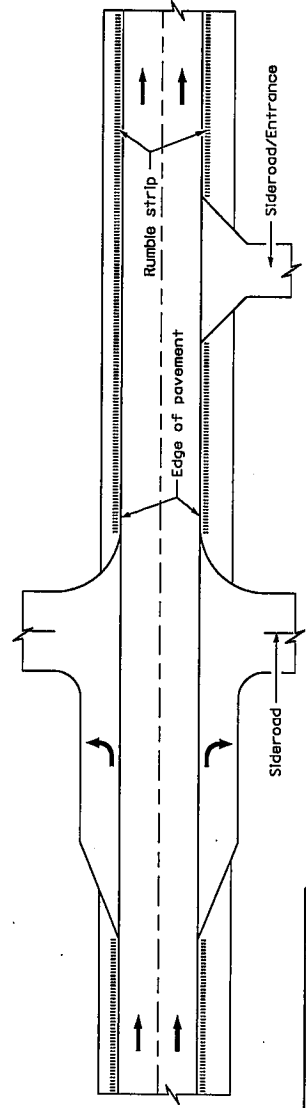

HALF PLAN
 TYPICAL APPLICATION AT AN INTERSECTION OR ENTRANCE

PASSED JANUARY 1, 2003 ENGINEER OF SAFETY AND PROCEDURES APPROVED [Signature] ENGINEER OF DESIGN AND ENVIRONMENT	ISSUED 1-1-03
	Illinois Department of Transportation

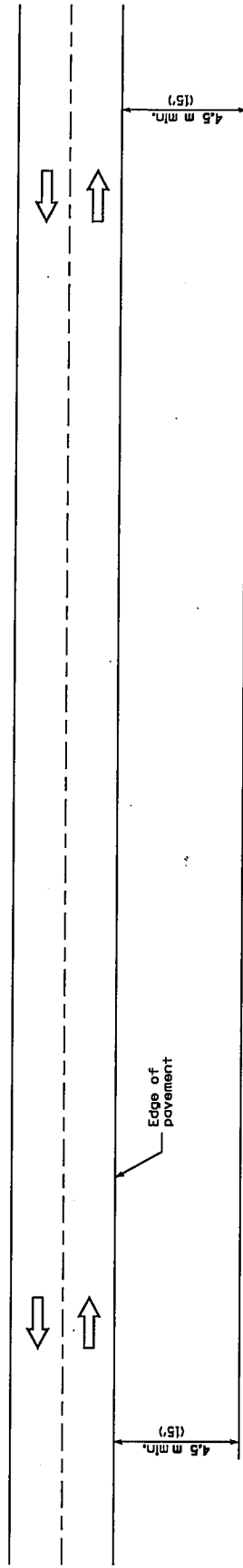

TYPICAL APPLICATIONS

- Landscaping work
- Utility work
- Fencing contracts and maintenance
- Cleaning culverts

GENERAL NOTES

This Standard is used where at all times all vehicles, equipment, workers or their activities are more than 4.5 m (15') from the edge of pavement.

When the work operation requires that two or more work vehicles close the 4.5 m (15') clear zone in any one hour, traffic control shall be according to Standard 701006.

All dimensions are in millimeters (inches) unless otherwise shown.

Ihms Department of Transportation	
APPROVED	JANUARY 1, 2005
ENGINEER OF OPERATIONS	<i>[Signature]</i>
APPROVED	JANUARY 1, 2005
	<i>[Signature]</i>
MINNESOTA DEPARTMENT OF TRANSPORTATION	

DATE	REVISIONS
1-1-05	Revised title and notes.
1-1-97	Renum. Standard 2301-6.

**OFF-ROAD OPERATIONS,
2L, 2W, MORE THAN
4.5 m (15') AWAY**

STANDARD 701001-01

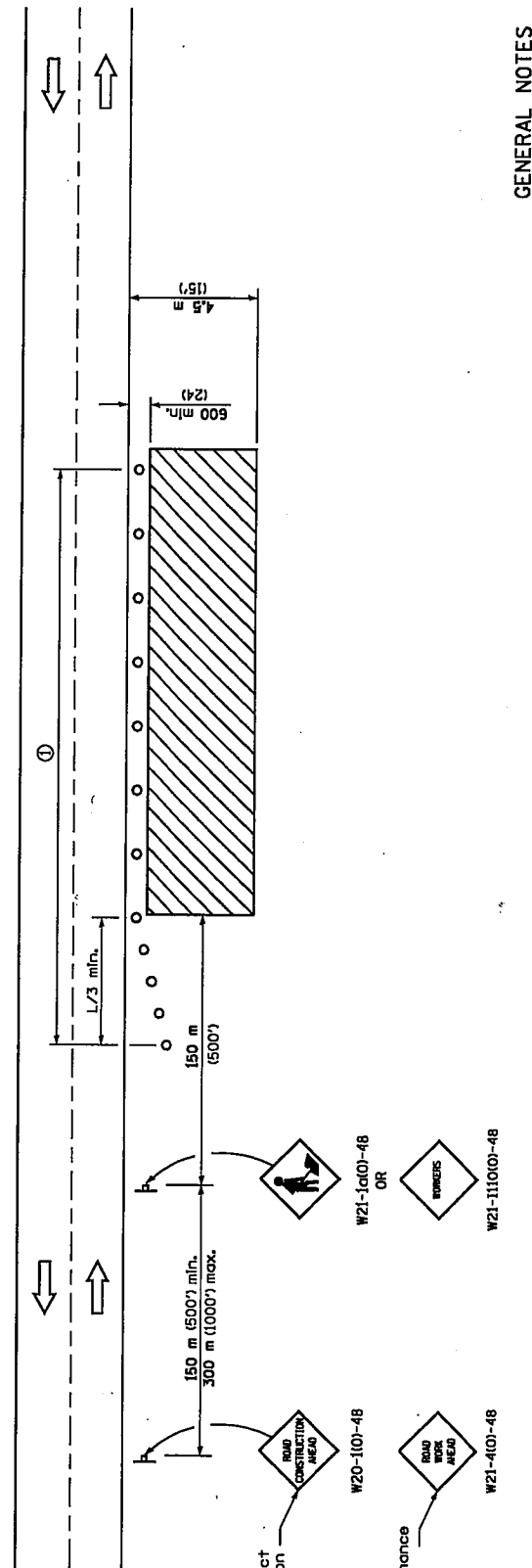

For contract construction projects

For maintenance and utility projects

GENERAL NOTES

This Standard is used where any vehicles, equipment, workers or their activities will encroach in the area 4.5 m (15') to 600 (24') from the edge of pavement.

Calculate L as follows:

SPEED LIMIT
 70 km/h (40 mph) or less: $L = \frac{WS^2}{150}$ (English)
 80 km/h (45 mph) or greater: $L = 0.65(W)(S)$ (Metric)
 $L = (W)(S)$
 W = Width of offset in meters (feet)
 S = Normal posted speed km/h (mph).

① When the work operation exceeds one hour, cones, drums or barricades shall be placed at 8 m (25') centers for L/3 distance and 15 m (50') centers through the remainder of the work area.

TYPICAL APPLICATIONS

- Utility operations
- Culvert extensions
- Side slope changes
- Guardrail installation and maintenance
- Delimitator installation
- Landscaping operations
- Shoulder repair
- Sign installation and maintenance

SYMBOLS

- Work area
- Sign
- Cone, drum or barricade

All dimensions are in millimeters (inches) unless otherwise shown.

DATE	REVISIONS
1-1-05	Revised title, notes, and sign spacing.
1-1-98	Rev. 1st GEN. NOTE.
	Rev. (24') to (24') in 3rd GEN. NOTE.

ISSUED 1-1-97

Illinois Department of Transportation

APPROVED: [Signature] 2005
 ENGINEER OF TRAFFIC CONTROL

APPROVED: [Signature] 2005
 ENGINEER OF DESIGN AND ENVIRONMENT

STANDARD 701006-02

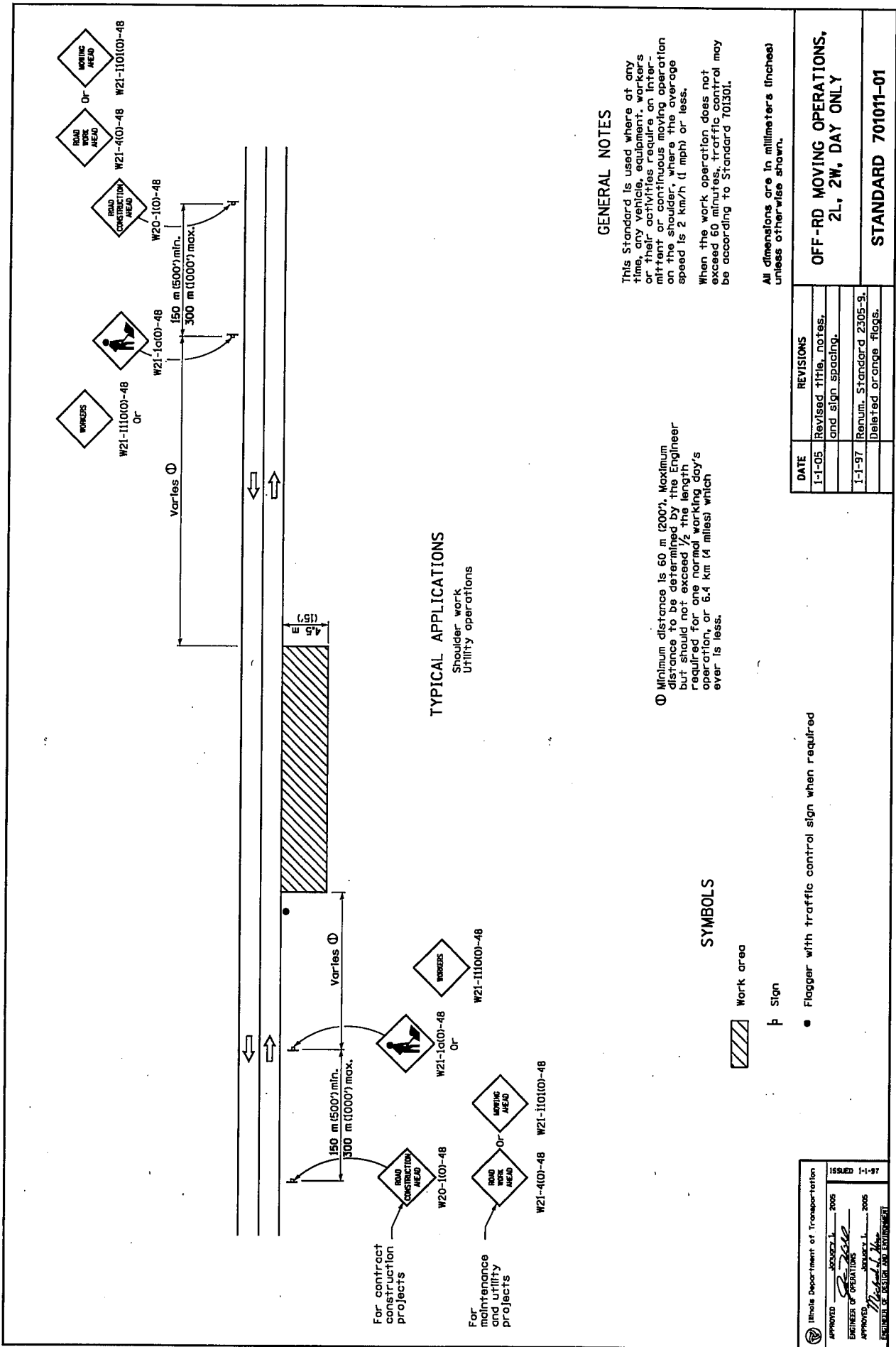

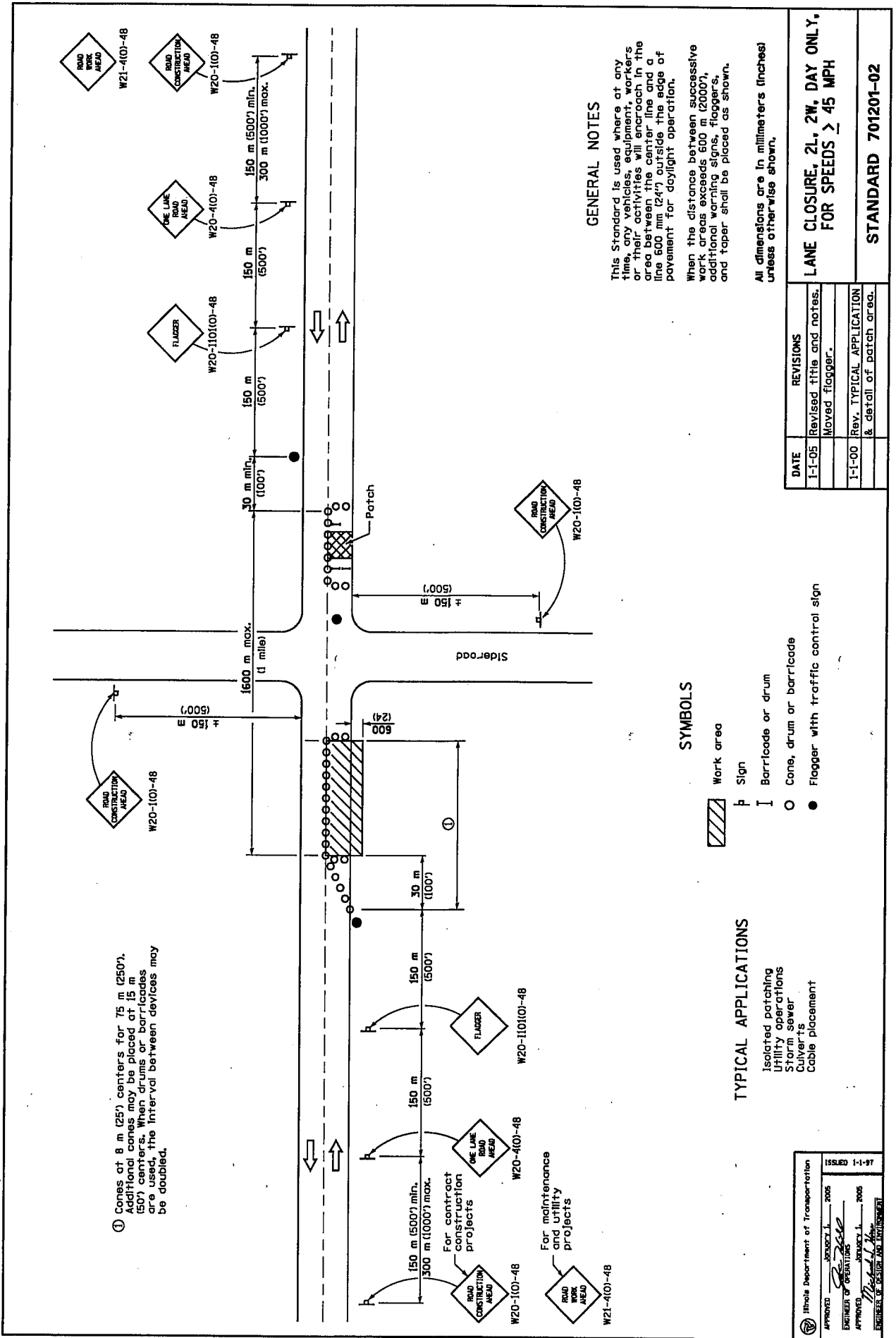

GENERAL NOTES

This Standard is used where at any time any vehicles, equipment, workers or their activities will encroach in the area between the centerline and a line 600 mm (24") outside the edge of pavement for daylight operation.

When the distance between successive work areas exceeds 600 m (2000'), additional warning signs, flaggers, and taper shall be placed as shown.

All dimensions are in millimeters (inches) unless otherwise shown.

SYMBOLS

- Work area
- Sign
- Barricade or drum
- Cone, drum or barricade
- Flagger with traffic control sign

TYPICAL APPLICATIONS

- Isolated patching
- Utility operations
- Storm sewer
- Culverts
- Cable placement

DATE	REVISIONS
1-1-05	Revised title and notes.
	Moved flagger.
1-1-00	Rev. TYPICAL APPLICATION & detail of patch area.

**LANE CLOSURE, 2L, 2W, DAY ONLY,
FOR SPEEDS > 45 MPH**

STANDARD 701201-02

APPROVED ENGINEER OF OPERATIONS	ILLINOIS DEPARTMENT OF TRANSPORTATION DIVISION OF OPERATIONS JUNE 1, 2005	ISSUED 1-1-97
	APPROVED ENGINEER OF DESIGN AND ENVIRONMENT	JUNE 1, 2005

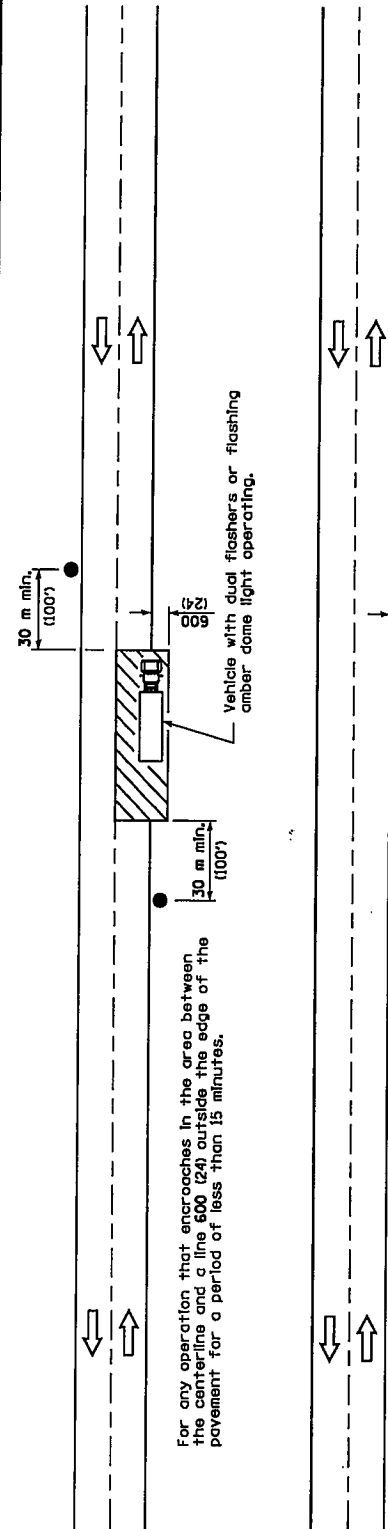

For any operation that encroaches in the area between the centerline and a line 600 (24) outside the edge of the pavement for a period of less than 15 minutes.

For any operation that is more than 600 (24) outside the edge of the pavement for a period of less than 60 minutes.

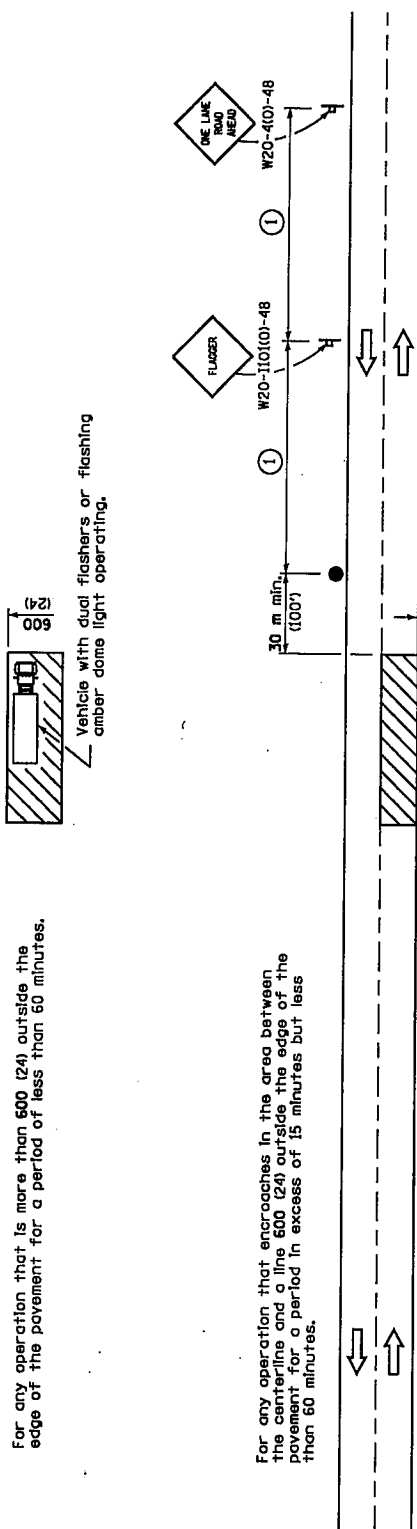

For any operation that encroaches in the area between the centerline and a line 600 (24) outside the edge of the pavement for a period in excess of 15 minutes but less than 60 minutes.

Posted Speed	Sign Spacing
55	164 m (500')
50-45	115 m (350')
<45	60 m (200')

① = Refer to SIGN SPACING table for distances.

All dimensions are in millimeters (inches) unless otherwise shown.

SYMBOLS

- Work area
- Sign on portable or permanent support
- Flagger with traffic control sign

TYPICAL APPLICATIONS

- Marking patches
- Field survey
- String line
- Utility operations
- Cleaning up debris on pavement

Illinois Department of Transportation

APPROVED: PROJECT L. 2005

ENGINEER OF DESIGN: [Signature]

APPROVED: PROJECT L. 2005

ENGINEER OF DESIGN AND ENVIRONMENT: [Signature]

ISSUED: 1-1-97

DATE	REVISIONS
1-1-05	Deleted FLAGGER SYMBOL sign.
1-1-00	Deleted "150 m" sign spacing dimension. Added SIGN SPACING table.

LANE CLOSURE, 2L, 2W, SHORT TIME OPERATIONS

STANDARD 701301-02

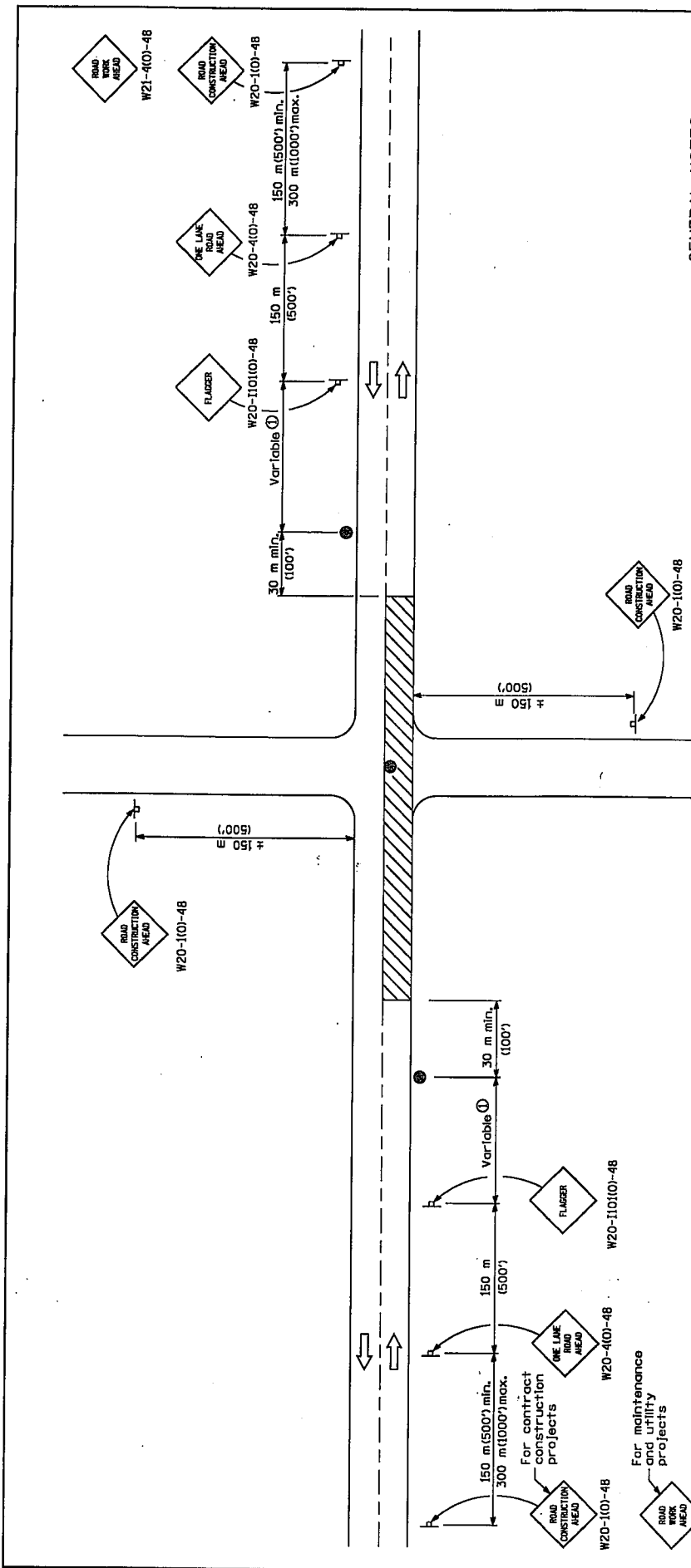

GENERAL NOTES

This Standard is used where, at any time, any vehicle, equipment, workers or their activities require an intermittent or continuous moving operation on the pavement where the average speed of movement is greater than 2 km/h (1 mph) and less than 6 km/h (4 mph).

When the operation does not exceed 60 minutes, traffic control may be according to Standard 701301.

All dimensions are in millimeters (inches) unless otherwise shown.

① Minimum distance is 60 m (200'). Maximum distance to be determined by the Engineer but shall not exceed 1/2 the length required for one working day's operation or 3200 m (2 miles), whichever ever is less.

SYMBOLS

- Work area
- Sign on portable or permanent support
- Flagger with traffic control sign

TYPICAL APPLICATIONS

- Bituminous resurfacing
- Utility operations
- Shoulder operations

LANE CLOSURE, 2L, 2W, SLOW MOVING OPERATIONS DAY ONLY, FOR SPEEDS > 45 MPH

STANDARD 701306-01

DATE	REVISIONS
I-1-05	Deleted FLAGGER SYMBOL sign and revised sign spacing.
I-1-97	Renum. Standard 2306-10. Deleted orange flags and FRESH OIL sign.

Illinois Department of Transportation

APPROVED: *[Signature]* January 1, 2005
 ENGINEER OF OPERATIONS

APPROVED: *[Signature]* January 1, 2005
 ENGINEER OF DESIGN AND ENVIRONMENT

ISSUED 1-1-97

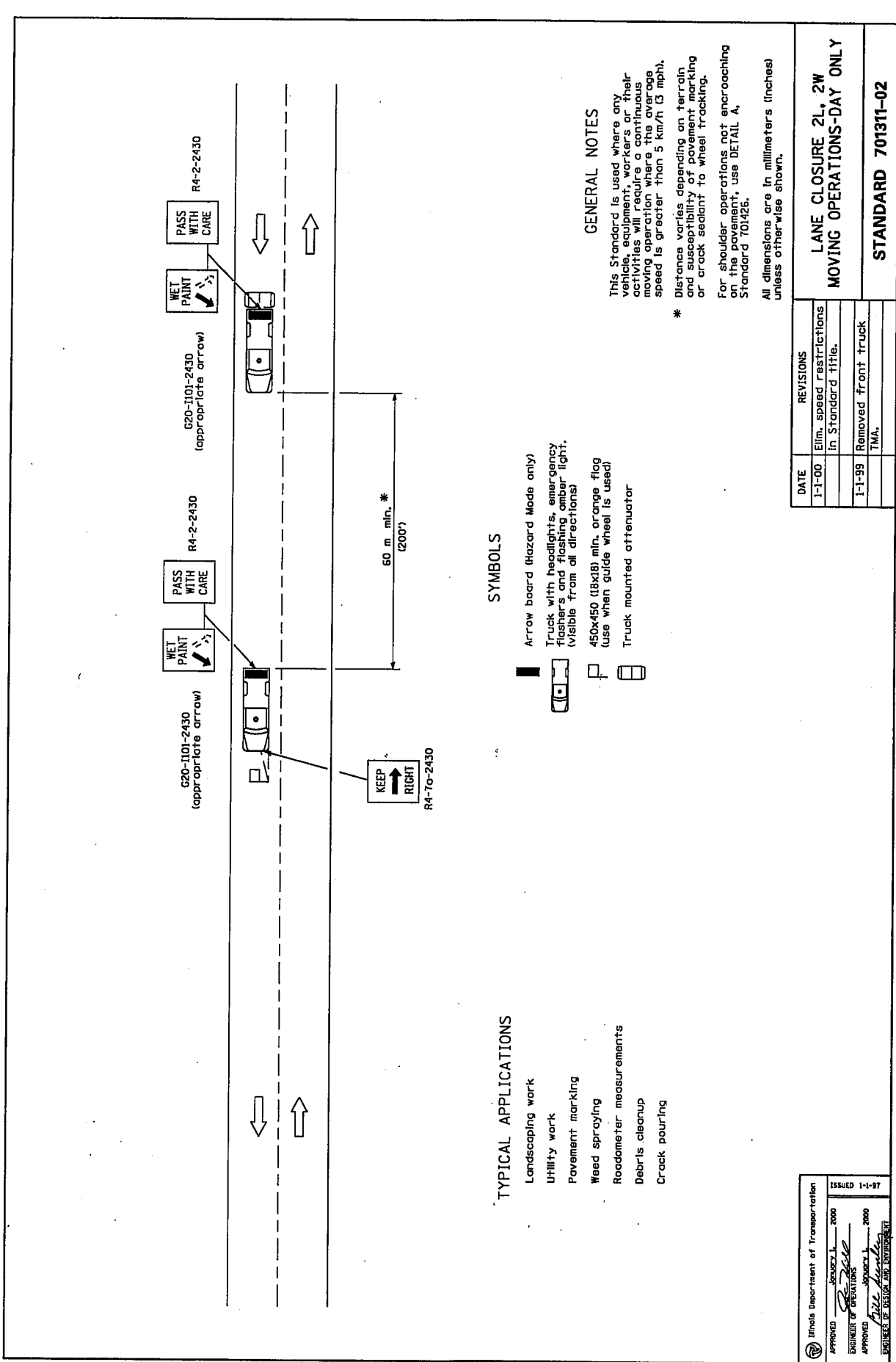

TYPICAL APPLICATIONS

- Landscape work
- Utility work
- Pavement marking
- Weed spraying
- Roadmeter measurements
- Debris cleanup
- Crack pouring

SYMBOLS

- Arrow board (Hazard Mode only)
- Truck with headlights, emergency flashers, and flashing amber light (visible from all directions)
- 450x450 (18x18) min. orange flag (use when guide wheel is used)
- Truck mounted attenuator

GENERAL NOTES

This Standard is used where any vehicle, equipment, workers or their activities will require a continuous moving operation where the average speed is greater than 5 km/h (3 mph).

* Distance varies depending on terrain and susceptibility of pavement marking or crack sealant to wheel tracking.

For shoulder operations not encroaching on the pavement, use DETAIL A.

All dimensions are in millimeters (inches) unless otherwise shown.

Illinois Department of Transportation	
APPROVED	ISSUED 1-1-97
ENGINEER OF REGULATIONS	
APPROVED	
ENGINEER OF DESIGN AND ENVIRONMENT	

LANE CLOSURE 2L, 2W MOVING OPERATIONS-DAY ONLY	
DATE	REVISIONS
1-1-00	Elim. speed restrictions in Standard title.
1-1-99	Removed front truck TMA.
STANDARD 701311-02	

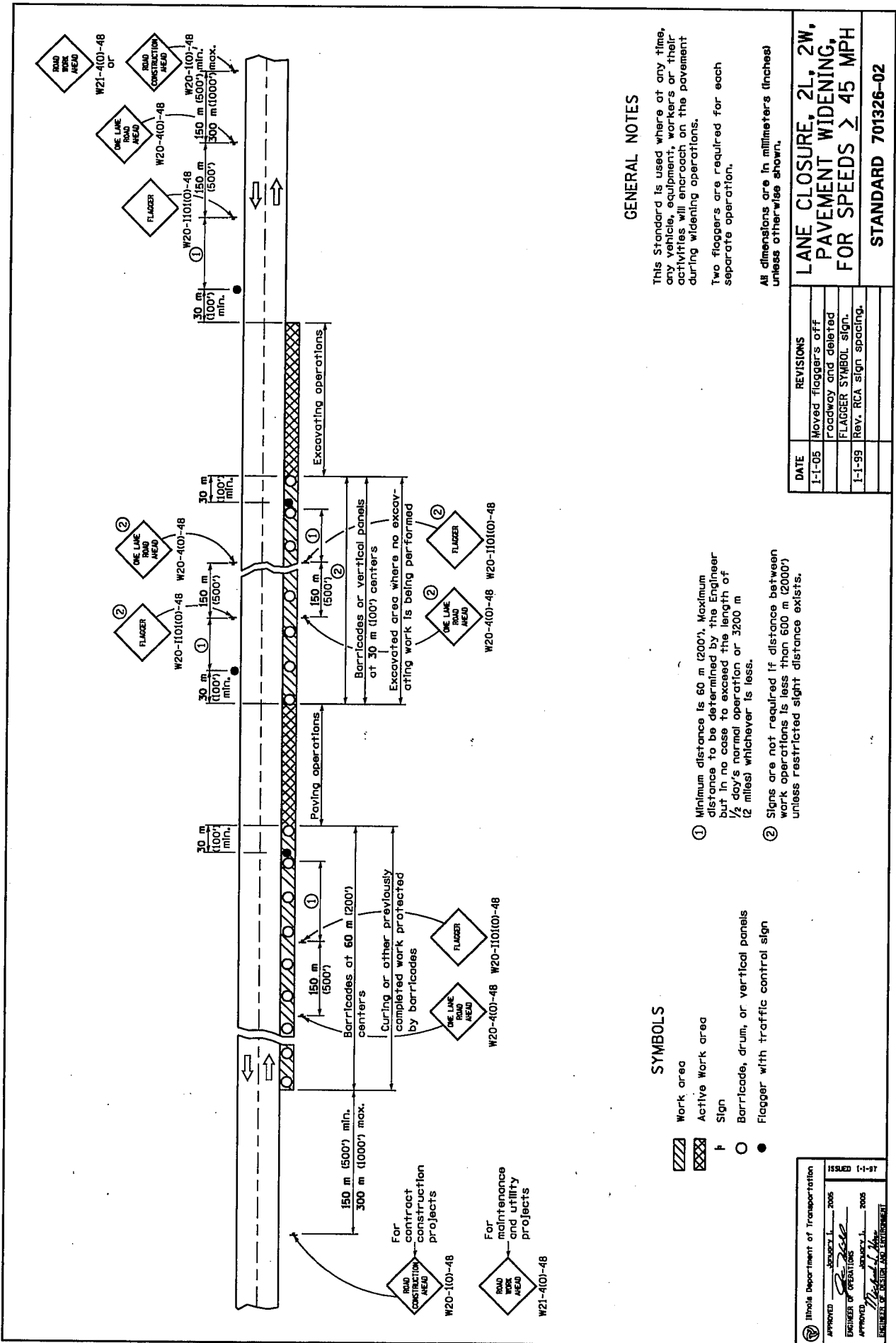

DATE	REVISIONS
1-1-05	Moved flaggers off roadway and deleted FLAGGER SYMBOL sign.
1-1-99	Rev. RCA sign spacing.

- ① Minimum distance is 60 m (200'). Maximum distance to be determined by the Engineer but in no case to exceed the length of 1/2 day's normal operation or 3200 m (2 miles) whichever is less.
- ② Signs are not required if distance between work operations is less than 600 m (2000') unless restricted sight distance exists.

Illinois Department of Transportation
 APPROVED: [Signature] JUNE 1, 2005
 ENGINEER OF OPERATIONS
 APPROVED: [Signature] JUNE 1, 2005
 ENGINEER OF SAFETY AND INSPECTION

27

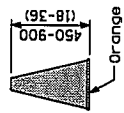

CONE

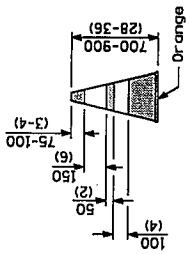

REFLECTORIZED CONE

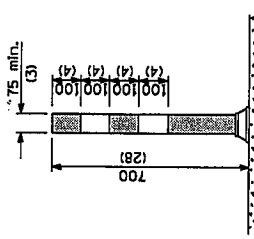

FLEXIBLE DELINEATOR

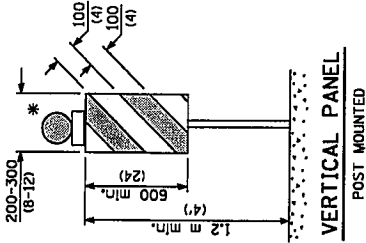

**VERTICAL PANEL
POST MOUNTED**

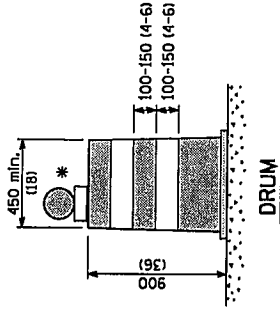

DRUM

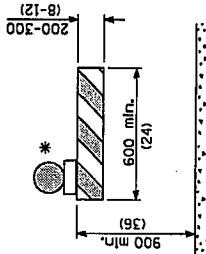

TYPE I BARRICADE

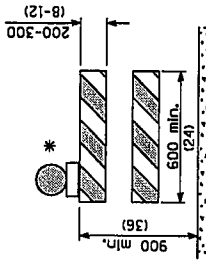

TYPE II BARRICADE

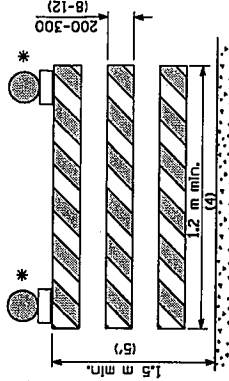

TYPE III BARRICADE

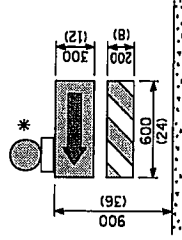

**DIRECTION INDICATOR
BARRICADE**

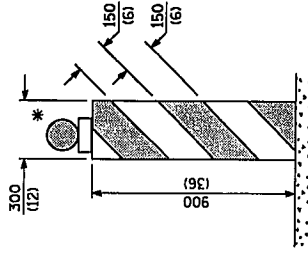

VERTICAL BARRICADE

* Warning lights (if required)

GENERAL NOTES

All heights shown shall be measured above the pavement surface.
All dimensions are in millimeters (inches) unless otherwise shown.

ILLINOIS Department of Transportation	ISSUED 1-1-11
APPROVED: JEREMY J. [Signature] 2008	
ENGINEER OF OPERATIONS	
APPROVED: [Signature] 2008	
ENGINEER OF DESIGN AND CONSTRUCTION	

DATE	REVISIONS
1-1-08	Renumbered Standard
	702001-06. Rev. note for temp. signs on Sheet 2.
4-1-06	Revised vert. barricades, post mounted signs, and signs on temp. supports.

**TRAFFIC CONTROL
DEVICES**

(Sheet 1 of 3)

STANDARD 701901

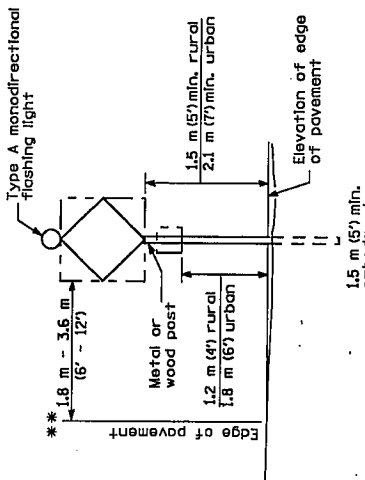

POST MOUNTED SIGNS

** When curb or paved shoulder are present this dimension shall be 500 (24) to the face of curb or 1.8 m (6') to the outside edge of the paved shoulder.

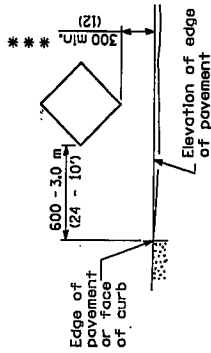

SIGNS ON TEMPORARY SUPPORTS

*** When work operations exceed four days, this dimension shall be 1.5 m (5') min. If located behind other devices, the height shall be sufficient to be seen by motorists.

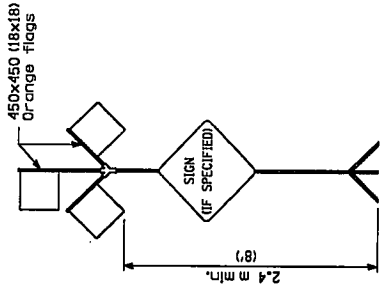

HIGH LEVEL WARNING DEVICE

ROAD CONSTRUCTION NEXT X MILES	G20-1(0)-6036
END CONSTRUCTION	G20-2a(0)-6024

This signing is required for all projects 3200 m (2 miles) or more in length.
 ROAD CONSTRUCTION NEXT X MILES sign shall be placed 150 m (500') in advance of project limits.
 END CONSTRUCTION sign shall be erected at the end of the job unless another job is within 3200 m (2 miles).
 Dual sign displays shall be utilized on multi-lane highways.

WORK LIMIT SIGNING

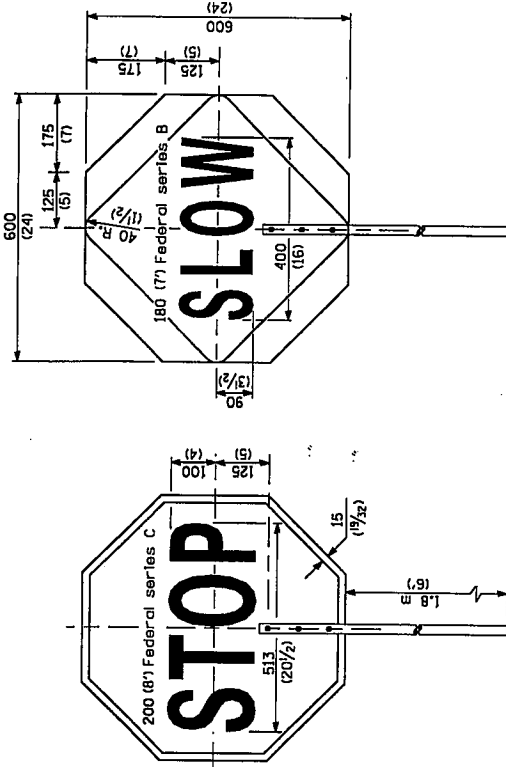

FRONT SIDE

REVERSE SIDE

FLAGGER TRAFFIC CONTROL SIGN

All dimensions are in millimeters (inches) unless otherwise shown.

Illinois Department of Transportation
 APPROVED: [Signature] JANUARY 1, 2008
 ENGINEER OF OPERATIONS
 APPROVED: [Signature] JANUARY 1, 2008
 ENGINEER OF DESIGN AND ENVIRONMENT

TRAFFIC CONTROL DEVICES

(Sheet 2 of 3)

STANDARD 701901

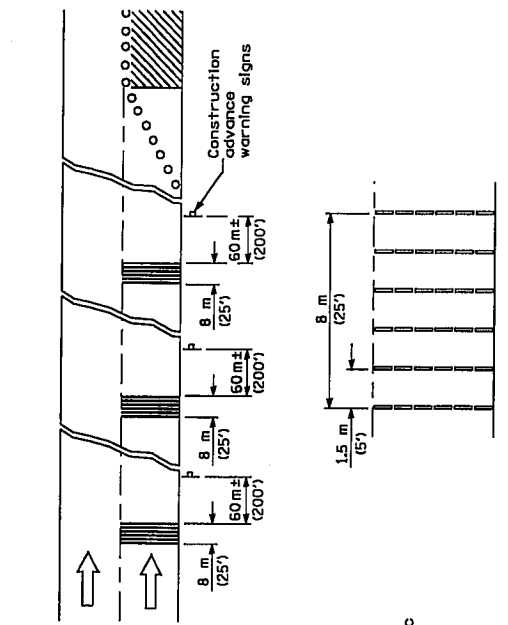

TYPICAL INSTALLATION

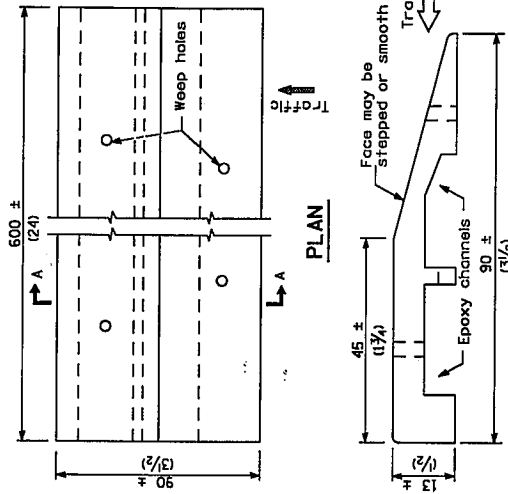

SECTION A-A

TEMPORARY RUMBLE STRIPS

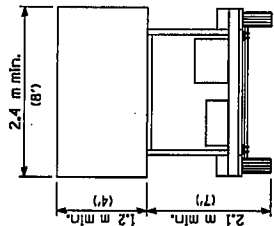

TYPE C
TRAILER
MOUNTED

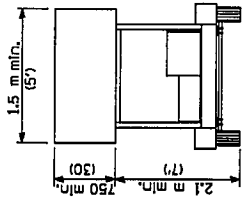

TYPE B
ROOF OR TRAILER
MOUNTED

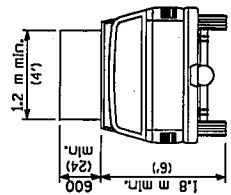

TYPE A
ROOF
MOUNTED

ARROW BOARDS

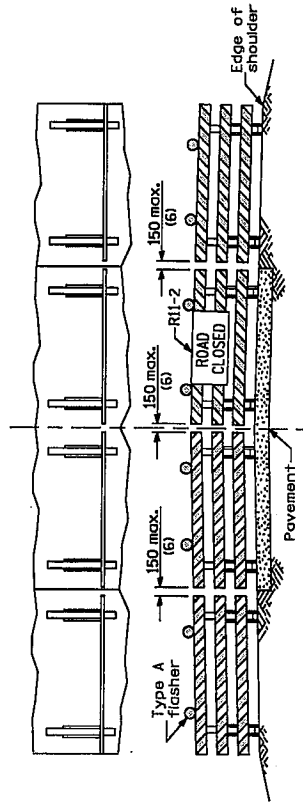

ROAD CLOSED TO ALL TRAFFIC

ReflectORIZED striping may be omitted on the back side of the barricades. If a Type III barricade with an attached sign panel which meets NCHRP 350 is not available, the sign may be mounted on an NCHRP 350 temporary sign support directly in front of the barricade.

ROAD CLOSED TO THRU TRAFFIC

ReflectORIZED striping shall appear on both sides of the barricades. If a Type III barricade with an attached sign panel which meets NCHRP 350 is not available, the signs may be mounted on NCHRP 350 temporary sign supports directly in front of the barricade.

TYPICAL APPLICATIONS OF
TYPE III BARRICADES CLOSING A ROAD

All dimensions are in millimeters (inches) unless otherwise shown.

TRAFFIC CONTROL
DEVICES
(Sheet 3 of 3)

STANDARD 701901

Illinois Department of Transportation
 APPROVED: [Signature] ISSUED: 1-1-19
 ENGINEER OF OPERATIONS: [Signature] 2008
 APPROVED: [Signature] 2008
 ENGINEER OF DESIGN AND ENVIRONMENT

Section modulus (minimum)	Axis A	Axis B
Steel	819 mm ³ (0.050 in. ³)	1720 mm ³ (0.105 in. ³)
Aluminum	2458 mm ³ (0.150 in. ³)	5162 mm ³ (0.315 in. ³)

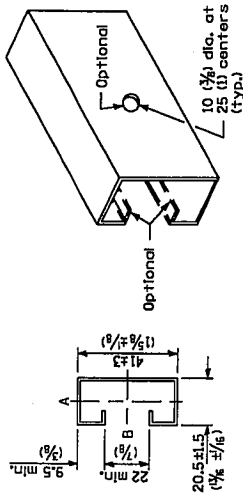

SUPPORTING CHANNEL DETAILS

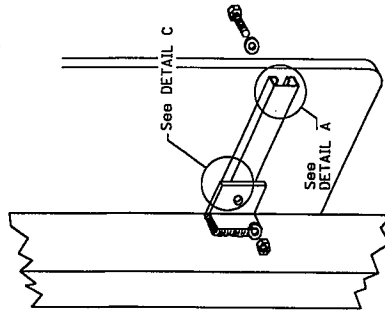

ROUTE MARKER ASSEMBLY

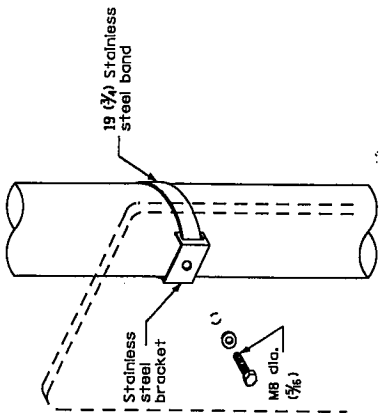

Sign panel 900 (36) wide or less

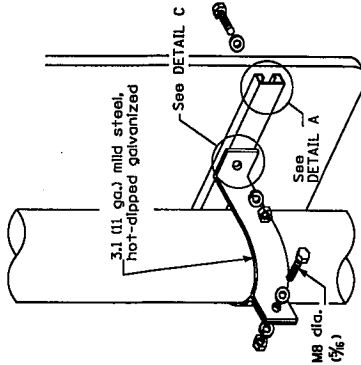

Sign panel over 900 (36) wide

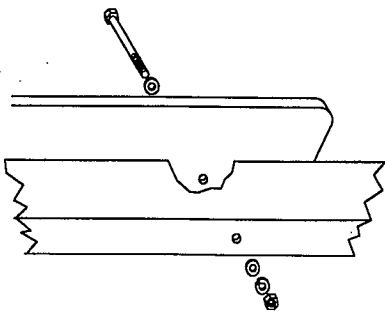

Sign panel 900 (36) wide or less

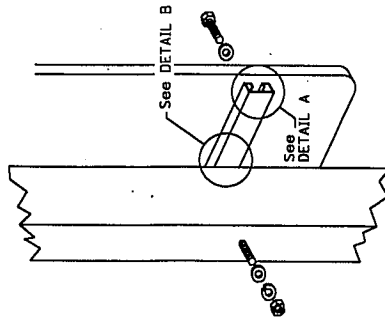

Sign panel over 900 (36) wide

LIGHT OR SIGNAL STANDARDS

WOOD OR TELESCOPING STEEL POSTS

BREAKAWAY STEEL TUBING POSTS
(All sign panel sizes)

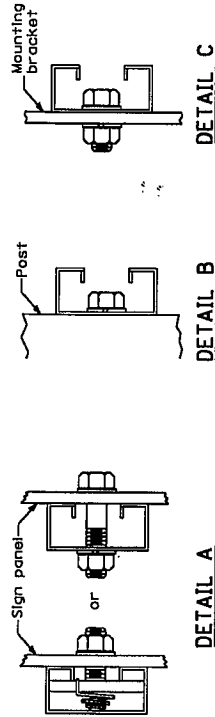

All dimensions are in millimeters (inches) unless otherwise shown.

SIGN PANEL MOUNTING DETAILS	
DATE	REVISIONS
1-1-97	Renum. Standard 2319-6.
2-1-95	Moved G. N. To Specs.
	Added metric.
STANDARD 720001	

Illinois Department of Transportation	
APPROVED	ISSUED 1-1-97
APPROVED	APPROVED
APPROVED	APPROVED
ENGINEER OF DESIGN AND ENVIRONMENT	

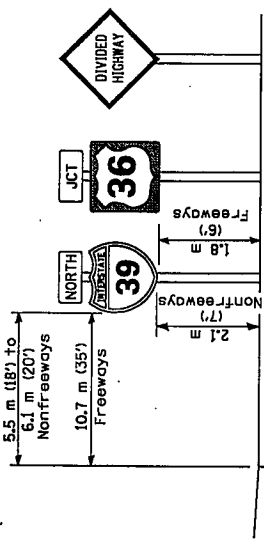

MULTILANE HIGHWAYS

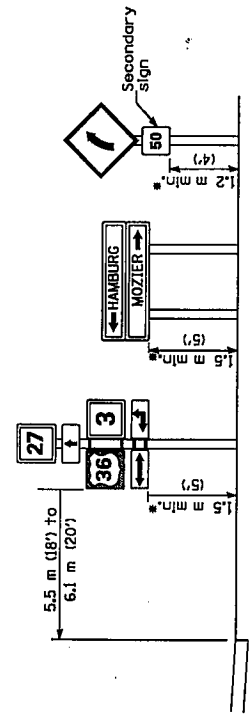

* In any area where parking is likely to occur or where there are obstructions to view or where signs are located over sidewalks, the height shall be at least 2.1 m (7').

TWO LANE RURAL HIGHWAYS

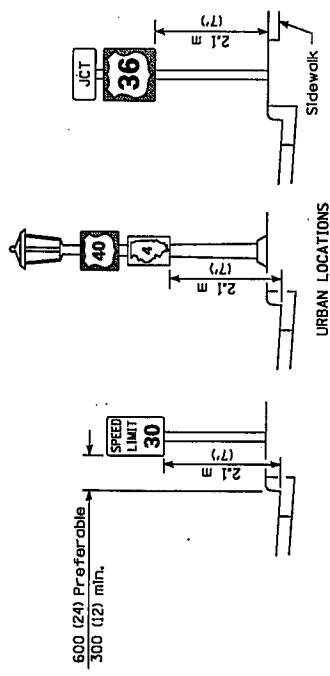

URBAN LOCATIONS

TYPICAL INSTALLATIONS
Signs in any area shall be erected to a uniform height above the edge of the pavement.

Illinois Department of Transportation
 APPROVED: [Signature] JANSOBY, L. 2007
 ENGINEER OF OPERATIONS
 APPROVED: [Signature] JANSOBY, L. 2007
 ENGINEER OF DESIGN AND ENVIRONMENT

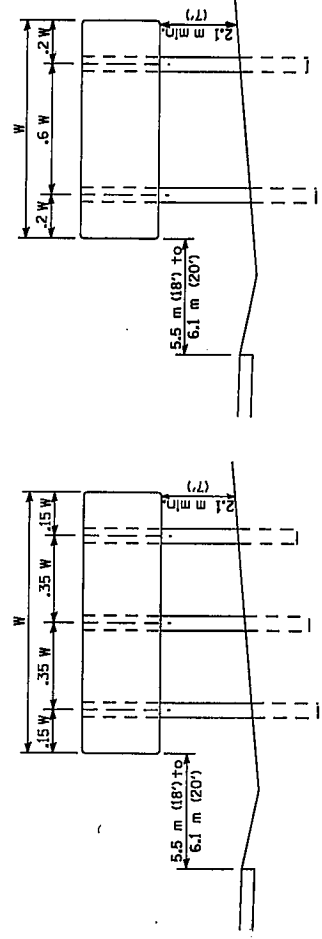

POST SPACING FOR NON-FREEWAY SIGN PANELS

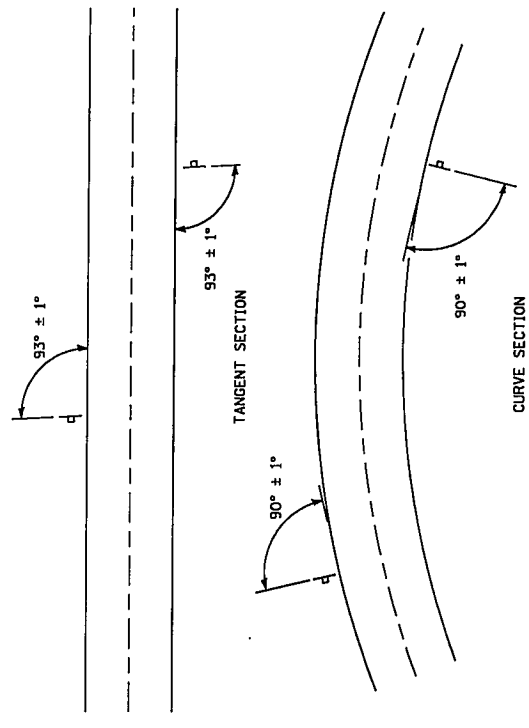

GROUND MOUNT SIGN POSITIONING

All dimensions are in millimeters (inches) unless otherwise shown.

DATE	REVISIONS
1-1-07	Deleted sheet 2.
	Telescoping steel post and base are new Sids.
1-1-97	Renum. Standard 72006-5.

SIGN PANEL ERECTION DETAILS

STANDARD 720006-01

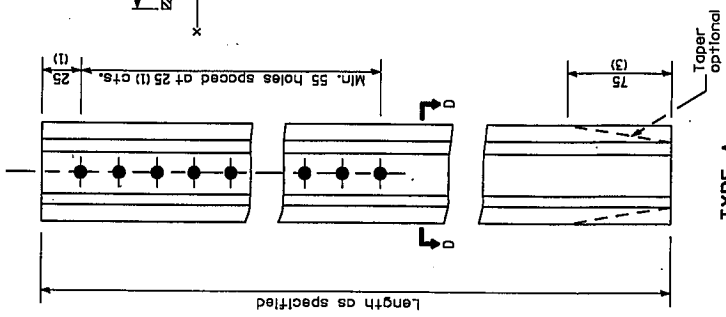

TYPE A

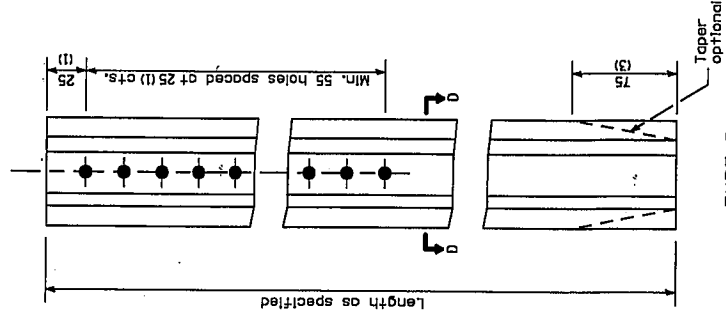

TYPE B

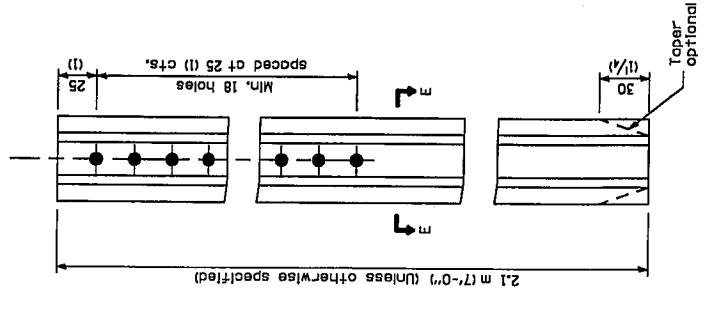

TYPE C

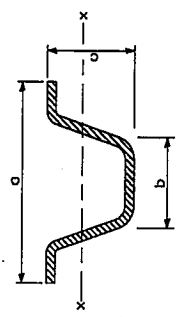

SECTION D-D

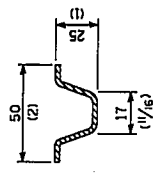

SECTION E-E

Steel - 1.67 kg/m
(0.12 lbs./ft.)

GENERAL NOTES

Dimensions shown for cross sections are minimum.
 All holes are 10 mm (3/8") diameter.
 S-x-x is the minimum section modulus about the x-x axis of the post as shown. For posts in which holes are punched or drilled for more than half their length, S-x-x shall be computed for the net section.
 All dimensions are in millimeters (inches) unless otherwise shown.

	d	b	c	S-x-x mm ³ (in. ³)	kg/m (lbs./ft.)
TYPE A	Steel	76 (3 1/8)	32 (1 1/4)	3,654 (0.223)	2.98 (2.00)
	Aluminum	89 (3 1/2)	41 (1 5/8)	7,128 (0.435)	1.34 (0.90)
TYPE B	Steel	81 (3 1/8)	32 (1 1/4)	5,588 (0.341)	4.46 (3.00)
	Aluminum	118 (4 5/8)	57 (2 1/4)	14,552 (0.888)	1.93 (1.30)

Illinois Department of Transportation
 PASSED JANUARY 1, 1987
 ENGINEER OF SAFETY AND PROCEDURES
 APPROVED BY JANUARY 1, 1987
 DIVISION OF DESIGN AND ENVIRONMENT
 ISSUED 1-1-87

DATE	REVISIONS
1-1-97	Revised Standard 2350-4.
6-15-94	Added Metric.

**METAL POSTS FOR
 SIGNS, MARKERS &
 DELINEATORS**

STANDARD 720011

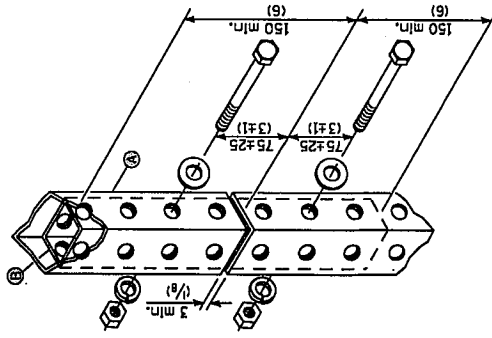

SPLICE DETAIL

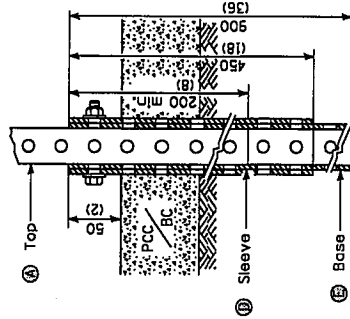

PAVEMENT MOUNT DETAIL

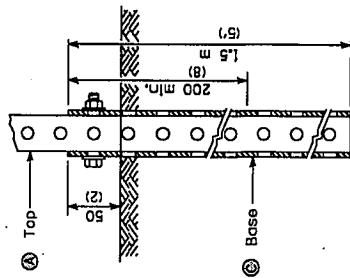

GROUND MOUNT DETAIL

(A)	51 x 51 x var. (2 x 2 x var.)
(B)	44 x 44 x 300 (1 3/4 x 1 3/4 x 12)
(C)	57 x 57 x 1500 (2 1/4 x 2 1/4 x 60)
(D)	64 x 64 x 450 (2 2/2 x 2 1/2 x 18)
(E)	57 x 57 x 900 (2 1/4 x 2 1/4 x 36)

GENERAL NOTES

All bolts M10 (3/8") hex head zinc or cadmium plated.

All dimensions are in millimeters (inches) unless otherwise shown.

DATE	REVISIONS
1-1-07	New Standard. Used to be part of Standard 720006.

TELESCOPING STEEL SIGN SUPPORT

STANDARD 728001

Illinois Department of Transportation
 APPROVED: *[Signature]* JANUARY 1, 2007
 ENGINEER OF OPERATIONS
 APPROVED: *[Signature]* JANUARY 1, 2007
 ENGINEER OF DESIGN AND ENVIRONMENT

ISSUED 1-1-07

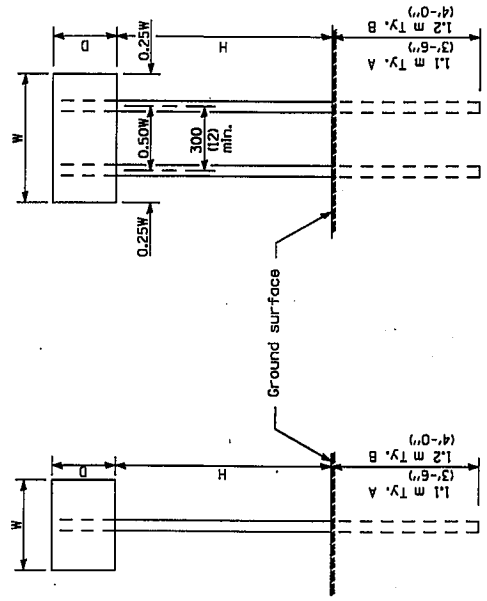

ONE POST INSTALLATION

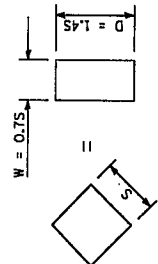

TWO POST INSTALLATION

For diamond shaped sign with side S as shown, use required post size for a sign with $W = 0.75$ and $D = 1.45$.

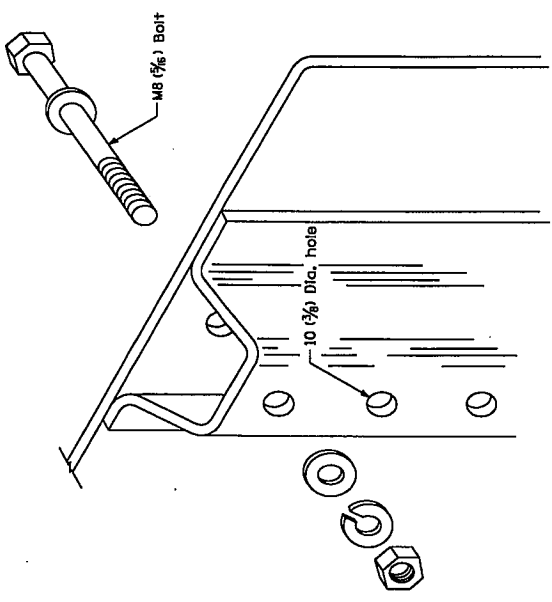

DETAIL OF MOUNTING SIGN TO POST

NOTE: Minimum of 2 bolts per post required.

SIGN DEPTH (D)	H	NO. AND TYPE OF POST FOR SIGN WIDTH (W)			
		300 (12)	450 (18)	600 (24)	750 (30)
450 (18)	1.5 m (5'-0")	A	A	A	A
	1.7 m (5'-6")	A	A	A	A
	1.8 m (6'-0")	A	A	A	A
	2.0 m (6'-6")	A	A	A	A
	2.1 m (7'-0")	A	A	A	A
	2.3 m (7'-6")	A	A	A	A
	2.4 m (8'-0")	A	A	A	A
	2.6 m (8'-6")	A	A	A	A
	2.7 m (9'-0")	A	A	A	A
600 (24)	1.5 m (5'-0")	A	A	A	A
	1.7 m (5'-6")	A	A	A	A
	1.8 m (6'-0")	A	A	A	A
	2.0 m (6'-6")	A	A	A	A
	2.1 m (7'-0")	A	A	A	A
	2.3 m (7'-6")	A	A	A	A
	2.4 m (8'-0")	A	A	A	A
	2.6 m (8'-6")	A	A	A	A
	2.7 m (9'-0")	A	A	A	A
750 (30)	1.5 m (5'-0")	A	A	A	A
	1.6 m (5'-6")	A	A	A	A
	1.8 m (6'-0")	A	A	A	A
	2.0 m (6'-6")	A	A	A	A
	2.1 m (7'-0")	A	A	A	A
	2.3 m (7'-6")	A	A	A	A
	2.4 m (8'-0")	A	A	A	A
	2.6 m (8'-6")	A	A	A	A
	2.7 m (9'-0")	A	A	A	A
900 (36)	1.5 m (5'-0")	A	A	B	2A
	1.7 m (5'-6")	A	A	B	2A
	1.8 m (6'-0")	A	A	B	2A
	2.0 m (6'-6")	A	A	B	2A
	2.1 m (7'-0")	A	A	B	2A
	2.3 m (7'-6")	A	A	B	2A
	2.4 m (8'-0")	A	A	B	2A
	2.6 m (8'-6")	A	A	B	2A
	2.7 m (9'-0")	A	A	B	2A
1.2 m (4'-0")	1.5 m (5'-0")	A	A	B	2A
	1.7 m (5'-6")	A	A	B	2A
	1.8 m (6'-0")	A	A	B	2A
	2.0 m (6'-6")	A	A	B	2A
	2.1 m (7'-0")	A	A	B	2A
	2.3 m (7'-6")	A	A	B	2A
	2.4 m (8'-0")	A	A	B	2A
	2.6 m (8'-6")	A	A	B	2A
	2.7 m (9'-0")	A	A	B	2A

GENERAL NOTES

DESIGN: Current AASHTO Standard Specifications for Structural Supports for Highway Signs, Luminaires and Traffic Signals.

LOADING: for 95 km/h (60 mph) wind velocity with 30% gust factor, normal to sign.

SOIL PRESSURE: Minimum allowable soil pressure 120 kPa (1.25 tsf).

See Standard 72001 for details of Types A and B posts.

All dimensions are in millimeters (inches) unless otherwise shown.

Illinois Department of Transportation
 PASSED: J. J. [Signature]
 APPROVED: J. J. [Signature]
 ENGINEER OF SAFETY AND PROCEDURES
 ENGINEER OF DESIGN AND ENVIRONMENT
 ISSUED 1-1-97

DATE	REVISIONS
1-1-97	Renum. Standard 2363-2.
6-15-94	Moved G.N. to Specs Added Metric

APPLICATIONS OF TYPES A & B METAL POSTS (FOR SIGNS & MARKERS)

STANDARD 729001

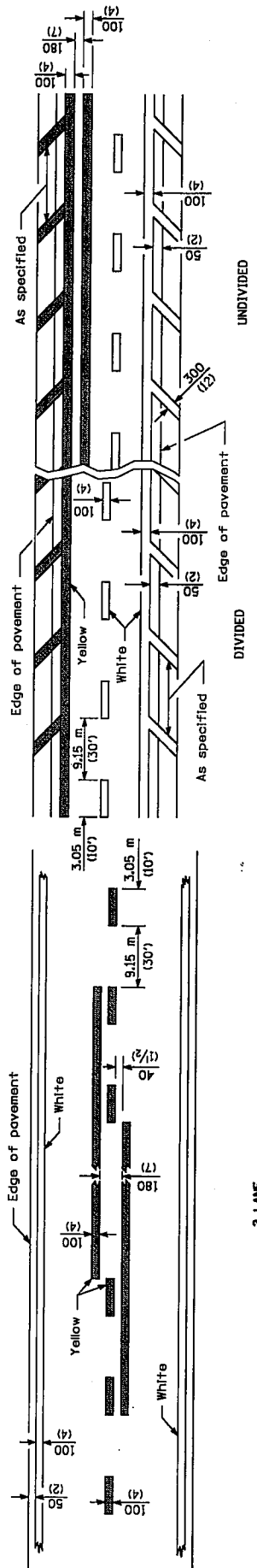

LANE AND EDGE LINES

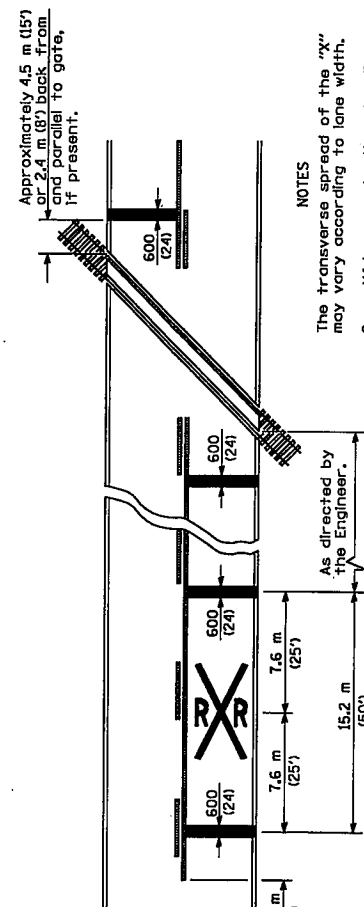

NOTES

The transverse spread of the "X" may vary according to lane width.

On multi-lane roads, the stop lines shall extend across all approach lanes and separate RRR symbols shall be placed adjacent to each other in each lane.

When the pavement marking symbol is used, a portion of the symbol should be located directly adjacent to the Advance Warning Sign (W10-1) as placed by Table II-1, condition B of the MUTCD.

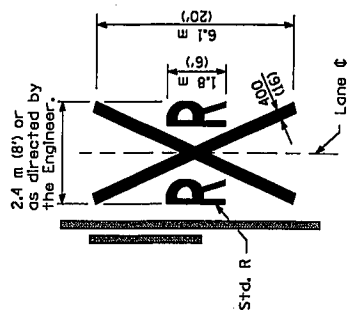

PAVEMENT MARKINGS AT RAILROAD-HIGHWAY GRADE CROSSING

All dimensions are in millimeters (inches) unless otherwise shown.

DATE	REVISIONS
1-1-99	Rev. dimen. & added 3rd note to pav't markings
1-1-97	RR-hwy grade Xing. Renum. Standard 2396-1. Revised metric values.

Illinois Department of Transportation APPROVED ENGINEER OF OPERATIONS APPROVED ENGINEER OF DESIGN AND ENVIRONMENT	JANUARY 1, 1999 <i>[Signature]</i> JANUARY 1, 1999 <i>[Signature]</i>	ISSUED 1-1-97
---	--	---------------

TYPICAL PAVEMENT MARKINGS

STANDARD 780001-01

(Sheet 1 of 2)

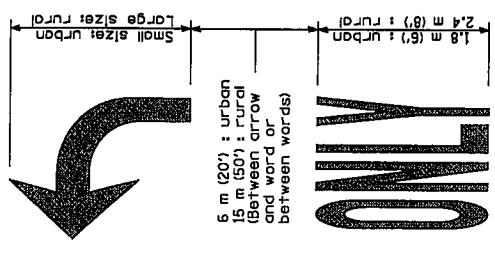
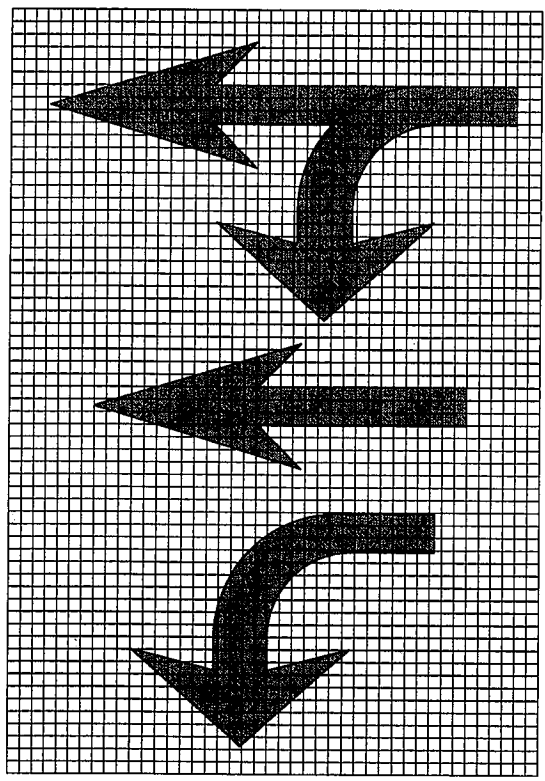
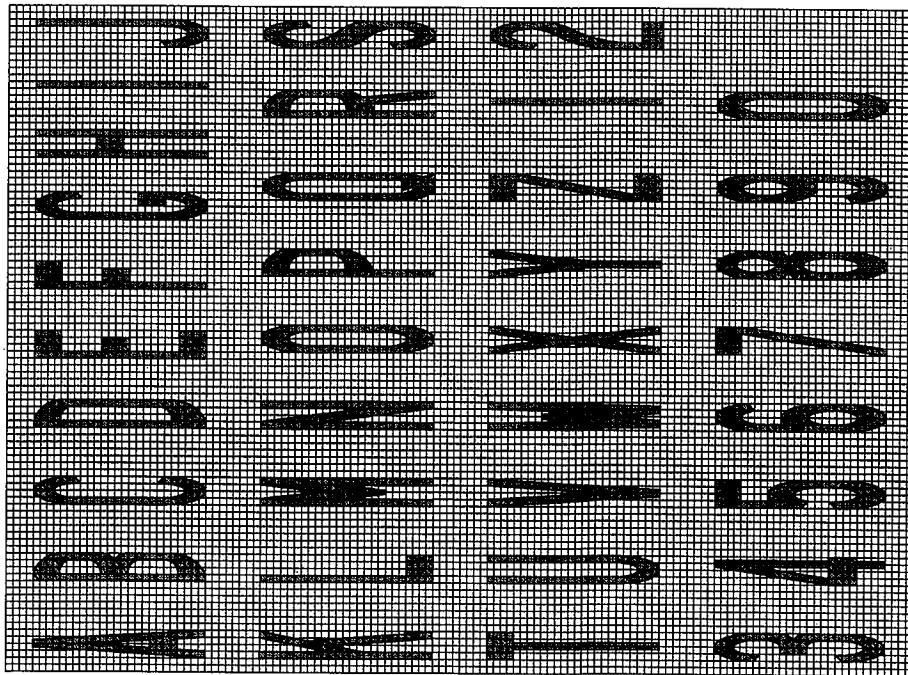

WORD AND ARROW LAYOUT

Legend Height	Arrow Size	a
1.8 m (6')	Small	74 (2.9)
2.4 m (8')	Large	96 (3.8)

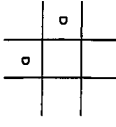

The space between adjacent letters or numerals should be approximately 75 (3) for 1.8 m (6') legend and 100 (4') for 2.4 m (8') legend.

LETTER AND ARROW GRID SCALE

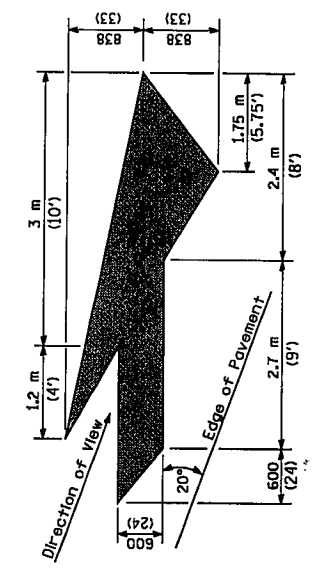

LANE DROP ARROW

Right lane drop arrow shown. Use mirror image for left lane.

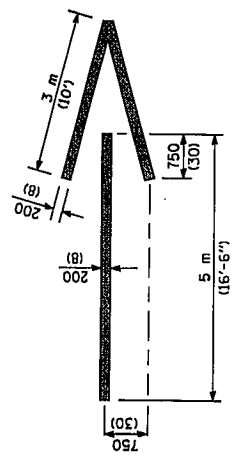

WRONG WAY ARROW

All dimensions are in millimeters (inches) unless otherwise shown.

TYPICAL PAVEMENT MARKINGS

(Sheet 2 of 2)

STANDARD 780001-01

Illinois Department of Transportation
 APPROVED: [Signature] JANUARY 1, 1999
 ENGINEER OF OPERATIONS
 APPROVED: [Signature] JANUARY 1, 1999
 ENGINEER OF DESIGN AND ENVIRONMENT

ISSUED 1-1-97

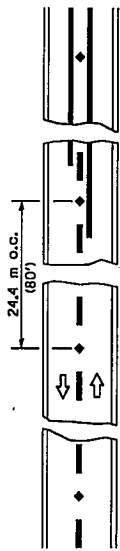

Reduce to 12.2 m (40') o.c. on curves with posted or advisory speeds of 70 km/h (45 mph) or less.

TWO-LANE / TWO-WAY

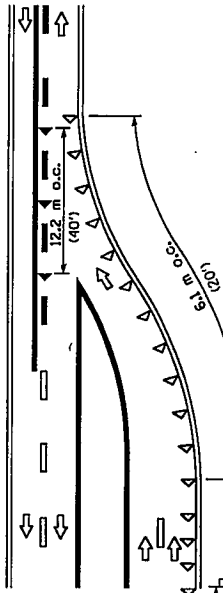

LANE REDUCTION TRANSITION

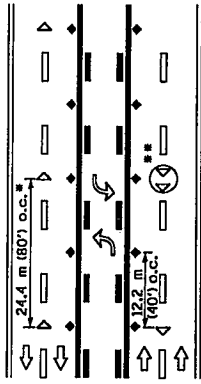

*** See MULTI LANE DIVIDED detail for lane marker notes.

TWO-WAY LEFT TURN

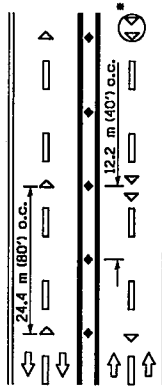

*** See MULTI LANE DIVIDED detail for lane marker notes.

MULTI-LANE UNDIVIDED

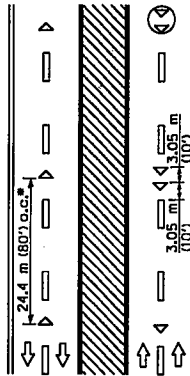

* Reduce to 12.2 m (40') o.c. on curves where advisory speeds are 15 km/h (10 mph) lower than posted speeds.

** Where double lane line markers are specified, they shall be spaced as shown.

MULTI-LANE DIVIDED

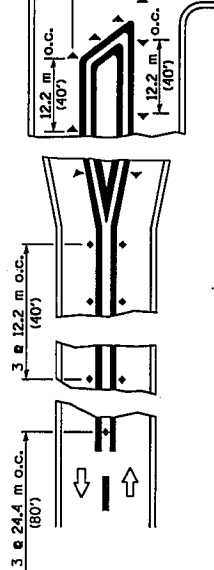

Illinois Department of Transportation
 APPROVED: [Signature] PROJECT L 1999
 ENGINEER OF CONSULTATIONS
 APPROVED: [Signature] PROJECT L 1999
 ENGINEER OF DESIGN AND EQUIPMENT

ISSUED 1-1-97

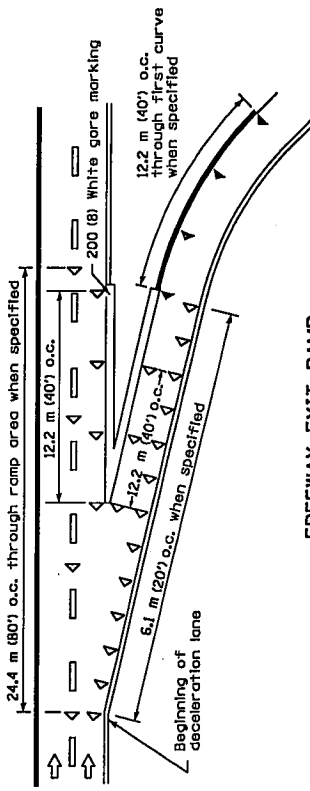

FREEWAY EXIT RAMP

SYMBOLS

- Yellow stripe
- White stripe
- One-way amber marker
- One-way crystal marker
- Two-way amber marker

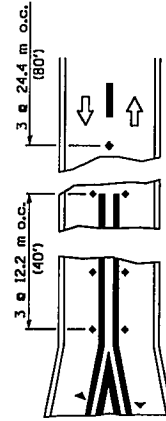

All dimensions are in millimeters (inches) unless otherwise shown.

**TYPICAL APPLICATIONS
 RAISED REFLECTIVE
 PAVEMENT MARKERS**

STANDARD 781001-02

DATE	REVISIONS
1-1-99	Extended double line to show different scenario in RURAL LEFT TURN.
1-1-98	Added "o.c." to 12.2 m dim. in RURAL LEFT TURN.

RURAL LEFT TURN

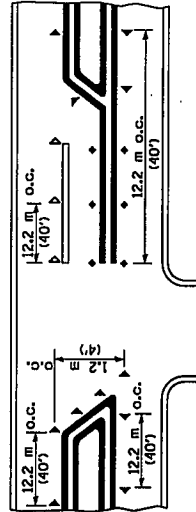

M24x200 (1x4) machine bolt with locknut furnished by the Contractor of this structure. Use plate washer D.

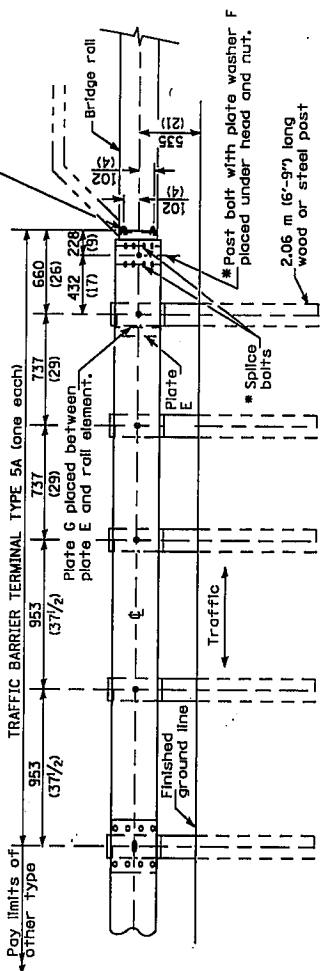

TYPE 5A - STEEL BRIDGE RAIL

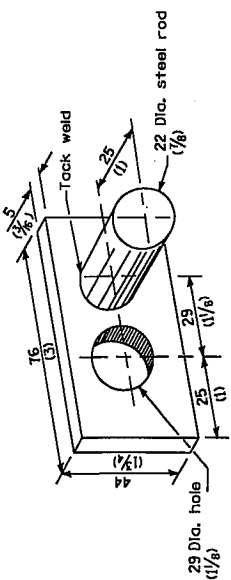
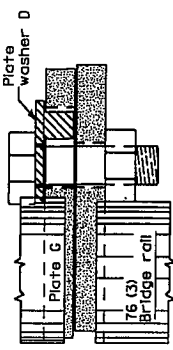

PLATE WASHER D



PLACEMENT OF PLATE WASHER D (PLAN)

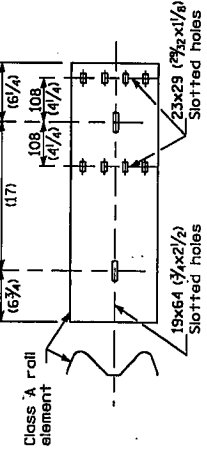

PLATE E

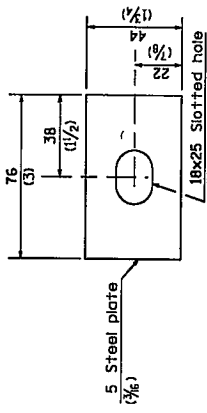

PLATE WASHER F

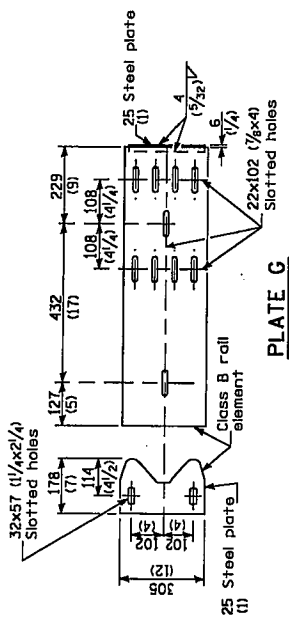

PLATE G

GENERAL NOTES

- See Standard B.L.R. 26 for details of guardrail not shown.
- Install plate washer D so the 25 mm (1") projection fills the remainder of the slotted holes in the 25 mm (1") end plate on plate G after the M24 (1") dia. bolts are in place.
- When an expansion joint exists below the connector, bolts shall be provided with a locknut or double nuts and shall be tightened only to a point that will allow plate G to be free to move.
- The face of the guardrail shall be installed flush with the face of the bridge rail.
- When this terminal is used with Standard 630021, the guardrail shall transition down to the height of the terminal.
- All dimensions are in millimeters (inches unless otherwise shown).

Issued Department of Transportation
 APPROVED: *[Signature]* 2008
 ENGINEER OF LOCAL ROADS AND STREETS
 APPROVED: *[Signature]* 2008
 ENGINEER OF DESIGN AND ENVIRONMENT

DATE	REVISIONS
1-1-08	New Standard, Was part of Std. 631026 prior to January 1, 2007.

TRAFFIC BARRIER
 TERMINAL TYPE 5A
 STANDARD B.L.R. 27

**REQUIRED CONTRACT PROVISIONS
FEDERAL-AID CONSTRUCTION CONTRACTS**

	Page
I. General	1
II. Nondiscrimination	1
III. Nonsegregated Facilities	3
IV. Payment of Predetermined Minimum Wage.....	3
V. Statements and Payrolls	6
VI. Record of Materials, Supplies, and Labor.....	7
VIII. Safety: Accident Prevention	7
IX. False Statements Concerning Highway Projects.....	7
X. Implementation of Clean Air Act and Federal Water Pollution Control Act	8
XI. Certification Regarding Debarment, Suspension, Ineligibility, and Voluntary Exclusion	8
XII. Certification Regarding Use of Contract Funds for Lobbying	9

ATTACHMENTS

- A. Employment Preference for Appalachian Contracts
(included in Appalachian contracts only)

I. GENERAL

1. These contract provisions shall apply to all work performed on the contract by the contractor's own organization and with the assistance of workers under the contractor's immediate superintendence and to all work performed on the contract by piecework, station work, or by subcontract.

2. Except as otherwise provided for in each section, the contractor shall insert in each subcontract all of the stipulations contained in these Required Contract Provisions, and further require their inclusion in any lower tier subcontract or purchase order that may in turn be made. The Required Contract Provisions shall not be incorporated by reference in any case. The prime contractor shall be responsible for compliance by any subcontractor or lower tier subcontractor with these Required Contract Provisions.

3. A breach of any of the stipulations contained in these Required Contract Provisions shall be sufficient grounds for termination of the contract.

4. A breach of the following clauses of the Required Contract Provisions may also be grounds for debarment as provided in 29 CFR 5.12:

- Section I, paragraph 2;
- Section IV, paragraphs 1, 2, 3, 4 and 7;
- Section V, paragraphs 1 and 2a through 2g.

5. Disputes arising out of the labor standards provisions of Section IV (except paragraph 5) and Section V of these Required Contract Provisions shall not be subject to the general disputes clause of this contract. Such disputes shall be resolved in accordance with the procedures of the U.S. Department of Labor (DOL) as set forth in 29 CFR 5, 6 and 7. Disputes within the meaning of this clause include disputes between the contractor (or any of its subcontractors) and the contracting agency, the DOL, or the contractor's employees or their representatives.

6. Selection of Labor: During the performance of this contract, the contractor shall not:

- a. Discriminate against labor from any other State, possession, or territory of the United States (except for employment preference for Appalachian contracts, when applicable, as specified in Attachment A), or
- b. Employ convict labor for any purpose within the limits of the project unless it is labor performed by convicts who are on parole, supervised release, or probation.

II. NONDISCRIMINATION

1. Equal Employment Opportunity: Equal employment opportunity (EEO) requirements not to discriminate and to take affirmative action to assure equal opportunity as set forth under laws, executive orders, rules, regulations (28 CFR 35, 29 CFR 1630 and 41 CFR 60 (and orders of the Secretary of Labor as modified by the provisions prescribed herein, and imposed pursuant to 23 U.S.C. 140 shall constitute the EEO and specific affirmative action standards for the contractor's project activities under this contract. The Equal Opportunity Construction Contract Specifications set forth under 41 CFR 60-4.3 and the provisions of the American Disabilities Act of 1990 (42 U.S.C. 12101 et seq.) set forth under 28 CFR 35 and 29 CFR 1630 are incorporated by reference in this contract. In the execution of this contract, the contractor agrees to comply with the following minimum specific requirement activities of EEO:

a. The contractor will work with the State highway agency (SHA) and the Federal Government in carrying out EEO obligations and in their review of his/her activities under the contract.

b. The contractor will accept as his operating policy the following statement:

"It is the policy of this Company to assure that applicants are employed, and that employees are treated during employment, without regard to their race, religion, sex, color, national origin, age or disability. Such action shall include: employment, upgrading, demotion, or transfer; recruitment or recruitment advertising; layoff or termination; rates of pay or other forms of compensation; and selection for training, including apprenticeship, preapprenticeship, and/or on-the-job-training."

2. EEO Officer: The contractor will designate and make known to the SHA contracting officers an EEO Officer who will have the responsibility for an must be capable of effectively administering and promoting an active contractor program of EEO and who must be assigned adequate authority and responsibility to do so.

3. Dissemination of Policy: All members of the contractor's staff who are authorized to hire, supervise, promote, and discharge employees, or who recommend such action, or who are substantially involved in such action, will be made fully cognizant of, and will implement, the contractor's EEO policy and contractual responsibilities to provide EEO in each grade and classification of employment. To ensure that the above

agreement will be met, the following actions will be taken as a minimum:

a. Periodic meetings of supervisory and personnel office employees will be conducted before the start of work and then not less often than once every six months, at which time the contractor's EEO policy and its implementation will be reviewed and explained. The meetings will be conducted by the EEO Officer.

b. All new supervisory or personnel office employees will be given a thorough indoctrination by the EEO Officer, covering all major aspects of the contractor's EEO obligations within thirty days following their reporting for duty with the contractor.

c. All personnel who are engaged in direct recruitment for the project will be instructed by the EEO Officer in the contractor's procedures for locating and hiring minority group employees.

d. Notices and posters setting forth the contractor's EEO policy will be placed in areas readily accessible to employees, applicants for employment and potential employees.

e. The contractor's EEO policy and the procedures to implement such policy will be brought to the attention of employees by means of meetings, employee handbooks, or other appropriate means.

4. Recruitment: When advertising for employees, the contractor will include in all advertisements for employees the notation: "An Equal Opportunity Employer." All such advertisements will be placed in publications having a large circulation among minority groups in the area from which the project work force would normally be derived.

a. The contractor will, unless precluded by a valid bargaining agreement, conduct systematic and direct recruitment through public and private employees referral sources likely to yield qualified minority group applicants. To meet this requirement, the contractor will identify sources of potential minority group employees, and establish which such identified sources procedures whereby minority group applicants may be referred to the contractor for employment consideration.

b. In the event the contractor has a valid bargaining agreement providing for exclusive hiring hall referrals, he is expected to observe the provisions of that agreement to the extent that the system permits the contractor's compliance with EEO contract provisions. (The DOL has held that where implementation of such agreements have the effect of discriminating against minorities or women, or obligates the contractor to do the same, such implementation violates Executive Order 11246, as amended.)

c. The contractor will encourage his present employees to refer minority group applicants for employment. Information and procedures with regard to referring minority group applicants will be discussed with employees.

5. Personnel Actions: Wages, working conditions, and employee benefits shall be established and administered, and personnel actions of every type, including hiring, upgrading, promotion, transfer, demotion, layoff, and termination, shall be taken without regard to race, color, religion, sex, national origin, age or disability. The following procedures shall be followed:

a. The contractor will conduct periodic inspections of project sites to insure that working conditions and employee facilities do not indicate discriminatory treatment of project site personnel.

b. The contractor will periodically evaluate the spread of wages paid within each classification to determine any

evidence of discriminatory wage practices.

c. The contractor will periodically review selected personnel actions in depth to determine whether there is evidence of discrimination. Where evidence is found, the contractor will promptly take corrective action. If the review indicates that the discrimination may extend beyond the actions reviewed, such corrective action shall include all affected persons.

d. The contractor will promptly investigate all complaints of alleged discrimination made to the contractor in connection with his obligations under this contract, will attempt to resolve such complaints, and will take appropriate corrective action within a reasonable time. If the investigation indicates that the discrimination may affect persons other than the complainant, such corrective action shall include such other persons. Upon completion of each investigation, the contractor will inform every complainant of all of his avenues of appeal.

6. Training and Promotion:

a. The contractor will assist in locating, qualifying, and increasing the skills of minority group and women employees, and applicants for employment.

b. Consistent with the contractor's work force requirements and as permissible under Federal and State regulations, the contractor shall make full use of training programs, i.e., apprenticeship, and on-the-job training programs for the geographical area of contract performance. Where feasible, 25 percent of apprentices or trainees in each occupation shall be in their first year of apprenticeship or training. In the event a special provision for training is provided under this contract, this subparagraph will be superseded as indicated in the special provision.

c. The contractor will advise employees and applicants for employment of available training programs and entrance requirements for each.

d. The contractor will periodically review the training and promotion potential of minority group and women employees and will encourage eligible employees to apply for such training and promotion.

7. Unions: If the contractor relies in whole or in part upon unions as a source of employees, the contractor will use his/her best efforts to obtain the cooperation of such unions to increase opportunities for minority groups and women within the unions, and to effect referrals by such unions of minority and female employees. Actions by the contractor either directly or through a contractor's association acting as agent will include the procedures set forth below:

a. The contractor will use best efforts to develop, in cooperation with the unions, joint training programs aimed toward qualifying more minority group members and women for membership in the unions and increasing the skills of minority group employees and women so that they may qualify for higher paying employment.

b. The contractor will use best efforts to incorporate an EEO clause into each union agreement to the end that such union will be contractually bound to refer applicants without regard to their race, color, religion, sex, national origin, age or disability.

c. The contractor is to obtain information as to the referral practices and policies of the labor union except that to the extent such information is within the exclusive possession of the labor union and such labor union refuses to furnish such information to the contractor, the contractor shall so certify to

the SHA and shall set forth what efforts have been made to obtain such information.

d. In the event the union is unable to provide the contractor with a reasonable flow of minority and women referrals within the time limit set forth in the collective bargaining agreement, the contractor will, through independent recruitment efforts, fill the employment vacancies without regard to race, color, religion, sex, national origin, age or disability; making full efforts to obtain qualified and/or quailifiable minority group persons and women. (The DOL has held that it shall be no excuse that the union with which the contractor has a collective bargaining agreement providing for exclusive referral failed to refer minority employees.) In the event the union referral practice prevents the contractor from meeting the obligations pursuant to Executive Order 11246, as amended, and these special provisions, such contractor shall immediately notify the SHA.

8. Selection of Subcontractors, Procurement of Materials and Leasing of Equipment: The contractor shall not discriminate on the grounds of race, color, religion, sex, national origin, age or disability in the selection and retention of subcontractors, including procurement of materials and leases of equipment.

a. The contractor shall notify all potential subcontractors and suppliers of his/her EEO obligations under this contract.

b. Disadvantaged business enterprises (DBE), as defined in 49 CFR 23, shall have equal opportunity to compete for and perform subcontracts which the contractor enters into pursuant to this contract. The contractor will use his best efforts to solicit bids from and to utilize DBE subcontractors or subcontractors with meaningful minority group and female representation among their employees. Contractors shall obtain lists of DBE construction firms from SHA personnel.

c. The contractor will use his best efforts to ensure subcontractor compliance with their EEO obligations.

9. Records and Reports: The contractor shall keep such records as necessary to document compliance with the EEO requirements. Such records shall be retained for a period of three years following completion of the contract work and shall be available at reasonable times and places for inspection by authorized representatives of the SHA and the FHWA.

a. The records kept by the contractor shall document the following:

(1) The number of minority and non-minority group members and women employed in each work classification on the project;

(2) The progress and efforts being made in cooperation with unions, when applicable, to increase employment opportunities for minorities and women;

(3) The progress and efforts being made in locating, hiring, training, qualifying, and upgrading minority and female employees; and

(4) The progress and efforts being made in securing the services of DBE subcontractors or subcontractors with meaningful minority and female representation among their employees.

b. The contractors will submit an annual report to the SHA each July for the duration of the project, indicating the number of minority, women, and non-minority group employees currently engaged in each work classification required by the contract work. This information is to be reported on Form FHWA-1391. If on-the-job training is being required by special provision, the contractor will be required to collect and report training data.

III. NONSEGREGATED FACILITIES

(Applicable to all Federal-aid construction contracts and to all related subcontracts of \$10,000 or more.)

a. By submission of this bid, the execution of this contract or subcontract, or the consummation of this material supply agreement or purchase order, as appropriate, the bidder, Federal-aid construction contractor, subcontractor, material supplier, or vendor, as appropriate, certifies that the firm does not maintain or provide for its employees any segregated facilities at any of its establishments, and that the firm does not permit its employees to perform their services at any location, under its control, where segregated facilities are maintained. The firm agrees that a breach of this certification is a violation of the EEO provisions of this contract. The firm further certifies that no employee will be denied access to adequate facilities on the basis of sex or disability.

b. As used in this certification, the term "segregated facilities" means any waiting rooms, work areas, restrooms and washrooms, restaurants and other eating areas, timeclocks, locker rooms, and other storage or dressing areas, parking lots, drinking fountains, recreation or entertainment areas, transportation, and housing facilities provided for employees which are segregated by explicit directive, or are, in fact, segregated on the basis of race, color, religion, national origin, age or disability, because of habit, local custom, or otherwise. The only exception will be for the disabled when the demands for accessibility override (e.g. disabled parking).

c. The contractor agrees that it has obtained or will obtain identical certification from proposed subcontractors or material suppliers prior to award of subcontracts or consummation of material supply agreements of \$10,000 or more and that it will retain such certifications in its files.

IV. PAYMENT OF PREDETERMINED MINIMUM WAGE

(Applicable to all Federal-aid construction contracts exceeding \$2,000 and to all related subcontracts, except for projects located on roadways classified as local roads or rural minor collectors, which are exempt.)

1. General:

a. All mechanics and laborers employed or working upon the site of the work will be paid unconditionally and not less often than once a week and without subsequent deduction or rebate on any account [except such payroll deductions as are permitted by regulations (29 CFR 3) issued by the Secretary of Labor under the Copeland Act (40 U.S.C. 276c)] the full amounts of wages and bona fide fringe benefits (or cash equivalents thereof) due at time of payment. The payment shall be computed at wage rates not less than those contained in the wage determination of the Secretary of Labor (hereinafter "the wage determination") which is attached hereto and made a part hereof, regardless of any contractual relationship which may be alleged to exist between the

contractor or its subcontractors and such laborers and mechanics. The wage determination (including any additional classifications and wage rates conformed under paragraph 2 of this Section IV and the DOL poster (WH-1321) or Form FHWA-1495) shall be posted at all times by the contractor and its subcontractors at the site of the work in a prominent and accessible place where it can be easily seen by the workers. For the purpose of this Section, contributions made or costs reasonably anticipated for bona fide fringe benefits under Section 1(b)(2) of the Davis-Bacon Act (40 U.S.C. 276a) on behalf of laborers or mechanics are considered wages paid to such laborers or mechanics, subject to the provisions of Section IV, paragraph 3b, hereof. Also, for the purpose of this Section, regular contributions made or costs incurred for more than a weekly period (but not less often than quarterly) under plans, funds, or programs, which cover the particular weekly period, are deemed to be constructively made or incurred during such weekly period. Such laborers and mechanics shall be paid the appropriate wage rate and fringe benefits on the wage determination for the classification of work actually performed, without regard to skill, except as provided in paragraphs 4 and 5 of this Section IV.

b. Laborers or mechanics performing work in more than one classification may be compensated at the rate specified for each classification for the time actually worked therein, provided, that the employer's payroll records accurately set forth the time spent in each classification in which work is performed.

c. All rulings and interpretations of the Davis-Bacon Act and related acts contained in 29 CFR 1, 3, and 5 are herein incorporated by reference in this contract.

2. Classification:

a. The SHA contracting officer shall require that any class of laborers or mechanics employed under the contract, which is not listed in the wage determination, shall be classified in conformance with the wage determination.

b. The contracting officer shall approve an additional classification, wage rate and fringe benefits only when the following criteria have been met:

(1) the work to be performed by the additional classification requested is not performed by a classification in the wage determination;

(2) the additional classification is utilized in the area by the construction industry;

(3) the proposed wage rate, including any bona fide fringe benefits, bears a reasonable relationship to the wage rates contained in the wage determination; and

(4) with respect to helpers, when such a classification prevails in the area in which the work is performed.

c. If the contractor or subcontractors, as appropriate, the laborers and mechanics (if known) to be employed in the additional classification or their representatives, and the contracting officer agree on the classification and wage rate (including the amount designated for fringe benefits where appropriate), a report of the action taken shall be sent by the contracting officer to the DOL, Administrator of the Wage and Hour Division, Employment Standards Administration, Washington, D.C. 20210. The Wage and Hour Administrator, or an authorized representative, will approve, modify, or

disapprove every additional classification action within 30 days of receipt and so advise the contracting officer or will notify the contracting officer within the 30-day period that additional time is necessary.

d. In the event the contractor or subcontractors, as appropriate, the laborers or mechanics to be employed in the additional classification or their representatives, and the contracting officer do not agree on the proposed classification and wage rate (including the amount designated for fringe benefits, where appropriate), the contracting officer shall refer the question, including the views of all interested parties and the recommendation of the contracting officer, to the Wage and Hour Administrator for determination. Said Administrator, or an authorized representative, will issue a determination within 30 days of receipt and so advise the contracting officer or will notify the contracting officer within the 30-day period that additional time is necessary.

e. The wage rate (including fringe benefits where appropriate) determined pursuant to paragraph 2c or 2d of this Section IV shall be paid to all workers performing work in the additional classification from the first day on which work is performed in the classification.

3. Payment of Fringe Benefits:

a. Whenever the minimum wage rate prescribed in the contract for a class of laborers or mechanics includes a fringe benefit which is not expressed as an hourly rate, the contractor or subcontractors, as appropriate, shall either pay the benefit as stated in the wage determination or shall pay another bona fide fringe benefit or an hourly case equivalent thereof.

b. If the contractor or subcontractor, as appropriate, does not make payments to a trustee or other third person, he/she may consider as a part of the wages of any laborer or mechanic the amount of any cost reasonably anticipated in providing bona fide fringe benefits under a plan or program, provided that the Secretary of Labor has found, upon the written request of the contractor, that the applicable standards of the Davis-Bacon Act have been met. The Secretary of Labor may require the contractor to set aside in a separate account assets for the meeting of obligations under the plan or program.

4. Apprentices and Trainees (Programs of the U.S. DOL) and Helpers:

a. Apprentices:

(1) Apprentices will be permitted to work at less than the predetermined rate for the work they performed when they are employed pursuant to and individually registered in a bona fide apprenticeship program registered with the DOL, Employment and Training Administration, Bureau of Apprenticeship and Training, or with a State apprenticeship agency recognized by the Bureau, or if a person is employed in his/her first 90 days of probationary employment as an apprentice in such an apprenticeship program, who is not individually registered in the program, but who has been certified by the Bureau of Apprenticeship and Training or a State apprenticeship agency (where appropriate) to be eligible for probationary employment as an apprentice.

(2) The allowable ratio of apprentices to journeyman-level employees on the job site in any craft classification shall not

be greater than the ratio permitted to the contractor as to the entire work force under the registered program. Any employee listed on a payroll at an apprentice wage rate, who is not registered or otherwise employed as stated above, shall be paid not less than the applicable wage rate listed in the wage determination for the classification of work actually performed. In addition, any apprentice performing work on the job site in excess of the ratio permitted under the registered program shall be paid not less than the applicable wage rate on the wage determination for the work actually performed. Where a contractor or subcontractor is performing construction on a project in a locality other than that in which its program is registered, the ratios and wage rates (expressed in percentages of the journeyman-level hourly rate) specified in the contractor's or subcontractor's registered program shall be observed.

(3) Every apprentice must be paid at not less than the rate specified in the registered program for the apprentice's level of progress, expressed as a percentage of the journeyman-level hourly rate specified in the applicable wage determination. Apprentices shall be paid fringe benefits in accordance with the provisions of the apprenticeship program. If the apprenticeship program does not specify fringe benefits, apprentices must be paid the full amount of fringe benefits listed on the wage determination for the applicable classification. If the Administrator for the Wage and Hour Division determines that a different practice prevails for the applicable apprentice classification, fringes shall be paid in accordance with that determination.

(4) In the event the Bureau of Apprenticeship and Training, or a State apprenticeship agency recognized by the Bureau, withdraws approval of an apprenticeship program, the contractor or subcontractor will no longer be permitted to utilize apprentices at less than the applicable predetermined rate for the comparable work performed by regular employees until an acceptable program is approved.

b. Trainees:

(1) Except as provided in 29 CFR 5.16, trainees will not be permitted to work at less than the predetermined rate for the work performed unless they are employed pursuant to and individually registered in a program which has received prior approval, evidenced by formal certification by the DOL, Employment and Training Administration.

(2) The ratio of trainees to journeyman-level employees on the job site shall not be greater than permitted under the plan approved by the Employment and Training Administration. Any employee listed on the payroll at a trainee rate who is not registered and participating in a training plan approved by the Employment and Training Administration shall be paid not less than the applicable wage rate on the wage determination for the classification of work actually performed. In addition, any trainee performing work on the job site in excess of the ratio permitted under the registered program shall be paid not less than the applicable wage rate on the wage determination for the work actually performed.

(3) Every trainee must be paid at not less than the rate specified in the approved program for his/her level of progress, expressed as a percentage of the journeyman-level hourly rate specified in the applicable wage determination. Trainees shall be paid fringe benefits in accordance with the provisions of the trainee program. If the trainee program does not mention fringe benefits, trainees shall be paid the full amount of fringe benefits

Wage and Hour Division determines that there is an apprenticeship program associated with the corresponding journeyman-level wage rate on the wage determination which provides for less than full fringe benefits for apprentices, in which cases such trainees shall receive the same fringe benefits as apprentices.

(4) In the event the Employment and Training Administration withdraws approval of a training program, the contractor or subcontractor will no longer be permitted to utilize trainees at less than the applicable predetermined rate for the work performed until an acceptable program is approved.

c. Helpers:

Helpers will be permitted to work on a project if the helper classification is specified and defined on the applicable wage determination or is approved pursuant to the conformance procedure set forth in Section IV. 2. Any worker listed on a payroll at a helper wage rate, who is not a helper under a approved definition, shall be paid not less than the applicable wage rate on the wage determination for the classification of work actually performed.

5. Apprentices and Trainees (Programs of the U.S. DOT):

Apprentices and trainees working under apprenticeship and skill training programs which have been certified by the Secretary of Transportation as promoting EEO in connection with Federal-aid highway construction programs are not subject to the requirements of paragraph 4 of this Section IV. The straight time hourly wage rates for apprentices and trainees under such programs will be established by the particular programs. The ratio of apprentices and trainees to journeymen shall not be greater than permitted by the terms of the particular program.

6. Withholding:

The SHA shall upon its own action or upon written request of an authorized representative of the DOL withhold, or cause to be withheld, from the contractor or subcontractor under this contract or any other Federal contract with the same prime contractor or any other Federally-assisted contract subject to Davis-Bacon prevailing wage requirements which is held by the same prime contractor, as much of the accrued payments or advances as may be considered necessary to pay laborers and mechanics, including apprentices, trainee's and helpers, employed by the contractor or any subcontractor the full amount of wages required by the contract. In the event of failure to pay any laborer or mechanic, including any apprentice, trainee, or helper, employed or working on the site of the work, all or part of the wages required by the contract, the SHA contracting officer may, after written notice to the contractor, take such action as may be necessary to cause the suspension of any further payment, advance, or guarantee of funds until such violations have ceased.

7. Overtime Requirements:

No contractor or subcontractor contracting for any part of the contract work which may require or involve the employment of laborers, mechanics, watchmen, or guards (including apprentices, trainees, and helpers described in paragraphs 4 and 5 above) shall require or permit any laborer, mechanic, watchman, or guard in any workweek in which he/she is employed on such work, to work in excess of 40 hours in such workweek unless such laborer, mechanic, watchman, or guard receives compensation at a rate not less than one-and-one-half times his/her basic rate of pay for all hours worked in excess of 40 hours in such workweek.

8. Violation:

Liability for Unpaid Wages; Liquidated Damages: In the event of any violation of the clause set forth in paragraph 7 above, the contractor and any subcontractor responsible thereof shall be liable to the affected employee for his/her unpaid wages. In addition, such contractor and subcontractor shall be liable to the United States (in the case of work done under contract for the District of Columbia or a territory, to such District or to such territory) for liquidated damages. Such liquidated damages shall be computed with respect to each individual laborer, mechanic, watchman, or guard employed in violation of the clause set forth in paragraph 7, in the sum of \$10 for each calendar day on which such employee was required or permitted to work in excess of the standard work week of 40 hours without payment of the overtime wages required by the clause set forth in paragraph 7.

9. Withholding for Unpaid Wages and Liquidated Damages:

The SHA shall; upon its own action or upon written request of any authorized representative of the DOL withhold, or cause to be withheld, from any monies payable on account of work performed by the contractor or subcontractor under any such contract or any other Federal contract with the same prime contractor, or any other Federally-assisted contract subject to the Contract Work Hours and Safety Standards Act, which is held by the same prime contractor, such sums as may be determined to be necessary to satisfy any liabilities of such contractor or subcontractor for unpaid wages and liquidated damages as provided in the clause set forth in paragraph 8 above.

V. STATEMENTS AND PAYROLLS

(Applicable to all Federal-aid construction contracts exceeding \$2,000 and to all related subcontracts, except for projects located on roadways classified as local roads or rural collectors, which are exempt.)

1. Compliance with Copeland Regulations (29 CFR 3):

The contractor shall comply with the Copeland Regulations of the Secretary of Labor which are herein incorporated by reference.

2. Payrolls and Payroll Records:

a. Payrolls and basic records relating thereto shall be maintained by the contractor and each subcontractor during the course of the work and preserved for a period of 3 years from the date of completion of the contract for all laborers, mechanics, apprentices, trainees, watchmen, helpers, and guards working at the site of the work.

b. The payroll records shall contain the name, social security number, and address of each such employee; his or her correct classification; hourly rates of wages paid (including rates of contributions or costs anticipated for bona fide fringe benefits or cash equivalent thereof the types described in Section 1(b)(2)(B) of the Davis Bacon Act); daily and weekly number of hours worked; deductions made; and actual wages paid. In addition, for Appalachian contracts, the payroll records shall contain a notation indicating whether the employee does, or does not, normally reside in the labor area as defined in Attachment A, paragraph 1. Whenever the Secretary of Labor, pursuant to Section IV, paragraph 3b, has found that the wages of any laborer or mechanic include the amount of any costs reasonably anticipated in providing benefits under a plan

or program described in Section 1(b)(2)(B) of the Davis Bacon Act, the contractor and each subcontractor shall maintain records which show that the commitment to provide such benefits is enforceable, that the plan or program is financially responsible, that the plan or program has been communicated in writing to the laborers or mechanics affected, and show the cost anticipated or the actual cost incurred in providing benefits. Contractors or subcontractors employing apprentices or trainees under approved programs shall maintain written evidence of the registration of apprentices and trainees, and ratios and wage rates prescribed in the applicable programs.

c. Each contractor and subcontractor shall furnish, each week in which any contract work is performed, to the SHA resident engineer a payroll of wages paid each of its employees (including apprentices trainees, and helpers, described in Section IV, paragraphs 4 and 5, and watchmen and guards engaged on work during the preceding weekly payroll period).

The payroll submitted shall set out accurately and completely all of the information required to be maintained under paragraph 2b of this Section V.

This information may be submitted in any form desired. Optional Form WH-347 is available for this purpose and may be purchased from the Superintendent of Documents (Federal stock number 029-005-0014-1), U.S. Government Printing Office, Washington, D.C. 20402. The prime contractor is responsible for the submission of copies of payrolls by all subcontractors.

d. Each payroll submitted shall be accompanied by a "Statement of Compliance," signed by the Contractor or subcontractor or his/her agent who pays or supervises the payment of the persons employed under the contract and shall certify the following:

(1) that the payroll for the payroll period contains the information required to be maintained under paragraph 2b of this Section V and that such information is correct and complete;

(2) that such laborer or mechanic (including each helper, apprentice, and trainee) employed on the contract during the payroll period has been paid the full weekly wages earned, without rebate, either directly or indirectly, and that no deductions have been made either directly or indirectly from the full wages earned, other than permissible deductions as set forth in the Regulations, 29 CFR 3;

(3) that each laborer or mechanic has been paid not less than the applicable wage rate and fringe benefits or cash equivalent for the classification of work performed, as specified in the applicable wage determination incorporated into the contract.

e. The weekly submission of a properly executed certification set forth on the reverse side of Optional Form WH-347 shall satisfy the requirement for submission of the "Statement of Compliance" required by paragraph 2d of this Section V.

f. The falsification of any of the above certifications may subject the contractor to civil or criminal prosecution under 18 U/S. C. 1001 and 31 U.S.C. 231.

g. The contractor or subcontractor shall make the records required under paragraph 2b of this Section V available for

inspection, copying, or transcription by authorized representatives of the SHA, the FHWA, or the DOL, and shall permit such representatives to interview employees during working hours on the job. If the contractor or subcontractor fails to submit the required records or to make them available, the SHA, the FHWA, the DOL, or all may, after written notice to the contractor, sponsor, applicant, or owner, take such actions as may be necessary to cause the suspension of any further payment, advance, or guarantee of funds. Furthermore, failure to submit the required records upon request or to make such records available may be grounds for debarment action pursuant to 29 CFR 5.12.

VI. RECORD OF MATERIALS, SUPPLIES, AND LABOR

1. On all federal-aid contracts on the national highway system, except those which provide solely for the installation of protective devices at railroad grade crossings, those which are constructed on a force account or direct labor basis, highway beautification contracts, and contracts for which the total final construction cost for roadway and bridge is less than \$1,000,000 (23 CFR 635) the contractor shall:

- a. Become familiar with the list of specific materials and supplies contained in Form FHWA-47, "Statement of Materials and Labor Used by Contractor of Highway Construction Involving Federal Funds," prior to the commencement of work under this contract.
- b. Maintain a record of the total cost of all materials and supplies purchased for and incorporated in the work, and also of the quantities of those specific materials and supplies listed on Form FHWA-47, and in the units shown on Form FHWA-47.
- c. Furnish, upon the completion of the contract, to the SHA resident engineer on /Form FHWA-47 together with the data required in paragraph 1b relative to materials and supplies, a final labor summary of all contract work indicating the total hours worked and the total amount earned.

2. At the prime contractor's option, either a single report covering all contract work or separate reports for the contractor and for each subcontract shall be submitted.

VII. SUBLETTING OR ASSIGNING THE CONTRACT

1. The contractor shall perform with its own organization contract work amounting to not less than 30 percent (or a greater percentage if specified elsewhere in the contract) of the total original contract price, excluding any specialty items designated by the State. Specialty items may be performed by subcontract and the amount of any such specialty items performed may be deducted from the total original contract price before computing the amount of work required to be performed by the contractors' own organization (23 CFR 635).

- a. "Its own organization" shall be construed to include only workers employed and paid directly by the prime contractor and equipment owned or rented by the prime contractor, with or without operators. Such term does not include employees or equipment of a subcontractor, assignee, or agent of the prime contractor.
- b. "Specialty Items" shall be construed to be limited to work that requires highly specialized knowledge, abilities, or equipment not ordinarily available in the type of contracting organizations qualified and expected to bid on the contract as a

whole and in general are to be limited to minor components of the overall contract.

2. The contract amount upon which the requirements set forth in paragraph 1 of Section VII is computed includes the cost of material and manufactured products which are to be purchased or produced by the contractor under the contract provisions.

3. The contractor shall furnish (a) a competent superintendent or supervisor who is employed by the firm, has full authority to direct performance of the work in accordance with the contract requirements, and is in charge of all construction operations (regardless of who performs the work) and (b) such other of its own organizational resources (supervision, management, and engineering services) as the SHA contracting officer determines is necessary to assure the performance of the contract.

4. No portion of the contract shall be sublet, assigned or otherwise disposed of except with the written consent of the SHA contracting officer, or authorized representative, and such consent when given shall not be construed to relieve the contractor of any responsibility for the fulfillment of the contract.

Written consent will be given only after the SHA has assured that each subcontract is evidenced in writing and that it contains all pertinent provisions and requirements of the prime contract.

VIII. SAFETY: ACCIDENT PREVENTION

1. In the performance of this contract the contractor shall comply with all applicable Federal, State, and local laws governing safety, health, and sanitation (23 CFR 635). The contractor shall provide all safeguards, safety devices and protective equipment and take any other needed actions as it determines, or as the SHA contracting officer may determine, to be reasonably necessary to protect the life and health of employees on the job and the safety of the public and to protect property in connection with the performance of the work covered by the contract.

2. It is a condition of this contract, and shall be made a condition of each subcontract, which the contractor enters into pursuant to this contract, that the contractor and any subcontractor shall not permit any employee, in performance of the contract, to work in surroundings or under conditions which are unsanitary, hazardous or dangerous to his/her health or safety, as determined under construction safety and health standards (29 CFR 1926) promulgated by the Secretary of Labor, in accordance with Section 107 of the Contract Work Hours and Safety Standards Act (40 U.S. C. 333).

3. Pursuant to 29 CFR 1926.3, it is a condition of this contract that the Secretary of Labor or authorized representative thereof, shall have right of entry to any site of contract performance to inspect or investigate the matter of compliance with the construction safety and health standards and to carry out the duties of the Secretary under Section 107 of the Contract Work Hours and Safety Standards Act (40 U.S.C. 333).

IX. FALSE STATEMENTS CONCERNING HIGHWAY PROJECTS

In order to assure high quality and durable construction in conformity with approved plans and specifications and a high degree of reliability on statements and representations made by engineers, contractors, suppliers, and workers on Federal-aid highway projects, it is essential that all persons concerned with the project perform their functions as carefully, thoroughly, and honestly as possible. Willful falsification,

distortion, or misrepresentation with respect to any facts related to the project is a violation of Federal law. To prevent any misunderstanding regarding the seriousness of these and similar acts, the following notice shall be posted on each Federal-aid highway project (23 CFR 635) in one or more places where it is readily available to all persons concerned with the project:

NOTICE TO ALL PERSONNEL ENGAGED ON FEDERAL-AID HIGHWAY PROJECTS

18 U.S.C. 1020 reads as follows:

“Whoever, being an officer, agent or employee of the United States, or of any State or Territory, or whoever, whether a person, association, firm, or corporation, knowingly makes any false statement, false representation, or false report as to the character, quality, quantity, or cost of the material used or to be used, or the quantity or quality of the work performed or to be performed, or the cost thereof in connection with the submission of plans, maps, specifications, contracts, or costs of construction on any highway or related project submitted for approval to the Secretary of Transportation; or

Whoever knowingly makes any false statement, false representation, false report or false claim with respect to the character, quality, quantity, or cost of any work performed or to be performed, or materials furnished or to be furnished, in connection with the construction of any highway or related project approved by the Secretary of Transportation; or

Whoever knowingly makes any false statement or false representation as to material fact in any statement, certificate, or report submitted pursuant to provisions of the Federal-aid Roads Act approved July 1, 1916, (39 Stat. 355), as amended and supplemented;

Shall be fined not more than \$10,000 or imprisoned not more than 5 years or both.”

X. IMPLEMENTATION OF CLEAN AIR ACT AND FEDERAL WATER POLLUTION CONTROL ACT

(Applicable to all Federal-aid construction contracts and to all related subcontracts of \$100,000 or more).

By submission of this bid or the execution of this contract, or subcontract, as appropriate, the bidder, Federal-aid construction contractor, or subcontractor, as appropriate, will be deemed to have stipulated as follows:

1. That any facility that is or will be utilized in the performance of this contract, unless such contract is exempt under the Clean Air Act, as amended (42 U.S.C. 1857 et seq., as amended by Pub.L. 91-604), and under the Federal Water Pollution Control Act, as amended (33 U.S.C. 1251 et seq., as amended by Pub.L. 92-500), Executive Order 11738, and regulations in implementation thereof (40 CFR 15) is not listed, on the date of contract award, on the U.S. Environmental Protection Agency (EPA) List of Violating Facilities pursuant to 40 CFR 15.20.

2. That the firm agrees to comply and remain in compliance with all the requirements of Section 114 of the Clean Air Act and Section 308 of the Federal Water Pollution Control Act and all regulations and guidelines listed thereunder.

3. That the firm shall promptly notify the SHA of the receipt of

any communication from the Director, Office of Federal Activities, EPA indicating that a facility that is or will be utilized for the contract is under consideration to be listed on the EPA List of Violating Facilities.

4. That the firm agrees to include or cause to be included the requirements of paragraph 1 through 4 of this Section X in every nonexempt subcontract, and further agrees to take such action as the government may direct as a means of enforcing such requirements.

XI. CERTIFICATION REGARDING DEBARMENT, SUSPENSION, INELIGIBILITY AND VOLUNTARY EXCLUSION

1. Instructions for Certification - Primary Covered Transactions:

(Applicable to all Federal-aid contracts - 49 CFR 29)

a. By signing and submitting this proposal, the prospective primary participant is providing the certification set out below.

b. The inability of a person to provide the certification set out below will not necessarily result in denial of participation in this covered transaction. The prospective participant shall submit an explanation of why it cannot provide the certification set out below. The certification or explanation will be considered in connection with the department or agency's determination whether to enter into this transaction. However, failure of the prospective primary participant to furnish a certification or an explanation shall disqualify such a person from participation in this transaction.

c. The certification in this clause is a material representation of fact upon which reliance was placed when the department or agency determined to enter into this transaction. If it is later determined that the prospective primary participant knowingly rendered an erroneous certification, in addition to other remedies available to the Federal Government, the department or agency may terminate this transaction for cause of default.

d. The prospective primary participant shall provide immediate written notice to the department or agency to whom this proposal is submitted if any time the prospective primary participant learns that its certification was erroneous when submitted or has become erroneous by reason of changed circumstances.

e. The terms “covered transaction,” “debarred,” “suspended,” “ineligible,” “lower tier covered transaction,” “participant,” “person,” “primary covered transaction,” “principal,” “proposal,” and “voluntarily excluded,” as used in this clause, have the meanings set out in the Definitions and Coverage sections of rules implementing Executive Order 12549. You may contact the department or agency to which this proposal is submitted for assistance in obtaining a copy of those regulations.

f. The prospective primary participant agrees by submitting this proposal that, should the proposed covered transaction be entered into, it shall not knowingly enter into any lower tier covered transaction with a person who is debarred, suspended, declared ineligible, or voluntarily excluded from participation in this covered transaction, unless authorized by the department or agency entering into this transaction.

g. The prospective primary participant further agrees by submitting this proposal that it will include the clause titled

"Certification Regarding Debarment, Suspension, Ineligibility and Voluntary Exclusion-Lower Tier Covered Transaction," provided by the department or agency entering into this covered transaction, without modification in all lower tier covered transactions and in all solicitations for lower tier covered transactions.

h. A participant in a covered transaction may rely upon a certification of a prospective participant in a lower tier covered transaction that is not debarred, suspended, ineligible, or voluntarily excluded from the covered transaction, unless it knows that the certification is erroneous. A participant may decide the method and frequency by which it determines the eligibility of its principals. Each participant may, but is not required to, check the nonprocurement portion of the "Lists of Parties Excluded from Federal Procurement or Nonprocurement Programs" (Nonprocurement List) which is compiled by the General Services Administration.

i. Nothing contained in the foregoing shall be construed to require establishment of a system of records in order to render in good faith the certification required by this clause. The knowledge and information of participant is not required to exceed that which is normally possessed by a prudent person in the ordinary course of business dealings.

j. Except for transactions authorized under paragraph f of these instructions, if a participant in a covered transaction knowingly enters into a lower tier covered transaction with a person who is suspended, debarred, ineligible, or voluntarily excluded from participation in this transaction, in addition to other remedies available to the Federal Government, the department or agency may terminate this transaction for cause or default.

Certification Regarding Debarment, Suspension, Ineligibility and Voluntary Exclusion-Primary Covered Transactions

1. The prospective primary participant certifies to the best of its knowledge and belief, that it and its principals:

- a. Are not presently debarred, suspended, proposed for debarment, declared ineligible, or voluntarily excluded from covered transactions by any Federal department or agency;
- b. Have not within a 3-year period preceding this proposal been convicted of or had a civil judgment rendered against them for commission of fraud or a criminal offense in connection with obtaining, attempting to obtain, or performing a public (Federal, State or local) transaction or contract under a public transaction; violation of Federal or State antitrust statutes or commission of embezzlement, theft, forgery, bribery, falsification or destruction of records, making false statements, or receiving stolen property;
- c. Are not presently indicted for or otherwise criminally or civilly charged by a governmental entity (Federal, State or local) with commission of any of the offenses enumerated in paragraph 1b of this certification; and
- d. Have not within a 3-year period preceding this application/proposal had one or more public transactions (Federal, State or local) terminated for cause or default.

2. Where the prospective primary participant is unable to certify to any of the statements in this certification, such prospective participant shall attach an explanation to this proposal.

2. Instructions for Certification - Lower Tier Covered Transactions:

(Applicable to all subcontracts, purchase orders and other lower tier transactions of \$25,000 or more - 49 CFR 29)

- a. By signing and submitting this proposal, the prospective lower tier is providing the certification set out below.
- b. The certification in this clause is a material representation of fact upon which reliance was placed when this transaction was entered into. If it is later determined that the prospective lower tier participant knowingly rendered an erroneous certification, in addition to other remedies available to the Federal Government, the department, or agency with which this transaction originated may pursue available remedies, including suspension and/or debarment.
- c. The prospective lower tier participant shall provide immediate written notice to the person to which this proposal is submitted if at any time the prospective lower tier participant learns that its certification was erroneous by reason of changed circumstances.
- d. The terms "covered transaction," "debarred," "suspended," "ineligible," "primary covered transaction," "participant," "person," "principal," "proposal," and "voluntarily excluded," as used in this clause, have the meanings set out in the Definitions and Coverage sections of rules implementing Executive Order 12549. You may contact the person to which this proposal is submitted for assistance in obtaining a copy of those regulations.
- e. The prospective lower tier participant agrees by submitting this proposal that, should the proposed covered transaction be entered into, it shall not knowingly enter into any lower tier covered transaction with a person who is debarred, suspended, declared ineligible, or voluntarily excluded from participation in this covered transaction, unless authorized by the department or agency with which this transaction originated.
- f. The prospective lower tier participant further agrees by submitting this proposal that it will include this clause titled "Certification Regarding Debarment, Suspension, Ineligibility and Voluntary Exclusion-Lower Tier Covered Transaction," without modification, in all lower tier covered transactions and in all solicitations for lower tier covered transactions.
- g. A participant in a covered transaction may rely upon a certification of a prospective participant in a lower tier covered transaction that is not debarred, suspended, ineligible, or voluntarily excluded from the covered transaction, unless it knows that the certification is erroneous. A participant may decide the method and frequency by which it determines the eligibility of its principals. Each participant may, but is not required to, check the Nonprocurement List.
- h. Nothing contained in the foregoing shall be construed to require establishment of a system of records in order to render in good faith the certification required by this clause. The knowledge and information of participant is not required to exceed that which is normally possessed by a prudent person in the ordinary course of business dealing.
- i. Except for transactions authorized under paragraph e of these instructions, if a participant in a covered transaction knowingly enters into a lower tier covered transaction with a person who is suspended, debarred, ineligible, or voluntarily

excluded from participation in this transaction, in addition to other remedies available to the Federal Government, the department or agency with which this transaction originated may pursue available remedies, including suspension and/or debarment.

Certification Regarding Debarment, Suspension, Ineligibility And Voluntary Exclusion-Lower Tier Covered Transactions:

1. The prospective lower tier participant certifies, by submission of this proposal, that neither it nor its principals is presently debarred, suspended, proposed for debarment, declared ineligible, or voluntarily excluded from participation in this transaction by any Federal department or agency.

2. Where the prospective lower tier participant is unable to certify to any of the statements in this certification, such prospective participant shall attach an explanation to this proposal.

XII. CERTIFICATION REGARDING USE OF CONTRACT FUNDS FOR LOBBYING

(Applicable to all Federal-aid construction contracts and to all related subcontracts which exceed \$100,000 - 49 CFR 20)

1. The prospective participant certifies, by signing and submitting this bid or proposal, to the best of his or her knowledge and belief, that:

a. No Federal appropriated funds have been paid or will be paid, by or on behalf of the undersigned, to any person for influencing or attempting to influence an officer or employee of any Federal agency, a Member of Congress, an officer or employee of Congress, or an employee of a Member of Congress in connection with the awarding of any Federal contract, the making of any Federal grant, the making of any Federal loan, the entering into of any cooperative agreement, and the extension, continuation, renewal, amendment, or modification of any Federal contract, grant, loan, or cooperative agreement.

b. If any funds other than Federal appropriated funds have been paid or will be paid to any person for influencing or attempting to influence an officer or employee of any Federal agency, a Member of Congress, an officer or employee of Congress, or an employee of a Member of Congress in connection with this Federal contract, grant, loan, or cooperative agreement, the undersigned shall complete and submit Standard Form-LLL, "Disclosure Form to Report Lobbying," in accordance with its instructions.

2. This certification is a material representation of fact upon which reliance was placed when this transaction was made or entered into. Submission of this certification is a prerequisite for making or entering into this transaction imposed by 31 U.S.C. 1352. Any person who fails to file the required certification shall be subject to a civil penalty of not less than \$10,000 and not more than \$100,000 for each such failure.

3. The prospective participant also agrees by submitting his or her bid or proposal that he or she shall require that the language of this certification be included in all lower tier subcontracts, which exceed \$100,000 and that all such recipients shall certify and disclose accordingly.

**MINIMUM WAGES FOR FEDERAL AND FEDERALLY
ASSISTED CONSTRUCTION CONTRACTS**

This project is funded, in part, with Federal-aid funds and, as such, is subject to the provisions of the Davis-Bacon Act of March 3, 1931, as amended (46 Sta. 1494, as amended, 40 U.S.C. 276a) and of other Federal statutes referred to in a 29 CFR Part 1, Appendix A, as well as such additional statutes as may from time to time be enacted containing provisions for the payment of wages determined to be prevailing by the Secretary of Labor in accordance with the Davis-Bacon Act and pursuant to the provisions of 29 CFR Part 1. The prevailing rates and fringe benefits shown in the General Wage Determination Decisions issued by the U.S. Department of Labor shall, in accordance with the provisions of the foregoing statutes, constitute the minimum wages payable on Federal and federally assisted construction projects to laborers and mechanics of the specified classes engaged on contract work of the character and in the localities described therein.

General Wage Determination Decisions, modifications and supersedes decisions thereto are to be used in accordance with the provisions of 29 CFR Parts 1 and 5. Accordingly, the applicable decision, together with any modifications issued, must be made a part of every contract for performance of the described work within the geographic area indicated as required by an applicable DBRA Federal prevailing wage law and 29 CFR Part 5. The wage rates and fringe benefits contained in the General Wage Determination Decision shall be the minimum paid by contractors and subcontractors to laborers and mechanics.

NOTICE

The most current **General Wage Determination Decisions** (wage rates) are available on the IDOT web site. They are located on the Letting and Bidding page at <http://www.dot.state.il.us/desenv/delett.html>.

In addition, ten (10) days prior to the letting, the applicable Federal wage rates will be e-mailed to subscribers. It is recommended that all contractors subscribe to the Federal Wage Rates List or the Contractor's Packet through IDOT's subscription service.

PLEASE NOTE: if you have already subscribed to the Contractor's Packet you will automatically receive the Federal Wage Rates.

The instructions for subscribing are at <http://www.dot.state.il.us/desenv/subsc.html>.

If you have any questions concerning the wage rates, please contact IDOT's Chief Contract Official at 217-782-7806.