

F.A.J. RTE.	SECTION	COUNTY	TOTAL SHEETS	SHEET NO.
74	92-9 1	VERMILION	8	8

CENTERLINE INTERSTATE OR MULTI-LANE TWO WAY DIVIDED HIGHWAY

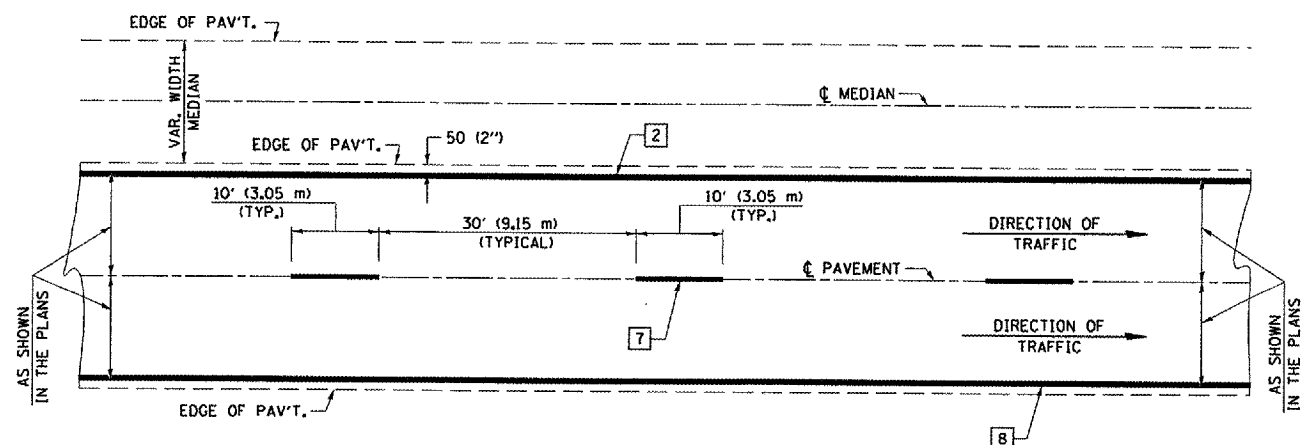

NOTE: PAVEMENT MARKINGS ARE TO BE EXTENDED THROUGH OMISSIONS WHEN APPLICABLE.

NOTE: SEE ARTICLES 780.04 & 781.03 FOR LOCATION OF STRIPES AND MARKERS RELATIVE TO EDGES OR JOINTS.

FOR RAISED REFLECTIVE PAVEMENT MARKERS, REFER TO STANDARD 781001.

TYPICAL EXIT RAMP TERMINAL

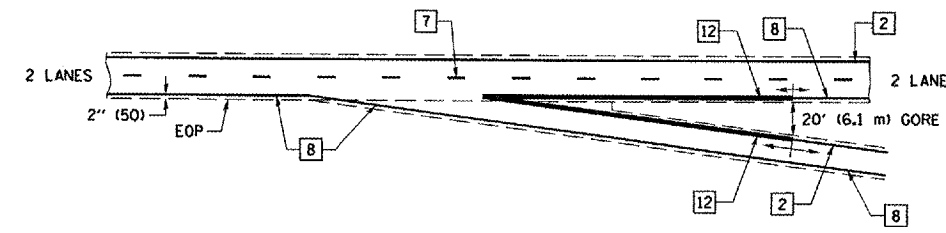

EXIT RAMP TERMINAL with EXCLUSIVE (auxiliary) LANE

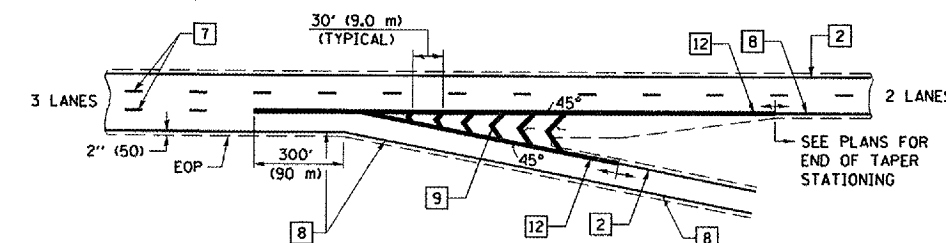

TYPICAL ENTRANCE RAMP TERMINAL

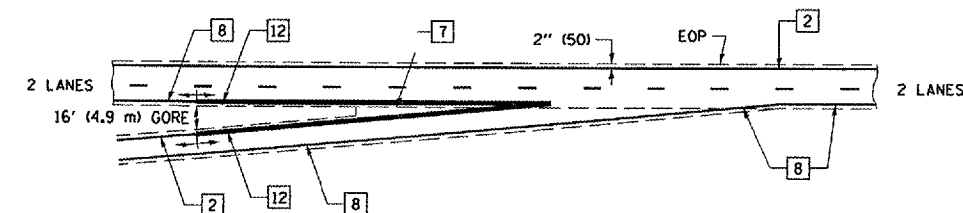

ENTRANCE RAMP TERMINAL with EXCLUSIVE LANE

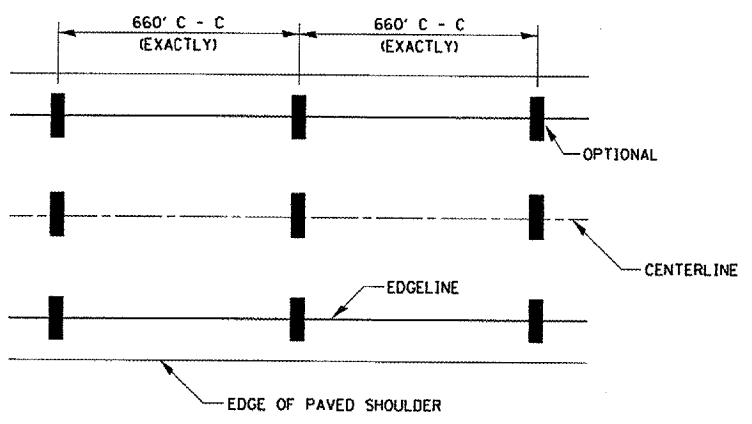
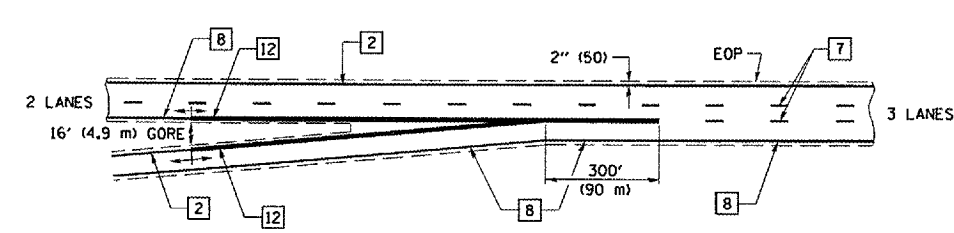

IT WILL BE NECESSARY TO HAVE A REPRESENTATIVE OF THE STATE POLICE PRESENT SO THAT THE ACCURACY OF MEASUREMENT CAN BE ATTESTED TO IN COURT.

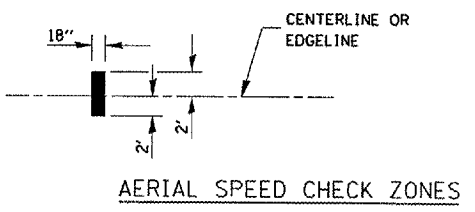

TYPICAL PAVEMENT MARKING LEGEND

- 1 4" (100) SKIP-DASH (YELLOW)
- 2 4" (100) SOLID (YELLOW)
- 3 12" (300) DIAGONAL (YELLOW)
- 4 4" (100) DOUBLE YELLOW (NARROW)
- 5 RESERVED
- 6 RESERVED
- 7 4" (100) SKIP-DASH (WHITE)
- 8 4" (100) SOLID (WHITE)
- 9 12" (300) DIAGONAL (WHITE)
- 10 6" (150) SOLID (WHITE)
- 11 24" (600) STOP BAR (WHITE)
- 12 8" (200) SOLID (WHITE)
- 13 4" (100) LANE LINE EXTENSIONS (WHITE)

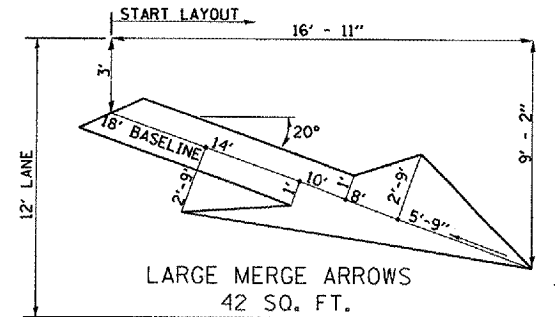

Note: All dimensions are in INCHES (millimeters) unless otherwise shown.

DATE	REVISIONS	NAME
11/06	REPLACED DETAIL F-5.22	TJB

ILLINOIS DEPARTMENT OF TRANSPORTATION
**PAVEMENT MARKING
 (INTERSTATE & MULTI-LANE APPLICATIONS)**
DISTRICT 5 DETAIL NO. 7800BBB

DESIGNER NOTE: