**STRUCTURE GEOTECHNICAL REPORT
CIRCLE INTERCHANGE RECONSTRUCTION
INTERSTATE 290 CONGRESS VIADUCT
DES PLAINES STREET TO CANAL STREET
EXISTING SN 016-0461, PROPOSED SN 016-0461
SECTIONS 2014-001 R&B, 2014-004 R&B
IDOT D-91-227-13, PTB 163/ITEM 001
COOK COUNTY, ILLINOIS**

for

AECOM

303 East Wacker Drive

Chicago, IL 60601

(312) 938-0300

submitted by

Wang Engineering, Inc.

1145 North Main Street

Lombard, IL 60148

(630) 953-9928

**Original Report: September 30, 2014
Revised Report: June 22, 2015**

Technical Report Documentation Page

1. Title and Subtitle Structure Geotechnical Report: Circle Interchange Reconstruction Interstate 290 Congress Viaduct, Des Plaines Street to Canal Street		2. Report Date June 22, 2015
		3. Report Type <input checked="" type="checkbox"/> SGR <input type="checkbox"/> RGR <input type="checkbox"/> Draft <input type="checkbox"/> Final <input checked="" type="checkbox"/> Revised
4. Route / Section / County FAI 290 / 2014-001 R&B, 2014-004 R&B / Cook		5. IDOT Project Number(s) Job D-91-227-13
6. PTB / Item No. 163/001	7. Existing Structure Number(s) SN 016-0461	8. Proposed Structure Number(s) SN 016-0461
9. Prepared by Wang Engineering, Inc. 1145 N Main Street Lombard, IL 60148	Contributor(s) Author: Mickey L. Snider, P.E. PIC: Corina T. Farez, P.G., P.E. QA/QC: Jerry W.H. Wang, PhD, P.E.	Contact Phone Number (630) 953-9928 x 1027 MSnider@wangeng.com
10. Prepared for AECOM 303 E Wacker Drive Chicago, IL 60601	Design / Structural Engineer Amish Bhatt, P.E., S.E.	Contact Phone Number (312) 938-0300
11. Abstract <p>The existing 16-span Interstate 290 Congress Viaduct between Des Plaines Street and Canal Street is proposed to be rehabilitated. The improvements include partial redecking, partial removal and replacement of the full superstructure, and partial rehabilitation of the existing deck. The back-to-back length will measure 1300.7 feet and the out-to-out width will measure 88.8 to 162.0 feet.</p> <p>The soil conditions immediately beneath the pavement include loose to medium dense sandy fill. Beneath the fill, the borings encountered a thin crust followed by about 25 to 40 feet of very soft to medium stiff clay overlying stiff to very stiff silty clay. The deeper foundation soils include hard silty clay to silty loam resting on top of very dense gravelly sand and strong, fair to excellent quality dolostone. Top of bedrock was encountered at an average elevation of about 490 feet. The site classifies in the Seismic Class E and is in Seismic Performance Zone 1.</p> <p>Two new MSE retaining walls, in various combinations of cut and fill, will be constructed to support the approach embankments behind new abutments. The approach pavement settlement and global stability will depend on the type, height, and geometry of these new retaining walls; these issues will be discussed in separate retaining wall SGRs.</p> <p>The existing piers are supported on drilled shafts. Plans provided from the original 1949/1950 design show a detail with the shafts established 6-inches into sound rock; however, the shaft schedules show the shafts established at elevations of -73 to -83 feet, CCD, which is approximately 10 feet above the bedrock elevation encountered in the borings. If the shafts are founded in the bedrock we estimate factored resistances of 1090 to 1463 kips for the 38 and 44 inch diameter shafts. If the shafts are founded at above the bedrock within the very dense, intermediate geomaterial we estimate significantly reduced factored resistances of 300 to 400 kips for the 38 to 44 inch diameter shafts. We strongly recommend confirming the base elevations of the shafts, as well as the foundation material prior to final design. The original plans offer conflicting information with regards to the shaft base elevations and soil borings for the original design are not included to confirm what information was known about the subsurface conditions. Three alternative methods are presented and we recommend downhole parallel seismic geophysical testing as the most feasible and complete method of confirmation.</p>		
12. Path to archived file S:\Netprojects\11000401\Reports\Bridges\RPT_Wang_MLS_11000401Bridge0461_20140925.pdf		

TABLE OF CONTENTS

1.0 INTRODUCTION	1
1.1 PROPOSED STRUCTURE	1
1.2 EXISTING STRUCTURE.....	2
2.0 SITE CONDITIONS AND GEOLOGICAL SETTING	2
2.1 PHYSIOGRAPHY	3
2.2 SURFICIAL COVER	3
2.3 BEDROCK	3
3.0 METHODS OF INVESTIGATION	4
3.1 SUBSURFACE INVESTIGATION	4
3.2 LABORATORY TESTING.....	5
4.0 RESULTS OF FIELD AND LABORATORY INVESTIGATIONS.....	5
4.1 SOIL CONDITIONS	5
4.2 GROUNDWATER CONDITIONS.....	7
4.3 SEISMIC DESIGN CONSIDERATIONS	7
5.0 FOUNDATION ANALYSIS AND RECOMMENDATIONS	8
5.1 STRUCTURE FOUNDATIONS.....	8
5.2 STAGE CONSTRUCTION DESIGN RECOMMENDATIONS.....	11
6.0 QUALIFICATIONS	11
REFERENCES	13
EXHIBITS	
1. Site Location Map	
2. Site and Regional Geology	
3. Boring Location Plan	
4. Soil Profile	
APPENDIX A	
Boring Logs	
APPENDIX B	
Laboratory and In-Situ Test Results	
APPENDIX C	
Bedrock Core Exhibit	

**STRUCTURE GEOTECHNICAL REPORT
CIRCLE INTERCHANGE RECONSTRUCTION
INTERSTATE 290 CONGRESS VIADUCT
DES PLAINES STREET TO CANAL STREET
EXISTING SN 016-0461, PROPOSED SN 016-0461
SECTIONS 2014-001 R&B AND 2014-004 R&B
IDOT D-91-227-13, PTB 163/ITEM 001
COOK COUNTY, ILLINOIS
FOR
AECOM**

1.0 INTRODUCTION

This report presents the results of our subsurface investigation, laboratory testing, and geotechnical evaluations for the design and reconstruction of the Interstate 290 (I-290) Congress Viaduct, between Des Plaines Street and Canal Street, immediately east of the Circle Interchange in Chicago, Cook County, Illinois. A *Site Location Map* is presented as Exhibit 1.

1.1 Proposed Structure

Wang Engineering, Inc. (Wang) understands Parsons Brinkerhoff, in conjunction with AECOM, envisions a partial reconstruction and rehabilitation of the existing Congress Viaduct superstructure and select number of columns, while reusing the existing shaft foundations. The total viaduct length is 1300.5 feet and consists of 16 spans, ranging in length from 54.9 to 92.4 feet. The out-to-out width of the deck ranges from 88.8 to 161.3 feet. The structure does not have abutments; rather Column Line C1 at the west limit is the transition to five separate structures: SN 016-1703, 1704, 1706, 1710, and 1715. Column Line 17 on the east end connects to the Congress Parkway viaduct running beneath the former US Post Office. The piers are multiple-column types supported on caisson foundations. The original plans from 1950, as well as a sub pier detail plan set, show shafts set 6-inches into rock with base diameters of 38 to 44 inches.

The TSL plan shows four individual ‘Units’ of improvement. Unit I, from Pier 1 to Pier 4 will undergo complete removal and repair. The entire superstructure, as well as Piers 1 through 4, will be removed and replaced. Units II and III, from Pier 4 to Pier 12 will have the deck removed, but will reuse the existing structural steel. New piers are only proposed at Column Lines 9 and 12. Unit IV, between Pier

12 and Pier 17 will see the superstructure remain as is, but will include improvements to the north and side limits to facilitate the construction of new retaining walls at Column Line 14.

Entrance and exit ramps along Canal Street will be constructed as part of the viaduct improvements. To facilitate the ramps, two sets of mechanically-stabilized earth (MSE) walls will be constructed leading to new, 25-foot wide abutments off the north and south ends of Column Line C14. The top of abutment elevation is proposed at 611.5 feet, whereas the existing ground surface elevation along the MSE walls is about 599 feet; therefore, the maximum total height of the walls will be approximately 17 feet. The abutments will be supported on new drilled shaft foundations.

The purpose of our investigation was to characterize the site soil and groundwater conditions, perform geotechnical analyses, and provide recommendations for the design and construction of the foundations.

1.2 Existing Structure

The existing viaduct was constructed in 1952 and has 16 main spans. The structure is approximately 1300 feet long and 162 feet wide. The site immediately to the west is a system of numerous ramps, embankments, and expressways that are scheduled for complete renovation and will be tied into the viaduct at various points. The east end of the viaduct is the former US Post Office immediately east of Span 16, which takes traffic over Canal Street. The existing foundations are drilled shafts connecting to multi-column piers. The existing shaft specifics are discussed in detail in Section 5.1.

2.0 SITE CONDITIONS AND GEOLOGICAL SETTING

The site is located within the City of Chicago. On the USGS *Chicago Loop 7.5 Minute Series* map, the bridge is located in the S½ of Section 16, Tier 39 N, Range 14 E of the 3rd Principal Meridian.

The following review of published geologic data, with emphasis on factors that might influence the design and construction of the proposed engineering works, is meant to place the project area within a geological framework and confirm the dependability and consistency of the present subsurface investigation results. For the study of the regional geologic framework, Wang considered northeastern Illinois in general and Cook County in particular. Exhibit 2 illustrates the *Site and Regional Geology*.

2.1 Physiography

The site is situated within the northern section of the Chicago/Calumet lacustrine plain (Chrzatowsky and Thompson 1992). The flat, lakeward-sloping surface is a wave-scoured groundmoraine covered by thin and discontinuous offshore lacustrine silt and clay (Willman 1971).

At the proposed bridge location, a number of existing ramps cross the alignment, converging and diverging with I-290 and I-90/94. The elevation along the existing viaduct is at about 610 to 620 feet, whereas the frontage roads along the north and south are at about 590 to 595 feet.

2.2 Surficial Cover

Within the project area, a more than 75-foot thick, Wisconsin-age glacial drift covers the bedrock (Leetaru et al. 2004). The glacial cover is made up of clay and silt of the Equality Formation of the Mason Group and diamictons of the Wadsworth and Lemont Formations of the Wedron Group (Hansel and Johnson 1996). The Equality Formation is made up of bedded silt and clay, locally laminated, with lenses and/or thin beds of sand and gravel. The Wadsworth Formation consists of relatively homogenous, massive, gray till with clay to silty clay matrix, with dolostone and shale clasts and occasional lenses of sorted and stratified silt. The Wadsworth Formation is underlined by the pebbly silty clay loam to silty loam diamicton of the Yorkville Member of the Lemont Formation, known informally as the Chicago “hardpan.”

The Equality Formation is characterized by low strength, medium to high plasticity, and medium to high moisture content. The underlying Wadsworth Formation is characterized by low plasticity, medium to low moisture content, medium to very stiff consistency, poor permeability, and low compressibility. The Yorkville Member is characterized by low plasticity, high blow counts, and low moisture content (Bauer et al. 1991; Peck and Reed 1954).

2.3 Bedrock

In the project area, the glacial deposits rest unconformably over a 350-foot thick Silurian-age dolostone. The top of bedrock may be encountered at elevations lower than 500 feet or 75 to 100 feet below ground surface (bgs). The Silurian dolostone dips gently eastward at a pace of 15 feet per mile. Only inactive faults are known in the area, and the seismic risk is minimal (Leetaru et al. 2004; Willman 1971). There are no records of mining activity in the area, but deep tunnel excavations are known to exist throughout the Circle Interchange area.

Our subsurface investigation results fit into the local geologic context. The borings drilled in the project area revealed the native sediments consist of clay to silty clay diamicton of the Wadsworth Formation resting on top of more competent silty clay loam diamicton (hardpan) of the Lemont Formation, which in turn is underlain by bedrock. Sound dolostone bedrock was sampled or inferred at depths deeper than 85.0 feet bgs or 486.0 to 490.0 feet elevation, within or close to the range predicted based on published geological data.

3.0 METHODS OF INVESTIGATION

The following sections outline the subsurface and laboratory investigations performed by Wang.

3.1 Subsurface Investigation

The subsurface investigation consisted of sixteen structure borings, designated as 0461-B-01 through 0461-B-15 and 41-RWB-01. Boring 0461-B-08 was divided into A and B sections due to an obstruction encountered at 37 feet bgs. The borings were drilled along the viaduct frontage Roads (Congress and Tilden Streets) from elevations of 587.2 to 604.5 feet to depths of 94.5 to 113.5 feet bgs. Northings and eastings were surveyed by Wang with a mapping-grade GPS unit, whereas elevations, stations, and offsets were provided by AECOM. The boring locations are presented in the *Boring Logs* (Appendix A) and in the *Boring Location Plan* (Exhibit 3).

A truck-mounted drilling rig, equipped with solid stem augers and mud rotary equipment, was used to advance and maintain an open borehole. Soil sampling was performed according to AASHTO T 206, "*Penetration Test and Split Barrel Sampling of Soils.*" The soil was sampled at 2.5-foot intervals to 30 feet bgs and at 5-foot intervals thereafter. Samples collected from each interval were placed in sealed jars for further examination and testing. NWD4-size bedrock cores were collected from selected boreholes in 10-foot runs. One TEXAM Pressuremeter test was performed adjacent to the northwest corner of the viaduct for SN 016-1715, or the West-South Ramp, in Boring 1715-PMT-01 and the results are shown in Appendix B.

Field boring logs, prepared and maintained by a Wang engineer, include lithological descriptions, visual-manual soil classifications (IDH Textural Classification), results of Rimac and/or pocket penetrometer unconfined compressive strength tests, and results of Standard Penetration Tests (SPT) recorded as blows per 6 inches of penetration. The bedrock cores were described and measured for recovery and Rock Quality Designation (RQD).

Groundwater observations were made during and at the end of drilling operations. The boreholes were grouted immediately upon completion.

3.2 Laboratory Testing

Soil samples were tested in the laboratory for moisture content (AASHTO T-265). Atterberg limits (AASHTO T 89/T 90) and particle size (AASHTO T 88) analyses were performed to classify selected samples. Field visual descriptions of the soil samples were verified in the laboratory and the tested samples were classified in accordance with the IDH Textural Classification chart. Laboratory test results are shown in the *Boring Logs* (Appendix A) and in the *Laboratory Test Results* (Appendix B).

4.0 RESULTS OF FIELD AND LABORATORY INVESTIGATIONS

Detailed descriptions of the soil conditions encountered during the subsurface investigation are presented in the attached *Boring Logs* (Appendix A) and in the *Soil Profile* (Exhibit 4). Please note that strata contact lines represent approximate boundaries between soil types. The actual transition between soil types in the field may be gradual in horizontal and vertical directions.

4.1 Soil Conditions

The viaduct investigation was performed along the lower levels of Congress Parkway and Tilden Street adjacent to the piers. The pavement sections along these roadways include 8 to 10 inches of concrete pavement over aggregate base. In descending order, the general lithological succession encountered beneath pavement or topsoil includes 1) man-made ground (fill); 2) stiff to very stiff silty clay; 3) very soft to medium stiff clay to silty clay; 4) stiff to very stiff silty clay loam; 5) hard silty clay and silty loam; 6) very dense gravelly sand; and 7) strong, fair to good quality dolostone.

(1) Man-made ground (fill)

Beneath the pavement, the borings encountered approximately 2 to 12 feet of very loose to dense, brown, black, and gray, fine to gravelly sand fill with miscellaneous debris. The fill has N-values from 0 to 37 blows/foot, including spoon refusals; we estimate the larger blow counts are outliers, and are likely the result of debris or obstruction and not a reflection of the material density. The moisture content values of the fill are relatively high, 15 to 29%, indicating this layer is exposed to perched groundwater during precipitation events.

(2) Stiff to very stiff silty clay

At elevations of about 580 to 585 feet, the fill overlies a 5- to 10-foot thick crust of stiff to very stiff, brown and gray silty clay. This thin layer has unconfined compressive strength (Q_u) values of 1.2 to 2.2 tsf and moisture contents from 20 to 24%.

(3) Very soft to medium stiff clay to silty clay

Below the crust, at elevations of about 575 to 578 feet, the borings encountered 30 to 40 feet of very soft to medium stiff, gray clay to silty clay. The ‘blue’ clay has Q_u values of 0.2 to 0.8 tsf and moisture content values of 21 to 31%. Laboratory index testing on soft clay samples shows liquid limit (L_L) values of 33 to 37% and plastic limit (P_L) values of 14 to 17%.

(4) Stiff to very stiff silty clay loam

At an elevation of about 540 feet, the soft clay transitions to stiff and very stiff silty clay. This soil has Q_u values of 1.2 to 3.6 tsf and moisture content values of 15 to 23%. Laboratory index testing on the stiff clay shows L_L values of 24 to 36% and plastic limit (P_L) values of 14 to 18%.

(5) Hard silty clay to silty loam

The borings encountered hard, gray silty clay to silty loam (hardpan) with traces of gravel at an average elevation of approximately 525 to 530 feet. This hard material has Q_u values generally greater than 5.0 tsf and moisture contents between 11 and 18%. The N-values in both the silty clay loam and silty loam are generally greater than 30 blows/foot. We have run an in-situ pressuremeter test immediately adjacent to the northwest corner of the viaduct in Boring 1715-PMT-01. A summary of the test results is shown below in Table 1.

Table 1: Summary of Pressuremeter Testing in Layer 5

Boring ID	Depth (feet)	Elevation (feet)	P_o (tsf)	P_f (tsf)	P_l (tsf)	E_o (tsf)	E_R (tsf)
1715-PMT-01	74.5	512	2.9	19.0	36.5	293	641

In Borings 0461-B-06, 07, 08B, 10, 11, and 12 along the eastern half of the viaduct, the investigation encountered a 5 to 10-foot thick layer of clay with noticeably higher moisture content of 23 to 33% and lower Q_u values, some as low as 0.7 tsf. This material was typically encountered in one or two split-

spoon samples between elevations of 510 and 520 feet; this soil is an important component of the subsurface profile due to its greater estimated deformability than the harder material directly above. The L_L value of the material is 36 to 38% and the P_L value is 18 to 19%.

(6) Very dense gravelly sand

Beneath the hardpan, the borings encountered very dense gravelly sand and weathered dolostone above the bedrock, ranging in thickness from 2 to greater than 15 feet. Each sample attempt within this material was met with spoon refusal and this soil layer can be considered an intermediate geomaterial (IGM) by AASHTO standards (2012). The borings encountered refusal at elevations ranging from 501 to 485 feet.

(7) Strong, fair to excellent quality dolostone

Sound bedrock was encountered at an average elevation of about 490 feet and was cored in Borings 0461-B-04, 07, 09, and 15 in 10-foot runs. The coring revealed strong dolostone of fair to excellent rock quality having RQD values of 65 to 94%.

4.2 Groundwater Conditions

Groundwater was encountered during drilling within the gravelly sand below an elevation of about 510 feet and perched within the sandy fill material below the roadway elevation. For design purposes, the gravelly sand and any other granular materials encountered below 510 feet, should be considered water-bearing and should be accounted for during the design and construction of the foundations. The possibility of encountering perched groundwater should be accounted for during construction.

4.3 Seismic Design Considerations

The seismic site class has been determined in accordance with the IDOT *All Geotechnical Manual Users (AGMU) 9.1* method of analysis. The soils within the top 100 feet have a weighted average S_u of 0.5 to 1.0 ksf (AASHTO 2012; Method C controlling), and the results classify the site in the Seismic Site Class E in accordance with the IDOT method. The analysis has been performed for shaft foundations with minimum diameters of 48 inches. The project location belongs to the Seismic Performance Zone 1. The seismic spectral acceleration parameters recommended for design in accordance with AASHTO (2012) are summarized in Table 2. The factor of safety (FOS) against liquefaction for the bridge site is greater than the AASHTO-required value of 1.

For seismic design based on the 2002 AASHTO *Specifications for Road and Bridge Design* the

horizontal bedrock acceleration coefficient is 3.7%, with a 90% probability of not being exceeded in 50 years, the Soil Profile is Type I, the Site Coefficient is 1.0, and the Seismic Performance Category is A (AASHTO, 2002).

Table 2: Seismic Design Parameters

Spectral Acceleration Period (sec)	Spectral Acceleration Coefficient ¹⁾ (% g)	Site Class Factors	Design Spectrum for Site Class E ²⁾ (% g)
0.0	PGA = 4.1	$F_{pga} = 2.5$	$A_s = 10.4$
0.2	$S_s = 9.0$	$F_a = 2.5$	$S_{DS} = 22.4$
1.0	$S_1 = 3.6$	$F_v = 3.5$	$S_{D1} = 12.5$

1) Base spectral acceleration coefficients from AASHTO (2012)

2) Site Class E values to be presented on plans ($A_s = PGA * F_{pga}$; $S_{DS} = S_s * F_a$; $S_{D1} = S_1 * F_v$)

5.0 FOUNDATION ANALYSIS AND RECOMMENDATIONS

Geotechnical evaluations and recommendations for the reuse of the existing caisson foundations are included in the following sections. The proposed change in loading on the foundations is not yet established; when the loads are available the evaluations should be revised appropriately.

The proposed ramp walls adjacent to Column Line 14 and supporting the proposed ramp abutments will be discussed in separate SGRs.

5.1 Structure Foundations

Wang understands the existing piers are supported on drilled shafts with diameters of approximately 4.0 to 5.5 feet, shown in the pier detail sheets from the original 1950 plan set. Additional sub-pier detail sheets, titled “*Furnishing and Constructing Sub Piers*”, dated 1949, shows a shaft detail with a 6-inch minimum embedment into rock. Section details contained on the “*Plan of Substructure*” sheet within the 1950 plan set, however, show the shafts ending at an elevation of about -70 to -80 feet, CCD. In agreement, the 1949 sub pier detail sheets show bottom of shaft elevations of -73 to -83 feet, with the majority of the shafts based at -76 to -80 feet, CCD. This corresponds to an NAVD88 elevation of

about 510 to 500 feet and **is not the top of sound bedrock** within the soil borings taken during this investigation. Sound bedrock was encountered at about 490 feet, with a relatively thick layer of weathered bedrock above spanning the length and width of the viaduct. Soil borings, confirming that the top of sound bedrock elevation was established at some point during the original design are not included in the full 1950 plan set or the 1949 sub pier detail sheets; therefore, the information currently available on where the base of the shafts were established gives strong indications that they may not extend into sound bedrock. If the design loads for the reconstructed viaduct are greater than the existing loads we strongly encourage pursuing means of determining the base elevations of the shafts prior to final design of the viaduct.

If the shafts are established at least 6-inches within the sound bedrock, as suggested in the detail on Sheet #4 of the sub pier plans, the bedrock cores show uniform, fair to excellent rock quality conditions. The shaft schedules on Sheets #4 and #5 of the sub pier plans show two socket diameters of 38 and 44 inches (3.2 to 3.8 feet). We recommend designing the rock sockets based on the methods outlined in the 2012 AASHTO LRFD *Bridge Design Specifications*. The rock sockets should be designed for a geotechnical unit base resistance factor (ϕ_{stat}) of 0.50. We estimate the bedrock has an RMR value of 56 to 62 (AASHTO, 2012). Based on this criterion, the R_F , R_N , and estimated base elevations for the 38- and 44-inch diameter sockets are summarized in Table 3. We estimate the settlement of the rock sockets will be less than 0.5 inch.

Table 3: Estimated Resistances for Rock Socket Shafts

Structure Unit	Top of Bedrock Elevation (feet)	Socket Diameter (inches)	Nominal Unit Socket Resistance (ksf)	Nominal Socket Resistance, R_N (kips)	Factored Resistance Available, R_F (kips)	Total Socket Length (inches)	Estimated Total Shaft Length (feet)
Piers 1 thru 17	490	38	227	2180	1090	6	95 to 105
		44	227	2925	1463	6	95 to 105

At the elevations shown in the shaft schedules (-73 to -83 feet, CCD) on the sub pier plans, the shafts would not be established within the sound bedrock. In this case, the nominal and factored design resistances would decrease significantly. Based on the methods outlined by AASHTO (2012, Section 10.8.3.5.2c), the nominal unit base resistance for intermediate geomaterials (IGM) with an N-value of 100 blows/foot maximum, is 70 ksf. The factored unit base resistance is based on an IGM resistance

factor of 0.55 and is 39 ksf, or a 157 ksf reduction from the sound bedrock resistance. The R_F , R_N , and estimated base elevations for the 38- and 44-inch diameter shafts in IGM are summarized in Table 4. We estimate the settlement of the IGM would also be less than 0.5 inch.

Table 4: Estimated Resistances for Shafts in IGM

Structure Unit	Base of Shaft Elevations (feet)	Base Diameter (inches)	Nominal Unit Socket Resistance (ksf)	Nominal Socket Resistance, R_N (kips)	Factored Resistance Available, R_F (kips)	Estimated Total Shaft Length (feet)
Piers 1 thru 17	507 to 497	38	70	551	303	85 to 95
		44	70	739	406	85 to 95

Prior to final design, we recommend confirming the existing base elevation of the shafts if the load is scheduled to increase relative to the existing load. This can be accomplished via one of the following three testing methods: 1) Pile Integrity Testing (PIT); 2) parallel seismic geophysical testing; or 3) concrete coring through the shaft to sample at the base. The PIT testing is likely the most economical solution, and would provide the approximate length of the shaft under ideal circumstances, but would not extend beyond any necking or cracking in the shaft. This method may show shorter shafts. The parallel seismic testing is performed within a borehole drilled adjacent to the shaft. The borehole should extend beyond the tip of the foundation, and would therefore be established about 5 to 10 feet into the underlying bedrock. The concrete coring with subsequent sampling beyond the base of the shaft is the most complete and visually confirmable method of determining if the shafts are on sound rock, but performing this work will require drill rig access to the top of at least one of the shafts. Of the three potential testing methods, we recommend the parallel seismic testing is the most feasible method and will provide the most complete data on the base elevation of the shafts. We recommend testing one shaft at a minimum of three existing piers; if inconsistencies are identified in the test results, we recommend choosing two additional piers and testing one shaft at each.

Lateral loads on piles and shafts should be analyzed for maximum moments and lateral deflections. Recommended lateral soil modulus and strain parameters required for analysis via the p-y curve method are included in Table 5. The incremental parameters for the soft silty clay (**Layer 3**) were obtained from vane shear testing conducted in borings throughout the eastern portion of the Circle Interchange.

Table 5: Recommended Soil Parameters for Lateral Load Analysis

Soil Type (Layer)	Unit Weight, γ (pcf)	Undrained Shear Strength, c_u (psf)	Estimated Friction Angle, ϕ ($^\circ$)	Estimated Lateral Soil Modulus Parameter, k (pci)	Estimated Soil Strain Parameter, ϵ_{50} (%)
Loose to M Dense SANDY FILL (1)	115	0	32	60	--
Stiff to V Stiff SILTY CLAY (2) EL 585 to 580 feet	120	1500	0	1000	0.7
Soft to M Stiff CLAY (3) EL 580 to 570 feet	115	750	0	100	1.0
V Soft CLAY (3) EL 570 to 550 feet	115	600	0	100	1.0
Soft to M Stiff SILTY CLAY (3) EL 550 to 540 feet	115	750	0	100	1.0
Stiff to V Stiff CLAY (4)	120	1500	0	1000	0.6
Hard SILTY CLAY (5)	125	4500	0	2000	0.4

5.2 Stage Construction Design Recommendations

We estimate any excavations required to reuse the existing foundations can be sloped and temporary shoring will not be required.

6.0 QUALIFICATIONS

The analysis and recommendations submitted in this report are based upon the data obtained from the borings drilled at the locations shown on the boring logs and in Exhibit 3. This report does not reflect any variations that may occur between the borings or elsewhere on the site, variations whose nature and extent may not become evident until the course of construction. In the event that any changes in the design and/or location of the bridge are planned, we should be timely informed so that our recommendations can be adjusted accordingly.

It has been a pleasure to assist AECOM and the Illinois Department of Transportation on this project. Please call if there are any questions, or if we can be of further service.

Respectfully Submitted,

WANG ENGINEERING, INC.

Mickey L. Snider, P.E.
Senior Geotechnical Engineer

Jerry W.H. Wang, Ph.D., P.E.
QA/QC Reviewer



REFERENCES

- AASHTO (2012) LRFD Bridge Design Specifications: Washington, D.C., American Association of State Highway and Transportation Officials.
- BAUER, R.A., CURRY, B.B., GRAESE, A.M., VAIDEN, R.C., SU, W.J., and HASEK, M.J. (1991) Geotechnical Properties of Selected Pleistocene, Silurian, and Ordovician Deposits of Northeastern Illinois: Environmental Geology 139, Illinois State Geological Survey, 69 p.
- BROWN, D.A., TURNER, J.P., and CASTELLI, R.J. (2010) Drilled Shafts: Construction Procedures and LRFD Design Methods: Geotechnical Engineering Circular No. 10: Washington, D.C., Federal Highway Administration, 970 p.
- CHRZATOWSKY, M.J., and THOMPSON, T.A. (1992) Late Wisconsinan and Holocene coastal evolution of the southern shore of Lake Michigan, *in* Fletcher, C.H., III, and Wehmiller, J.F., eds., Quaternary Coasts of the United States: Marine and Lacustrine Systems: SEPM Special Publication No.48: Tulsa, Oklahoma, Society for Sedimentary Geology, p. 397-413.
- HANSEL, A.K., and JOHNSON, W.H. (1996) Wedron and Mason Groups: Lithostratigraphic Reclassification of the Wisconsin Episode, Lake Michigan Lobe Area: ISGS Bulletin 104: Champaign, Illinois State Geological Survey, 116 p.
- IDOT (2012a) Bridge Manual, Illinois Department of Transportation.
- IDOT (2012b) Standard Specifications for Road and Bridge Construction, Illinois Department of Transportation, 1098 p.
- LEETARU, H.E., SARGENT, M.L., and KOLATA, D.R. (2004) Geologic Atlas of Cook County for Planning Purposes, Open File Series 2004-12, Illinois State Geological Survey, p. 30.
- PECK, R.B., and REED, W.C. (1954) Engineering Properties of Chicago Subsoils: University of Illinois Engineering Experiment Station Bulletin No. 423: Urbana, University of Illinois, 62
- WILLMAN, H.B. (1971) Summary of the Geology of the Chicago Area, ISGS Circular C460: Urbana, Illinois State Geological Survey, p. 77.

EXHIBITS

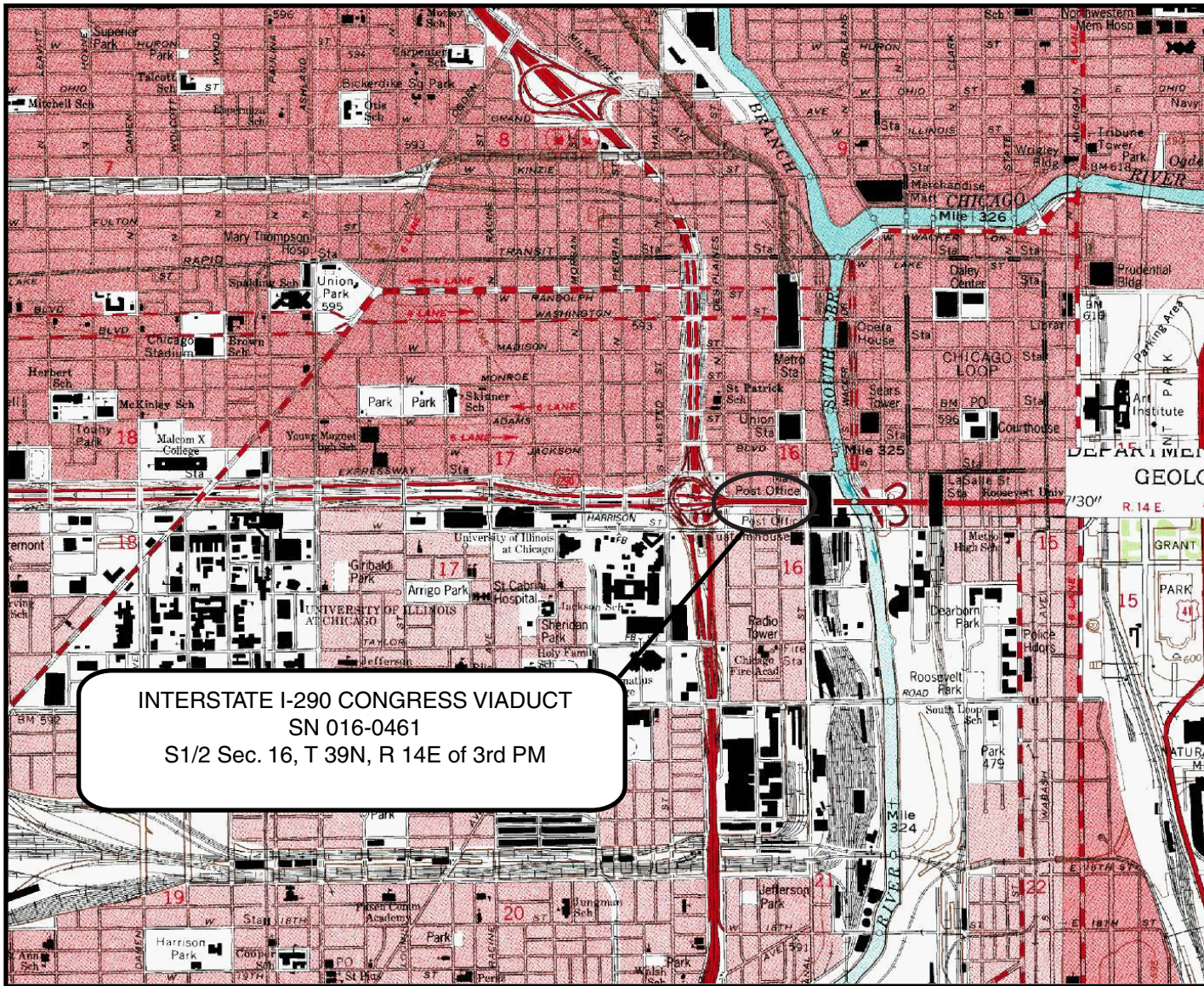

INTERSTATE I-290 CONGRESS VIADUCT
 SN 016-0461
 S1/2 Sec. 16, T 39N, R 14E of 3rd PM



Cook County

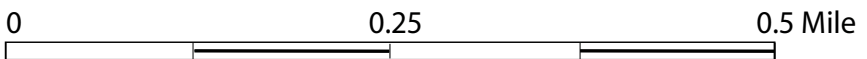

SITE LOCATION MAP: CIRCLE INTERCHANGE RECONSTRUCTION INTERSTATE 290 CONGRESS VIADUCT, SN 016-0461, COOK COUNTY

SCALE: GRAPHICAL | EXHIBIT 1 | DRAWN BY: M. de los Reyes | CHECKED BY: M. Snider



1145 N. Main Street
 Lombard, IL 60148
 www.wangeng.com

FOR AECOM | 1100-04-01

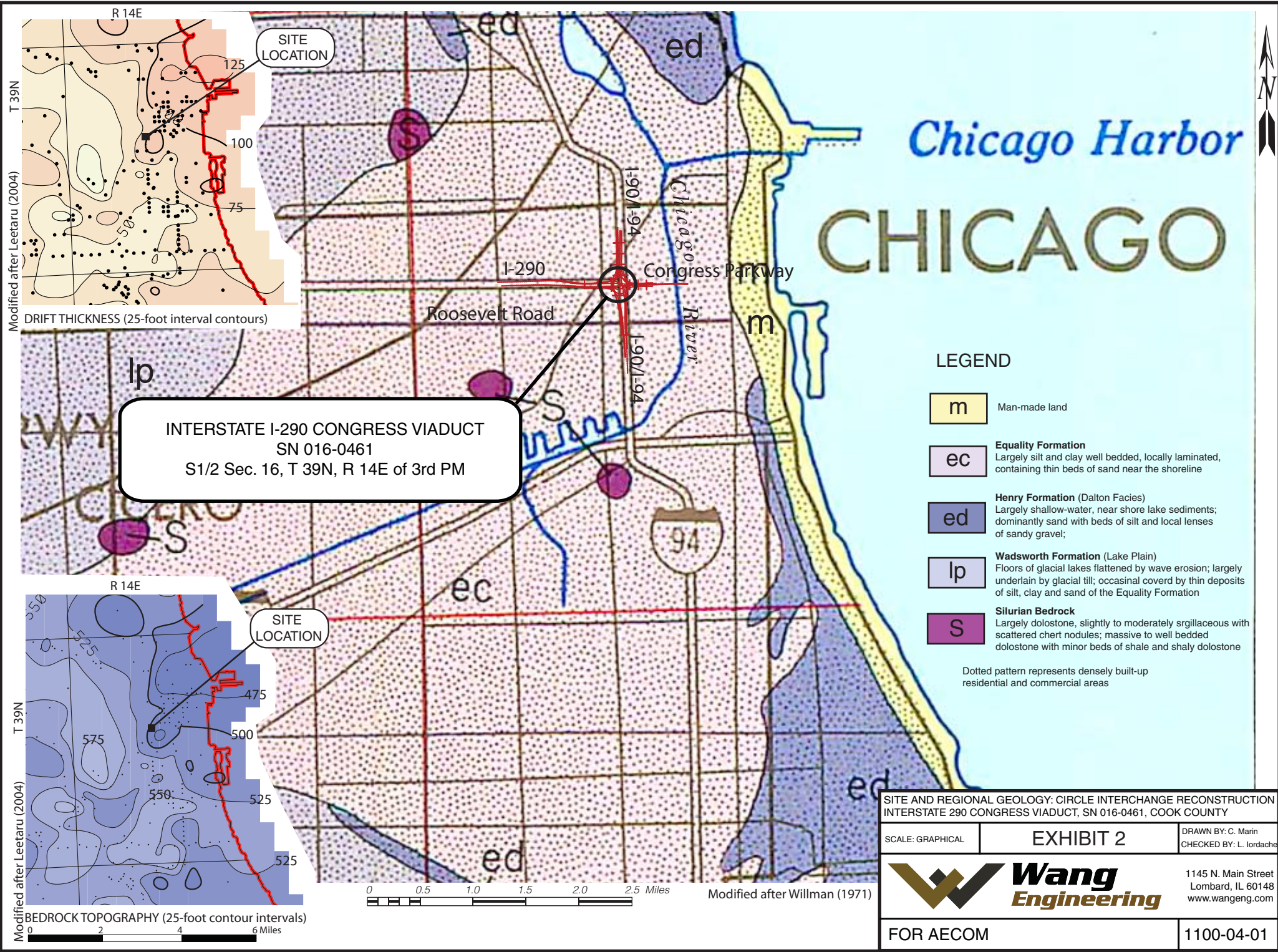

INTERSTATE I-290 CONGRESS VIADUCT
 SN 016-0461
 S1/2 Sec. 16, T 39N, R 14E of 3rd PM

- LEGEND**
- m** Man-made land
 - ec** **Equality Formation**
Largely silt and clay well bedded, locally laminated, containing thin beds of sand near the shoreline
 - ed** **Henry Formation (Dalton Facies)**
Largely shallow-water, near shore lake sediments; dominantly sand with beds of silt and local lenses of sandy gravel;
 - lp** **Wadsworth Formation (Lake Plain)**
Floors of glacial lakes flattened by wave erosion; largely underlain by glacial till; occasional covered by thin deposits of silt, clay and sand of the Equality Formation
 - S** **Silurian Bedrock**
Largely dolostone, slightly to moderately argillaceous with scattered chert nodules; massive to well bedded dolostone with minor beds of shale and shaly dolostone
- Dotted pattern represents densely built-up residential and commercial areas

SITE AND REGIONAL GEOLOGY: CIRCLE INTERCHANGE RECONSTRUCTION INTERSTATE 290 CONGRESS VIADUCT, SN 016-0461, COOK COUNTY

SCALE: GRAPHICAL **EXHIBIT 2** DRAWN BY: C. Marin
 CHECKED BY: L. Iordache

Wang Engineering
 1145 N. Main Street
 Lombard, IL 60148
 www.wangeng.com

FOR AECOM 1100-04-01

Modified after Leetaru (2004)

Modified after Leetaru (2004)

Modified after Willman (1971)

Bench Mark: Square cut at center of door entrance to 707 W. Harrison St. South side of Harrison St. ±90' west of west line of Des Plaines. Elevation 597.47. A + cut in the SE anchor bolt at the 11th street light N. of Roosevelt on the W. side of Halsted. Elev. = 594.06.

Existing Structure: S.N. 016-0461 was originally built in 1952 as F.A. Route Number 131, Section 062-2424.4. The existing structure consists of 16 main spans of multi-unit steel continuous multi-beam superstructures with additional entrance and exit ramp spans along Spans 12 and 13. The existing structure has an overall length of approximately 1300'-0" and an average cut-to-out width of approximately 162'-0" for the main spans and 25'-0" for the ramp spans. The substructure units are founded on drilled shafts and consist of 17 multi column piers. The existing bridge is to be rehabilitated through a combination of partial removal and replacement, repairs, and partial infill of ramp spans.

Traffic Control: Two lanes of traffic will be maintained in each direction utilizing stage construction. Canal Street exit and entrance ramps, ramp WS, ramp WN and ramp NE will be closed during stage construction of the outside lanes. Traffic will be detoured via local roads.

Solvoage: None

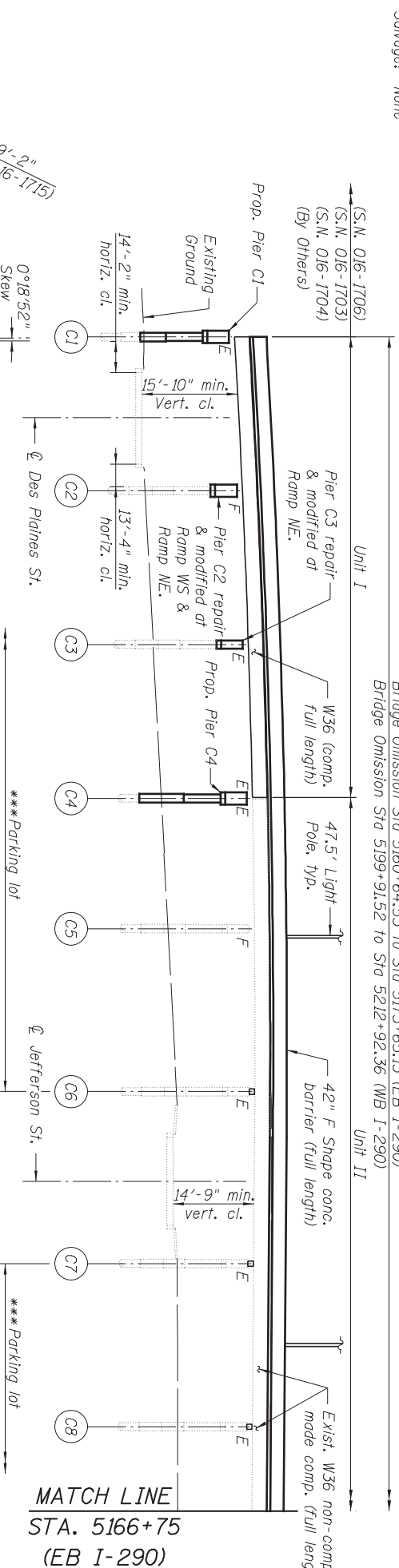

- ① Sta. 5163+05.06 (EB I-290) Offset 53.25' Rt.
- ② Sta. 5163+05.06 (EB I-290) Offset 24.50' Rt.
- ③ Sta. 5162+25.79 (EB I-290) Offset 27.58' Rt.
- ④ Sta. 5161+85.50 (EB I-290) Offset 27.58' Rt.
- ⑤ Sta. 5160+64.71 (EB I-290) Offset 32.54' Rt.
- ⑥ Sta. 5212+97.58 (WB I-290) Offset 34.69' Rt.
- ⑦ Sta. 5212+14.16 (WB I-290) Offset 49.60' Rt.
- ⑧ Sta. 5212+15.75 (WB I-290) Offset 83.58' Rt.
- ⑨ Sta. 5210+60.50 (WB I-290) Offset 58.08' Rt.
- ⑩ Sta. 5209+89.73 (WB I-290) Offset 54.25' Rt.

DESIGN SPECIFICATIONS

2012 AASHTO LRFD Bridge Design Specifications
6th Edition with 2013 Interim Revisions (Spans 1-3)
2002 AASHTO Standard Specifications for Highway Bridges (Spans 4-16)

DESIGN STRESSES

FIELD UNITS (New Construction)

$f_c = 3,500$ psi
 $f_y = 60,000$ psi (Reinforcement)
 $f_y = 50,000$ psi (M270 Grade 50)

FIELD UNITS (Exist. Construction)

$f_c = 3,500$ psi
 $f_y = 40,000$ psi (Reinforcement)
 $f_y = 33,000$ psi (ASTM A7)

LOADING HL-93 (SPANS 1-3)

LOADING HS20-44 & ALT. (SPANS 4-16)

Allow 50#/#sq. ft. for future wearing surface

SEISMIC DATA

Seismic Performance Zone (SPZ) = 1
 Design Spectral Acceleration at 1.0 sec. (S_{d1}) = 0.109
 Design Spectral Acceleration at 0.2 sec. (S_{d5}) = 0.229
 Soil Site Class = E

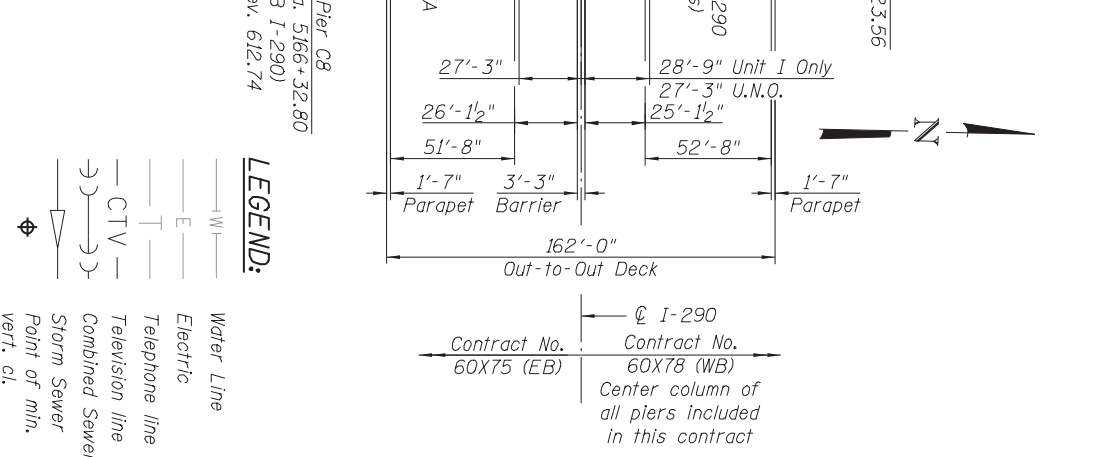
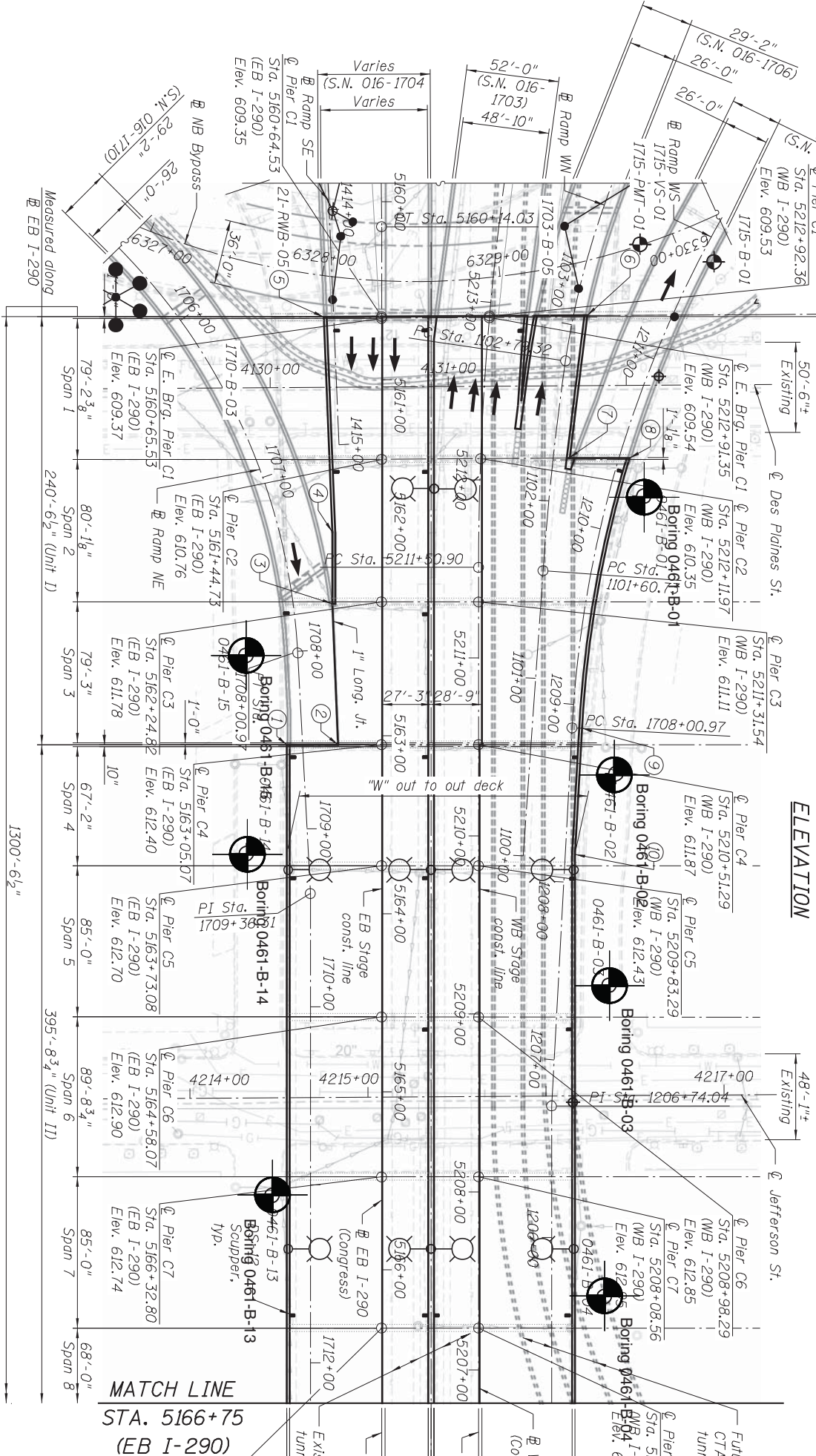

DESIGN STRESSES

FIELD UNITS (New Construction)

$f_c = 3,500$ psi
 $f_y = 60,000$ psi (Reinforcement)
 $f_y = 50,000$ psi (M270 Grade 50)

FIELD UNITS (Exist. Construction)

$f_c = 3,500$ psi
 $f_y = 40,000$ psi (Reinforcement)
 $f_y = 33,000$ psi (ASTM A7)

LOADING HL-93 (SPANS 1-3)

LOADING HS20-44 & ALT. (SPANS 4-16)

Allow 50#/#sq. ft. for future wearing surface

SEISMIC DATA

Seismic Performance Zone (SPZ) = 1
 Design Spectral Acceleration at 1.0 sec. (S_{d1}) = 0.109
 Design Spectral Acceleration at 0.2 sec. (S_{d5}) = 0.229
 Soil Site Class = E

"W" OUT TO OUT DECK

148'-1 1/8" @ Pier C1
 134'-6 3/8" @ Pier C2 - Span 1
 168'-6 5/8" @ Pier C2 - Span 2
 147'-11 3/4" @ Pier C3
 165'-2 1/2" @ Pier C4
 162'-0" @ Point 10

GENERAL PLAN & ELEVATION - 1

I-290 (CONGRESS) VIADUCT OVER

DES PLAINES ST. TO CANAL ST.

BRIDGE REHABILITATION

F.A.I. ROUTE 90/94/290

SECTION 2014-001 R&B (EB),

2014-004 R&B (WB)

COOK COUNTY

STATION 5165+03.09

STRUCTURE NO. 016-0461

PARSONS BRINCKERHOFF

FILE NAME = USER	DESIGNED = P.L.	REVISION	REVISION
PLT SCALE = NONE	CHECKED = HA	REVISION	REVISION
PLT DATE = 9/29/2014	DRAWN = DDP	REVISION	REVISION
	CHECKED = JIC	REVISION	REVISION

STATE OF ILLINOIS

DEPARTMENT OF TRANSPORTATION

BRIDGE REHABILITATION

STRUCTURE NO. 016-0461

SHEET NO. 1 OF 8 SHEETS

F.A.I. RTE.	SECTION	COUNTY	TOTAL SHEETS
90/94/290	**	COOK	8
			1

ILLINOIS FED. AID PROJECT

**PARSONS
BRINCKERHOFF**

FILE NAME = USER
DESIGNED - P.L.
CHECKED - HA
PLANT SCALE = NONE
DRAWN - DDP
CHECKED - JIC
PLOT DATE = 9/29/2014

REVISOR
REVISION
REVISION
REVISION
REVISION

DESIGNED - P.L.
CHECKED - HA
PLANT SCALE = NONE
DRAWN - DDP
CHECKED - JIC

STATE OF ILLINOIS
DEPARTMENT OF TRANSPORTATION

BRIDGE REHABILITATION
STRUCTURE NO. 016-0461

SHEET NO. 2 OF 8 SHEETS

BRIDGE REHABILITATION
STRUCTURE NO. 016-0461

F.A.I. RT# SECTION COUNTY TOTAL SHEET NO.
90/94/290 ** COOK 8 2
ILLINOIS FED. AID PROJECT CONTRACT NO. *

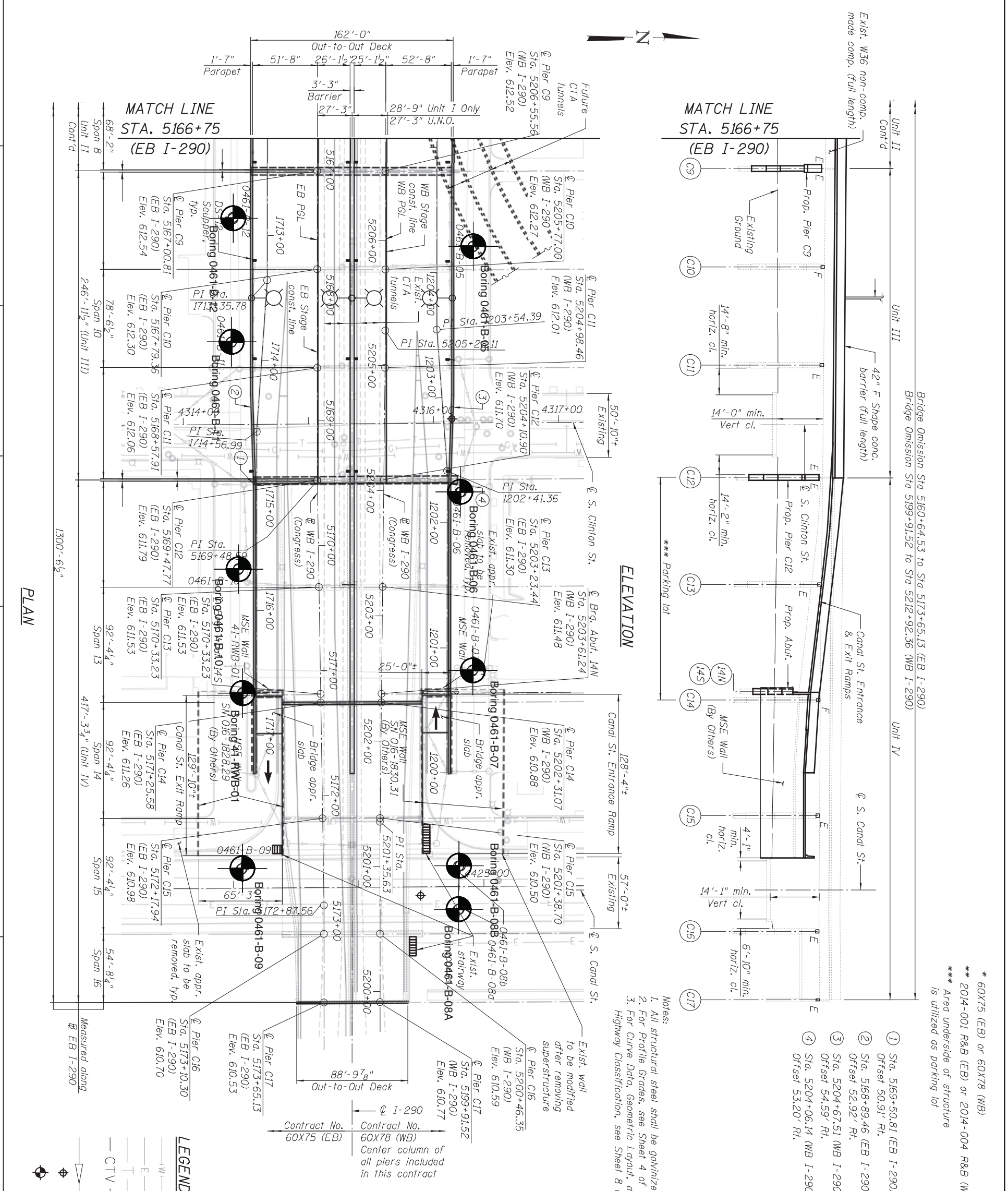

GENERAL PLAN & ELEVATION - 2
I-290 (CONGRESS) VIADUCT OVER
DES PLAINES ST. TO CANAL ST.
BRIDGE REHABILITATION
F.A.I. ROUTE 90/94/290
SECTION 2014-001 R&B (EB),
2014-004 R&B (WB)
COOK COUNTY
STATION 5165+03.09
STRUCTURE NO. 016-0461

FOR AECOM
1100-04-01

Wang Engineering
1145 N. Main Street
Lombard, IL 60148
www.wangeng.com

BORING LOCATION PLAN: CIRCLE INTERCHANGE RECONSTRUCTION INTERSTATE 290 CONGRESS VIADUCT, SN 016-0461, COOK COUNTY
SCALE GRAPHICAL EXHIBIT 3-2
DESIGNED BY: M. SHINE
CHECKED BY: M. SHINE

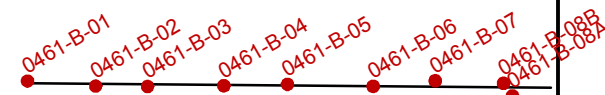
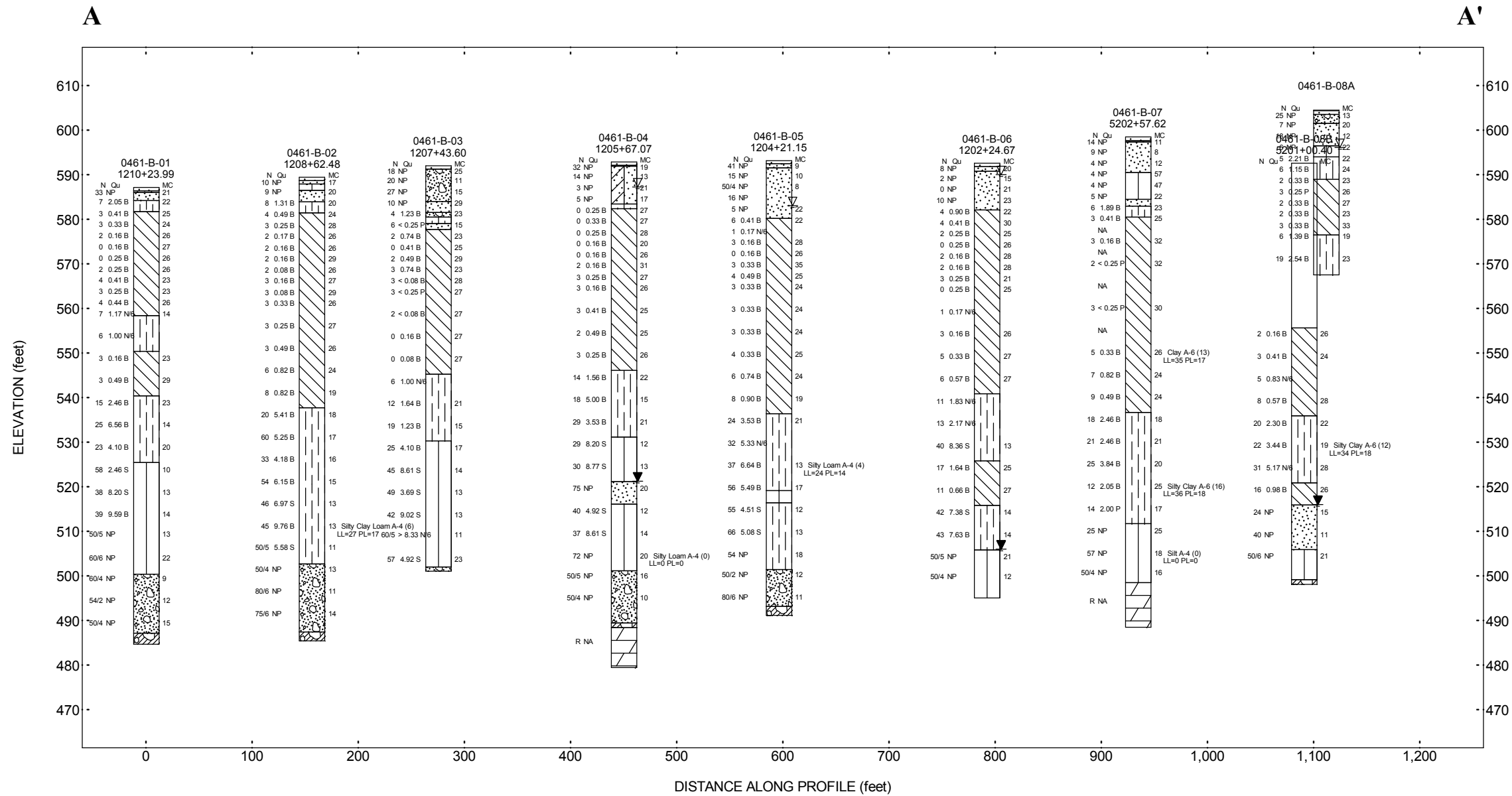

Site Map Scale 1 inch equals 440 feet

Explanation:

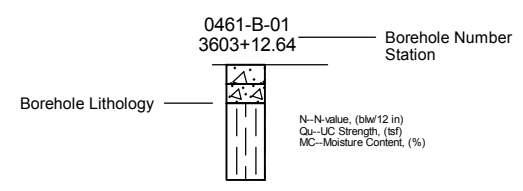

- ▽ Water Level Reading at time of drilling.
- ▼ Water Level Reading 24-hr after drilling or at end of drilling

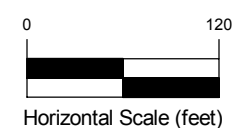

Vertical Exaggeration: 4x

Lithology Graphics

- Concrete
- IDH Clay
- IDH Loam
- Crushed stone
- IDH Silt, Silty Loam
- Dolomite or Dolomitic Limestone
- IDH Sand, Sandy Loam
- Gravelly sand, sandy gravel
- Pavement
- IDH Silty Clay, Silty Clay Loam
- Weathered bedrock

Wang Engineering, Inc.
 1145 N Main Street
 Lombard, IL 60148

Soil Profile A-A'
SN 016-0461, Congress Viaduct Westbound



Circle Interchange Reconstruction
 Section 17, T39N, R14E of 3rd PM

JOB NUMBER	PLATE NUMBER
1100-04-01	EXHIBIT 4-1

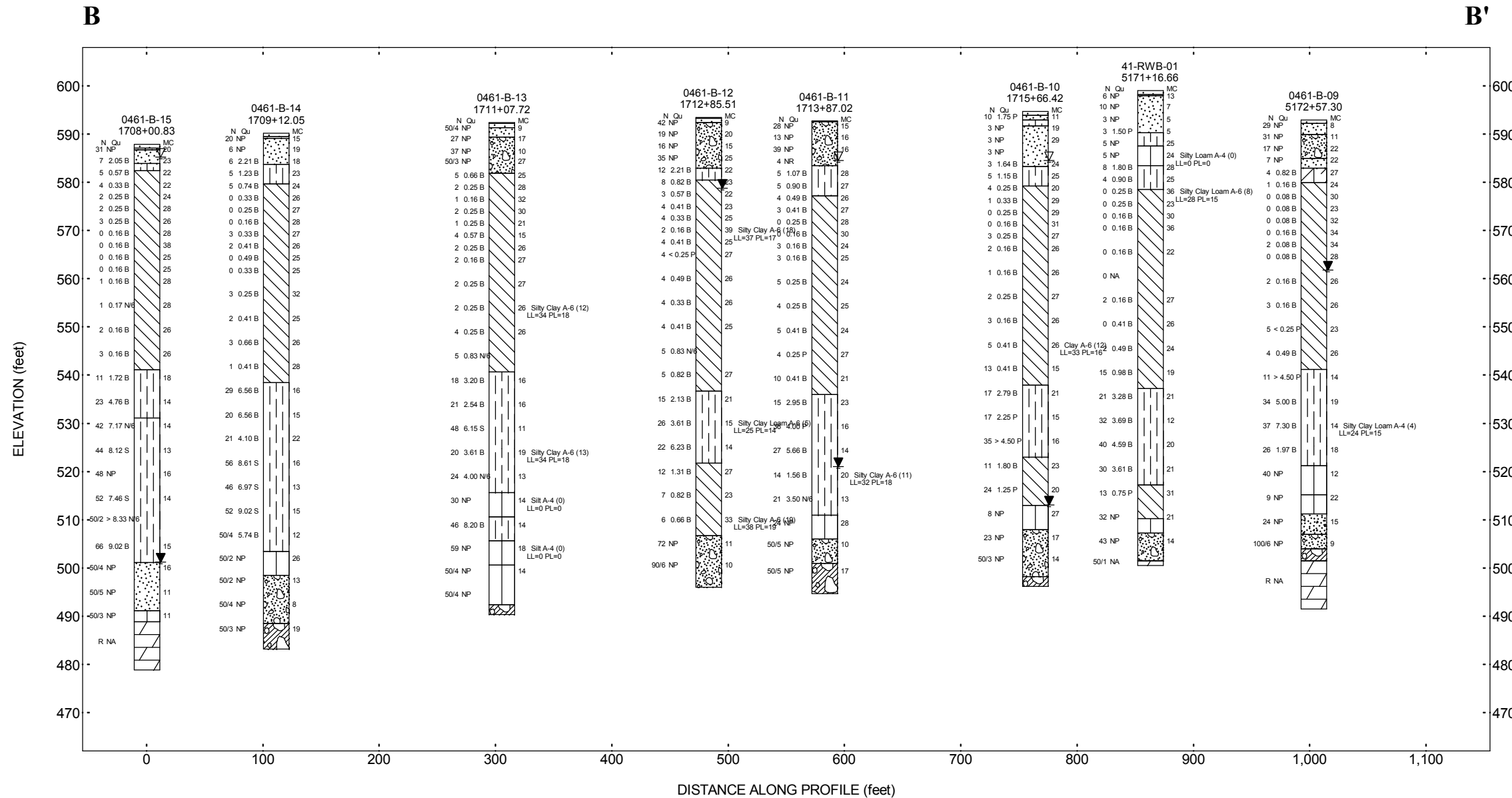

Lithology Graphics

	Concrete		IDH Sand, Sandy Loam		Gravelly sand, sandy gravel		IDH Clay Loam
	IDH Clay		IDH Silty Clay, Silty Clay Loam		IDH Silt, Silty Loam		Coarse sand
	Weathered bedrock		Dolomite or Dolomitic Limestone		Crushed stone		Pavement

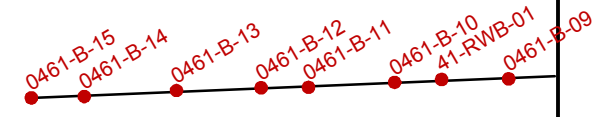

Site Map Scale 1 inch equals 405 feet

Explanation:

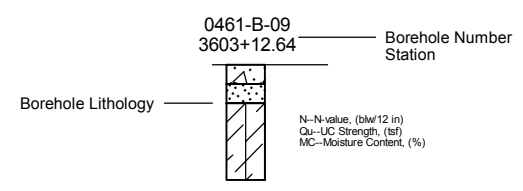

- Water Level Reading at time of drilling.
- Water Level Reading 24-hr after drilling or at end of drilling

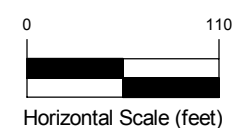

Vertical Exaggeration: 4x

Wang Engineering, Inc.
1145 N Main Street
Lombard, IL 60148

Soil Profile B-B'
SN 016-0461, Congress Viaduct Eastbound



Circle Interchange Reconstruction
Section 17, T39N, R14E of 3rd PM

JOB NUMBER	PLATE NUMBER
1100-04-01	EXHIBIT 4-2

APPENDIX A



BORING LOG 0461-B-01

wangeng@wangeng.com
 1145 N Main Street
 Lombard, IL 60148
 Telephone: 630 953-9928
 Fax: 630 953-9938

WEI Job No.: 1100-04-01

Client **AECOM**
 Project **Circle Interchange Reconstruction**
 Location **Section 17, T39N, R14E of 3rd PM**

Datum: NAVD 88
 Elevation: 587.18 ft
 North: 1898107.11 ft
 East: 1172063.72 ft
 Station: 1210+23.99
 Offset: 19.2353 RT

Profile	Elevation (ft)	SOIL AND ROCK DESCRIPTION	Depth (ft)	Sample Type recovery	Sample No.	SPT Values (blw/6 in)	Qu (tsf)	Moisture Content (%)	Profile	Elevation (ft)	SOIL AND ROCK DESCRIPTION	Depth (ft)	Sample Type recovery	Sample No.	SPT Values (blw/6 in)	Qu (tsf)	Moisture Content (%)
	586.4	10-inch thick CONCRETE															
	586.0	--PAVEMENT--															
		4-inch thick GRAVELLY SAND			1	15 15 18	NP	21						11	0 2 2	0.44 B	26
		--BASE COURSE--															
	584.2	Dense, gray, fine SAND															
		--FILL--															
		Very stiff, gray SILTY CLAY, trace gravel	5		2	3 3 4	2.05 B	22		558.4	Stiff, gray SILTY CLAY LOAM, trace gravel	30		12	2 2 5	1.17 N/6	14
	581.7	Very soft to soft, gray CLAY to SILTY CLAY, trace gravel			3	2 1 2	0.41 B	25									
			10		4	0 1 2	0.33 B	24				35		13	2 3 3	1.00 N/6	
			15		5	0 1 1	0.16 B	26		550.4	Very soft to soft, gray CLAY to SILTY CLAY, trace gravel						
			20		6	0 0 0	0.16 B	27				40		14	0 1 2	0.16 B	23
			25		7	0 0 0	0.25 B	26									
					8	0 0 2	0.25 B	26				45		15	0 1 2	0.49 B	29
					9	1 2 2	0.41 B	23		540.4	Very stiff to hard, gray SILTY CLAY to SILTY CLAY LOAM, trace gravel						
					10	0 1 2	0.25 B	23				50		16	1 7 8	2.46 B	23

GENERAL NOTES

Begin Drilling **03-24-2014** Complete Drilling **03-24-2014**
 Drilling Contractor **Wang Testing Services** Drill Rig **CME-55 TMR**
 Driller **R&N** Logger **M de los Reyes** Checked by **C. Marin**
 Drilling Method **2.25" SSA to 12.5', mud rotary thereafter, boring**
backfilled upon completion

WATER LEVEL DATA

While Drilling ∇ **NA**
 At Completion of Drilling ∇ **NA**
 Time After Drilling **NA**
 Depth to Water ∇ **NA**

The stratification lines represent the approximate boundary between soil types; the actual transition may be gradual.

WANGENGINC 11000401.GPJ WANGENG.GDT 9/26/14



BORING LOG 0461-B-01

wangeng@wangeng.com
 1145 N Main Street
 Lombard, IL 60148
 Telephone: 630 953-9928
 Fax: 630 953-9938

WEI Job No.: 1100-04-01

Client **AECOM**
 Project **Circle Interchange Reconstruction**
 Location **Section 17, T39N, R14E of 3rd PM**

Datum: NAVD 88
 Elevation: 587.18 ft
 North: 1898107.11 ft
 East: 1172063.72 ft
 Station: 1210+23.99
 Offset: 19.2353 RT

Profile	Elevation (ft)	SOIL AND ROCK DESCRIPTION	Depth (ft)	Sample Type recovery	Sample No.	SPT Values (blw/6 in)	Qu (tsf)	Moisture Content (%)	Profile	Elevation (ft)	SOIL AND ROCK DESCRIPTION	Depth (ft)	Sample Type recovery	Sample No.	SPT Values (blw/6 in)	Qu (tsf)	Moisture Content (%)
	525.4	Hard, gray SILTY CLAY LOAM to SILTY LOAM, trace gravel	55	X	17	8 11 14	6.56 B	14		500.4	Very dense, gray GRAVELLY SAND	80	X	22	50/5	NP	13
	60		X	18	6 10 13	4.10 B	20		85	X		23	40 60/6	NP	22		
	65		X	19	18 30 28	2.46 S	10		90	X		24	60/4	NP	9		
	70		X	20	15 17 21	8.20 S	13		95	X		25	54/2	NP	12		
	75		X	21	11 17 22	9.59 B	14		100	X		26	50/4	NP	15		
										487.2							

--HARD DRILLING--
 --Possible Cobbles--

--HARD DRILLING--
 --Possible Cobbles--

--HARD DRILLING--
 --Possible Cobbles--

GENERAL NOTES

WATER LEVEL DATA

Begin Drilling **03-24-2014** Complete Drilling **03-24-2014**
 Drilling Contractor **Wang Testing Services** Drill Rig **CME-55 TMR**
 Driller **R&N** Logger **M de los Reyes** Checked by **C. Marin**
 Drilling Method **2.25" SSA to 12.5', mud rotary thereafter, boring**
 **backfilled upon completion**

While Drilling **NA**
 At Completion of Drilling **NA**
 Time After Drilling **NA**
 Depth to Water **NA**

The stratification lines represent the approximate boundary between soil types; the actual transition may be gradual.

WANGENGINC 11000401.GPJ WANGENG.GDT 9/26/14



wangeng@wangeng.com
 1145 N Main Street
 Lombard, IL 60148
 Telephone: 630 953-9928
 Fax: 630 953-9938

BORING LOG 0461-B-01

WEI Job No.: 1100-04-01

Client **AECOM**
 Project **Circle Interchange Reconstruction**
 Location **Section 17, T39N, R14E of 3rd PM**

Datum: NAVD 88
 Elevation: 587.18 ft
 North: 1898107.11 ft
 East: 1172063.72 ft
 Station: 1210+23.99
 Offset: 19.2353 RT

Profile	Elevation (ft)	SOIL AND ROCK DESCRIPTION	Depth (ft)	Sample Type recovery	Sample No.	SPT Values (blw/6 in)	Qu (tsf)	Moisture Content (%)	Profile	Elevation (ft)	SOIL AND ROCK DESCRIPTION	Depth (ft)	Sample Type recovery	Sample No.	SPT Values (blw/6 in)	Qu (tsf)	Moisture Content (%)
	484.7	--WEATHERED BEDROCK-- --DIFFICULT DRILLING-- --AUGER REFUSAL-- Boring terminated at 102.50 ft	105														

GENERAL NOTES

Begin Drilling **03-24-2014** Complete Drilling **03-24-2014**
 Drilling Contractor **Wang Testing Services** Drill Rig **CME-55 TMR**
 Driller **R&N** Logger **M de los Reyes** Checked by **C. Marin**
 Drilling Method **2.25" SSA to 12.5', mud rotary thereafter, boring**
 **backfilled upon completion**

WATER LEVEL DATA

While Drilling ▽ **NA**
 At Completion of Drilling ▼ **NA**
 Time After Drilling **NA**
 Depth to Water ▼ **NA**

The stratification lines represent the approximate boundary between soil types; the actual transition may be gradual.



BORING LOG 0461-B-02

wangeng@wangeng.com
 1145 N Main Street
 Lombard, IL 60148
 Telephone: 630 953-9928
 Fax: 630 953-9938

WEI Job No.: 1100-04-01

Client **AECOM**
 Project **Circle Interchange Reconstruction**
 Location **Section 17, T39N, R14E of 3rd PM**

Datum: NAVD 88
 Elevation: 589.44 ft
 North: 1898095.48 ft
 East: 1172219.91 ft
 Station: 1208+62.48
 Offset: 26.1117 RT

Profile	Elevation (ft)	SOIL AND ROCK DESCRIPTION	Depth (ft)	Sample Type recovery	Sample No.	SPT Values (blw/6 in)	Qu (tsf)	Moisture Content (%)	Profile	Elevation (ft)	SOIL AND ROCK DESCRIPTION	Depth (ft)	Sample Type recovery	Sample No.	SPT Values (blw/6 in)	Qu (tsf)	Moisture Content (%)	
	588.6	9.5-inch thick CONCRETE --PAVEMENT--																
	587.9	Gray CRUSHED STONE --BASE COURSE--			1	6 5 5	NP	17						11	1 1 2	0.08 B	29	
	586.4	Medium dense, brown and black SILTY LOAM --FILL--			2	3 4 5	NP	20						12	1 1 2	0.33 B	26	
	583.9	Stiff, brown SILTY CLAY LOAM, trace gravel			3	2 3 5	1.31 B	20										
	581.4	Very soft to medium stiff, gray CLAY to SILTY CLAY, trace gravel			4	1 2 2	0.49 B	24						13	1 1 2	0.25 B	27	
					5	0 1 2	0.25 B	28										
					6	0 1 1	0.17 B	26						14	1 1 2	0.49 B	26	
					7	1 1 1	0.16 B	26										
					8	0 1 1	0.16 B	29						15	2 3 3	0.82 B	24	
					9	0 0 2	0.08 B	26										
					10	1 1 2	0.16 B	27						16	2 3 5	0.82 B	19	

GENERAL NOTES

Begin Drilling **03-20-2014** Complete Drilling **03-20-2014**
 Drilling Contractor **Wang Testing Services** Drill Rig **CME-55 TMR**
 Driller **R&N** Logger **F. Bozga** Checked by **C. Marin**
 Drilling Method **2.25" SSA to 12.5', mud rotary thereafter, boring**
backfilled upon completion

WATER LEVEL DATA

While Drilling ∇ **NA**
 At Completion of Drilling ∇ **NA**
 Time After Drilling **NA**
 Depth to Water ∇ **NA**

The stratification lines represent the approximate boundary between soil types; the actual transition may be gradual.

WANGENGINC 11000401.GPJ WANGENG.GDT 9/26/14



BORING LOG 0461-B-02

wangeng@wangeng.com
 1145 N Main Street
 Lombard, IL 60148
 Telephone: 630 953-9928
 Fax: 630 953-9938

WEI Job No.: 1100-04-01

Client: **AECOM**
 Project: **Circle Interchange Reconstruction**
 Location: **Section 17, T39N, R14E of 3rd PM**

Datum: NAVD 88
 Elevation: 589.44 ft
 North: 1898095.48 ft
 East: 1172219.91 ft
 Station: 1208+62.48
 Offset: 26.1117 RT

Profile	Elevation (ft)	SOIL AND ROCK DESCRIPTION	Depth (ft)	Sample Type recovery	Sample No.	SPT Values (blw/6 in)	Qu (tsf)	Moisture Content (%)	Profile	Elevation (ft)	SOIL AND ROCK DESCRIPTION	Depth (ft)	Sample Type recovery	Sample No.	SPT Values (blw/6 in)	Qu (tsf)	Moisture Content (%)	
	537.7	Hard, gray SILTY CLAY LOAM to SILTY LOAM, trace gravel --HARD DRILLING-- --Possible Cobbles--																
			55	X	17	5 9 11	5.41 B	18					X	22	11 20 25	9.76 B	13	
			60	X	18	12 24 36	5.25 B	17					X	23	40 50/5	5.58 S	11	
			65	X	19	7 13 20	4.18 B	16			502.7	Very dense, gray GRAVELLY SAND to SANDY LOAM	90	X	24	23 50/4	NP	13
			70	X	20	13 27 27	6.15 B	15					95	X	25	80/6	NP	11
		75	X	21	11 19 27	6.97 S	13				100		X	26	75/6	NP	14	

GENERAL NOTES

Begin Drilling **03-20-2014** Complete Drilling **03-20-2014**
 Drilling Contractor **Wang Testing Services** Drill Rig **CME-55 TMR**
 Driller **R&N** Logger **F. Bozga** Checked by **C. Marin**
 Drilling Method **2.25" SSA to 12.5', mud rotary thereafter, boring**
backfilled upon completion

WATER LEVEL DATA

While Drilling ∇ **NA**
 At Completion of Drilling ∇ **NA**
 Time After Drilling **NA**
 Depth to Water ∇ **NA**

The stratification lines represent the approximate boundary between soil types; the actual transition may be gradual.



wangeng@wangeng.com
 1145 N Main Street
 Lombard, IL 60148
 Telephone: 630 953-9928
 Fax: 630 953-9938

BORING LOG 0461-B-02

WEI Job No.: 1100-04-01

Client **AECOM**
 Project **Circle Interchange Reconstruction**
 Location **Section 17, T39N, R14E of 3rd PM**

Datum: NAVD 88
 Elevation: 589.44 ft
 North: 1898095.48 ft
 East: 1172219.91 ft
 Station: 1208+62.48
 Offset: 26.1117 RT

Profile	Elevation (ft)	SOIL AND ROCK DESCRIPTION	Depth (ft)	Sample Type recovery	Sample No.	SPT Values (blw/6 in)	Qu (tsf)	Moisture Content (%)	Profile	Elevation (ft)	SOIL AND ROCK DESCRIPTION	Depth (ft)	Sample Type recovery	Sample No.	SPT Values (blw/6 in)	Qu (tsf)	Moisture Content (%)
	487.4	--DIFFICULT DRILLING-- --WEATHERED BEDROCK--															
	485.4	--AUGER REFUSAL-- Boring terminated at 104.00 ft	105														
			110														
			115														
			120														
			125														

GENERAL NOTES

Begin Drilling **03-20-2014** Complete Drilling **03-20-2014**
 Drilling Contractor **Wang Testing Services** Drill Rig **CME-55 TMR**
 Driller **R&N** Logger **F. Bozga** Checked by **C. Marin**
 Drilling Method **2.25" SSA to 12.5', mud rotary thereafter, boring**
 **backfilled upon completion**

WATER LEVEL DATA

While Drilling ▽ **NA**
 At Completion of Drilling ▼ **NA**
 Time After Drilling **NA**
 Depth to Water ▼ **NA**

The stratification lines represent the approximate boundary between soil types; the actual transition may be gradual.



BORING LOG 0461-B-03

wangeng@wangeng.com
 1145 N Main Street
 Lombard, IL 60148
 Telephone: 630 953-9928
 Fax: 630 953-9938

WEI Job No.: 1100-04-01

Client **AECOM**
 Project **Circle Interchange Reconstruction**
 Location **Section 17, T39N, R14E of 3rd PM**

Datum: NAVD 88
 Elevation: 592.02 ft
 North: 1898094.57 ft
 East: 1172338.82 ft
 Station: 1207+43.60
 Offset: 28.6318 RT

Profile	Elevation (ft)	SOIL AND ROCK DESCRIPTION	Depth (ft)	Sample Type recovery	Sample No.	SPT Values (blw/6 in)	Qu (tsf)	Moisture Content (%)	Profile	Elevation (ft)	SOIL AND ROCK DESCRIPTION	Depth (ft)	Sample Type recovery	Sample No.	SPT Values (blw/6 in)	Qu (tsf)	Moisture Content (%)
	591.2	10-inch thick CONCRETE --PAVEMENT--															
		Medium dense, brown GRAVELLY SAND --FILL--			1	12 12 6	NP	25						11	1 2 1	< 0.08 B	28
			5		2	4 10 10	NP	11				30		12	0 1 2	< 0.25 P	27
					3	12 13 14	NP	15									
	584.0	Medium dense, brown and gray SAND to SANDY LOAM --WET-- --FILL--10			4	10 4 6	NP	29						13	1 1 1	< 0.08 B	27
	581.5	Brown GRAVELLY SAND --FILL--			5	1 2 2	1.23 B	23									
	580.5	Stiff, gray SILTY CLAY, trace gravel			6	6 4 2	< 0.25 P	15						14	0 0 0	0.16 B	27
	579.0	Gray SAND			7	0 1 1	0.74 B	23									
	577.7	Very soft to medium stiff, gray CLAY to SILTY CLAY, trace gravel	15		8	0 0 0	0.41 B	25						15	0 0 0	0.08 B	27
					9	0 1 1	0.49 B	29		545.3	Stiff, gray SILTY CLAY, trace gravel						
					10	0 1 2	0.74 B	23						16	0 2 4	1.00 N/6	
			25														

GENERAL NOTES

Begin Drilling **03-23-2014** Complete Drilling **03-23-2014**
 Drilling Contractor **Wang Testing Services** Drill Rig **CME-55 TMR**
 Driller **R&N** Logger **M de los Reyes** Checked by **C. Marin**
 Drilling Method **2.25" SSA to 12.5', mud rotary thereafter, boring**
backfilled upon completion

WATER LEVEL DATA

While Drilling ∇ **NA**
 At Completion of Drilling ∇ **NA**
 Time After Drilling **NA**
 Depth to Water ∇ **NA**

The stratification lines represent the approximate boundary between soil types; the actual transition may be gradual.

WANGENGINC 11000401.GPJ WANGENG.GDT 9/26/14



BORING LOG 0461-B-03

wangeng@wangeng.com
 1145 N Main Street
 Lombard, IL 60148
 Telephone: 630 953-9928
 Fax: 630 953-9938

WEI Job No.: 1100-04-01

Client **AECOM**
 Project **Circle Interchange Reconstruction**
 Location **Section 17, T39N, R14E of 3rd PM**

Datum: NAVD 88
 Elevation: 592.02 ft
 North: 1898094.57 ft
 East: 1172338.82 ft
 Station: 1207+43.60
 Offset: 28.6318 RT

Profile	Elevation (ft)	SOIL AND ROCK DESCRIPTION	Depth (ft)	Sample Type recovery	Sample No.	SPT Values (blw/6 in)	Qu (tsf)	Moisture Content (%)	Profile	Elevation (ft)	SOIL AND ROCK DESCRIPTION	Depth (ft)	Sample Type recovery	Sample No.	SPT Values (blw/6 in)	Qu (tsf)	Moisture Content (%)
	530.3	Very stiff to hard, gray SILTY CLAY LOAM to SILTY LOAM, trace gravel	55	X	17	4 5 7	1.64 B	21				80	X	22	11 18 24	9.02 S	13
			60	X	18	5 7 12	1.23 B	15				85	X	23	60/5	8.33 N/6	11
			65	X	19	6 10 15	4.10 B	17				90	X	24	20 28 29	4.92 S	23
			70	X	20	12 15 30	8.61 S	14				95					
			75	X	21	13 17 32	3.69 S	13				100					
										502.0	--HARD DRILLING-- --Possible Cobbles--						
										501.0	--WEATHERED BEDROCK-- --AUGER REFUSAL--						
											Boring terminated at 91.00 ft						

GENERAL NOTES

Begin Drilling **03-23-2014** Complete Drilling **03-23-2014**
 Drilling Contractor **Wang Testing Services** Drill Rig **CME-55 TMR**
 Driller **R&N** Logger **M de los Reyes** Checked by **C. Marin**
 Drilling Method **2.25" SSA to 12.5', mud rotary thereafter, boring backfilled upon completion**

WATER LEVEL DATA

While Drilling ∇ **NA**
 At Completion of Drilling ∇ **NA**
 Time After Drilling **NA**
 Depth to Water ∇ **NA**

The stratification lines represent the approximate boundary between soil types; the actual transition may be gradual.



BORING LOG 0461-B-04

wangeng@wangeng.com
 1145 N Main Street
 Lombard, IL 60148
 Telephone: 630 953-9928
 Fax: 630 953-9938

WEI Job No.: 1100-04-01

Client: **AECOM**
 Project: **Circle Interchange Reconstruction**
 Location: **Section 17, T39N, R14E of 3rd PM**

Datum: NAVD 88
 Elevation: 592.89 ft
 North: 1898096.29 ft
 East: 1172513.70 ft
 Station: 1205+67.07
 Offset: 29.6569 RT

Profile	Elevation (ft)	SOIL AND ROCK DESCRIPTION	Depth (ft)	Sample Type recovery	Sample No.	SPT Values (blw/6 in)	Qu (tsf)	Moisture Content (%)	Profile	Elevation (ft)	SOIL AND ROCK DESCRIPTION	Depth (ft)	Sample Type recovery	Sample No.	SPT Values (blw/6 in)	Qu (tsf)	Moisture Content (%)
	592.1	10-inch thick CONCRETE															
	591.9	--PAVEMENT--															
		Black SAND and GRAVEL, some asphalt tar															
		--BASE COURSE--															
		Very loose to dense, black and brown LOAM to fine SAND, trace glass and cinders															
		--FILL--															
			1		1	15 19 13	NP	19						11	0 1 2	0.25 B	27
			2		2	5 7 7	NP	13						12	1 2 1	0.16 B	26
			3		3	2 1 2	NP	21									
	583.4		4		4	2 3 2	NP	17						13	1 2 1	0.41 B	25
	582.4	Stiff (1.56B), brown and gray SILTY CLAY LOAM, trace gravel	10														
		Very soft to soft, gray CLAY to SILTY CLAY, trace gravel															
			5		5	1 0 0	0.25 B	27									
			6		6	0 0 0	0.33 B	27						14	2 1 1	0.49 B	25
			7		7	0 0 0	0.25 B	28									
			8		8	0 0 0	0.16 B	20						15	2 1 2	0.25 B	26
			9		9	0 0 0	0.16 B	26									
			10		10	0 0 2	0.16 B	31						16	3 5 9	1.56 B	22
										546.1	Stiff to hard, gray SILTY CLAY, trace gravel						

GENERAL NOTES

Begin Drilling **03-18-2014** Complete Drilling **03-20-2014**
 Drilling Contractor **Wang Testing Services** Drill Rig **B-57 TMR**
 Driller **P&P** Logger **D. Kolpacki** Checked by **C. Marin**
 Drilling Method **3.25" HSA to 10', mud rotary thereafter, boring**
backfilled upon completion

WATER LEVEL DATA

While Drilling ∇ **6.00 ft**
 At Completion of Drilling ∇ **NA**
 Time After Drilling **48 hours**
 Depth to Water ∇ **72.00 ft**

The stratification lines represent the approximate boundary between soil types; the actual transition may be gradual.

WANGENGINC 11000401.GPJ WANGENG.GDT 9/26/14



BORING LOG 0461-B-04

wangeng@wangeng.com
 1145 N Main Street
 Lombard, IL 60148
 Telephone: 630 953-9928
 Fax: 630 953-9938

WEI Job No.: 1100-04-01

Client: **AECOM**
 Project: **Circle Interchange Reconstruction**
 Location: **Section 17, T39N, R14E of 3rd PM**

Datum: NAVD 88
 Elevation: 592.89 ft
 North: 1898096.29 ft
 East: 1172513.70 ft
 Station: 1205+67.07
 Offset: 29.6569 RT

Profile	Elevation (ft)	SOIL AND ROCK DESCRIPTION	Depth (ft)	Sample Type recovery	Sample No.	SPT Values (blw/6 in)	Qu (tsf)	Moisture Content (%)	Profile	Elevation (ft)	SOIL AND ROCK DESCRIPTION	Depth (ft)	Sample Type recovery	Sample No.	SPT Values (blw/6 in)	Qu (tsf)	Moisture Content (%)
	516.1									516.1	Hard, gray SILTY CLAY LOAM to SILTY LOAM, trace gravel						
			55	X	17	5 9 9	5.00 B	15				80	X	22	11 18 22	4.92 S	12
			60	X	18	6 12 17	3.53 B	21				85	X	23	10 18 19	8.61 S	14
	531.1	Hard, gray SILTY CLAY LOAM to SILTY LOAM, trace gravel															
			65	X	19	12 14 15	8.20 S	12			--L _L (%)=NP, P _L (%)=NP-- --%Gravel=4.7-- --%Sand=18.7--90 --%Silt=70.1-- --%Clay=6.5-- --A-4 (0)--		X	24	17 28 44	NP	20
			70	X	20	14 11 19	8.77 S	13			Very dense, gray GRAVELLY SAND						
			75	X	21	13 25 50	NP	20			--WET--	95	X	25	50/5	NP	16
	521.1	Very dense, gray SAND, SILT and CLAY interbedded															
			75	X	21	13 25 50	NP	20				100	X	26	50/4	NP	10

GENERAL NOTES

Begin Drilling **03-18-2014** Complete Drilling **03-20-2014**
 Drilling Contractor **Wang Testing Services** Drill Rig **B-57 TMR**
 Driller **P&P** Logger **D. Kolpacki** Checked by **C. Marin**
 Drilling Method **3.25" HSA to 10', mud rotary thereafter, boring**
backfilled upon completion

WATER LEVEL DATA

While Drilling ∇ **6.00 ft**
 At Completion of Drilling ∇ **NA**
 Time After Drilling **48 hours**
 Depth to Water ∇ **72.00 ft**

The stratification lines represent the approximate boundary between soil types; the actual transition may be gradual.

WANGENGINC 11000401.GPJ WANGENG.GDT 9/26/14



wangeng@wangeng.com
 1145 N Main Street
 Lombard, IL 60148
 Telephone: 630 953-9928
 Fax: 630 953-9938

BORING LOG 0461-B-04

WEI Job No.: 1100-04-01

Client: **AECOM**
 Project: **Circle Interchange Reconstruction**
 Location: **Section 17, T39N, R14E of 3rd PM**

Datum: NAVD 88
 Elevation: 592.89 ft
 North: 1898096.29 ft
 East: 1172513.70 ft
 Station: 1205+67.07
 Offset: 29.6569 RT

Profile	Elevation (ft)	SOIL AND ROCK DESCRIPTION	Depth (ft)	Sample Type recovery	Sample No.	SPT Values (blw/6 in)	Qu (tsf)	Moisture Content (%)	Profile	Elevation (ft)	SOIL AND ROCK DESCRIPTION	Depth (ft)	Sample Type recovery	Sample No.	SPT Values (blw/6 in)	Qu (tsf)	Moisture Content (%)
	489.4	--WEATHERED BEDROCK--															
	488.4	Strong, light gray, fair rock mass 105 quality, bedded fresh DOLOSTONE, up to 3.5-foot beds, 7-inch joints spacing, horizontal joints with none to more than 0.2-inch greenish gray argillaceous infilling, hard joint wall, with stylolitic surfaces, and moderately vuggy porosity			1												
		--Run 1 - RECOVERY=100%-- --RQD=65%--															
	479.4	Boring terminated at 113.50 ft															
			115														
			120														
			125														

GENERAL NOTES

Begin Drilling **03-18-2014** Complete Drilling **03-20-2014**
 Drilling Contractor **Wang Testing Services** Drill Rig **B-57 TMR**
 Driller **P&P** Logger **D. Kolpacki** Checked by **C. Marin**
 Drilling Method **3.25" HSA to 10', mud rotary thereafter, boring backfilled upon completion**

WATER LEVEL DATA

While Drilling ∇ **6.00 ft**
 At Completion of Drilling ∇ **NA**
 Time After Drilling **48 hours**
 Depth to Water ∇ **72.00 ft**

The stratification lines represent the approximate boundary between soil types; the actual transition may be gradual.



BORING LOG 0461-B-05

wangeng@wangeng.com
 1145 N Main Street
 Lombard, IL 60148
 Telephone: 630 953-9928
 Fax: 630 953-9938

WEI Job No.: 1100-04-01

Client **AECOM**
 Project **Circle Interchange Reconstruction**
 Location **Section 17, T39N, R14E of 3rd PM**

Datum: NAVD 88
 Elevation: 593.15 ft
 North: 1898099.49 ft
 East: 1172659.59 ft
 Station: 1204+21.15
 Offset: 29.1659 RT

Profile	Elevation (ft)	SOIL AND ROCK DESCRIPTION	Depth (ft)	Sample Type recovery	Sample No.	SPT Values (blw/6 in)	Qu (tsf)	Moisture Content (%)	Profile	Elevation (ft)	SOIL AND ROCK DESCRIPTION	Depth (ft)	Sample Type recovery	Sample No.	SPT Values (blw/6 in)	Qu (tsf)	Moisture Content (%)
	592.5	8-inch thick CONCRETE --PAVEMENT--															
	591.5	12-inch thick CRUSHED STONE --BASE COURSE--			1	3 11 30	NP	9						11	1 2 2	0.49 B	25
		Medium dense, brown and gray SAND to SANDY LOAM, trace cinders and construction debris --FILL--	5		2	7 9 6	NP	10				30		12	1 1 2	0.33 B	24
					3	2 2 50/4	NP	8									
			10		4	3 3 13	NP					35		13	1 1 2	0.33 B	24
		--Black, strong odor--			5	2 2 3	NP	22									
	580.1	Very soft to medium stiff, gray CLAY to SILTY CLAY, trace gravel	15		6	1 3 3	0.41 B	22				40		14	0 1 2	0.33 B	24
					7	0 0 1	0.17 N/6										
			20		8	1 1 2	0.16 B	28				45		15	1 2 2	0.33 B	25
					9	0 0 0	0.16 B	26									
			25		10	1 1 2	0.33 B	35				50		16	2 3 3	0.74 B	24

GENERAL NOTES

Begin Drilling **03-19-2014** Complete Drilling **03-19-2014**
 Drilling Contractor **Wang Testing Services** Drill Rig **CME-55 TMR**
 Driller **R&N** Logger **F. Bozga** Checked by **C. Marin**
 Drilling Method **2.25" SSA to 12.5', mud rotary thereafter, boring backfilled upon completion**

WATER LEVEL DATA

While Drilling ∇ **10.50 ft**
 At Completion of Drilling ∇ **NA**
 Time After Drilling **NA**
 Depth to Water ∇ **NA**

The stratification lines represent the approximate boundary between soil types; the actual transition may be gradual.

WANGENGINC 11000401.GPJ WANGENG.GDT 9/26/14



BORING LOG 0461-B-05

wangeng@wangeng.com
 1145 N Main Street
 Lombard, IL 60148
 Telephone: 630 953-9928
 Fax: 630 953-9938

WEI Job No.: 1100-04-01

Client: **AECOM**
 Project: **Circle Interchange Reconstruction**
 Location: **Section 17, T39N, R14E of 3rd PM**

Datum: NAVD 88
 Elevation: 593.15 ft
 North: 1898099.49 ft
 East: 1172659.59 ft
 Station: 1204+21.15
 Offset: 29.1659 RT

Profile	Elevation (ft)	SOIL AND ROCK DESCRIPTION	Depth (ft)	Sample Type recovery	Sample No.	SPT Values (blw/6 in)	Qu (tsf)	Moisture Content (%)	Profile	Elevation (ft)	SOIL AND ROCK DESCRIPTION	Depth (ft)	Sample Type recovery	Sample No.	SPT Values (blw/6 in)	Qu (tsf)	Moisture Content (%)
										516.4	Hard, gray SILTY CLAY LOAM to SILTY LOAM, trace gravel						
			55		17	2 4 4	0.90 B	19				80		22	14 25 30	4.51 S	12
	536.4	Very stiff to hard, gray SILTY CLAY, trace gravel															
			60		18	5 10 14	3.53 B	21				85		23	19 27 39	5.08 S	13
			65		19	7 12 20	5.33 N/6					90		24	15 25 29	NP	18
										501.4	Very dense, gray GRAVELLY SANDY LOAM						
		--L _L (%)=24, P _L (%)=14-- --%Gravel=5.3-- --%Sand=23.4--70 --%Silt=56.4-- --%Clay=14.9-- --A-4 (4)--			20	11 17 20	6.64 B	13				95		25	43 50 2	NP	12
	519.1	Very dense, gray SILT			21	14 26 30	5.49 B	17				100		26	80 6	NP	11
			75							493.1	--Possible Cobbles--						

WANGENGINC 11000401.GPJ WANGENG.GDT 9/26/14

GENERAL NOTES

WATER LEVEL DATA

Begin Drilling: **03-19-2014** Complete Drilling: **03-19-2014**
 Drilling Contractor: **Wang Testing Services** Drill Rig: **CME-55 TMR**
 Driller: **R&N** Logger: **F. Bozga** Checked by: **C. Marin**
 Drilling Method: **2.25" SSA to 12.5', mud rotary thereafter, boring**
backfilled upon completion

While Drilling: ▽ **10.50 ft**
 At Completion of Drilling: ▽ **NA**
 Time After Drilling: **NA**
 Depth to Water: ▽ **NA**
 The stratification lines represent the approximate boundary between soil types; the actual transition may be gradual.



BORING LOG 0461-B-05

wangeng@wangeng.com
 1145 N Main Street
 Lombard, IL 60148
 Telephone: 630 953-9928
 Fax: 630 953-9938

WEI Job No.: 1100-04-01

Client **AECOM**
 Project **Circle Interchange Reconstruction**
 Location **Section 17, T39N, R14E of 3rd PM**

Datum: NAVD 88
 Elevation: 593.15 ft
 North: 1898099.49 ft
 East: 1172659.59 ft
 Station: 1204+21.15
 Offset: 29.1659 RT

Profile	Elevation (ft)	SOIL AND ROCK DESCRIPTION	Depth (ft)	Sample Type recovery	Sample No.	SPT Values (blw/6 in)	Qu (tsf)	Moisture Content (%)	Profile	Elevation (ft)	SOIL AND ROCK DESCRIPTION	Depth (ft)	Sample Type recovery	Sample No.	SPT Values (blw/6 in)	Qu (tsf)	Moisture Content (%)
	491.1	--DIFFICULT DRILLING-- --WEATHERED BEDROCK-- --AUGER REFUSAL-- Boring terminated at 102.00 ft	105														
			110														
			115														
			120														
			125														

GENERAL NOTES

Begin Drilling **03-19-2014** Complete Drilling **03-19-2014**
 Drilling Contractor **Wang Testing Services** Drill Rig **CME-55 TMR**
 Driller **R&N** Logger **F. Bozga** Checked by **C. Marin**
 Drilling Method **2.25" SSA to 12.5', mud rotary thereafter, boring backfilled upon completion**

WATER LEVEL DATA

While Drilling ∇ **10.50 ft**
 At Completion of Drilling \blacktriangledown **NA**
 Time After Drilling **NA**
 Depth to Water ∇ **NA**

The stratification lines represent the approximate boundary between soil types; the actual transition may be gradual.



BORING LOG 0461-B-06

wangeng@wangeng.com
 1145 N Main Street
 Lombard, IL 60148
 Telephone: 630 953-9928
 Fax: 630 953-9938

WEI Job No.: 1100-04-01

Client **AECOM**
 Project **Circle Interchange Reconstruction**
 Location **Section 17, T39N, R14E of 3rd PM**

Datum: NAVD 88
 Elevation: 592.58 ft
 North: 1898094.96 ft
 East: 1172855.95 ft
 Station: 1202+24.67
 Offset: 11.3524 RT

Profile	Elevation (ft)	SOIL AND ROCK DESCRIPTION	Depth (ft)	Sample Type recovery	Sample No.	SPT Values (blw/6 in)	Qu (tsf)	Moisture Content (%)	Profile	Elevation (ft)	SOIL AND ROCK DESCRIPTION	Depth (ft)	Sample Type recovery	Sample No.	SPT Values (blw/6 in)	Qu (tsf)	Moisture Content (%)
	591.8	10-inch thick CONCRETE --PAVEMENT--															
	590.8	12-inch thick CRUSHED STONE --BASE COURSE--															
		Very loose to medium dense, brown SAND and cinders, trace gravel			1	4 5 3	NP	20						11	0 1 2	0.25 B	21
			5		2	1 1 1	NP	15				30		12	0 0 0	0.25 B	25
					3	0 0 0	NP	21									
			10		4	2 8 2	NP	23				35		13	1 1 0	0.17 N/6	
	582.1	Very soft to medium stiff, gray CLAY to SILTY CLAY, trace gravel			5	1 2 2	0.90 B	22									
			15		6	1 2 2	0.41 B	30				40		14	1 1 2	0.16 B	26
					7	0 1 1	0.25 B	25									
			20		8	0 0 0	0.25 B	26				45		15	1 2 3	0.33 B	27
					9	0 1 1	0.16 B	28									
			25		10	0 1 1	0.16 B	28				50		16	1 3 3	0.57 B	27

GENERAL NOTES

Begin Drilling **03-25-2014** Complete Drilling **03-25-2014**
 Drilling Contractor **Wang Testing Services** Drill Rig **B-57 TMR**
 Driller **P&P** Logger **D. Kolpacki** Checked by **C. Marin**
 Drilling Method **3.25" HSA to 10', mud rotary thereafter, boring**
backfilled upon completion

WATER LEVEL DATA

While Drilling **3.00 ft**
 At Completion of Drilling **87.00 ft**
 Time After Drilling **NA**
 Depth to Water **NA**

The stratification lines represent the approximate boundary between soil types; the actual transition may be gradual.

WANGENGINC 11000401.GPJ WANGENG.GDT 9/26/14



BORING LOG 0461-B-06

wangeng@wangeng.com
 1145 N Main Street
 Lombard, IL 60148
 Telephone: 630 953-9928
 Fax: 630 953-9938

WEI Job No.: 1100-04-01

Client **AECOM**
 Project **Circle Interchange Reconstruction**
 Location **Section 17, T39N, R14E of 3rd PM**

Datum: NAVD 88
 Elevation: 592.58 ft
 North: 1898094.96 ft
 East: 1172855.95 ft
 Station: 1202+24.67
 Offset: 11.3524 RT

Profile	Elevation (ft)	SOIL AND ROCK DESCRIPTION	Depth (ft)	Sample Type recovery	Sample No.	SPT Values (blw/6 in)	Qu (tsf)	Moisture Content (%)	Profile	Elevation (ft)	SOIL AND ROCK DESCRIPTION	Depth (ft)	Sample Type recovery	Sample No.	SPT Values (blw/6 in)	Qu (tsf)	Moisture Content (%)
	540.8	Stiff to hard, gray SILTY CLAY to SILTY CLAY LOAM, trace to little gravel								515.8	Hard, gray SILTY CLAY LOAM, trace gravel						
	55		17	4 5 6	1.83 N/6				80	22		11 17 25	7.38 S	14			
	60		18	5 6 7	2.17 N/6				85	23		11 18 25	7.63 B	14			
	65		19	13 19 21	8.36 S	13			90	24		22 29 50/5	NP	21			
	525.8	Medium stiff to stiff, gray CLAY, trace gravel								505.8	Very dense, gray SILTY LOAM, trace to little gravel --WET--						
	70		20	6 7 10	1.64 B	25			95	25		50/4	NP	12			
	75		21	4 5 6	0.66 B	27											
										495.1	--AUGER REFUSAL-- Boring terminated at 97.50 ft						

GENERAL NOTES

Begin Drilling **03-25-2014** Complete Drilling **03-25-2014**
 Drilling Contractor **Wang Testing Services** Drill Rig **B-57 TMR**
 Driller **P&P** Logger **D. Kolpacki** Checked by **C. Marin**
 Drilling Method **3.25" HSA to 10', mud rotary thereafter, boring backfilled upon completion**

WATER LEVEL DATA

While Drilling ∇ **3.00 ft**
 At Completion of Drilling ∇ **87.00 ft**
 Time After Drilling **NA**
 Depth to Water ∇ **NA**

The stratification lines represent the approximate boundary between soil types; the actual transition may be gradual.

WANGENGINC 11000401.GPJ WANGENG.GDT 9/26/14



wangeng@wangeng.com
 1145 N Main Street
 Lombard, IL 60148
 Telephone: 630 953-9928
 Fax: 630 953-9938

BORING LOG 0461-B-07

WEI Job No.: 1100-04-01

Client: **AECOM**
 Project: **Circle Interchange Reconstruction**
 Location: **Section 17, T39N, R14E of 3rd PM**

Datum: NAVD 88
 Elevation: 598.46 ft
 North: 1898107.61 ft
 East: 1172998.12 ft
 Station: 5202+57.62
 Offset: 72.7190 RT

Profile	Elevation (ft)	SOIL AND ROCK DESCRIPTION	Depth (ft)	Sample Type recovery	Sample No.	SPT Values (blw/6 in)	Qu (tsf)	Moisture Content (%)	Profile	Elevation (ft)	SOIL AND ROCK DESCRIPTION	Depth (ft)	Sample Type recovery	Sample No.	SPT Values (blw/6 in)	Qu (tsf)	Moisture Content (%)
	597.7	9.5-inch thick CONCRETE --PAVEMENT--															
	597.4	3-inch thick CRUSHED STONE --BASE COURSE--			1	5 6 8	NP	11			--In-Situ Vane Shear, 26.5 feet-- -- $S_{u\ undis}$ = 827.2 psf-- -- $S_{u\ remold}$ = 465.3 psf-- --Sensitivity = 1.78--			2			
		Loose to medium dense, brown, fine SAND, trace gravel and slag --FILL--	5		2	3 3 3	NP	8				30		10	0 1 1	< 0.25 P	32
					3	3 2 2	NP	12									
	590.5	Loose, gray and black SILTY LOAM, trace slag --FILL--	10		4	2 2 2	NP	57			--In-Situ Vane Shear, 34 feet-- -- $S_{u\ undis}$ = 1085.7 psf-- -- $S_{u\ remold}$ = 465.3 psf-- --Sensitivity = 2.33--			3			
					5	1 2 2	NP	47									
	584.5	Loose, brown SANDY LOAM --FILL--	15		6	4 2 3	NP	22				40		11	0 1 2	< 0.25 P	30
	583.0	Stiff, brown and gray SILTY CLAY LOAM, trace gravel			7	2 2 4	1.89 B	23									
	580.5	Very soft to medium stiff, gray CLAY to SILTY CLAY, trace gravel	20		8	1 1 2	0.41 B	25			--In-Situ Vane Shear, 44 feet-- -- $S_{u\ undis}$ = 1292.5 psf-- -- $S_{u\ remold}$ = 620.4 psf-- --Sensitivity = 2.08--			4			
		--In-Situ Vane Shear, 21.5 feet-- -- $S_{u\ undis}$ = 672.1 psf-- -- $S_{u\ remold}$ = 517.0 psf-- --Sensitivity = 1.30--			1						-- L_L (%)=35, P_L (%)=17-- --%Gravel=5.0-- --%Sand=16.1-- --%Silt=45.7-- --%Clay=33.1-- --A-6 (13)--						
			25		9	0 0 3	0.16 B	32				50		12	1 2 3	0.33 B	26

GENERAL NOTES

Begin Drilling **10-23-2013** Complete Drilling **10-24-2013**
 Drilling Contractor **Wang Testing Services** Drill Rig **CME-55 TMR**
 Driller **R&J** Logger **A. Happel** Checked by **C. Marin**
 Drilling Method **2.25" HSA to 20', mud rotary thereafter, boring**
backfilled upon completion

WATER LEVEL DATA

While Drilling ∇ **NA**
 At Completion of Drilling ∇ **tbd**
 Time After Drilling **NA**
 Depth to Water ∇ **NA**

The stratification lines represent the approximate boundary between soil types; the actual transition may be gradual.



BORING LOG 0461-B-07

wangeng@wangeng.com
 1145 N Main Street
 Lombard, IL 60148
 Telephone: 630 953-9928
 Fax: 630 953-9938

WEI Job No.: 1100-04-01

Client **AECOM**
 Project **Circle Interchange Reconstruction**
 Location **Section 17, T39N, R14E of 3rd PM**

Datum: NAVD 88
 Elevation: 598.46 ft
 North: 1898107.61 ft
 East: 1172998.12 ft
 Station: 5202+57.62
 Offset: 72.7190 RT

Profile	Elevation (ft)	SOIL AND ROCK DESCRIPTION	Depth (ft)	Sample Type recovery	Sample No.	SPT Values (blw/6 in)	Qu (tsf)	Moisture Content (%)	Profile	Elevation (ft)	SOIL AND ROCK DESCRIPTION	Depth (ft)	Sample Type recovery	Sample No.	SPT Values (blw/6 in)	Qu (tsf)	Moisture Content (%)
			55	X	13	2 3 4	0.82 B	24				80	X	18	5 6 6	2.05 B	25
			60	X	14	3 4 5	0.49 B	24				85	X	19	7 7 7	2.00 P	17
	536.7	Very stiff, gray SILTY CLAY to SILTY CLAY LOAM, trace gravel								511.7	Medium dense, to very dense, gray SILTY LOAM						
			65	X	15	5 6 12	2.46 B	18				90	X	20	3 14 11	NP	25
			70	X	16	5 7 14	2.46 B	21				95	X	21	28 26 31	NP	18
			75	X	17	7 9 16	3.84 B	20				100	X	22	50/4	NP	16
										498.5							

--L_L(%)=36, P_L(%)=18--
 --%Gravel=1.6--
 --%Sand=9.9--
 --%Silt=50.8--
 --%Clay=37.7--
 --A-6 (16)--

--%Gravel=8.3--
 --%Sand=5.2--
 --%Silt=78.6--
 --%Clay=8.0--
 --A-4 (0)--

GENERAL NOTES

WATER LEVEL DATA

Begin Drilling **10-23-2013** Complete Drilling **10-24-2013**
 Drilling Contractor **Wang Testing Services** Drill Rig **CME-55 TMR**
 Driller **R&J** Logger **A. Happel** Checked by **C. Marin**
 Drilling Method **2.25" HSA to 20', mud rotary thereafter, boring**
backfilled upon completion

While Drilling ∇ **NA**
 At Completion of Drilling ∇ **tbd**
 Time After Drilling **NA**
 Depth to Water ∇ **NA**

The stratification lines represent the approximate boundary between soil types; the actual transition may be gradual.

WANGENGINC 11000401.GPJ WANGENG.GDT 9/26/14



wangeng@wangeng.com
 1145 N Main Street
 Lombard, IL 60148
 Telephone: 630 953-9928
 Fax: 630 953-9938

BORING LOG 0461-B-07

WEI Job No.: 1100-04-01

Client **AECOM**
 Project **Circle Interchange Reconstruction**
 Location **Section 17, T39N, R14E of 3rd PM**

Datum: NAVD 88
 Elevation: 598.46 ft
 North: 1898107.61 ft
 East: 1172998.12 ft
 Station: 5202+57.62
 Offset: 72.7190 RT

Profile	Elevation (ft)	SOIL AND ROCK DESCRIPTION	Depth (ft)	Sample Type recovery	Sample No.	SPT Values (blw/6 in)	Qu (tsf)	Moisture Content (%)	Profile	Elevation (ft)	SOIL AND ROCK DESCRIPTION	Depth (ft)	Sample Type recovery	Sample No.	SPT Values (blw/6 in)	Qu (tsf)	Moisture Content (%)
	488.5	Strong, light gray, excellent rock mass quality, bedded fresh DOLOSTONE, up to 5-foot beds, 17-inch joints spacing, horizontal and vertical joints with less than 0.2-inch infilling, hard joint wall, with stylolitic surfaces, and moderately vuggy porosity. --Run 1 - RECOVERY=100%-- --RQD=94%--	110		1	MPOC											
		Boring terminated at 100.00 ft															
			115														
			120														
			125														

GENERAL NOTES

Begin Drilling **10-23-2013** Complete Drilling **10-24-2013**
 Drilling Contractor **Wang Testing Services** Drill Rig **CME-55 TMR**
 Driller **R&J** Logger **A. Happel** Checked by **C. Marin**
 Drilling Method **2.25" HSA to 20', mud rotary thereafter, boring**
 **backfilled upon completion**

WATER LEVEL DATA

While Drilling ▽ **NA**
 At Completion of Drilling ▼ **tbd**
 Time After Drilling **NA**
 Depth to Water ▼ **NA**

The stratification lines represent the approximate boundary between soil types; the actual transition may be gradual.



wangeng@wangeng.com
 1145 N Main Street
 Lombard, IL 60148
 Telephone: 630 953-9928
 Fax: 630 953-9938

BORING LOG 0461-B-08A

WEI Job No.: 1100-04-01

Client **AECOM**
 Project **Circle Interchange Reconstruction**
 Location **Section 17, T39N, R14E of 3rd PM**

Datum: field
 Elevation: 604.50 ft
 North: 1898072.88 ft
 East: 1173175.26 ft
 Station:
 Offset:

Profile	Elevation (ft)	SOIL AND ROCK DESCRIPTION	Depth (ft)	Sample Type recovery	Sample No.	SPT Values (blw/6 in)	Qu (tsf)	Moisture Content (%)	Profile	Elevation (ft)	SOIL AND ROCK DESCRIPTION	Depth (ft)	Sample Type recovery	Sample No.	SPT Values (blw/6 in)	Qu (tsf)	Moisture Content (%)
	604.41	1-inch thick ASPHALT															
	603.5	--PAVEMENT-- 11-inch thick CONCRETE															
	601.5	--PAVEMENT-- Medium dense, brown GRAVELLY SANDY LOAM, some cinders			1	29 15 10	NP	13		576.5	Stiff to very stiff, gray SILTY CLAY, trace gravel			11	1 1 2	0.33 B	33
		--FILL-- Loose to medium dense, brown SANDY LOAM, trace to little gravel	5		2	7 4 3	NP	20				30		12	2 3 3	1.39 B	19
	596.5	--FILL-- Loose, dark brown SILTY LOAM			3	4 8 10	NP	12						13	3 9 10	2.54 B	23
	594.0	--Saturated-- Stiff to very stiff, brown and gray SILTY CLAY, trace gravel	10		4	2 2 4	NP	22		567.5	--AUGER REFUSAL-- --Obstruction at 37 feet-- --Boring relocated 40 feet west across the road-- Boring terminated at 37.00 ft	35					
	589.0	Soft, gray CLAY to SILTY CLAY, trace gravel	15		5	2 2 3	2.21 B	22									
			20		6	2 3 3	1.15 B	24									
			25		7	0 0 2	0.33 B	23									
					8	0 0 3	0.25 P	26									
					9	0 0 2	0.33 B	27									
					10	0 0 2	0.33 B	23									

GENERAL NOTES

Begin Drilling **02-24-2014** Complete Drilling **02-24-2014**
 Drilling Contractor **Wang Testing Services** Drill Rig **CME-55 TMR**
 Driller **R&K** Logger **D. Kolpacki** Checked by **CLM(-coord)**
 Drilling Method **2.25" HSA to 15', mud rotary thereafter, boring backfilled upon completion**

WATER LEVEL DATA

While Drilling ∇ **8.75 ft**
 At Completion of Drilling ∇ **NA**
 Time After Drilling **NA**
 Depth to Water ∇ **NA**

The stratification lines represent the approximate boundary between soil types; the actual transition may be gradual.



wangeng@wangeng.com
 1145 N Main Street
 Lombard, IL 60148
 Telephone: 630 953-9928
 Fax: 630 953-9938

BORING LOG 0461-B-08B

WEI Job No.: 1100-04-01

Client **AECOM**
 Project **Circle Interchange Reconstruction**
 Location **Section 17, T39N, R14E of 3rd PM**

Datum: NAVD 88
 Elevation: 592.61 ft
 North: 1898101.61 ft
 East: 1173154.73 ft
 Station: 5201+00.40
 Offset: 64.1086 RT

Profile	Elevation (ft)	SOIL AND ROCK DESCRIPTION	Depth (ft)	Sample Type recovery	Sample No.	SPT Values (blw/6 in)	Qu (tsf)	Moisture Content (%)	Profile	Elevation (ft)	SOIL AND ROCK DESCRIPTION	Depth (ft)	Sample Type recovery	Sample No.	SPT Values (blw/6 in)	Qu (tsf)	Moisture Content (%)
		Drilled without sampling to 37 feet	5									30					
			10									35					
										555.6	Very soft to medium stiff, gray CLAY to SILTY CLAY, trace gravel						
			15									40		14	0 1 1	0.16 B	26
			20									45		15	1 1 2	0.41 B	24
			25									50		16	2 2 3	0.83 N/6	

GENERAL NOTES

Begin Drilling **02-25-2014** Complete Drilling **02-25-2014**
 Drilling Contractor **Wang Testing Services** Drill Rig **CME-55 TMR**
 Driller **R&K** Logger **D. Kolpacki** Checked by **C. Marin**
 Drilling Method **2.25" HSA to 15', mud rotary thereafter, boring**
 **backfilled upon completion**

WATER LEVEL DATA

While Drilling **NA**
 At Completion of Drilling **77.00 ft**
 Time After Drilling **NA**
 Depth to Water **NA**

The stratification lines represent the approximate boundary between soil types; the actual transition may be gradual.



wangeng@wangeng.com
 1145 N Main Street
 Lombard, IL 60148
 Telephone: 630 953-9928
 Fax: 630 953-9938

BORING LOG 0461-B-08B

WEI Job No.: 1100-04-01

Client: **AECOM**
 Project: **Circle Interchange Reconstruction**
 Location: **Section 17, T39N, R14E of 3rd PM**

Datum: NAVD 88
 Elevation: 592.61 ft
 North: 1898101.61 ft
 East: 1173154.73 ft
 Station: 5201+00.40
 Offset: 64.1086 RT

Profile	Elevation (ft)	SOIL AND ROCK DESCRIPTION	Depth (ft)	Sample Type recovery	Sample No.	SPT Values (blw/6 in)	Qu (tsf)	Moisture Content (%)	Profile	Elevation (ft)	SOIL AND ROCK DESCRIPTION	Depth (ft)	Sample Type recovery	Sample No.	SPT Values (blw/6 in)	Qu (tsf)	Moisture Content (%)
	535.9	Very stiff to hard, gray SILTY CLAY, trace gravel	55	X	17	3 3 5	0.57 B	28		515.9	Medium dense to dense, gray, coarse SAND, trace to little gravel --SATURATED--	80	X	22	9 12 12	NP	15
	535.9		60	X	18	4 9 11	2.30 B	22		505.9	Very dense, gray SILTY LOAM --SATURATED--	85	X	23	18 17 23	NP	11
		--L _L (%)=34, P _L (%)=18-- --%Gravel=4.1-- --%Sand=11.7-- --%Silt=49.5-- --%Clay=34.7-- --A-6 (12)--	65	X	19	8 8 14	3.44 B	19				90	X	24	20 50/6	NP	21
			70	X	2	10 13 18	5.17 N/6	28		499.1	--DIFFICULT DRILLING-- --WEATHERED BEDROCK-- --AUGER REFUSAL--	95					
	520.9	Medium stiff, gray CLAY, trace gravel	75	X	21	6 7 9	0.98 B	26		498.1	Boring terminated at 94.50 ft						

GENERAL NOTES

Begin Drilling **02-25-2014** Complete Drilling **02-25-2014**
 Drilling Contractor **Wang Testing Services** Drill Rig **CME-55 TMR**
 Driller **R&K** Logger **D. Kolpacki** Checked by **C. Marin**
 Drilling Method **2.25" HSA to 15', mud rotary thereafter, boring backfilled upon completion**

WATER LEVEL DATA

While Drilling ∇ **NA**
 At Completion of Drilling ∇ **77.00 ft**
 Time After Drilling **NA**
 Depth to Water ∇ **NA**

The stratification lines represent the approximate boundary between soil types; the actual transition may be gradual.

WANGENGINC 11000401.GPJ WANGENG.GDT 9/26/14



BORING LOG 0461-B-09

wangeng@wangeng.com
 1145 N Main Street
 Lombard, IL 60148
 Telephone: 630 953-9928
 Fax: 630 953-9938

WEI Job No.: 1100-04-01

Client **AECOM**
 Project **Circle Interchange Reconstruction**
 Location **Section 17, T39N, R14E of 3rd PM**

Datum: NAVD 88
 Elevation: 592.95 ft
 North: 1897926.04 ft
 East: 1173161.53 ft
 Station: 5172+57.30
 Offset: 66.2870 RT

Profile	Elevation (ft)	SOIL AND ROCK DESCRIPTION	Depth (ft)	Sample Type recovery	Sample No.	SPT Values (blw/6 in)	Qu (tsf)	Moisture Content (%)	Profile	Elevation (ft)	SOIL AND ROCK DESCRIPTION	Depth (ft)	Sample Type recovery	Sample No.	SPT Values (blw/6 in)	Qu (tsf)	Moisture Content (%)
	592.2	9-inch thick CONCRETE --PAVEMENT--															
		Medium dense, brown SANDY LOAM, little gravel --FILL--			1	10 17 12	NP	8						11	0 1 1	0.08 B	34
	589.9	Medium dense to dense, brown GRAVELLY SAND, some brick fragments and construction debris --FILL--	5		2	3 12 19	NP	11				30		12	0 0 0	0.08 B	28
	584.9	Loose, brown, SILT and fine SAND --FILL--			3	3 6 11	NP	22									
	582.9	Medium stiff, brown CLAY LOAM, trace gravel --FILL--	10		4	5 4 3	NP	22				35		13	0 0 2	0.16 B	26
	579.9	Very soft to soft, gray CLAY to SILTY CLAY, trace gravel			5	1 2 2	0.82 B	27									
			15		6	0 0 1	0.16 B	24				40		14	0 1 2	0.16 B	26
					7	0 0 0	0.08 B	30									
			20		8	0 00 0	0.08 B	23				45		15	1 2 3	< 0.25 P	23
					9	0 0 0	0.08 B	32									
			25		10	0 0 0	0.16 B	34				50		16	0 1 3	0.49 B	26

GENERAL NOTES

Begin Drilling **10-30-2013** Complete Drilling **11-07-2013**
 Drilling Contractor **Wang Testing Services** Drill Rig **D-50 TMR**
 Driller **R&N** Logger **F. Bozga** Checked by *****
 Drilling Method **3.25" HSA to 10', mud rotary thereafter, boring**
backfilled upon completion

WATER LEVEL DATA

While Drilling **NA**
 At Completion of Drilling **31.50 ft**
 Time After Drilling **NA**
 Depth to Water **NA**

The stratification lines represent the approximate boundary between soil types; the actual transition may be gradual.

WANGENGINC 11000401.GPJ WANGENG.GDT 9/26/14



BORING LOG 0461-B-09

wangeng@wangeng.com
 1145 N Main Street
 Lombard, IL 60148
 Telephone: 630 953-9928
 Fax: 630 953-9938

WEI Job No.: 1100-04-01

Client: **AECOM**
 Project: **Circle Interchange Reconstruction**
 Location: **Section 17, T39N, R14E of 3rd PM**

Datum: NAVD 88
 Elevation: 592.95 ft
 North: 1897926.04 ft
 East: 1173161.53 ft
 Station: 5172+57.30
 Offset: 66.2870 RT

Profile	Elevation (ft)	SOIL AND ROCK DESCRIPTION	Depth (ft)	Sample Type recovery	Sample No.	SPT Values (blw/6 in)	Qu (tsf)	Moisture Content (%)	Profile	Elevation (ft)	SOIL AND ROCK DESCRIPTION	Depth (ft)	Sample Type recovery	Sample No.	SPT Values (blw/6 in)	Qu (tsf)	Moisture Content (%)
	541.2	Stiff to hard, gray SILTY CLAY LOAM, trace gravel	55	X	17	3 5 3	4.50 P	14		515.2	Loose, gray SILT with fine SAND interbeds	80	X	22	3 4 5	NP	22
			60	X	18	7 14 20	5.00 B	19		511.2	Medium dense, gray, medium SAND	85	X	23	14 11 13	NP	15
				X	19	8 15 22	7.30 B	14		506.9	Very dense, gray GRAVELLY SANDY LOAM --HARD DRILLING-- --Possible Cobbles--		X	24	400/6	NP	9
				X	20	7 10 16	1.97 B	18		503.9	--WEATHERED BEDROCK-- --HARD DRILLING--	90	X				
				X	21	10 20 20	NP	12		501.4	Strong, light gray and white, good rock mass quality, bedded fresh DOLOSTONE, up to 18-inch beds, 7-inch joints spacing, horizontal and oblique joints with less than 0.1-inch infilling, hard joint wall, with stylolitic surfaces, and slightly vuggy porosity. --Run 1 - RECOVERY=98%-- --RQD=78%--	95	X	1			
	521.2	Dense, gray SILTY LOAM	75	X									X				

--L_L(%)=24, P_L(%)=15--
 --%Gravel=3.4--
 --%Sand=19.3--65
 --%Silt=56.9--
 --%Clay=20.4--
 --A-4 (4)--

ROCK

GENERAL NOTES

WATER LEVEL DATA

Begin Drilling **10-30-2013** Complete Drilling **11-07-2013**
 Drilling Contractor **Wang Testing Services** Drill Rig **D-50 TMR**
 Driller **R&N** Logger **F. Bozga** Checked by *****
 Drilling Method **3.25" HSA to 10', mud rotary thereafter, boring**
backfilled upon completion

While Drilling ∇ **NA**
 At Completion of Drilling ∇ **31.50 ft**
 Time After Drilling **NA**
 Depth to Water ∇ **NA**

The stratification lines represent the approximate boundary between soil types; the actual transition may be gradual.

WANGENGINC 11000401.GPJ WANGENG.GDT 9/26/14



BORING LOG 0461-B-09

wangeng@wangeng.com
 1145 N Main Street
 Lombard, IL 60148
 Telephone: 630 953-9928
 Fax: 630 953-9938

WEI Job No.: 1100-04-01

Datum: NAVD 88
 Elevation: 592.95 ft
 North: 1897926.04 ft
 East: 1173161.53 ft
 Station: 5172+57.30
 Offset: 66.2870 RT

Client **AECOM**
 Project **Circle Interchange Reconstruction**
 Location **Section 17, T39N, R14E of 3rd PM**

Profile	Elevation (ft)	SOIL AND ROCK DESCRIPTION	Depth (ft)	Sample Type recovery	Sample No.	SPT Values (blw/6 in)	Qu (tsf)	Moisture Content (%)	Profile	Elevation (ft)	SOIL AND ROCK DESCRIPTION	Depth (ft)	Sample Type recovery	Sample No.	SPT Values (blw/6 in)	Qu (tsf)	Moisture Content (%)
	491.4	Boring terminated at 101.50 ft															
			105														
			110														
			115														
			120														
			125														

GENERAL NOTES

Begin Drilling **10-30-2013** Complete Drilling **11-07-2013**
 Drilling Contractor **Wang Testing Services** Drill Rig **D-50 TMR**
 Driller **R&N** Logger **F. Bozga** Checked by *
 Drilling Method **3.25" HSA to 10', mud rotary thereafter, boring**
 **backfilled upon completion**

WATER LEVEL DATA

While Drilling ▽ **NA**
 At Completion of Drilling ▼ **31.50 ft**
 Time After Drilling **NA**
 Depth to Water ▼ **NA**

The stratification lines represent the approximate boundary between soil types; the actual transition may be gradual.



BORING LOG 0461-B-10

wangeng@wangeng.com
 1145 N Main Street
 Lombard, IL 60148
 Telephone: 630 953-9928
 Fax: 630 953-9938

WEI Job No.: 1100-04-01

Client: **AECOM**
 Project: **Circle Interchange Reconstruction**
 Location: **Section 17, T39N, R14E of 3rd PM**

Datum: NAVD 88
 Elevation: 594.70 ft
 North: 1897918.58 ft
 East: 1172921.87 ft
 Station: 1715+66.42
 Offset: 14.5370 RT

Profile	Elevation (ft)	SOIL AND ROCK DESCRIPTION	Depth (ft)	Sample Type recovery	Sample No.	SPT Values (blw/6 in)	Qu (tsf)	Moisture Content (%)	Profile	Elevation (ft)	SOIL AND ROCK DESCRIPTION	Depth (ft)	Sample Type recovery	Sample No.	SPT Values (blw/6 in)	Qu (tsf)	Moisture Content (%)	
	593.9	10-inch thick CONCRETE --PAVEMENT--																
	592.9	12-inch thick CRUSHED STONE --BASE COURSE--			1	4 5 5	1.75 P	11						11	0 2 1	0.25 B	27	
	591.7	Stiff, brown and gray SILTY CLAY LOAM, trace gravel --FILL--			2	2 2 1	NP	19				30		12	1 1 1	0.16 B	26	
		Very loose, dark brown, coarse SAND, trace gravel and brock fragments --FILL--	5		3	2 1 2	NP	29						13	1 1 0	0.16 B	26	
	583.3	Stiff, brown and gray SILTY CLAY LOAM, trace gravel			5	3 1 2	1.64 B	24						14	1 1 1	0.25 B	27	
	579.2	Very soft to soft, gray CLAY to SILTY CLAY, trace gravel			6	2 2 3	1.15 B	25				40		15	1 1 2	0.16 B	26	
					7	2 2 2	0.25 B	20						16	1 2 3	0.41 B	26	
					8	0 1 0	0.33 B	29										
					9	0 0 0	0.25 B	29										
					10	0 0 0	0.16 B	31										

--L_L(%)=33, P_L(%)=16--
 --%Gravel=3.5--
 --%Sand=18.6--50

GENERAL NOTES

WATER LEVEL DATA

Begin Drilling **03-23-2014** Complete Drilling **03-24-2014**
 Drilling Contractor **Wang Testing Services** Drill Rig **B-57 TMR**
 Driller **P&P** Logger **D. Kolpacki** Checked by *****
 Drilling Method **3.25" HSA to 10', mud rotary thereafter, boring**
backfilled upon completion

While Drilling **10.50 ft**
 At Completion of Drilling **NA**
 Time After Drilling **24 hours**
 Depth to Water **82.00 ft**

The stratification lines represent the approximate boundary between soil types; the actual transition may be gradual.

WANGENGINC 11000401.GPJ WANGENG.GDT 9/26/14



BORING LOG 0461-B-10

wangeng@wangeng.com
 1145 N Main Street
 Lombard, IL 60148
 Telephone: 630 953-9928
 Fax: 630 953-9938

WEI Job No.: 1100-04-01

Client: **AECOM**
 Project: **Circle Interchange Reconstruction**
 Location: **Section 17, T39N, R14E of 3rd PM**

Datum: NAVD 88
 Elevation: 594.70 ft
 North: 1897918.58 ft
 East: 1172921.87 ft
 Station: 1715+66.42
 Offset: 14.5370 RT

Profile	Elevation (ft)	SOIL AND ROCK DESCRIPTION	Depth (ft)	Sample Type recovery	Sample No.	SPT Values (blw/6 in)	Qu (tsf)	Moisture Content (%)	Profile	Elevation (ft)	SOIL AND ROCK DESCRIPTION	Depth (ft)	Sample Type recovery	Sample No.	SPT Values (blw/6 in)	Qu (tsf)	Moisture Content (%)
		--%Silt=47.9-- --%Clay=30.0-- --A-6 (12)--															
	537.9	Very stiff to hard, gray SILTY CLAY, trace gravel	55	X	17	3 6 7	0.41 B	15		512.9	Loose, gray SILTY LOAM, trace gravel --Wet--	80	X	22	12 12 12	1.25 P	20
			60	X	18	5 7 10	2.79 B	21				85	X	23	2 3 5	NP	27
			65	X	19	7 7 10	2.25 P	15		507.9	Medium dense to very dense, gray GRAVELLY SAND --Wet--	90	X	24	9 11 12	NP	17
			70	X	20	13 16 19	4.50 P	16				95	X	25	5 0 3	NP	14
	522.9	Stiff, gray CLAY to SILTY CLAY, trace gravel	75	X	21	5 5 6	1.80 B	23		498.2	--VERY HARD DRILLING-- --WEATHERED BEDROCK--						
										496.2	--AUGER REFUSAL-- Boring terminated at 98.50 ft						

GENERAL NOTES

Begin Drilling **03-23-2014** Complete Drilling **03-24-2014**
 Drilling Contractor **Wang Testing Services** Drill Rig **B-57 TMR**
 Driller **P&P** Logger **D. Kolpacki** Checked by *****
 Drilling Method **3.25" HSA to 10', mud rotary thereafter, boring backfilled upon completion**

WATER LEVEL DATA

While Drilling **10.50 ft**
 At Completion of Drilling **NA**
 Time After Drilling **24 hours**
 Depth to Water **82.00 ft**

The stratification lines represent the approximate boundary between soil types; the actual transition may be gradual.

WANGENGINC 11000401.GPJ WANGENG.GDT 9/26/14



BORING LOG 0461-B-11

wangeng@wangeng.com
 1145 N Main Street
 Lombard, IL 60148
 Telephone: 630 953-9928
 Fax: 630 953-9938

WEI Job No.: 1100-04-01

Client **AECOM**
 Project **Circle Interchange Reconstruction**
 Location **Section 17, T39N, R14E of 3rd PM**

Datum: NAVD 88
 Elevation: 592.71 ft
 North: 1897908.17 ft
 East: 1172741.09 ft
 Station: 1713+87.02
 Offset: 25.1777 RT

Profile	Elevation (ft)	SOIL AND ROCK DESCRIPTION	Depth (ft)	Sample Type recovery	Sample No.	SPT Values (blw/6 in)	Qu (tsf)	Moisture Content (%)	Profile	Elevation (ft)	SOIL AND ROCK DESCRIPTION	Depth (ft)	Sample Type recovery	Sample No.	SPT Values (blw/6 in)	Qu (tsf)	Moisture Content (%)
	592.62	6.2-inch thick ASPHALT --PAVEMENT--															
		Medium dense to dense, brown SANDY GRAVEL, trace brick and cinders --FILL--			1	8 10 18	NP	15						11	1 1 2	0.16 B	24
			5		2	2 6 7	NP	16				30		12	1 1 2	0.16 B	25
					3	3 3 36	NP	16									
	583.5	Medium stiff to stiff, brown and gray SILTY CLAY LOAM, trace gravel and glass fragments --FILL--	10		4	2 2 2	NR					35		13	1 2 3	0.25 B	24
					5	2 2 3	1.07 B	28									
			15		6	5 2 3	0.90 B	27				40		14	1 2 2	0.25 B	25
	577.2	Very soft to medium stiff, gray CLAY to SILTY CLAY, trace gravel			7	1 2 2	0.49 B	26									
			20		8	1 1 2	0.41 B	27				45		15	1 2 3	0.41 B	24
					9	0 0 0	0.25 B	28									
			25		10	0 0 0	0.16 B	30				50		16	1 2 2	0.25 P	27

GENERAL NOTES

Begin Drilling **03-16-2014** Complete Drilling **03-17-2014**
 Drilling Contractor **Wang Testing Services** Drill Rig **B-57 TMR**
 Driller **P&P** Logger **D. Kolpacki** Checked by *****
 Drilling Method **3.25" HSA to 10', mud rotary thereafter, boring backfilled upon completion**

WATER LEVEL DATA

While Drilling **8.50 ft**
 At Completion of Drilling **72.00 ft**
 Time After Drilling **NA**
 Depth to Water **NA**

The stratification lines represent the approximate boundary between soil types; the actual transition may be gradual.

WANGENGINC 11000401.GPJ WANGENG.GDT 9/26/14



BORING LOG 0461-B-11

wangeng@wangeng.com
 1145 N Main Street
 Lombard, IL 60148
 Telephone: 630 953-9928
 Fax: 630 953-9938

WEI Job No.: 1100-04-01

Client **AECOM**
 Project **Circle Interchange Reconstruction**
 Location **Section 17, T39N, R14E of 3rd PM**

Datum: NAVD 88
 Elevation: 592.71 ft
 North: 1897908.17 ft
 East: 1172741.09 ft
 Station: 1713+87.02
 Offset: 25.1777 RT

Profile	Elevation (ft)	SOIL AND ROCK DESCRIPTION	Depth (ft)	Sample Type recovery	Sample No.	SPT Values (blw/6 in)	Qu (tsf)	Moisture Content (%)	Profile	Elevation (ft)	SOIL AND ROCK DESCRIPTION	Depth (ft)	Sample Type recovery	Sample No.	SPT Values (blw/6 in)	Qu (tsf)	Moisture Content (%)
	536.0	Stiff to hard, gray SILTY CLAY LOAM to SILTY LOAM, trace to little gravel	55	X	17	2 4 6	0.41 B	21		511.0	--%Silt=55.6-- --%Clay=31.1-- --A-6 (11)-- Medium dense, gray SILT, trace interbedded CLAY and SAND --WET--	80	X	22	10 12 9	3.50 N/6	13
			60	X	18	3 6 9	2.95 B	23				85	X	23	4 6 18	NP	28
			65	X	19	15 15 21	4.00 P	16		506.0	Very dense, gray GRAVELLY SAND --WET--	90	X	24	5 0 5	NP	10
			70	X	20	10 13 14	5.66 B	14		501.0	--HARD DRILLING-- --Possible Cobbles-- Very dense, DOLOSTONE fragments, some bluish gray SILTY LOAM joints infill --WEATHERED BEDROCK--	95	X	25	14 31 50/5	NP	17
										494.7	--AUGER REFUSAL-- Boring terminated at 98.00 ft	100					
		--L _L (%)=32, P _L (%)=18-- --%Gravel=2.5-- --%Sand=10.9--75		X	21	5 6 8	1.56 B	20									

GENERAL NOTES

Begin Drilling **03-16-2014** Complete Drilling **03-17-2014**
 Drilling Contractor **Wang Testing Services** Drill Rig **B-57 TMR**
 Driller **P&P** Logger **D. Kolpacki** Checked by *****
 Drilling Method **3.25" HSA to 10', mud rotary thereafter, boring backfilled upon completion**

WATER LEVEL DATA

While Drilling **8.50 ft**
 At Completion of Drilling **72.00 ft**
 Time After Drilling **NA**
 Depth to Water **NA**

The stratification lines represent the approximate boundary between soil types; the actual transition may be gradual.

WANGENGINC 11000401.GPJ WANGENG.GDT 9/26/14



BORING LOG 0461-B-12

wangeng@wangeng.com
 1145 N Main Street
 Lombard, IL 60148
 Telephone: 630 953-9928
 Fax: 630 953-9938

WEI Job No.: 1100-04-01

Client **AECOM**
 Project **Circle Interchange Reconstruction**
 Location **Section 17, T39N, R14E of 3rd PM**

Datum: NAVD 88
 Elevation: 593.46 ft
 North: 1897907.11 ft
 East: 1172641.44 ft
 Station: 1712+85.51
 Offset: 27.1941 RT

Profile	Elevation (ft)	SOIL AND ROCK DESCRIPTION	Depth (ft)	Sample Type recovery	Sample No.	SPT Values (blw/6 in)	Qu (tsf)	Moisture Content (%)	Profile	Elevation (ft)	SOIL AND ROCK DESCRIPTION	Depth (ft)	Sample Type recovery	Sample No.	SPT Values (blw/6 in)	Qu (tsf)	Moisture Content (%)
	593.32	2.5-inch thick ASPHALT															
	592.4	--PAVEMENT--															
		10.5-inch thick CONCRETE															
		--PAVEMENT--															
		Medium dense, brown GRAVELLY SAND, trace to some construction debris															
		--FILL--															
			5		1	23 13 29	NP	9						11	1 2 2	0.41 B	25
					2	15 10 9	NP	20						12	1 2 2	< 0.25 P	27
					3	4 7 9	NP	15									
					4	7 23 12	NP	25						13	1 2 2	0.49 B	26
	583.0	Very stiff, brown SILTY CLAY LOAM, trace gravel			5	3 5 7	2.21 B	22									
	580.5	Very soft to medium stiff, gray CLAY to SILTY CLAY, trace gravel			6	2 3 5	0.82 B	23						14	1 2 2	0.33 B	26
					7	1 1 2	0.57 B	22									
					8	1 2 2	0.41 B	23						15	1 2 2	0.41 B	25
					9	1 2 2	0.33 B	25									
		--L _L (%)=37, P _L (%)=17-- --%Gravel=1.3-- --%Sand=8.6--25			10	0 0 2	0.16 B	39						16	2 2 3	0.83 N/6	

GENERAL NOTES

WATER LEVEL DATA

Begin Drilling **03-17-2014** Complete Drilling **03-19-2014**
 Drilling Contractor **Wang Testing Services** Drill Rig **CME-55 TMR**
 Driller **R&N** Logger **F. Bozga** Checked by *****
 Drilling Method **2.25" SSA to 12.5', mud rotary thereafter, boring**
backfilled upon completion

While Drilling **DRY**
 At Completion of Drilling **NA**
 Time After Drilling **24 hours**
 Depth to Water **15.00 ft**

The stratification lines represent the approximate boundary between soil types; the actual transition may be gradual.

WANGENGINC 11000401.GPJ WANGENG.GDT 9/26/14



BORING LOG 0461-B-12

wangeng@wangeng.com
 1145 N Main Street
 Lombard, IL 60148
 Telephone: 630 953-9928
 Fax: 630 953-9938

WEI Job No.: 1100-04-01

Client: **AECOM**
 Project: **Circle Interchange Reconstruction**
 Location: **Section 17, T39N, R14E of 3rd PM**

Datum: NAVD 88
 Elevation: 593.46 ft
 North: 1897907.11 ft
 East: 1172641.44 ft
 Station: 1712+85.51
 Offset: 27.1941 RT

Profile	Elevation (ft)	SOIL AND ROCK DESCRIPTION	Depth (ft)	Sample Type recovery	Sample No.	SPT Values (blw/6 in)	Qu (tsf)	Moisture Content (%)	Profile	Elevation (ft)	SOIL AND ROCK DESCRIPTION	Depth (ft)	Sample Type recovery	Sample No.	SPT Values (blw/6 in)	Qu (tsf)	Moisture Content (%)
	536.7	Very stiff to hard, gray SILTY CLAY LOAM, trace gravel	55	X	17	1 2 3	0.82 B	27				80	X	22	3 3 4	0.82 B	23
				60	X	18	3 5 10	2.13 B	21			--L _L (%)=38, P _L (%)=19-- --%Gravel=0.6-- --%Sand=2.4--85 --%Silt=54.5-- --%Clay=42.5-- --A-6 (19)--	80	X	23	2 3 3	0.66 B
	506.7	Very dense, gray GRAVELLY SAND	65	X	19	3 11 15	3.61 B	15			--WET--	90	X	24	10 26 46	NP	11
				70	X	20	6 10 12	6.23 B	14				90	X	25	90/6	NP
	521.7	Medium stiff to stiff, gray CLAY to SILTY CLAY, trace gravel	75	X	21	4 5 7	1.31 B	27			--AUGER REFUSAL--						
												Boring terminated at 97.50 ft					
	496.0																

GENERAL NOTES

Begin Drilling **03-17-2014** Complete Drilling **03-19-2014**
 Drilling Contractor **Wang Testing Services** Drill Rig **CME-55 TMR**
 Driller **R&N** Logger **F. Bozga** Checked by *****
 Drilling Method **2.25" SSA to 12.5', mud rotary thereafter, boring backfilled upon completion**

WATER LEVEL DATA

While Drilling **DRY**
 At Completion of Drilling **NA**
 Time After Drilling **24 hours**
 Depth to Water **15.00 ft**

The stratification lines represent the approximate boundary between soil types; the actual transition may be gradual.

WANGENGINC 11000401.GPJ WANGENG.GDT 9/26/14



BORING LOG 0461-B-13

wangeng@wangeng.com
 1145 N Main Street
 Lombard, IL 60148
 Telephone: 630 953-9928
 Fax: 630 953-9938

WEI Job No.: 1100-04-01

Client **AECOM**
 Project **Circle Interchange Reconstruction**
 Location **Section 17, T39N, R14E of 3rd PM**

Datum: NAVD 88
 Elevation: 592.38 ft
 North: 1897901.39 ft
 East: 1172463.73 ft
 Station: 1711+07.72
 Offset: 28.4223 RT

Profile	Elevation (ft)	SOIL AND ROCK DESCRIPTION	Depth (ft)	Sample Type recovery	Sample No.	SPT Values (blw/6 in)	Qu (tsf)	Moisture Content (%)	Profile	Elevation (ft)	SOIL AND ROCK DESCRIPTION	Depth (ft)	Sample Type recovery	Sample No.	SPT Values (blw/6 in)	Qu (tsf)	Moisture Content (%)
	592.31	1.5-inch thick ASPHALT															
	591.4	--PAVEMENT--															
		11-inch thick CONCRETE			1	24	NP	9						11	0 1 1	0.25 B	26
		--PAVEMENT--															
	589.4	Very dense, gray SANDY LOAM															
		--FILL--															
		Medium dense to very dense, brown GRAVELLY SANDY LOAM	5		2	12 15 12	NP	17				30		12	0 0 2	0.16 B	27
		--FILL--															
					3	3 17 20	NP	10									
					4	5 50/3	NP	27				35		13	0 0 2	0.25 B	27
	581.9	Very soft to medium stiff, gray CLAY to SILTY CLAY, trace gravel			5	2 2 3	0.66 B	25									
					6	1 1 1	0.25 B	28						14	0 0 2	0.25 B	26
					7	0 0 1	0.16 B	32									
					8	0 0 2	0.25 B	30				45		15	0 2 2	0.25 B	26
					9	0 0 1	0.25 B	21									
					10	1 2 2	0.57 B	15				50		16	2 2 3	0.83 N/6	

--L_L(%)=34, P_L(%)=18--
 --%Gravel=2.5--
 --%Sand=15.8--40
 --%Silt=49.4--
 --%Clay=32.2--
 --A-6 (12)--

GENERAL NOTES

Begin Drilling **03-09-2014** Complete Drilling **03-09-2014**
 Drilling Contractor **Wang Testing Services** Drill Rig **CME-55 TMR**
 Driller **R&N** Logger **F. Bozga** Checked by *****
 Drilling Method **2.25" SSA to 12.5', mud rotary thereafter, boring**
backfilled upon completion

WATER LEVEL DATA

While Drilling **NA**
 At Completion of Drilling **NA**
 Time After Drilling **NA**
 Depth to Water **NA**

The stratification lines represent the approximate boundary between soil types; the actual transition may be gradual.

WANGENGINC 11000401.GPJ WANGENG.GDT 9/26/14



BORING LOG 0461-B-13

wangeng@wangeng.com
 1145 N Main Street
 Lombard, IL 60148
 Telephone: 630 953-9928
 Fax: 630 953-9938

WEI Job No.: 1100-04-01

Client **AECOM**
 Project **Circle Interchange Reconstruction**
 Location **Section 17, T39N, R14E of 3rd PM**

Datum: NAVD 88
 Elevation: 592.38 ft
 North: 1897901.39 ft
 East: 1172463.73 ft
 Station: 1711+07.72
 Offset: 28.4223 RT

Profile	Elevation (ft)	SOIL AND ROCK DESCRIPTION	Depth (ft)	Sample Type recovery	Sample No.	SPT Values (blw/6 in)	Qu (tsf)	Moisture Content (%)	Profile	Elevation (ft)	SOIL AND ROCK DESCRIPTION	Depth (ft)	Sample Type recovery	Sample No.	SPT Values (blw/6 in)	Qu (tsf)	Moisture Content (%)
	540.6	Very stiff to hard, gray SILTY CLAY to SILTY CLAY LOAM, trace gravel								515.6	Medium dense, gray SILTY LOAM --%Gravel=2.1-- --%Sand=12.4-- --%Silt=79.9--80 --%Clay=5.6-- --A-4 (0)--						
	55		X	17	4 7 11	3.20 B	16			510.6		Hard, gray SILTY CLAY LOAM, trace gravel					
	60		X	18	4 8 13	2.54 B	16			505.6	Very dense, gray SILT --%Gravel=0.8-- --%Sand=6.9-- --%Silt=83.6--90 --%Clay=8.7-- --A-4 (0)--						
	65		X	19	7 20 28	6.15 S	11			500.6		Very dense, gray SILTY LOAM, trace gravel --L _L (%)=34, P _L (%)=18-- --%Gravel=1.4-- --%Sand=11.3--70 --%Silt=50.6-- --%Clay=36.7-- --A-6 (13)--					
	70		X	20	10 10 10	3.61 B	19				--HARD DRILLING-- --Possible Cobbles<400						
	75	X	21	4 8 16	4.00 N/6	13			492.4								

GENERAL NOTES

Begin Drilling **03-09-2014** Complete Drilling **03-09-2014**
 Drilling Contractor **Wang Testing Services** Drill Rig **CME-55 TMR**
 Driller **R&N** Logger **F. Bozga** Checked by *****
 Drilling Method **2.25" SSA to 12.5', mud rotary thereafter, boring**
backfilled upon completion

WATER LEVEL DATA

While Drilling **NA**
 At Completion of Drilling **NA**
 Time After Drilling **NA**
 Depth to Water **NA**

The stratification lines represent the approximate boundary between soil types; the actual transition may be gradual.

WANGENGINC 11000401.GPJ WANGENG.GDT 9/26/14



wangeng@wangeng.com
 1145 N Main Street
 Lombard, IL 60148
 Telephone: 630 953-9928
 Fax: 630 953-9938

BORING LOG 0461-B-13

WEI Job No.: 1100-04-01

Client **AECOM**
 Project **Circle Interchange Reconstruction**
 Location **Section 17, T39N, R14E of 3rd PM**

Datum: NAVD 88
 Elevation: 592.38 ft
 North: 1897901.39 ft
 East: 1172463.73 ft
 Station: 1711+07.72
 Offset: 28.4223 RT

Profile	Elevation (ft)	SOIL AND ROCK DESCRIPTION	Depth (ft)	Sample Type recovery	Sample No.	SPT Values (blw/6 in)	Qu (tsf)	Moisture Content (%)	Profile	Elevation (ft)	SOIL AND ROCK DESCRIPTION	Depth (ft)	Sample Type recovery	Sample No.	SPT Values (blw/6 in)	Qu (tsf)	Moisture Content (%)
	490.4	--WEATHERED BEDROCK--															
		Boring terminated at 102.00 ft															
			105														
			110														
			115														
			120														
			125														

GENERAL NOTES

WATER LEVEL DATA

Begin Drilling **03-09-2014** Complete Drilling **03-09-2014**
 Drilling Contractor **Wang Testing Services** Drill Rig **CME-55 TMR**
 Driller **R&N** Logger **F. Bozga** Checked by *
 Drilling Method **2.25" SSA to 12.5', mud rotary thereafter, boring**
 **backfilled upon completion**

While Drilling ▽ **NA**
 At Completion of Drilling ▼ **NA**
 Time After Drilling **NA**
 Depth to Water ▼ **NA**

The stratification lines represent the approximate boundary between soil types; the actual transition may be gradual.



BORING LOG 0461-B-14

wangeng@wangeng.com
 1145 N Main Street
 Lombard, IL 60148
 Telephone: 630 953-9928
 Fax: 630 953-9938

WEI Job No.: 1100-04-01

Client **AECOM**
 Project **Circle Interchange Reconstruction**
 Location **Section 17, T39N, R14E of 3rd PM**

Datum: NAVD 88
 Elevation: 590.20 ft
 North: 1897888.98 ft
 East: 1172270.17 ft
 Station: 1709+12.05
 Offset: 34.7157 RT

Profile	Elevation (ft)	SOIL AND ROCK DESCRIPTION	Depth (ft)	Sample Type recovery	Sample No.	SPT Values (blw/6 in)	Qu (tsf)	Moisture Content (%)	Profile	Elevation (ft)	SOIL AND ROCK DESCRIPTION	Depth (ft)	Sample Type recovery	Sample No.	SPT Values (blw/6 in)	Qu (tsf)	Moisture Content (%)
	589.5	9-inch thick CONCRETE															
	589.1	--PAVEMENT--															
		4-inch thick CRUSHED STONE			1	8 13 7	NP	15						11	0 0 0	0.49 B	25
		--BASE COURSE--															
		Loose to medium dense, brown, fine SAND	5		2	1 2 4	NP	19				30		12	0 0 0	0.33 B	25
	583.7	Stiff to very stiff, gray SILTY CLAY, trace gravel	10		3	2 2 4	2.21 B	18				35		13	0 1 2	0.25 B	32
	579.7	Soft to medium stiff, gray CLAY to SILTY CLAY, trace gravel	15		4	2 3 2	1.23 B	23				40		14	0 0 2	0.41 B	25
			20		5	2 3 2	0.74 B	24				45		15	0 1 2	0.66 B	26
			25		6	0 0 0	0.33 B	26				50		16	0 0 1	0.41 B	28
					7	0 0 0	0.25 B	27									
					8	0 0 0	0.16 B	28									
					9	0 1 2	0.33 B	27									
					10	0 0 2	0.41 B	26									

GENERAL NOTES

Begin Drilling **03-26-2014** Complete Drilling **03-26-2014**
 Drilling Contractor **Wang Testing Services** Drill Rig **CME-55 TMR**
 Driller **R&J** Logger **F. Bozga** Checked by *****
 Drilling Method **2.25" SSA to 11', mud rotary thereafter, boring**
backfilled upon completion

WATER LEVEL DATA

While Drilling **NA**
 At Completion of Drilling **NA**
 Time After Drilling **NA**
 Depth to Water **NA**

The stratification lines represent the approximate boundary between soil types; the actual transition may be gradual.

WANGENGINC 11000401.GPJ WANGENG.GDT 9/26/14



BORING LOG 0461-B-14

wangeng@wangeng.com
 1145 N Main Street
 Lombard, IL 60148
 Telephone: 630 953-9928
 Fax: 630 953-9938

WEI Job No.: 1100-04-01

Client **AECOM**
 Project **Circle Interchange Reconstruction**
 Location **Section 17, T39N, R14E of 3rd PM**

Datum: NAVD 88
 Elevation: 590.20 ft
 North: 1897888.98 ft
 East: 1172270.17 ft
 Station: 1709+12.05
 Offset: 34.7157 RT

Profile	Elevation (ft)	SOIL AND ROCK DESCRIPTION	Depth (ft)	Sample Type recovery	Sample No.	SPT Values (blw/6 in)	Qu (tsf)	Moisture Content (%)	Profile	Elevation (ft)	SOIL AND ROCK DESCRIPTION	Depth (ft)	Sample Type recovery	Sample No.	SPT Values (blw/6 in)	Qu (tsf)	Moisture Content (%)	
	538.5	Hard, gray SILTY CLAY LOAM to SILTY LOAM, trace gravel																
			55	X	17	8 13 16	6.56 B	16				80	X	22	16 22 30	9.02 S	15	
			60	X	18	6 9 11	6.56 B	15				85	X	23	37 37 50/4	5.74 B	12	
			65	X	19	4 9 12	4.10 B	22			503.5	Very dense, gray SILT	90	X	24	37 49 50/2	NP	26
			70	X	20	16 26 30	8.61 S	16			498.5	Very dense, gray GRAVELLY SANDY LOAM	95	X	25	50/2	NP	13
			75	X	21	11 18 28	6.97 S	13					100	X	26	50/4	NP	8

GENERAL NOTES

Begin Drilling **03-26-2014** Complete Drilling **03-26-2014**
 Drilling Contractor **Wang Testing Services** Drill Rig **CME-55 TMR**
 Driller **R&J** Logger **F. Bozga** Checked by *****
 Drilling Method **2.25" SSA to 11', mud rotary thereafter, boring**
backfilled upon completion

WATER LEVEL DATA

While Drilling ∇ **NA**
 At Completion of Drilling ∇ **NA**
 Time After Drilling **NA**
 Depth to Water ∇ **NA**

The stratification lines represent the approximate boundary between soil types; the actual transition may be gradual.

WANGENGINC 11000401.GPJ WANGENG.GDT 9/26/14



BORING LOG 0461-B-14

wangeng@wangeng.com
 1145 N Main Street
 Lombard, IL 60148
 Telephone: 630 953-9928
 Fax: 630 953-9938

WEI Job No.: 1100-04-01

Client **AECOM**
 Project **Circle Interchange Reconstruction**
 Location **Section 17, T39N, R14E of 3rd PM**

Datum: NAVD 88
 Elevation: 590.20 ft
 North: 1897888.98 ft
 East: 1172270.17 ft
 Station: 1709+12.05
 Offset: 34.7157 RT

Profile	Elevation (ft)	SOIL AND ROCK DESCRIPTION	Depth (ft)	Sample Type recovery	Sample No.	SPT Values (blw/6 in)	Qu (tsf)	Moisture Content (%)	Profile	Elevation (ft)	SOIL AND ROCK DESCRIPTION	Depth (ft)	Sample Type recovery	Sample No.	SPT Values (blw/6 in)	Qu (tsf)	Moisture Content (%)
	488.5	--HARD DRILLING-- --Possible Cobbles--															
		Very dense, white DOLOSTONE fragments and greenish gray argillaceous infill															
		--WEATHERED BEDROCK--			27	50/3	NP	19									
		--HARD DRILLING-- --Possible Cobbles--	105														
	483.2	--AUGER REFUSAL--															
		Boring terminated at 107.00 ft															
			110														
			115														
			120														
			125														

GENERAL NOTES

WATER LEVEL DATA

Begin Drilling **03-26-2014** Complete Drilling **03-26-2014**
 Drilling Contractor **Wang Testing Services** Drill Rig **CME-55 TMR**
 Driller **R&J** Logger **F. Bozga** Checked by *
 Drilling Method **2.25" SSA to 11', mud rotary thereafter, boring**
backfilled upon completion

While Drilling ▽ **NA**
 At Completion of Drilling ▼ **NA**
 Time After Drilling **NA**
 Depth to Water ▼ **NA**

The stratification lines represent the approximate boundary between soil types; the actual transition may be gradual.



wangeng@wangeng.com
 1145 N Main Street
 Lombard, IL 60148
 Telephone: 630 953-9928
 Fax: 630 953-9938

BORING LOG 0461-B-15

WEI Job No.: 1100-04-01

Client **AECOM**
 Project **Circle Interchange Reconstruction**
 Location **Section 17, T39N, R14E of 3rd PM**

Datum: NAVD 88
 Elevation: 587.87 ft
 North: 1897885.92 ft
 East: 1172158.86 ft
 Station: 1708+00.83
 Offset: 29.1344 RT

Profile	Elevation (ft)	SOIL AND ROCK DESCRIPTION	Depth (ft)	Sample Type recovery	Sample No.	SPT Values (blw/6 in)	Qu (tsf)	Moisture Content (%)	Profile	Elevation (ft)	SOIL AND ROCK DESCRIPTION	Depth (ft)	Sample Type recovery	Sample No.	SPT Values (blw/6 in)	Qu (tsf)	Moisture Content (%)
	587.1 586.8	10-inch thick CONCRETE --PAVEMENT--															
		3-inch thick CRUSHED STONE --BASE COURSE--			1	14 18 13	NP	20						11	0 0 0	0.16 B	25
		Dense, brown, fine SAND --FILL--															
	583.9				2	3 3 4	2.05 B	23				30		12	0 0 1	0.16 B	28
	582.4	Very stiff, gray SILTY CLAY, trace gravel	5														
		Very soft to medium stiff, gray CLAY to SILTY CLAY, trace gravel			3	4 3 2	0.57 B	22									
					4	1 2 2	0.33 B	22				35		13	0 0 1	0.17 N/6	28
					5	1 1 1	0.25 B	24									
					6	0 0 2	0.25 B	28				40		14	1 1 1	0.16 B	26
					7	0 1 2	0.25 B	26									
					8	0 0 0	0.16 B	28				45		15	1 2 1	0.16 B	26
					9	0 0 0	0.16 B	38									
					10	0 0 0	0.16 B	25		541.1	Stiff to hard, gray SILTY CLAY, trace gravel			16	2 4 7	1.72 B	18

GENERAL NOTES

Begin Drilling **03-26-2014** Complete Drilling **03-26-2014**
 Drilling Contractor **Wang Testing Services** Drill Rig **B-57 TMR**
 Driller **P&P** Logger **D. Kolpacki** Checked by **C. Marin**
 Drilling Method **3.25" HSA to 10', mud rotary thereafter, boring**
backfilled upon completion

WATER LEVEL DATA

While Drilling **3.00 ft**
 At Completion of Drilling **87.00 ft**
 Time After Drilling **NA**
 Depth to Water **NA**

The stratification lines represent the approximate boundary between soil types; the actual transition may be gradual.

WANGENGINC 11000401.GPJ WANGENG.GDT 9/26/14



BORING LOG 0461-B-15

wangeng@wangeng.com
 1145 N Main Street
 Lombard, IL 60148
 Telephone: 630 953-9928
 Fax: 630 953-9938

WEI Job No.: 1100-04-01

Client **AECOM**
 Project **Circle Interchange Reconstruction**
 Location **Section 17, T39N, R14E of 3rd PM**

Datum: NAVD 88
 Elevation: 587.87 ft
 North: 1897885.92 ft
 East: 1172158.86 ft
 Station: 1708+00.83
 Offset: 29.1344 RT

Profile	Elevation (ft)	SOIL AND ROCK DESCRIPTION	Depth (ft)	Sample Type recovery	Sample No.	SPT Values (blw/6 in)	Qu (tsf)	Moisture Content (%)	Profile	Elevation (ft)	SOIL AND ROCK DESCRIPTION	Depth (ft)	Sample Type recovery	Sample No.	SPT Values (blw/6 in)	Qu (tsf)	Moisture Content (%)	
	531.1	Hard, gray SILTY CLAY LOAM to SILTY LOAM, trace gravel	55	X	17	7 10 13	4.76 B	14				80			50/2	8.33 N/6		
			60	X	18	10 20 22	7.17 N/6	14				85	X	23	15 25 41	9.02 B	15	
			65	X	19	9 18 26	8.12 S	13			501.1	Very dense, gray, fine SAND --WET--	90	X	24	50/4	NP	16
			70	X	20	12 17 31	NP	16					95	X	25	50/5	NP	11
			75	X	21	16 24 28	7.46 S	14			491.1	Very dense, gray SILTY LOAM, some gravel	100	X	26	50/3 C	NP	11
										488.9	Strong, light gray, fair to good rock mass quality, bedded fresh							

GENERAL NOTES

Begin Drilling **03-26-2014** Complete Drilling **03-26-2014**
 Drilling Contractor **Wang Testing Services** Drill Rig **B-57 TMR**
 Driller **P&P** Logger **D. Kolpacki** Checked by **C. Marin**
 Drilling Method **3.25" HSA to 10', mud rotary thereafter, boring**
backfilled upon completion

WATER LEVEL DATA

While Drilling **3.00 ft**
 At Completion of Drilling **87.00 ft**
 Time After Drilling **NA**
 Depth to Water **NA**

The stratification lines represent the approximate boundary between soil types; the actual transition may be gradual.

WANGENGINC 11000401.GPJ WANGENG.GDT 9/26/14



wangeng@wangeng.com
 1145 N Main Street
 Lombard, IL 60148
 Telephone: 630 953-9928
 Fax: 630 953-9938

BORING LOG 0461-B-15

WEI Job No.: 1100-04-01

Client **AECOM**
 Project **Circle Interchange Reconstruction**
 Location **Section 17, T39N, R14E of 3rd PM**

Datum: NAVD 88
 Elevation: 587.87 ft
 North: 1897885.92 ft
 East: 1172158.86 ft
 Station: 1708+00.83
 Offset: 29.1344 RT

Profile	Elevation (ft)	SOIL AND ROCK DESCRIPTION	Depth (ft)	Sample Type recovery	Sample No.	SPT Values (blw/6 in)	Qu (tsf)	Moisture Content (%)	Profile	Elevation (ft)	SOIL AND ROCK DESCRIPTION	Depth (ft)	Sample Type recovery	Sample No.	SPT Values (blw/6 in)	Qu (tsf)	Moisture Content (%)
	478.9	DOLOSTONE, up to 18-inch beds, 10-inch joints spacing, horizontal joints with none to less than 0.2-inch infilling, hard joint wall, with stylolitic surfaces, and moderately vuggy porosity --Run 1 - RECOVERY=100%-- --RQD=75%--	105		1												
		Boring terminated at 109.00 ft	110														
			115														
			120														
			125														

GENERAL NOTES

WATER LEVEL DATA

Begin Drilling **03-26-2014** Complete Drilling **03-26-2014**
 Drilling Contractor **Wang Testing Services** Drill Rig **B-57 TMR**
 Driller **P&P** Logger **D. Kolpacki** Checked by **C. Marin**
 Drilling Method **3.25" HSA to 10', mud rotary thereafter, boring**
 **backfilled upon completion**

While Drilling ▽ **3.00 ft**
 At Completion of Drilling ▼ **87.00 ft**
 Time After Drilling **NA**
 Depth to Water ▼ **NA**

The stratification lines represent the approximate boundary between soil types; the actual transition may be gradual.



wangeng@wangeng.com
 1145 N Main Street
 Lombard, IL 60148
 Telephone: 630 953-9928
 Fax: 630 953-9938

BORING LOG 41-RWB-01

WEI Job No.: 1100-04-01

Client: **AECOM**
 Project: **Circle Interchange Reconstruction**
 Location: **Section 17, T39N, R14E of 3rd PM**

Datum: NAVD 88
 Elevation: 598.99 ft
 North: 1897924.42 ft
 East: 1173020.83 ft
 Station: 5171+16.66
 Offset: 62.1317 RT

Profile	Elevation (ft)	SOIL AND ROCK DESCRIPTION	Depth (ft)	Sample Type recovery	Sample No.	SPT Values (blw/6 in)	Qu (tsf)	Moisture Content (%)	Profile	Elevation (ft)	SOIL AND ROCK DESCRIPTION	Depth (ft)	Sample Type recovery	Sample No.	SPT Values (blw/6 in)	Qu (tsf)	Moisture Content (%)
	598.2	10-inch thick CONCRETE									--A-6 (8) --						
	598.0	--PAVEMENT--															
		CRUSHED STONE			1	2 3 3	NP	13						11	0 0 0	0.16 B	30
		--BASE COURSE--															
		Very loose to medium dense, yellowish brown, fine to medium SAND, trace gravel and brick fragments			2	5 6 4	NP	7				30		12	0 0 0	0.16 B	36
		--FILL--	5														
					3	1 2 1	NP	5									
	590.2	Stiff, brown and gray SILTY CLAY LOAM, trace gravel			4	1 1 2	1.50 P	5				35		13	0 0 0	0.16 B	22
		--FILL--	10														
	587.5	Loose, brown SILTY LOAM			5	1 2 3	NP	25									
		--Moist--															
		--L _L (%)=NP, P _L (%)=NP--			6	1 2 3	NP	24				40		14	0 0 0	NA	
		--%Gravel=0.3--															
		--%Sand=22.4--	15														
		--%Silt=72.2--			7	2 3 5		1.80 B									
		--%Clay=5.2--															
	583.5	Medium stiff to stiff, gray SILTY CLAY, trace gravel			7												
		--A-4 (0)--															
					8	2 2 2		0.90 B				45		15	0 0 2	0.16 B	27
			20														
	578.5	Very soft to medium stiff, gray CLAY to SILTY CLAY, trace gravel			9	0 0 0		0.25 B									
		--L _L (%)=28, P _L (%)=15--															
		--%Gravel=2.9--															
		--%Sand=19.1--															
		--%Silt=49.3--			10	0 0 0		0.25 B				50		16	0 0 0	0.41 B	26
		--%Clay=28.7--															
			25														

GENERAL NOTES

Begin Drilling **10-20-2013** Complete Drilling **10-20-2013**
 Drilling Contractor **Wang Testing Services** Drill Rig **CME-55 TMR**
 Driller **R&J** Logger **A. Happel** Checked by _____
 Drilling Method **2.25" HSA to 20', mud rotary thereafter, boring**
backfilled upon completion

WATER LEVEL DATA

While Drilling ∇ **NA**
 At Completion of Drilling ∇ **NA**
 Time After Drilling **NA**
 Depth to Water ∇ **NA**

The stratification lines represent the approximate boundary between soil types; the actual transition may be gradual.

WANGENGINC 11000401.GPJ WANGENG.GDT 9/26/14



wangeng@wangeng.com
 1145 N Main Street
 Lombard, IL 60148
 Telephone: 630 953-9928
 Fax: 630 953-9938

BORING LOG 41-RWB-01

WEI Job No.: 1100-04-01

Client: **AECOM**
 Project: **Circle Interchange Reconstruction**
 Location: **Section 17, T39N, R14E of 3rd PM**

Datum: NAVD 88
 Elevation: 598.99 ft
 North: 1897924.42 ft
 East: 1173020.83 ft
 Station: 5171+16.66
 Offset: 62.1317 RT

Profile	Elevation (ft)	SOIL AND ROCK DESCRIPTION	Depth (ft)	Sample Type recovery	Sample No.	SPT Values (blw/6 in)	Qu (tsf)	Moisture Content (%)	Profile	Elevation (ft)	SOIL AND ROCK DESCRIPTION	Depth (ft)	Sample Type recovery	Sample No.	SPT Values (blw/6 in)	Qu (tsf)	Moisture Content (%)
	537.2	Very stiff to hard, gray SILTY CLAY, trace gravel	55	X	17	0 0 0	0.49 B	24		517.2	Medium stiff, gray CLAY	80	X	22	8 16 14	3.61 B	21
			60	X	18	3 7 8	0.98 B	19				85	X	23	4 5 8	0.75 P	31
			65	X	19	4 8 13	3.28 B	21		510.2	Dense, gray SILTY LOAM	90	X	24	11 11 21	NP	21
			70	X	20	8 16 16	3.69 B	12		507.2	Dense, gray GRAVELLY SAND --Wet--	95	X	25	12 25 18	NP	14
			75	X	21	12 16 24	4.59 B	20		501.5	--HARD DRILLING--			26		NA	
										500.5	--BEDROCK--						
											Boring terminated at 98.50 ft				50/1		

GENERAL NOTES

WATER LEVEL DATA

Begin Drilling **10-20-2013** Complete Drilling **10-20-2013**
 Drilling Contractor **Wang Testing Services** Drill Rig **CME-55 TMR**
 Driller **R&J** Logger **A. Happel** Checked by _____
 Drilling Method **2.25" HSA to 20', mud rotary thereafter, boring backfilled upon completion**

While Drilling ∇ **NA**
 At Completion of Drilling ∇ **NA**
 Time After Drilling **NA**
 Depth to Water ∇ **NA**

The stratification lines represent the approximate boundary between soil types; the actual transition may be gradual.

WANGENGINC 11000401.GPJ WANGENG.GDT 9/26/14

APPENDIX B

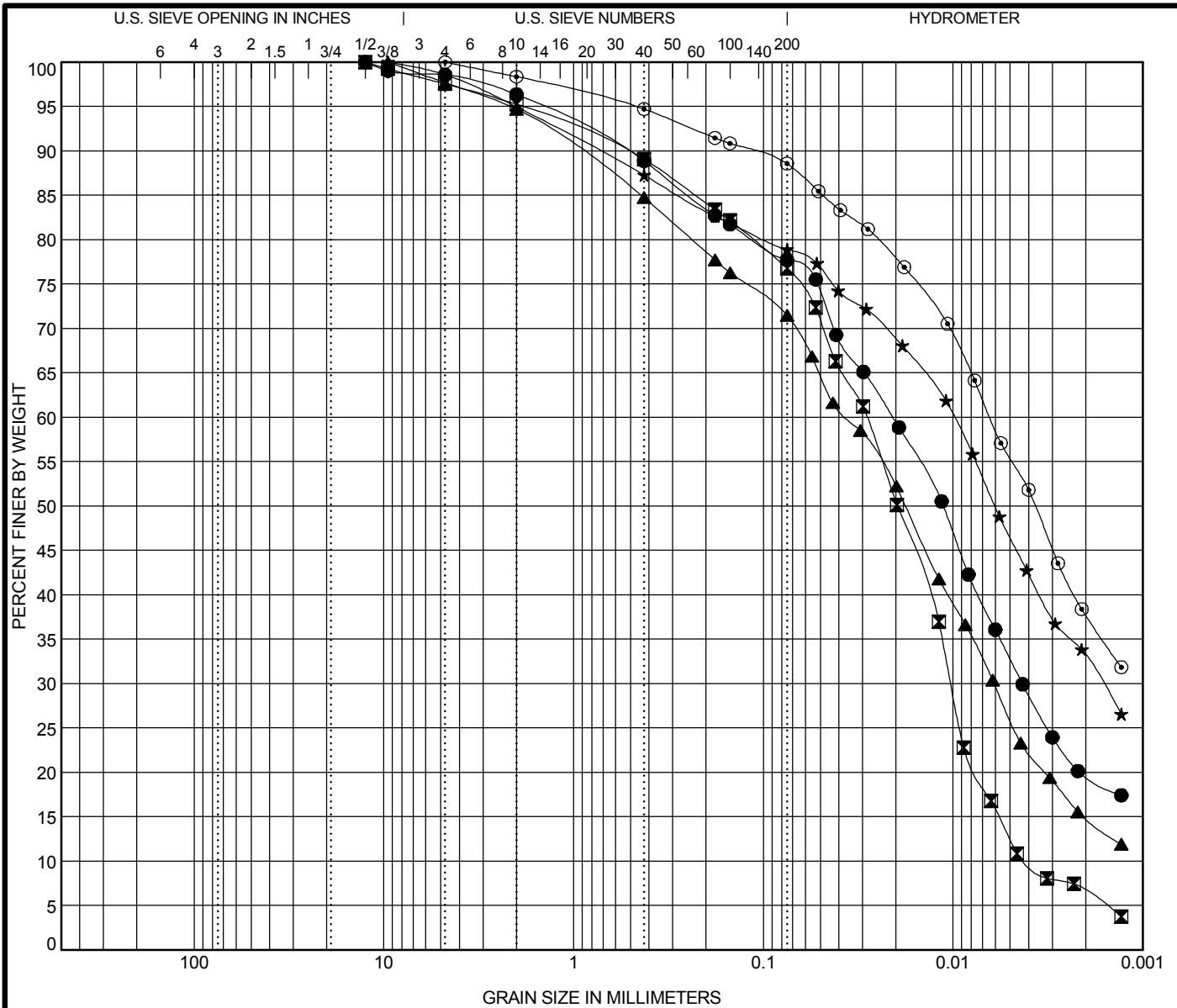

COBBLES	GRAVEL	SAND		SILT AND CLAY
		coarse	fine	

Specimen Identification			IDH Classification					LL	PL	PI	Cc	Cu
●	0461-B-02#22	78.5 ft	Silty Clay Loam					27	17	10		
☒	0461-B-04#24	88.5 ft	Silty Loam					NP	NP	NP	0.90	6.94
▲	0461-B-05#20	68.5 ft	Silty Loam					24	14	10		
★	0461-B-07#12	48.5 ft	Clay					35	17	18		
◎	0461-B-07#18	78.5 ft	Silty Clay					36	18	18		
Specimen Identification			D100	D60	D30	D10	%Gravel	%Sand	%Silt	%Clay		
●	0461-B-02#22	78.5 ft	12.5	0.021	0.004		3.6	18.7	58.0	19.7		
☒	0461-B-04#24	88.5 ft	12.5	0.029	0.01	0.004	4.7	18.7	70.1	6.5		
▲	0461-B-05#20	68.5 ft	9.5	0.036	0.006		5.3	23.4	56.4	14.9		
★	0461-B-07#12	48.5 ft	9.5	0.01	0.002		5.0	16.1	45.7	33.1		
◎	0461-B-07#18	78.5 ft	4.75	0.006			1.6	9.9	50.8	37.7		

WEI GRAIN SIZE IDH 11000401.GPJ US_LAB.GDT 9/26/14



Wang Engineering, Inc.
 1145 N Main Street
 Lombard, IL 60148
 Telephone: 630 953-9928
 Fax: 630 953-9938

GRAIN SIZE DISTRIBUTION

Project: Circle Interchange Reconstruction
 Location: Section 17, T39N, R14E of 3rd PM
 Number: 1100-04-01

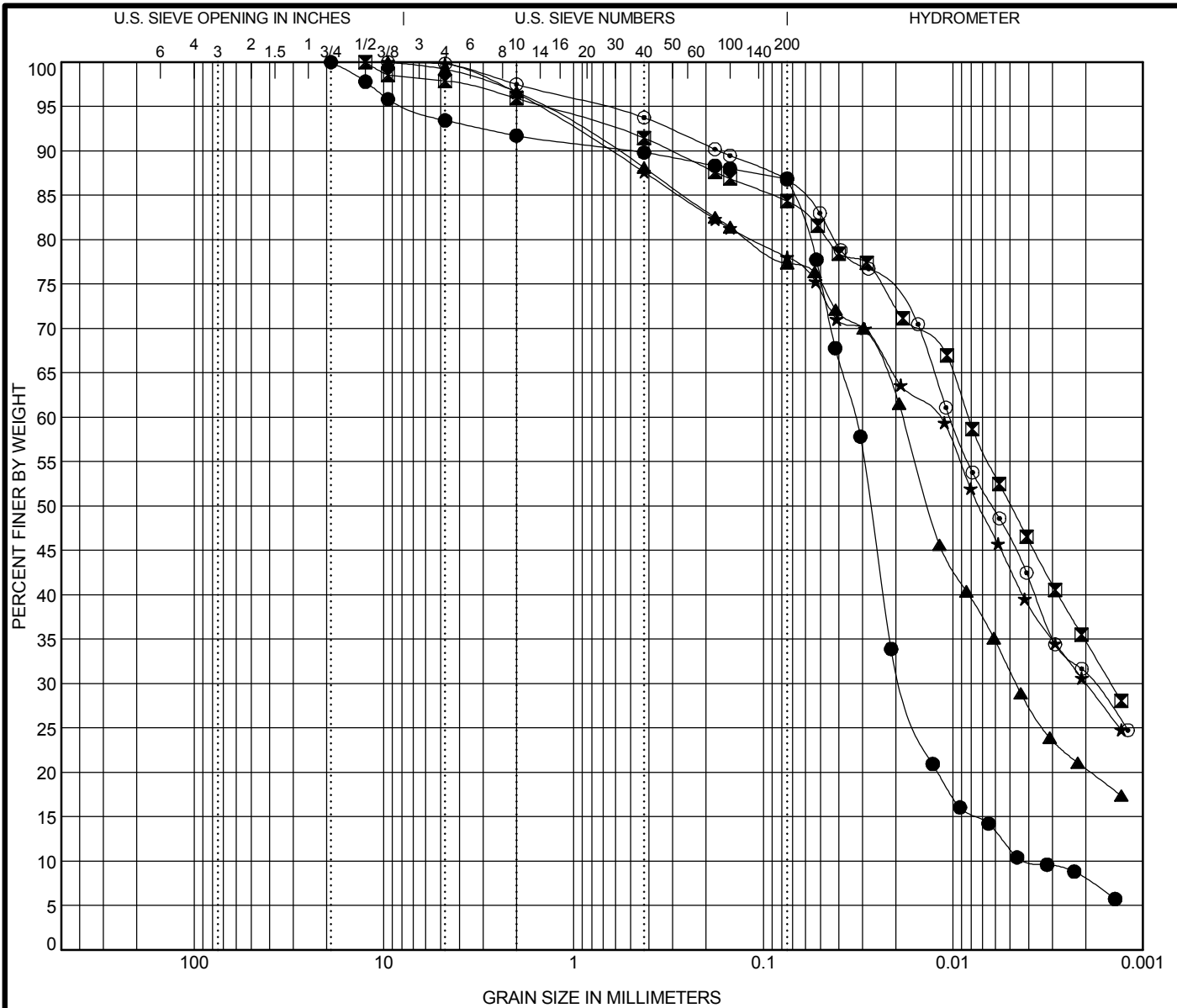

COBBLES	GRAVEL	SAND		SILT AND CLAY
		coarse	fine	

Specimen Identification			IDH Classification					LL	PL	PI	Cc	Cu
●	0461-B-07#21	93.5 ft	Silt					NP	NP	NP	2.64	8.63
☒	0461-B-08B#19	63.5 ft	Silty Clay					34	18	16		
▲	0461-B-09#19	63.5 ft	Silty Clay Loam					24	15	9		
★	0461-B-10#16	48.5 ft	Clay					33	16	17		
◎	0461-B-11#21	73.5 ft	Silty Clay					32	18	14		
Specimen Identification			D100	D60	D30	D10	%Gravel	%Sand	%Silt	%Clay		
●	0461-B-07#21	93.5 ft	19	0.033	0.018	0.004	8.3	5.2	78.6	8.0		
☒	0461-B-08B#19	63.5 ft	12.5	0.008	0.001		4.1	11.7	49.5	34.7		
▲	0461-B-09#19	63.5 ft	9.5	0.018	0.005		3.4	19.3	56.9	20.4		
★	0461-B-10#16	48.5 ft	9.5	0.012	0.002		3.5	18.6	47.9	30.0		
◎	0461-B-11#21	73.5 ft	9.5	0.01	0.002		2.5	10.9	55.6	31.1		

WEI GRAIN SIZE IDH 11000401.GPJ US_LAB.GDT 9/26/14



Wang Engineering, Inc.
 1145 N Main Street
 Lombard, IL 60148
 Telephone: 630 953-9928
 Fax: 630 953-9938

GRAIN SIZE DISTRIBUTION

Project: Circle Interchange Reconstruction
 Location: Section 17, T39N, R14E of 3rd PM
 Number: 1100-04-01

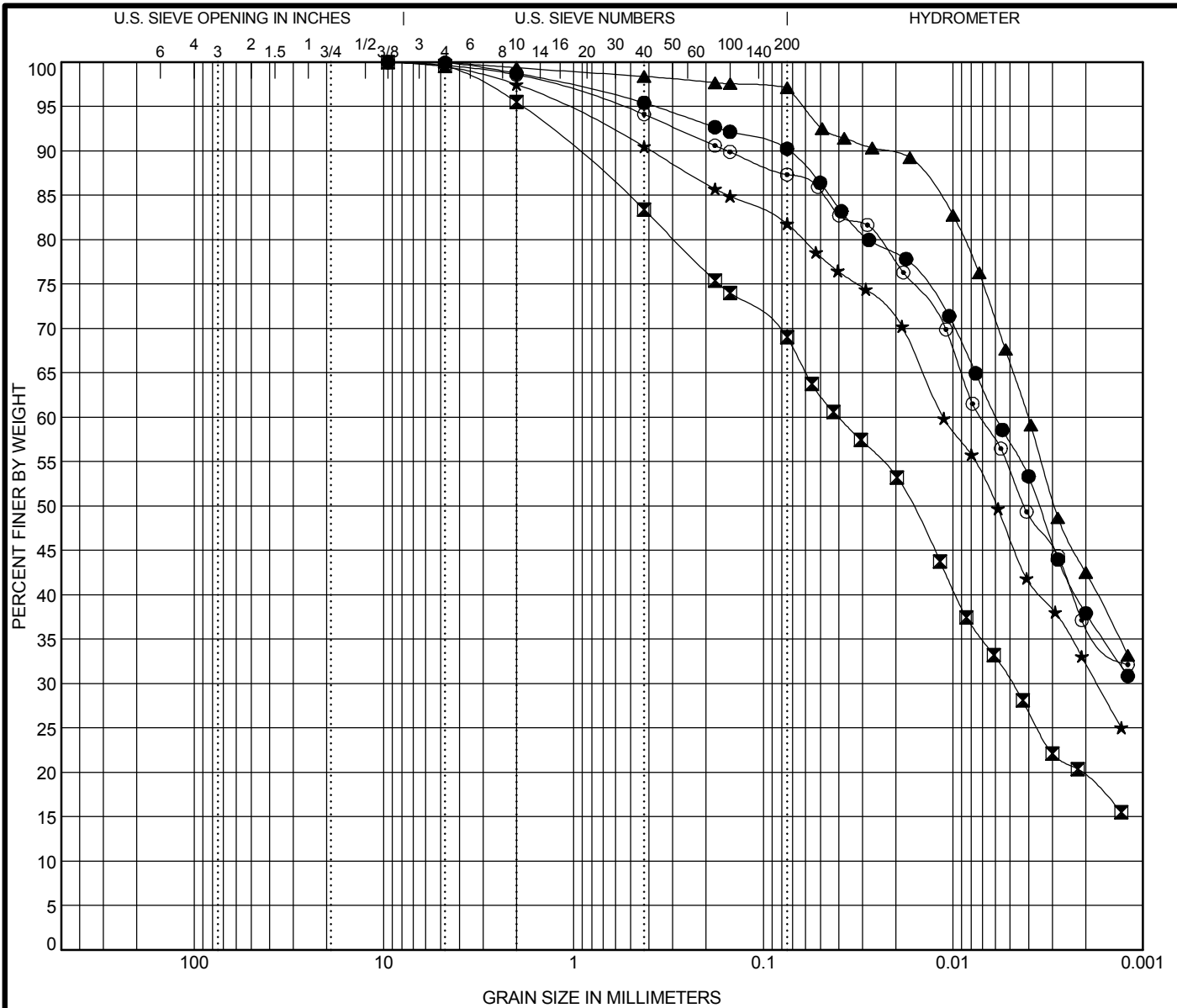

COBBLES	GRAVEL	SAND		SILT AND CLAY
		coarse	fine	

Specimen Identification			IDH Classification					LL	PL	PI	Cc	Cu
●	0461-B-12#10	23.5 ft	Silty Clay					37	17	20		
☒	0461-B-12#19	63.5 ft	Silty Clay Loam					25	14	11		
▲	0461-B-12#23	83.5 ft	Silty Clay					38	19	19		
★	0461-B-13#14	38.5 ft	Silty Clay					34	18	16		
◎	0461-B-13#20	68.5 ft	Silty Clay					34	18	16		
Specimen Identification			D100	D60	D30	D10	%Gravel	%Sand	%Silt	%Clay		
●	0461-B-12#10	23.5 ft	9.5	0.006			1.3	8.6	52.2	37.9		
☒	0461-B-12#19	63.5 ft	9.5	0.04	0.005		4.5	26.7	49.3	19.5		
▲	0461-B-12#23	83.5 ft	4.75	0.004			0.6	2.4	54.5	42.5		
★	0461-B-13#14	38.5 ft	9.5	0.011	0.002		2.5	15.8	49.4	32.2		
◎	0461-B-13#20	68.5 ft	9.5	0.007			1.4	11.3	50.6	36.7		

WEI GRAIN SIZE IDH 11000401.GPJ US_LAB.GDT 9/26/14



Wang Engineering, Inc.
 1145 N Main Street
 Lombard, IL 60148
 Telephone: 630 953-9928
 Fax: 630 953-9938

GRAIN SIZE DISTRIBUTION

Project: Circle Interchange Reconstruction
 Location: Section 17, T39N, R14E of 3rd PM
 Number: 1100-04-01

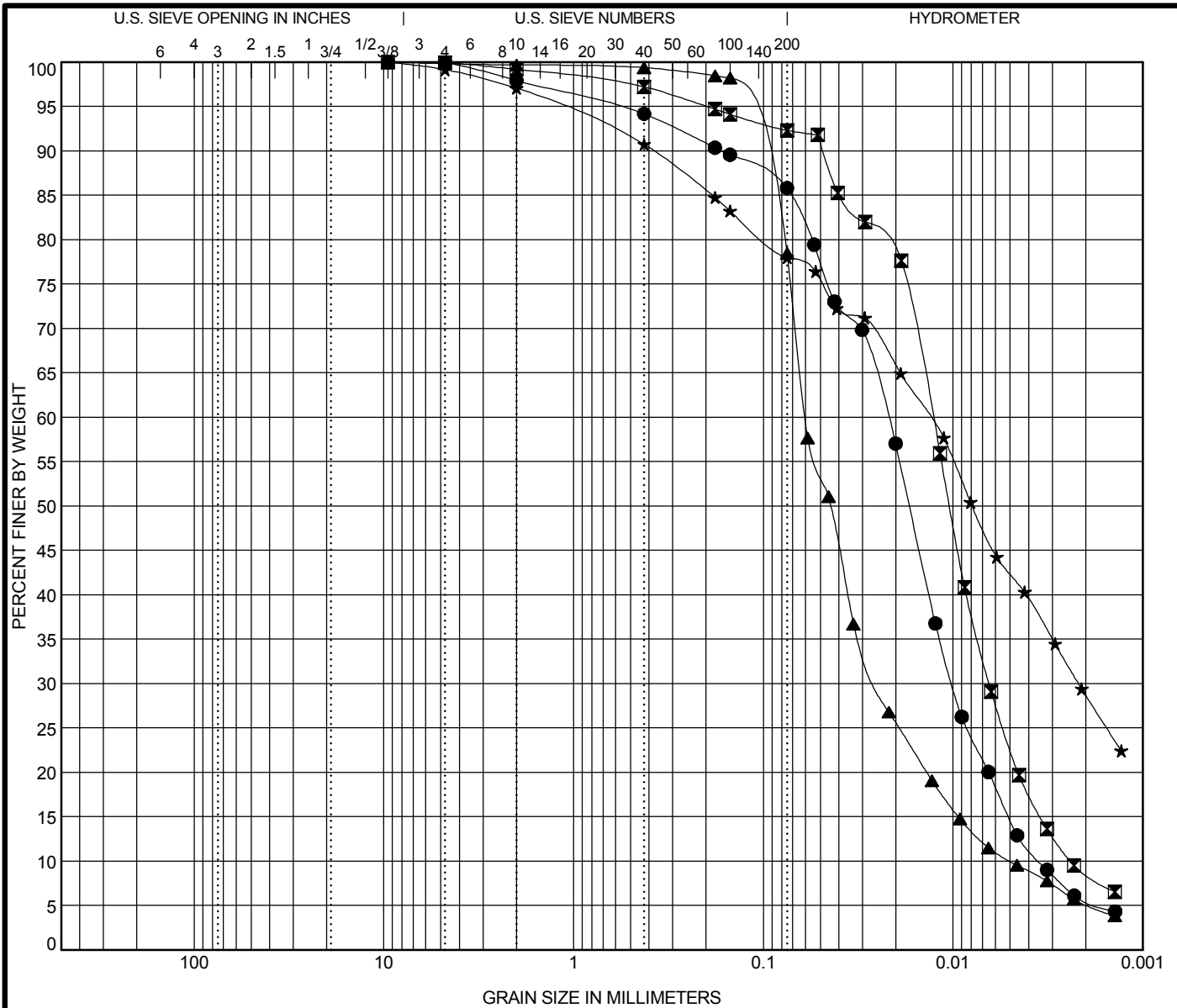

COBBLES	GRAVEL	SAND		SILT AND CLAY
		coarse	fine	

Specimen Identification	IDH Classification	LL	PL	PI	Cc	Cu
● 0461-B-13#22 78.5 ft	Silt	NP	NP	NP	1.31	6.30
◻ 0461-B-13#24 88.5 ft	Silt	NP	NP	NP	1.36	5.34
▲ 41-RWB-01#6 13.5 ft	Silty Loam	NP	NP	NP	2.09	11.99
★ 41-RWB-01#9 21.0 ft	Silty Clay Loam	28	15	13		

Specimen Identification	D100	D60	D30	D10	%Gravel	%Sand	%Silt	%Clay
● 0461-B-13#22 78.5 ft	9.5	0.022	0.01	0.004	2.1	12.4	79.9	5.6
◻ 0461-B-13#24 88.5 ft	9.5	0.013	0.006	0.002	0.8	6.9	83.6	8.7
▲ 41-RWB-01#6 13.5 ft	9.5	0.06	0.025	0.005	0.3	22.4	72.2	5.2
★ 41-RWB-01#9 21.0 ft	9.5	0.013	0.002		2.9	19.1	49.3	28.7



Wang Engineering, Inc.
 1145 N Main Street
 Lombard, IL 60148
 Telephone: 630 953-9928
 Fax: 630 953-9938

GRAIN SIZE DISTRIBUTION

Project: Circle Interchange Reconstruction
 Location: Section 17, T39N, R14E of 3rd PM
 Number: 1100-04-01

WEI GRAIN SIZE IDH 11000401.GPJ US_LAB.GDT 9/26/14

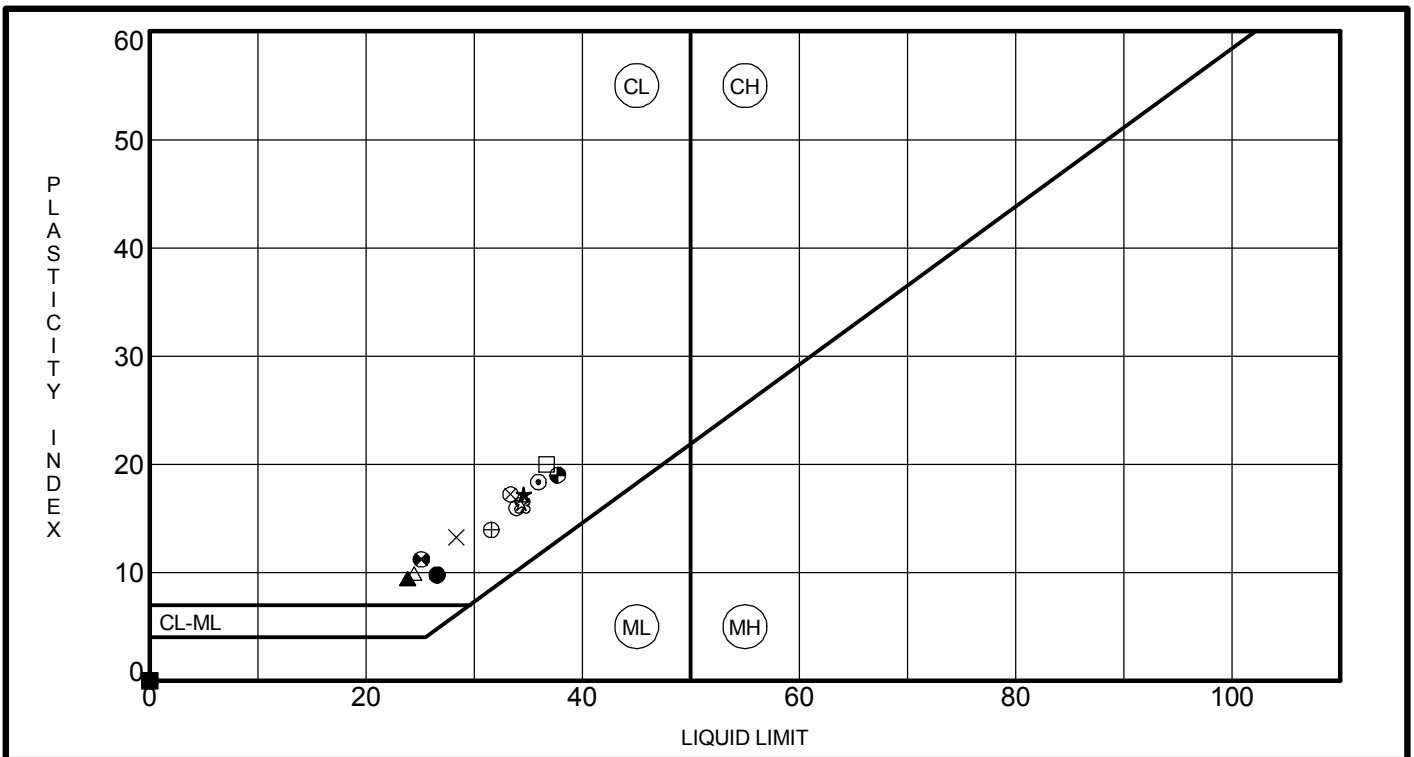

Specimen Identification	LL	PL	PI	Fines	IDH Classification	
● 0461-B-02#22	78.5 ft	27	17	10	78	Silty Clay Loam
⊠ 0461-B-04#24	88.5 ft	NP	NP	NP	77	Silty Loam
▲ 0461-B-05#20	68.5 ft	24	14	10	72	Silty Loam
★ 0461-B-07#12	48.5 ft	35	17	18	79	Clay
⊙ 0461-B-07#18	78.5 ft	36	18	18	89	Silty Clay
⊕ 0461-B-07#21	93.5 ft	NP	NP	NP	87	Silt
○ 0461-B-08B#19	63.5 ft	34	18	16	84	Silty Clay
△ 0461-B-09#19	63.5 ft	24	15	9	77	Silty Clay Loam
⊗ 0461-B-10#16	48.5 ft	33	16	17	78	Clay
⊕ 0461-B-11#21	73.5 ft	32	18	14	87	Silty Clay
□ 0461-B-12#10	23.5 ft	37	17	20	90	Silty Clay
⊕ 0461-B-12#19	63.5 ft	25	14	11	69	Silty Clay Loam
⊕ 0461-B-12#23	83.5 ft	38	19	19	97	Silty Clay
☆ 0461-B-13#14	38.5 ft	34	18	16	82	Silty Clay
⊗ 0461-B-13#20	68.5 ft	34	18	16	87	Silty Clay
■ 0461-B-13#22	78.5 ft	NP	NP	NP	86	Silt
◆ 0461-B-13#24	88.5 ft	NP	NP	NP	92	Silt
◇ 41-RWB-01#6	13.5 ft	NP	NP	NP	78	Silty Loam
× 41-RWB-01#9	21.0 ft	28	15	13	78	Silty Clay Loam

WEI ATTERBERG LIMITS IDH 11000401.GPJ US LAB.GDT 9/26/14



Wang Engineering, Inc.
 1145 N Main Street
 Lombard, IL 60148
 Telephone: 630 953-9928
 Fax: 630 953-9938

ATTERBERG LIMITS' RESULTS

Project: Circle Interchange Reconstruction
 Location: Section 17, T39N, R14E of 3rd PM
 Number: 1100-04-01



Unconfined Compressive Strength of Intact Rock Core Specimens

Project: Circle Interchange

Client: AECOM

WEI Job No.: 1100-04-01

Note: The specimens were sulphur capped for a more uniform break

Field Sample ID	Lab Specimen ID	Depth	Location	Sample Description	Length (in)			Diameter (in)	Total Load (lbs)	Total Pressure (psi)	Fracture Type*	Break Date	Tested By	Area (in ²)
					Total Core	Before Capping	After Capping							
0461-B-07, Run #1	4700	105.0	Congress Parkway Interstate 290	Sound Dolomite	N/A	3.90	4.06	2.04	30680	9350	3	5/15/2015	AM	3.28
0461-B-15, Run #1	9768	104.0	Congress Parkway Interstate 290	Sound Dolomite	N/A	3.89	4.03	2.01	36660	11560	3	6/12/2014	AM	3.17

*** Fracture Types:**

- Type 1 - Reasonably well-formed cones on both ends, less than 1 in. [25 mm] of cracking through caps;
- Type 2 - Well-formed cone on one end, vertical cracks running through caps, no well defined cone on other end;
- Type 3 - Columnar vertical cracking through both ends, no well-formed cones;
- Type 4 - Diagonal fracture with no cracking through ends; tap with hammer to distinguish from Type 1;
- Type 5 - Side fractures at top or bottom (occur commonly with unbonded caps);
- Type 6 - Similar to Type 5 but end of cylinder is pointed.

Prepared by: _____

Checked by: _____



TEXAM Pressuremeter Test

Project number: 1100-04-01
 Project name: Circle Interchange
 Borehole ID: 1715-PMT-01
 Test date: 04/24/2014
 Test number: PMT#2
 Probe size: N

Client: AECOM
 Use of a slotted casing: No
 Test depth: 74.50 feet
 Manometer height above ground: 2.00 feet
 Poisson's coefficient: 0.40
 Fluid density: 1.000

Raw Readings		Corrected Readings		
Pressure tsf	Volume cm ³	Pressure tsf	Volume cm ³	$\Delta R/R_0$ %
27.00	0.0	2.67	0.0	0.00
0.41	80.0	2.68	79.9	2.46
0.53	160.0	2.70	159.8	4.85
0.84	240.0	2.94	239.6	7.19
1.24	280.0	3.32	279.2	8.34
1.91	320.0	3.96	318.7	9.47
2.62	360.0	4.65	358.1	10.58
3.29	400.0	5.30	397.6	11.69
3.97	440.0	5.96	437.0	12.78
4.53	480.0	6.51	476.5	13.87
5.41	520.0	7.37	515.8	14.93
6.46	560.0	8.41	555.0	15.99
8.31	600.0	10.25	593.5	17.02
10.02	640.0	11.95	632.1	18.04
12.16	680.0	14.08	670.3	19.04
4.64	620.0	6.57	616.5	17.63
13.99	720.0	15.89	708.9	20.05
15.63	760.0	17.53	747.5	21.04
17.13	800.0	19.03	786.3	22.04
18.42	840.0	20.30	825.3	23.03
19.62	880.0	21.50	864.3	24.01
20.70	920.0	22.58	903.4	24.99
21.73	960.0	23.59	942.6	25.96
22.67	1000.0	24.53	981.8	26.92
23.53	1040.0	25.39	1021.1	27.88
24.33	1080.0	26.18	1060.5	28.84
25.08	1120.0	26.93	1099.9	29.79
25.73	1160.0	27.58	1139.3	30.73
26.40	1200.0	28.25	1178.8	31.66
27.00	1240.0	28.84	1218.3	32.59
27.54	1280.0	29.38	1257.9	33.52
28.08	1320.0	29.92	1297.4	34.44
28.58	1360.0	30.42	1337.0	35.35
29.04	1400.0	30.88	1376.6	36.26
29.49	1440.0	31.32	1416.3	37.16
29.96	1480.0	31.79	1455.9	38.06
30.36	1520.0	32.18	1495.6	38.95
30.74	1560.0	32.56	1535.3	39.83
31.11	1600.0	32.93	1575.0	40.71
31.48	1640.0	33.30	1614.7	41.59
31.81	1680.0	33.63	1654.4	42.46
32.05	1720.0	33.87	1694.2	43.33

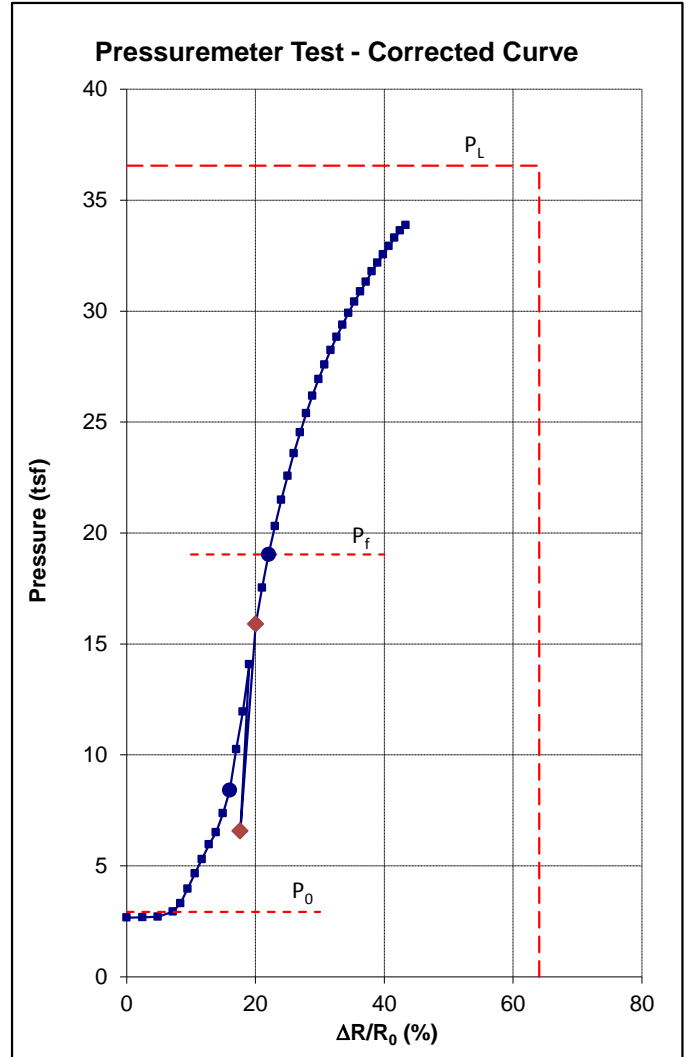

Test Results

Pressuremeter modulus E_0 : 293 tsf
 Pressuremeter reload modulus E_R : 641 tsf
 Limit pressure P_L : 36.5 tsf
 Yield pressure P_f : 19.0 tsf
 Initial pressure P_0 : 2.9 tsf
 Ratio E_0 / P_L : 8
 Ratio P_L / P_f : 1.92
 Ratio E_0 / E_R : 0.46

General Notes

Rotary bit, 2 15/16 inch diameter

APPENDIX C



Run #1

TOP

0461-B-04

Run 2

1100-04-01

3-20-2014

Bottom
113.5'

BOTTOM

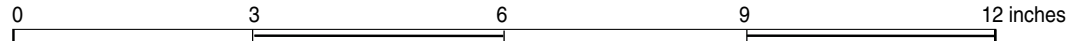

Boring 0461-B-04:
Run 1, 103.5' to 113.5', RECOVERY = 100% , RQD =65%

BEDROCK CORE: CIRCLE INTERCHANGE RECONSTRUCTION INTERSTATE 290 CONGRESS VIADUCT, SN 016-0461, COOK COUNTY		
SCALE : GRAPHIC	APPENDIX C	DRAWN BY: M. de los Reyes CHECKED BY: C. Marin
		1145 N. Main Street Lombard, IL 60148 www.wangeng.com
FOR AECOM		1100-04-01

Run #1

TOP



BOTTOM

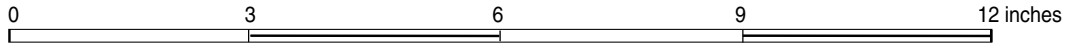

Boring 0461-B-07:
 Run 1, 100' to 110', RECOVERY = 100% , RQD = 94%

BEDROCK CORE: CIRCLE INTERCHANGE RECONSTRUCTION
 INTERSTATE 290 CONGRESS VIADUCT, SN 016-0461, COOK COUNTY

SCALE : GRAPHIC

APPENDIX C

DRAWN BY: M. de los Reyes
CHECKED BY: C. Marin



1145 N. Main Street
 Lombard, IL 60148
 www.wangeng.com

FOR AECOM

1100-04-01

Run #1

TOP



BOTTOM



Boring 0461-B-09:
 Run 1, 91.5' to 101.5', RECOVERY = 98% , RQD = 78%

BEDROCK CORE: CIRCLE INTERCHANGE RECONSTRUCTION
 INTERSTATE 290 CONGRESS VIADUCT, SN 016-0461, COOK COUNTY

SCALE : GRAPHIC

APPENDIX C

DRAWN BY: M. de los Reyes
CHECKED BY: C. Marin



Wang
 Engineering

1145 N. Main Street
 Lombard, IL 60148
 www.wangeng.com

FOR AECOM

1100-04-01

Run #1

TOP



Boring 0461-B-15:
Run 1, 99' to 109', RECOVERY = 93% , RQD = 55%

BEDROCK CORE: CIRCLE INTERCHANGE RECONSTRUCTION
INTERSTATE 290 CONGRESS VIADUCT, SN 016-0461, COOK COUNTY

SCALE : GRAPHIC

APPENDIX C

DRAWN BY: M. de los Reyes
CHECKED BY: C. Marin



1145 N. Main Street
Lombard, IL 60148
www.wangeng.com

FOR AECOM

1100-04-01