

CONTRACT NO: 83763

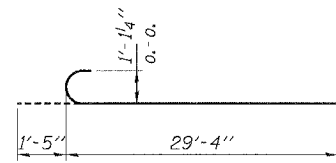

BAR a4(E)

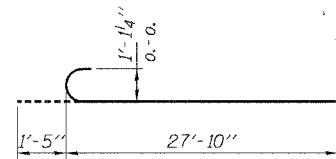

BAR a5(E)

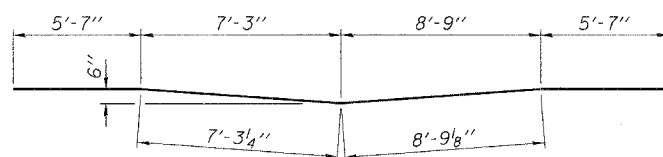

BAR a6(E)

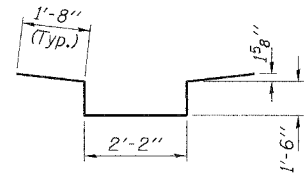

BAR s20(E)

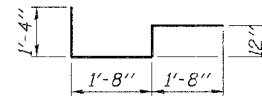

BAR s18(E)

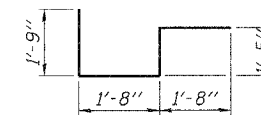

BAR s19(E)

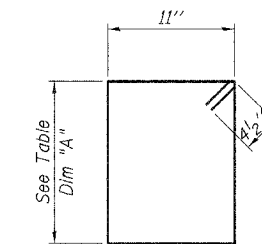

DIM "A"

s(E)	1'-9 1/2"
s1(E)	1'-10 1/2"
s2(E)	1'-11 1/2"
s3(E)	2'-0 1/2"
s4(E)	2'-1 1/2"
s5(E)	2'-2 1/2"
s6(E)	2'-3 1/2"

BARS s(E) THRU s6(E)

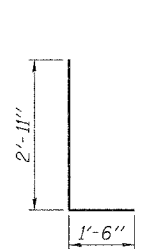

BAR d(E)

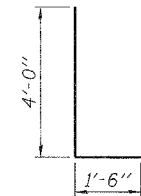

BAR d1(E)

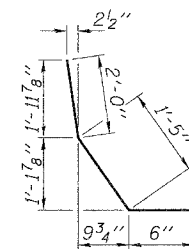

BAR d3(E)

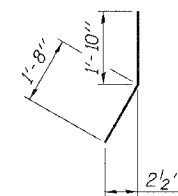

BAR d4(E)

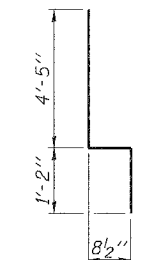

BAR d5(E)

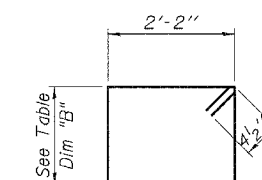

DIM "B"

s7(E)	11"
s8(E)	1'-0"
s9(E)	1'-1"
s10(E)	1'-2"
s11(E)	1'-3"
s12(E)	1'-4"
s13(E)	1'-5"

BARS s8(E) THRU s13(E)

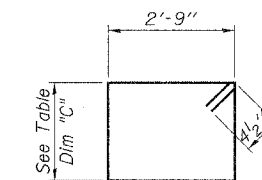

DIM "C"

s14(E)	1'-5"
s15(E)	1'-6"
s16(E)	1'-7"
s24(E)	1'-9"

BARS s14(E) THRU s16(E), s24(E)

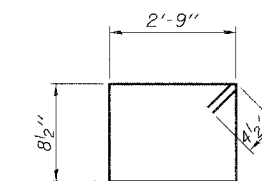

BARS s17(E)

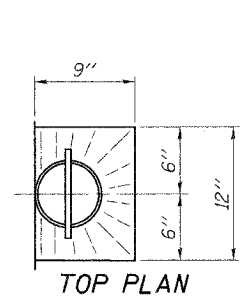

TOP PLAN

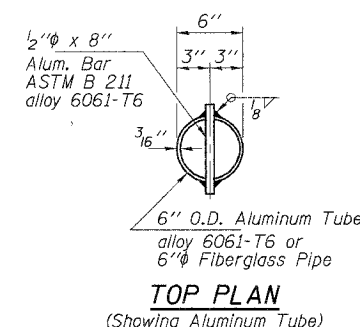

TOP PLAN

(Showing Aluminum Tube)

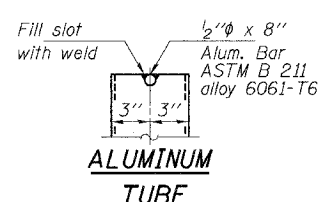

ALUMINUM TUBE

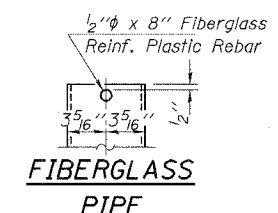

FIBERGLASS PIPE

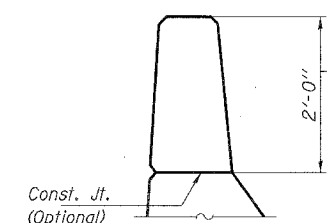

PARAPET JOINT DETAILS

Notes:  
 The exterior surfaces of fiberglass floor drains shall be painted with a vinyl enamel coat. The color shall be Munsell Std. 10Y7/1 Light Grey. Painting of the fiberglass floor drains will not be required when the exterior surfaces of the furnished drains are coated by the manufacturer with silver pigment or a pigment that matches the color of the concrete.  
 Fiberglass pipe shall conform to ASTM D 2996, with short-time rupture strength hoop tensile stress of 30,000 p.s.i. minimum.

**HLR**  
 Account Number 12-07-0043-1  
 Date: 05/23/05  
 DESIGNED: S.M.S. CHECKED: S.W.M. DRAWN: D.B.

**SUPERSTRUCTURE DETAILS**  
 MILLBURN ROAD / CH 14  
 SECTION 99-00076-11-BR  
 LAKE COUNTY  
 STATION 17+65