

# VILLAGE OF LANSING LANSING, ILLINOIS

## CONSTRUCTION PLANS FOR LANSING MUNICIPAL AIRPORT

CONSTRUCT NORTH QUADRANT SITE WORK - PHASE 1;  
CONSTRUCT TAXIWAY G2 EXTENSION;  
GLENWOOD-LANSING ROAD INTERSECTION IMPROVEMENTS

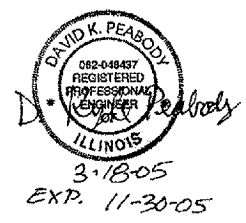

DESIGN INFORMATION  
APPROACH CATEGORY B  
DESIGN GROUP II

LANSING MUNICIPAL AIRPORT  
TOWNSHIP: 36 NORTH BLOOM TOWNSHIP  
RANGE: 15 EAST (SECTION: 8 AND 17)  
COOK COUNTY OPPOSITE GLENWOOD-LANSING ROAD

CALL JULIE  
BEFORE EXCAVATING  
1-800-892-0123

**CMT** 03297-02  
CRAWFORD, MURPHY & TILLY, INC.  
CONSULTING ENGINEERS  
SPRINGFIELD, ILLINOIS  
AURORA, ILLINOIS  
ST. LOUIS, MISSOURI  
ROCKFORD, ILLINOIS  
PEORIA, ILLINOIS  
CHICAGO, ILLINOIS  
MEDWARDSVILLE, ILLINOIS  
EAST ALTON, ILLINOIS  
COLUMBUS, OHIO  
SUBMITTED BY: D. Kyle Peabody  
D. KYLE PEABODY, P.E.  
DATE: March 18, 2005

Lansing Municipal  
**airport**  
APPROVED BY: Daniel Podgorski MAYOR  
DANIEL PODGORSKI  
APPROVED BY: Robert R. Malkas AIRPORT MANAGER  
ROBERT R. MALKAS  
DATE: March 3, 2005

ILLINOIS PROJECT: IGO-3329  
A.I.P. PROJECT: 3-17-0121-B21

MARCH 4, 2005  
REVISED JUNE 10, 2005

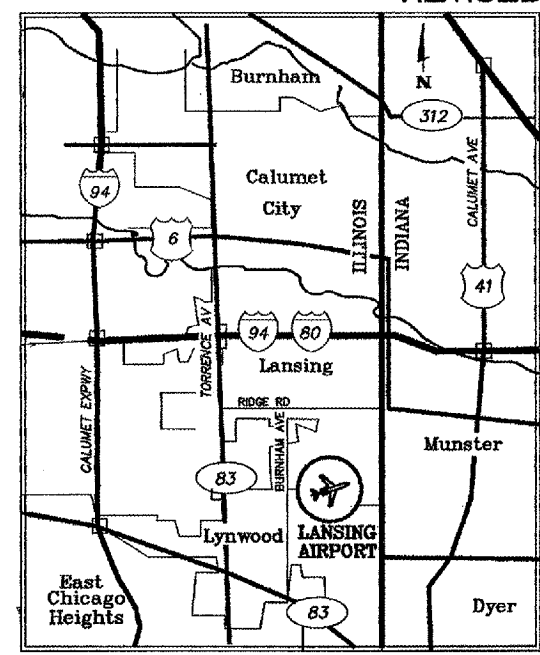

LOCATION MAP

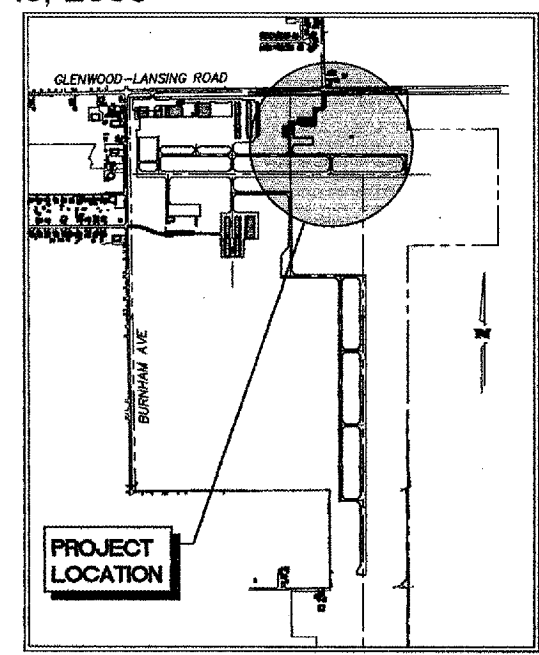

SITE PLAN

### INDEX TO SHEETS

- CONSTRUCT NORTH QUADRANT SITE WORK - PHASE 1 AND CONSTRUCT TAXIWAY G2 EXTENSION
- 1 COVER SHEET
  - 2 SUMMARY OF QUANTITIES
  - 3 SITE PLAN / HORIZONTAL AND VERTICAL CONTROL PLAN
  - 4 SEQUENCE OF CONSTRUCTION GENERAL NOTES AND DETAILS
  - 5 SEQUENCE OF CONSTRUCTION PER AC 150/6370-2E (LATEST EDITION)
  - 6 STORM WATER POLLUTION PREVENTION PLAN
  - 7 STORM WATER POLLUTION PREVENTION PLAN NOTES
  - 8 STORM WATER POLLUTION PREVENTION PLAN DETAILS
  - 9 TYPICAL SECTIONS
  - 10 EXISTING CONDITIONS / PROPOSED REMOVALS NORTH QUADRANT SITEWORK AND AUTO PARKING LOT
  - 11 EXISTING CONDITIONS / PROPOSED REMOVALS BORROW SITE
  - 12 GRADING PLAN NORTH QUADRANT SITE WORK AND AUTO PARKING LOT
  - 13 GRADING PLAN BORROW SITE
  - 14 LIGHTING AND PAVEMENT MARKING PLAN NORTH QUADRANT SITEWORK AND AUTO PARKING LOT
  - 15 DRAINAGE, FENCE AND UTILITY PLAN
  - 16 STORM SEWER PROFILES
  - 17 WATERMAIN PLAN AND PROFILE - SHEET 1
  - 18 WATERMAIN PLAN AND PROFILE - SHEET 2
  - 19 DRAINAGE DETAILS - SHEET 1
  - 20 DRAINAGE DETAILS AND SCHEDULE - SHEET 2
  - 21 PRECAST BOX CULVERT DETAILS
  - 22 ELECTRICAL DETAILS - SHEET 1
  - 23 ELECTRICAL DETAILS - SHEET 2
  - 24 ELECTRICAL DETAILS - SHEET 3
  - 25 ELECTRICAL DETAILS - SHEET 4
  - 26 WATERMAIN DETAILS
  - 27 FENCING DETAILS
  - 28 ELECTRIC GATE DETAILS
  - 29 MISCELLANEOUS DETAILS
  - 30 EXISTING CONDITIONS / PROPOSED REMOVALS TAXIWAY G2 EXTENSION
  - 31 PLAN AND PROFILE TAXIWAY G2 STA. 311+00 TO STA. 319+00
  - 32 GRADING PLAN TAXIWAY G2 EXTENSION
  - 33 LIGHTING AND PAVEMENT MARKING PLAN TAXIWAY G2 EXTENSION
  - 34 INDEX TO CROSS SECTIONS / EARTHWORK SUMMARY
  - 35 CROSS SECTIONS STA. 312+00 TO STA. 314+00
  - 36 CROSS SECTIONS STA. 314+11.80 TO STA. 316+00
  - 37 CROSS SECTIONS STA. 316+50 TO STA. 318+00
  - 38 CROSS SECTIONS STA. 318+38.80 TO STA. 319+36
  - 39 CROSS SECTIONS STA. 319+63.30 TO STA. 320+73.50
  - 40 CROSS SECTIONS STA. 320+90 TO STA. 321+14.08
  - 41 CROSS SECTIONS STA. 321+26.09 TO STA. 321+57.09
  - 42 CROSS SECTIONS STA. 321+88.06 TO STA. 322+19.08
  - 43 CROSS SECTIONS STA. 322+50.09 TO STA. 323+89.00
  - 44 CROSS SECTIONS STA. 323+95.18 TO STA. 325+04.67
  - 45 ENGINEERING INFORMATION - SHEET 1
  - 46 ENGINEERING INFORMATION - SHEET 2
  - 47 GLENWOOD-LANSING ROAD INTERSECTION IMPROVEMENTS
  - 48 INTERSECTION IMPROVEMENTS EXISTING CONDITIONS AND SITE PLAN
  - 49 INTERSECTION IMPROVEMENTS TEMPORARY SIGNAL INSTALLATION
  - 50 INTERSECTION IMPROVEMENTS ELECTRICAL PLAN AND MISCELLANEOUS NOTES AND DETAILS
  - 51 INTERSECTION IMPROVEMENTS TRAFFIC SIGNAL INSTALLATION

SUMMARY OF QUANTITIES

PATH: K:\0051101\sheets\
FILE: qty.dwg
UPDATE BY: tmarin
SURVEY BOOK #
XREF DWG:
XREF DWG:
DATE: Tue 4/23/04 11:16am

Table with columns: ITEM NO., DESCRIPTION, UNIT, TOTAL ESTIMATED QUANTITY, TOTAL RECORD QUANTITY, TAXIWAY G2 EXTENSION, NORTH QUADRANT SITEWORK - PHASE 1, ROADWAY INTERSECTION. Includes items like 1/C #3/0 600 V UG CABLE, 1/C #6 600 V UG CABLE, etc.

Table with columns: ITEM NO., DESCRIPTION, UNIT, TOTAL ESTIMATED QUANTITY, TOTAL RECORD QUANTITY, TAXIWAY G2 EXTENSION, NORTH QUADRANT SITEWORK - PHASE 1, ROADWAY INTERSECTION. Includes items like SODDING, TOPSOILING (FROM ON SITE), MULCHING, ROADWAY LIGHT POLE, etc.

REVISIONS table with columns: NUMBER, BY, DATE. Revision 1 by ARM on 6/10/05.

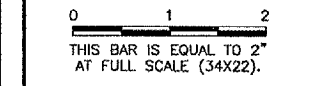

LANSING MUNICIPAL AIRPORT
LANSING, ILLINOIS
NORTH QUADRANT SITEWORK - PHASE 1
AND TAXIWAY G2 EXTENSION
SUMMARY OF QUANTITIES

NOTES:

WORK WITHIN COOK COUNTY RIGHT-OF-WAY SHALL BE PAID FOR UNDER IDOT-STANDARD SPECIFICATIONS FOR ROAD AND BRIDGE CONSTRUCTION SPECIFIED PAY ITEMS EXCEPT FOR THE FOLLOWING:

- ACCESS DRIVE PAVEMENT WITH CURB AND GUTTER
LANDSCAPING AND TOPSOIL PLACEMENT
WATERMAIN INCLUDING BORING AND JACKING

THE ABOVE LISTED ITEMS SHALL BE PAID FOR UNDER IDOT-STANDARD SPECIFICATIONS FOR CONSTRUCTION OF AIRPORTS SPECIFIED PAY ITEMS

CMT logo and contact information: CRAWFORD, MURPHY & TILLY, INC. CONSULTING ENGINEERS License No. 184-000613

Table with design and approval information: DESIGN BY: ARM, DRAWN BY: ARM, CHECKED BY: ARM, APPROVED BY: (blank), DATE: 03/04/05, JOB No: 03297-02, SHEET 2 OF 50 SHEETS

HORIZONTAL/VERTICAL CONTROL					
NO.	STATION/OFFSET	ELEVATION	NORTHING	EASTING	DESCRIPTION
1	311+98.00 @ TAXIWAY G2	-	1775650.38	719616.74	INTERSECTION CENTERLINE TAXIWAY G2 AND CENTERLINE TAXIWAY G3
2	314+48.10 @ TAXIWAY G2	-	1775900.49	719615.00	INTERSECTION CENTERLINE TAXIWAY G2 AND CENTERLINE RUNWAY 9/27
3	316+98.10 @ TAXIWAY G2	-	1776150.48	719613.26	INTERSECTION CENTERLINE TAXIWAY G2 AND CENTERLINE TAXIWAY A
4	318+54.10 @ TAXIWAY G2	-	1776306.46	719612.18	INTERSECTION CENTERLINE TAXIWAY G2 AND APRON BASELINE
5	321+26.10 @ TAXIWAY G2	-	1776578.44	719610.29	INTERSECTION CENTERLINE TAXIWAY G2 AND ENTRANCE ROAD BASELINE
6	318+54.10, 300' RT, @ TAXIWAY G2	-	1776308.55	719912.17	EDGE OF APRON
7	502+28.16, @ ENTRANCE RD.	-	1776580.67	719938.43	ENTRANCE ROAD BASELINE
8	503+44.19, @ ENTRANCE RD.	-	1776696.69	719937.64	INTERSECTION ENTRANCE ROAD BASELINE AND BORROW SITE BASELINE
9	504+14.16, @ ENTRANCE RD.	-	1776766.67	719937.16	ENTRANCE ROAD BASELINE
10	507+66.32, @ ENTRANCE RD.	-	1776995.72	720057.12	INTERSECTION ENTRANCE ROAD BASELINE AND CENTERLINE GLENWOOD-LANSING ROAD
11	505+38.08, @ ENTRANCE RD.	-	1776767.51	720061.07	ENTRANCE ROAD BASELINE
12	18+50, @ BORROW SITE	-	1776703.11	720882.46	END OF BORROW SITE BASELINE
13	507+72.06, 99.53' LT, @ ENTRANCE RD.	-	1776999.75	719957.72	PK NAIL ON GLENWOOD-LANSING ROAD MEDIAN
14	325+30.13, 498.64 LT, @ TAXIWAY G2	-	1776979.01	719108.85	PK NAIL ON GLENWOOD-LANSING ROAD MEDIAN
BM1	3+10.61, 215.31' RT, @ RUNWAY 9/27	613.53	1776979.01	719108.85	AZ MARKER "LANSPORT" (ROD IN CAN)
BM2	23+37.02, 209.83' RT, @ RUNWAY 9/27	613.56	1776979.01	719108.85	MARKER "LANSPORT 1990" (ROD IN CAN)
BM3	37+49.70, 195.54' RT, @ RUNWAY 9/27	613.69	1776979.01	719108.85	GPS IGOA MONUMENT
BM4	146+22.30, 582.00' RT, @ RUNWAY 18/36	614.13	1776979.01	719108.85	CHISELED "X" ON CONCRETE BOX CULVERT

- LEGEND**
- NEW PAVEMENT
  - EXISTING BUILDING
  - EXISTING PAVEMENT
  - PROPOSED BORROW SITE
  - BENCHMARK/CONTROL POINT
  - AIRPORT PROPERTY LINE
  - FUTURE/PROPOSED HANGAR (BY OTHERS)

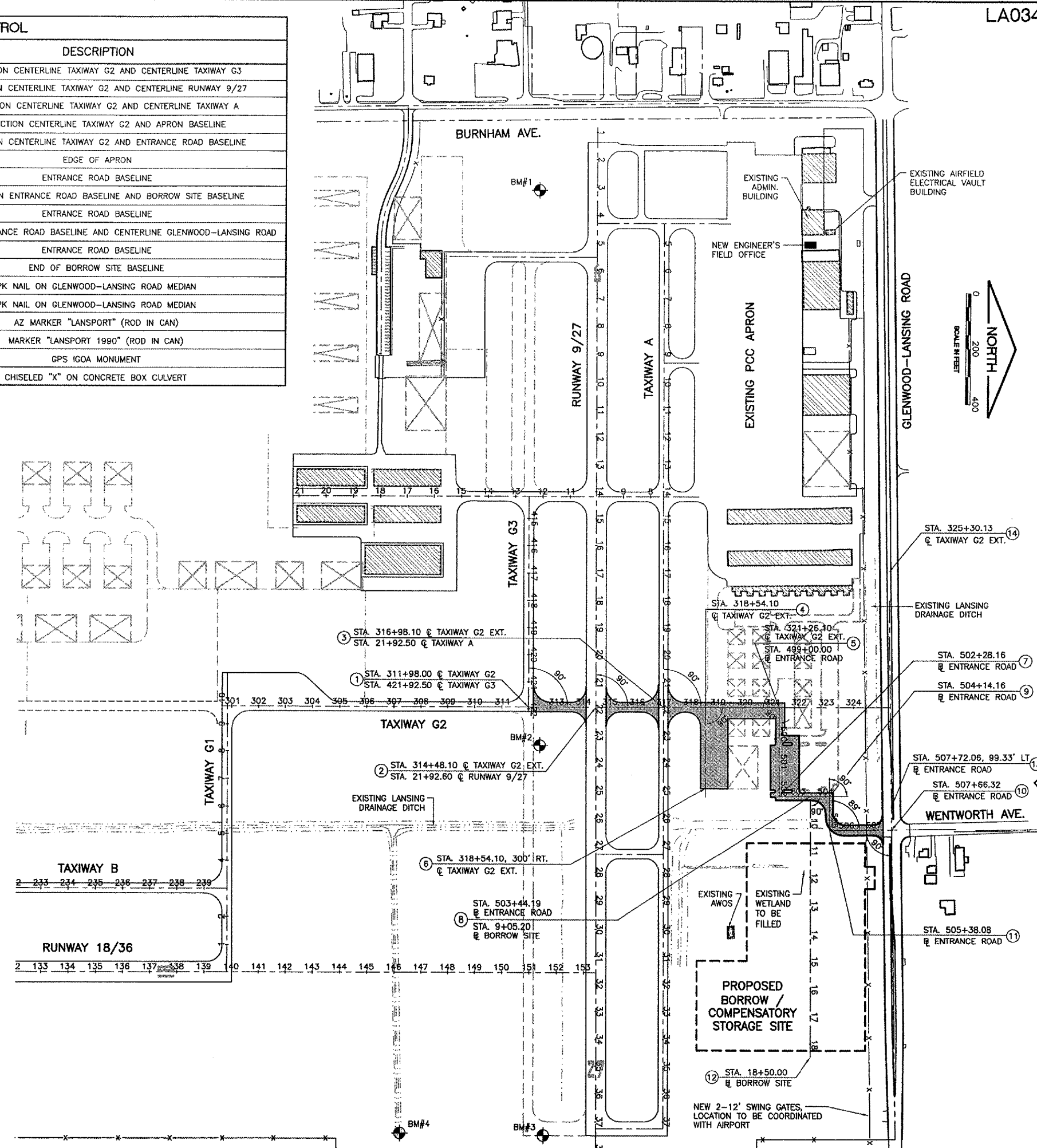

**REVISIONS**

NUMBER	BY	DATE

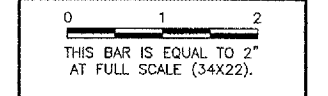

**LANSING MUNICIPAL AIRPORT  
 LANSING, ILLINOIS  
 NORTH QUADRANT SITEWORK - PHASE 1  
 AND TAXIWAY G2 EXTENSION  
 SITE PLAN/HORIZONTAL AND  
 VERTICAL CONTROL PLAN**

**CMT**  
 CRAWFORD, MURPHY & TILLY, INC.  
 CONSULTING ENGINEERS  
 License No. 84-000613

**Lansing Municipal  
 airport**

DESIGN BY: ARM  
 DRAWN BY: JRO  
 CHECKED BY: ARM  
 APPROVED BY:  
 DATE: 03/04/05  
 JOB No: 03297-02

**GENERAL NOTES**

- THE SUGGESTED SEQUENCE OF CONSTRUCTION SHOWN IS INTENDED TO ALLOW FOR THE ORDERLY CONSTRUCTION OF THE PROPOSED IMPROVEMENTS WHILE MAINTAINING AIRCRAFT ACCESS AT ALL TIMES. THE PHASING SHOWN IS A SUGGESTED SEQUENCE OF CONSTRUCTION ONLY. THIS SEQUENCE MAY BE MODIFIED HOWEVER, ALTERNATE STAGING PLANS MUST MAINTAIN AIRPORT OPERATIONS TO THE SATISFACTION OF THE AIRPORT MANAGER AND RESIDENT ENGINEER AND BE APPROVED BY THE DIVISION OF AERONAUTICS AND FEDERAL AVIATION ADMINISTRATION.
- ALL OPERATIONS SHALL BE IN CONFORMANCE WITH AC 150/5370-2E (LATEST EDITION) SAFETY DURING CONSTRUCTION.
- CONTRACTOR'S EQUIPMENT SHALL BE STORED IN THE EQUIPMENT AND MATERIAL STORAGE AREA WHEN CONSTRUCTION IS NOT IN PROGRESS.
- THE AIRPORT MANAGER IN CONSULTATION WITH THE RESIDENT ENGINEER SHALL HAVE FINAL SAY IN THE APPROVAL OF THE CONSTRUCTION OPERATING SEQUENCE AS IT RELATES TO PEDESTRIAN, VEHICULAR AND AIRCRAFT SAFETY.
- ALL EXISTING PAVEMENTS, DRIVES OR ANY OTHER AREAS USED AS A HAUL ROAD OR STORAGE AREA BY THE CONTRACTOR SHALL BE RESTORED IN KIND TO THEIR PRE-CONSTRUCTION CONDITION OR TO THE SATISFACTION OF THE RESIDENT ENGINEER AND AIRPORT MANAGER. THE COST OF MAINTAINING, REPAIRING OR CONSTRUCTING THESE PAVEMENTS AND AREAS SHALL BE INCIDENTAL TO THE CONTRACT. EXISTING AREAS OUTSIDE THE PROJECT LIMITS WHICH ARE DISTURBED BY THE CONTRACTOR'S OPERATIONS SHALL BE RESTORED BY HIM AT HIS EXPENSE TO THE SATISFACTION OF THE RESIDENT ENGINEER AND THE AIRPORT MANAGER.
- THE CONTRACTOR SHALL KEEP ALL TRUCKS, EQUIPMENT AND MATERIALS OFF OF THE EXISTING TAXIWAYS, APRONS AND RUNWAYS OUTSIDE OF THE PROJECT LIMITS EXCEPT AS SHOWN OR WITH THE PRIOR PERMISSION OF THE ENGINEER.
- WORK PERFORMED BY THE CONTRACTOR OUTSIDE OF DAYLIGHT HOURS SHALL BE DONE UNDER SUFFICIENT ARTIFICIAL LIGHTING TO ALLOW FOR PROPER CONSTRUCTION METHODS AND INSPECTIONS. LIGHT SHALL CONSIST OF MOVABLE POLE MOUNTED FLOODLIGHTS AND/OR SPOTLIGHTS OF SUFFICIENT NUMBER TO ILLUMINATE THE WORK AREA. VEHICLE HEADLIGHTS WILL BE ALLOWED ONLY IN ADDITION TO OTHER LIGHTS MENTIONED ABOVE. LIGHTING SHALL BE AS APPROVED BY THE ENGINEER AND SHALL NOT BE USED IF THEY AFFECT FLIGHT SAFETY. CONTRACTOR'S WORK HOURS SHALL BE IN ACCORDANCE WITH LOCAL ORDINANCES.
- THE CONTRACTOR SHALL PROVIDE PORTABLE FLOOD LIGHTING FOR NIGHTTIME CONSTRUCTION. SUFFICIENT UNITS SHALL BE PROVIDED SO THAT WORK AREAS ARE ILLUMINATED TO A LEVEL OF FIVE HORIZONTAL FOOT CANDLES. THE LIGHTING LEVELS SHALL BE CALCULATED AND MEASURED IN ACCORDANCE WITH THE CURRENT STANDARDS OF THE ILLUMINATION ENGINEERING SOCIETY. LIGHTS SHALL BE POSITIONED SO AS NOT TO INTERFERE WITH AIRPORT OPERATIONS.
- THE CONTRACTOR WILL BE REQUIRED TO HAVE A SWEEPER AVAILABLE FOR USE AT ALL TIMES. WHEN ACTIVE AIRFIELD PAVEMENTS ARE UTILIZED AS HAUL ROADS BY THE CONTRACTOR, MATERIAL TRACKED ON TO THE PAVEMENT SHALL BE CONTINUALLY REMOVED WITH SAID SWEEPER. THIS SWEEPING SHALL NOT BE PAID FOR SEPARATELY BUT SHALL BE CONSIDERED INCIDENTAL TO THE CONTRACT.
- MATERIALS REMOVED FROM THE PROJECT WILL BE DISPOSED OF OFF AIRPORT PROPERTY, UNLESS NOTED OTHERWISE.
- FOR WORK ON AIRPORT PROPERTY:** PAYMENT FOR TRAFFIC CONTROL INCLUDING, BUT NOT LIMITED TO BARRICADES, SIGNING, RUNWAY CLOSED MARKERS, AIR OPERATIONS AREA (A.O.A.) LATHE AND RIBBON, ETC. SHALL NOT BE PAID SEPARATELY, BUT SHALL BE CONSIDERED INCIDENTAL TO THE CONTRACT. BARRICADES AT 10-FOOT CENTERS WITH ONE ORANGE FLAG (24" x 24") BETWEEN EACH SET OF BARRICADES SHALL BE PLACED AT THE LOCATIONS SHOWN ON THE PLANS OR AS DIRECTED BY THE ENGINEER. BARRICADES SHALL BE WEIGHED TO PREVENT BLOWING OVER. BARRICADES SHALL HAVE A FLASHING RED LIGHT AND CONFORM TO DOT STANDARD 702001, TYPE II. BARRICADE INSTALLATION WILL BE REQUIRED PRIOR TO ACCESS TO THE A.O.A. BY CONTRACTOR'S WORKERS. EQUIPMENT OR MATERIAL SIGNS SHALL BE PLACED AT EACH TAXIWAY/RUNWAY CLOSURE LOCATION AND SHALL BE ATTACHED TO THE BARRICADES. EACH BARRICADE LOCATION SHALL CONSIST OF ONE "DO NOT ENTER" SIGN AND ONE "AIRCRAFT MOVEMENT AREA" SIGN. SIGNS SHALL BE CONSIDERED INCIDENTAL TO THE CONTRACT.
- THE CONTRACTOR SHALL CONTACT THE AIRPORT MANAGER (5) WORKING DAYS IN ADVANCE OF THE START OF CONSTRUCTION SO THAT THE APPROPRIATE NOTAMS MAY BE ISSUED.
- THE CONTRACTOR SHALL BE RESPONSIBLE FOR KEEPING ALL CONSTRUCTION ACCESS GATES CLOSED DURING NON WORKING HOURS. THE CONTRACTOR SHALL PROVIDE A SIGN AT THE ACCESS GATE SAYING "AUTHORIZED PERSONNEL ONLY". THE CONTRACTOR SHALL CLOSE AND LOCK THE ACCESS GATE UPON LEAVING THE SITE. THROUGHOUT THE DURATION OF THE CONTRACT, ANY DAMAGES TO THE ACCESS ROAD, ACCESS GATE OR FENCING ADJACENT TO THE PROJECT SHALL BE REPAIRED BY THE CONTRACTOR TO THE SATISFACTION OF THE RESIDENT ENGINEER. ALL COST RELATING TO CONTRACTOR'S ACCESS AND SECURITY SHALL BE THE RESPONSIBILITY OF THE CONTRACTOR.
- CONTRACTOR WILL BE REQUIRED TO PUT AIRPORT FLAGS AND HAVE BEACON LIGHTS ON ALL EQUIPMENT AT ALL TIMES DURING CONSTRUCTION. SEE FLAG DETAIL, THIS SHEET.
- IN THE CASE OF AN EMERGENCY, CONTRACTOR SHALL NOTIFY AIRPORT MANAGER AND THE ENGINEER IMMEDIATELY.
- DURING ADVERSE WEATHER, THE CONTRACTOR SHALL MAKE PROVISIONS FOR ACCESS TO THE WORK AT NO ADDITIONAL COST TO THE CONTRACT. NO EXTENSION OF CONTRACT TIME WILL BE CONSIDERED FOR DELAYS DUE TO LACK OF ADEQUATE ACCESS TO THE WORK.
- THE TALLEST PIECE OF CONSTRUCTION EQUIPMENT IS ANTICIPATED TO BE AN ASPHALT/STONE TRUCK WHICH HAS A MAXIMUM HEIGHT OF 18 FEET IN A DUMP POSITION.
- IF RUNWAY NUMERALS ARE PRESENT DURING CONSTRUCTION THEN CONTRACTOR SHALL PLACE CLOSED RUNWAY MARKER OVER NUMERALS AS DETAILED, OTHERWISE PLACE RUNWAY CLOSED MARKER IN TURF AT ENDS OF RUNWAY AS DETAILED.
- LANSING MUNICIPAL AIRPORT WILL BE IN OPERATION DURING THE CONSTRUCTION OF THIS PROJECT. COORDINATION OF WORK WITH THE AIRPORT IS MANDATORY SO AS TO MINIMIZE IMPACTS ON AIRPORT OPERATIONS.
- APPROXIMATE LOCATION OF HAUL ROUTES ON THE AIRPORT SITE ARE SHOWN ON THE GENERAL PROJECT LAYOUT AND THE PHASING PLANS. IT SHALL BE THE CONTRACTOR'S RESPONSIBILITY TO COORDINATE OFF-SITE HAUL ROUTES (STATE HIGHWAYS, COUNTY ROADS OR CITY STREETS) WITH THE APPROPRIATE OWNER WHO HAS JURISDICTION OVER THE AFFECTED ROUTE. ON-SITE ROADS USED AS HAUL ROUTES SHALL BE MAINTAINED BY THE CONTRACTOR AND SHALL BE RESTORED AT THE CONTRACTOR'S EXPENSE TO THEIR ORIGINAL CONDITION UPON COMPLETION OF BEING USED AS A HAUL ROUTE. THE BEFORE AND AFTER CONDITION OF ON-SITE HAUL ROUTES SHALL BE JOINTLY INSPECTED AND DETERMINED BY THE CONTRACTOR AND THE ENGINEER. FENCING, DRAINAGE, GRADING AND OTHER MISCELLANEOUS CONSTRUCTION REQUIRED TO CONSTRUCT TEMPORARY HAUL ROUTES OR ACCESS POINTS ON THE AIRPORT WILL BE THE CONTRACTOR'S TOTAL RESPONSIBILITY AND SHALL BE APPROVED BY THE ENGINEER PRIOR TO THE WORK. ALL ON-SITE ACCESS ROADS TO AIRPORT FACILITIES SHALL REMAIN OPEN AND MAINTAINED AT ALL TIMES.

- MOBILIZATION/EQUIPMENT STORAGE AREA WILL BE MADE AVAILABLE FOR CONTRACTOR'S MOBILIZATION AND STORAGE AS SHOWN ON THE PLANS. THIS AREA SHALL BE RESTORED TO THE ORIGINAL CONDITION UPON COMPLETION OF THE PROJECT AT THE CONTRACTOR'S EXPENSE.
- LOCATION OF KNOWN EXISTING AIRPORT UNDERGROUND CABLES ARE SHOWN ON THE PLANS AND MUST BE VERIFIED BY THE CONTRACTOR. REPAIR OF DAMAGED CABLE MUST BE STARTED IMMEDIATELY AND CONTINUED UNTIL COMPLETED. ALL SUCH REPAIRS SHALL BE IN ACCORDANCE WITH THE SPECIFICATIONS, OR AS DIRECTED BY THE OWNER OF THE CABLE, AND SHALL BE AT THE CONTRACTOR'S EXPENSE. IF FAA CABLES ARE DAMAGED, REPAIRS SHALL BE DONE FROM POINT TO POINT IN ACCORDANCE WITH FAA REQUIREMENTS AND IN THE PRESENCE OF A FAA REPRESENTATIVE. THE OWNER MAY ELECT TO HAVE THE REPAIR PERFORMED BY OTHERS IN WHICH CASE THE CONTRACTOR SHALL BE RESPONSIBLE FOR PAYING THE INCURRED COSTS OF REPAIRS.
- COORDINATION MEETINGS - THE CONTRACTOR SHALL CONDUCT WEEKLY COORDINATION MEETINGS TO DISCUSS WORK AREAS AND SCHEDULING, ETC. WITH THE ENGINEER, AIRPORT OPERATIONS, FAA, AND OTHER APPROPRIATE OFFICIALS. MINUTES FROM THE WEEKLY MEETINGS SHALL BE PREPARED BY THE CONTRACTOR, FURNISHED TO ALL ATTENDEES PRIOR TO THE SUBSEQUENT MEETING, AND KEPT ON FILE AT THE FIELD OFFICE. THE COORDINATION MEETING COSTS SHALL BE CONSIDERED INCIDENTAL TO THE PROJECT.
- THE CONTRACTOR SHALL PROVIDE THE PHONE NUMBERS OF THREE PERSONNEL, INCLUDING THE PROJECT SUPERINTENDENT, WHO MAY BE CONTACTED IN AN EMERGENCY. PERSONNEL SHALL BE ON CALL 24 HOURS PER DAY FOR MAINTAINING AIRPORT HAZARD LIGHTING AND BARRICADES.
- DRAINAGE MODIFICATIONS SHALL BE SEQUENCED TO PROVIDE POSITIVE DRAINAGE AT ALL TIMES AT NO ADDITIONAL COST TO THE CONTRACT. EXISTING LANSING DRAINAGE FLOWS SHALL BE MAINTAINED THROUGHOUT CONSTRUCTION.
- VEHICLES AND EQUIPMENT SHALL NOT BE ALLOWED WITHIN 65' FROM ACTIVE TAXIWAYS AND 125' FROM ACTIVE RUNWAYS UNLESS OTHERWISE APPROVED BY THE AIRPORT MANAGER.
- CONTRACTOR SHALL STORE EQUIPMENT AND MATERIALS IN SUCH A MANNER AS NOT TO VIOLATE FEDERAL AVIATION ADMINISTRATION PART 77 SURFACES OR RUNWAY AND TAXIWAY SAFETY AREAS.
- ALL EXISTING TAXIWAY AND RUNWAY AIRFIELD LIGHTING CIRCUITS, FAA CABLES AND OTHER ELECTRICAL CABLES SHALL REMAIN IN SERVICE AT ALL TIMES. ALL EXISTING LIGHTING AND VAULT EQUIPMENT SHALL REMAIN IN SERVICE UNTIL PROPOSED IMPROVEMENTS ARE INSTALLED AND OPERATIONAL, UNLESS OTHERWISE APPROVED BY THE ENGINEER. ANY CABLES DAMAGED BY THE CONTRACTOR SHALL BE IMMEDIATELY REPAIRED AT HIS EXPENSE.
- COORDINATION BY THE CONTRACTOR WITH THE EXISTING UTILITIES SHALL BE COMPLETED BEFORE CONSTRUCTION IS STARTED. CONTRACTOR IS REFERRED TO SECTION 50-17 OF THE SPECIAL PROVISIONS FOR SPECIFIC REQUIREMENTS. THE LOCATION OF UNDERGROUND UTILITIES AS INDICATED ON THE PLANS HAS BEEN OBTAINED FROM EXISTING RECORDS. NEITHER THE OWNER OR THE DESIGN ENGINEER ASSUME ANY RESPONSIBILITY WHATSOEVER IN RESPECT TO THE ACCURACY, COMPLETENESS OR SUFFICIENCY OF THE INFORMATION. THERE IS NO GUARANTEE, EITHER EXPRESSED OR IMPLIED THAT THE LOCATIONS, SIZE AND TYPE MATERIAL OF EXISTING UNDERGROUND UTILITIES AS INDICATED ARE REPRESENTATIVE OF THOSE TO BE ENCOUNTERED DURING CONSTRUCTION. IT SHALL BE THE CONTRACTOR'S RESPONSIBILITY TO DETERMINE THE ACTUAL LOCATION OF ALL SUCH FACILITIES, INCLUDING SERVICE CONNECTIONS TO UNDERGROUND UTILITIES. PRIOR TO CONSTRUCTION, THE CONTRACTOR SHALL NOTIFY THE UTILITY COMPANY OF HIS OPERATIONAL PLANS. THE CONTRACTOR SHALL MAKE ARRANGEMENTS FOR DETAILED INFORMATION AND ASSISTANCE IN LOCATING UTILITIES. IN THE EVENT AN UNEXPECTED UTILITY INTERFERENCE IS ENCOUNTERED DURING CONSTRUCTION, THE CONTRACTOR SHALL IMMEDIATELY NOTIFY THE UTILITY COMPANY, THE RESIDENT ENGINEER AND THE AIRPORT DIRECTOR. ANY SUCH MAINS AND/OR SERVICES DISTURBED BY THE CONTRACTOR'S OPERATIONS SHALL BE RESTORED IMMEDIATELY AT HIS EXPENSE TO THE SATISFACTION OF THE RESIDENT ENGINEER AND AIRPORT MANAGER.
- ALL AIRFIELD LIGHTING AND LIGHTING GUIDANCE SYSTEMS (NAVAIDS) LOCATED WITHIN AND IMMEDIATELY ADJACENT TO THE CONTRACTOR'S WORK ZONE SHALL BE CHECKED FOR OPERATIONAL CONDITION PRIOR TO THE DEPARTURE FROM THE AIRPORT WITH THE AIRPORT MAINTENANCE. ANY DEFICIENCIES IN THESE SYSTEMS DUE TO THE ACTS OF CONTRACTOR OR HIS SUBCONTRACTORS, SUPPLIERS OR CONSULTANTS SHALL BE REPAIRED IMMEDIATELY.

**CONTRACTOR CROSSING RUNWAY AND TAXIWAY AIR OPERATIONS AREA (A.O.A.)**

ANYTIME THE CONTRACTOR IS REQUIRED TO UTILIZE OR CROSS ACTIVE AIRFIELD PAVEMENTS FOR ACCESS TO AND FROM THE WORK ZONE, A FULL TIME CROSSING GUARD IN RADIO CONTACT WITH THE AIR TRAFFIC SHALL BE FURNISHED BY THE CONTRACTOR FOR MOVEMENTS OF VEHICLES OR EQUIPMENT TO AND FROM THE WORK ZONE. THE RADIO OPERATOR SHALL BE FAMILIAR WITH AIRPORT GROUND CONTROL PROCEDURES AND DEMONSTRATE KNOWLEDGE OF SAME TO THE AIRPORT. THE AIRPORT RESERVES THE RIGHT TO APPROVE THE CROSSING GUARDS. THE CONTRACTOR SHALL PROVIDE THEIR OWN RADIOS. THIS COST SHALL BE CONSIDERED INCIDENTAL TO THE CONTRACT. THE CONTRACTOR SHALL BE RESPONSIBLE FOR PAYMENT OF MUNICIPAL FINES (\$500 PER OCCURRENCE) DUE TO AIRFIELD INCURSIONS BY HIS EMPLOYEES, SUBCONTRACTORS, SUPPLIERS, CONSULTANTS AND/OR AGENTS.

ANY PAVEMENT DAMAGED BY CONTRACTOR'S OPERATIONS SHALL BE REPAIRED IMMEDIATELY BY HIM TO THE SATISFACTION OF THE RESIDENT ENGINEER AND AIRPORT MANAGER AT NO ADDITIONAL COST TO THE OWNER. PAVEMENT SHALL BE CONTINUALLY SWEEPED TO PROVIDE DEBRIS FREE SURFACE DURING ALL HAUL ROAD OPERATIONS. THIS COST SHALL NOT BE PAID SEPARATELY BUT SHALL BE CONSIDERED INCIDENTAL TO THE CONTRACT.

WORK WITHIN THE A.O.A. SHALL BE EXPEDITED. ANY DROP OFF SHALL BE ADEQUATELY LIGHTED, SIGNED AND BARRICADED. NO MATERIAL SHALL BE STOCKPILED WITHIN THE A.O.A. SHOULD IT BE NECESSARY FOR THE CONTRACTOR TO TEMPORARILY RELOCATE EQUIPMENT TO ALLOW AIRCRAFT TO PASS, THEY SHALL DO SO AT NO EXTRA COST TO THE PROJECT. THE CONTRACTOR SHALL NOTIFY THE RESIDENT ENGINEER AND AIRPORT MANAGER TWO (2) WORKING DAYS IN ADVANCE OF ANY PLANNED CONSTRUCTION WITHIN THESE LIMITS.

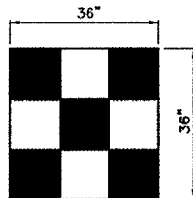

**CONSTRUCTION EQUIPMENT AND TRUCK SIGNAL FLAG**  
NOT TO SCALE

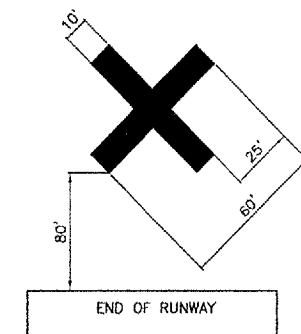

**OFF PAVEMENT CLOSED RUNWAY MARKER DETAIL**  
NO SCALE

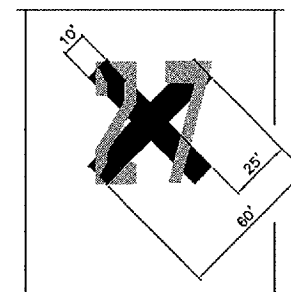

**ON PAVEMENT CLOSED RUNWAY MARKER DETAIL**  
NO SCALE

**CLOSED RUNWAY MARKER DETAIL NOTES**

- CLOSED RUNWAY MARKERS SHALL BE YELLOW.
- MARKERS SHALL BE MATERIAL APPROVED BY THE ENGINEER.
- CONTRACTOR SHALL MAINTAIN AND RELOCATE MARKERS AS SHOWN ON THE PLANS OR AS NEEDED TO FACILITATE CONSTRUCTION
- MARKERS ON PAVEMENT SHALL BE PLACED OVER EXISTING RUNWAY NUMERALS AS SHOWN.
- COST OF FURNISHING, INSTALLING, MAINTAINING AND REMOVING MARKERS SHALL BE CONSIDERED INCIDENTAL TO THE CONTRACT.
- DURING VARIOUS PHASES OF WORK, IT WILL BE NECESSARY TO CLOSE RUNWAYS TO AIR TRAFFIC ON A TEMPORARY BASIS AS COORDINATED WITH THE AIRPORT AND TOWER PERSONNEL. THE CONTRACTOR SHALL MARK THE RUNWAYS TO BE CLOSED BY PLACING A YELLOW CROSS AT THE LOCATION AND DIMENSIONS DETAILED ON THIS SHEET. THE CROSSES ARE SHOWN ON THE RESPECTIVE RUNWAYS ACCORDING TO THE VARIOUS PHASES OF WORK AS DELINEATED IN THE SUGGESTED SEQUENCE OF CONSTRUCTION.

**LIMITATIONS ON CONSTRUCTION WITHIN AIRPORT OPERATIONS AREA (A.O.A.)**

**RUNWAYS:**

ANY WORK WITHIN 125' OF THE CENTERLINE OF AN ACTIVE RUNWAY SHALL EITHER BE DONE ON WEEKENDS, OFF-PEAK DAYTIME OR NIGHTTIME HOURS, LOCAL TIME AS SHOWN ON THE SEQUENCE OF CONSTRUCTION PLAN SHEETS. ON ANY DAY WHEN CONSTRUCTION IS WITHIN 125' OF THE CENTERLINE OF THE RUNWAY, THE RUNWAY SHALL BE CLOSED. THE CONTRACTOR SHALL NOTIFY THE RESIDENT ENGINEER AND AIRPORT MANAGER TWO (2) WORKING DAYS IN ADVANCE OF ANY PLANNED CONSTRUCTION WITHIN THESE LIMITS.

STEEL PLATES IF NECESSARY SHALL BE FURNISHED AND INSTALLED BY THE CONTRACTOR TO COVER ANY OPEN TRENCHES OR EXCAVATION WITHIN THE A.O.A. IF DURING RUNWAY CLOSURE AN EMERGENCY IS DECLARED, THE CONTRACTOR SHALL IMMEDIATELY CLEAR THE RUNWAY OF ALL VEHICLES, MEN AND EQUIPMENT.

**TAXIWAYS / TAXILANES / APRONS:**

CONSTRUCTION WILL BE ALLOWED UP TO THE EDGE OF PAVEMENTS WITHOUT CLOSURE ON A LIMITED BASIS. WORK WITHIN THE A.O.A. SHALL BE EXPEDITED. ANY DROP OFF SHALL BE ADEQUATELY LIGHTED, SIGNED AND BARRICADED. NO MATERIAL SHALL BE STOCKPILED WITHIN THE A.O.A. SHOULD IT BE NECESSARY FOR THE CONTRACTOR TO TEMPORARILY RELOCATE EQUIPMENT TO ALLOW AIRCRAFT TO PASS, THEY SHALL DO SO AT NO EXTRA COST TO THE PROJECT. THE CONTRACTOR SHALL NOTIFY THE RESIDENT ENGINEER AND AIRPORT MANAGER TWO (2) WORKING DAYS IN ADVANCE OF ANY PLANNED CONSTRUCTION WITHIN THESE LIMITS.

**NOTE - ALL PHASES**

ALL EXISTING TAXIWAY AND RUNWAY AIRFIELD LIGHTING CIRCUITS, FAA CABLES AND OTHER AIRPORT ELECTRICAL CABLES SHALL REMAIN IN SERVICE UNTIL REPLACED AS ACCEPTABLE TO THE RESIDENT ENGINEER. ALL TEMPORARY CABLING AND SPLICING NECESSARY TO KEEP THE CIRCUITS IN OPERATION SHALL BE CONSIDERED INCIDENTAL TO CONTRACT.

LA034

PATH: K:\0329702\sheet\ FILE: seqnotes.dwg UPDATE BY: johse SURVEY BOOK # XREF DWG: XREF DWG: DATE: Fri 3/26/04 2:50pm

**DESIGN AIRCRAFT APPROACH CATEGORY: B**  
**DESIGN AIRPORT GROUP: II**

MAXIMUM ANTICIPATED HEIGHT OF CONSTRUCTION EQUIPMENT: 20'

**POINT "A"**  
NEAREST POINT ON CONSTRUCTION SITE TO ACTIVE RUNWAY 9/27  
LATITUDE: 41°32'23.21"N (NAD 83)  
LONGITUDE: 87°31'52.28"W (NAD 83)  
EXISTING ELEVATION: 614.11

**POINT "B"**  
NEAREST POINT ON CONSTRUCTION SITE TO ACTIVE RUNWAY 18/36 OFFSET FROM CENTERLINE EXTENDED  
LATITUDE: 41°32'21.27"N (NAD 83)  
LONGITUDE: 87°31'47.68"W (NAD 83)  
EXISTING ELEVATION: 614.00

**POINT "C"**  
NEAREST POINT ON CONSTRUCTION SITE TO ACTIVE RUNWAY 18/36 OFFSET FROM CENTERLINE EXTENDED  
LATITUDE: 41°32'27.25"N (NAD 83)  
LONGITUDE: 87°31'39.54"W (NAD 83)  
EXISTING ELEVATION: 613.80

**REVISIONS**

NUMBER	BY	DATE

0 1 2  
THIS BAR IS EQUAL TO 2' AT FULL SCALE (34X22).

CONTRACTOR SHALL PLAN AND PERFORM HIS WORK SO AS NOT TO INTERFERE OR HINDER THE PROGRESS, WORK OR HAUL ROAD ACCESS OF OTHER CONTRACTORS (SEE SPECIAL PROVISIONS SECTION 30-05). THE PRIME CONTRACTOR WILL BE RESPONSIBLE TO COORDINATE CONSTRUCTION ACTIVITIES AND ACCESS BETWEEN ALL ON-SITE CONTRACTORS SUBCONTRACTORS. IT IS NOT ANTICIPATED THE FOLLOWING PROJECTS MAY BE UNDER CONSTRUCTION CONCURRENTLY WITH THIS PROJECT.

- HANGAR CONSTRUCTION AT MAIN APRON.
- HANGAR CONSTRUCTION AT NORTH QUADRANT SITEWORK.
- RUNWAY 36 LOCATOR INSTALLATION.

**LANSING MUNICIPAL AIRPORT**  
**LANSING, ILLINOIS**  
**NORTH QUADRANT SITEWORK - PHASE 1**  
**AND TAXIWAY G2 EXTENSION**  
**SEQUENCE OF CONSTRUCTION**  
**GENERAL NOTES AND DETAILS**

© Copyright, CMT, Inc.  
**CMT**  
CRAWFORD, MURPHY & TILLY, INC.  
CONSULTING ENGINEERS  
License No. 184-000613



DESIGN BY:	ARM
DRAWN BY:	JRO
CHECKED BY:	ARM
APPROVED BY:	
DATE:	03/04/05
JOB No:	03297-02
IL PROJECT: IGQ-3329 A.I.P. PROJECT: 3-17-0121-821	
SHEET 4 OF 50 SHEETS	



**SUGGESTED SEQUENCE OF CONSTRUCTION**

**PHASE 1 - NORTH QUADRANT SITING**

- PLACE BARRICADES AS SHOWN OR AS DIRECTED BY THE ENGINEER.
- MARK AIR OPERATIONS AREA (A.O.A.) WITH LATHE AND RIBBON AS SHOWN OR AS DIRECTED BY THE ENGINEER.
- INSTALL SILT FENCE.
- CONSTRUCT STABILIZED CONSTRUCTION ENTRANCE.
- CONSTRUCT TEMPORARY DITCH CROSSING.
- STRIP TOPSOIL AND PLACE EMBANKMENT FILL.
- PLACE STORM SEWER AND UNDERGROUND UTILITIES.

**PHASE 2 - NORTH QUADRANT SITING/TAXIWAY G2**

- COORDINATE CLOSURE OF RUNWAY 9/27 AND TAXIWAY A WITH ENGINEER. PLACE CLOSED RUNWAY MARKERS AND BARRICADES AS SHOWN OR AS DIRECTED BY THE ENGINEER.
- STRIP TOPSOIL AND PLACE EMBANKMENT FILL FOR TAXIWAY G2.
- PLACE STORM SEWER AND UNDERGROUND UTILITIES FOR TAXIWAY G2.
- PLACE STONE BASE/BITUMINOUS BASE COURSE/BITUMINOUS SURFACE COURSE.
- PLACE LIGHTING, PAVEMENT MARKING AND TOPSOILING.
- PLACE SEEDING AND MULCHING.
- CLEAN PAVEMENTS AND REMOVE BARRICADES FOR TAXIWAY G2.
- OPEN RUNWAY 9/27, TAXIWAY A, TAXIWAY G2 AND NORTH QUADRANT PAVEMENTS.

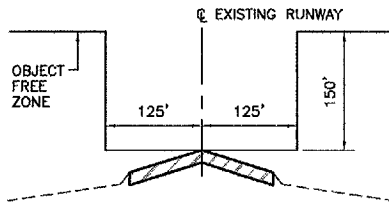

**TYPICAL SECTION  
OBSTACLE FREE ZONE (OFZ)**

NOT TO SCALE

CONTRACTOR SHALL NOT WORK WITHIN THE RUNWAY OBSTACLE FREE ZONE WHILE THE RUNWAY IS OPEN TO AIR TRAFFIC.

WORK AREA	ALLOWABLE WORK PERIODS	OPERATIONAL STATUS/RESTRICTIONS
WORK WITHIN TAXIWAY/APRON AIR OPERATIONS AREA (PHASE 1 AND 2)	NO RESTRICTIONS - WORK SHALL BE EXPEDITED TO SATISFACTION OF AIRPORT MANAGER	RUNWAY 9/27 OPEN - IN PHASE 1 TEMPORARY CLOSURES OF TAXIWAYS/APRONS TO BE APPROVED BY AIRPORT MANAGER
WORK WITHIN RUNWAY 9/27 AND TAXIWAY A AND G3 AIR OPERATIONS AREA (PHASE 2)	WORK SHALL BE EXPEDITED TO SATISFACTION OF AIRPORT MANAGER	RUNWAY 9/27 - CLOSED TAXIWAY A - CLOSED TAXIWAY C,G2,G3 - OPEN
WORK OUTSIDE ALL AIR OPERATIONS AREA (PHASE 1 AND 2)	NO RESTRICTIONS	RUNWAY AND TAXIWAY OPEN
GLENWOOD-LANSING ROAD INTERSECTION IMPROVEMENTS (PHASE 2)	WORK SHALL BE COMPLETED WITHIN 30 CALENDAR DAYS AFTER IMPROVEMENTS BEGIN (SEE NOTE 6)	GLENWOOD-LANSING ROAD RESTRICTIONS AS REQUIRED BY COOK COUNTY

**NOTES**

- CONTRACTOR SHALL STAGE HIS OPERATIONS SO THAT THE EMBANKMENT FILL FOR THE PROPOSED HANGAR PADS IS COMPLETED BEFORE THE REMAINING PORTIONS OF EMBANKMENT FILL OUTSIDE OF THESE AREAS.
- CONTRACTOR SHALL COORDINATE HIS WORK WITH THE BUILDING CONTRACTOR FOR THE INSTALLATION OF THE PROPOSED HANGAR FOUNDATION AND FLOOR PLACEMENT (BY OTHERS) AT NO ADDITIONAL COST TO THE CONTRACT.
- IF REQUIRED CONTRACTOR SHALL OBTAIN NECESSARY PERMITS TO CONSTRUCT TEMPORARY DITCH CROSSING. CONTRACTOR SHALL COORDINATE WITH ILLINOIS DEPARTMENT OF TRANSPORTATION, OFFICE OF WATER RESOURCES. TEMPORARY DITCH CROSSING SHALL COMPLY WITH ALL REQUIREMENTS SET FORTH BY THE NATURAL RESOURCES CONSERVATION SERVICES, ILLINOIS URBAN MANUAL, TEMPORARY STREAM CROSSING. (COST SHALL BE INCIDENTAL TO THE CONTRACT).
- CONTRACTOR SHALL CONSTRUCT STABILIZED CONSTRUCTION ENTRANCE AS SHOWN IN THE STORM WATER POLLUTION PREVENTION PLAN DETAILS. (COST SHALL BE INCIDENTAL TO CONTRACT).
- CONTRACTOR SHALL HAVE DEDICATED FLAGGER ONSITE WHEN WORKING WITHIN TAXIWAY G3 A.O.A. AND YIELD TO ALL ONCOMING AIRCRAFT (COST SHALL BE INCIDENTAL TO CONTRACT).
- CONTRACTOR SHALL OBTAIN ALL PERMITS FROM COOK COUNTY DEPARTMENT OF HIGHWAYS FOR ALL WORK WITHIN THE COUNTY'S RIGHT-OF-WAY (COST SHALL BE INCIDENTAL TO CONTRACT).
- CONTRACTOR SHALL SEQUENCE THEIR WORK WITHIN RUNWAY 9/27 AND TAXIWAY A AIR OPERATIONS AREA TO MINIMIZE CLOSURE TIME OF RUNWAY 9/27 AND TAXIWAY A.

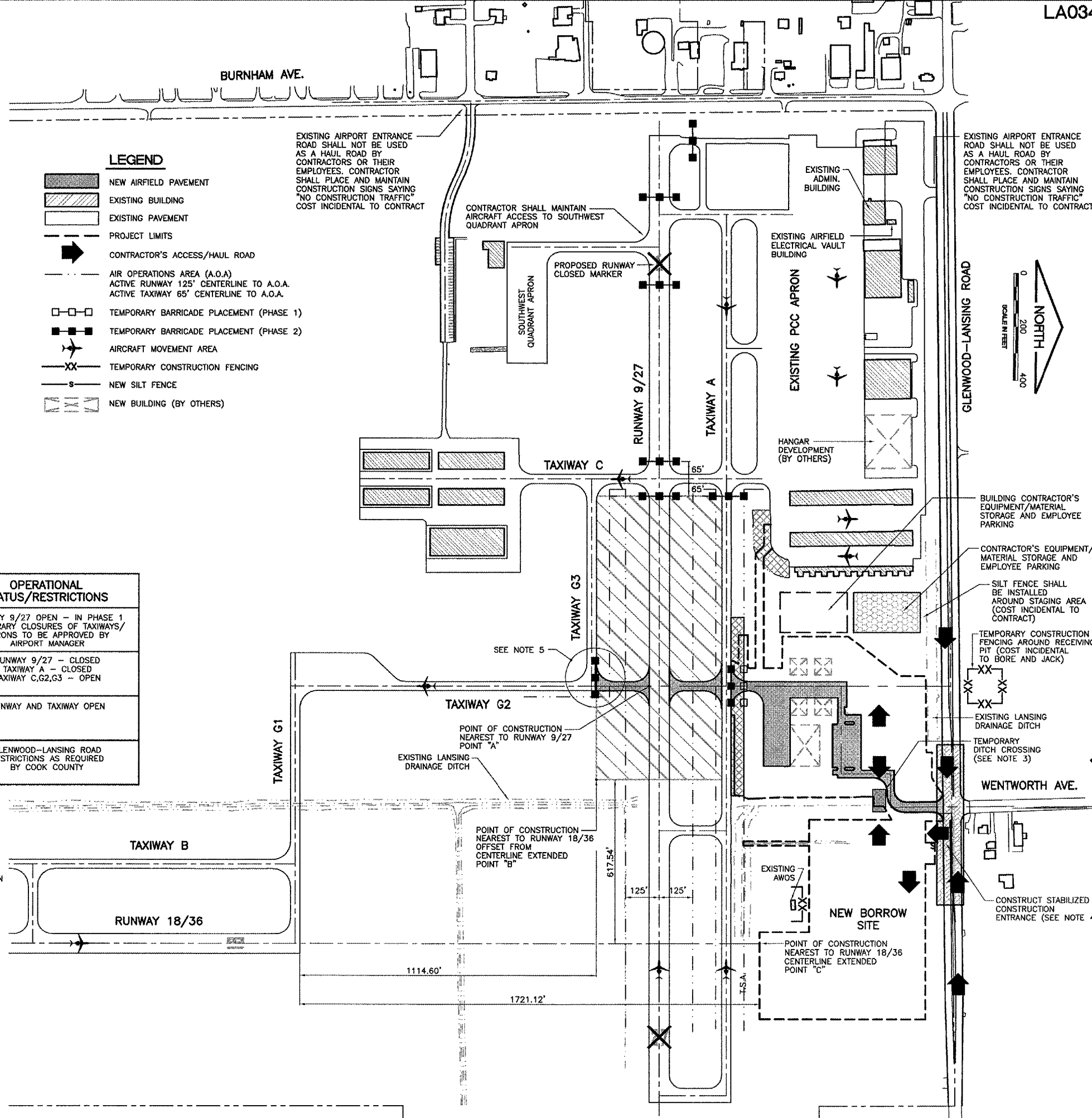

**LEGEND**

- NEW AIRFIELD PAVEMENT
- EXISTING BUILDING
- EXISTING PAVEMENT
- PROJECT LIMITS
- CONTRACTOR'S ACCESS/HAUL ROAD
- AIR OPERATIONS AREA (A.O.A)  
ACTIVE RUNWAY 125' CENTERLINE TO A.O.A.  
ACTIVE TAXIWAY 65' CENTERLINE TO A.O.A.
- TEMPORARY BARRICADE PLACEMENT (PHASE 1)
- TEMPORARY BARRICADE PLACEMENT (PHASE 2)
- AIRCRAFT MOVEMENT AREA
- TEMPORARY CONSTRUCTION FENCING
- NEW SILT FENCE
- NEW BUILDING (BY OTHERS)

EXISTING AIRPORT ENTRANCE ROAD SHALL NOT BE USED AS A HAUL ROAD BY CONTRACTORS OR THEIR EMPLOYEES. CONTRACTOR SHALL PLACE AND MAINTAIN CONSTRUCTION SIGNS SAYING "NO CONSTRUCTION TRAFFIC" COST INCIDENTAL TO CONTRACT

CONTRACTOR SHALL MAINTAIN AIRCRAFT ACCESS TO SOUTHWEST QUADRANT APRON

EXISTING AIRPORT ENTRANCE ROAD SHALL NOT BE USED AS A HAUL ROAD BY CONTRACTORS OR THEIR EMPLOYEES. CONTRACTOR SHALL PLACE AND MAINTAIN CONSTRUCTION SIGNS SAYING "NO CONSTRUCTION TRAFFIC" COST INCIDENTAL TO CONTRACT

LA034  
 PATH: K:\LansingAp\0329702\draw\st  
 FILE: seq.dwg  
 UPDATE BY: johse  
 SURVEY BOOK #  
 XREF DWG:  
 XREF DWG:  
 DATE: Wed 5/5/04 2:26pm

**REVISIONS**

NUMBER	BY	DATE
1	ARM	6/10/05

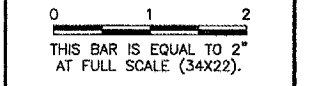

**LANSING MUNICIPAL AIRPORT  
LANSING, ILLINOIS**

**NORTH QUADRANT SITING - PHASE 1  
AND TAXIWAY G2 EXTENSION**

**SEQUENCE OF CONSTRUCTION  
PER AC 150/5370-2E (LATEST EDITION)**

© Copyright CMT, Inc.

**CMT**  
CRAWFORD, MURPHY & TILLY, INC.  
CONSULTING ENGINEERS  
License No. 94-000613

**Lansing Municipal  
airport**

DESIGN BY:	ARM
DRAWN BY:	JRO
CHECKED BY:	ARM
APPROVED BY:	
DATE:	03/04/05
JOB No:	03297-02
IL PROJECT: IGQ-3329 A.I.P. PROJECT: 3-17-0121-B21	
SHEET 5 OF 50 SHEETS	

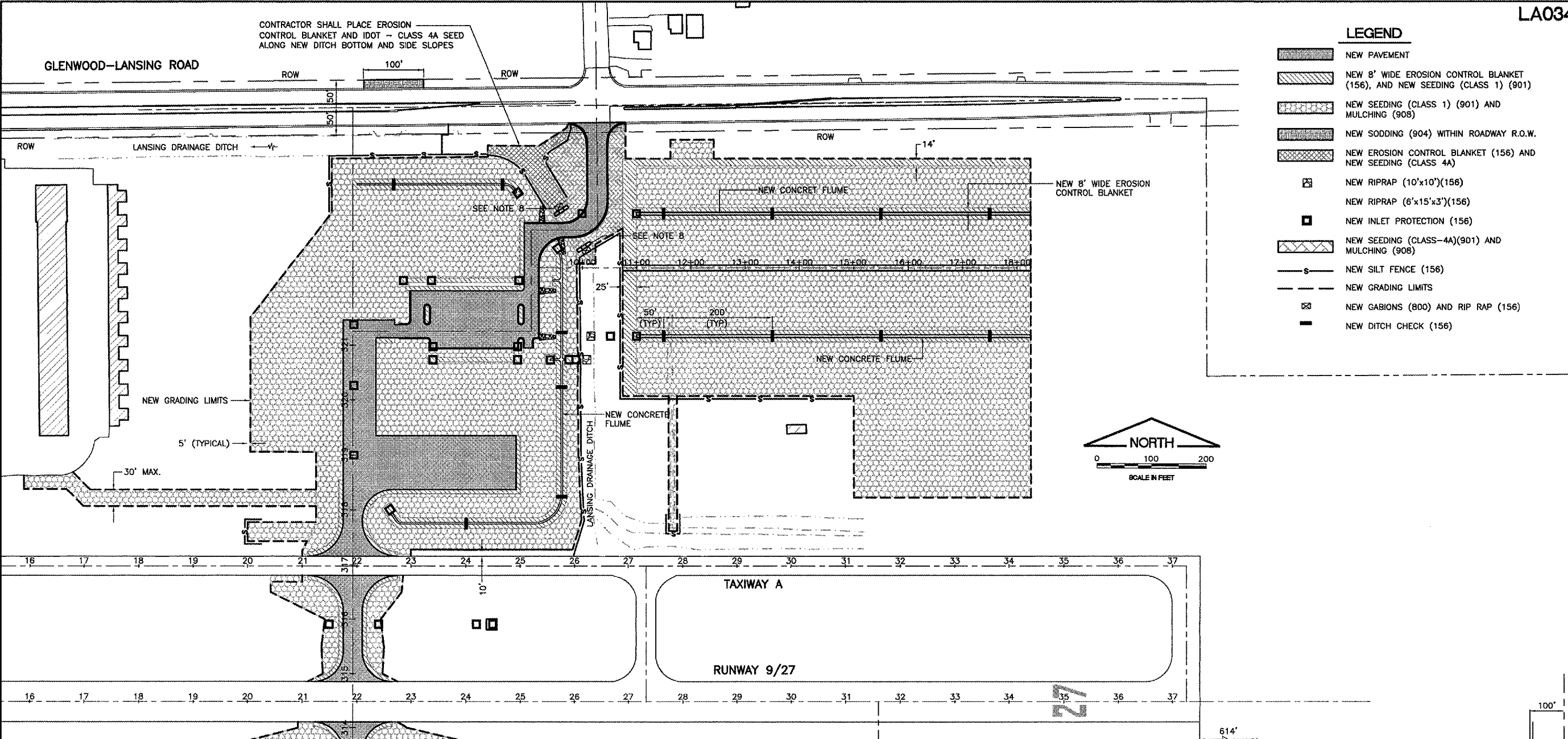

- LEGEND**
- NEW PAVEMENT
  - NEW 8' WIDE EROSION CONTROL BLANKET (156), AND NEW SEEDING (CLASS 1) (901)
  - NEW SEEDING (CLASS 1) (901) AND MULCHING (908)
  - NEW SODDING (904) WITHIN ROADWAY R.O.W.
  - NEW EROSION CONTROL BLANKET (156) AND NEW SEEDING (CLASS 4A)
  - NEW RIPRAP (10'x10')(156)
  - NEW RIPRAP (6'x15'x3')(156)
  - NEW INLET PROTECTION (156)
  - NEW SEEDING (CLASS-4A)(901) AND MULCHING (908)
  - NEW SILT FENCE (156)
  - NEW GRADING LIMITS
  - NEW GABIONS (800) AND RIP RAP (156)
  - NEW DITCH CHECK (156)

**REVISIONS**

NUMBER	BY	DATE
1	ARM	6/10/05

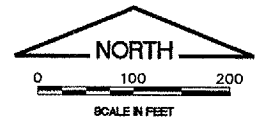
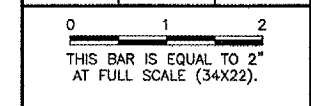

**SEED TABLE**

IDOT CLASS--TYPE	SEED MIXTURE	RATE (LB/ACRE)
1 (LAWN MIXTURE)	KENTUCKY BLUEGRASS	100
	PERENNIAL RYEGRASS	60
	CREeping RED FESCUE	40
4A (LOW PROFILE NATIVE GRASS)	LITTLE BLUE STEM	5
	SIDE-OATS GRAMA	5
	WILD RYE	1
	PRAIRIE DROPSEED	0.5
	ANNUAL RYEGRASS	25
	OATS, SPRING PERENNIAL RYEGRASS	15

- NOTES**
- BALES SHALL BE PLACED AROUND ALL STORM SEWER INLETS AS DETAILED ON THE PLANS TO MINIMIZE SOIL INTRUSION INTO THE STORM SEWER SYSTEM.
  - THE CONTRACTOR SHALL BE REQUIRED TO COMPLY WITH THE REQUIREMENTS OF THE NATIONAL POLLUTANT DISCHARGE ELIMINATION SYSTEM (NPDES) STORM WATER PERMIT FOR CONSTRUCTION SITE ACTIVITIES.
  - ALL PROJECT AREAS, INCLUDING STOCKPILES, ABANDONED HAUL ROADS AND STAGING AREAS, AS SHOWN ON THE PLANS, SHALL HAVE 4 INCHES OF TOPSOIL PLACED AND BE SEEDED AND MULCHED IN ACCORDANCE WITH THE SPECIFICATIONS. AREAS DISTURBED OUTSIDE THE PROJECT LIMITS WILL BE SEEDED AND MULCHED BY THE CONTRACTOR AT HIS COST AND RESTORED TO ORIGINAL CONDITIONS.
  - FOR DETAILS, SEE STORMWATER POLLUTION PREVENTION NOTES AND DETAILS SHEET.
  - FOR EXACT LOCATIONS OF INLETS, SEE EXISTING CONDITIONS/PROPOSED REMOVALS SHEET AND GRADING AND DRAINAGE PLANS.
  - SEDIMENT AND EROSION CONTROL MEASURES SHALL BE INSPECTED ON A WEEKLY BASIS AND AFTER EACH 1/2" RAIN EVENT.
  - THE CONTRACTOR SHALL HAVE A COPY OF THE APPROVED EROSION AND SEDIMENT CONTROL PLAN ON THE SITE AT ALL TIMES.
  - SEE PRECAST BOX CULVERT DETAILS FOR GABION AND RIP RAP PLACEMENT FOR PRECAST CONCRETE BOX CULVERT END SECTIONS.

PROPOSED EARTHWORK STOCKPILE  
 EXACT LOCATION TO BE FIELD DETERMINED BY ENGINEER

**LANSING MUNICIPAL AIRPORT  
 LANSING, ILLINOIS  
 NORTH QUADRANT SITEWORK - PHASE 1  
 AND TAXIWAY G2 EXTENSION  
 STORM WATER POLLUTION PREVENTION PLAN**

© Copyright CMT, Inc.

**CMT**  
 CRAWFORD, MURPHY & TILLY, INC.  
 CONSULTING ENGINEERS  
 License No. 184-000618

Lansing Municipal Airport

DESIGN BY:	ARM
DRAWN BY:	JRO
CHECKED BY:	ARM
APPROVED BY:	
DATE:	03/04/05
JOB No:	03297-02
IL PROJECT: IGQ-3329 A.I.P. PROJECT: 3-17-0121-B21	

SHEET 6 OF 50 SHEETS

# STORM WATER POLLUTION PREVENTION PLAN

THE FOLLOWING PLAN IS ESTABLISHED AND INCORPORATED IN THE PROJECT TO DIRECT THE CONTRACTOR IN THE PLACEMENT OF TEMPORARY EROSION CONTROL SYSTEMS AND TO PROVIDE A STORM WATER POLLUTION PREVENTION PLAN FOR COMPLIANCE WITH NPDES.

THE PURPOSE OF THIS PLAN IS TO MINIMIZE EROSION WITHIN THE CONSTRUCTION SITE AND TO LIMIT SEDIMENTS FROM LEAVING THE SITE BY UTILIZING PROPER TEMPORARY EROSION CONTROL SYSTEMS AND PROVIDING GROUND COVER WITHIN A REASONABLE AMOUNT OF TIME.

CERTAIN EROSION CONTROL FACILITIES SHALL BE INSTALLED BY THE CONTRACTOR AT THE BEGINNING OF CONSTRUCTION. OTHER ITEMS SHALL BE INSTALLED BY THE CONTRACTOR AS DIRECTED BY THE ENGINEER ON A CASE BY CASE SITUATION DEPENDING ON THE CONTRACTOR'S SEQUENCE OF ACTIVITIES, TIME OF YEAR, AND EXPECTED WEATHER CONDITIONS.

THE CONTRACTOR SHALL INSTALL PERMANENT EROSION CONTROL SYSTEMS AND SEEDING WITHIN A TIMEFRAME SPECIFIED HEREIN AND AS DIRECTED BY THE ENGINEER, THEREFORE MINIMIZING THE AMOUNT OF AREA SUSCEPTIBLE TO EROSION AND REDUCING THE AMOUNT OF TEMPORARY SEEDING, WHICH WILL BE THE CONTRACTOR'S COST. THE ENGINEER WILL DETERMINE IF ANY TEMPORARY EROSION CONTROL SYSTEMS SHOWN IN THE PLAN CAN BE DELETED AND IF ANY ADDITIONAL TEMPORARY EROSION CONTROL SYSTEMS, WHICH ARE NOT INCLUDED IN THIS PLAN, SHALL BE ADDED. THE CONTRACTOR SHALL PERFORM ALL WORK AS DIRECTED BY THE ENGINEER AND AS SHOWN ON THE PLANS.

## SITE DESCRIPTION

THE FOLLOWING IS A DESCRIPTION OF THE CONSTRUCTION ACTIVITY WHICH IS THE SUBJECT OF THIS PLAN:

THIS PROJECT CONSISTS OF CONSTRUCTING A NEW APRON TAXIWAY EXTENSION AT THE LANSING MUNICIPAL AIRPORT. THE PROJECT INCLUDES EXCAVATION, EMBANKMENT, DRAINAGE, VARIOUS PAVEMENT ITEMS, FENCING, ELECTRICAL IMPROVEMENTS AND OTHER MISCELLANEOUS CONSTRUCTION WORK.

THE FOLLOWING IS A DESCRIPTION OF THE INTENDED SEQUENCE OF MAJOR ACTIVITIES WHICH WILL DISTURB SOILS FOR MAJOR PORTIONS OF THE CONSTRUCTION SITE, SUCH AS EXCAVATION AND GRADING:

- EXCAVATION AND EMBANKMENT WILL BE COMPLETED WITHIN THE PROJECT LIMITS TO GRADE OUT FOR THE PROPOSED DRAINAGE AND PAVEMENT IMPROVEMENTS.
- UNDERDRAIN INSTALLATION AND MANHOLE ADJUSTMENTS.
- PLACEMENT, MAINTENANCE, REMOVAL AND PROPER CLEAN-UP OF TEMPORARY EROSION CONTROL, SUCH AS PERIMETER SILT FENCE AND INLET PROTECTION.
- PAVEMENT CONSTRUCTION.
- FENCING AND ELECTRICAL IMPROVEMENTS.
- FINAL GRADING AND OTHER MISCELLANEOUS ITEMS.
- PLACEMENT OF PERMANENT EROSION CONTROL, SUCH AS SEEDING AND MULCHING.

## AREA OF CONSTRUCTION SITE

THE TOTAL AREA OF THE CONSTRUCTION SITE IS ESTIMATED TO BE 27.8 ACRES OF WHICH 27.8 ACRES WILL BE DISTURBED BY EXCAVATION, GRADING AND OTHER ACTIVITIES.

## OTHER REPORTS, STUDIES AND PLANS WHICH AID IN THE DEVELOPMENT OF THE STORM WATER POLLUTION PREVENTION PLAN AS REFERENCED DOCUMENTS:

- INFORMATION OF THE SOILS AND TERRAIN WITHIN THE SITE WAS OBTAINED FROM TOPOGRAPHIC SURVEYS AND SOIL BORINGS THAT WERE UTILIZED FOR THE DEVELOPMENT OF THE PROPOSED TEMPORARY EROSION CONTROL SYSTEMS.
- PROJECT PLAN DOCUMENTS, SPECIFICATION AND SPECIAL PROVISIONS, AND PLAN DRAWINGS INDICATING DRAINAGE PATTERNS AND APPROXIMATE SLOPES ANTICIPATED AFTER GRADING ACTIVITIES WERE UTILIZED FOR THE PROPOSED PLACEMENT OF THE TEMPORARY EROSION CONTROL SYSTEMS.

## DRAINAGE TRIBUTARIES AND SENSITIVE AREAS RECEIVING RUNOFF FROM THIS CONSTRUCTION SITE:

THE CONSTRUCTION SITE DRAINS INTO THE LANSING DRAINAGE DITCH THROUGH A STORM SEWER SYSTEM.

## SEDIMENTATION AND EROSION CONTROL NOTES

THE WILL/SOUTH COOK SOIL AND WATER CONSERVATION DISTRICT (SWCD) IS RESPONSIBLE FOR CONDUCTING SITE VISITS AND VERIFYING THAT THE PRACTICES ARE WORKING PROPERLY AND DETERMINE IF ADDITIONAL PRACTICES ARE NEEDED FOR BETTER SOIL EROSION AND SEDIMENT CONTROL. IF ADDITIONAL PRACTICES ARE DEEMED NECESSARY BY THE SWCD THE CONTRACTOR WILL IMPLEMENT THE PRACTICES IN A TIMELY MANNER. THE ADDITIONAL PRACTICES (IF REQUIRED) SHALL BE COORDINATED WITH THE RESIDENT ENGINEER BEFORE WORK BEGINS.

THE WILL/SOUTH COOK SOIL AND WATER CONSERVATION DISTRICT MUST BE NOTIFIED ONE WEEK PRIOR TO THE PRE-CONSTRUCTION CONFERENCE, ONE WEEK PRIOR TO THE COMMENCEMENT OF LAND DISTURBING ACTIVITIES, AND ONE WEEK PRIOR TO FINAL INSPECTION.

THE SOIL EROSION AND SEDIMENT CONTROL PRACTICES WILL BE INSPECTED WEEKLY AND AFTER 1/2 INCH OF RAIN OR MORE BY THE RESIDENT ENGINEER.

ALL SOIL EROSION AND SEDIMENT CONTROL PRACTICES ARE REFERENCED FROM THE ILLINOIS URBAN MANUAL.

THE DRAWINGS, SPECIFICATIONS AND SPECIAL PROVISIONS WILL ENSURE THAT EXISTING VEGETATION IS PRESERVED WHERE ATTAINABLE AND DISTURBED PORTIONS OF THE SITE WILL BE STABILIZED. STABILIZATION PRACTICES INCLUDE SEEDING AND MULCHING AS DIRECTED BY THE ENGINEER. STABILIZATION MEASURES SHALL BE INITIATED AS SOON AS POSSIBLE IN PORTIONS OF THE SITE WHERE CONSTRUCTION ACTIVITIES HAVE TEMPORARILY OR PERMANENTLY CEASED, BUT IN NO CASE MORE THAN 7 DAYS AFTER THE CONSTRUCTION ACTIVITY IN THAT PORTION OF THE SITE HAS TEMPORARILY OR PERMANENTLY CEASED.

AS SOON AS REASONABLE ACCESS IS AVAILABLE TO ALL LOCATIONS WHERE WATER DRAINS AWAY FROM THE PROJECT, INLET PROTECTION AND PERIMETER SILT FENCE SHALL BE INSTALLED AS CALLED OUT IN THE PLANS OR AS DIRECTED BY THE ENGINEER.

THIS PLAN HAS BEEN PREPARED TO COMPLY WITH THE PROVISIONS OF THE NPDES PERMIT NUMBER 1LR10, ISSUED BY THE ILLINOIS ENVIRONMENTAL PROTECTION AGENCY FOR STORM WATER DISCHARGES FROM CONSTRUCTION SITE ACTIVITIES.

## DESCRIPTION OF STABILIZATION PRACTICES DURING CONSTRUCTION:

DURING CONSTRUCTION, AREAS OUTSIDE THE CONSTRUCTION LIMITS AS OUTLINED PREVIOUSLY HEREIN SHALL BE PROTECTED. THE CONTRACTOR SHALL NOT USE THIS AREA FOR STAGING (EXCEPT AS DESCRIBED ON THE PLANS AND DIRECTED BY THE ENGINEER), PARKING OF VEHICLES OR CONSTRUCTION EQUIPMENT, STORAGE OF MATERIALS, OR OTHER CONSTRUCTION RELATED ACTIVITIES.

- WITHIN THE CONSTRUCTION LIMITS, AREAS WHICH MAY BE SUSCEPTIBLE TO EROSION AS DETERMINED BY THE ENGINEER SHALL REMAIN UNDISTURBED UNTIL FULL SCALE CONSTRUCTION IS UNDERWAY TO PREVENT UNNECESSARY SOIL EROSION.
- EARTH STOCKPILES SHALL BE TEMPORARILY SEEDED, AT THE CONTRACTORS EXPENSE, IF THEY ARE TO REMAIN UNUSED FOR MORE THAN FOURTEEN DAYS.
- AS CONSTRUCTION PROCEEDS, THE CONTRACTOR SHALL INSTITUTE THE FOLLOWING AS DIRECTED BY THE ENGINEER:
  - PLACE TEMPORARY EROSION CONTROL FACILITIES AT LOCATIONS SHOWN ON THE PLANS.
  - CONSTRUCT DITCHES AND PROVIDE TEMPORARY EROSION CONTROL SYSTEMS.
  - BUILD NECESSARY EMBANKMENT AT CULVERT/STORM SEWER LOCATIONS AND THEN EXCAVATE AND PLACE PIPE.
  - EXCAVATED AREAS AND EMBANKMENT AREAS SHALL BE PERMANENTLY SEEDED IMMEDIATELY AFTER FINAL GRADING. IF NOT, THEY SHALL BE TEMPORARILY SEEDED, AT THE CONTRACTOR'S COST, IF NO CONSTRUCTION ACTIVITY IN THE AREA IS PLANNED FOR SEVEN DAYS.
- CONSTRUCTION EQUIPMENT SHALL BE STORED AND FUELED ONLY AT DESIGNATED LOCATIONS. ALL NECESSARY MEASURES SHALL BE TAKEN TO CONTAIN ANY FUEL OR POLLUTANT IN ACCORDANCE WITH EPA WATER QUALITY REGULATIONS. LEAKING EQUIPMENT OR SUPPLIES SHALL BE IMMEDIATELY REPAIRED OR REMOVED FROM THE SITE.
- SEDIMENT COLLECTED DURING CONSTRUCTION OF THE VARIOUS TEMPORARY EROSION CONTROL SYSTEMS SHALL BE DISPOSED OF ON SITE ON A REGULAR BASIS AS DIRECTED BY THE ENGINEER. THE COST OF THIS MAINTENANCE SHALL BE INCLUDED IN THE UNIT BID PRICE FOR UNCLASSIFIED EXCAVATION AND EROSION CONTROL ITEMS.
- THE TEMPORARY EROSION CONTROL SYSTEMS SHALL BE REMOVED AS DIRECTED BY THE ENGINEER AFTER USE IS NO LONGER NEEDED OR NO LONGER FUNCTIONING. THE COST OF THIS REMOVAL SHALL BE INCLUDED IN THE UNIT BID PRICE FOR VARIOUS TEMPORARY EROSION CONTROL PAY ITEMS.

## DESCRIPTION OF STRUCTURAL PRACTICES AFTER FINAL GRADING:

TEMPORARY EROSION CONTROL SYSTEMS SHALL BE LEFT IN PLACE WITH PROPER MAINTENANCE UNTIL PERMANENT EROSION CONTROL IS IN PLACE AND WORKING PROPERLY AND ALL PROPOSED TURF AREAS ARE SEEDED AND ESTABLISHED.

ONCE PERMANENT EROSION CONTROL SYSTEMS AS PROPOSED IN THE PLANS ARE FUNCTIONAL AND ESTABLISHED, TEMPORARY ITEMS SHALL BE REMOVED, CLEANED UP, AND DISTURBED TURF RESEEDED.

## MAINTENANCE AFTER CONSTRUCTION

CONSTRUCTION IS COMPLETE AFTER FINAL ACCEPTANCE BY THE ILLINOIS DIVISION OF AERONAUTICS. MAINTENANCE UP TO THIS DATE WILL BE REQUIRED BY THE CONTRACTOR.

## CONTRACTORS

- THE STORM WATER POLLUTION PREVENTION PLAN MUST CLEARLY IDENTIFY FOR EACH MEASURE IDENTIFIED IN THE PLAN, THE CONTRACTOR(S) OR SUBCONTRACTOR(S) THAT WILL IMPLEMENT THE MEASURE. ALL CONTRACTORS AND SUBCONTRACTORS IDENTIFIED IN THE PLAN MUST SIGN A COPY OF THE CERTIFICATION STATEMENT IN PARAGRAPH 2 BELOW IN ACCORDANCE WITH PART VI.G (SIGNATORY REQUIREMENTS) OF THIS PERMIT. ALL CERTIFICATIONS MUST BE INCLUDED IN THE STORM WATER POLLUTION PREVENTION PLAN EXCEPT FOR OWNERS THAT ARE ACTING AS CONTRACTOR.
- CERTIFICATION STATEMENT. ALL CONTRACTORS AND SUBCONTRACTORS IDENTIFIED IN A STORM WATER POLLUTION PREVENTION PLAN IN ACCORDANCE WITH PARAGRAPH 1 ABOVE SHALL SIGN A COPY OF THE FOLLOWING CERTIFICATION STATEMENT BEFORE CONDUCTING ANY PROFESSIONAL SERVICE AT THE SITE IDENTIFIED IN THE STORM WATER POLLUTION PREVENTION PLAN:

"I CERTIFY UNDER PENALTY OF LAW THAT I UNDERSTAND THE TERMS AND CONDITIONS OF THE GENERAL NATIONAL POLLUTANT DISCHARGE ELIMINATION SYSTEM (NPDES) PERMIT (1LR10) THAT AUTHORIZES THE STORM WATER DISCHARGES ASSOCIATED WITH INDUSTRIAL ACTIVITY FROM THE CONSTRUCTION SITE IDENTIFIED AS PART OF THIS CERTIFICATION."

THE CERTIFICATION MUST INCLUDE THE NAME AND TITLE OF THE PERSON PROVIDING THE SIGNATURE IN ACCORDANCE WITH PART VI.G OF THIS PERMIT; THE NAME, ADDRESS AND TELEPHONE NUMBER OF THE CONTRACTING FIRM; THE ADDRESS (OR OTHER IDENTIFYING DESCRIPTION) OF THE SITE; AND THE DATE THE CERTIFICATION IS MADE.

## CONTRACTOR CERTIFICATION

"I CERTIFY UNDER PENALTY OF LAW THAT I UNDERSTAND THE TERMS AND CONDITIONS OF THE GENERAL NATIONAL POLLUTANT DISCHARGE ELIMINATION SYSTEM (NPDES) PERMIT (1LR10) THAT AUTHORIZES THE STORM WATER DISCHARGES ASSOCIATED WITH INDUSTRIAL ACTIVITY FROM THE CONSTRUCTION SITE IDENTIFIED AS PART OF THIS CERTIFICATION."

## GENERAL CONTRACTOR

\_\_\_\_\_  
SIGNATURE TITLE DATE

\_\_\_\_\_  
COMPANY



## NOTICE OF INTENT (NOI) GENERAL PERMIT TO DISCHARGE STORM SEWER CONSTRUCTION SITE ACTIVITIES

IMPORTANT: FORM MUST BE TYPED TO ENABLE AUTOMATED OPTICAL PROCESSING.  
SUBMIT ORIGINAL - DO NOT SUBMIT PHOTOCOPY

OWNER INFORMATION		OWNER TYPE (SELECT ONE AND TYPE "X")	
NAME: LAST FIRST MI. (SEE INSTRUCTIONS)	VILLAGE OF LANSING ILLINOIS	<input type="checkbox"/> PRIVATE	<input type="checkbox"/> COUNTY
MAILING ADDRESS:	18200 CHICAGO AVE.	<input checked="" type="checkbox"/> CITY	<input type="checkbox"/> SPECIAL DISTRICT
CITY:	LANSING ST. IL ZIP: 60438	<input type="checkbox"/> FEDERAL	
CONTACT PERSON:	ROBERT MALKAS	TELEPHONE NUMBER:	AREA CODE NUMBER
		708	895-8844

CONTRACTOR INFORMATION		TELEPHONE NUMBER:		AREA CODE		NUMBER	
NAME: LAST FIRST MI. (SEE INSTRUCTIONS)							
MAILING ADDRESS:		CITY:	ST.	ZIP:			

CONSTRUCTION SITE INFORMATION		GENERAL NPDES PERMIT NO.		GENERAL NPDES PERMIT NO.	
SELECT OWNER AND TYPE "X"	<input type="checkbox"/> EXISTING SITE <input checked="" type="checkbox"/> NEW SITE <input type="checkbox"/> CHANGE OF INFORMATION	DEFERRED PERMIT NUMBERS (IF APPLICABLE)	N/A		
FACILITY NAME:	LANSING MUNICIPAL AIRPORT	TELEPHONE NUMBER:	708	AREA CODE	895-8844
MAILING ADDRESS:	18200 CHICAGO AVE.	CITY:	LANSING	ST.	IL
CITY:	LANSING	ZIP:	60438	LATITUDE (DEG. MIN. SEC.)	LONGITUDE (DEG. MIN. SEC.)
COUNTY:	COOK	SECTION:	8	TOWNSHIP:	36 NORTH RANGE: 15 EAST
START CONSTRUCTION DATE:	MM/YY	END CONSTRUCTION DATE:	MM/YY	TOTAL SIZE OF CONSTRUCTION SITE IN ACRES:	27.8 ACRES

TYPE OF CONSTRUCTION	
<input type="checkbox"/> RESIDENTIAL	<input type="checkbox"/> COMMERCIAL
<input type="checkbox"/> INDUSTRIAL	<input type="checkbox"/> RECONSTRUCTION
<input checked="" type="checkbox"/> TRANSPORTATION	<input type="checkbox"/> OTHER

HISTORIC PRESERVATION AND ENDANGERED SPECIES COMPLIANCE (OPTIONAL)	
HAS THIS PROJECT SATISFIED APPLICABLE REQUIREMENTS FOR COMPLIANCE WITH ILLINOIS LAW ON:	
HISTORIC PRESERVATION	<input checked="" type="checkbox"/> YES <input type="checkbox"/> NO, AND
ENDANGERED SPECIES	<input checked="" type="checkbox"/> YES <input type="checkbox"/> NO.

"I certify under penalty of law that this document and all attachments were prepared under my direction and supervision in accordance with a system designed to ensure that qualified personnel properly gather and evaluate the information submitted. Based on my inquiry of the person or persons who manage the system, or those persons directly responsible for gathering the information, the information submitted is, to the best of my knowledge and belief, true, accurate, and complete. I am aware that there are significant penalties for submitting false information, including the possibility of fine and imprisonment. In addition, I certify that the provisions of the permit, including the development and implementation of a Storm Water Pollution Prevention Plan and a Monitoring Program Plan, will be complied with.

OWNER SIGNATURE: _____	DATE: _____
MAIL COMPLETED FORM TO: (DO NOT SUBMIT ADDITIONAL DOCUMENTATION UNLESS REQUESTED)	ILLINOIS ENVIRONMENTAL PROTECTION AGENCY DIVISION OF WATER POLLUTION CONTROL ATTN: PERMIT SECTION 2200 CHURCHILL ROAD POST OFFICE BOX 19276 SPRINGFIELD, IL 62784-9276
	FOR OFFICE USE ONLY
	LOG
	PERMIT
	DATE

This Agency is authorized to require this information under Illinois Revised Statute, 1991, Chapter 111 1/2, section 1030. Information is required under that Section. Failure to do so may prevent this form from being processed and could result in your application being denied. This form has been approved by the Permit Management Center.

LA034

K:\Lansing\p\0329702\draw\sheet\1  
FILE: erosnotes.dwg  
LAYOUT: Layout1  
UPDATE BY: tmarin  
SURVEY BOOK #  
DATE: Wed 6/15/05 2:36pm  
XREF DWG: tb.cint.dwg  
tb.dwg

REVISIONS		
NUMBER	BY	DATE
1	ARM	6/10/05

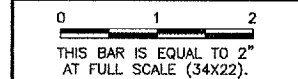

LANSING MUNICIPAL AIRPORT  
 LANSING, ILLINOIS  
 NORTH QUADRANT SITEWORK - PHASE 1  
 AND TAXIWAY G2 EXTENSION  
 STORM WATER POLLUTION PREVENTION  
 PLAN NOTES

© Copyright: CMT, Inc.

**CMT**  
CRAWFORD, MURPHY & TILLY, INC.  
CONSULTING ENGINEERS  
License No. 184-000818

Lansing Municipal  
airport

DESIGN BY:	ARM
DRAWN BY:	JRO
CHECKED BY:	ARM
APPROVED BY:	
DATE:	03/04/05
JOB No:	03297-02

IL PROJECT: IGQ-3329  
A.I.P. PROJECT: 3-17-0121-B21

**NOTES**

- BALES SHALL BE PLACED AT THE TOE OF SLOPE OR ON A CONTOUR AND IN A ROW WITH ENDS TIGHTLY ABUTTING THE ADJACENT BALES.
- EACH BALE SHALL BE EMBEDDED IN THE SOIL A MINIMUM OF 4 INCHES, AND PLACED SO THE BINDINGS ARE HORIZONTAL.
- BALES SHALL BE SECURELY ANCHORED IN PLACE BY EITHER TWO STAKES OR REBARS DRIVEN THROUGH THE BALE. THE FIRST STAKE IN EACH BALE SHALL BE DRIVEN TOWARD THE PREVIOUSLY LAID BALE AT AN ANGLE TO FORCE THE BALES TOGETHER. STAKES SHALL BE DRIVEN FLUSH WITH THE BALE.
- INSPECTION SHALL BE FREQUENT AND REPAIR / REPLACEMENT SHALL BE MADE PROMPTLY AS NEEDED.
- BALES SHALL BE REMOVED WHEN THEY HAVE SERVED THEIR USEFULNESS SO AS NOT TO BLOCK OR IMPEDE STORM FLOW OR DRAINAGE. COST OF REMOVAL / REPLACEMENT TO BE INCLUDED IN UNIT PRICE FOR BALES.
- AFTER FINAL APPROVAL OF THE ENGINEER, STRAW BALES MAY BE REMOVED. CONTRACTOR SHALL PLACE SEED AND MULCH OVER THE DISTURBED AREAS. COST INCIDENTAL TO INLET PROTECTION.

SEE NRCS STANDARD DRAWING NO. IL-508 SF FOR ADDITIONAL INSTALLATION DETAILS AND NOTES USED FOR TEMPORARY EROSION CONTROL. DETAIL BELOW SHALL BE USED AFTER RIP RAP IS PLACED

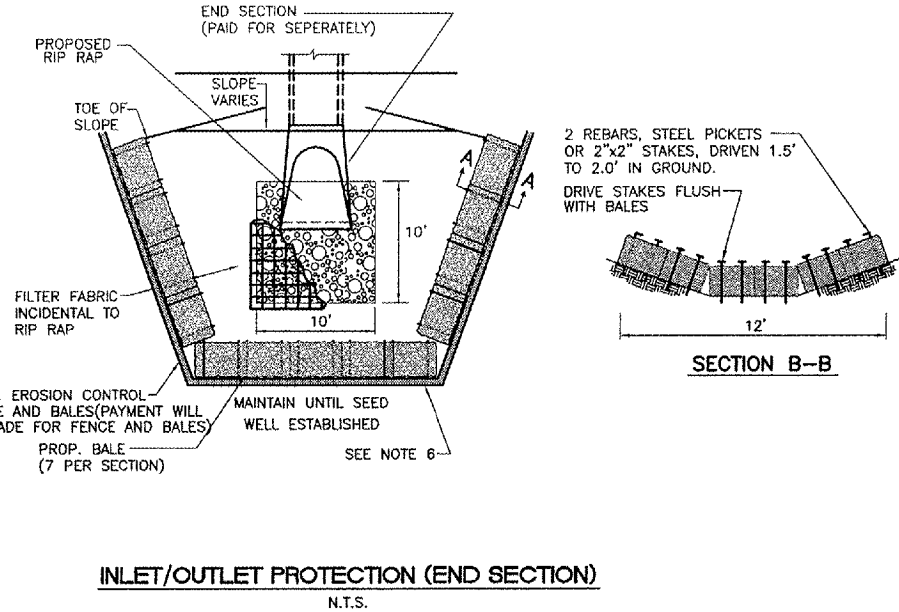

**INLET/OUTLET PROTECTION (END SECTION)**

N.T.S.

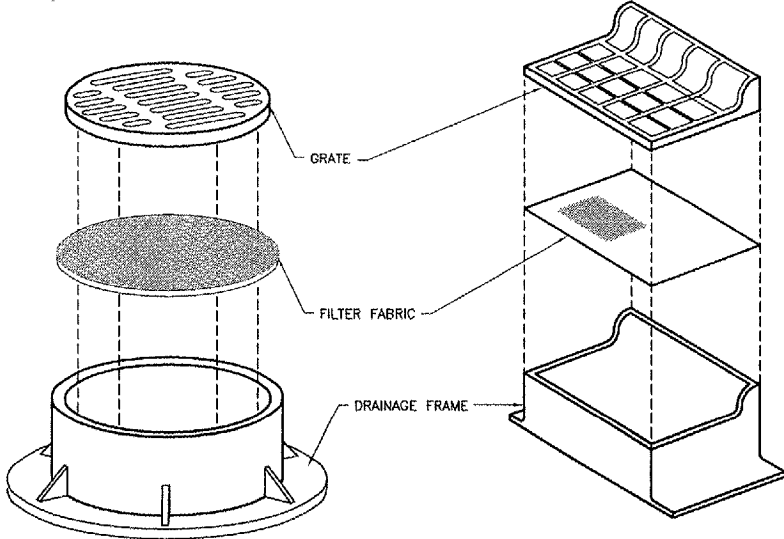

**NOTES**

- FILTER WRAP TO BE PLACED IN ALL EXISTING/PROPOSED INLETS, MANHOLES, TRENCH DRAINS AND CATCH BASINS LOCATED IN PAVED AREAS AND NONPAVED AREAS.
- FABRIC SHALL BE IN CONFORMANCE WITH MATERIALS SPECIFIED FOR SILT FENCE.
- FABRIC SHALL OVERLAY FRAME BY 2" (MIN.).
- CONTRACTOR SHALL CLEAR DEBRIS AND SILT AS REQUIRED FROM FABRIC TO MAINTAIN DRAINAGE THROUGH THE STRUCTURE.
- FABRIC SHALL REMAIN IN PLACE UNTIL TURFED AREAS HAVE DEVELOPED A MIN. OF 80% OF COVERAGE.
- COST OF FILTER WRAP SHALL BE CONSIDERED INCIDENTAL TO BALES.

**DRAINAGE STRUCTURE FILTER WRAP**

N.T.S.

LA034

K:\LansingAp\0328702\draw\sheet\ FILE: erosnotes2.dwg LAYOUT: Layout1 UPDATE BY: johse SURVEY BOOK # DATE: Wed 3/9/05 8:26am XREF DWG: tbcint.dwg tb.dwg

**REVISIONS**

NUMBER	BY	DATE

0 1 2  
THIS BAR IS EQUAL TO 2" AT FULL SCALE (34X22).

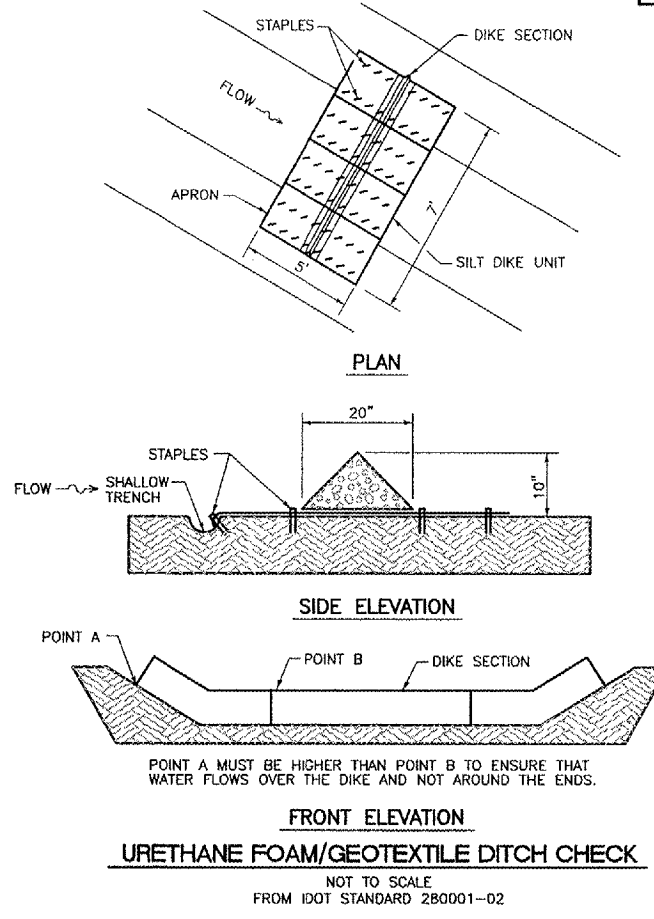

**URETHANE FOAM/GEOTEXTILE DITCH CHECK**

NOT TO SCALE FROM IDOT STANDARD 280001-02

SEE NRCS STANDARD DRAWING NO. IL-620 SILT FENCE PLAN FOR INSTALLATION DETAIL AND ADDITIONAL NOTES

**CONSTRUCTION NOTES FOR SILT FENCE**

- WHEN TWO SECTIONS OF FILTER CLOTH ADJOIN EACH OTHER THEY SHALL BE OVERLAPPED BY 6" MIN. AND FOLDED.
- MAINTENANCE SHALL BE PERFORMED AS NEEDED AND MATERIAL REMOVED WHEN "BULGES" DEVELOP IN THE SILT FENCE. MAINTENANCE, WHICH INCLUDES THE REPLACEMENT OF DAMAGED FENCE, SHALL BE CONSIDERED INCIDENTAL TO THE COST OF THE EROSION CONTROL FENCE.
- SILT FENCE SHALL BE INSTALLED PER STORM WATER POLLUTION PREVENTION PLAN OR AS DIRECTED BY THE ENGINEER.

**EROSION CONTROL FABRIC FENCE DETAIL**

N.T.S.

SEE NRCS STANDARD DRAWING NO. IL-563 INLET PROTECTION STRAW BALE BARRIER PLAN FOR INSTALLATION DETAIL AND ADDITIONAL NOTES

**NOTES**

- BALES SHALL BE PLACED AT THE TOE OF SLOPE OR ON A CONTOUR AND IN A ROW WITH ENDS TIGHTLY ABUTTING THE ADJACENT BALES.
- EACH BALE SHALL BE EMBEDDED IN THE SOIL A MINIMUM OF 4 INCHES, AND PLACED SO THE BINDINGS ARE HORIZONTAL.
- BALES SHALL BE SECURELY ANCHORED IN PLACE BY EITHER TWO STAKES OR REBARS DRIVEN THROUGH THE BALE. THE FIRST STAKE IN EACH BALE SHALL BE DRIVEN TOWARD THE PREVIOUSLY LAID BALE AT AN ANGLE TO FORCE THE BALES TOGETHER. STAKES SHALL BE DRIVEN FLUSH WITH THE BALE.
- INSPECTION SHALL BE FREQUENT AND REPAIR / REPLACEMENT SHALL BE MADE PROMPTLY AS NEEDED.
- BALES SHALL BE REMOVED WHEN THEY HAVE SERVED THEIR USEFULNESS SO AS NOT TO BLOCK OR IMPEDE STORM FLOW OR DRAINAGE. COST OF REMOVAL / REPLACEMENT TO BE INCLUDED IN UNIT PRICE FOR BALES.
- AFTER FINAL APPROVAL OF THE ENGINEER, STRAW BALES MAY BE REMOVED. CONTRACTOR SHALL PLACE TOPSOIL, SEED AND MULCH OVER THE DISTURBED AREAS. COST INCIDENTAL TO BALES.

**INLET PROTECTION - TURF AREAS**

N.T.S.

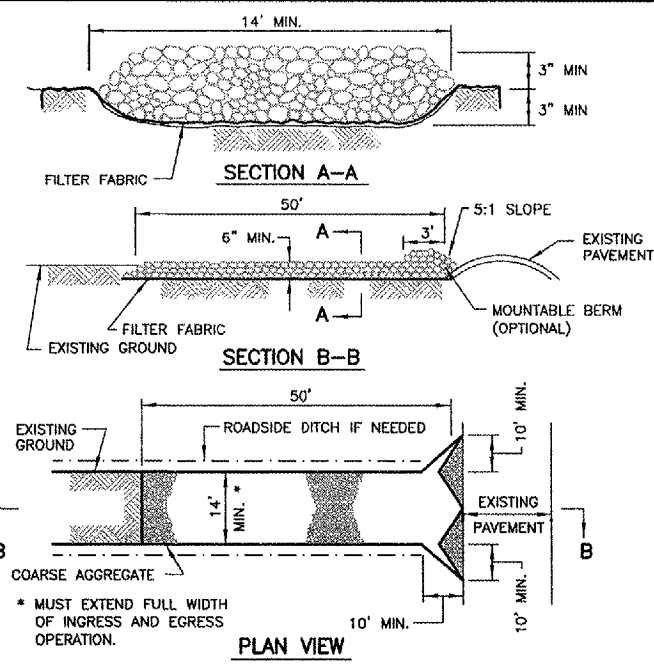

- FILTER FABRIC SHALL MEET THE REQUIREMENTS OF MATERIAL SPECIFIED FOR AR152540 IN THE ILLINOIS DEPARTMENT OF TRANSPORTATION DIVISION OF AERONAUTICS SUPPLEMENTAL SPECIFICATIONS AND RECURRING SPECIAL PROVISIONS.
- ROCK OR RECLAIMED CONCRETE SHALL MEET ONE OF THE FOLLOWING IDOT COARSE AGGREGATE GRADATION, CA-1, CA-2, CA-3 OR CA-4.
- ANY DRAINAGE FACILITIES REQUIRED BECAUSE OF WASHING SHALL BE CONSTRUCTED ACCORDING TO MANUFACTURERS SPECIFICATIONS AND SHALL BE INCIDENTAL TO THE CONTRACT.
- MINIMUM WIDTH IS 14' FOR ONE-WAY TRAFFIC AND 20' FOR TWO WAY TRAFFIC. TWO-WAY TRAFFIC WIDTHS SHALL BE INCREASED A MINIMUM OF 4' FOR TRAILER TRAFFIC. DEPENDING ON THE TYPE OF VEHICLE OR EQUIPMENT, SPEED, LOADS, CLIMATIC AND OTHER CONDITIONS UNDER WHICH VEHICLES AND EQUIPMENT OPERATE AN INCREASE IN THE MINIMUM WIDTHS MAY BE REQUIRED.
- ROADWAY SHALL FOLLOW THE CONTOUR OF THE NATURAL TERRAIN TO THE EXTENT POSSIBLE.
- STABILIZED CONSTRUCTION ENTRANCE SHALL BE INCIDENTAL TO THE CONTRACT.

**STABILIZED CONSTRUCTION ENTRANCE**

FROM NRCS STANDARD DRAWING NO. IL-630

SEE NRCS STANDARD DRAWING NO. IL-530 EROSION BLANKET PLAN FOR INSTALLATION DETAIL AND NOTES

**LANSING MUNICIPAL AIRPORT**  
**LANSING, ILLINOIS**  
**NORTH QUADRANT SITEWORK - PHASE 1**  
**AND TAXIWAY G2 EXTENSION**  
**STORM WATER POLLUTION PREVENTION**  
**PLAN DETAILS**

Copyright: CMT, Inc.  
**CMT**  
 CRAWFORD, MURPHY & TILLY, INC.  
 CONSULTING ENGINEERS  
 License No. 184-000613  
 Lansing Municipal Airport

DESIGN BY:	ARM
DRAWN BY:	JRO
CHECKED BY:	ARM
APPROVED BY:	
DATE:	03/04/05
JOB No:	03297-02
IL PROJECT:	IGQ-3329
A.I.P. PROJECT:	3-17-0121-B21
SHEET	8 OF 50 SHEETS



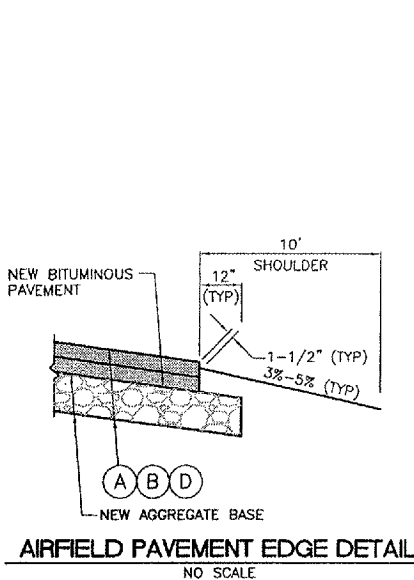

**AIRFIELD PAVEMENT EDGE DETAIL**  
NO SCALE

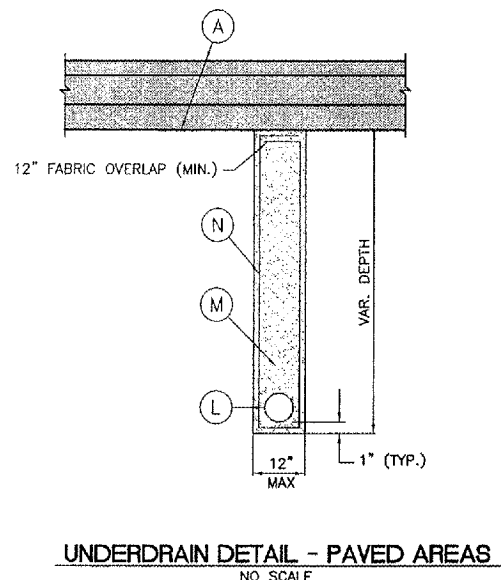

**UNDERDRAIN DETAIL - PAVED AREAS**  
NO SCALE

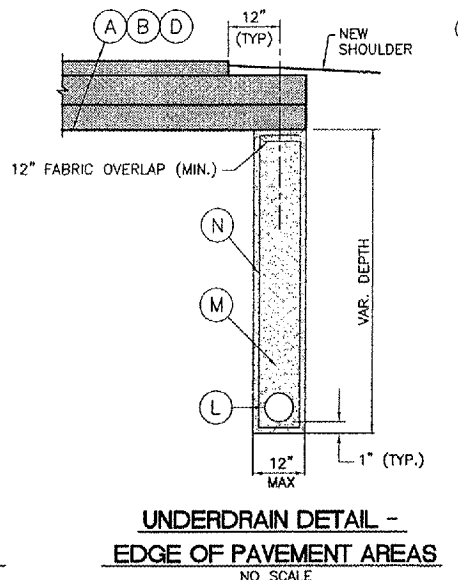

**UNDERDRAIN DETAIL -  
EDGE OF PAVEMENT AREAS**  
NO SCALE

**LEGEND**

- (A) NEW HANGAR/TAXILANE PAVEMENT STRUCTURE (STATE/LOCAL FUNDING)  
1.5" BITUMINOUS SURFACE COURSE (401)  
2.5" BITUMINOUS BASE COURSE (201)  
7" CRUSHED AGGREGATE BASE COURSE (209)  
4" AGGREGATE BASE COURSE (208)
- (B) NEW HANGAR APRON PAVEMENT STRUCTURE (LOCAL ONLY FUNDING)  
1.5" BITUMINOUS SURFACE COURSE (401)  
2.5" BITUMINOUS BASE COURSE (201)  
7" CRUSHED AGGREGATE BASE COURSE (209)  
4" AGGREGATE BASE COURSE (208)
- (C) NEW HANGAR FLOOR SLAB - BY OTHERS  
5" P.C. CONCRETE PAVEMENT  
4" AGGREGATE BASE COURSE
- (D) NEW TAXIWAY G2 PAVEMENT STRUCTURE (FEDERAL/STATE/LOCAL FUNDING)  
1.5" BITUMINOUS SURFACE COURSE (401)  
2.5" BITUMINOUS BASE COURSE (201)  
11" CRUSHED AGGREGATE BASE COURSE (209)
- (E) NEW ACCESS DRIVE/AUTO PARKING LOT PAVEMENT STRUCTURE (STATE/LOCAL FUNDING)  
1.5" BITUMINOUS SURFACE COURSE (401)  
2.5" BITUMINOUS BASE COURSE (201)  
8" CRUSHED AGGREGATE BASE COURSE (209)
- (F) FUTURE HANGAR APRON PAVEMENT STRUCTURE (BY OTHERS)
- (G) NEW TOPSOIL PLACEMENT (4" MIN.)(905)
- (H) NEW EMBANKMENT FILL (152)
- (I) NEW SEEDING AND MULCHING (901 AND 908)
- (J) NEW TACK COAT (603)
- (K) NEW PRIME COAT (602)
- (L) NEW 6" C.P.P.U.P. W/ SOCK (705)
- (M) NEW POROUS BACKFILL (705) COST INCIDENTAL TO PROPOSED UNDERDRAIN
- (N) NEW UNDERDRAIN TRENCH FABRIC ENVELOPE (705) COST INCIDENTAL TO UNDERDRAIN
- (O) NEW GROUNDLINE
- (P) EXISTING GROUNDLINE
- (Q) NEW 12" AVERAGE TOPSOIL STRIPPING (152)
- (R) FUTURE GROUNDLINE
- (S) NEW 6" AVERAGE TOPSOIL STRIPPING (152)
- (T) NEW SHOULDER FILL (152)
- (U) NEW COMBINATION CONCRETE CURB AND GUTTER, TYPE B-6.12 (GUTTER THICKNESS SHALL BE 9" W/ 4" AGGREGATE BASE)
- (V) NEW SOIL STABILIZATION FABRIC (152)
- (W) NEW 8' WIDE EROSION CONTROL BLANKET (156)
- (X) NEW 24" THICK POROUS GRANULAR EMBANKMENT (208) UNDER PAVEMENT WITHIN EXISTING LANSING DRAINAGE DITCH
- (Y) CONTRACTOR SHALL PAVE 10' WIDTH AFTER BUILDING CONTRACTOR'S COMPLETION OF NEW BUILDING FOUNDATION. TIMING/SCHEDULING/COORDINATING THIS WORK SHALL BE AT NO ADDITIONAL COST TO CONTRACT.
- (Z) NEW UNCLASSIFIED EXCAVATION (152)

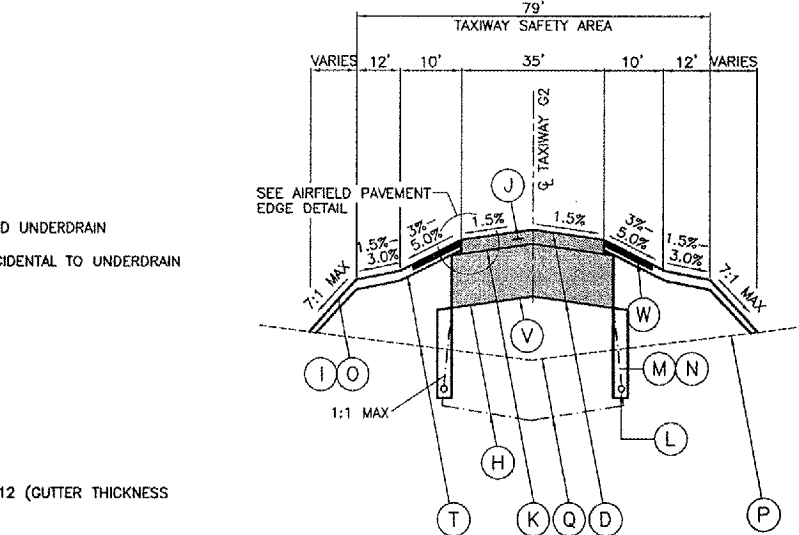
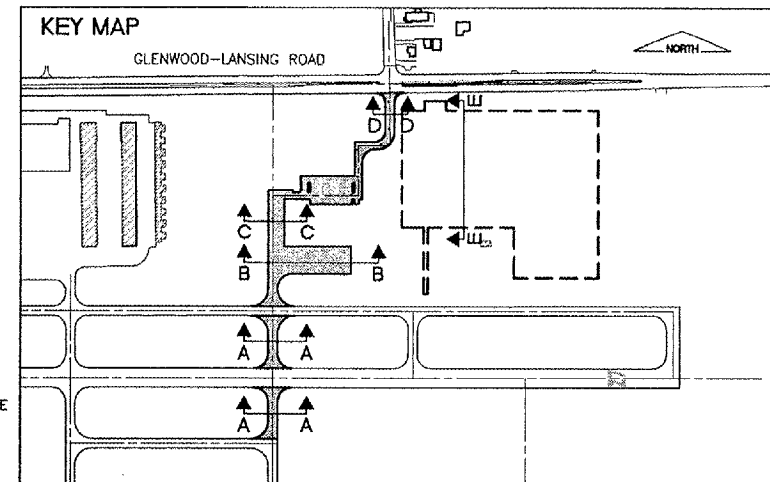

**TAXIWAY G2 EXTENSION TYPICAL SECTION A-A**  
NO SCALE

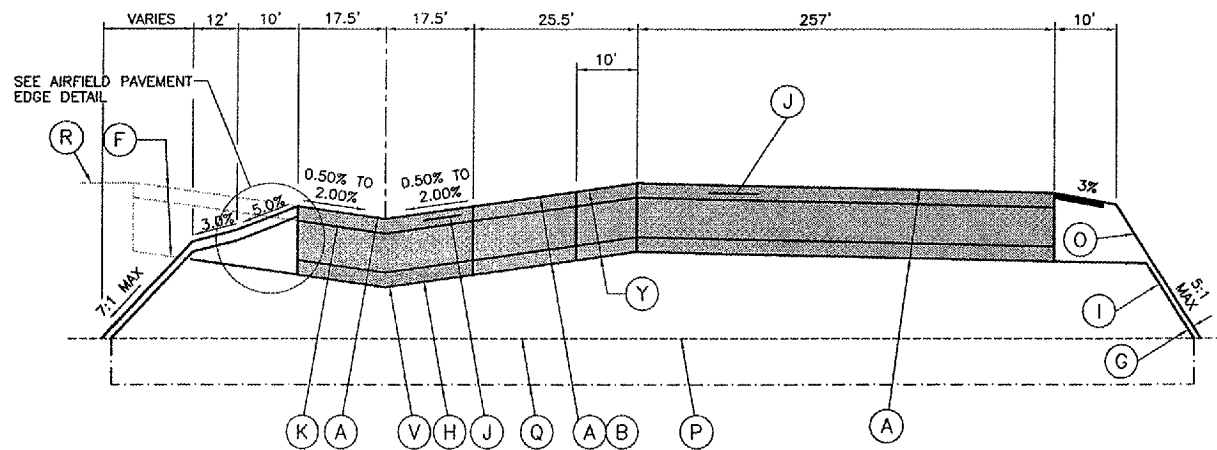

**HANGAR SITE TYPICAL SECTION B-B**  
NO SCALE

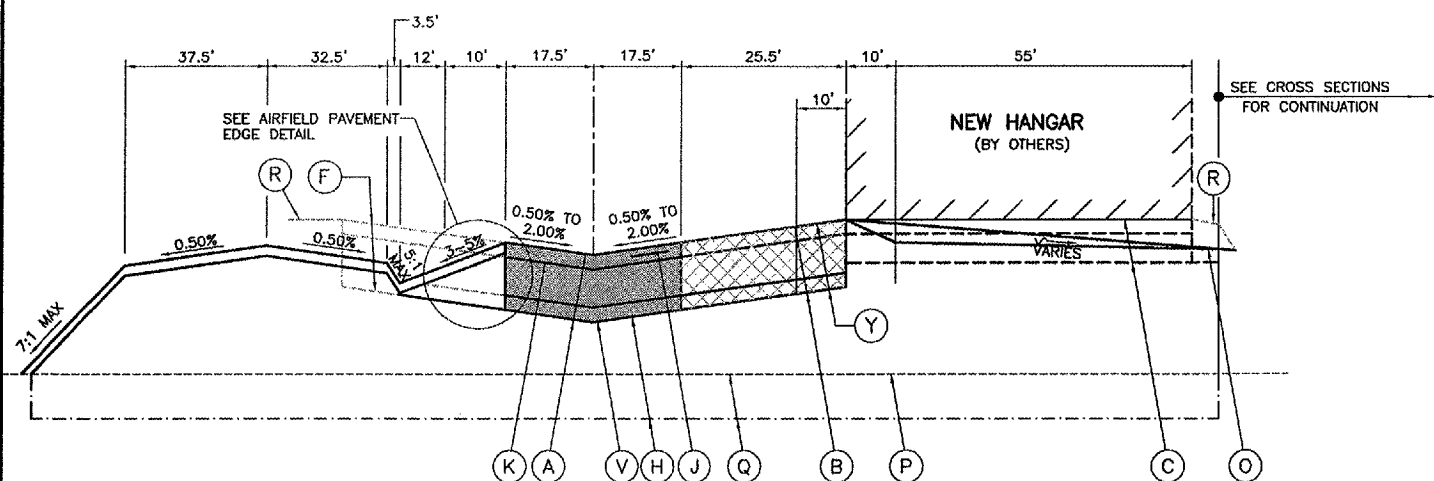

**HANGAR SITE TYPICAL SECTION C-C**  
NO SCALE

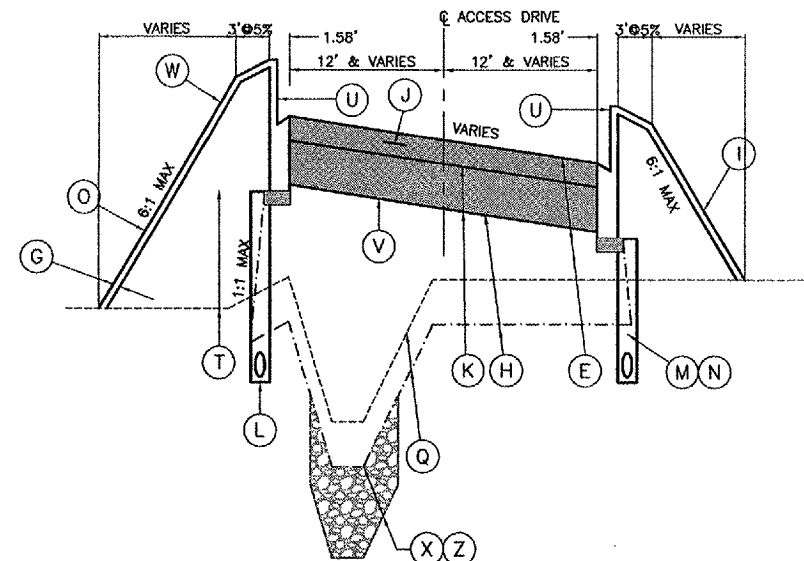

**ROADWAY TYPICAL SECTION D-D**  
NO SCALE  
NEW AUTO PARKING LOT PAVEMENT STRUCTURE SHALL BE SECTION D-D

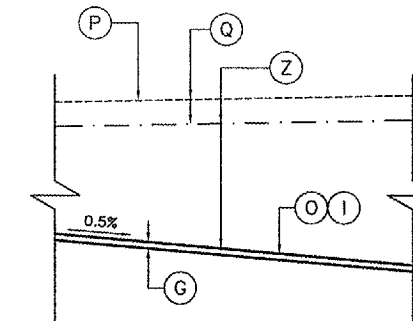

**BORROW SITE TYPICAL SECTION E-E**  
NO SCALE

REVISIONS		
NUMBER	BY	DATE

**LANSING MUNICIPAL AIRPORT  
LANSING, ILLINOIS  
NORTH QUADRANT SITEWORK - PHASE 1  
AND TAXIWAY G2 EXTENSION**

**TYPICAL SECTIONS**

© Copyright CMT, Inc.  
**CMT**  
 CRAWFORD, MURPHY & TILLY, INC.  
 CONSULTING ENGINEERS  
 License No. 84-00815

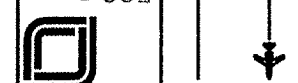

DESIGN BY:	ARM
DRAWN BY:	JP
CHECKED BY:	ARM
APPROVED BY:	
DATE:	03/04/05
JOB No:	03297-02
IL PROJECT:	IGQ-3329
A.I.P. PROJECT:	3-17-0121-B21

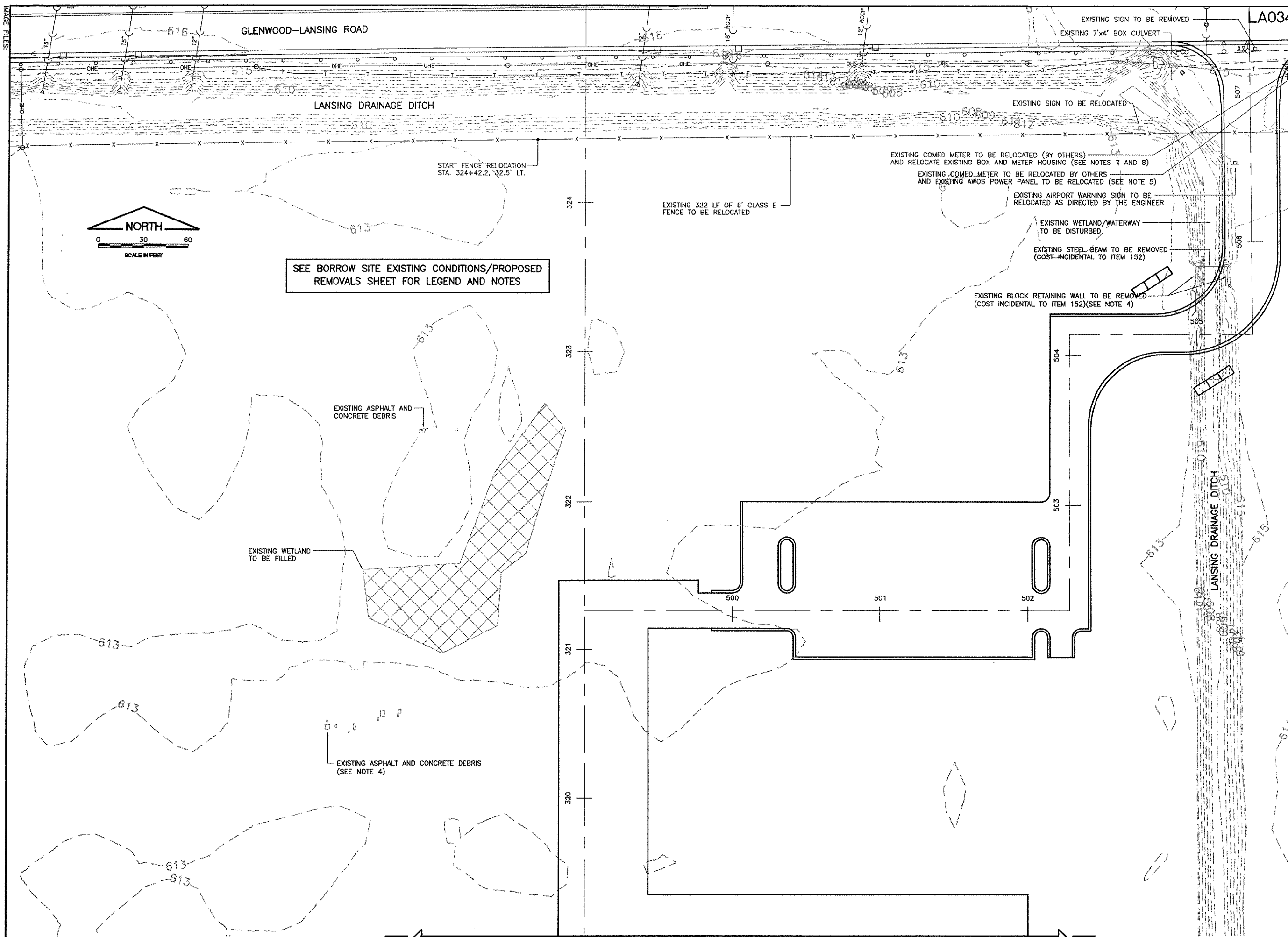

LA034

K:\LansingAp\0329702\draw\sheet\FILE: econd.dwg  
 LAYOUT: Layout1  
 UPDATE BY: johse  
 SURVEY BOOK #  
 DATE: Fri 3/18/05 2:19pm  
 XREF DWG: nethgr-base.dwg  
 tblnt.dwg  
 tb.dwg

REVISIONS

NUMBER	BY	DATE

0 1 2  
 THIS BAR IS EQUAL TO 2"  
 AT FULL SCALE (34X22).

LANSING MUNICIPAL AIRPORT  
 LANSING, ILLINOIS  
 NORTH QUADRANT SITEWORK - PHASE 1  
 AND TAXIWAY G2 EXTENSION

EXISTING CONDITIONS/PROPOSED REMOVALS  
 NORTH QUADRANT SITEWORK  
 AND AUTO PARKING LOT

© Copyright CMT, Inc.  
**CMT**  
 CRAWFORD, MURPHY & TILLY, INC.  
 CONSULTING ENGINEERS  
 License No. 84-00613



DESIGN BY:	ARM
DRAWN BY:	JRO
CHECKED BY:	ARM
APPROVED BY:	
DATE:	03/04/05
JOB No:	03297-02

IL PROJECT: IGQ-3329  
 A.I.P. PROJECT: 3-17-0121-B21

MATCHLINE STA.319+00

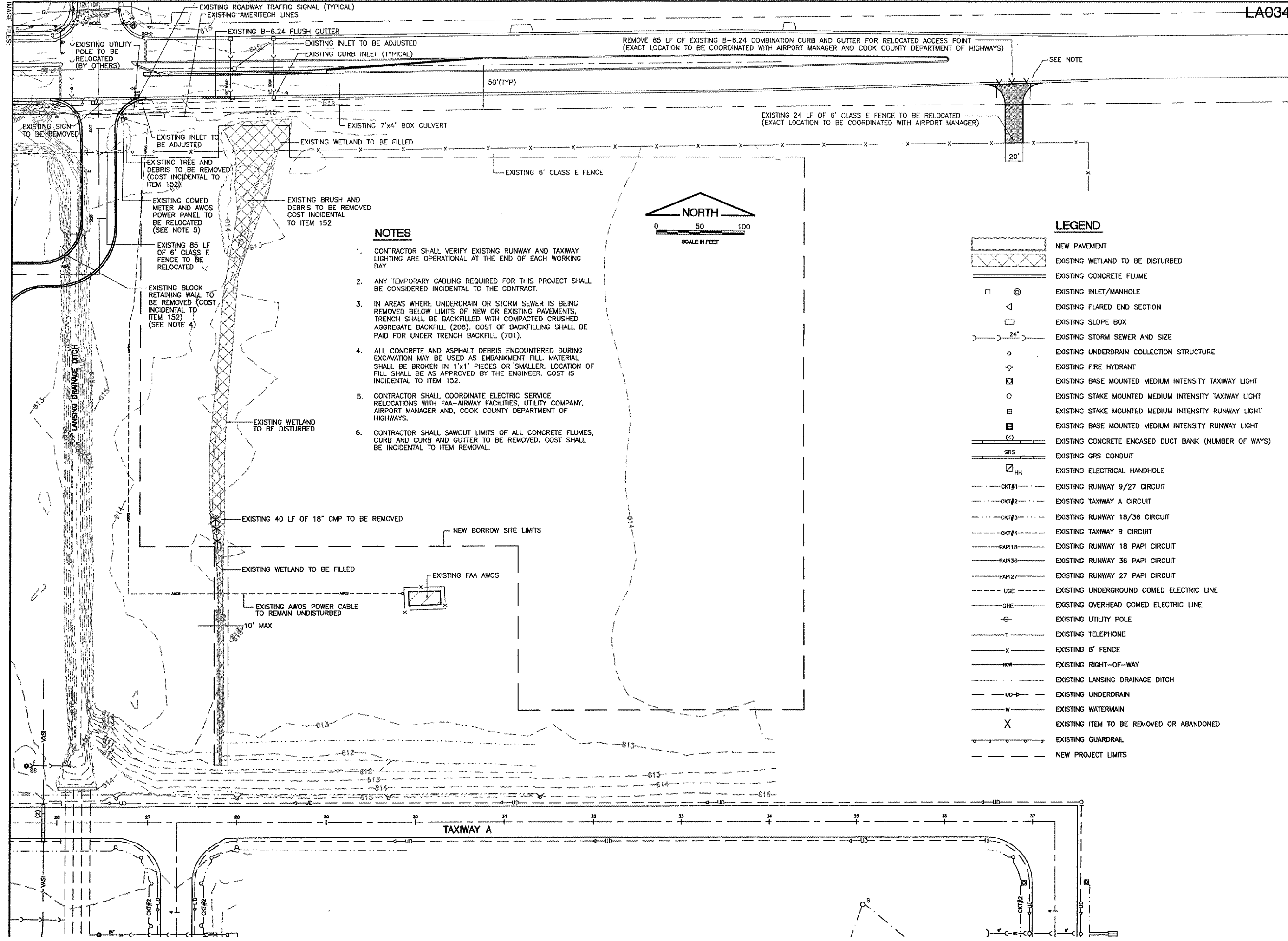

- NOTES
1. CONTRACTOR SHALL VERIFY EXISTING RUNWAY AND TAXIWAY LIGHTING ARE OPERATIONAL AT THE END OF EACH WORKING DAY.
2. ANY TEMPORARY CABLING REQUIRED FOR THIS PROJECT SHALL BE CONSIDERED INCIDENTAL TO THE CONTRACT.
3. IN AREAS WHERE UNDERDRAIN OR STORM SEWER IS BEING REMOVED BELOW LIMITS OF NEW OR EXISTING PAVEMENTS, TRENCH SHALL BE BACKFILLED WITH COMPACTED CRUSHED AGGREGATE BACKFILL (208). COST OF BACKFILLING SHALL BE PAID FOR UNDER TRENCH BACKFILL (701).
4. ALL CONCRETE AND ASPHALT DEBRIS ENCOUNTERED DURING EXCAVATION MAY BE USED AS EMBANKMENT FILL. MATERIAL SHALL BE BROKEN IN 1'x1' PIECES OR SMALLER. LOCATION OF FILL SHALL BE AS APPROVED BY THE ENGINEER. COST IS INCIDENTAL TO ITEM 152.
5. CONTRACTOR SHALL COORDINATE ELECTRIC SERVICE RELOCATIONS WITH FAA-AIRWAY FACILITIES, UTILITY COMPANY, AIRPORT MANAGER AND, COOK COUNTY DEPARTMENT OF HIGHWAYS.
6. CONTRACTOR SHALL SAWCUT LIMITS OF ALL CONCRETE FLUMES, CURB AND CURB AND GUTTER TO BE REMOVED. COST SHALL BE INCIDENTAL TO ITEM REMOVAL.

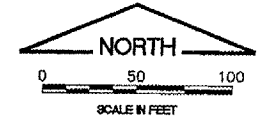

- LEGEND
NEW PAVEMENT
EXISTING WETLAND TO BE DISTURBED
EXISTING CONCRETE FLUME
EXISTING INLET/MANHOLE
EXISTING FLARED END SECTION
EXISTING SLOPE BOX
EXISTING STORM SEWER AND SIZE
EXISTING UNDERDRAIN COLLECTION STRUCTURE
EXISTING FIRE HYDRANT
EXISTING BASE MOUNTED MEDIUM INTENSITY TAXIWAY LIGHT
EXISTING STAKE MOUNTED MEDIUM INTENSITY TAXIWAY LIGHT
EXISTING STAKE MOUNTED MEDIUM INTENSITY RUNWAY LIGHT
EXISTING BASE MOUNTED MEDIUM INTENSITY RUNWAY LIGHT
EXISTING CONCRETE ENCASED DUCT BANK (NUMBER OF WAYS)
EXISTING GRS CONDUIT
EXISTING ELECTRICAL HANDHOLE
EXISTING RUNWAY 9/27 CIRCUIT
EXISTING TAXIWAY A CIRCUIT
EXISTING RUNWAY 18/36 CIRCUIT
EXISTING TAXIWAY B CIRCUIT
EXISTING RUNWAY 18 PAPI CIRCUIT
EXISTING RUNWAY 36 PAPI CIRCUIT
EXISTING RUNWAY 27 PAPI CIRCUIT
EXISTING UNDERGROUND COMED ELECTRIC LINE
EXISTING OVERHEAD COMED ELECTRIC LINE
EXISTING UTILITY POLE
EXISTING TELEPHONE
EXISTING 6' FENCE
EXISTING RIGHT-OF-WAY
EXISTING LANSING DRAINAGE DITCH
EXISTING UNDERDRAIN
EXISTING WATERMAIN
EXISTING ITEM TO BE REMOVED OR ABANDONED
EXISTING GUARDRAIL
NEW PROJECT LIMITS

Table with 3 columns: NUMBER, BY, DATE. Title: REVISIONS.

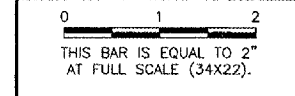

LANSING MUNICIPAL AIRPORT
LANSING, ILLINOIS
NORTH QUADRANT SITework - PHASE 1
AND TAXIWAY G2 EXTENSION
EXISTING CONDITIONS/PROPOSED REMOVALS
BORROW SITE

GMT
CRAWFORD, MURPHY & TILLY, INC.
CONSULTING ENGINEERS
License No. 94-000613
Lansing Municipal Airport

Table with 2 columns: Field, Value. Fields: DESIGN BY, DRAWN BY, CHECKED BY, APPROVED BY, DATE, JOB No., IL PROJECT, A.I.P. PROJECT, SHEET.

REVISIONS		
NUMBER	BY	DATE
1	ARM	6/10/05

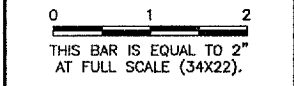

**NOTES**

1. SEE CROSS SECTION SHEET FOR THE REMAINING GRADES.
2. CONTRACTOR TO VERIFY EXISTING DRAINAGE DITCH INVERTS PRIOR TO PLACEMENT OF ALL DRAINAGE STRUCTURES.
3. CONTRACTOR SHALL COORDINATE WITH BUILDING CONTRACTOR ON ALL NEW PAVEMENT WITHIN 10' OF PROPOSED BUILDING LOCATIONS. CONTRACTOR SHALL PAVE 10' WIDTH AFTER BUILDING CONTRACTOR'S COMPLETION OF NEW BUILDING FOUNDATIONS. TIMING/SCHEDULING/COORDINATING THIS WORK SHALL BE AT NO ADDITIONAL COST TO CONTRACT.

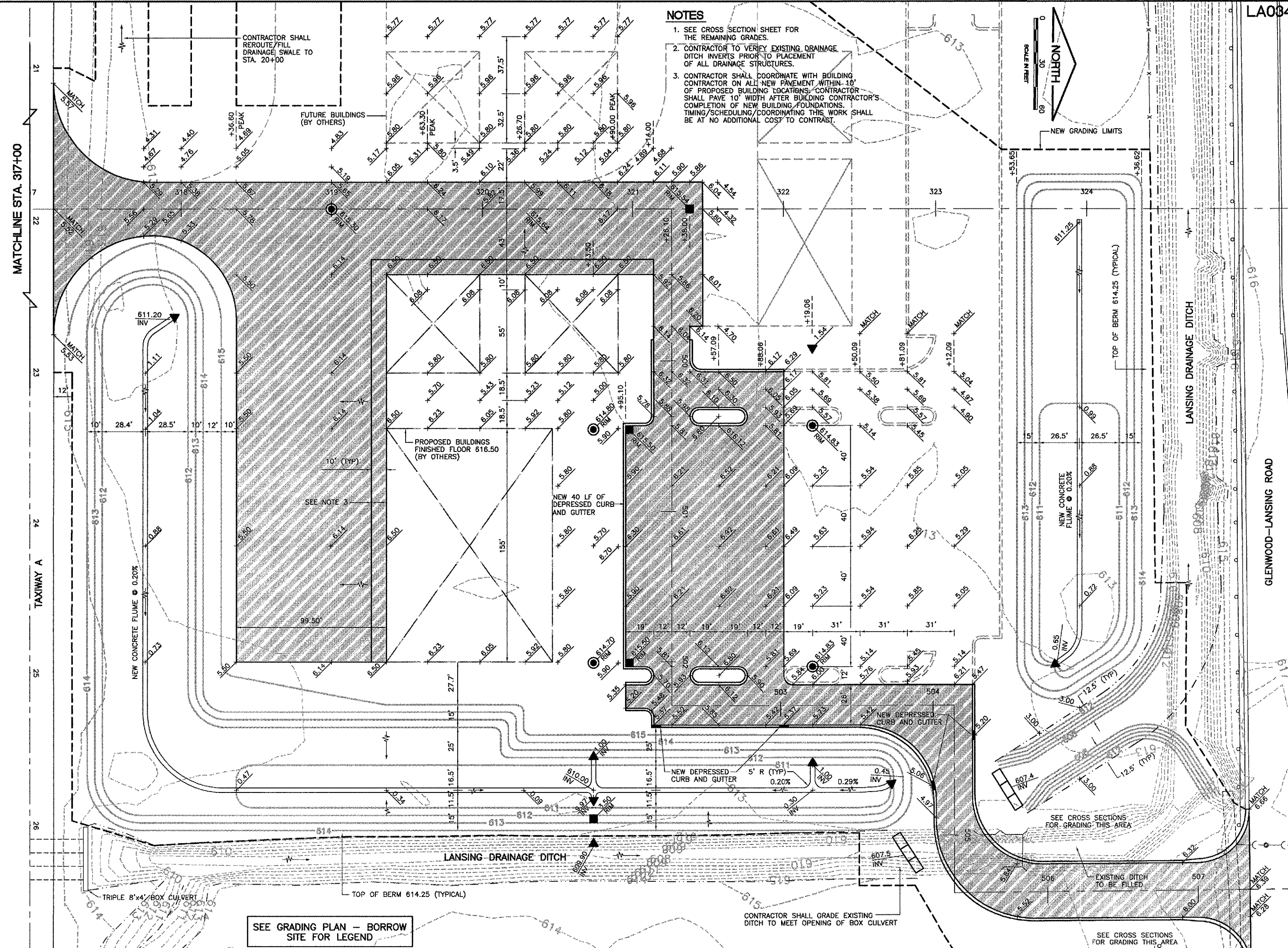
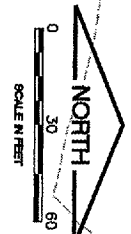

MATCHLINE STA. 317+00

TAXIWAY A

24

26

SEE GRADING PLAN - BORROW SITE FOR LEGEND

CONTRACTOR SHALL GRADE EXISTING DITCH TO MEET OPENING OF BOX CULVERT

SEE CROSS SECTIONS FOR GRADING THIS AREA

**LANSING MUNICIPAL AIRPORT  
LANSING, ILLINOIS**

**NORTH QUADRANT SITEWORK - PHASE 1  
AND TAXIWAY G2 EXTENSION**

**GRADING PLAN NORTH QUADRANT  
SITEWORK AND AUTO PARKING LOT**

**CMT**  
CRAWFORD, MURPHY & TILLY, INC.  
CONSULTING ENGINEERS  
License No. 184-000613

Lansing Municipal  
**airport**

DESIGN BY:	ARM
DRAWN BY:	JRO
CHECKED BY:	ARM
APPROVED BY:	
DATE:	08/08/05
JOB No:	03297-02
IL PROJECT:	IGQ-3329
A.I.P. PROJECT:	3-17-0121-B21
SHEET 12 OF 50 SHEETS	



REVISIONS		
NUMBER	BY	DATE
1	ARM	6/10/05

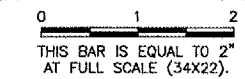

**LANSING MUNICIPAL AIRPORT  
 LANSING, ILLINOIS  
 NORTH QUADRANT SITEWORK - PHASE 1  
 AND TAXIWAY G2 EXTENSION  
 GRADING PLAN  
 BORROW SITE**

© copyright CMT, Inc.

**CMT**  
 CRAWFORD, MURPHY & TILLY, INC.  
 CONSULTING ENGINEERS  
 License No. 184-000813

DESIGN BY:	ARM
DRAWN BY:	JRO
CHECKED BY:	ARM
APPROVED BY:	
DATE:	03/04/05
JOB No:	03297-02
IL PROJECT: IGQ-3329 A.I.P. PROJECT: 3-17-0121-B21	
SHEET 13 OF 50 SHEETS	

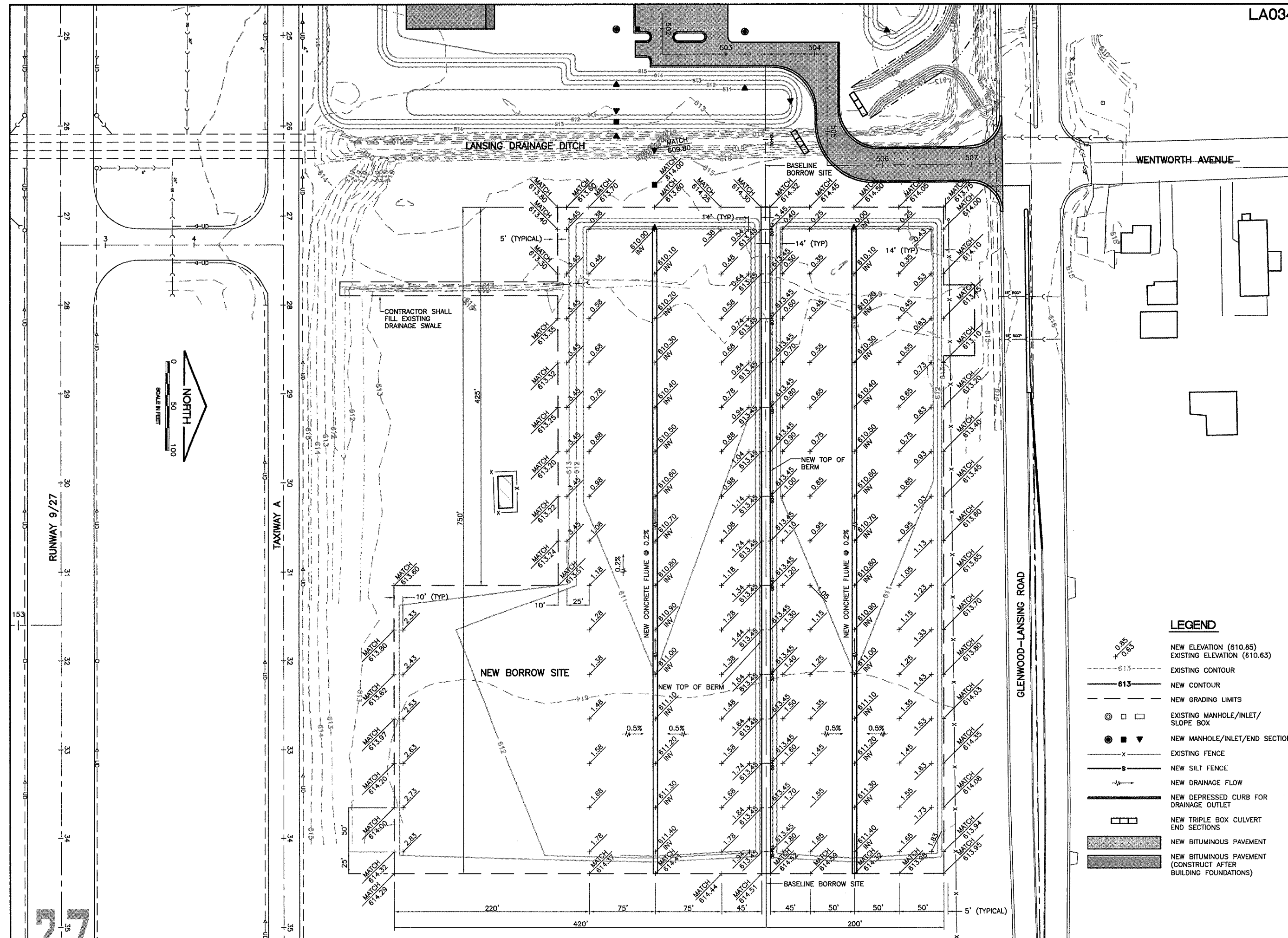

**LEGEND**

- NEW ELEVATION (610.85)  
EXISTING ELEVATION (610.63)
- EXISTING CONTOUR
- NEW CONTOUR
- NEW GRADING LIMITS
- EXISTING MANHOLE/INLET/  
SLOPE BOX
- NEW MANHOLE/INLET/END SECTION
- EXISTING FENCE
- NEW SILT FENCE
- NEW DRAINAGE FLOW
- NEW DEPRESSED CURB FOR  
DRAINAGE OUTLET
- NEW TRIPLE BOX CULVERT  
END SECTIONS
- NEW BITUMINOUS PAVEMENT
- NEW BITUMINOUS PAVEMENT  
(CONSTRUCT AFTER  
BUILDING FOUNDATIONS)

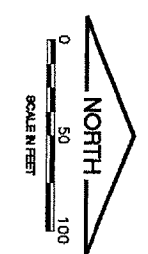

RUNWAY 9/27

27

RADIUS CONTROL POINTS				
POINT	RADIUS*	STATION/OFFSET	NORTHING	EASTING
1	35'	506+99.71, 53' LT BASELINE ENTRANCE RD.	1776927.78	720005.31
2	35'	507+00, 53' RT BASELINE ENTRANCE RD.	1776929.81	720111.16
3	7.5'	499+99.65, 42' LT BASELINE ENTRANCE RD.	1776598.63	719709.81
4	6'	500+37.16, 44' LT BASELINE ENTRANCE RD.	1776623.38	719747.14
5	6'	502+82.00, 19' LT BASELINE ENTRANCE RD.	1776624.55	719919.13
6	6'	500+37.16, 18' LT BASELINE ENTRANCE RD.	1776597.38	719747.31
7	6'	502+56.00, 19' LT BASELINE ENTRANCE RD.	1776598.55	719919.31
8	6'	500+37.15, 18' RT BASELINE ENTRANCE RD.	1776561.38	719747.56
9	6'	502+9.15, 18' RT BASELINE ENTRANCE RD.	1776562.55	719919.56
10	6'	504+22.14, 204' RT BASELINE ENTRANCE RD.	1776562.73	719946.55
11	50'	503+52.15, 63' RT BASELINE ENTRANCE RD.	1776705.10	720000.58
12	45'	505+95.74, 63' LT BASELINE ENTRANCE RD.	1776824.08	771997.09
13	65'	505+91.57, 47' LT BASELINE ENTRANCE RD.	1776820.19	720013.16

\* NOTE: ALL RADIUS' ARE TO EDGE OF PAVEMENT.

REVISIONS		
NUMBER	BY	DATE

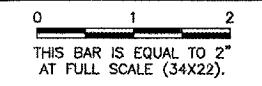

**LANSING MUNICIPAL AIRPORT  
 LANSING, ILLINOIS  
 NORTH QUADRANT SITEWORK - PHASE 1  
 AND TAXIWAY G2 EXTENSION  
 LIGHTING AND PAVEMENT MARKING PLAN  
 NORTH QUADRANT SITEWORK AND  
 AUTO PARKING LOT**

Copyright CMT, Inc.  
**CMT**  
 CRAWFORD, MURPHY & TILLY, INC.  
 CONSULTING ENGINEERS  
 License No. 184-006913

DESIGN BY:	ARM
DRAWN BY:	JRO
CHECKED BY:	ARM
APPROVED BY:	
DATE:	03/04/05
JOB No:	03297-02
IL PROJECT: IGQ-3329 A.I.P. PROJECT: 3-17-0121-B21	

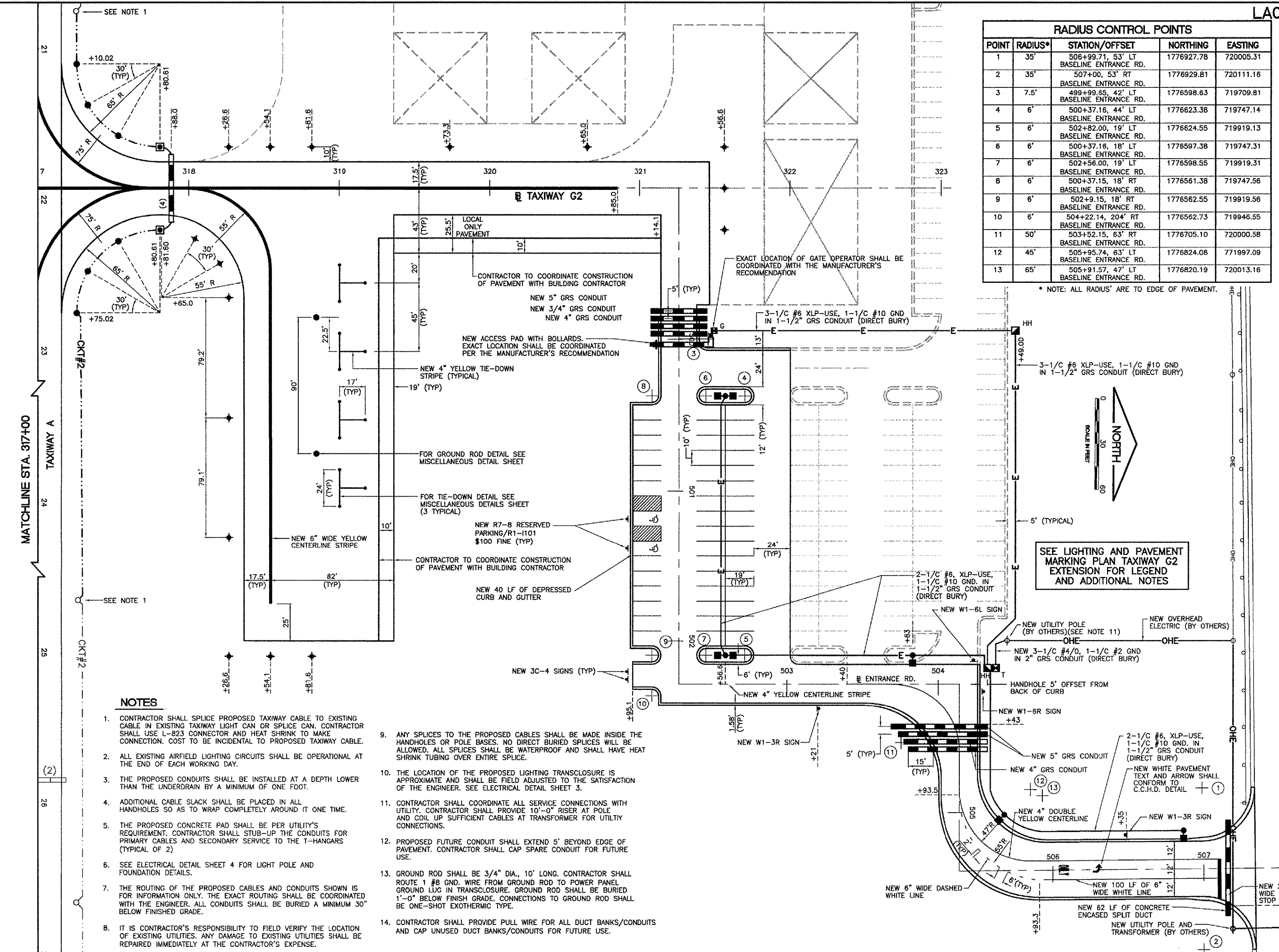

**NOTES**

- CONTRACTOR SHALL SPLICE PROPOSED TAXIWAY CABLE TO EXISTING CABLE IN EXISTING TAXIWAY LIGHT CAN OR SPLICE CAN. CONTRACTOR SHALL USE L-823 CONNECTOR AND HEAT SHRINK TO MAKE CONNECTION. COST TO BE INCIDENTAL TO PROPOSED TAXIWAY CABLE.
- ALL EXISTING AIRFIELD LIGHTING CIRCUITS SHALL BE OPERATIONAL AT THE END OF EACH WORKING DAY.
- THE PROPOSED CONDUITS SHALL BE INSTALLED AT A DEPTH LOWER THAN THE UNDERDRAIN BY A MINIMUM OF ONE FOOT.
- ADDITIONAL CABLE SLACK SHALL BE PLACED IN ALL HANDHOLES SO AS TO WRAP COMPLETELY AROUND IT ONE TIME.
- THE PROPOSED CONCRETE PAD SHALL BE PER UTILITY'S REQUIREMENT. CONTRACTOR SHALL STUB-UP THE CONDUITS FOR PRIMARY CABLES AND SECONDARY SERVICE TO THE T-HANGARS (TYPICAL OF 2)
- SEE ELECTRICAL DETAIL SHEET 4 FOR LIGHT POLE AND FOUNDATION DETAILS.
- THE ROUTING OF THE PROPOSED CABLES AND CONDUITS SHOWN IS FOR INFORMATION ONLY. THE EXACT ROUTING SHALL BE COORDINATED WITH THE ENGINEER. ALL CONDUITS SHALL BE BURIED A MINIMUM 30" BELOW FINISHED GRADE.
- IT IS CONTRACTOR'S RESPONSIBILITY TO FIELD VERIFY THE LOCATION OF EXISTING UTILITIES. ANY DAMAGE TO EXISTING UTILITIES SHALL BE REPAIRED IMMEDIATELY AT THE CONTRACTOR'S EXPENSE.
- ANY SPLICES TO THE PROPOSED CABLES SHALL BE MADE INSIDE THE HANDHOLES OR POLE BASES. NO DIRECT BURIED SPLICES WILL BE ALLOWED. ALL SPLICES SHALL BE WATERPROOF AND SHALL HAVE HEAT SHRINK TUBING OVER ENTIRE SPLICE.
- THE LOCATION OF THE PROPOSED LIGHTING TRANSCLOSURE IS APPROXIMATE AND SHALL BE FIELD ADJUSTED TO THE SATISFACTION OF THE ENGINEER. SEE ELECTRICAL DETAIL SHEET 3.
- CONTRACTOR SHALL COORDINATE ALL SERVICE CONNECTIONS WITH UTILITY. CONTRACTOR SHALL PROVIDE 10'-0" RISER AT POLE AND COIL UP SUFFICIENT CABLES AT TRANSFORMER FOR UTILITY CONNECTIONS.
- PROPOSED FUTURE CONDUIT SHALL EXTEND 5' BEYOND EDGE OF PAVEMENT. CONTRACTOR SHALL CAP SPARE CONDUIT FOR FUTURE USE.
- GROUND ROD SHALL BE 3/4" DIA., 10' LONG. CONTRACTOR SHALL ROUTE 1 #8 GND. WIRE FROM GROUND ROD TO POWER PANEL GROUND LUG IN TRANSCLOSURE. GROUND ROD SHALL BE BURIED 1'-0" BELOW FINISH GRADE. CONNECTIONS TO GROUND ROD SHALL BE ONE-SHOT EXOTHERMIC TYPE.
- CONTRACTOR SHALL PROVIDE PULL WIRE FOR ALL DUCT BANKS/CONDUITS AND CAP UNUSED DUCT BANKS/CONDUITS FOR FUTURE USE.

K:\Lansing\0329702\draw\sheet\FILE: utility.dwg  
 LAYOUT: Layout1  
 UPDATE BY: tmarin  
 SURVEY BOOK #  
 DATE: Wed 6/15/05 2:19pm  
 XREF DWG: tbcint.dwg  
 tb.dwg  
 nethgr-base.dwg

RESTRICTOR PLATE SCHEDULE		
STRUCTURE	TYPE	RESTRICTOR DIAMETER
D2	B	4.0"
H1	A	4.38"
H3	A	4.32"
H4	A	7.9"

WATERMAIN/FIRE HYDRANT SCHEDULE				
POINT NUMBER	STATION/OFFSET	NORTHING	EASTING	ELEVATION
1	16+66.10, 154.53' LT. @ TAXIWAY A	1776301.35	719085.79	-
2	16+74.10, 154.53' LT. @ TAXIWAY A	1776301.41	719093.79	RIM=MATCH EXISTING
3	17+05.15, 123.49' LT. @ TAXIWAY A	1776270.58	719125.05	-
4	24+96.38, 123.49' LT. @ TAXIWAY A	1776276.08	719916.26	-
5	25+10.52, 137.63' LT. @ TAXIWAY A	1776290.32	719930.30	-
6	502+59.36, 35' LT @ ENTRANCE RD.	1771559.69	732246.75	G/L= 616.78
7	503+11.14, 3' RT @ ENTRANCE RD.	1771611.48	732285.25	RIM= 615.84
8	505+59.06, 144' LT @ ENTRANCE RD.	1771735.46	732261.12	-
9	505+87, 160' LT @ ENTRANCE RD.	1771763.40	732244.91	-
10	323+56.42, 100.61' RT. @ TAXIWAY G2	1776809.47	719709.30	G/L= 614.25
11	323+51.12, 75.61' RT. @ TAXIWAY G2	1776804.00	719684.33	-
12	325+75.87, 75.61' RT. @ TAXIWAY G2	1777028.75	719682.77	RIM=MATCH EXISTING

FOR CONTINUATION  
SEE INSET THIS SHEET

**UNDERDRAIN NOTES**

- CONTRACTOR SHALL FIELD VERIFY EXISTING UNDERDRAIN INVERTS BEFORE INSTALLING PROPOSED UNDERDRAIN, CONNECTIONS AND ORDERING UNDERDRAIN MATERIALS.
- ALL UNDERDRAIN CONNECTIONS, CORING INTO STRUCTURES, TEES, BENDS, STORM SEWER ETC. SHALL BE CONSIDERED INCIDENTAL TO THE COST OF THE UNDERDRAIN.
- UNDERDRAIN SLOPES FOLLOW EDGE OF PAVEMENT SLOPE UNLESS OTHERWISE NOTED.
- INSTALL PROPOSED ELECTRICAL DUCTS/CONDUITS TO BE CLEAR OF UNDERDRAIN, COST INCIDENTAL.
- UNDERDRAIN CONFLICTS WITH EXISTING CONDITIONS SHALL BE RESOLVED AND COST SHALL BE INCIDENTAL TO UNDERDRAIN.
- PRIOR TO ORDERING AND INSTALLING ALL FIELD TILE REPLACEMENT PIPE, THE CONTRACTOR SHALL FIELD VERIFY THE LOCATION AND INVERTS OF EXISTING FIELD TILE CONNECTIONS. ADJUSTMENTS SHALL BE MADE AS NECESSARY AT NO ADDITIONAL COST TO THE CONTRACT.
- CORING OF DRAINAGE STRUCTURE AND REMOVAL OF EXISTING STORM SEWER MANHOLE/INLET CONCRETE BENCHES TO FACILITATE CONNECTIONS OF PROPOSED STORM SEWER PIPE SHALL BE CONSIDERED INCIDENTAL TO THE COST OF THE PIPE.

REVISIONS		
NUMBER	BY	DATE
1	ARM	6/10/05

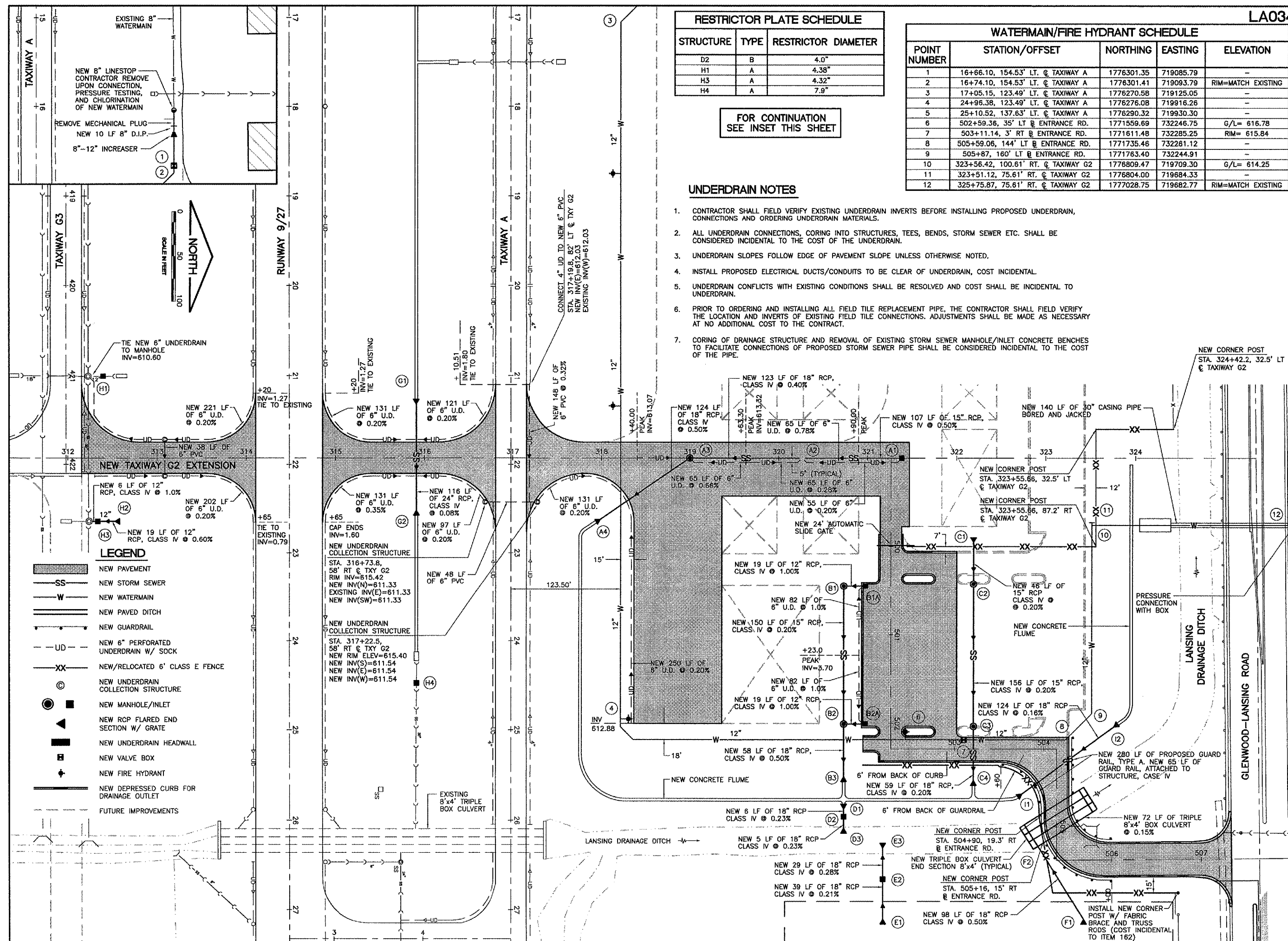
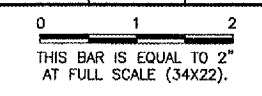



REVISIONS		
NUMBER	BY	DATE

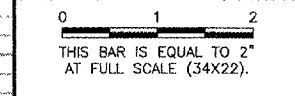

**LANSING MUNICIPAL AIRPORT  
 LANSING, ILLINOIS  
 NORTH QUADRANT SITework - PHASE 1  
 AND TAXIWAY G2 EXTENSION  
 STORM SEWER PROFILES**

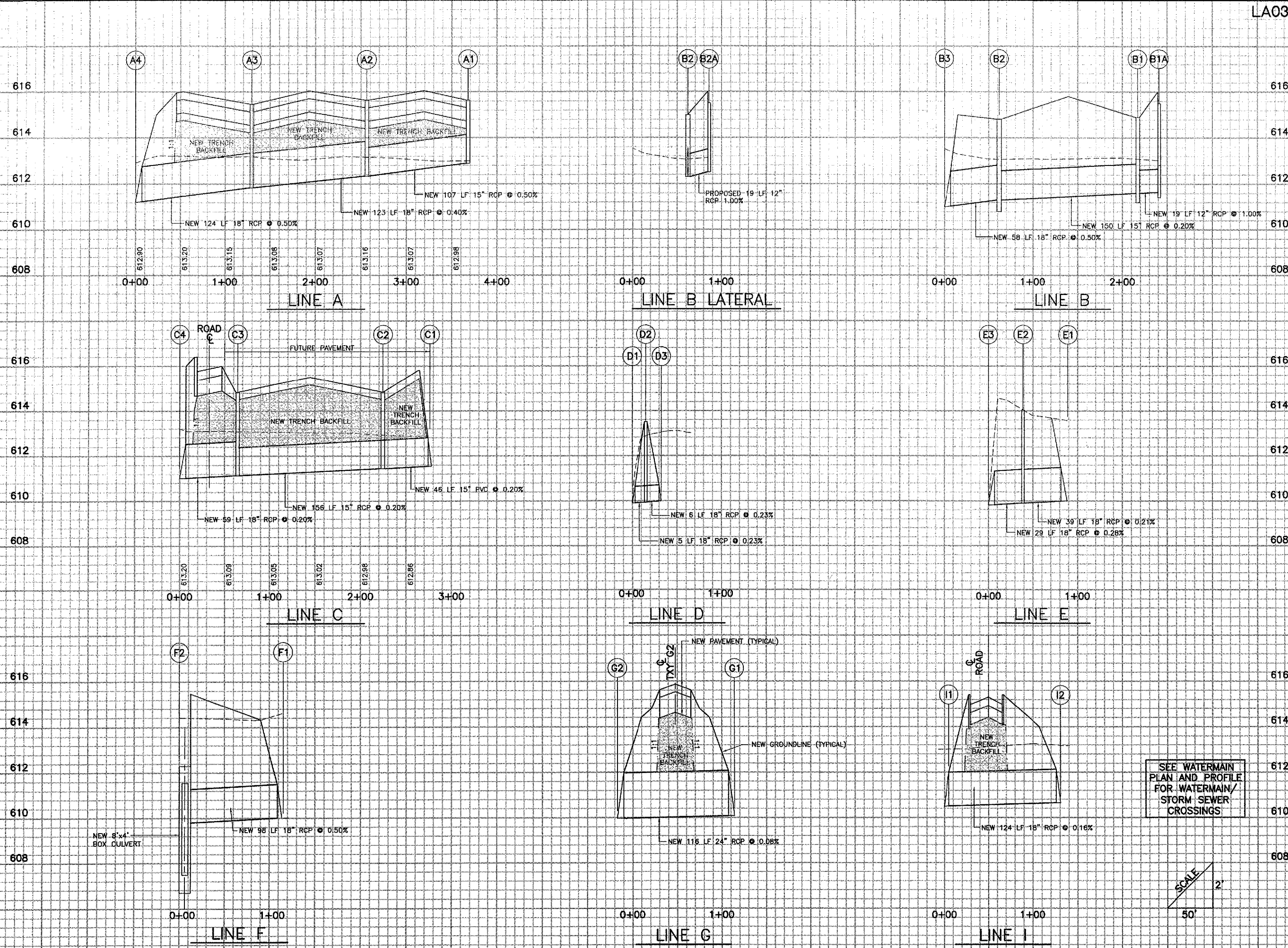

SEE WATERMAIN  
 PLAN AND PROFILE  
 FOR WATERMAIN/  
 STORM SEWER  
 CROSSINGS

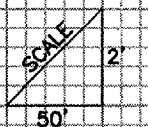

© Copyright CMT, Inc.

**CMT**  
 CRAWFORD, MURPHY & TILLY, INC.  
 CONSULTING ENGINEERS  
 License No. 984-000618

Lansing Municipal  
**airport**

DESIGN BY:	ARM
DRAWN BY:	JRO
CHECKED BY:	ARM
APPROVED BY:	
DATE:	03/04/05
JOB No:	03297-02
IL PROJECT: IGQ-3329 A.I.P. PROJECT: 3-17-0121-B21	
SHEET 16 OF 50 SHEETS	



**LEGEND**

- |  |                       |  |                                      |
|--|-----------------------|--|--------------------------------------|
|  | NEW PAVEMENT          |  | EXISTING GAS LINE                    |
|  | NEW WATERMAIN         |  | EXISTING GUARDRAIL                   |
|  | NEW STORM SEWER       |  | NEW LINE STOP                        |
|  | NEW FENCE             |  | NEW FIRE HYDRANT                     |
|  | NEW UNDERDRAIN        |  | NEW 8"x12" INVERTER                  |
|  | NEW GUARDRAIL         |  | NEW GATE VALVE AND BOX               |
|  | EXISTING CONTOUR      |  | NEW INLET/MANHOLE/FLARED END SECTION |
|  | EXISTING STORM SEWER  |  | NEW PAVED DITCH                      |
|  | EXISTING UNDERDRAIN   |  | EXISTING INLET/MANHOLE               |
|  | EXISTING WATERMAIN    |  | EXISTING SLOPE BOX                   |
|  | EXISTING RIGHT-OF-WAY |  |                                      |

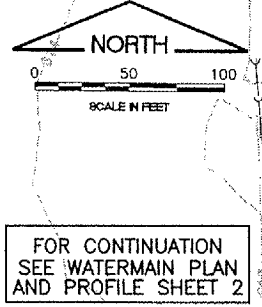

**REVISIONS**

NUMBER	BY	DATE

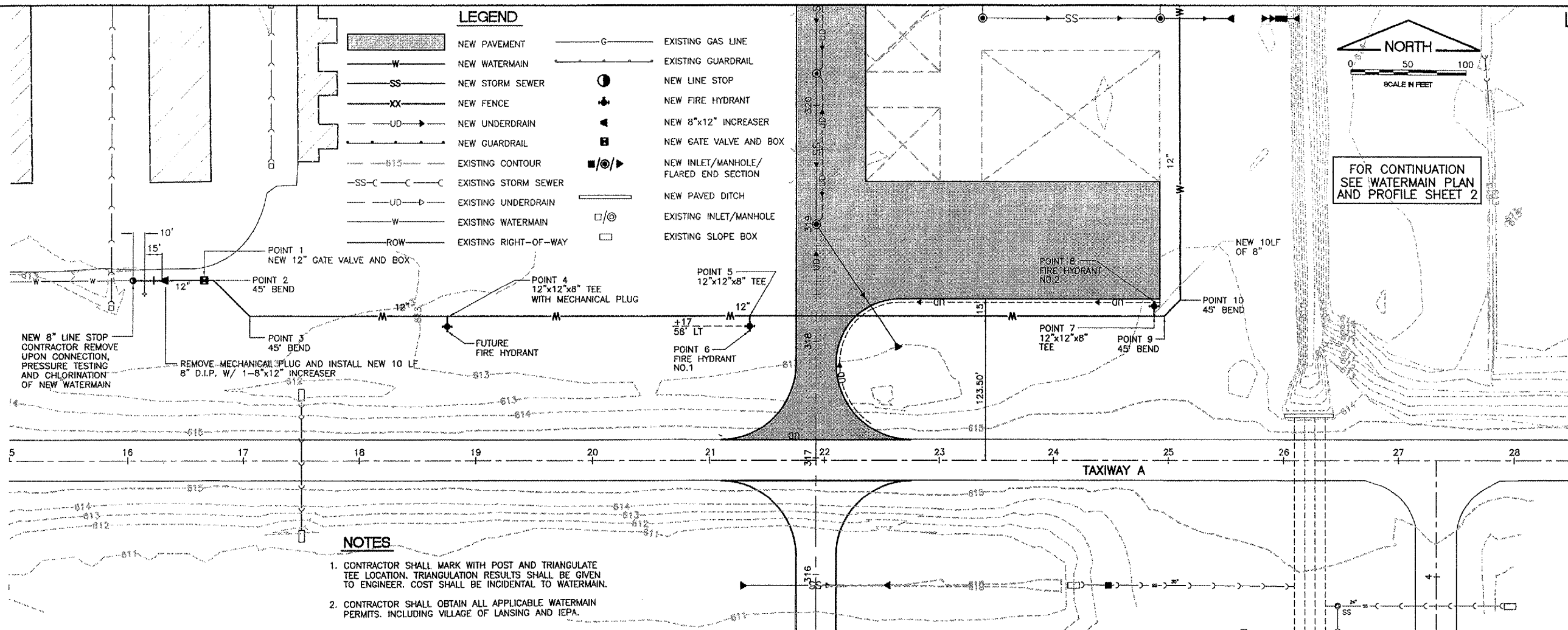
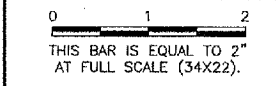

- NOTES**
- CONTRACTOR SHALL MARK WITH POST AND TRIANGULATE TEE LOCATION. TRIANGULATION RESULTS SHALL BE GIVEN TO ENGINEER. COST SHALL BE INCIDENTAL TO WATERMAIN.
  - CONTRACTOR SHALL OBTAIN ALL APPLICABLE WATERMAIN PERMITS, INCLUDING VILLAGE OF LANSING AND IEPA.

**LANSING MUNICIPAL AIRPORT  
 LANSING, ILLINOIS  
 NORTH QUADRANT SITEWORK - PHASE 1  
 AND TAXIWAY G2 EXTENSION  
 WATERMAIN PLAN AND PROFILE  
 SHEET 1**

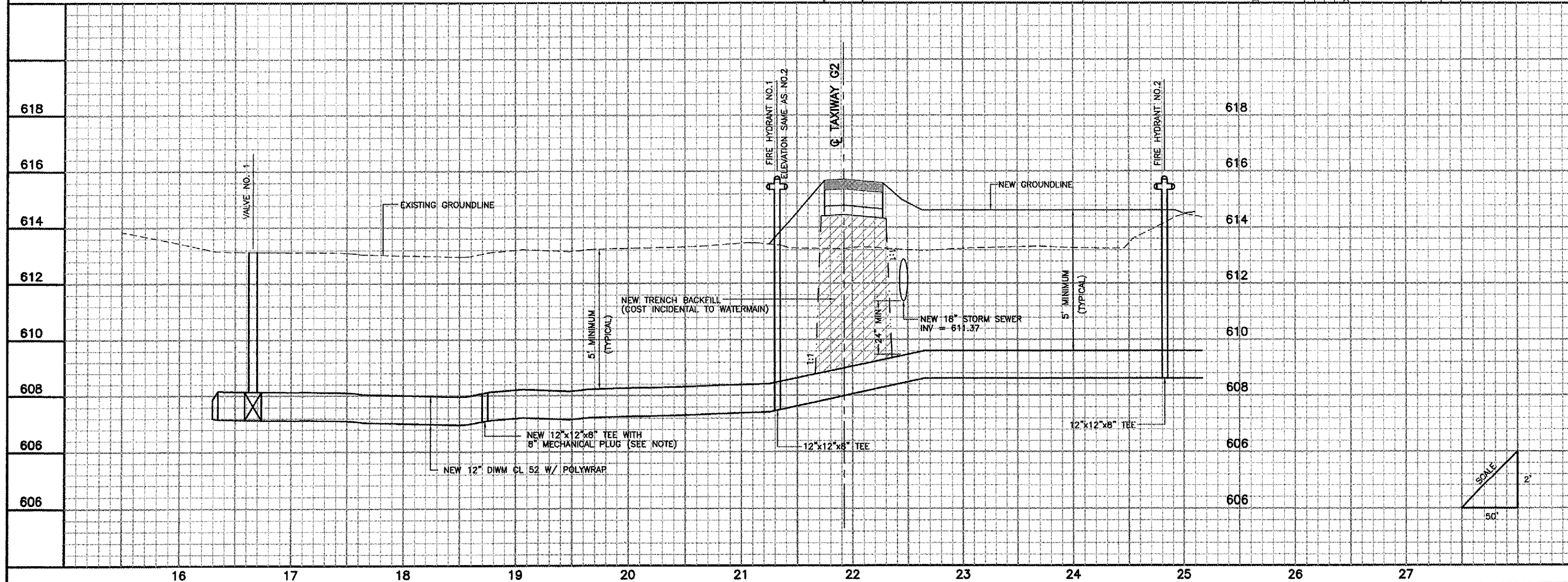

© Copyright CMT, Inc.

**CMT**  
 CRAWFORD, MURPHY & TILLY, INC.  
 CONSULTING ENGINEERS  
 License No. 184-000618

Lansing Municipal Airport

DESIGN BY:	MJW/ARM
DRAWN BY:	JRO
CHECKED BY:	ARM
APPROVED BY:	
DATE:	03/04/05
JOB No:	03297-02

IL PROJECT: IGQ-3329  
 A.I.P. PROJECT: 3-17-0121-B21

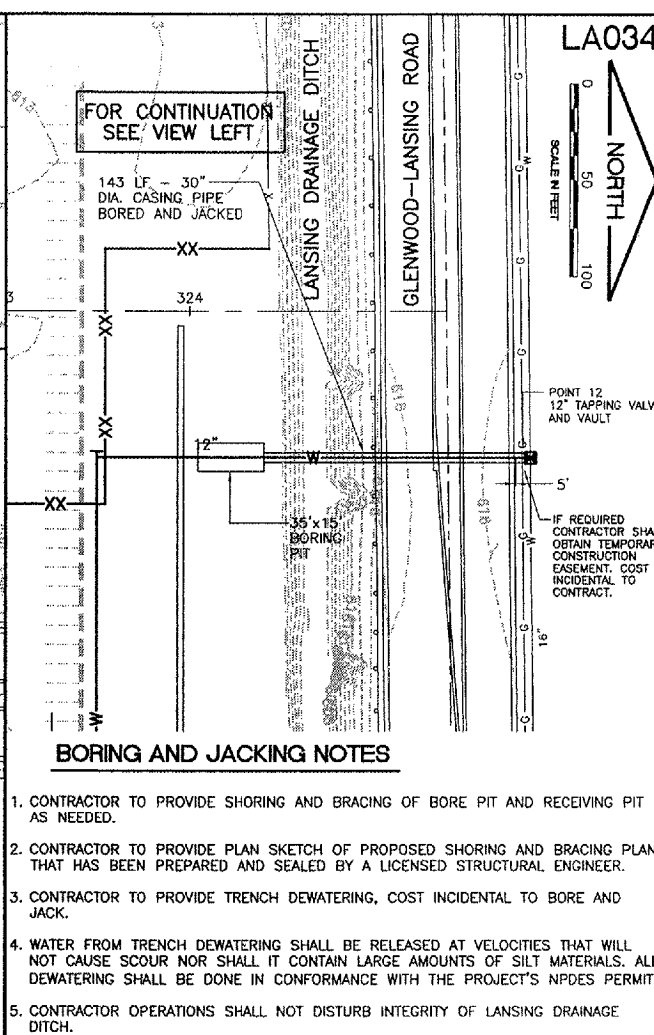
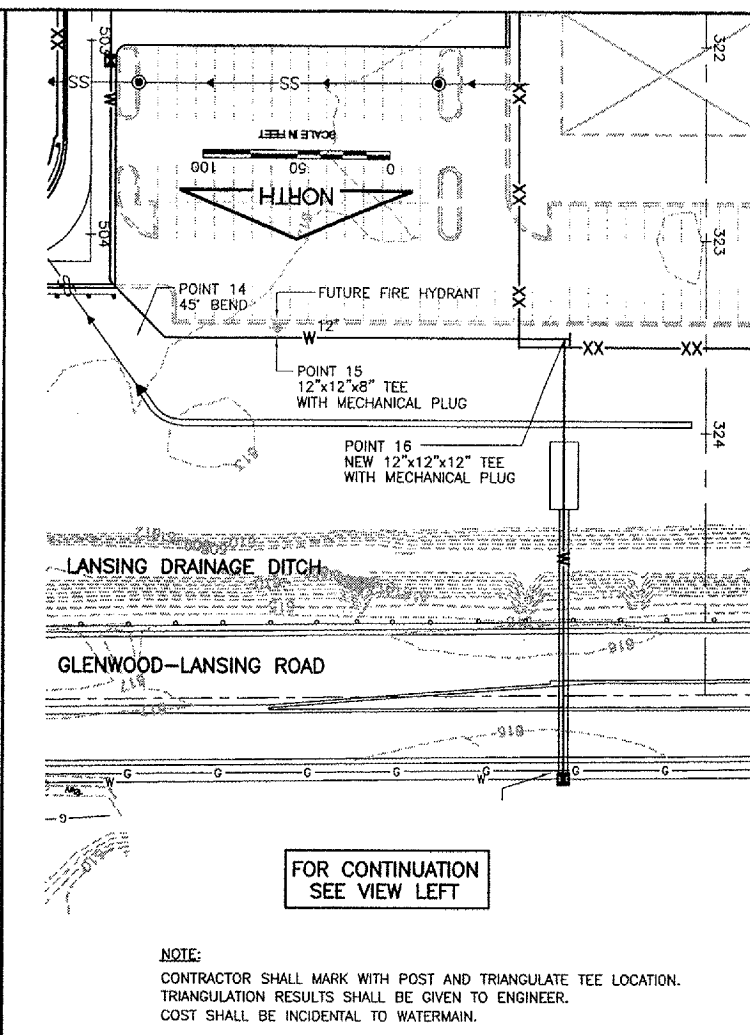
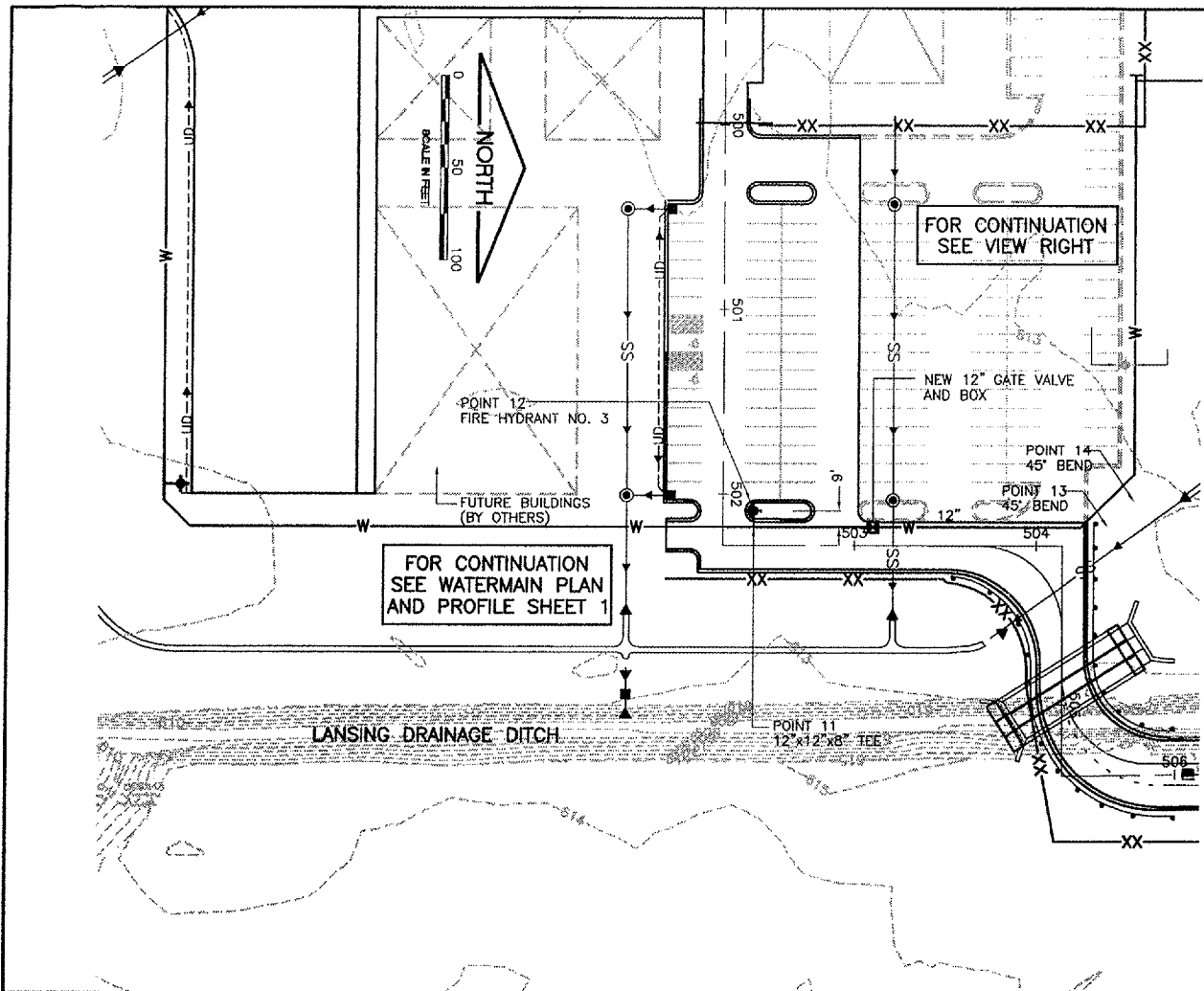

LA034

K:\LansingAp\0329702\draw\sheet\FILE: water-pp2.dwg  
 LAYOUT: Layout1  
 UPDATE BY: johse  
 SURVEY BOOK # 1  
 DATE: Mon 3/14/05 2:36pm  
 XREF DWG: nethgr-base.dwg  
 tbcont.dwg  
 tb.dwg  
 tbrfgrd.dwg

REVISIONS		
NUMBER	BY	DATE

0 1 2

THIS BAR IS EQUAL TO 2" AT FULL SCALE (34X22).

LANSING MUNICIPAL AIRPORT  
 LANSING, ILLINOIS

NORTH QUADRANT SITWORK - PHASE 1  
 AND TAXIWAY G2 EXTENSION

WATERMAIN PLAN AND PROFILE  
 SHEET 2

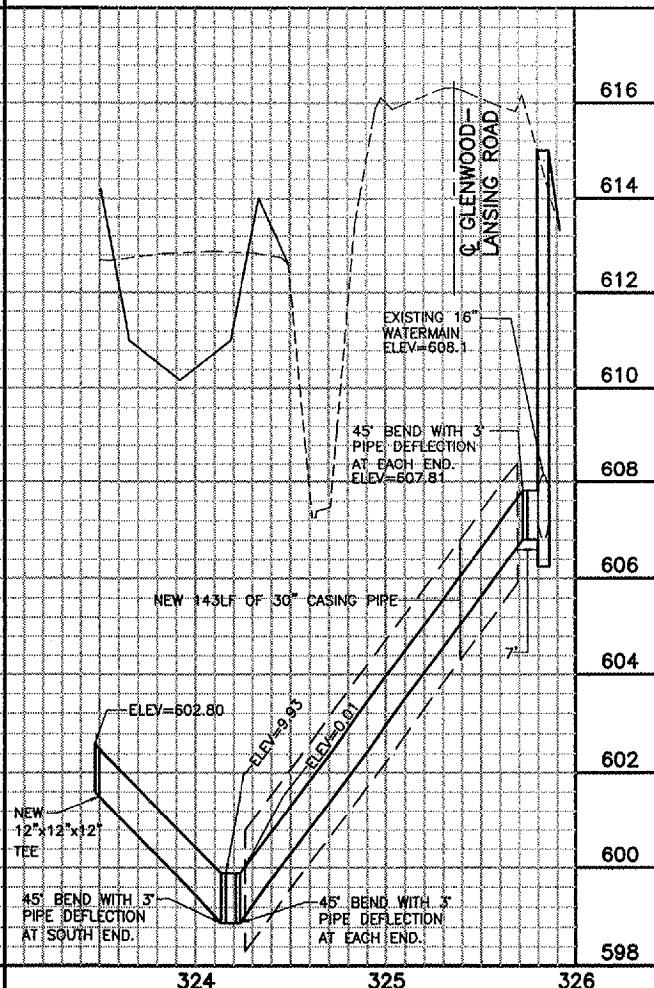
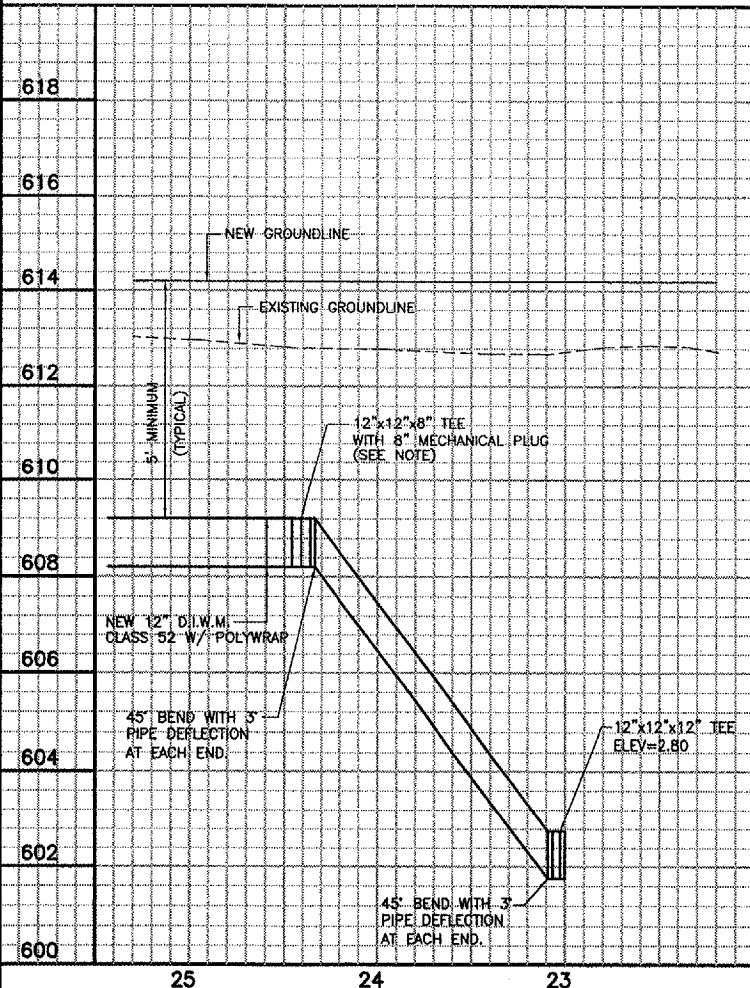
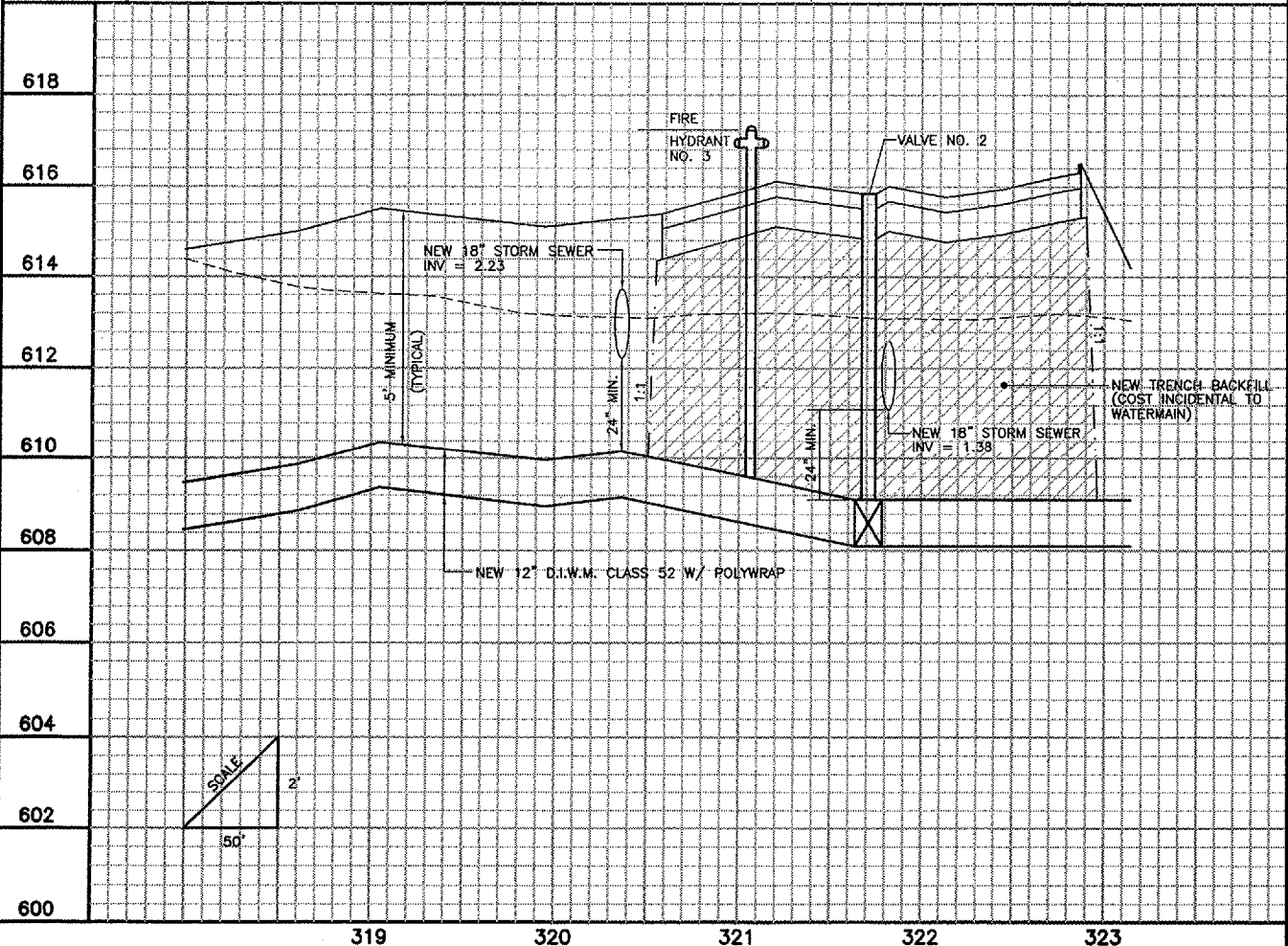

© Copyright CMT, Inc.

**CMT**  
 CRAWFORD, MURPHY & TILLY, INC.  
 CONSULTING ENGINEERS  
 License No. 94-00053

Lansing Municipal Airport

DESIGN BY: MJW/ARM

DRAWN BY: JRO

CHECKED BY: ARM

APPROVED BY:

DATE: 03/04/05

JOB No: 03297-02

IL PROJECT: IGQ-3329  
 A.I.P. PROJECT: 3-17-0121-B21

SHEET 18 OF 50 SHEETS

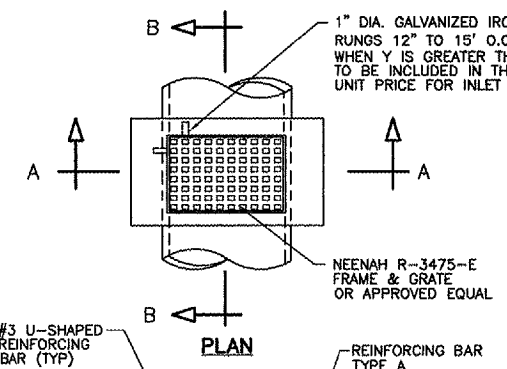

**REINFORCING BAR SCHEDULE**

TYPE	PER INLET	DIMENSIONS	SIZE	APPROX. WT. OF BARS IN INLET
A	2	3'4" x 2'4"	#5	16.7

REINFORCING STEEL BARS TYPES

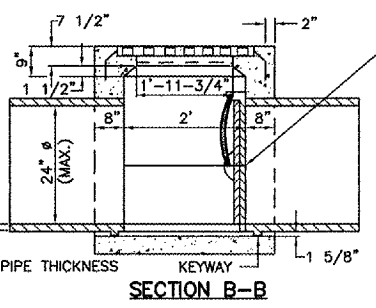
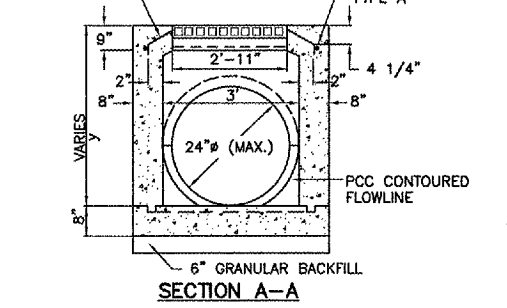
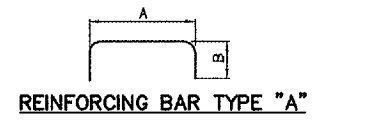

**TYPE 1 INLET**  
NOT TO SCALE

**NOTES**

- 1/2" CHAMFER TO BE USED ON ALL EXPOSED CORNERS ON INLETS. BARS TO BE INSTALLED 2" FROM FACE OF WALL.
- INLET TO BE CONSTRUCTED OF STRUCTURAL P.C. CONCRETE. THE CONTRACT UNIT PRICE FOR INLET SHALL INCLUDE THE GRATE AND FRAME AS SPECIFIED.

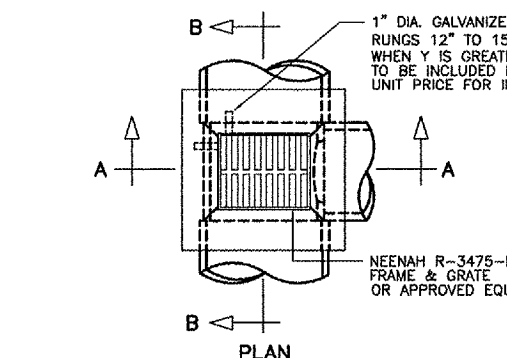

**REINFORCING BAR SCHEDULE**

TYPE	PER INLET	DIMENSIONS	SIZE	APPROX. WT. OF BARS IN INLET
A	4	5'-4" x 3'-4"	#5	43.1

- 1/2" CHAMFER TO BE USED ON ALL EXPOSED CORNERS OF INLETS. BARS TO BE INSTALLED 2" FROM FACE OF WALL.
- INLET TO BE CONSTRUCTED OF STRUCTURAL P.C. CONCRETE. THE CONTRACT UNIT PRICE FOR INLET SHALL INCLUDE THE GRATE AND FRAME AS SPECIFIED.

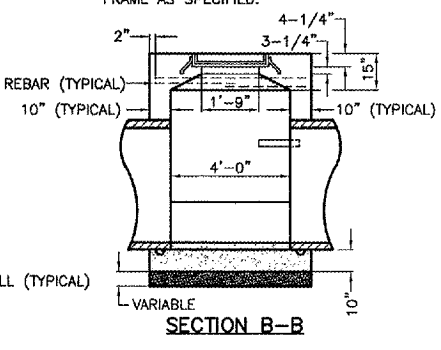
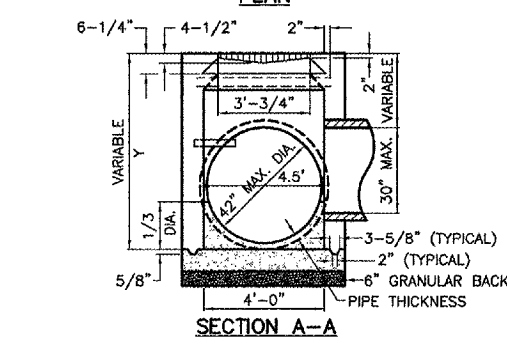

**PROPOSED TYPE 2 INLET**  
NOT TO SCALE

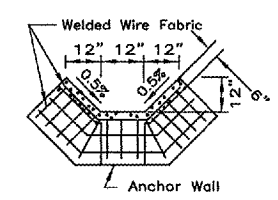

**SECTION B-B**

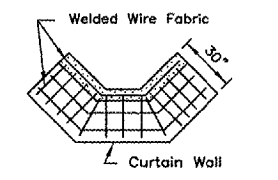

**SECTION C-C**

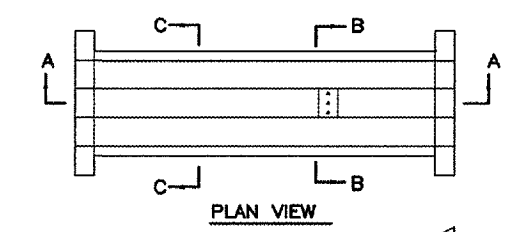

**PLAN VIEW**

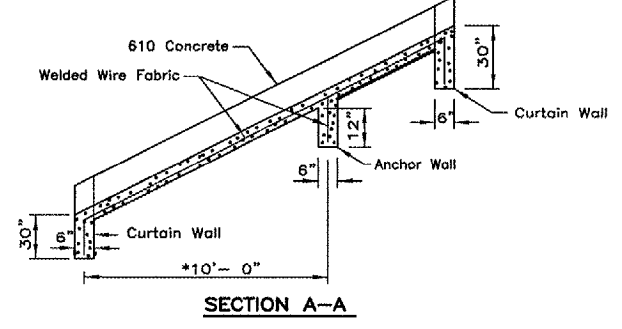

**SECTION A-A**

**CONCRETE FLUME**  
NOT TO SCALE

- \* The maximum typical spacing between Anchor Walls and Curtain Walls shall be 10'-0" from center to center.

**AUTOMATIC DRAINAGE GATE NOTES:**

1. EPON SYSTEM C6 EPOXY ANCHORS MANUFACTURED BY ITW, RAMSET, REDHEAD CO. OR EQUAL SHALL BE USED FOR ANCHORING THE BOLTS.
2. ANCHOR BOLT SIZE SHALL BE AS SPECIFIED BY DRAINAGE GATE MANUFACTURER. ALL ANCHOR BOLTS, SCREWS AND NUTS SHALL BE GALVANIZED STEEL, ASTM A307 AND ASTM A164 OF AMPLE SECTION TO SAFELY WITHSTAND FORCES CREATED BY OPERATION SHOWN ON MANUFACTURER'S GATE SCHEDULE.
3. USE OF MECHANICAL/EXPANSION TYPE ANCHORS SHALL NOT BE CONSIDERED AS AN ACCEPTABLE ALTERNATE TO THE SPECIFIED CHEMICAL SYSTEMS.
4. ANCHOR BOLTS SHALL BE EMBEDDED A MINIMUM DEPTH OF 6" INTO THE PRECAST PORTION OF THE TYPE 1 INLET AND TYPE 2 INLET WALLS, ANCHORING THE BOLTS INTO THE MORTARED PORTION OF THE INLET BETWEEN THE OUTSIDE OF THE DRAINAGE PIPE AND THE OPENING OF THE DRAINAGE INLET WILL NOT BE ALLOWED.
5. ANCHOR BOLTS SHALL BE INSTALLED IN THE PRECAST PORTION A MINIMUM OF 3" FROM THE FACE OF THE DRAINAGE STRUCTURE PIPE OPENING.
6. AUTOMATIC DRAINAGE GATES SHALL BE NEENAH R-5050-SF OR EQUAL WITH MINIMUM SIZES AS SHOWN BELOW:

- R-5050-SF30 FOR 18" DIAMETER PIPE OPENING.

INSIDE DIAMETER OF STORM SEWER (INCHES)	MAXIMUM TRENCH WIDTH
6	3'-7"
8	3'-9"
12	4'-2"
15	4'-6"
18	4'-9"
21	5'-0"
24	5'-4"
27	5'-7"
30	5'-11"
36	6'-6"
42	7'-1"
48	7'-8"
54	8'-3"
60	8'-10"
66	9'-5"
72	10'-0"
78	10'-7"
84	11'-2"
90	11'-9"
96	12'-4"
102	12'-11"
108	13'-6"

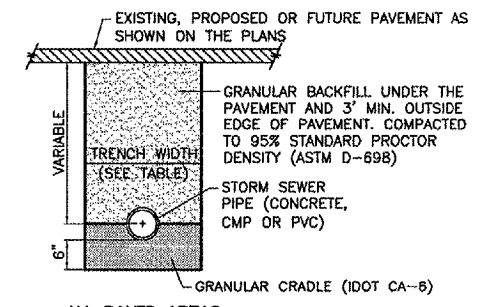

**ALL PAVED AREAS**

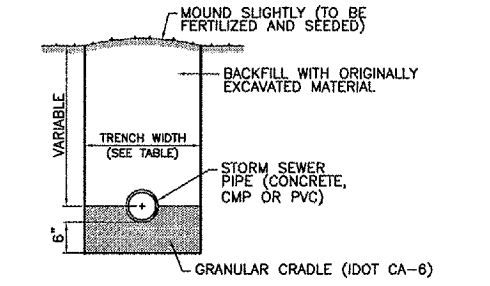

**NON-PAVED AREAS**

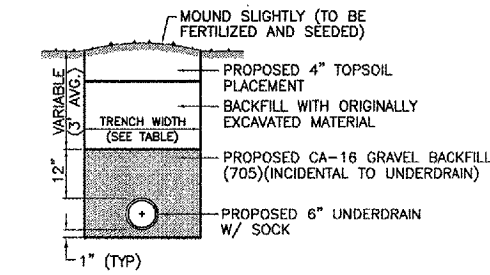

**NON-PAVED AREAS AT UNDERDRAIN OUTLET**

**TRENCH DETAILS - STORM SEWER**  
NOT TO SCALE

**REVISIONS**

NUMBER	BY	DATE
1	ARM	6/10/05

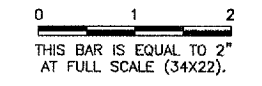

**LANSING MUNICIPAL AIRPORT  
LANSING, ILLINOIS  
NORTH QUADRANT SITEWORK - PHASE 1  
AND TAXIWAY G2 EXTENSION  
DRAINAGE DETAILS - SHEET 1**

Copyright: CMT, Inc.

**CMT**  
CRAWFORD, MURPHY & TILLY, INC.  
CONSULTING ENGINEERS  
License No. 84-000613

Lansing Municipal Airport

DESIGN BY:	ARM
DRAWN BY:	JRO
CHECKED BY:	ARM
APPROVED BY:	
DATE:	03/04/05
JOB No:	03297-02
IL PROJECT: IGQ-3329 A.I.P. PROJECT: 3-17-0121-B21	



DRAINAGE STRUCTURE SCHEDULE

POINT NO.	STATION / OFFSET	DESCRIPTION	RIM	INVERT
A1	STA. 321+38.0 CENTERLINE OF TXY G2	TYPE 1 INLET	615.54	15" RCP SOUTH = 612.88 6" U.D. SOUTH = 613.21
A2	STA. 320+26.7 CENTERLINE OF TXY G2	TYPE 1 INLET	615.64	15" RCP NORTH = 612.33 18" RCP SOUTH = 612.33 6" U.D. NORTH = 612.89 6" U.D. SOUTH = 612.89
A3	STA. 319+00.0 CENTERLINE OF TXY G2	TYPE A-4 MANHOLE WITH TYPE 1 OPEN FRAME AND LID	615.30	18" RCP NORTH = 611.84 18" RCP SOUTHWEST = 611.84 6" U.D. NORTH = 612.46
A4	STA. 317+92.5, 72.6' RT. CENTERLINE OF TXY G2	CONCRETE FLARED END SECTION WITH GRATE - 18"	N.A.	611.20
B1	STA. 500+45.64, 52.58' RT BASELINE ENTRANCE RD.	TYPE A-4 MANHOLE WITH TYPE 1 FRAME AND OPEN LID	614.80	12" RCP NORTH = 611.62 15" RCP EAST = 611.62
B2	STA. 502+00.64, 52.58' RT BASELINE ENTRANCE RD.	TYPE A-5 MANHOLE WITH TYPE 1 FRAME AND OPEN LID	614.70	12" RCP NORTH = 611.32 18" RCP EAST = 611.32 15" RCP WEST = 611.32
B3	STA. 504+50, 238.57' RT BASELINE ENTRANCE RD.	CONCRETE FLARED END SECTION WITH GRATE - 18"	N.A.	611.00
B1A	STA. 500+45.64, 32.58' RT BASELINE ENTRANCE RD.	TYPE A INLET WITH TYPE 12 FRAME AND LID	615.50	12" RCP SOUTH = 611.81 6" U.D. SOUTHWEST=612.88
B2A	STA. 502+00.64, 32.58' RT BASELINE ENTRANCE RD.	TYPE A INLET WITH TYPE 12 FRAME AND LID	615.50	12" RCP SOUTH = 611.51 6" U.D. SOUTHWEST=612.88
C1	STA. 499+91.38, 93' LT BASELINE ENTRANCE RD.	CONCRETE FLARED END SECTION WITH GRATE - 15"	N.A.	611.54
C2	STA. 500+41.57, 93' LT BASELINE ENTRANCE RD.	TYPE A-4 MANHOLE WITH TYPE B LID	614.83	15" RCP EAST = 611.44 15" RCP WEST = 611.44
C3	STA. 503+21.16, 22.42' LT BASELINE ENTRANCE RD.	TYPE A-4 MANHOLE WITH TYPE B LID	614.83	18" RCP EAST = 611.13 15" RCP WEST = 611.13
C4	STA. 503+21.16, 40' RT BASELINE ENTRANCE RD.	CONCRETE FLARED END SECTION WITH GRATE - 18"	N.A.	611.00
D1	STA. 504+75, 238.58' RT BASELINE ENTRANCE RD.	CONCRETE FLARED END SECTION WITH GRATE - 18"	N.A.	609.97
D2	STA. 504+89, 238.58' RT BASELINE ENTRANCE RD.	TYPE 1 INLET WITH RESTRICTOR PLATE ON EAST WALL	613.50	18" RCP EAST = 609.93 18" RCP WEST = 609.94
D3	STA. 505+01.96, 238.58' RT BASELINE ENTRANCE RD.	CONCRETE FLARED END SECTION WITH GRATE - 18"	N.A.	609.90
E1	STA. 10+94.75, 125' RT BASELINE BORROW SITE	CONCRETE FLARED END SECTION WITH GRATE - 18"	N.A.	610.00
E2	STA. 10+50, 125' RT BASELINE BORROW SITE	TYPE 1 INLET WITH AUTOMATIC DRAINAGE GATE ON EAST WALL	614.00	18" RCP EAST = 609.90 18" RCP WEST = 609.90
E3	STA. 10+15, 125' RT BASELINE BORROW SITE	CONCRETE FLARED END SECTION WITH GRATE - 18"	N.A.	609.80
F1	STA. 10+94.75, 99.9' LT BASELINE BORROW SITE	CONCRETE FLARED END SECTION WITH GRATE - 18"	N.A.	610.00
F2	STA. 505+13, 20.5' RT BASELINE ENTRANCE RD.	INTERSECTION WITH BOX CULVERT	N.A.	18" RCP EAST = 609.51
G1	STA. 315+90.9, 65' LT. CENTERLINE OF TXY G2	CONCRETE FLARED END SECTION WITH GRATE - 18"	N.A.	610.07 ± MATCH FLUME INVERT
G2	STA. 315+90.9, 65' RT. CENTERLINE OF TXY G2	CONCRETE FLARED END SECTION WITH GRATE - 18"	N.A.	609.97 ± MATCH FLUME INVERT
H1	STA. 312+39.4, 91.9' LT. CENTERLINE OF TXY G2	TYPE 1 INLET WITH RESTRICTOR PLATE ON SOUTH WALL	614.38±	12" RCP NORTH = 611.36± 12" RCP SOUTH = 611.36±
H2	STA. 312+58, 71.5' RT. CENTERLINE OF TXY G2	CONCRETE FLARED END SECTION WITH GRATE - 12"	N.A.	610.92
H3	STA. 312+33.2, 71.5' RT. CENTERLINE OF TXY G2	TYPE 1 INLET WITH RESTRICTOR PLATE ON SOUTH WALL	614.51	12" RCP NORTH = 610.77± 12" RCP SOUTH = 610.75±
H4	STA. 315+90.9, 254.7' RT. CENTERLINE OF TXY G2	TYPE 2 INLET WITH RESTRICTOR PLATE ON EAST WALL	614.20	30" RCP EAST = 609.51± 30" RCP WEST = 609.51±
I1	STA. 504+67, 43' RT BASELINE ENTRANCE RD.	CONCRETE FLARED END SECTION WITH GRATE - 18"	N.A.	18" RCP SOUTH = 610.45
I2	STA. 506+02.13, 147.61' LT BASELINE ENTRANCE RD.	CONCRETE FLARED END SECTION WITH GRATE - 18"	N.A.	18" RCP NORTH = 610.65

NOTE: 1. ± DENOTES CONTRACTOR SHALL VERIFY RIMS/INVERTS PRIOR TO ORDERING MATERIALS.  
 2. TYPE B GRATES SHALL BE PLACED ON 4" ADJUSTING RINGS.  
 3. TYPE 12 FRAME AND LID RIMS ARE ELEVATIONS AT EDGE OF PAVEMENT.  
 4. TYPE 12 FRAME AND LID STATIONS/OFFSETS ARE REFERENCED TO BACK OF CURB.

REVISIONS

NUMBER	BY	DATE

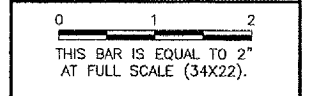

LANSING MUNICIPAL AIRPORT  
 LANSING, ILLINOIS  
 NORTH QUADRANT SITEWORK - PHASE 1  
 AND TAXIWAY G2 EXTENSION  
 DRAINAGE DETAILS AND SCHEDULE - SHEET 2

Copyright: GMT, Inc.  
**GMT**  
 CRAWFORD, MURPHY & TILLY, INC.  
 CONSULTING ENGINEERS  
 License No. 184-000613  
 Lansing Municipal Airport

DESIGN BY:	ARM
DRAWN BY:	JRO
CHECKED BY:	ARM
APPROVED BY:	
DATE:	03/04/05
JOB No:	03297-02

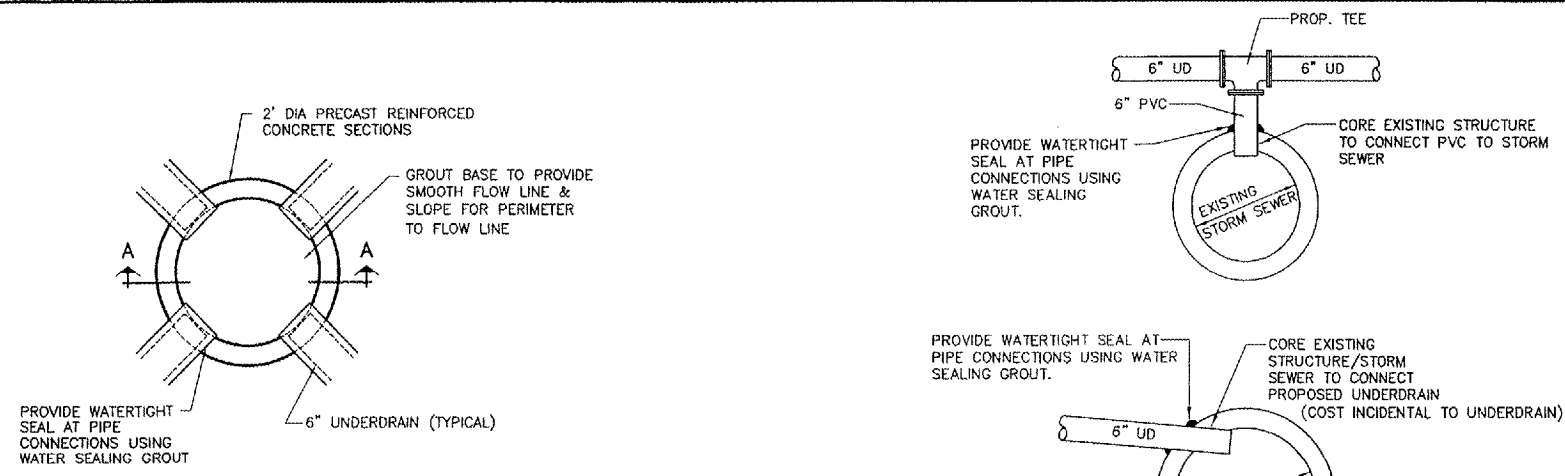

UNDERDRAIN CONNECTION DETAILS

NOT TO SCALE  
 UNDERDRAIN CONNECTIONS AND FITTINGS, TEES AND ELBOWS USED FOR CONNECTIONS TO PROPOSED STRUCTURES AND STORM SEWERS / EXISTING STRUCTURES AND STORM SEWERS, SHALL BE CONSIDERED INCIDENTAL TO THE PROPOSED UNDERDRAIN.

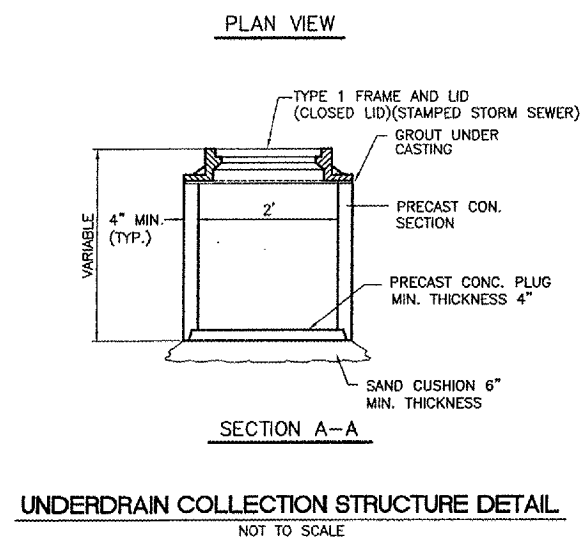

UNDERDRAIN COLLECTION STRUCTURE DETAIL

NOT TO SCALE

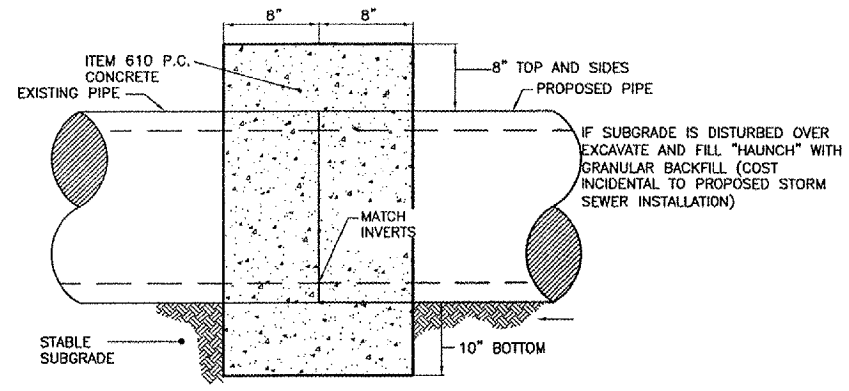

CONCRETE COLLAR - STORM SEWER

NOT TO SCALE

MWRDGC GENERAL NOTES (APPLIES TO ALL SANITARY SEWER)

- THE MWRDGC SEWER PERMIT SECTION FIELD OFFICE MUST BE NOTIFIED AT LEAST TWO (2) DAYS PRIOR TO THE COMMENCEMENT OF WORK (CALL 708-588-4055).
- ELEVATION DATUM IS USGS.
- ALL FLOOR DRAINS SHALL DISCHARGE TO THE SANITARY SEWER.
- ALL DOWNSPOUTS AND FOOTING DRAINS SHALL DISCHARGE TO THE STORM SEWER.
- ALL SANITARY PIPE (AND STORM IN COMBINED AREAS) SHALL CONFORM TO THE FOLLOWING:  
 DUCTILE IRON PIPE ASTM A-21.5  
 PVC ASTM D 3034 SDR26  
 JOINT SPECIFICATIONS SHALL CONFORM TO THE FOLLOWING.  
 DUCTILE IRON PIPE ASTM A-21.11  
 PVC ASTM D 3212
- ALL SANITARY SEWER CONSTRUCTION (AND STORM SEWER CONSTRUCTION IN COMBINED SEWER AREAS) REQUIRES STONE BEDDING 1/4" TO 1" IN SIZE, WITH A MINIMUM BEDDING THICKNESS EQUAL TO 1/4 THE OUTSIDE DIAMETER OF THE SEWER PIPE, BUT NOT LESS THAN FOUR (4) INCHES OR MORE THAN EIGHT (8) INCHES. MATERIAL SHALL BE CA-11 OR CA-13 AND SHALL BE EXTENDED AT LEAST 12" ABOVE THE TOP OF THE PIPE WHEN USING PVC.
- "BAND SEAL" OF SIMILAR FLEXIBLE-TYPE COUPLINGS SHALL BE USED IN THE CONNECTION OF SEWER PIPE OF DISSIMILAR MATERIALS.
- WHEN CONNECTING TO AN EXISTING SEWER MAIN BY MEANS OTHER THAN AN EXISTING WYE, TEE, OR AN EXISTING MANHOLE, ONE OF THE FOLLOWING METHODS SHALL BE USED.  
 1. CIRCULAR SAW-CUT OF SEWER MAIN BY PROPER TOOLS ("SEWER TAP" MACHINE OR SIMILAR) AND PROPER INSTALLATION OF HUB-WYE SADDLE OR HUB-TEE SADDLE.  
 2. REMOVE AN ENTIRE SECTION OF PIPE (BREAKING ONLY THE TOP OF ONE BELL AND REPLACE WITH A WYE OR TEE BRANCH SECTION).  
 3. WITH PIPE CUTTER, NEATLY AND ACCURATELY CUT OUT DESIRED LENGTH OF PIPE FOR INSERTION OF PROPER FITTING, USING "BAND-SEAL" OR SIMILAR COUPLINGS TO HOLD IT FIRMLY IN PLACE.
- WHEREVER A SEWER CROSSES UNDER A WATER MAIN, THE MINIMUM VERTICAL DISTANCE FROM THE TOP OF THE SEWER TO THE BOTTOM OF THE WATER MAIN SHALL BE 18 INCHES, FURTHERMORE, A MINIMUM HORIZONTAL DISTANCE OF 10 FEET BETWEEN SANITARY SEWERS AND WATER MAINS SHALL BE MAINTAINED UNLESS: THE SEWER IS LAID IN A SEPARATE TRENCH, KEEPING A MINIMUM 18" VERTICAL SEPARATION; OR THE SEWER IS LAID IN THE SAME TRENCH WITH THE WATER MAIN LOCATED AT THE OPPOSITE SIDE ON A BENCH OF UNDISTURBED EARTH, KEEPING A MINIMUM 18" VERTICAL SEPARATION. IF EITHER THE VERTICAL OR HORIZONTAL DISTANCES DESCRIBED ABOVE CANNOT BE MAINTAINED, OR THE SEWER CROSSES ABOVE THE WATER MAIN, THE SEWER SHALL BE CONSTRUCTED TO WATER MAIN STANDARDS.
- ALL EXISTING SEPTIC SYSTEMS ARE TO BE ABANDONED. ABANDONED ARE TANKS TO BE FILLED OR REMOVED.
- ALL SANITARY MANHOLES, AND STORM MANHOLES IN COMBINED SEWER AREAS SHALL HAVE A MINIMUM INSIDE DIAMETER OF 48 INCHES, AND SHALL BE CAST IN PLACE OR PRE-CAST REINFORCED CONCRETE.

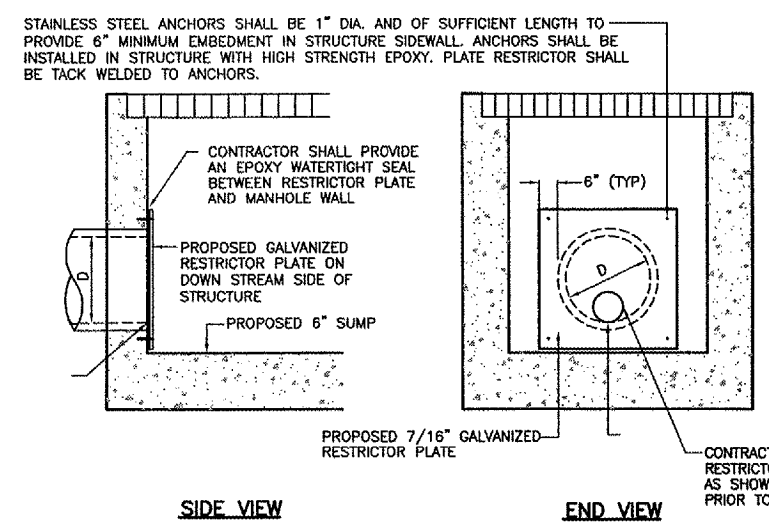

RESTRICTOR PLATE DETAIL-TYPE A

N.T.S.

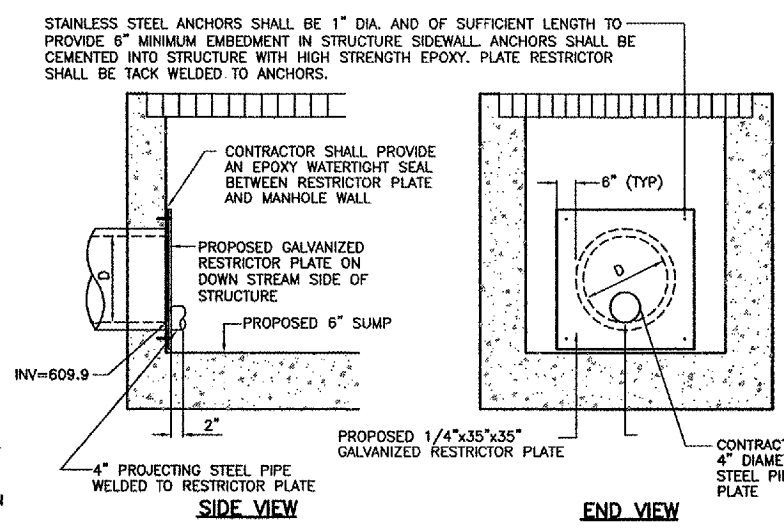

RESTRICTOR PLATE DETAIL-TYPE B

N.T.S.



**NOTES**

1. ALL PRECAST BOX CULVERTS SHALL BE DESIGNED IN ACCORDANCE WITH AASHTO M273, HS-20 LOADING.
2. PRIOR TO BACKFILLING, FILL SOLID THE 3" JOINT BETWEEN BARRELS WITH CONCRETE (610) USING A MAXIMUM SIZE AGGREGATE OF 3/8 INCH.
3. GROUT ALL LIFTING HOLES BEFORE BACKFILLING, ALLOW GROUT TO ACHIEVE MINIMUM STRENGTH BEFORE BACKFILLING.
4. DURING BACKFILL PLACEMENT, DO NOT PERMIT A DIFFERENCE IN FILL ELEVATION ON THE WALLS OF THE CULVERT IN EXCESS OF 2 FEET. DURING COMPACTION, DO NOT ALLOW WHEELS OF ROLLERS TO COME CLOSER THAN ONE FOOT TO THE FACE OF THE STRUCTURE.
5. JOINT MATERIAL BETWEEN PRECAST SECTIONS SHALL CONFORM TO SECTION 1056 OR SECTION 1055 OF IDOT STANDARD SPECIFICATIONS FOR ROAD AND BRIDGE CONSTRUCTION, ADOPTED JANUARY 1, 2002.
6. ALL BOX CULVERT END SECTIONS SHALL HAVE A PRECAST OR CAST IN PLACE TOWEALL.
7. ANY ACCUMULATED DEBRIS WITHIN THE PROJECT AS A RESULT OF THE IMPROVEMENT SHALL BE REMOVED AND DISPOSED OF SATISFACTORILY BY THE CONTRACTOR AS DIRECTED BY THE ENGINEER. THE COST OF THIS WORK WILL NOT BE PAID FOR SEPARATELY BUT SHALL BE CONSIDERED INCIDENTAL TO THE CONTRACT.
8. THE CONTRACTOR SHALL BE RESPONSIBLE FOR THE MAINTENANCE OF DRAINAGE AT ALL TIMES DURING THE CONSTRUCTION OF THE CULVERT. THE METHODS USED BY THE CONTRACTOR SHALL BE SUBJECT TO THE APPROVAL OF THE ENGINEER. THE COST FOR THIS REQUIREMENT WILL NOT BE PAID FOR SEPARATELY BUT SHALL BE CONSIDERED INCIDENTAL TO THE CONTRACT.
9. THE JOINTS SHALL BE EXTERNALLY SEALED ON ALL FOUR SIDES USING EITHER 13 INCH WIDE EXTERNAL SEALING BANDS CONFORMING TO SECTION 1057.01 OR 24" WIDE NONWOVEN GEOTECHNICAL FABRIC MEETING THE REQUIREMENTS OF SECTION 1080.01, IDOT STANDARD SPECIFICATIONS FOR ROAD AND BRIDGE CONSTRUCTION, EXCEPT THE MINIMUM WEIGHT SHALL BE 4 OZ/SY. THE SEAL OR FABRIC SHALL BE CENTERED OVER THE JOINT AND SECURED TO REMAIN IN PLACE DURING THE BACKFILLING OPERATION.

**REVISIONS**

NUMBER	BY	DATE
1	ARM	6/10/05

0 1 2  
 THIS BAR IS EQUAL TO 2" AT FULL SCALE (34x22).

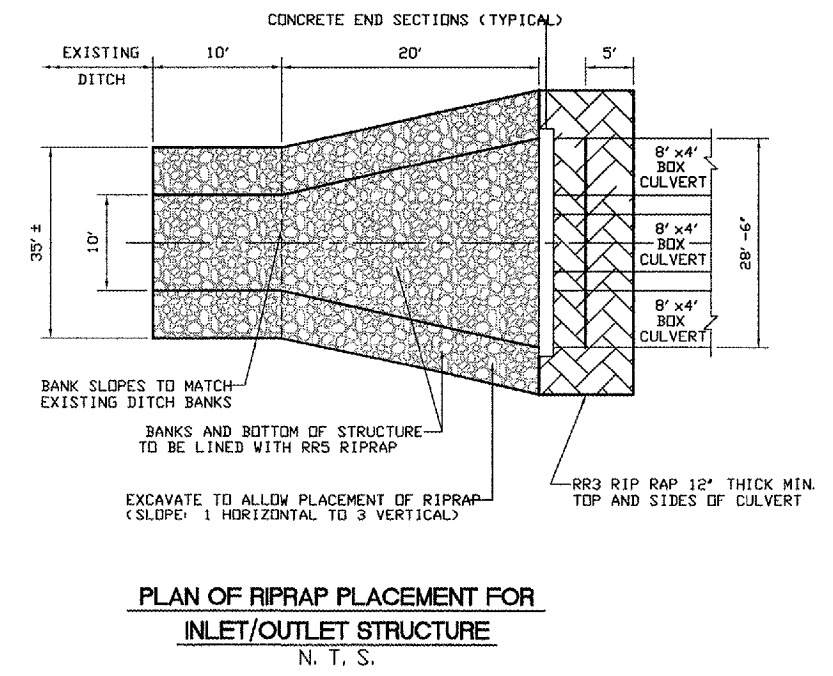
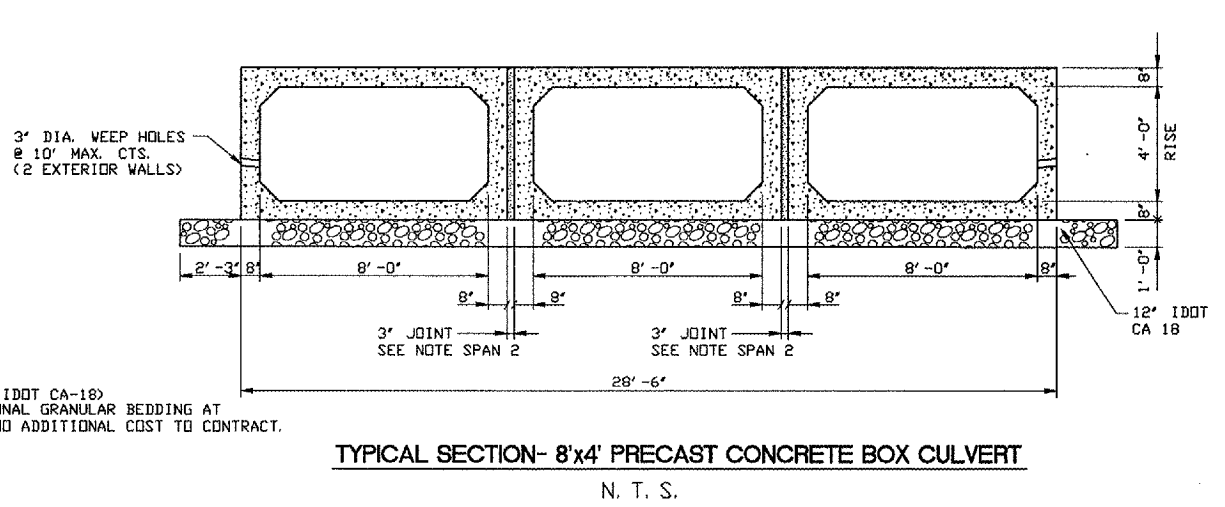
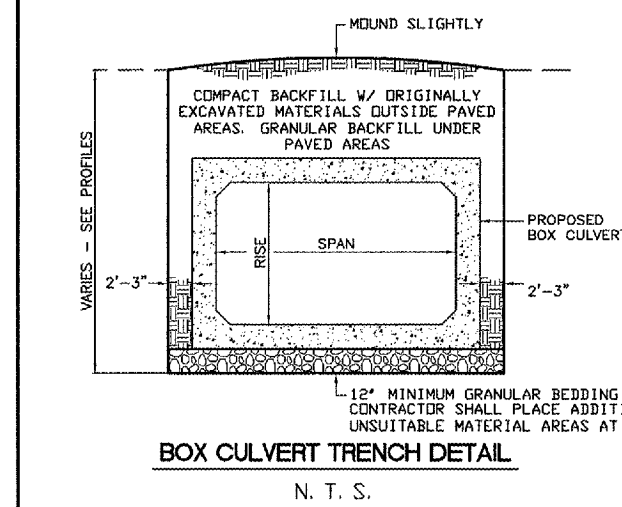
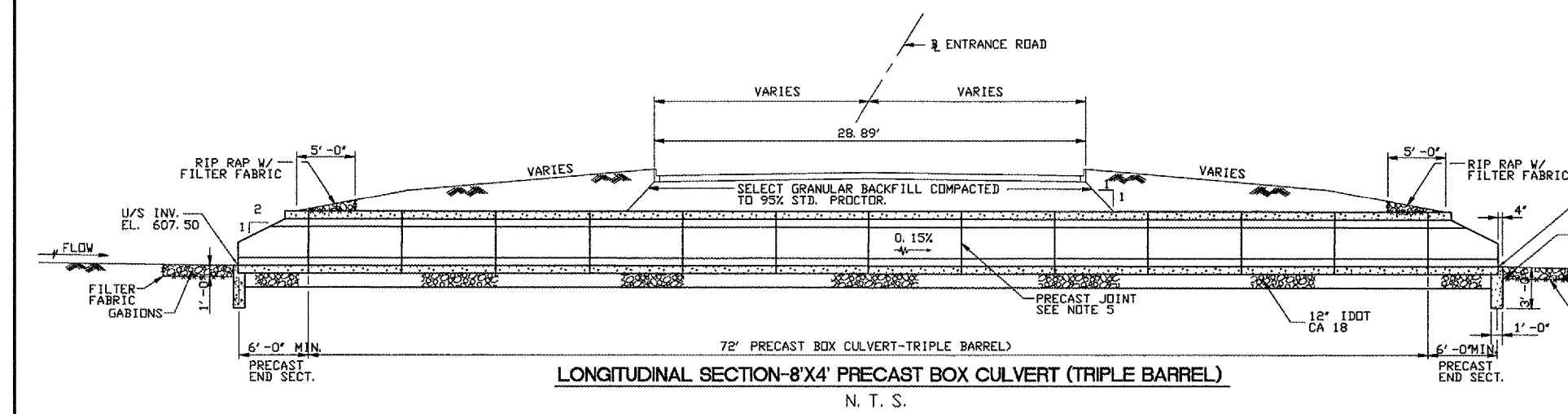
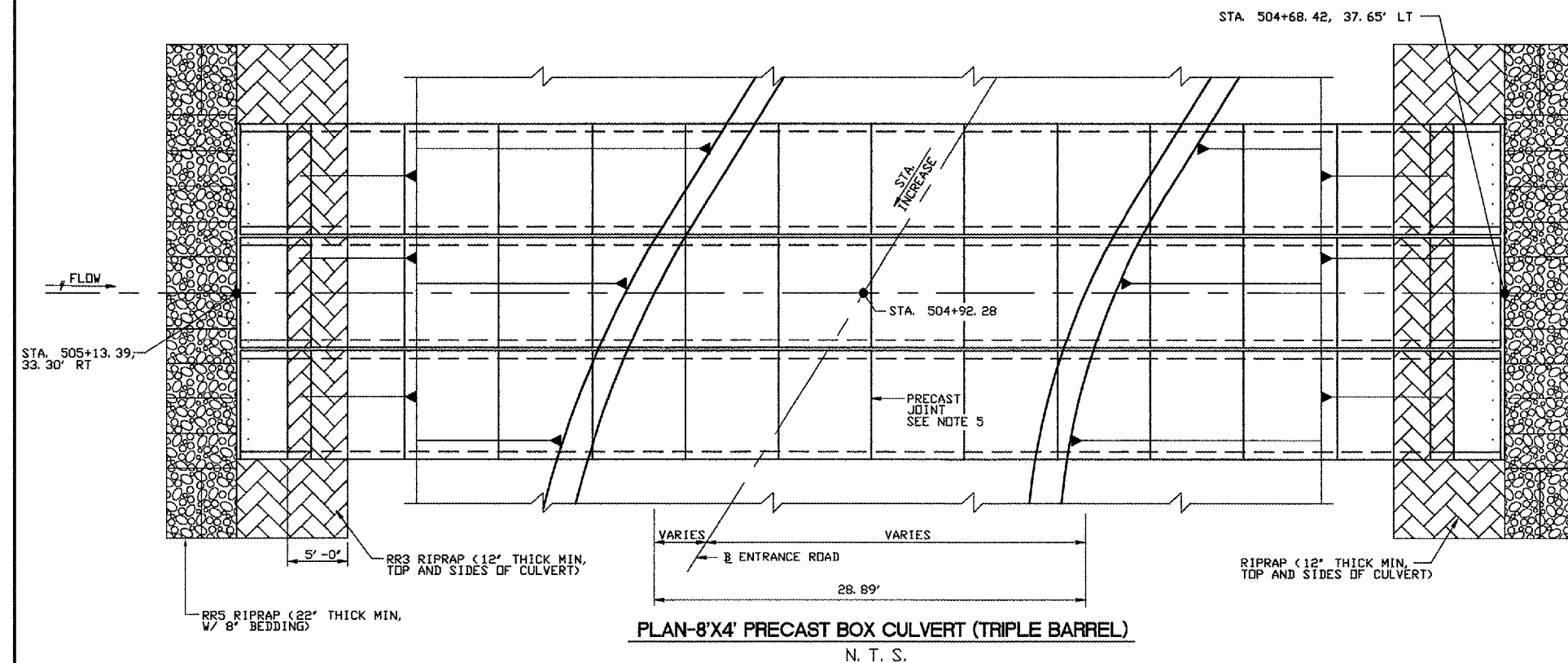

**LANSING MUNICIPAL AIRPORT**  
**LANSING, ILLINOIS**  
**NORTH QUADRANT SITEWORK - PHASE 1**  
**AND TAXIWAY G2 EXTENSION**  
**PRECAST BOX CULVERT DETAILS**

Copyright: CMT, Inc.  
**CMT**  
 CRAWFORD, MURPHY & TILLY, INC.  
 CONSULTING ENGINEERS  
 License No. 184-000613

DESIGN BY:	DKP
DRAWN BY:	JRD
CHECKED BY:	ARM
APPROVED BY:	
DATE:	03/04/05
JOB No:	03297-02
IL PROJECT: IGQ-3329 A.I.P. PROJECT: 3-17-0121-B21	
SHEET 21 OF 50 SHEETS	

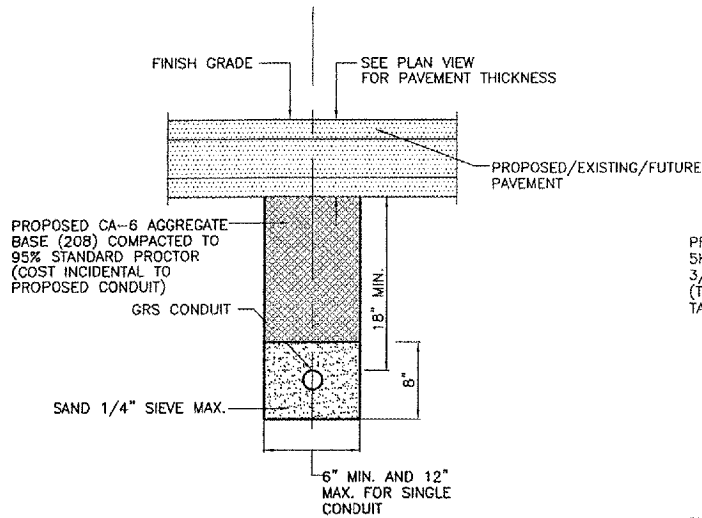

**PAVED AREA CABLE IN CONDUIT TRENCH DETAIL**  
 N.T.S.

NOTE: CONDUIT SHALL BE INSTALLED AT AN ELEVATION THAT WILL NOT CONFLICT WITH THE OTHER UTILITIES SUCH AS SANITARY SEWER, STORM SEWER, WATERMAIN, UNDERDRAIN, AND ETC.

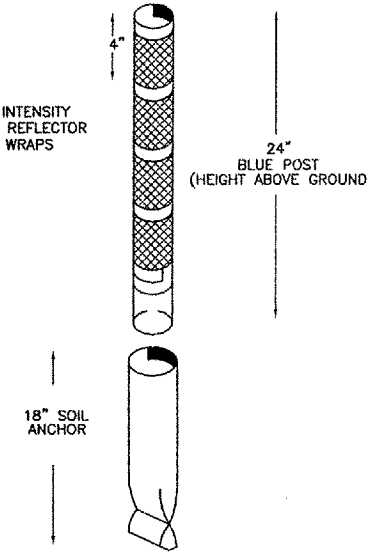

**TAXIWAY RETROREFLECTIVE MARKER DETAIL**  
 NOT TO SCALE

NOTE: RETROREFLECTIVE MARKER SHALL BE SAFE-HIT OR APPROVED EQUAL.

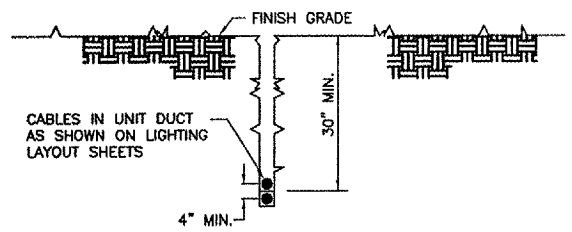

**CABLE IN UNIT DUCT - PLOWED**  
 NOT TO SCALE

NOTE: CONTRACTOR SHALL HAVE THE OPTION TO TRENCH OR PLOW UNIT DUCT. NO ADDITIONAL PAYMENT SHALL BE MADE FOR TRENCHING.

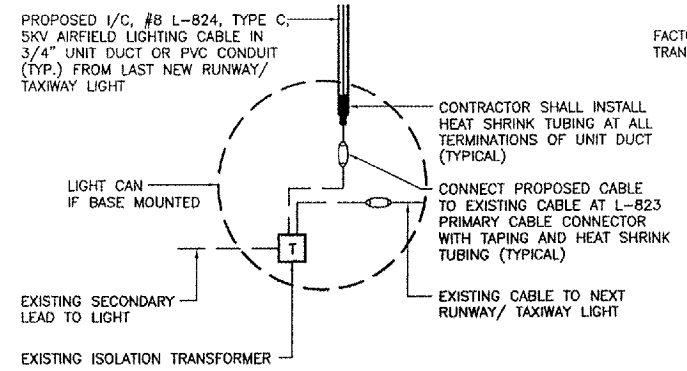

**RUNWAY/TAXIWAY LIGHTING CIRCUIT CONNECTION DETAIL**  
 NOT TO SCALE

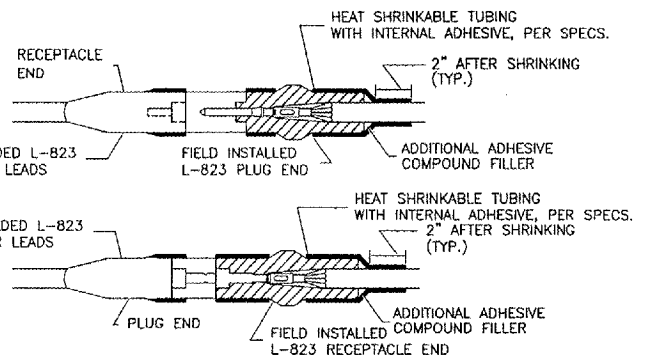

**TYPE C AND D - CABLE SPLICE**

FOR SPLICES AT RUNWAY/TAXIWAY LIGHTS AND SIGNS NOT TO SCALE

**CABLE SPLICE NOTES**

1. INSIDE DIAMETER OF CONNECTOR SHALL PROPERLY MATCH THE OUTSIDE DIAMETER OF CABLE.
2. WRAP WITH AT LEAST ONE LAYER OF RUBBER OR SYNTHETIC RUBBER TAPE AND ONE LAYER OF PLASTIC TAPE, ONE-HALF LAPPED, EXTENDING AT LEAST 1-1/2 INCHES ON EACH SIDE OF JOINT.
3. THE COST OF FURNISHING AND INSTALLING ALL SPLICE MATERIALS SHALL BE INCIDENTAL TO THE ASSOCIATED CABLE ITEMS.
4. THE CONTRACTOR SHALL HAVE A MINIMUM OF TWO (2) TYPE A SPLICE KITS ON THE JOB SITE AT ALL TIMES FOR EMERGENCY REPAIRS.

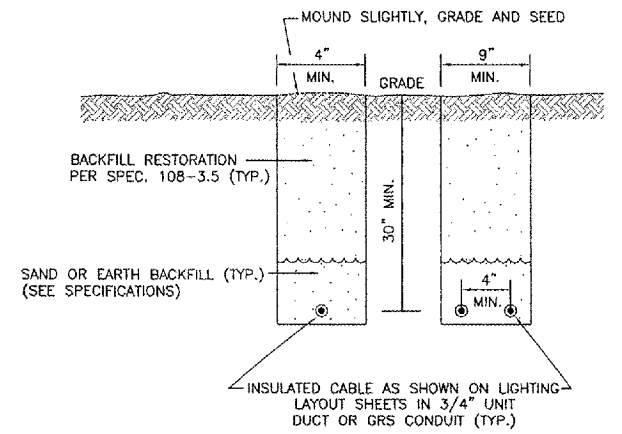

**TURF AREA CABLE TRENCH DETAIL**  
 NOT TO SCALE

**NOTES**

1. TRENCHES WITH MORE THAN 2 CABLES SHALL BE INCREASED 4\"/>
2. DEPTH OF TRENCHES SHALL BE AS SHOWN UNLESS OTHERWISE SPECIFIED ON THE PLANS.
3. SAND BACKFILL SHALL BE USED IF THE EXISTING SOIL DOES NOT MEET THE BACKFILL REQUIREMENTS.
4. ALL DISTURBED SURFACES SHALL BE RESTORED TO THEIR ORIGINAL CONDITION. COST IS INCIDENTAL.

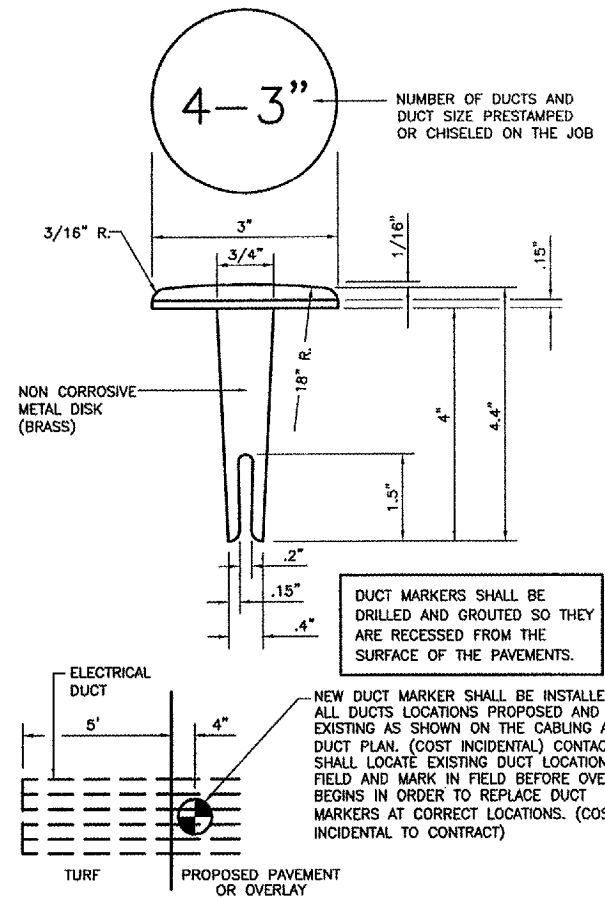

**DUCT MARKER DETAIL**  
 NOT TO SCALE

DUCT MARKERS SHALL BE DRILLED AND GROUTED SO THEY ARE RECESSED FROM THE SURFACE OF THE PAVEMENTS.

NEW DUCT MARKER SHALL BE INSTALLED AT ALL DUCTS LOCATIONS PROPOSED AND EXISTING AS SHOWN ON THE CABLING AND DUCT PLAN. (COST INCIDENTAL) CONTRACTOR SHALL LOCATE EXISTING DUCT LOCATIONS IN FIELD AND MARK IN FIELD BEFORE OVERLAY BEGINS IN ORDER TO REPLACE DUCT MARKERS AT CORRECT LOCATIONS. (COST INCIDENTAL TO CONTRACT)

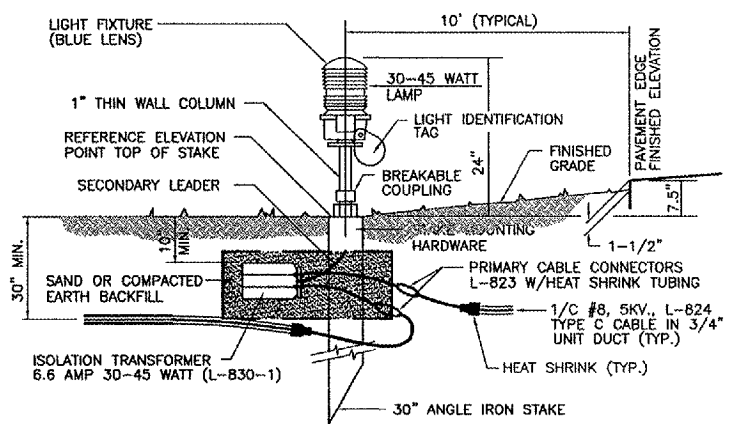

**PROPOSED/ADJUSTED/RELOCATED STAKE MOUNTED MEDIUM INTENSITY TAXIWAY LIGHT**  
 NOT TO SCALE

**GENERAL NOTES:**

1. THE VEHICULAR BARRIERS/BOLLARDS WILL NOT BE MEASURED SEPERATELY FOR PAYMENT BUT SHALL BE CONSIDERED INCIDENTAL TO THE CONCRETE UTILITY PAD.
2. LOCATION OF UNDERGROUND ELECTRICAL ITEMS SHALL BE COORDINATED WITH VEHICULAR BARRIERS/BOLLARDS TO AVOID ANY CONFLICTS
3. NUMBER OF BARRIERS/BOLLARDS TO BE INSTALLED SHALL BE AS REQUIRED BY THE UTILITY COMPANY

REVISIONS		
NUMBER	BY	DATE

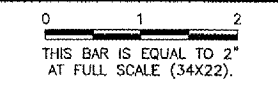

**LANSING MUNICIPAL AIRPORT**  
**LANSING, ILLINOIS**  
**NORTH QUADRANT SITEMWORK - PHASE 1**  
**AND TAXIWAY G2 EXTENSION**  
**ELECTRICAL DETAILS - SHEET 1**

Copyright ©, Inc.  
**CMT**  
 CRAWFORD, MURPHY & TILLY, INC.  
 CONSULTING ENGINEERS  
 License No. 84-000515



DESIGN BY:	DKP
DRAWN BY:	JRO
CHECKED BY:	ARM
APPROVED BY:	
DATE:	03/04/05
JOB No:	03297-02

IL PROJECT: IGQ-3329  
 A.I.P. PROJECT: 3-17-0121-B21

REVISIONS		
NUMBER	BY	DATE

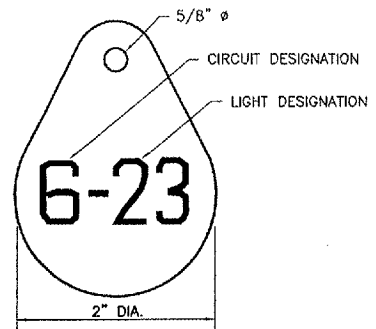
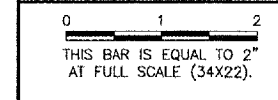

**LIGHT IDENTIFICATION DETAIL**  
 NOT TO SCALE

- NOTES:**
1. INSTALL A NONCORROSIVE DISC OF 2" MINIMUM DIAMETER WITH THE NUMBER PERMANENTLY STAMPED, CUT OUT, OR ENGRAVED UNDER THE HEAD OF THE BASE PLATE BOLT OR ATTACHED TO LIGHT FLANGE WITH A SET SCREW.
  2. NUMERALS SHOWN ARE FOR ILLUSTRATIVE PURPOSES ONLY. ALL EXISTING AND PROPOSED TAXIWAY AND RUNWAY LIGHTS SHALL BE TAGGED AS DIRECTED BY THE RESIDENT ENGINEER. ALL LIGHTS ON EXISTING CIRCUITS THAT HAVE LIGHTING IMPROVEMENTS (PROPOSED OR RELOCATED LIGHTS) SHALL BE RETAGGED.
  3. COST OF TAGGING LIGHTS SHALL NOT BE PAID FOR SEPARATELY BUT SHALL BE CONSIDERED INCIDENTAL TO THE CONTRACT.

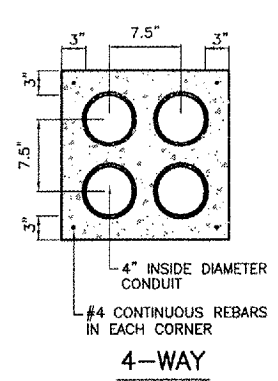

**CONCRETE ENCASED DUCT BANKS**  
 4-WAY  
 NOT TO SCALE

- NOTES:**
1. DIMENSIONS ARE MINIMUM.
  2. CONCRETE SHALL CONFORM TO ITEM 610.
  3. ALL CONDUIT SHALL BE SCHEDULE 40 PVC.
  4. TOP OF CONCRETE ENCASEMENT IN TURF AREAS SHALL NOT BE LESS THAN 24" BELOW FINISHED GRADE.
  5. 4" SPLIT DUCT SHALL BE CONCRETE ENCASED WITH 3" MINIMUM CONCRETE SURROUNDING 4" CONDUIT. COST INCIDENTAL TO SPLIT DUCT.
  6. PROVIDE PULL STRING AND CAPS FOR UNUSED DUCTS.

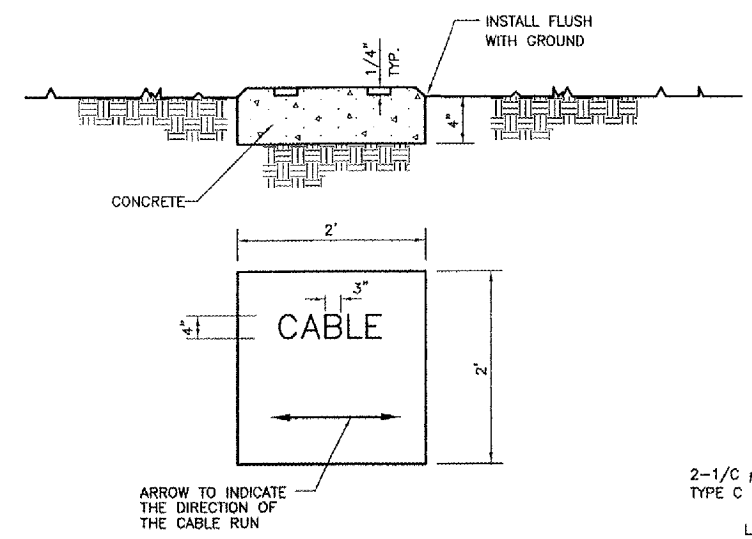

**TURF CABLE MARKER DETAIL**  
 NO SCALE

- NOTES**
- 1.) CABLE MARKERS SHALL BE INSTALLED AT ALL BENDS AND EVERY 200' ALONG THE CABLE RUN.
  - 2.) ITEM 610 CONCRETE SHALL BE USED.
  - 3.) ALL EXPOSED EDGES SHALL BE EDGED WITH A 1/4" RADIUS TOOL.
  - 4.) THE COST OF FURNISHING AND INSTALLING NEW MARKERS SHALL BE INCIDENTAL TO THE ASSOCIATED CABLE ITEMS.
  - 5.) 0.049 CU. YD. CONCRETE PER MARKER.
  - 6.) CONTACTOR SHALL LOCATE EXISTING CABLE MARKERS IN THE FIELD BEFORE SHOULDER ADJUSTMENT BEGINS IN ORDER TO REPLACE CABLE MARKERS AT CORRECT LOCATIONS (COST INCIDENTAL TO CONTRACT).

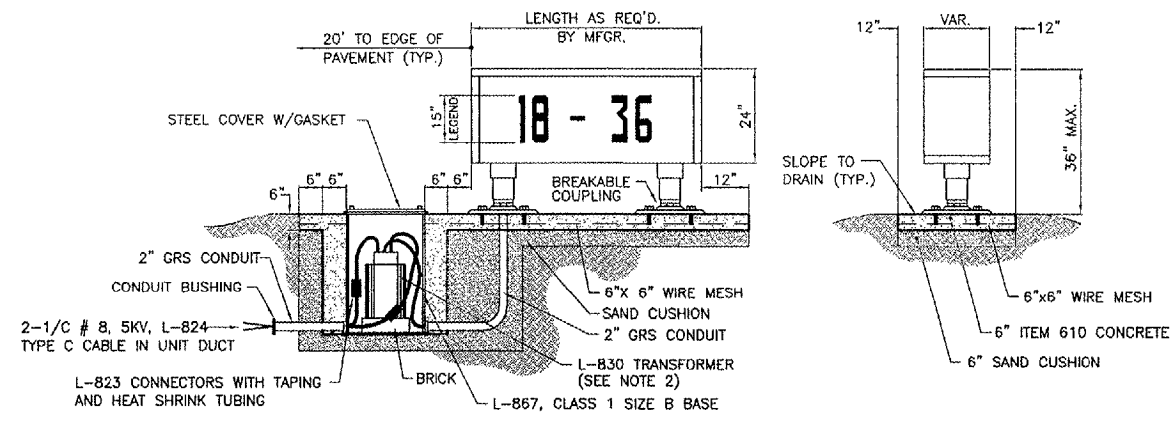

**HOLD LINE / TAXIWAY GUIDANCE SIGN L-858, SIZE 2, STYLE 2, CLASS 2**  
 NOT TO SCALE

- SIGNAGE NOTES**
1. ALL SIGNS ARE LUMACURVE 2-SIDED SIGNS BY STANDARD SIGNS OR APPROVED EQUAL.
  2. TRANSFORMER WATTAGE AS RECOMMENDED BY MANUFACTURER.
  3. LIGHTED SIGNS SHALL BE BASE MOUNTED ONLY.
  4. UNIT DUCT SHALL BE TERMINATED IN THE CAN AND SEALED TO THE CABLE WITH HEAT SHRINK AS SPECIFIED.
  5. THE NUMBER OF MODULES PER SIGN SHALL BE AS RECOMMENDED BY THE MANUFACTURER.
  6. CONTRACTOR SHALL SUBMIT DETAILED SHOP DRAWING INCLUDING SIGN, COLOR, SIZE AND PROPOSED LEGEND, IN ENOUGH DETAIL AND DETERMINE PROPOSED SPACING AND OTHER INFORMATION REQUIRED BY SPECIAL PROVISIONS. CONTRACTOR TO VERIFY PROPOSED SIGN LOCATIONS AND ORIENTATIONS WITH RESIDENT ENGINEER PRIOR TO INSTALLATION.
  7. WHEN EXISTING SIGNS ARE PROPOSED TO BE RETROFITTED WITH NEW SIGN PANELS, THE SIGN PANELS SHALL CONFORM TO THE APPLICABLE REQUIREMENTS OF ADVISORY CIRCULAR 15015340-18 (LATEST EDITION). THE CONTRACTOR SHALL VERIFY THAT THE PROPOSED SIGN PANELS ARE COMPATIBLE WITH THE EXISTING SIGN ASSEMBLIES WHICH ARE LUMACURVE BY STANDARD SIGNS.

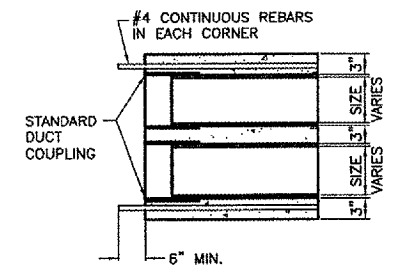

**CONCRETE ENCASED DUCT END DETAIL**  
 NO SCALE

**GENERAL NOTES:**

1. THE CONCRETE BASE FOR BASE MTD. LIGHTS SHALL BE TROWEL FINISHED WITH A 45° BEVELED EDGE. SLOPE TO DRAIN (610).
2. TRANSFORMER HOLDER SHALL BE ANY COMMERCIALY AVAILABLE BRICK.
3. BREAKING GROOVE COUPLINGS SHALL NOT BE OVER 1" ABOVE GROUND LINE.
4. ISOLATION TRANSFORMERS COME WITH A FACTORY INSTALLED PLUG (TYPE 1, CLASS A, STYLE 2) AND RECEPTACLE (TYPE 1, CLASS A, STYLE 9). A TYPE 1, CLASS B, STYLE 3 PLUG AND TYPE 1, CLASS B, STYLE 10 RECEPTACLE SHALL BE INSTALLED ON THE 1/C, No. 8, 5000 V., L-824 TYPE C CABLES FOR CONNECTION TO EACH TRANSFORMER.
5. TO FURTHER REDUCE THE POSSIBILITY OF WATER/MOISTURE ENTRANCE INTO THE CONNECTOR BETWEEN THE CABLE AND THE FIELD ATTACHED CONNECTOR, IT IS REQUIRED THAT A HEAT SHRINKABLE TUBING WITH INTERNAL ADHESIVE BE APPLIED OVER THE ENTIRE CABLE CONNECTOR.
6. ALL SIGNS, LIGHTS, CABLES AND TRANSFORMERS TO BE REMOVED SHALL REMAIN THE PROPERTY OF THE AIRPORT. AT THE DISCRETION OF THE AIRPORT MANAGER, THE CONTRACTOR MAY BE REQUIRED TO DISPOSE OF THESE MATERIALS OFFSITE AT NO ADDITIONAL COST.
7. TAXIWAY LIGHTS SHALL HAVE A BLUE LENS, RUNWAY LIGHTS SHALL HAVE A CLEAR OR 180° AMBER/CLEAR LENS AS DESIGNATED ON PLANS.
8. DUCT MARKERS SHALL BE INSTALLED AT EVERY NEW DUCT AND AT EVERY EXISTING DUCT USED FOR THIS PROJECT.
9. CONTRACTOR SHALL HAVE THE OPTION TO TRENCH OR PLOW UNIT DUCT. NO ADDITIONAL PAYMENT SHALL BE MADE FOR TRENCHING.

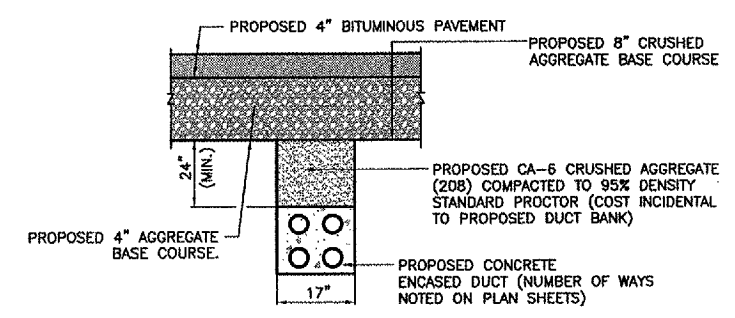

**CONCRETE ENCASED DUCT BACKFILL**  
 NOT TO SCALE

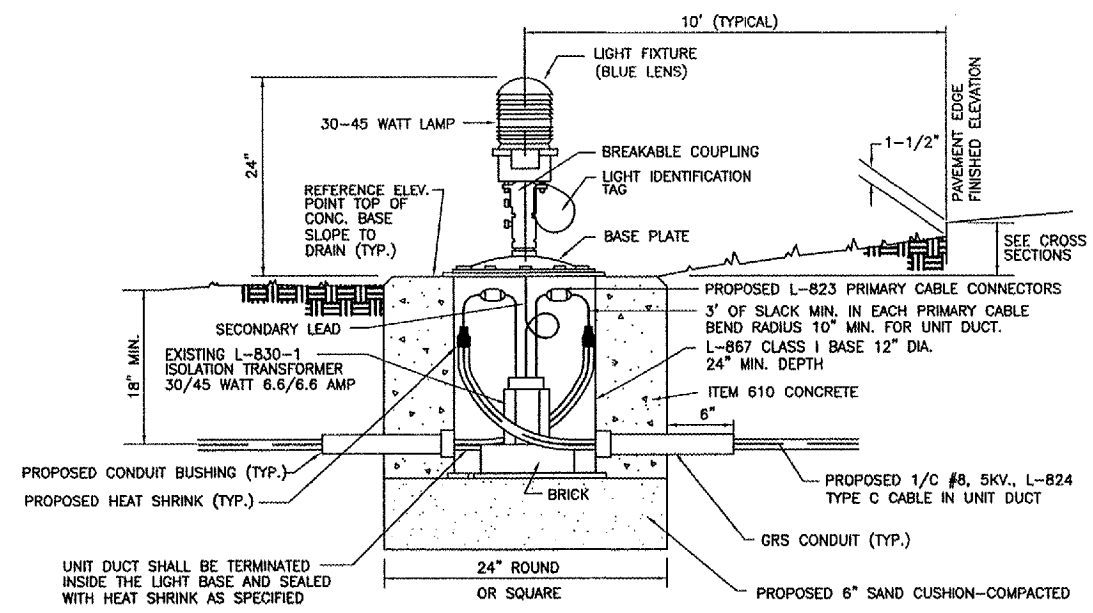

**PROPOSED/ADJUSTED/RELOCATED BASE MOUNTED MEDIUM INTENSITY TAXIWAY LIGHT**  
 NOT TO SCALE

**LANSING MUNICIPAL AIRPORT**  
**LANSING, ILLINOIS**  
**NORTH QUADRANT SITEWORK - PHASE 1**  
**AND TAXIWAY G2 EXTENSION**  
**ELECTRICAL DETAILS - SHEET 2**

Copyright CMT, Inc.

**CMT**  
 CRAWFORD, MURPHY & TILLY, INC.  
 CONSULTING ENGINEERS  
 License No. 184-000813

Lansing Municipal Airport

DESIGN BY:	DKP
DRAWN BY:	JRO
CHECKED BY:	ARM
APPROVED BY:	
DATE:	03/04/05
JOB No:	03297-02
IL PROJECT: IGQ-3329	
A.I.P. PROJECT: 3-17-0121-B21	
SHEET 23 OF 50 SHEETS	



LIGHTING PANEL SCHEDULE			
CIRCUIT NO.	POLE NO.	CIRCUIT BREAKER SIZE	USAGE
A-1	1,3	200A	MAIN CIRCUIT BREAKER
A-2	2,4	20A	ELECTRIC GATE
A-3	5	20A	PARKING LOT LIGHTING
A-4	6	20A	RECEPTACLE
A-5	7	15A	LIGHT INSIDE CABINET
		15A	TIMECLOCK

**NOTES**

- UTILITY METER. THE NEW ELECTRIC SERVICE SHALL BE 200 AMP, 120/240 VOLT, 1 PHASE, 3-WIRE 60 HZ SERVICE. UTILITY METER SHALL BE INSTALLED ON THE SIDE OF TRANSCLOSURE. CONTRACTOR SHALL SUPPLY THE BASE FOR METER AND COORDINATE SERVICE CONNECTION WITH UTILITY COMPANY.
- 30 CIRCUIT LIGHTING PANEL WITH 200 AMP 2-POLE MAIN CIRCUIT BREAKER.
- 8 CIRCUIT PROGRAMMABLE TIMECLOCK, MODEL NO. ET70B15CR AS MANUFACTURED BY INTERMATIC OR EQUAL.
- 42"x36"x8" JUNCTION BOX HOUSING FOR TIMECLOCK AND CONTACTORS.
- GROUND ROD SHALL BE 3/4" DIA. x 10'-0" COPPER CLAD. ALL CONNECTIONS TO GROUND ROD SHALL BE ONE-SHOT EXOTHERMIC TYPE.
- 30A, 2-POLE LIGHTING CONTACTOR. (TYP. OF 3)

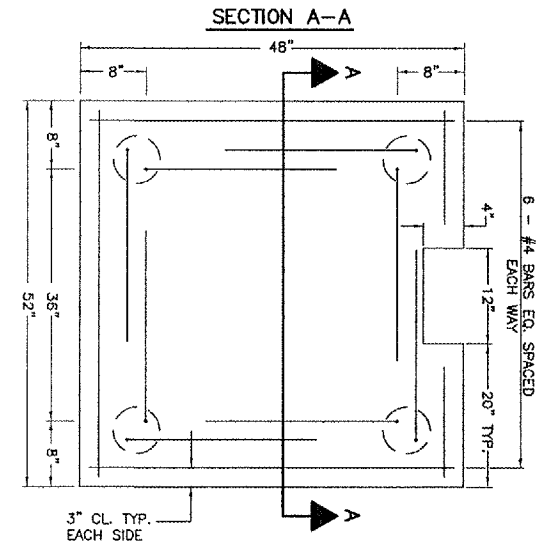
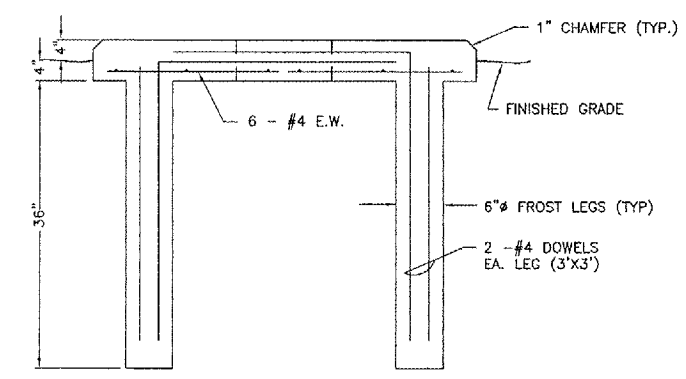
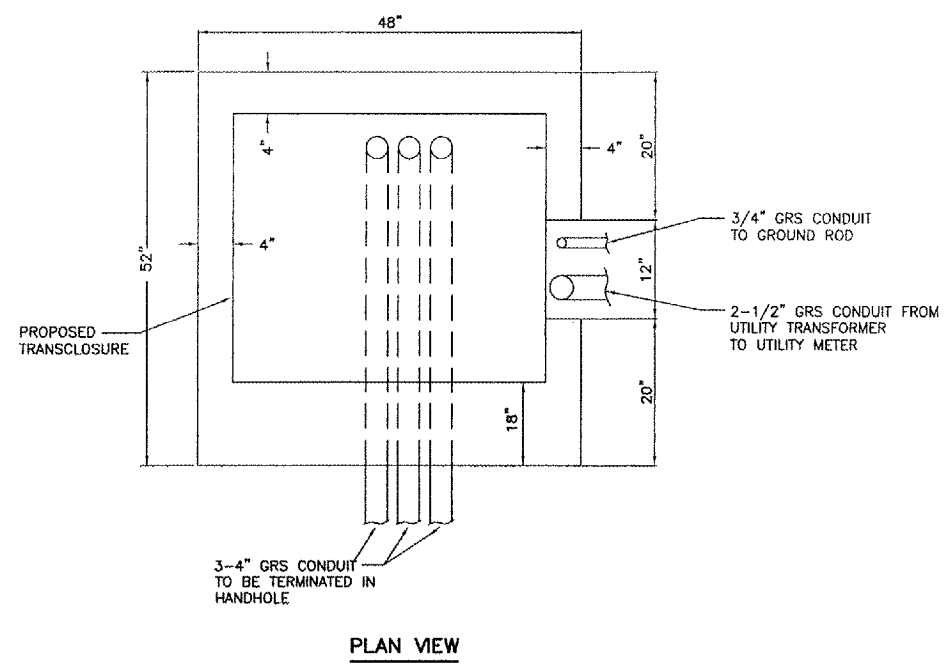

**CONCRETE PAD FOR ELECTRICAL TRANSCLOSURE**  
 NOT TO SCALE

- CONCRETE SHALL HAVE A COMPRESSIVE STRENGTH AT 14 DAYS OF 3500 PSI
- REINFORCING STEEL SHALL BE A-615 GRADE 60
- ALL EXPOSED EDGES AND EQUIPMENT PADS SHALL BE CHAMFERED 1"
- CONTRACTOR SHALL INSTALL CONDUITS THROUGH PAD AS REQUIRED. CONDUITS NOT SHOWN FOR CLARITY.
- DIMENSIONS ARE APPROXIMATE AND SHALL BE FIELD VERIFIED.

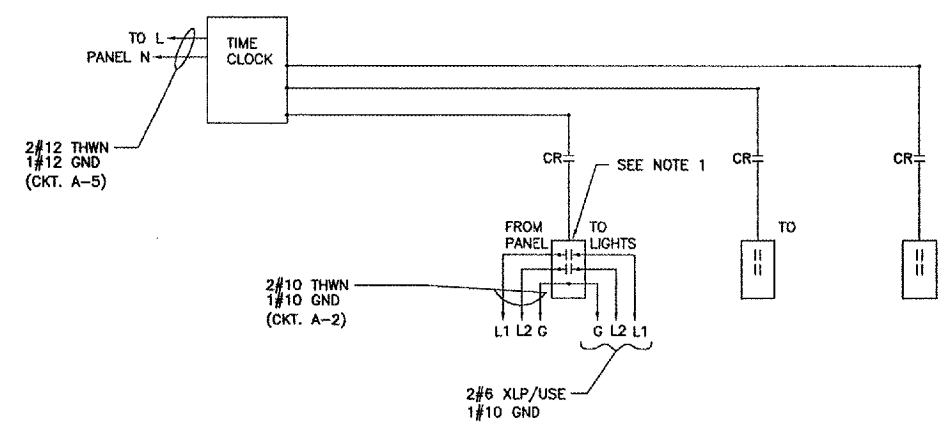
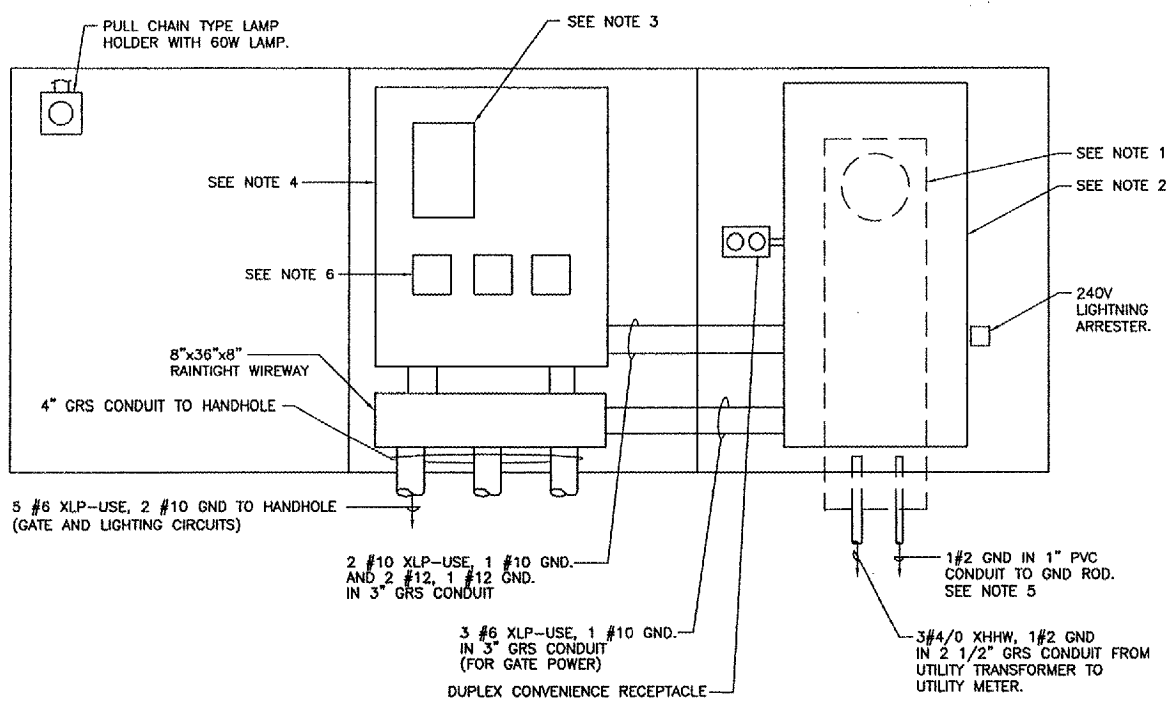

**NOTES:**

- 2 POLE, 30 AMP LIGHTING CONTACTOR. (TYP. OF 3)

REVISIONS		
NUMBER	BY	DATE

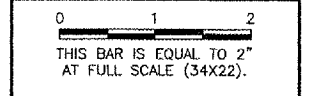

LANSING MUNICIPAL AIRPORT  
 LANSING, ILLINOIS  
 NORTH QUADRANT SITEWORK - PHASE 1  
 AND TAXIWAY G2 EXTENSION  
 ELECTRICAL DETAILS - SHEET 3

Copyright CMT, Inc.  
**CMT**  
 CRAWFORD, MURPHY & TILLY, INC.  
 CONSULTING ENGINEERS  
 License No. 184-000519

DESIGN BY:	DKP
DRAWN BY:	JRO
CHECKED BY:	ARM
APPROVED BY:	
DATE:	03/04/05
JOB No:	03297-02
IL PROJECT:	IGQ-3329
A.I.P. PROJECT:	3-17-0121-B21
SHEET	24 OF 50 SHEETS

REVISIONS		
NUMBER	BY	DATE

0 1 2  
 THIS BAR IS EQUAL TO 2"  
 AT FULL SCALE (3/4X22).

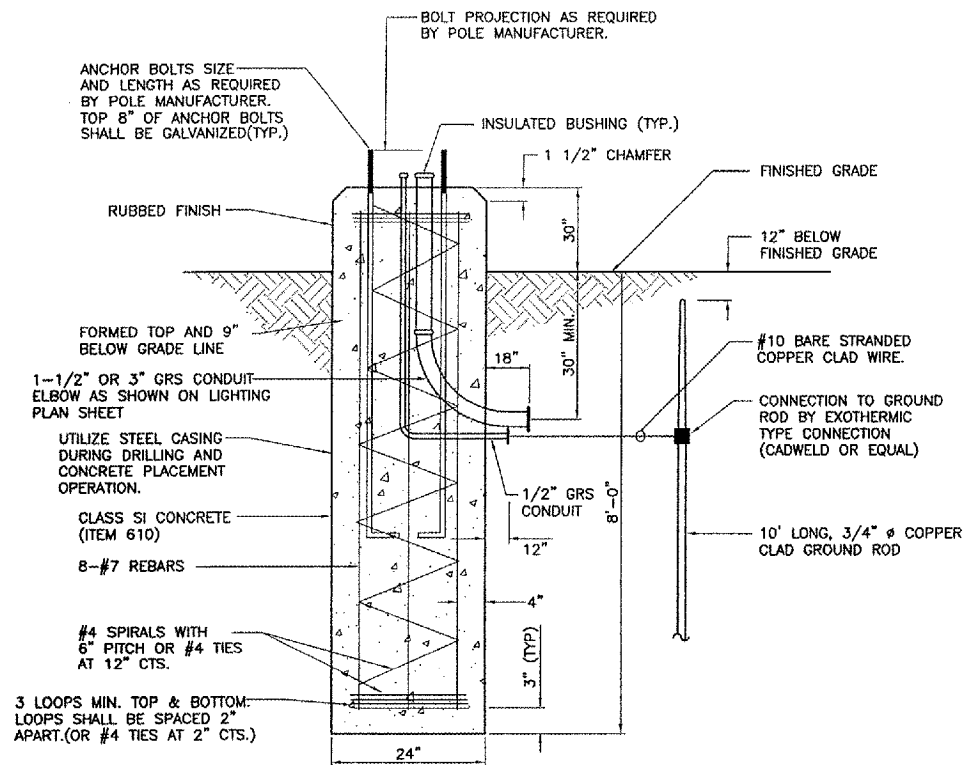

ELEVATIONS VIEW

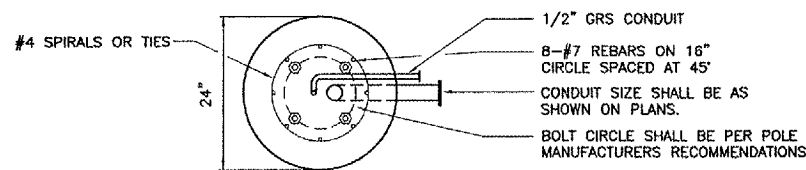

PLAN VIEW

**LIGHT POLE FOUNDATION DETAIL**

NOT TO SCALE

\*CONTRACTOR TO VERIFY FINISHED GRADE WITH ENGINEER

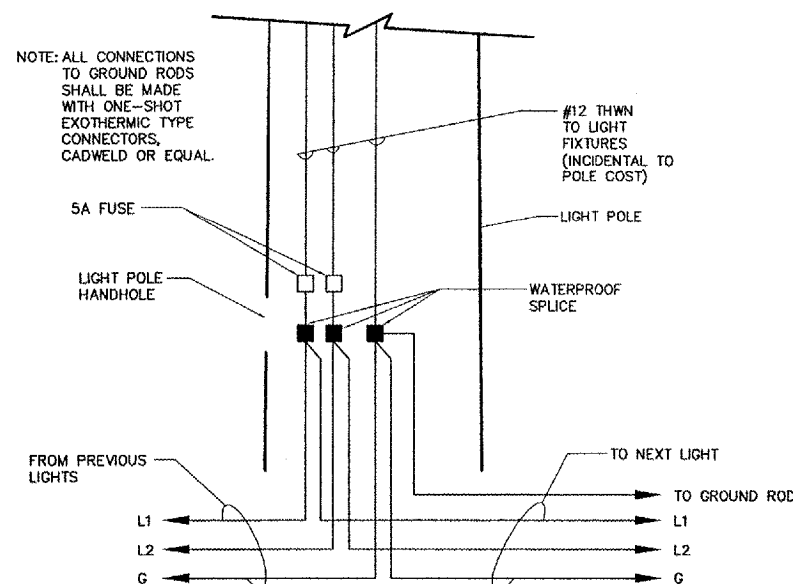

LIGHT POLE HANDHOLE WIRING DIAGRAM

NOT TO SCALE

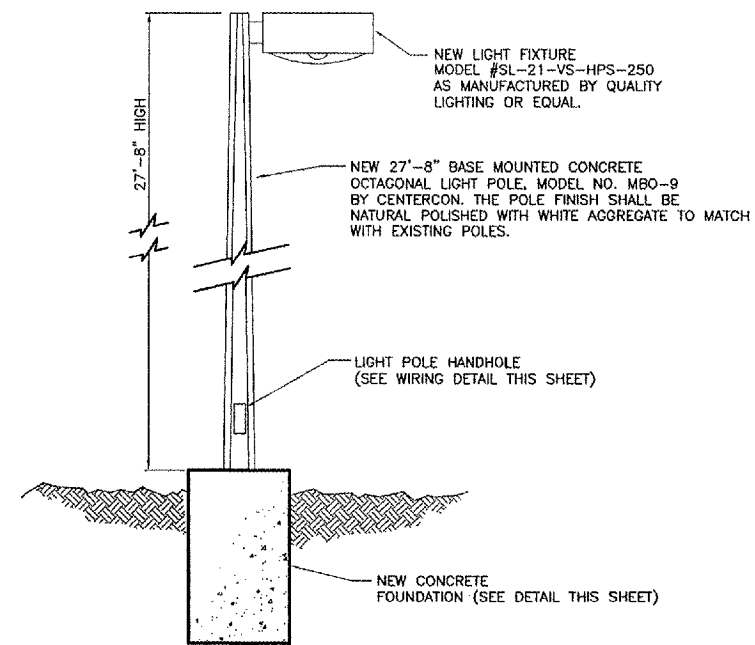

PROPOSED LIGHT POLE DETAIL

NOT TO SCALE

LANSING MUNICIPAL AIRPORT  
 LANSING, ILLINOIS  
 NORTH QUADRANT SITEWORK - PHASE 1  
 AND TAXIWAY G2 EXTENSION  
 ELECTRICAL DETAILS - SHEET 4

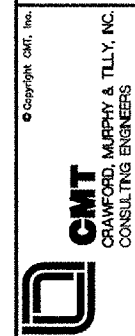

DESIGN BY:	DKP
DRAWN BY:	JRO
CHECKED BY:	ARM
APPROVED BY:	
DATE:	03/04/05
JOB No:	03297-02

IL PROJECT: IGQ-3329  
 A.I.P. PROJECT: 3-17-0121-B21

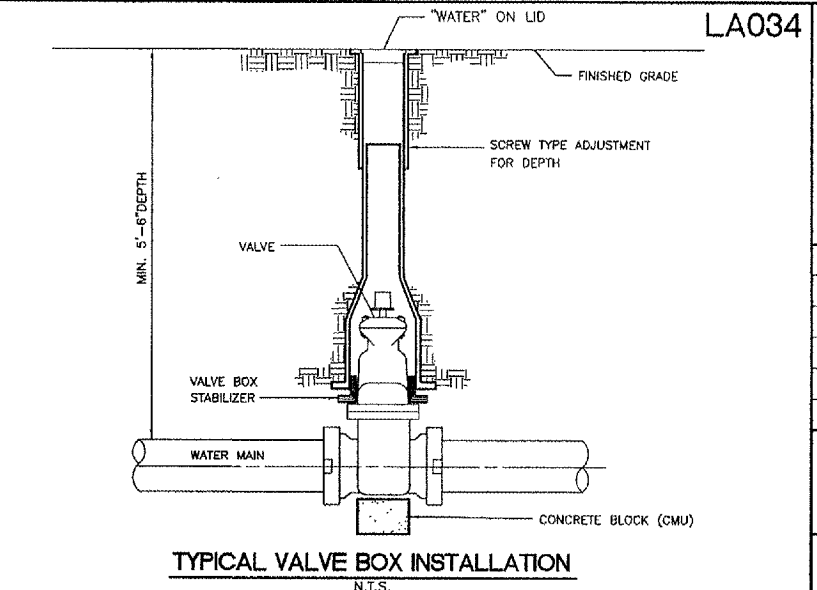
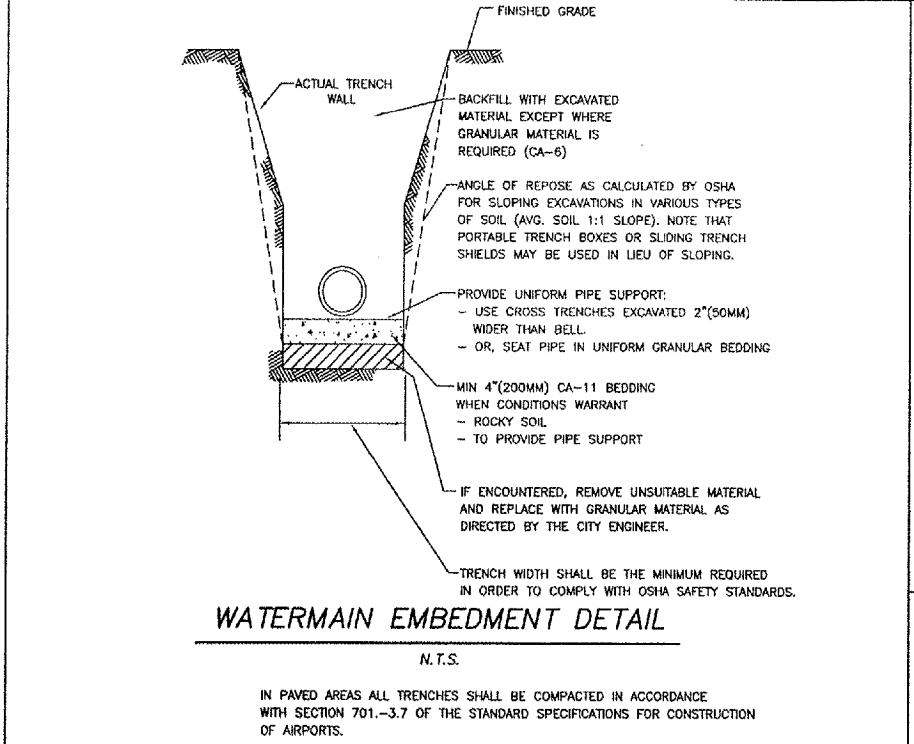
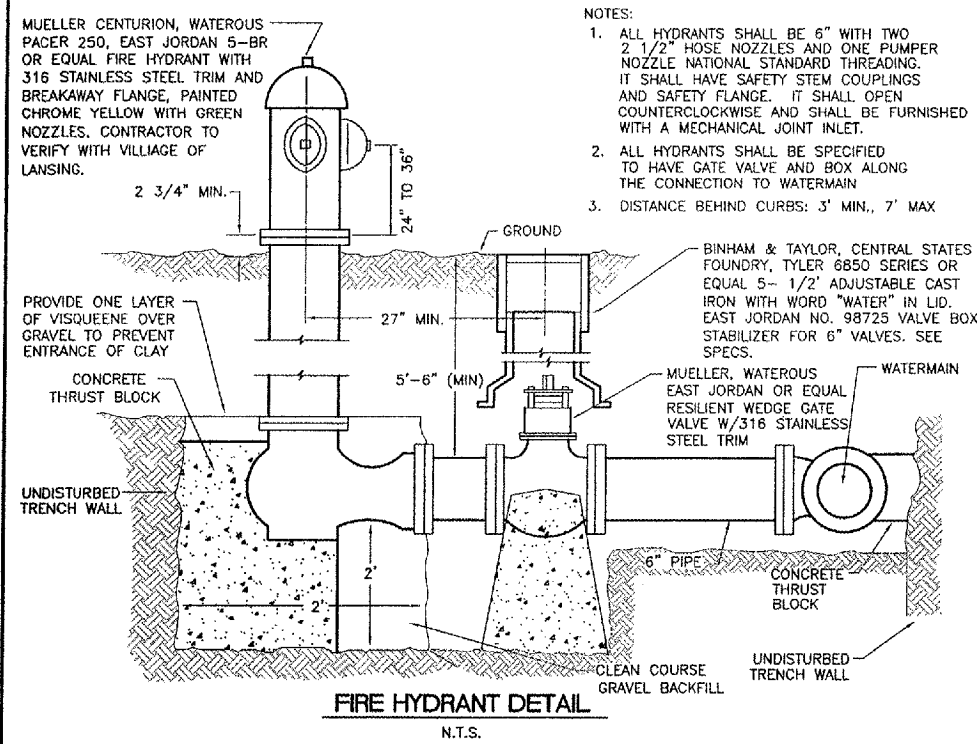

LA034

PATH: K:\0329702\sheets\  
FILE: waterdl.dwg  
UPDATE BY: johse  
SURVEY BOOK #  
XREF DWG:  
XREF DWG:  
DATE: Fri 3/26/04 2:56pm

REVISIONS		
NUMBER	BY	DATE

0 1 2  
THIS BAR IS EQUAL TO 2" AT FULL SCALE (34X22).

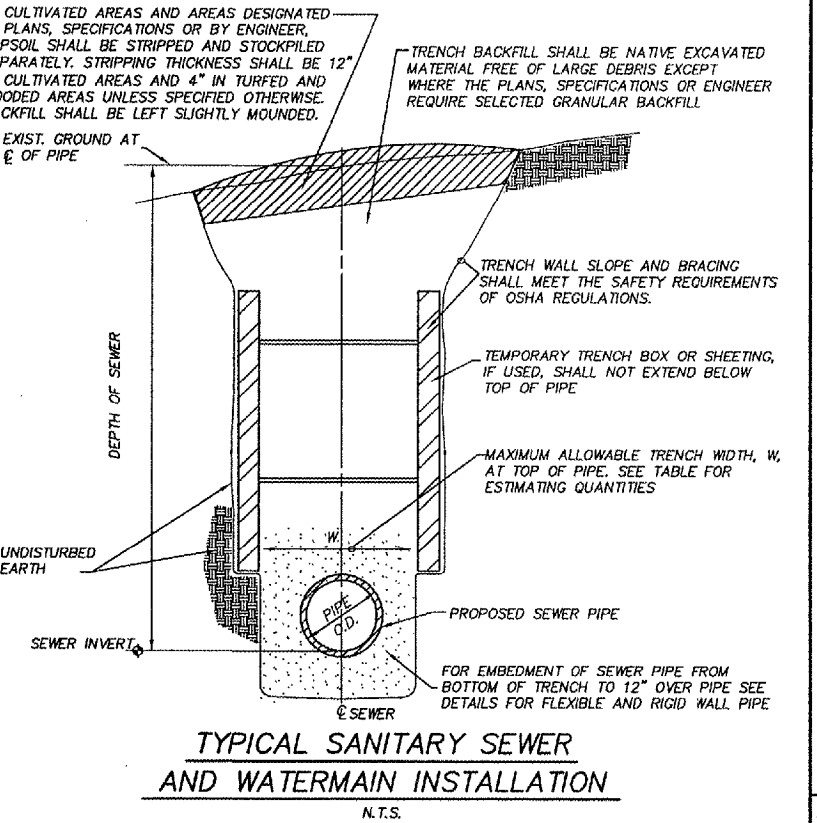
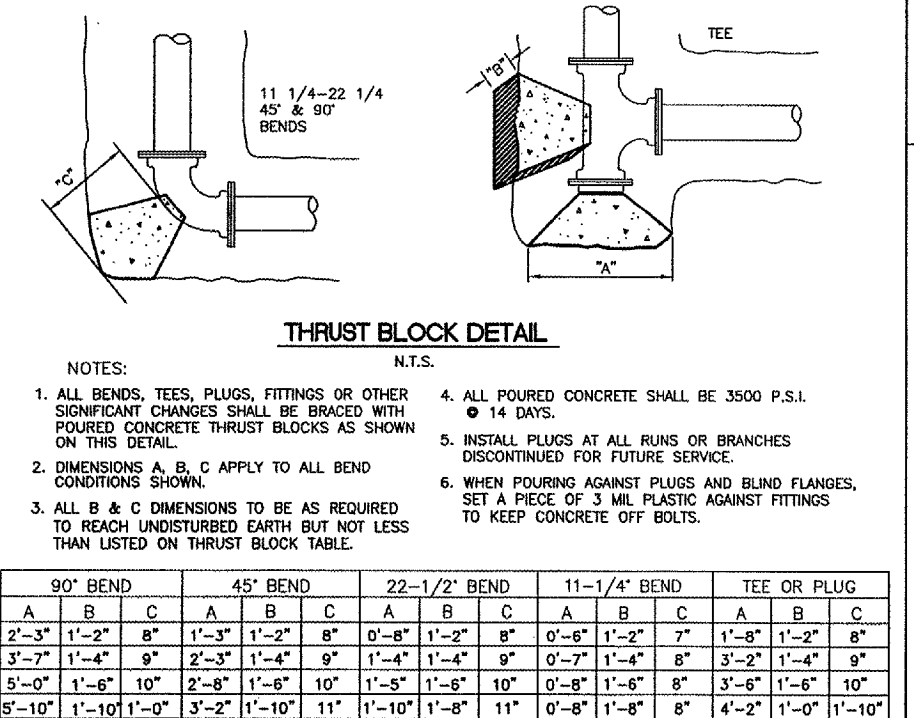
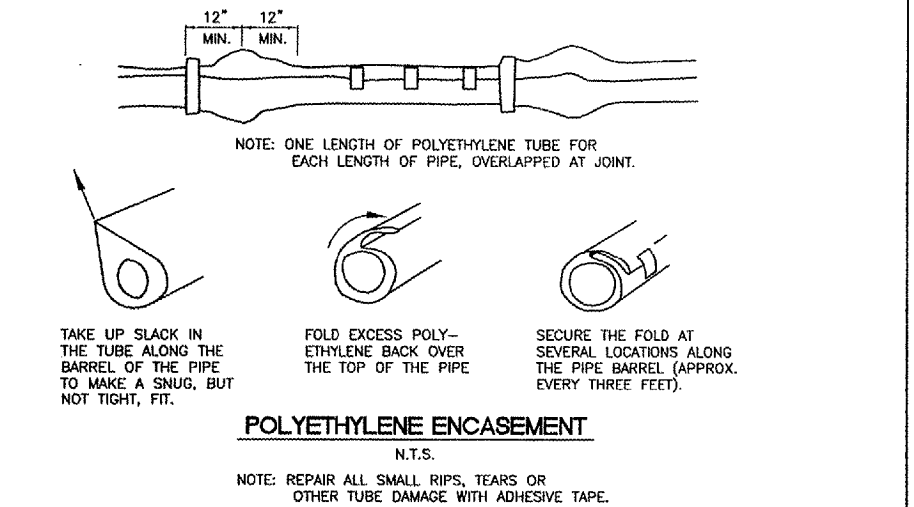
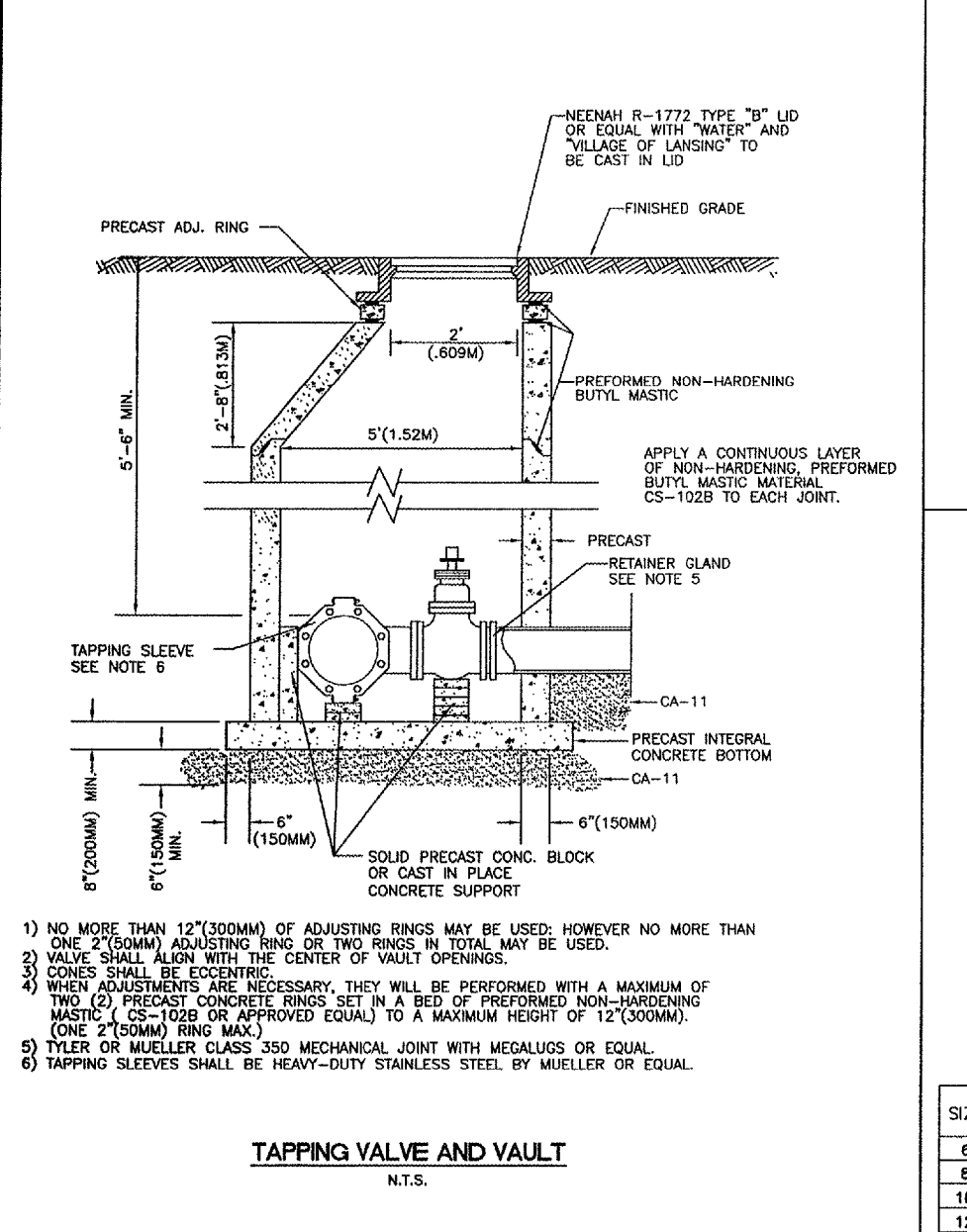

QUANTITIES PER LINEAL FOOT OF CONDUIT

INSIDE DIAMETER OF CONDUIT IN INCHES	MAXIMUM TRENCH WIDTH IN FEET	BEDDING C.Y./FOOT WHERE ELIGIBLE	HAUNCHING C.Y./FOOT WHERE ELIGIBLE	INITIAL BACKFILL C.Y./FOOT WHERE ELIGIBLE	FINAL BACKFILL C.Y./FOOT PER FOOT	PERMANENT FLEXIBLE REMOVAL AND REPLACEMENT S.Y./FOOT
6	3.58	0.04	0.03	0.17	0.13	0.62
8	3.78	0.05	0.05	0.19	0.14	0.64
10	3.97	0.05	0.06	0.20	0.15	0.66
12	4.17	0.05	0.07	0.22	0.15	0.69
14	4.36	0.05	0.08	0.24	0.16	0.71
15	4.46	0.06	0.09	0.25	0.17	0.72
16	4.56	0.06	0.10	0.26	0.17	0.73
18	4.75	0.06	0.11	0.29	0.18	0.75
20	4.94	0.06	0.12	0.31	0.18	0.77
21	5.04	0.06	0.13	0.32	0.19	0.78
24	5.33	0.07	0.15	0.35	0.20	0.81
27	5.63	0.07	0.17	0.38	0.21	0.85
28	5.72	0.07	0.18	0.39	0.21	0.86
30	5.92	0.07	0.20	0.41	0.22	0.88
33	6.21	0.08	0.22	0.45	0.23	0.91
36	6.50	0.08	0.24	0.48	0.24	0.94

BASED ON STANDARD DRAWING NO. 2 OF THE STANDARD SPECIFICATIONS FOR WATER AND SEWER MAIN CONSTRUCTION IN ILLINOIS.

**TABLE OF QUANTITIES FOR ESTIMATING PURPOSES**

LANSING MUNICIPAL AIRPORT  
LANSING, ILLINOIS

NORTH QUADRANT SITEWORK - PHASE 1  
AND TAXIWAY G2 EXTENSION

WATERMAIN DETAILS

DESIGN BY: ARM  
DRAWN BY: JRO  
CHECKED BY: ARM  
APPROVED BY:  
DATE: 03/04/05  
JOB No: 03297-02

IL PROJECT: IGQ-3329  
A.I.P. PROJECT: 3-17-0121-B21

SHEET 26 OF 50 SHEETS



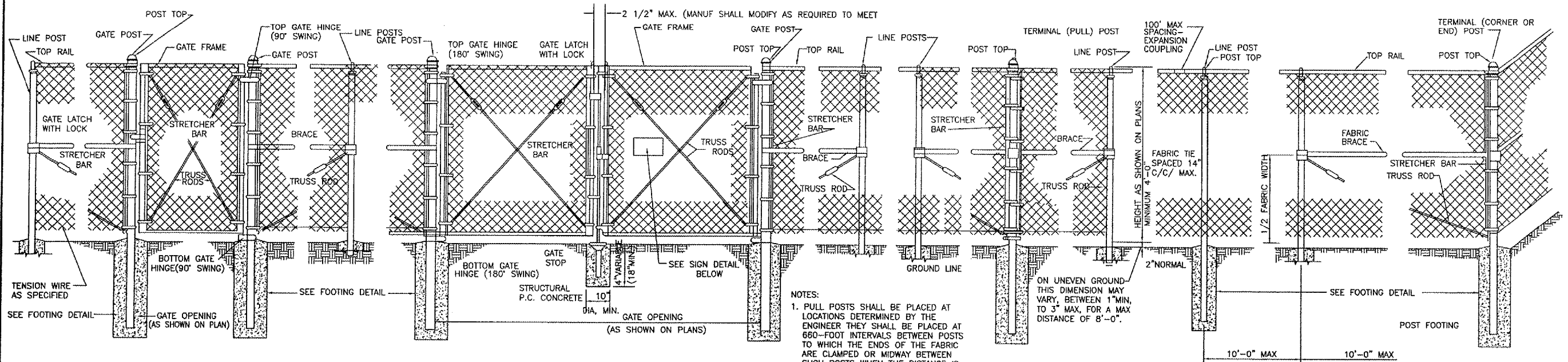

**PEDESTRIAN GATE ARRANGEMENT**

**VEHICLE GATE ARRANGEMENT**

**PULL POST ARRANGEMENT**

**LINE POST ARRANGEMENT**

**CORNER OF END POST ARRANGEMENT**

**NOTES:**  
 1. PULL POSTS SHALL BE PLACED AT LOCATIONS DETERMINED BY THE ENGINEER THEY SHALL BE PLACED AT 660-FOOT INTERVALS BETWEEN POSTS TO WHICH THE ENDS OF THE FABRIC ARE CLAMPED OR MIDWAY BETWEEN SUCH POSTS WHEN THE DISTANCE IS LESS THAN 1320' AND GREATER THAN 660'  
 2. WHERE FENCE HAS A CHANGE IN DIRECTION OF 15° OR MORE, A TERMINAL POST SHALL BE PLACED AS SHOWN ABOVE.

**REVISIONS**

NUMBER	BY	DATE

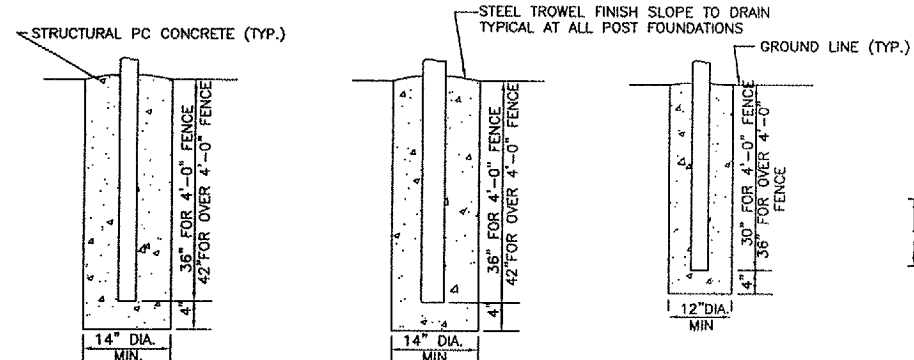
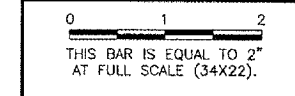

**FOOTING FOR TERMINAL POST**

**FOOTING FOR GATE POST**

**FOOTING FOR LINE POST**

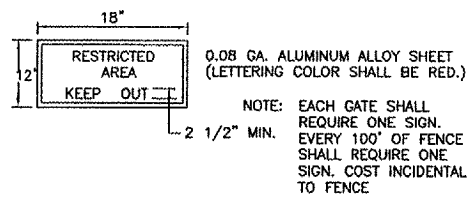

**SIGN DETAIL**

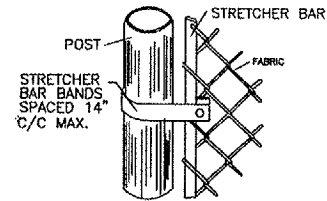

**METHOD OF FASTENING STRETCHER BAR TO POST**

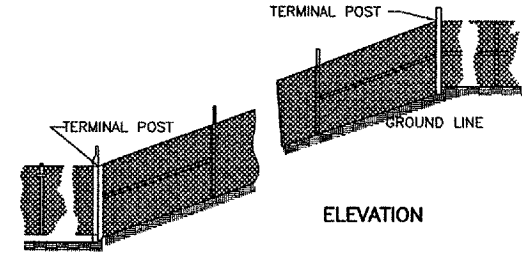

**FENCE INSTALLATION ON SLOPES**

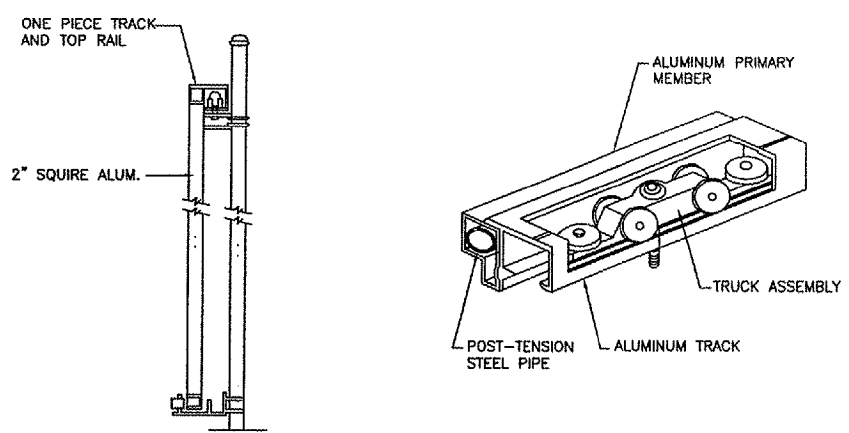

**ROLLER ASSEMBLY FOR SLIDING DRIVEWAY GATE**

NOTE: GATE AND ROLLERS SHALL BE MOUNTED INBOARD  
 CONTRACTOR SHALL SUBMIT SHOP DRAWINGS ENCLOSED  
 TRUCK ROLLER ASSEMBLY FOR SLIDING DRIVEWAY GATES.

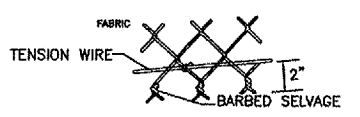

**METHOD OF TYING FABRIC TO TENSION WIRE**



**METHOD OF TYING FABRIC TO PIPE**

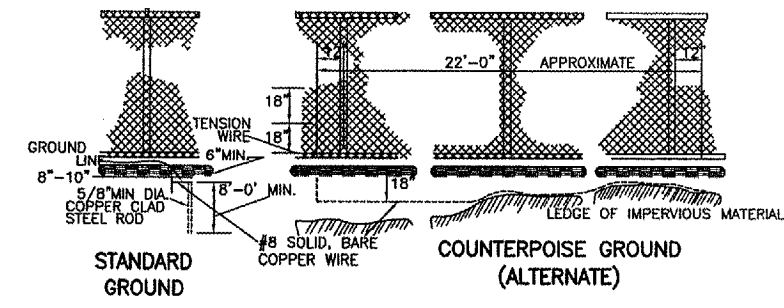

**PROTECTIVE ELECTRICAL GROUND**

**NOTES:**  
 1. CONTINUOUS FENCE SHALL BE GROUNDED AT INTERVALS NOT EXCEEDING 1000' EXCEPT THERE SHALL BE A GROUND NOT EXCEEDING 100 FT. FROM A GATE IN EACH SECTION OF THE FENCE ADJACENT TO THE GATE.  
 2. FENCE UNDER POWER LINE SHALL BE GROUNDED BY THREE GROUNDS, ONE DIRECTLY UNDER THE CROSSING AND ONE ON EACH SIDE 25 TO 50 FT. AWAY. A SINGLE GROUND SHALL BE LOCATED DIRECTLY UNDER EACH TELEPHONE WIRE OR CABLE CROSSING.  
 3. THE COUNTERPOISE SHALL BE USED ONLY WHERE IT IS IMPOSSIBLE TO DRIVE A GROUND ROD BECAUSE OF AN IMPERVIOUS EARTH STRUCTURES.  
 4. THE GROUND WIRE SHALL BE CONNECTED TO FABRIC, TENSION WIRE, AND THE GROUND ROD BY A MECHANICAL CLAMP OF CAST BRONZE BODY AND BRONZE OR STAINLESS STEEL BOLTS AND WASHERS.

**LANSING MUNICIPAL AIRPORT**  
**LANSING, ILLINOIS**  
**NORTH QUADRANT SITEWORK - PHASE 1**  
**AND TAXIWAY G2 EXTENSION**  
**FENCING DETAILS**

Copyright CMT, Inc.  
**CMT**  
 CRAWFORD, MURPHY & TILLY, INC.  
 CONSULTING ENGINEERS  
 License No. 184-000613

DESIGN BY:	ARM
DRAWN BY:	JRO
CHECKED BY:	ARM
APPROVED BY:	
DATE:	03/04/05
JOB No:	03297-02
IL PROJECT: IGQ-3329 A.I.P. PROJECT: 3-17-0121-B21	
SHEET 27 OF 50 SHEETS	

REVISIONS

NUMBER	BY	DATE

0 1 2  
 THIS BAR IS EQUAL TO 2" AT FULL SCALE (34X22).

LANSING MUNICIPAL AIRPORT  
 LANSING, ILLINOIS  
 NORTH QUADRANT SITEWORK - PHASE 1  
 AND TAXIWAY G2 EXTENSION  
 ELECTRIC GATE DETAILS

© Copyright GMT, Inc.  
**GMT**  
 CRAWFORD, MURPHY & TILLY, INC.  
 CONSULTING ENGINEERS  
 License No. 184-000618  
 Lansing Municipal Airport

DESIGN BY: ARM  
 DRAWN BY: JRO  
 CHECKED BY: ARM  
 APPROVED BY:  
 DATE: 03/04/05  
 JOB No: 03297-02

IL PROJECT: IGQ-3329  
 A.I.P. PROJECT: 3-17-0121-B21

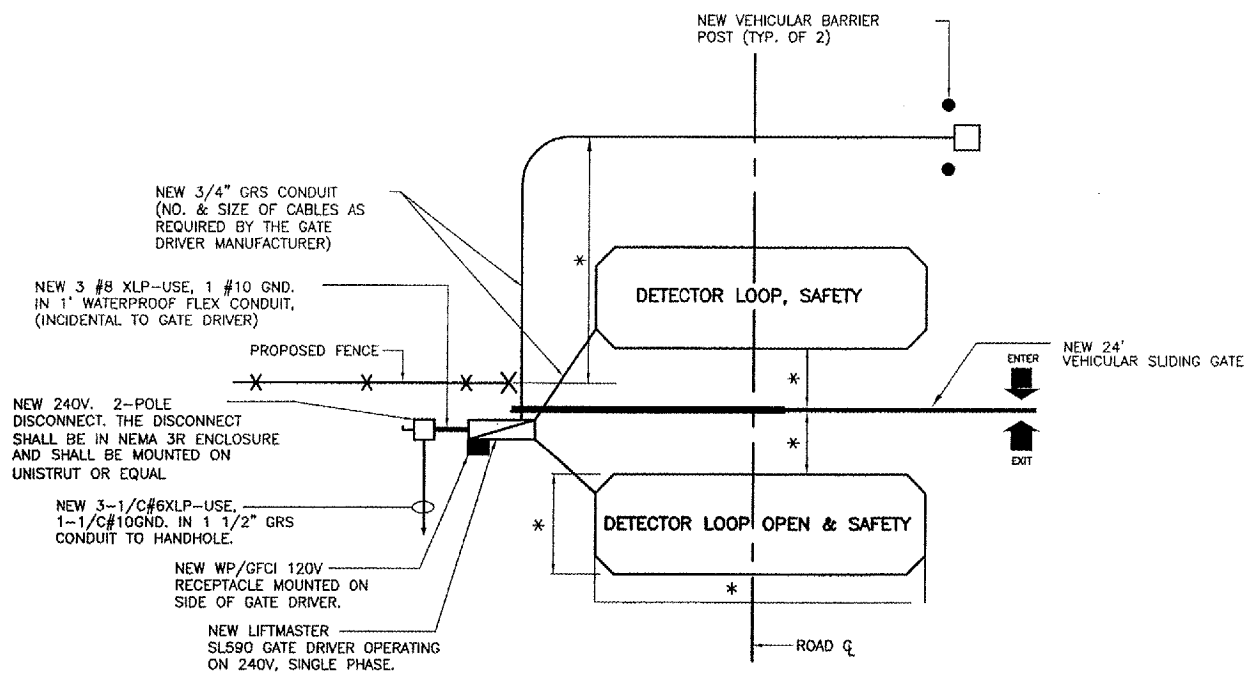

NEW KEY PAD OPERATED GATE AND DETECTOR LOOP LAYOUT

NOT TO SCALE  
 \* PER MANUFACTURERS RECOMMENDATION CONTRACTOR SHALL COORDINATE THIS WORK WITH ENGINEER.

NOTES:

1. THE LOCATION OF THE NEW GATE DRIVER, DISCONNECT AND DETECTOR LOOPS ARE FOR INFORMATION ONLY AND SHALL BE FIELD ADJUSTED PER THE MANUFACTURER RECOMMENDATION.
2. THE MINIMUM BURIAL DEPTH FOR GRS CONDUIT IS 30" BELOW FINISHED GRADE.
3. NO DIRECT BURIED CABLE WILL BE ALLOWED IN THE INSTALLATION OF THE NEW GATE DRIVER.

GATE TYPE	GATE
A	DISTANCE BETWEEN GATE POSTS (INSIDE FACE TO INSIDE FACE) 24'-0"
B	DISTANCE BETWEEN HANGER POSTS (CENTER TO CENTER) 10'-0"*
C	OVERALL GATE LENGTH 34'-6"*
D	OVERALL GATE HEIGHT 6'-0"
E	HEIGHT OF FABRIC IN GATE 5'-0"
F	COUNTER BALANCE LENGTH 10'-6"
G	HEIGHT OF 4" POSTS ABOVE GRADE 6'-6"*

\* OR AS RECOMMENDED BY MFG.

NOTES:

1. CANTILEVERED GATE SHALL BE SUFFICIENTLY RIGID TO WITHSTAND FLEXING OR BENDING DURING WINDY CONDITIONS. CONTRACTOR SHALL PROVIDE STIFFENERS, STRUCTURAL SHAPES IN EXCESS OF THE MINIMUM SPECIFIED DIMENSIONS OR ADDITIONAL ROLLERS AND POSTS SUFFICIENT TO PREVENT DISPLACEMENT OF THE GATE BY WIND OR BY UNAUTHORIZED PERSONNEL.
2. CONTRACTOR SHALL INSTALL GATE AS A COMPLETE WORKING UNIT. THE GATE WORK SHALL INCLUDE, BUT NOT BE LIMITED TO THE GATE, CHAIN GATE OPERATOR AND FOUNDATION, AND POWER CABLES CONDUIT, TRENCHING, CIRCUIT BREAKERS AND ALL CONNECTIONS, LABOR AND MATERIALS NECESSARY TO COMPLETE OPERATION.
3. LOCATION OF THE GATE OPERATOR SHALL BE AS RECOMMENDED BY THE MANUFACTURER.
4. THE FABRIC TYPE AND FINISH OF THE GATE SHALL MATCH WITH THE NEW FENCE OR AS DIRECTED BY THE ENGINEER.
5. ALL NEW SLIDING VEHICULAR GATES SHALL HAVE ENCLOSED TRUCK ASSEMBLIES, SAFE-GLIDE BY EDKO OR EQUAL.

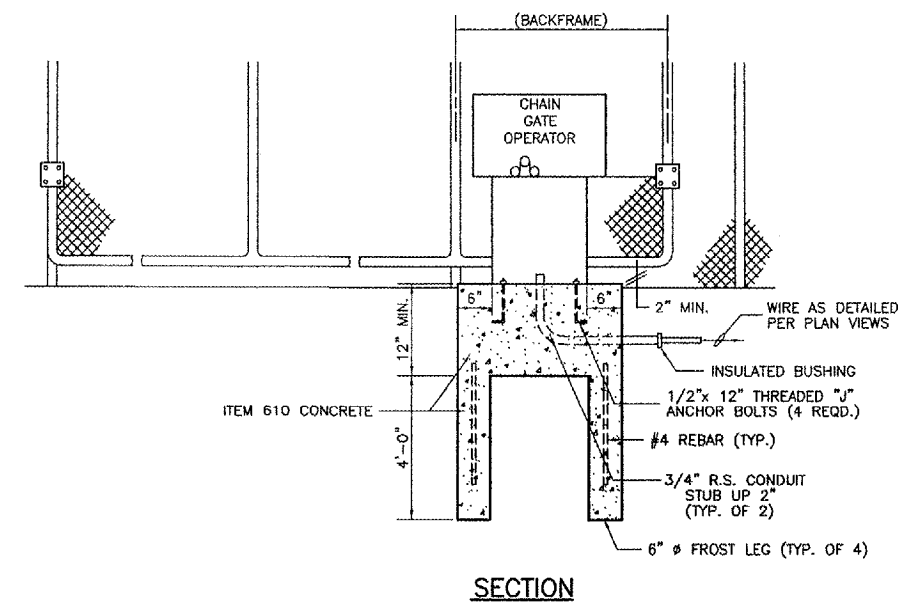

SECTION

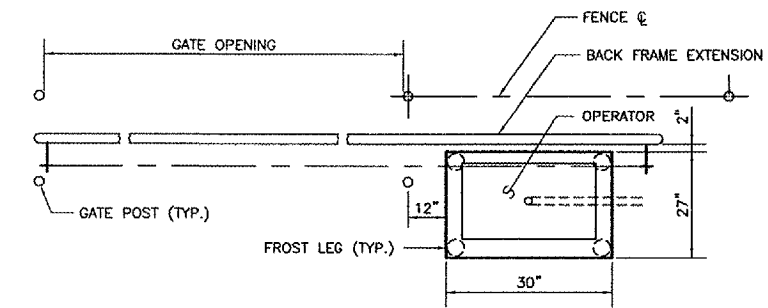

PLAN

GATE OPERATOR DETAIL

NOT TO SCALE

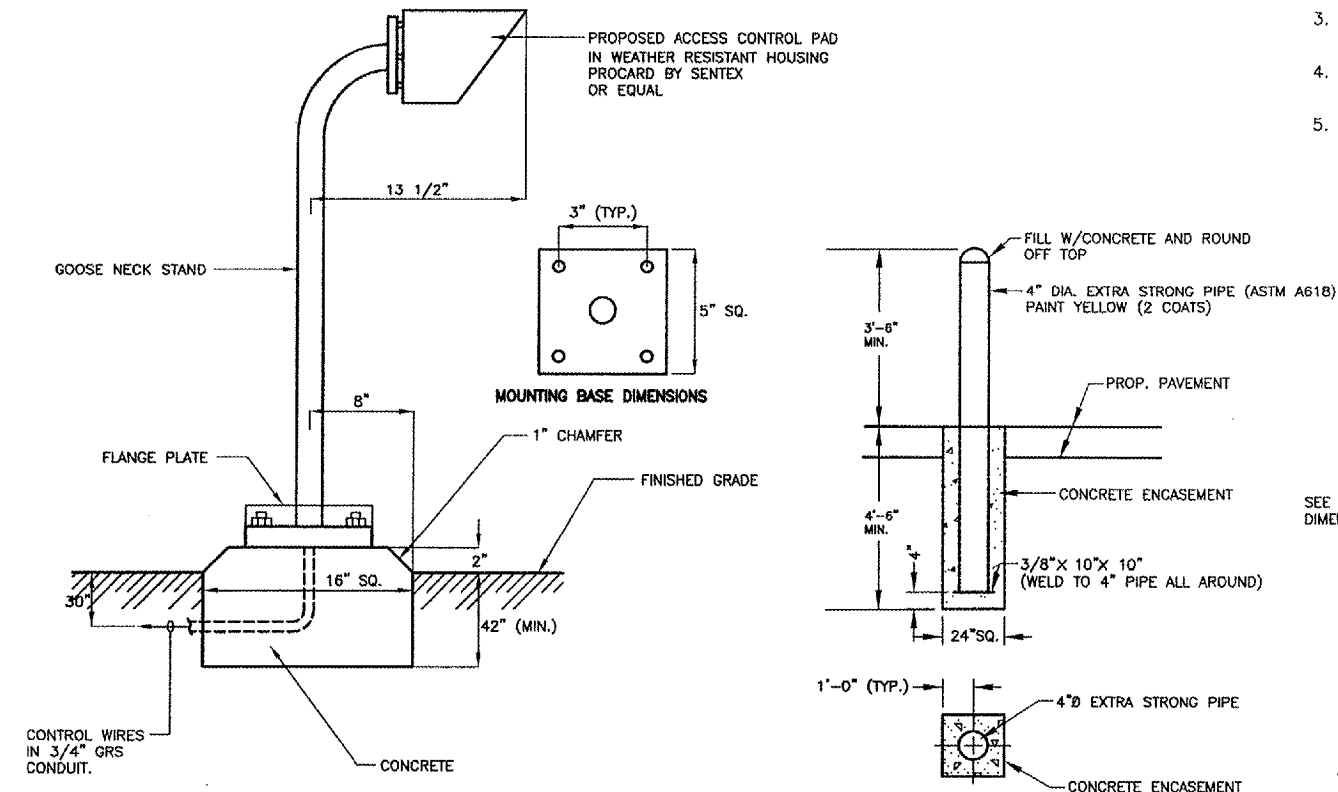

ACCESS CONTROL PAD MOUNTING DETAIL

NOT TO SCALE

VEHICULAR BARRIER DETAIL

NOT TO SCALE

NOTES:

1. THE VEHICULAR BARRIERS WILL NOT BE MEASURED SEPARATELY FOR PAYMENT BUT SHALL BE CONSIDERED INCIDENTAL TO ELECTRIC GATE.
2. LOCATION OF UNDERGROUND ELECTRICAL ITEMS SHALL BE COORDINATED WITH VEHICULAR BARRIERS TO AVOID ANY CONFLICTS.
3. CONTRACTORS SHALL INSTALL TWO VEHICULAR BARRIERS ADJACENT TO THE GATE OPERATOR AND TWO VEHICULAR BARRIERS ADJACENT TO ACCESS CONTROL PAD.

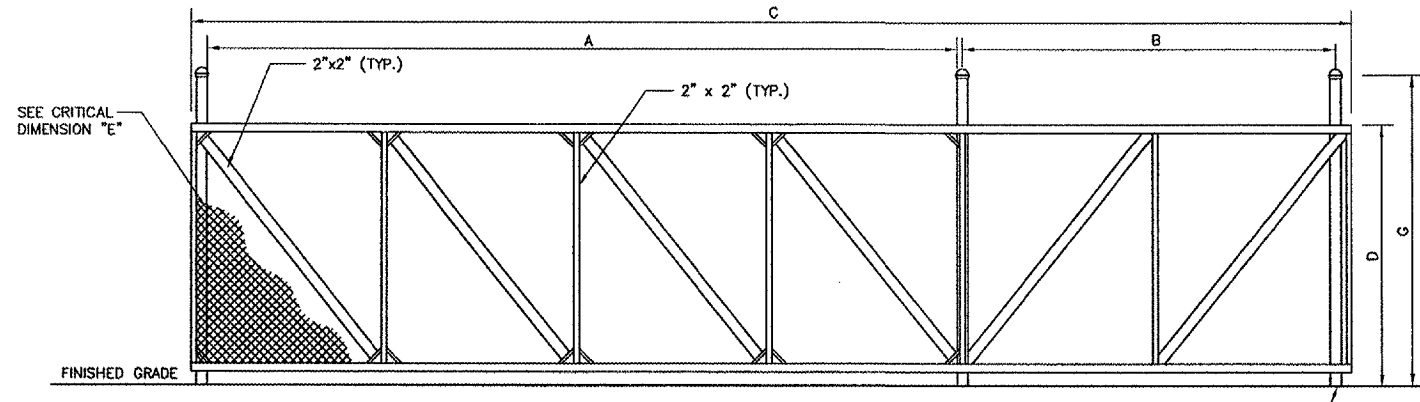

ELEVATION

CANTILEVER SLIDE GATE

NOT TO SCALE

LOCATIONS, DETAILS AND CHARACTER OF EQUIPMENT SHOWN ON THIS SHEET ARE GENERIC. EQUIPMENT LOCATIONS SHALL BE AS RECOMMENDED BY THE EQUIPMENT MANUFACTURER.

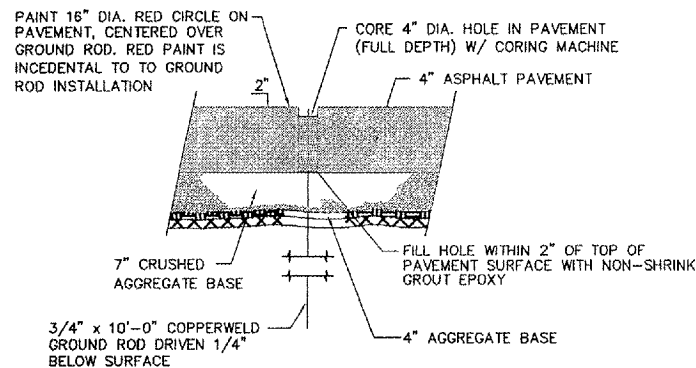

**GROUND ROD DETAIL**

N.T.S.

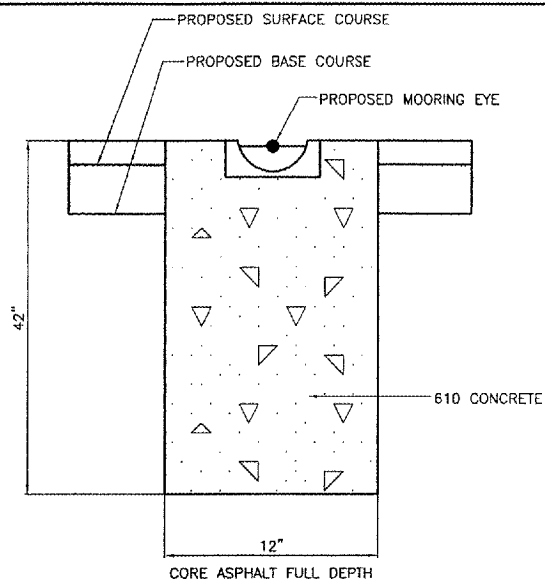

**SECTION**

**MOORING EYE INSTALLATION DETAIL**

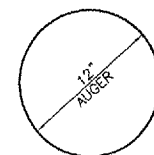

**PLAN**

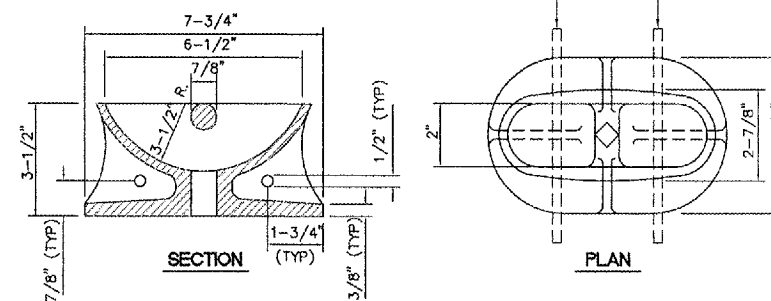

**MOORING EYE DETAIL**

N.T.S.

**NOTES**

- 1.) MOORING CASTINGS SHALL BE NEENAH SEMI-STEEL AIRPORT MOORING EYE CATALOG NO. R3490 OR APPROVED EQUIVALENT.
- 2.) ANCHOR RODS TO BE NO. 3 DEFORMED REINFORCING STEEL 15" LONG AND SHALL BE BENT DOWNWARD AT 45°.

**BARRIER CURB, DEPRESSED CURB AND CURB AND GUTTER TYPE B-6.12 NOTES**

1. CONTRACTION JOINTS SHALL BE PLACED AT TEN (10) FOOT MINIMUM ON CENTERS AND SHALL BE SAW CUT TO MINIMUM DEPTH OF TWO (2) INCHES FROM FRONT TO BACK AS SOON AS THE CONCRETE IS SUFFICIENTLY CURED TO ALLOW CUTTING. AS A MAXIMUM, THE CURB SHALL BE SAWED WITHIN TWENTY-FOUR (24) HOURS OF CONCRETE PLACEMENT. CONTRACTION JOINTS SHALL BE FILLED WITH GRAY NP1 OR EQUIVALENT.
2. EXPANSION JOINTS SHALL BE CONSTRUCTED AT A 50' MAXIMUM SPACING.
3. ALL CURBS SHALL BE CURED AND PROTECTED TO THE REQUIREMENTS OF ARTICLE 606 OF THE STATE OF ILLINOIS "STANDARD SPECIFICATIONS FOR ROAD AND BRIDGE CONSTRUCTION" LATEST EDITION. MEMBRANE CURING WITH W.R. MEADOWS CS 309, OR APPROVED EQUAL, WILL BE ALLOWED WITH A WHITE FUGITIVE DYE, AS PER TYPE II MEMBRANE CURING.
4. CURB AND GUTTER SHALL HAVE A LIGHT BROOM FINISH.
5. EXPANSION JOINTS SHALL ALSO BE PLACED AT ALL POINTS OF CURVATURE, AT 5' EACH SIDE OF ALL DRAINAGE STRUCTURES, AT THE END OF THE DAYS POUR, OR AS DIRECTED BY THE ENGINEER.
6. TWO (2) NO. 5 REBARS (TEN) 10' LONG SHALL BE PLACED ON EITHER SIDE OF ALL PROPOSED UTILITY TRENCHES.
7. THREE (3) NO. 5 REBARS SPACED 5' APART SHALL BE PLACED THE LENGTH OF ALL DEPRESSED CURB.

**SIDEWALK RAMPS**

1. SIDEWALK RAMPS ACCESSIBLE TO THE DISABLED SHALL BE PROVIDED AT ALL LOCATIONS WHERE THE FUTURE SIDEWALK MEETS THE PROPOSED CURB AND GUTTER AND SHALL BE CONSTRUCTED IN ACCORDANCE WITH SECTION 424 OF THE STANDARD SPECIFICATIONS AND STANDARD 424001. THIS WORK SHALL BE PAID FOR AS PORTLAND CEMENT CONCRETE SIDEWALK.

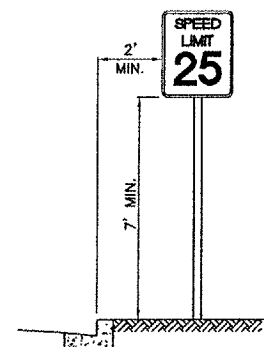

**POST MOUNTED SIGN LOCATION DETAIL**

NO SCALE

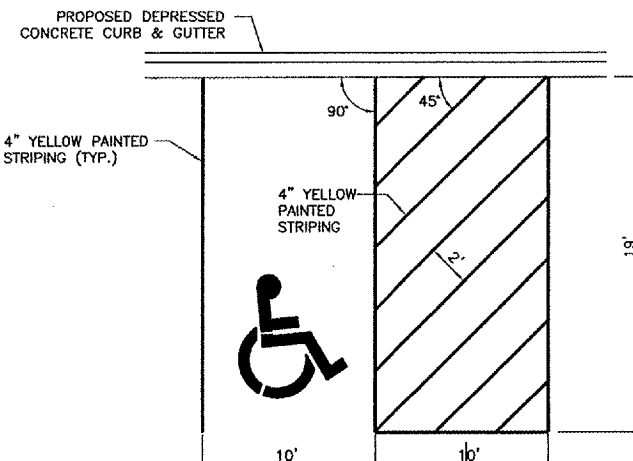

**HANDICAP PARKING STALL STRIPING DETAIL**

NO SCALE

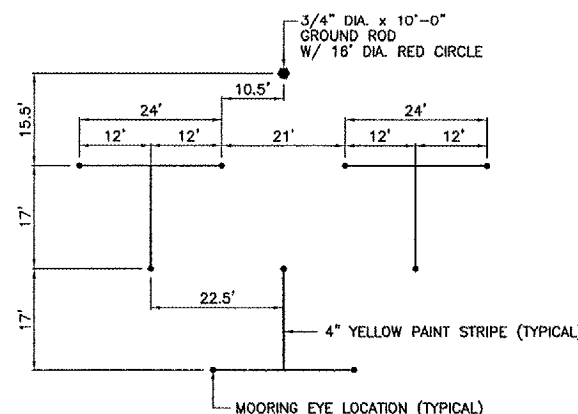

**TIEDOWN DETAIL**

NO SCALE

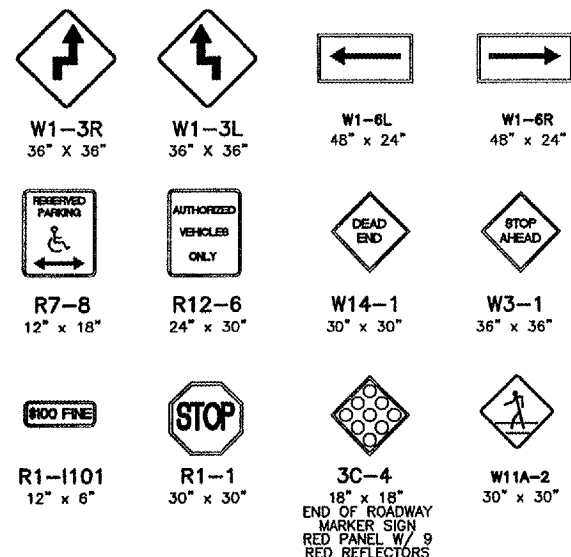

**SIGN LEGEND**

NO SCALE

- NOTE: 1. ALL SIGNS ARE STANDARD MATERIALS, COLORS AND LETTER STYLE AND SIZE AS SHOWN IN THE "MANUAL OF UNIFORM TRAFFIC CONTROL DEVICES", 2001 EDITION.
2. SIGN R7-1101 (\$100 FINE) TO BE INSTALLED UNDER ALL SIGNS R7-8. (COST INCIDENTAL)

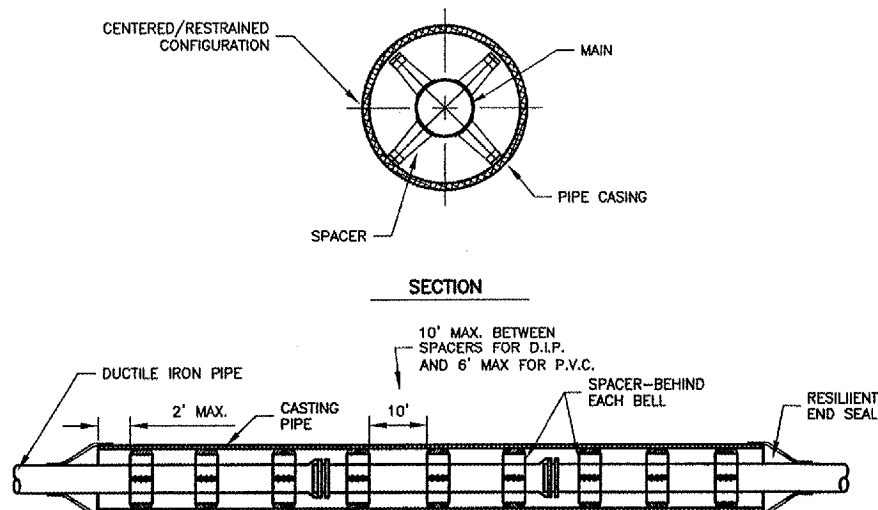

**CASING SPACER DETAIL**

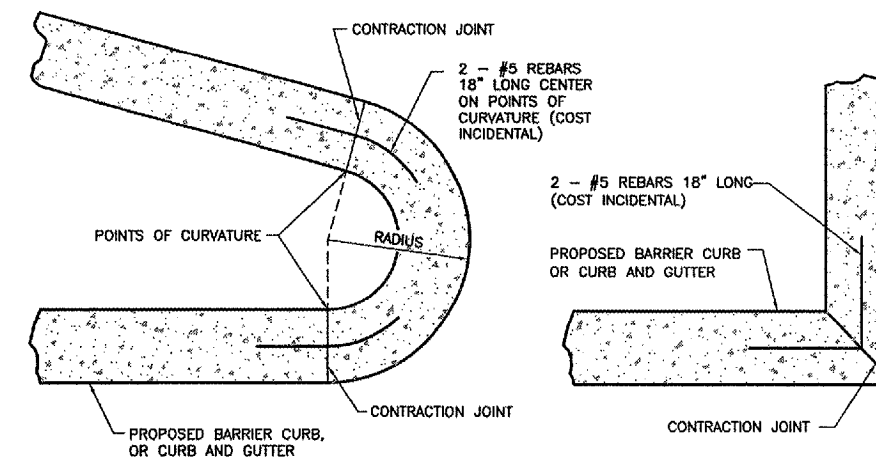

**ISLAND RADII REINFORCEMENT DETAIL**

N.T.S.

INSTALL TIE BARS IN LIEU OF DOWEL BARS WHEN RADII ARE 7.5' AND LESS.

**CORNER REINFORCEMENT DETAIL**

N.T.S.

REINFORCEMENTS SHALL BE INSTALLED AT ALL CORNERS.

LANSING MUNICIPAL AIRPORT  
 LANSING, ILLINOIS  
 NORTH QUADRANT SITEWORK - PHASE 1  
 AND TAXIWAY G2 EXTENSION

MISCELLANEOUS DETAILS

© copyright CMT, Inc.

**CMT**  
 CRAWFORD, MURPHY & TILLY, INC.  
 CONSULTING ENGINEERS  
 License No. 184-000613

Lansing Municipal Airport

DESIGN BY:	ARM
DRAWN BY:	JRO
CHECKED BY:	ARM
APPROVED BY:	
DATE:	03/04/05
JOB No:	03297-02

IL PROJECT: IGQ-3329  
 A.I.P. PROJECT: 3-17-0121-B21



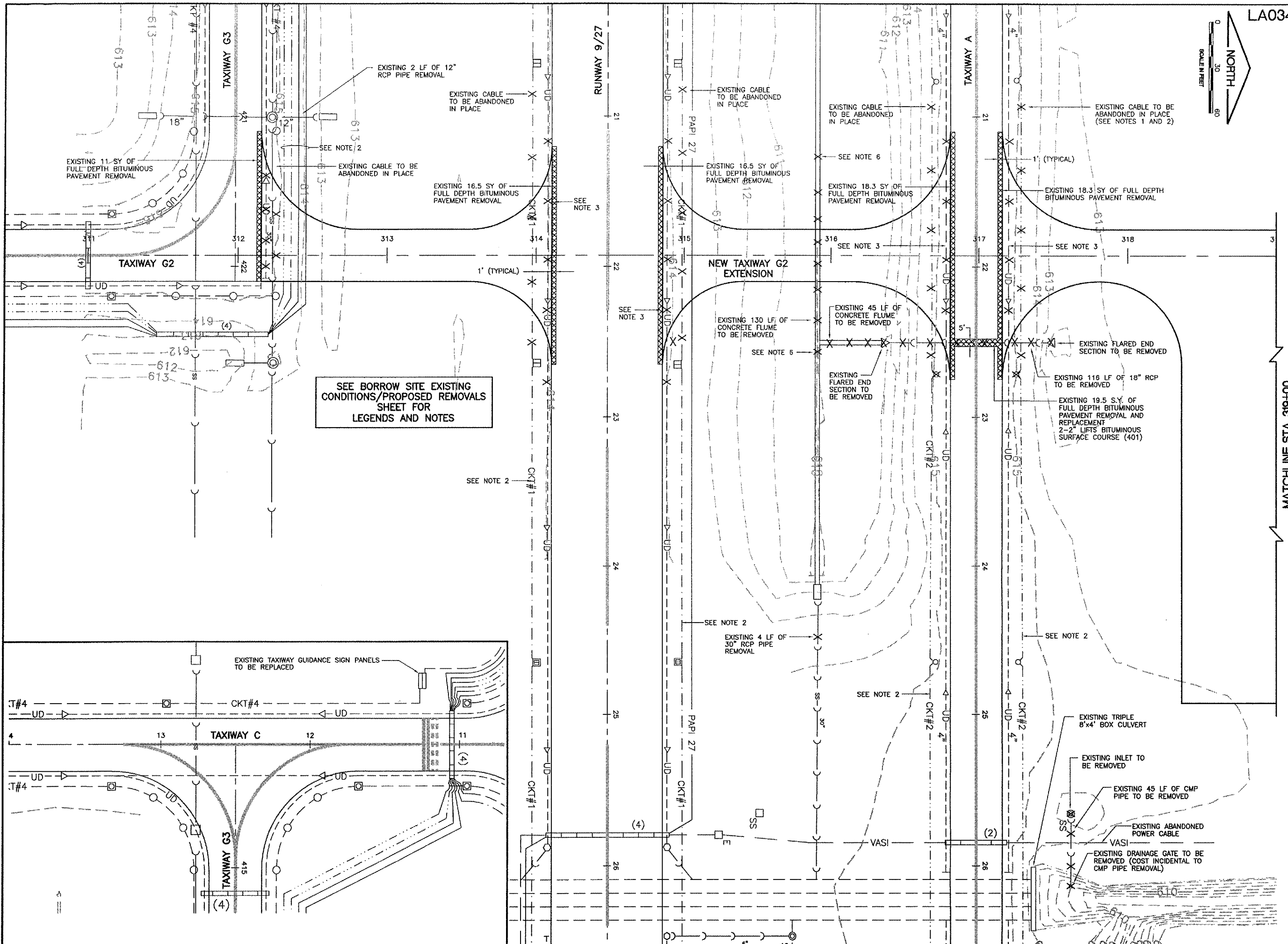

LA034

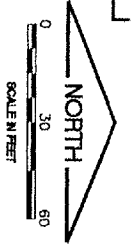

K:\LansingAp\0329702\draw\sheets\  
 FILE: econd2.dwg  
 LAYOUT: Layout1  
 UPDATE BY: johse  
 SURVEY BOOK #  
 DATE: Thu 3/10/05 5:16pm  
 XREF DWG: tbcint.dwg  
 tb.dwg  
 nethgr-base.dwg

REVISIONS		
NUMBER	BY	DATE

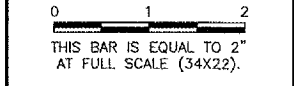

**EXISTING CONDITIONS/PROPOSED REMOVALS  
 TAXIWAY G2 EXTENSION**

**LANSING MUNICIPAL AIRPORT**  
 LANSING, ILLINOIS

**NORTH QUADRANT SITework - PHASE 1  
 AND TAXIWAY G2 EXTENSION**

DESIGN BY:	ARM
DRAWN BY:	JRO
CHECKED BY:	ARM
APPROVED BY:	
DATE:	03/04/05
JOB No:	03297-02
IL PROJECT:	100-3329
A.I.P. PROJECT:	3-17-0121-B21

LA034

K:\Lansing\0329702\draw\sheet\ FILE: PP1.dwg  
 LAYOUT: Layout1  
 UPDATE BY: johse  
 SURVEY BOOK # 1  
 DATE: Tue 3/8/05 5:50pm  
 XREF DWG: nethgr-base.dwg  
 tbcint.dwg  
 tb.dwg  
 tbrprgrd.dwg

REVISIONS		
NUMBER	BY	DATE

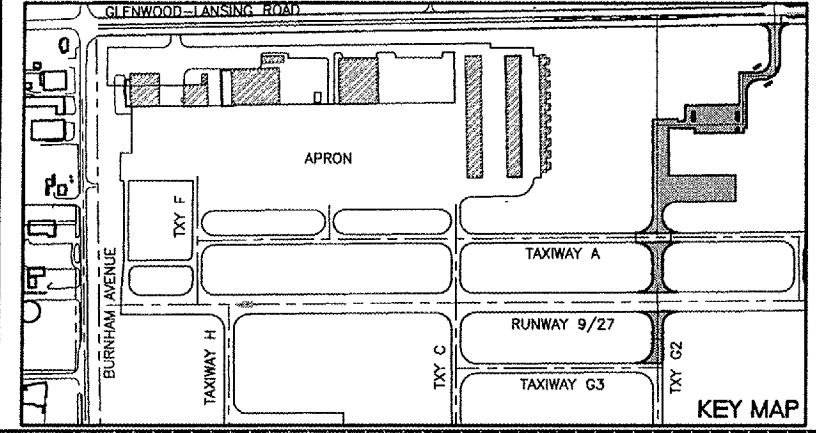
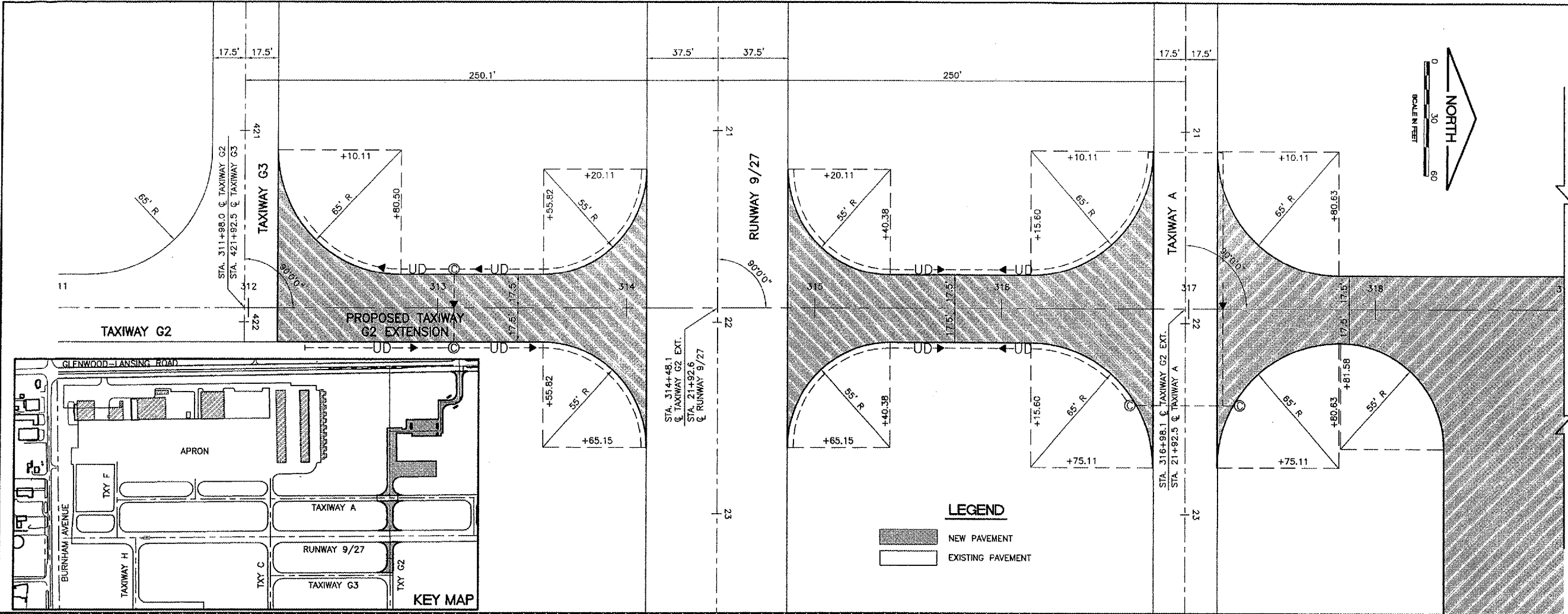
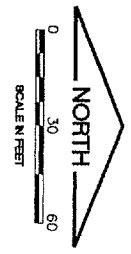
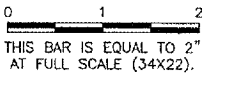

SEE GRADING PLAN FOR HANGAR SITE AND AUTO PARKING LOT  
 MATCHLINE STA. 319+00

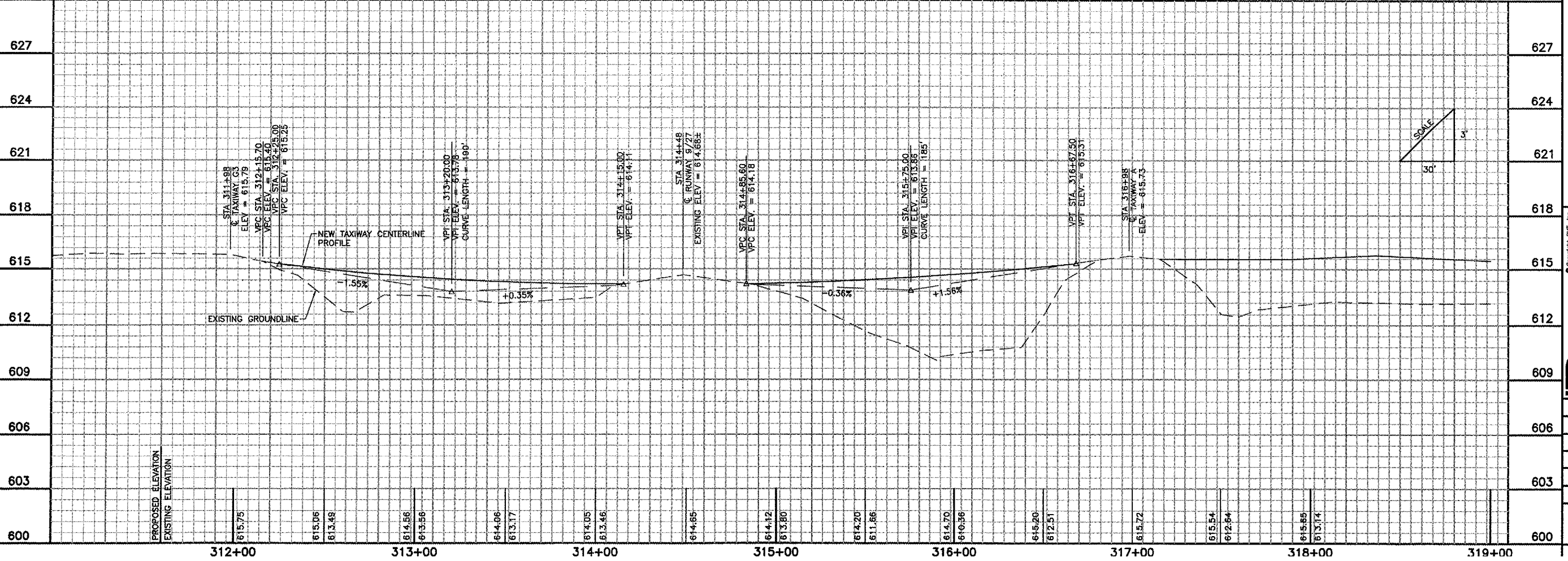

LANSING MUNICIPAL AIRPORT  
 LANSING, ILLINOIS  
 NORTH QUADRANT SITEWORK - PHASE 1  
 AND TAXIWAY G2 EXTENSION  
 PLAN AND PROFILE TAXIWAY G2  
 STA. 311+00 TO STA. 319+00

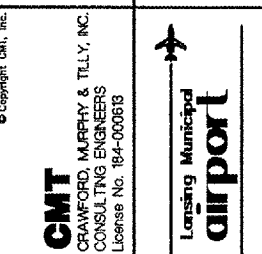

DESIGN BY:	ARM
DRAWN BY:	JRO
CHECKED BY:	ARM
APPROVED BY:	
DATE:	03/04/05
JOB No:	03297-02
IL PROJECT: IGQ-3329 A.I.P. PROJECT: 3-17-0121-821	

LA034

K:\LansingAp\0329702\draw\sheet\FILE: grade.dwg  
LAYOUT: Layout1  
UPDATE BY: johse  
SURVEY BOOK #  
DATE: Fri 3/11/05 9:44am  
XREF DWG: nethgr-base.dwg  
tblnt.dwg  
tb.dwg

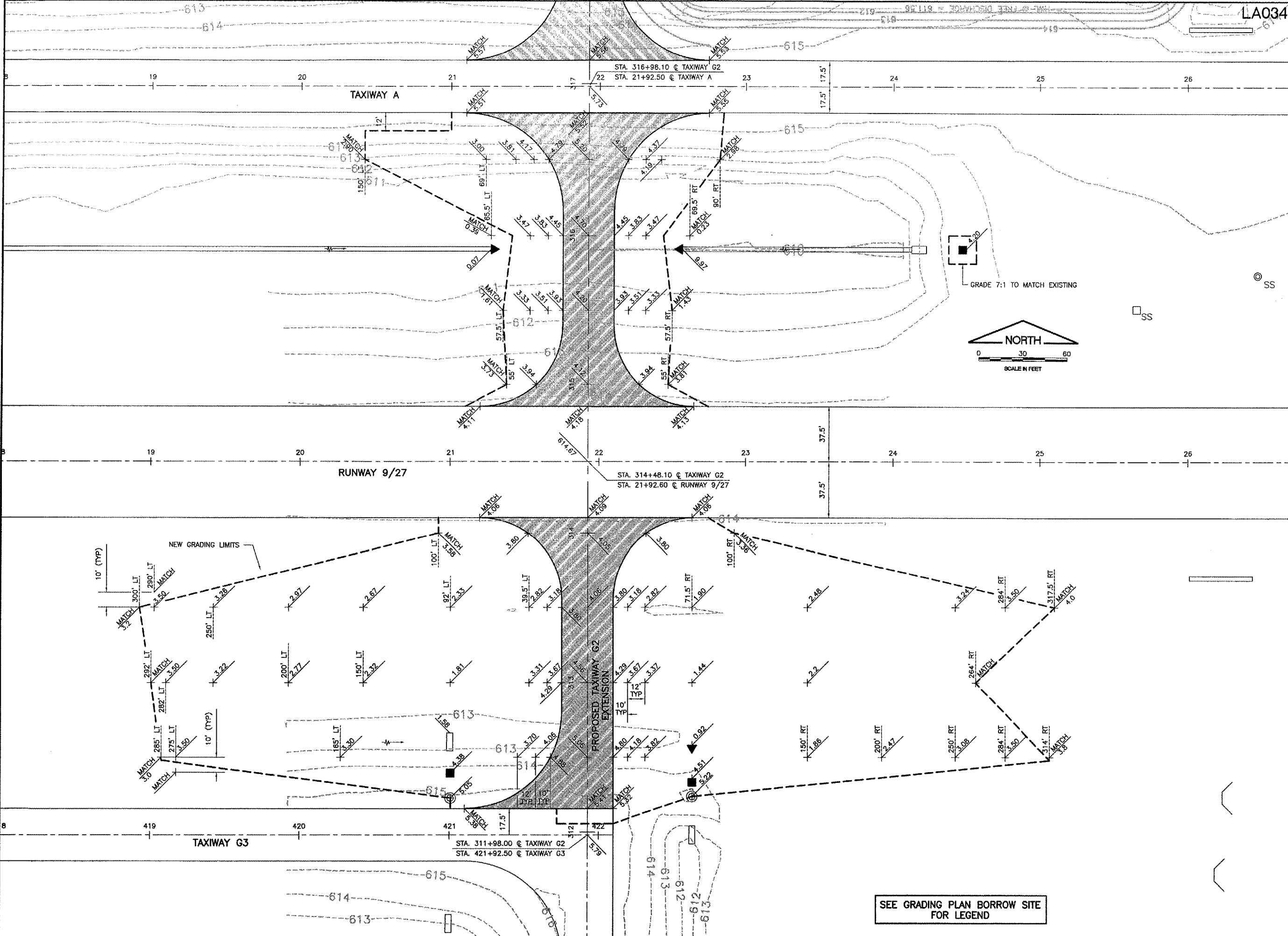

REVISIONS		
NUMBER	BY	DATE

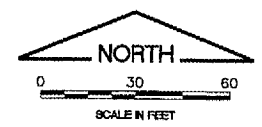
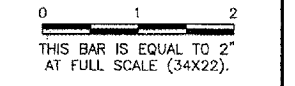

**LANSING MUNICIPAL AIRPORT  
LANSING, ILLINOIS  
NORTH QUADRANT SITEMARK - PHASE 1  
AND TAXIWAY G2 EXTENSION  
TAXIWAY G2 EXTENSION**

© Copyright GMT, Inc.



**GMT**  
CRAWFORD, MURPHY & TILLY, INC.  
CONSULTING ENGINEERS  
License No. 164-000613



DESIGN BY:	ARM
DRAWN BY:	JRO
CHECKED BY:	ARM
APPROVED BY:	
DATE:	03/04/05
JOB No:	03297-02

IL PROJECT: IGQ-3329  
A.I.P. PROJECT: 3-17-0121-B21

SEE GRADING PLAN BORROW SITE FOR LEGEND



**LEGEND**

- NEW PAVEMENT
- NEW STAKE MOUNTED MEDIUM INTENSITY TAXIWAY LIGHT (MITL)
- NEW BASE MOUNTED MEDIUM INTENSITY TAXIWAY LIGHT (MITL)
- EXISTING STAKE MOUNTED TAXIWAY LIGHT
- EXISTING BASE MOUNTED TAXIWAY LIGHT
- NEW AIRFIELD GUIDANCE SIGN
- EXISTING AIRFIELD GUIDANCE SIGN
- NEW GRS CONDUIT, DIRECT BURY
- NEW CONCRETE ENCASED DUCT (NUMBER OF WAYS NOTED)
- EXISTING CONCRETE ENCASED DUCT (NUMBER OF WAYS SHOWN)
- NEW POWER POLE (BY COMED)
- NEW ELECTRICAL HANDHOLE
- NEW ROADWAY TRANSCLOSURE
- NEW GATE OPERATOR
- NEW RETROREFLECTIVE MARKER
- NEW ROADWAY LIGHT
- NEW GROUND ROD
- NEW POWER CABLE (NO. AND SIZE OF CONDUITS AS SHOWN) (DIRECT BURIED)
- NEW 1/C #8 5KV, L-824 CABLE IN 34" UNIT DUCT CIRCUIT #1 RUNWAY 9/27
- NEW 1/C #8 5KV, L-824 CABLE IN 34" UNIT DUCT CIRCUIT #1 TAXIWAY A
- NEW 1/C #8 5KV, L-824 CABLE IN 34" UNIT DUCT CIRCUIT #1 TAXIWAY (G2,G3)
- EXISTING RUNWAY 9/27 CIRCUIT
- EXISTING TAXIWAY A CIRCUIT
- EXISTING RUNWAY 18/36 CIRCUIT
- EXISTING TAXIWAY CIRCUIT (G2,G3)
- EXISTING RUNWAY 36 PAPI CIRCUIT
- EXISTING RUNWAY 18 PAPI CIRCUIT
- EXISTING RUNWAY 27 PAPI CIRCUIT
- EXISTING AWOS CIRCUIT
- NEW DEPRESSED CURB

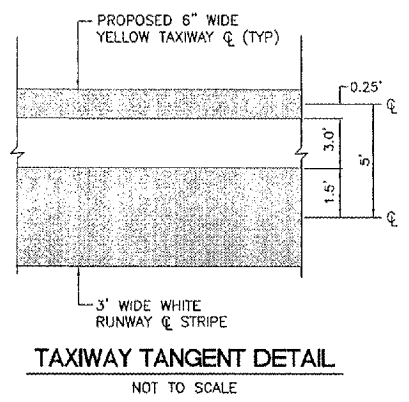
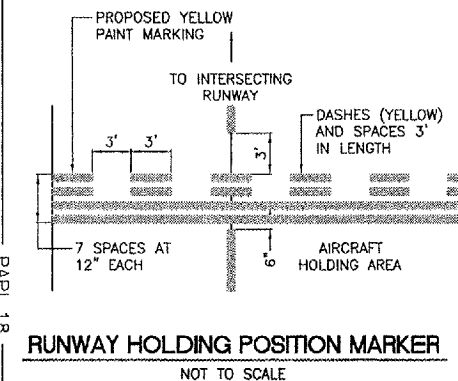
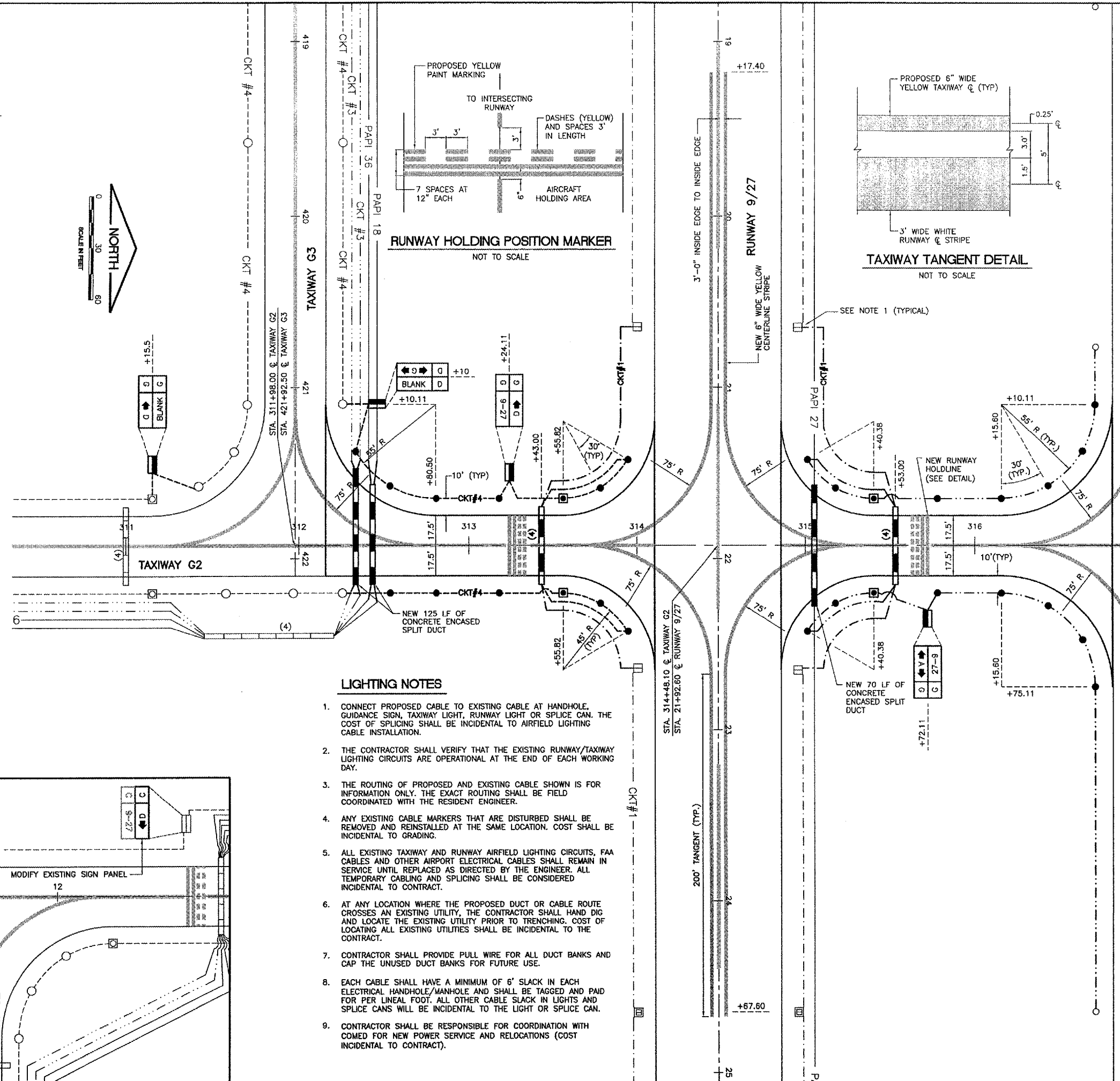
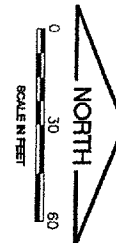

**LIGHTING NOTES**

1. CONNECT PROPOSED CABLE TO EXISTING CABLE AT HANDHOLE, GUIDANCE SIGN, TAXIWAY LIGHT, RUNWAY LIGHT OR SPLICE CAN. THE COST OF SPLICING SHALL BE INCIDENTAL TO AIRFIELD LIGHTING CABLE INSTALLATION.
2. THE CONTRACTOR SHALL VERIFY THAT THE EXISTING RUNWAY/TAXIWAY LIGHTING CIRCUITS ARE OPERATIONAL AT THE END OF EACH WORKING DAY.
3. THE ROUTING OF PROPOSED AND EXISTING CABLE SHOWN IS FOR INFORMATION ONLY. THE EXACT ROUTING SHALL BE FIELD COORDINATED WITH THE RESIDENT ENGINEER.
4. ANY EXISTING CABLE MARKERS THAT ARE DISTURBED SHALL BE REMOVED AND REINSTALLED AT THE SAME LOCATION. COST SHALL BE INCIDENTAL TO GRADING.
5. ALL EXISTING TAXIWAY AND RUNWAY AIRFIELD LIGHTING CIRCUITS, FAA CABLES AND OTHER AIRPORT ELECTRICAL CABLES SHALL REMAIN IN SERVICE UNTIL REPLACED AS DIRECTED BY THE ENGINEER. ALL TEMPORARY CABLING AND SPLICING SHALL BE CONSIDERED INCIDENTAL TO CONTRACT.
6. AT ANY LOCATION WHERE THE PROPOSED DUCT OR CABLE ROUTE CROSSES AN EXISTING UTILITY, THE CONTRACTOR SHALL HAND DIG AND LOCATE THE EXISTING UTILITY PRIOR TO TRENCHING. COST OF LOCATING ALL EXISTING UTILITIES SHALL BE INCIDENTAL TO THE CONTRACT.
7. CONTRACTOR SHALL PROVIDE PULL WIRE FOR ALL DUCT BANKS AND CAP THE UNUSED DUCT BANKS FOR FUTURE USE.
8. EACH CABLE SHALL HAVE A MINIMUM OF 6' SLACK IN EACH ELECTRICAL HANDHOLE/MANHOLE AND SHALL BE TAGGED AND PAID FOR PER LINEAL FOOT. ALL OTHER CABLE SLACK IN LIGHTS AND SPLICE CANS WILL BE INCIDENTAL TO THE LIGHT OR SPLICE CAN.
9. CONTRACTOR SHALL BE RESPONSIBLE FOR COORDINATION WITH COMED FOR NEW POWER SERVICE AND RELOCATIONS (COST INCIDENTAL TO CONTRACT).

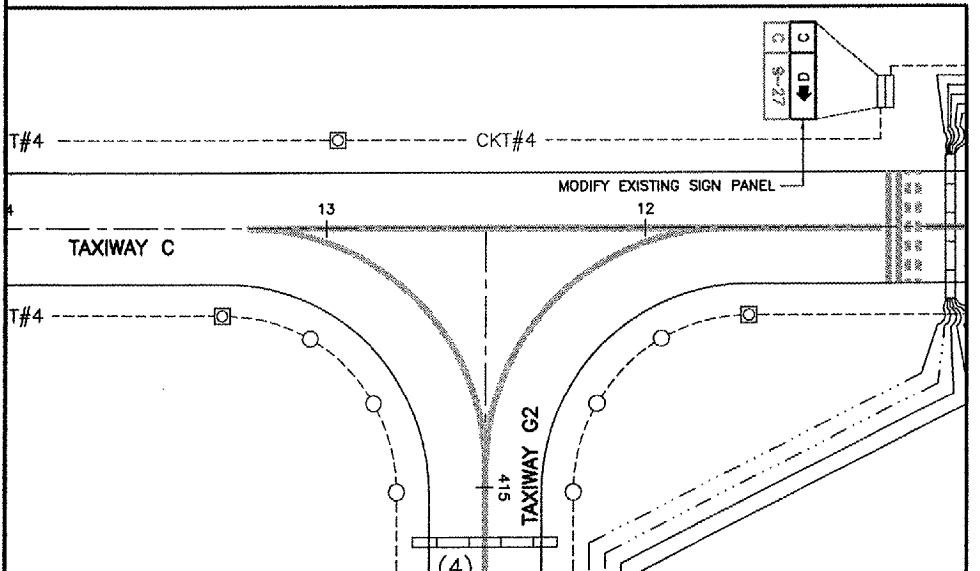

LA034  
K:\LansingAp\0329702\draw\sheet\FILE: pmark2.dwg  
LAYOUT: Layout1  
UPDATE BY: johse  
SURVEY BOOK #  
DATE: Fri 3/11/05 10:38am  
XREF DWG: nethgr-base.dwg  
tbclnt.dwg  
tb.dwg

REVISIONS		
NUMBER	BY	DATE

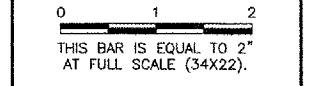

**LANSING MUNICIPAL AIRPORT  
LANSING, ILLINOIS  
NORTH QUADRANT SITEWORK - PHASE 1  
AND TAXIWAY G2 EXTENSION  
LIGHTING AND PAVEMENT MARKING PLAN  
TAXIWAY G2 EXTENSION**

© Copyright GMT, Inc.  
**GMT**  
CRANFORD, MERRILL & TILLY, INC.  
CONSULTING ENGINEERS  
License No. 184-000618

Lansing Municipal  
**airport**

DESIGN BY:	ARM
DRAWN BY:	JRO
CHECKED BY:	ARM
APPROVED BY:	
DATE:	03/04/05
JOB No:	03297-02
IL PROJECT:	IG0-3329
A.I.P. PROJECT:	3-17-0121-B21
SHEET	33 OF 50 SHEETS

**GENERAL EARTHWORK NOTES:**

- ALL EARTHWORK QUANTITIES ARE CALCULATED BASED ON THE MATERIAL IN ITS INITIAL OR FINAL POSITION AS SHOWN IN THE PLANS AND QUANTIFIED BY METHOD OF AVERAGE END AREAS. SHRINKAGE FACTORS HAVE BEEN ESTIMATED AND ARE INCLUDED FOR THE UNCLASSIFIED EXCAVATION DISPOSAL QUANTITY AND NO CHANGES IN PAYMENT WILL BE MADE FOR ANY VARIATIONS IN SHRINKAGE.
- ALL HAUL ROADS TO BE CONSTRUCTED FOR THE PROJECT WILL NOT BE MEASURED FOR PAYMENT BUT SHALL BE CONSIDERED INCIDENTAL TO THE PROJECT.
- SURPLUS MATERIALS SHALL BE STOCKPILED ONSITE BY THE CONTRACTOR. STOCKPILING OF EXCESS MATERIALS SHALL BE PAID FOR AS ONSITE STOCKPILE. SEE STORM WATER POLLUTION PREVENTION PLAN FOR APPROXIMATE LOCATION OF STOCKPILE.
- CONTRACTOR'S HAUL ROADS SHALL BE RESTORED WITH 4" MINIMUM OF TOPSOIL PLACED. ALL HAUL ROAD RESTORATION SHALL BE INCIDENTAL TO THE CONTRACT AND NO SEPARATE PAYMENT SHALL BE MADE.
- WHEN THE VOLUME OF UNCLASSIFIED EXCAVATION IS NOT SUFFICIENT FOR EMBANKMENT FILL, IT SHALL BE SUPPLIED FROM THE ON-SITE BORROW AREA.
- UNCLASSIFIED EXCAVATION IS INCIDENTAL TO EMBANKMENT FILL. TOPSOIL STRIPPING IS INCIDENTAL TO TOPSOIL PLACEMENT AND SHOULDER FILL.
- EXISTING BERMS SHALL REMAIN IN PLACE AT THE LANSING DRAINAGE DITCH.
- BORROW AREA SHALL HAVE 4" MINIMUM OF TOPSOIL PLACED AND SEEDED AND MULCHED. SEEDING AND MULCHING SHALL BE PAID UNDER ITEMS 901 AND 908, RESPECTIVELY. CONTRACTOR'S HAUL ROADS TO THE BORROW SITE SHALL HAVE 4" MINIMUM OF TOPSOIL PLACED AND SEEDED AND MULCHED (COST INCIDENTAL).
- AREAS OF UNSUITABLE MATERIAL (UNCLASSIFIED EXCAVATION) SHALL BE AS DESIGNATED BY THE ENGINEER. THE QUANTITY OF UNSUITABLE MATERIAL SHALL NOT BE USED AS EMBANKMENT FILL MATERIAL UNLESS AUTHORIZED BY THE ENGINEER.
- CONTRACTOR IS REQUIRED TO CONSTRUCT THE PROPOSED BORROW SITE NO HIGHER THAN THE LINES AND GRADES SHOWN TO MEET COMPENSATORY STORAGE VOLUME REQUIREMENTS PER THE IDOT OFFICE OF WATER RESOURCES PERMIT.
- THE STOCKPILING OF EXCESS TOPSOIL AND UNCLASSIFIED EXCAVATION SHALL BE KEPT SEPERATE. ALL STOCKPILES SHALL HAVE 4" MINIMUM OF TOPSOIL PLACED. COSTS ASSOCIATED WITH SEPARATION OF STOCKPILES AND TOPSOIL PLACEMENT SHALL BE INCIDENTAL TO THE PAY ITEM.

**REVISIONS**

NUMBER	BY	DATE
1	ARM	6/10/05

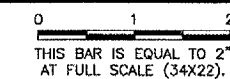

**LANSING MUNICIPAL AIRPORT  
 LANSING, ILLINOIS  
 NORTH QUADRANT SITWORK - PHASE 1  
 AND TAXIWAY G2 EXTENSION  
 INDEX TO CROSS SECTIONS/  
 EARTHWORK SUMMARY**

**LEGEND**

	NEW PAVEMENT
	EXISTING BUILDING
	PROPOSED/FUTURE BUILDING/PAVEMENT
	EXISTING PAVEMENT

**EARTHWORK SUMMARY TABLE**

LOCATION	TOPSOIL STRIPPING	TOPSOIL PLACEMENT	SHOULDER FILL	UNCLASSIFIED EXCAVATION	EMBANKMENT FILL
	INITIAL POSITION (CUBIC YARD)	FINAL POSITION (CUBIC YARD)	FINAL POSITION (CUBIC YARD)	INITIAL POSITION (CUBIC YARD)	FINAL POSITION (CUBIC YARD)
TAXIWAY G2 EXTENSION	1,807	585	671	1,046	649
NORTH QUADRANT HANGAR SITWORK	10,984	2,720	2,470	5,580	21,405
BORROW SITE	13,234	4,443	10	25,290	-
UNSUITABLE MATERIAL	-	-	-	1,000	-
<b>TOTALS</b>	<b>28,025</b>	<b>7,748</b>	<b>3,151</b>	<b>32,915</b>	<b>22,054</b>

ONSITE STOCKPILE	14,036	-	-	7,553	-
------------------	--------	---	---	-------	---

- NOTES: 1. ONSITE STOCKPILE SHALL BE COMPUTED USING 10% SHRINKAGE FOR TOPSOIL PLACEMENT AND SHOULDER FILL AND 15% SHRINKAGE FOR EMBANKMENT FILL.  
 2. GLENWOOD-LANSING ROAD EARTHWORK QUANTITIES ARE NOT INCLUDED IN THE ABOVE EARTHWORK SUMMARY TABLE.

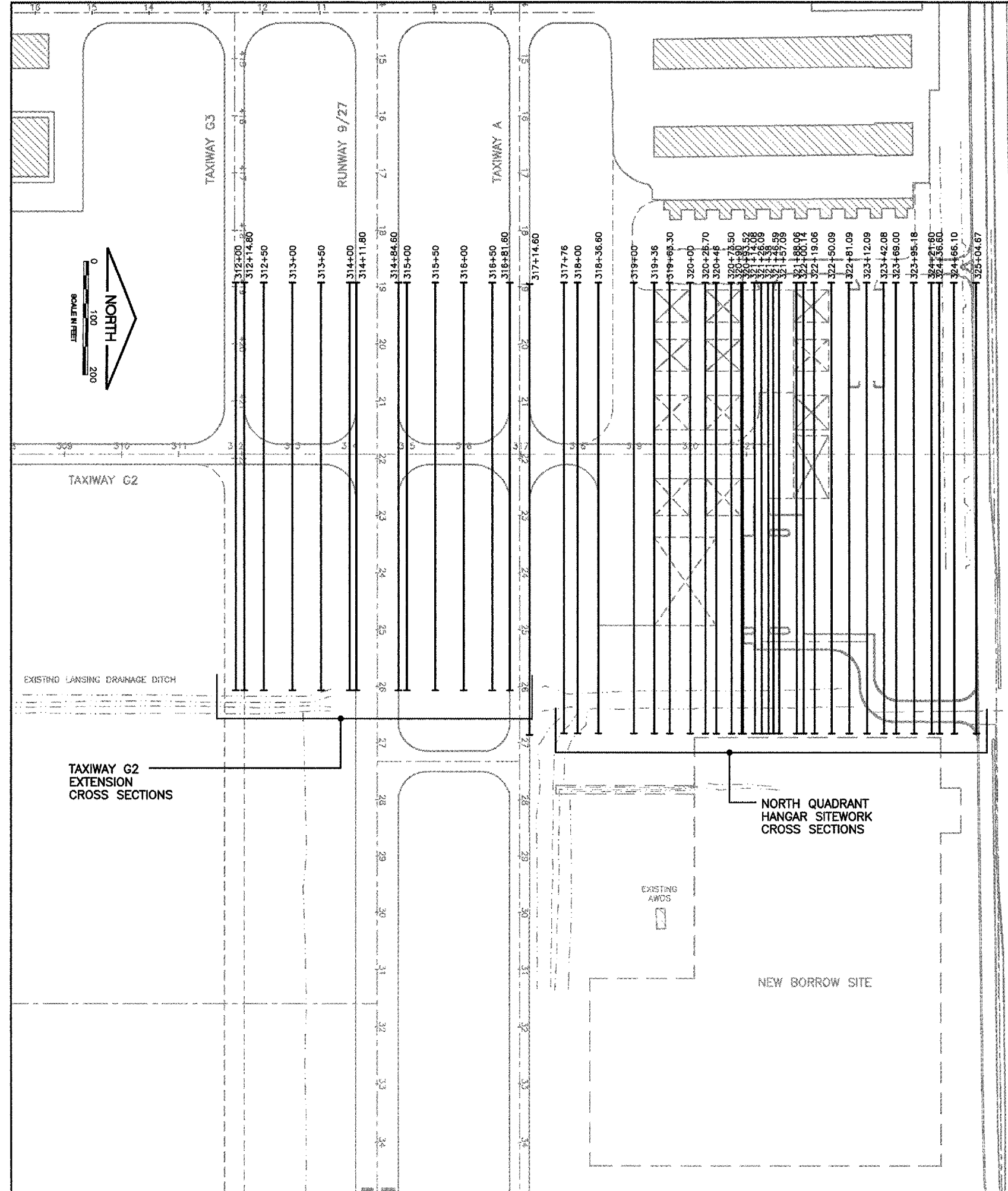

© Copyright CMT, Inc.

**CMT**  
 CRAWFORD, MURPHY & TILLY, INC.  
 CONSULTING ENGINEERS  
 License No. 184-000813

Lansing Municipal  
**airport**

DESIGN BY:	ARM
DRAWN BY:	JRO
CHECKED BY:	ARM
APPROVED BY:	
DATE:	03/04/05
JOB No:	03297-02
IL PROJECT: IGQ-3329 A.I.P. PROJECT: 3-17-0121-B21	
SHEET 34 OF 50 SHEETS	

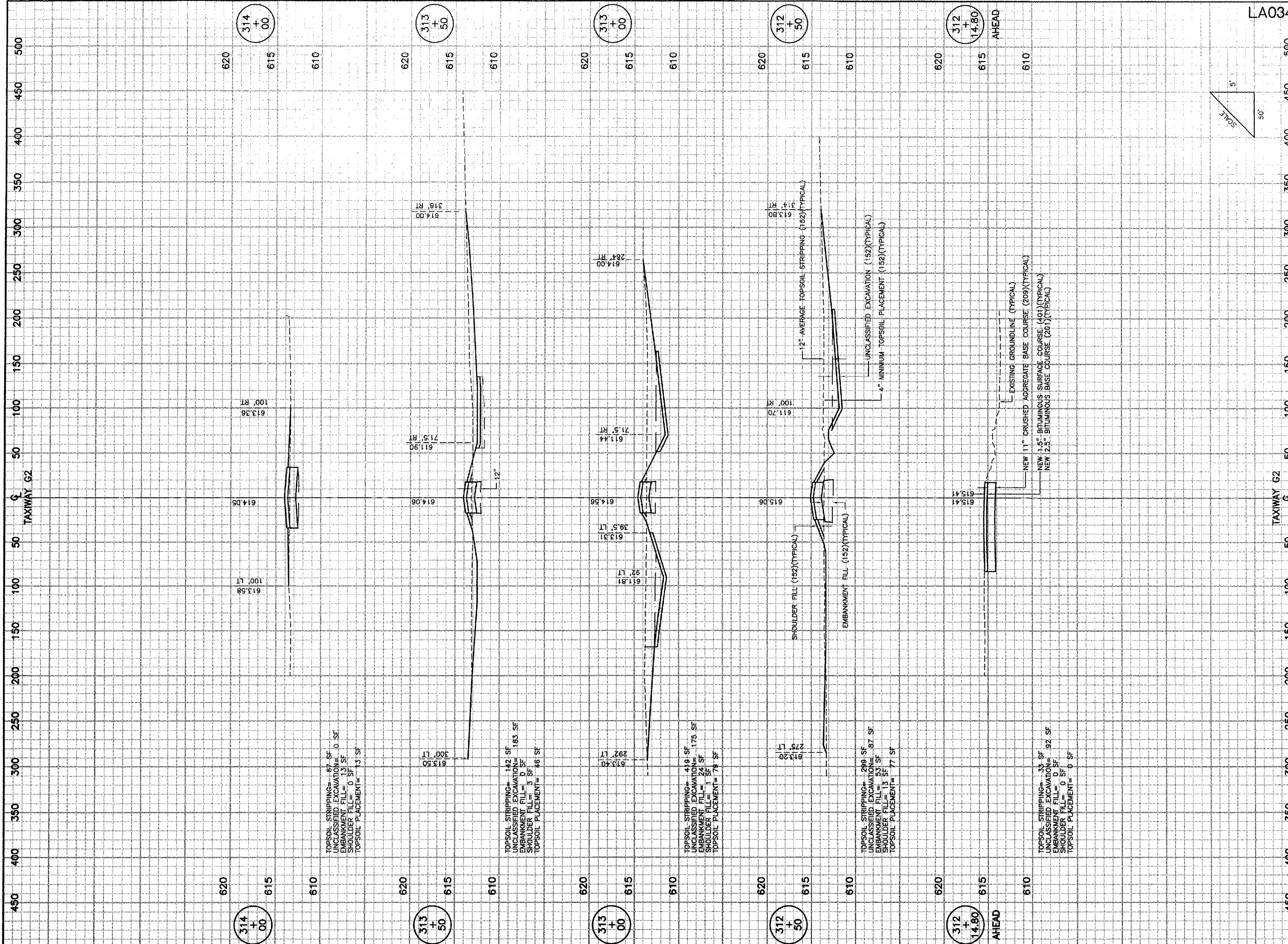

LA034

PATH: K:\LansingAp\0329702\draw\stf-  
 FILE: xsec.dwg  
 UPDATE BY: johae  
 SURVEY BOOK #  
 XREF DWG:  
 XREF DWG:  
 DATE: Tue 5/4/04 8:44am

REVISIONS		
NUMBER	BY	DATE

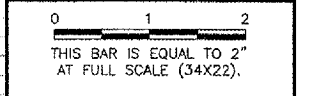

**LANSING MUNICIPAL AIRPORT**  
**LANSING, ILLINOIS**  
**NORTH QUADRANT SITEWORK - PHASE 1**  
**AND TAXIWAY G2 EXTENSION**  
**STA. 312+00 TO STA. 314+00**

© Copyright CMT, Inc.



**CMT**  
 CRAWFORD, MURPHY & TILLY, INC.  
 CONSULTING ENGINEERS  
 License No. 184-000813



DESIGN BY:	ARM
DRAWN BY:	JRO
CHECKED BY:	ARM
APPROVED BY:	
DATE:	03/04/05
JOB No:	03297-02
IL PROJECT:	IGQ-3329
A.I.P. PROJECT:	3-17-0121-B21

SHEET 35 OF 50 SHEETS



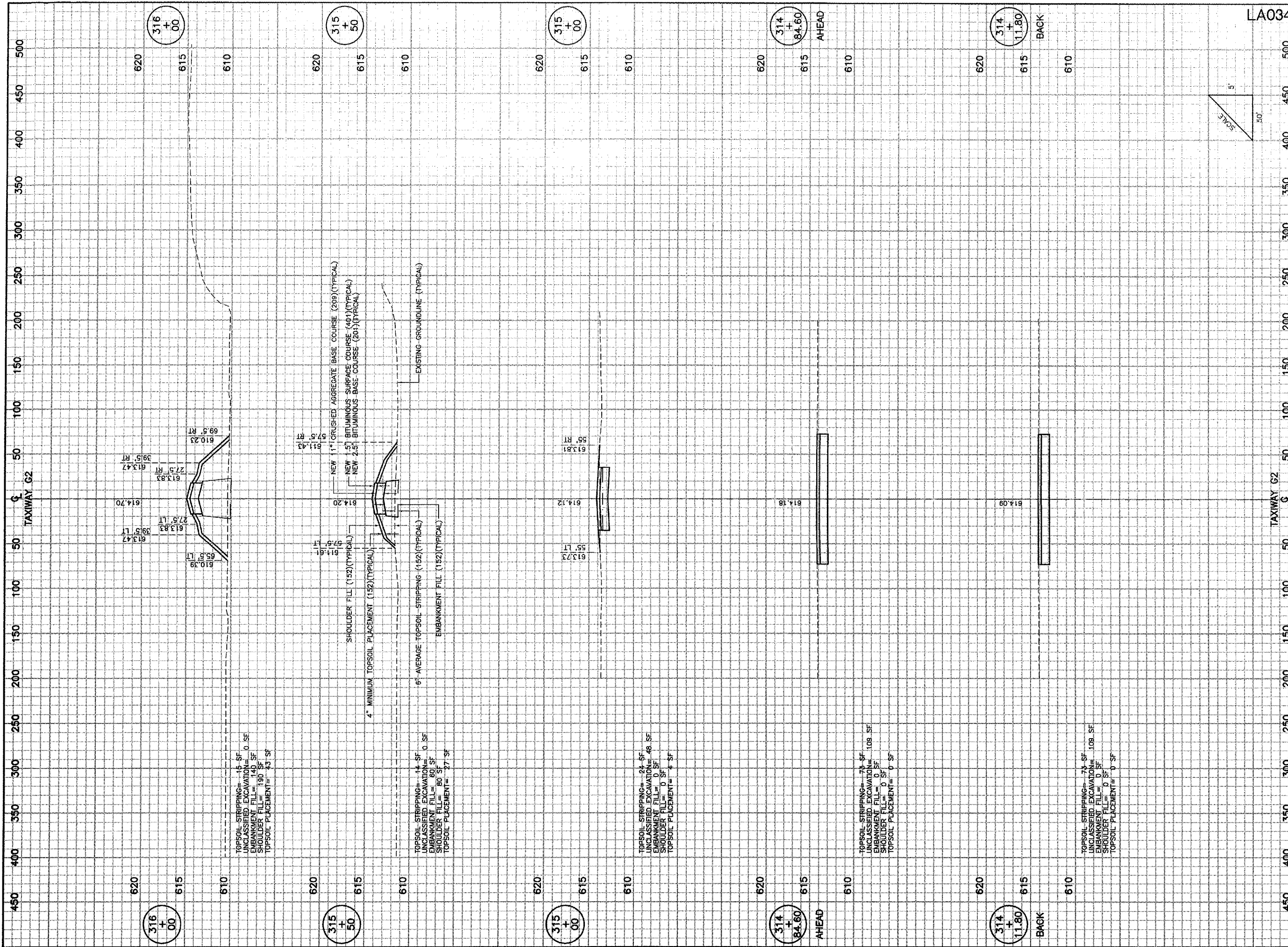

LA034

PATH: K:\LansingAp\0329702\draw\stee  
 FILE: xsec.dwg  
 UPDATE BY: johse  
 SURVEY BOOK #  
 XREF DWG:  
 XREF DWG:  
 DATE: Tue 5/4/04 8:45am

REVISIONS		
NUMBER	BY	DATE

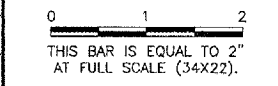

**LANSING MUNICIPAL AIRPORT  
 LANSING, ILLINOIS  
 NORTH QUADRANT SITEWORK - PHASE 1  
 AND TAXIWAY G2 EXTENSION  
 STA. 314+11.80 TO STA. 316+00**

© Copyright CMT, Inc.



**CMT**  
 CRAWFORD, MURPHY & TILLY, INC.  
 CONSULTING ENGINEERS  
 License No. 84-00618



DESIGN BY:	ARM
DRAWN BY:	JRO
CHECKED BY:	ARM
APPROVED BY:	
DATE:	03/04/05
JOB No:	03297-02
IL PROJECT: IGQ-3329 A.I.P. PROJECT: 3-17-0121-B21	
SHEET 36 OF 50 SHEETS	



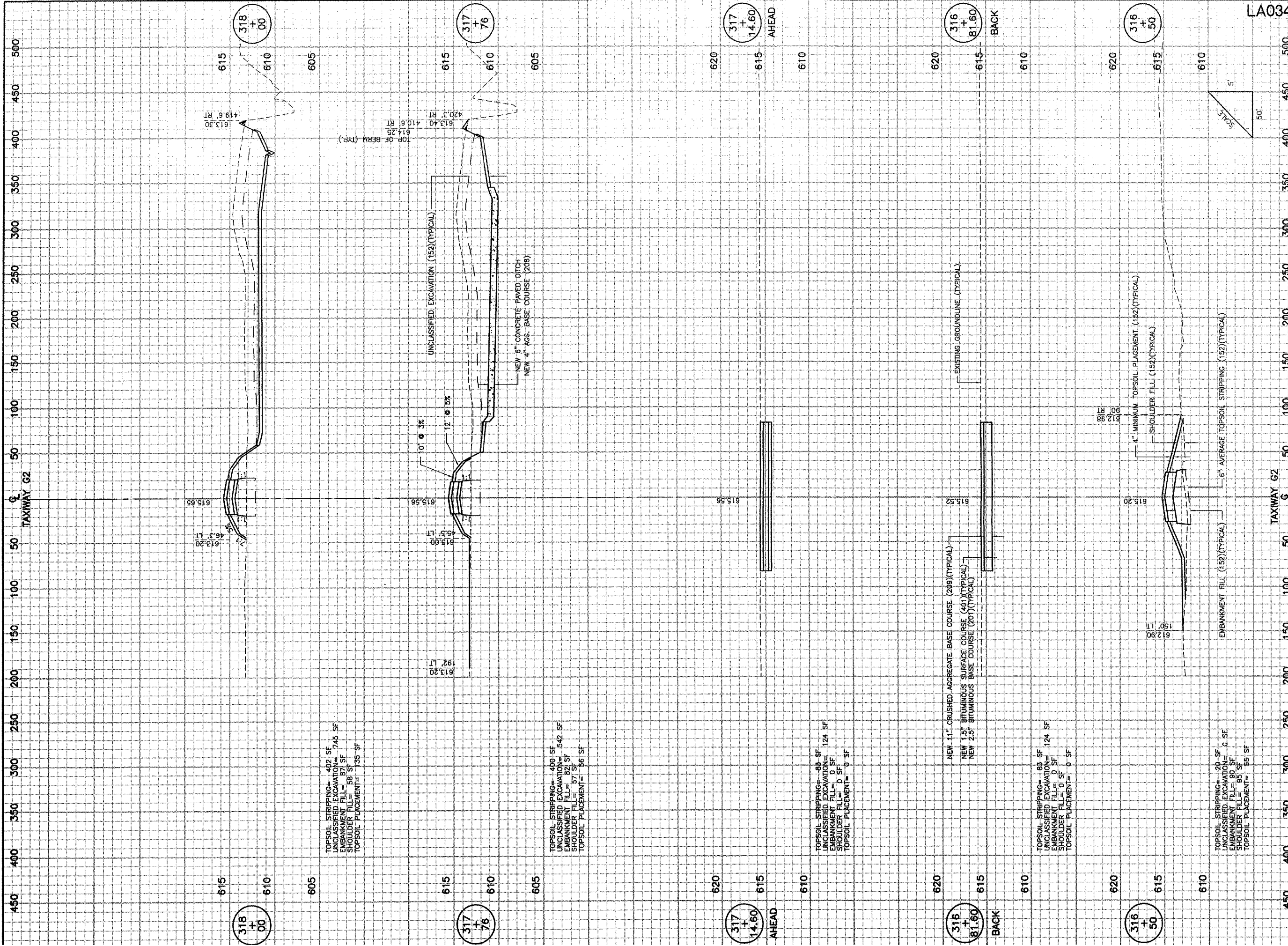

LA034

PATH: K:\LansingAp\0329702\draw\sheet  
 FILE: xsec.dwg  
 UPDATE BY: johse  
 SURVEY BOOK #  
 XREF DWG:  
 XREF DWG:  
 DATE: Tue 5/4/04 8:47am

REVISIONS		
NUMBER	BY	DATE

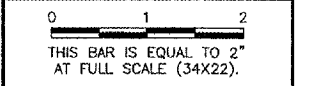

**LANSING MUNICIPAL AIRPORT**  
**LANSING, ILLINOIS**  
**NORTH QUADRANT SITEWORK - PHASE 1**  
**AND TAXIWAY G2 EXTENSION**  
**STA. 316+50 TO STA. 318+00**

© Copyright CMT, Inc.



**CMT**  
 CRAWFORD, MURPHY & TILLY, INC.  
 CONSULTING ENGINEERS  
 License No. 084-000613



DESIGN BY:	ARM
DRAWN BY:	JRO
CHECKED BY:	ARM
APPROVED BY:	
DATE:	03/04/05
JOB No:	03297-02

IL PROJECT: 16Q-3329  
 A.I.P. PROJECT: 3-17-0121-B21  
 SHEET 37 OF 50 SHEETS

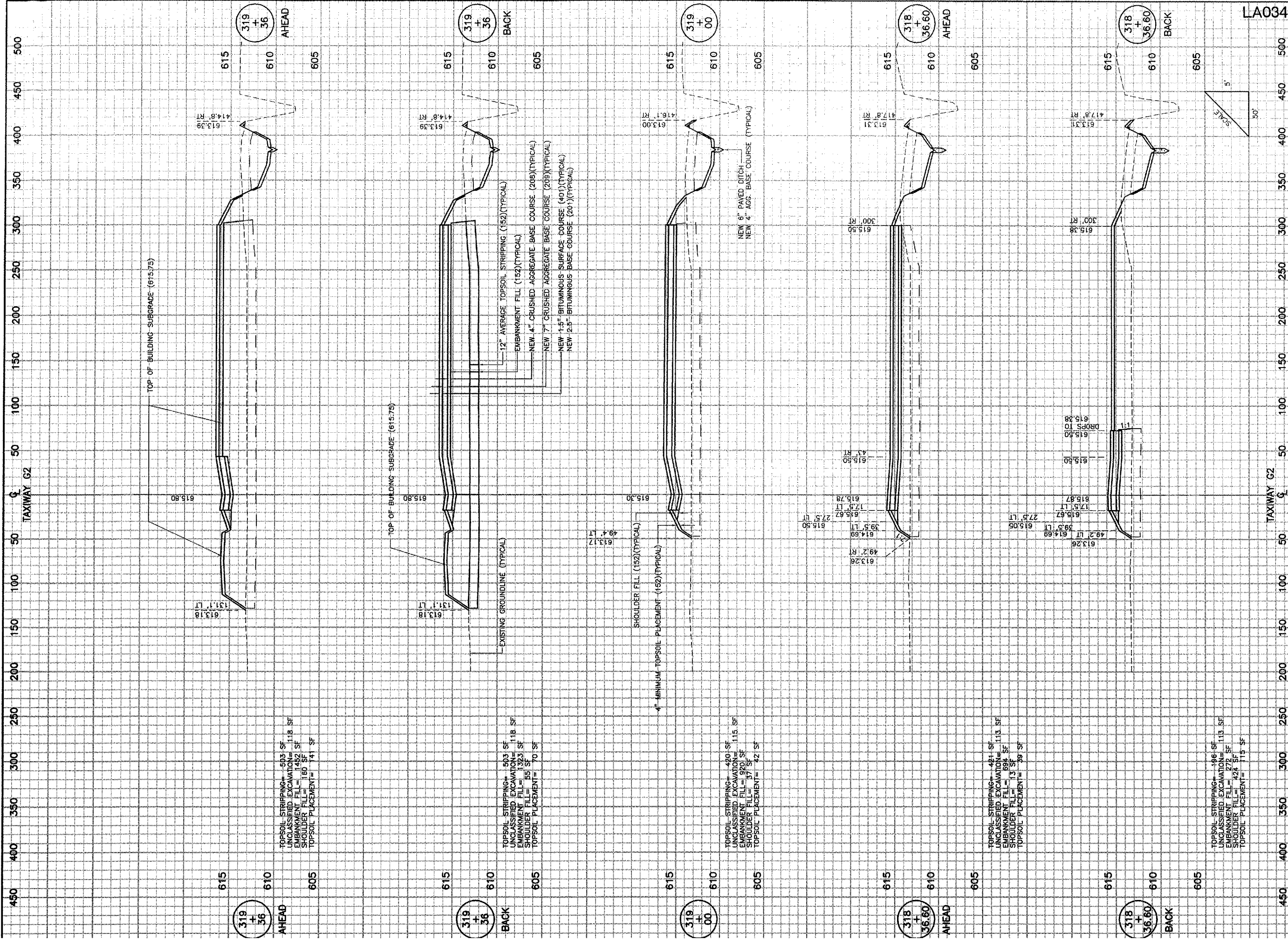

LA034

PATH: K:\LansingAp\0329702\draw\sheet  
 FILE: xsec.dwg  
 UPDATE BY: johse  
 SURVEY BOOK #  
 XREF DWG:  
 XREF DWG:  
 DATE: Tue 5/4/04 8:48am

REVISIONS		
NUMBER	BY	DATE

0 1 2  
 THIS BAR IS EQUAL TO 2"  
 AT FULL SCALE (34X22).

LANSING MUNICIPAL AIRPORT  
 LANSING, ILLINOIS  
 NORTH QUADRANT SITEWORK - PHASE 1  
 AND TAXIWAY G2 EXTENSION  
 STA. 318+36.60 TO STA. 319+36

© Copyright CMT, Inc.

**CMT**  
 CRAWFORD, MURPHY & TILLY, INC.  
 CONSULTING ENGINEERS  
 License No. 184-000693

Lansing Municipal  
**airport**

DESIGN BY:	ARM
DRAWN BY:	JRO
CHECKED BY:	ARM
APPROVED BY:	
DATE:	03/04/05
JOB No:	03297-02
IL PROJECT:	IGQ-3329
A.I.P. PROJECT:	3-17-0121-B21

SHEET 38 OF 50 SHEETS



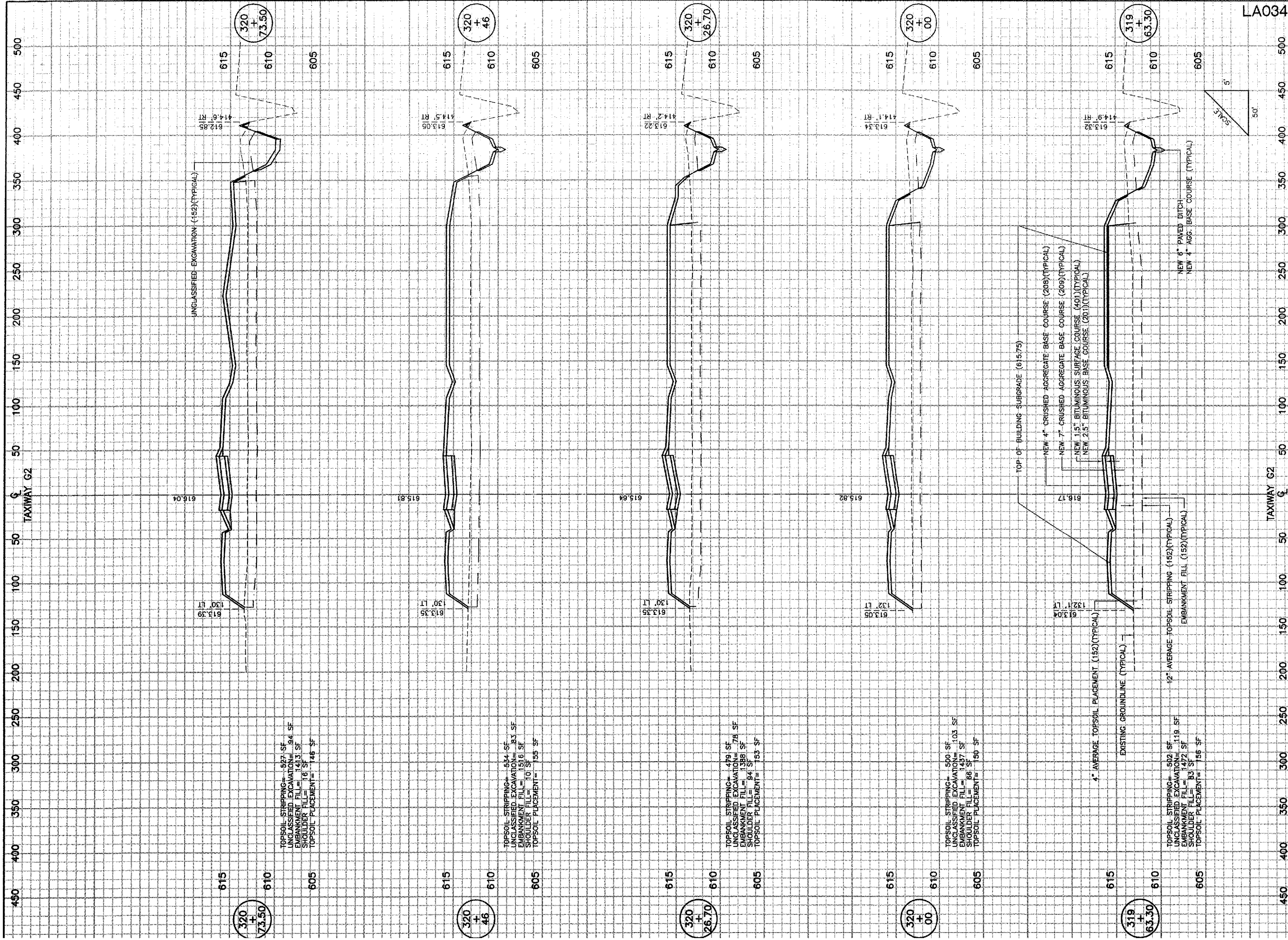

LA034

PATH: K:\LansingAp\0329702\draw\sheet  
 FILE: xsec.dwg  
 UPDATE BY: johse  
 SURVEY BOOK #  
 XREF DWG:  
 XREF DWG:  
 DATE: Tue 5/4/04 8:49am

REVISIONS		
NUMBER	BY	DATE

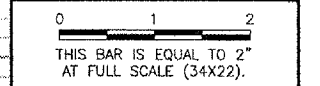

**LANSING MUNICIPAL AIRPORT**  
**LANSING, ILLINOIS**  
**NORTH QUADRANT SITWORK - PHASE 1**  
**AND TAXIWAY G2 EXTENSION**  
**STA. 319+63.30 TO STA. 320+73.50**

© Copyright CMT, Inc.



**CMT**  
 CRAWFORD MURPHY & TILLY, INC.  
 CONSULTING ENGINEERS  
 License No. 184-000618



DESIGN BY:	ARM
DRAWN BY:	JRO
CHECKED BY:	ARM
APPROVED BY:	
DATE:	03/04/05
JOB No:	03297-02
IL PROJECT: IGQ-3329 A.I.P. PROJECT: 3-17-0121-B21	
SHEET 39 OF 50 SHEETS	

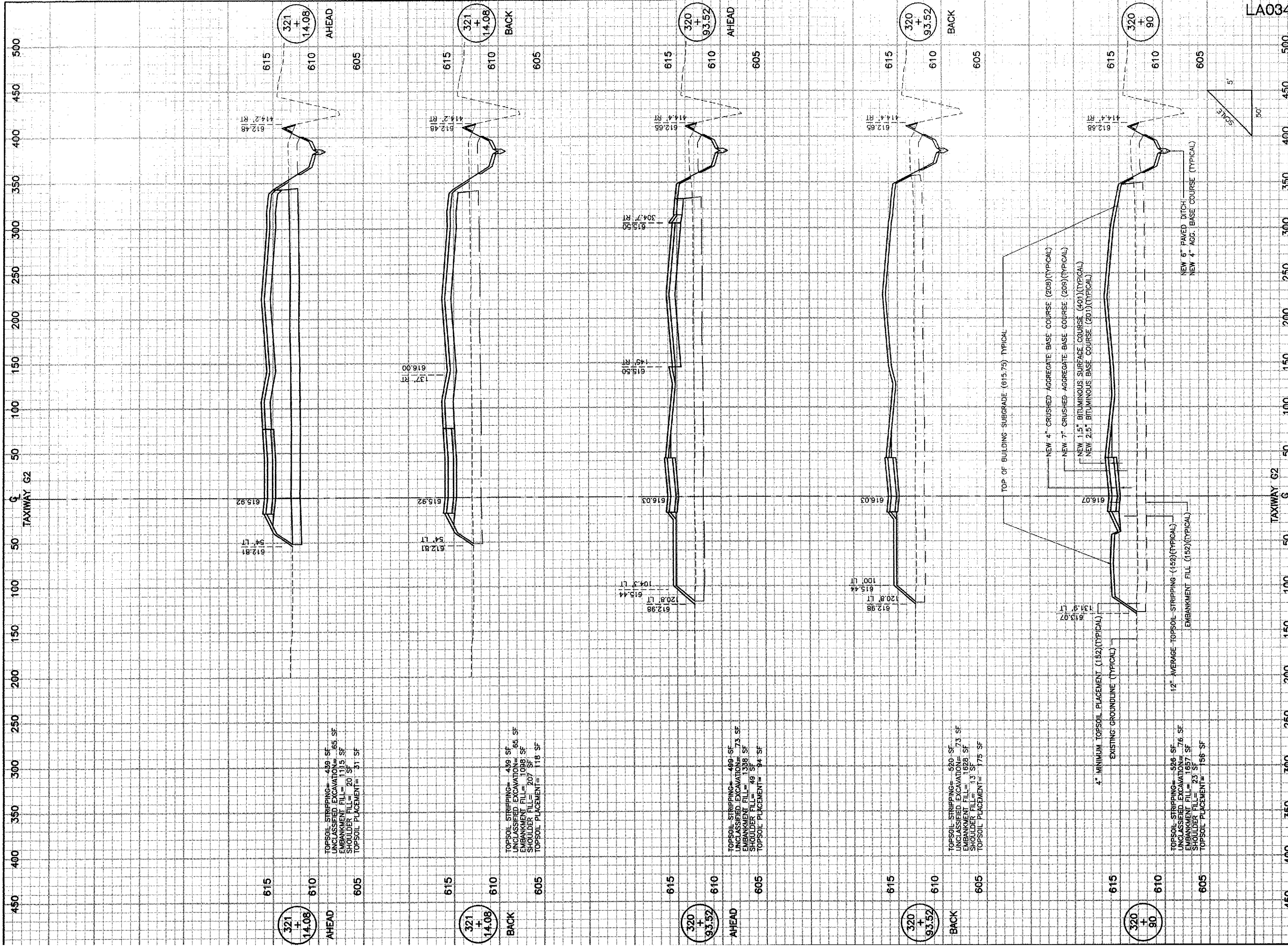

TOPSOIL STRIPPING= 499 SF  
 UNCLASSIFIED EXCAVATION= 65 SF  
 EMBANKMENT FILL= 111.5 SF  
 SHOULDER FILL= 20 SF  
 TOPSOIL PLACEMENT= 31 SF

TOPSOIL STRIPPING= 499 SF  
 UNCLASSIFIED EXCAVATION= 65 SF  
 EMBANKMENT FILL= 1098 SF  
 SHOULDER FILL= 207 SF  
 TOPSOIL PLACEMENT= 118 SF

TOPSOIL STRIPPING= 499 SF  
 UNCLASSIFIED EXCAVATION= 73 SF  
 EMBANKMENT FILL= 1398 SF  
 SHOULDER FILL= 49 SF  
 TOPSOIL PLACEMENT= 94 SF

TOPSOIL STRIPPING= 590 SF  
 UNCLASSIFIED EXCAVATION= 73 SF  
 EMBANKMENT FILL= 1828 SF  
 SHOULDER FILL= 13 SF  
 TOPSOIL PLACEMENT= 175 SF

TOPSOIL STRIPPING= 568 SF  
 UNCLASSIFIED EXCAVATION= 76 SF  
 EMBANKMENT FILL= 1397 SF  
 SHOULDER FILL= 23 SF  
 TOPSOIL PLACEMENT= 156 SF

LA034

PATH: K:\LansingAp\0329702\draw\sheet  
 FILE: xsec.dwg  
 UPDATE BY: johse  
 SURVEY BOOK #  
 XREF DWG:  
 XREF DWG:  
 DATE: Tue 5/4/04 8:52am

REVISIONS		
NUMBER	BY	DATE

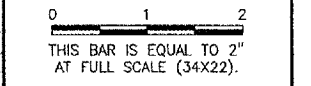

**LANSING MUNICIPAL AIRPORT**  
**LANSING, ILLINOIS**  
**NORTH QUADRANT SITEWORK - PHASE 1**  
**AND TAXIWAY G2 EXTENSION**  
**STA. 320+90 TO STA. 321+14.08**

© Copyright CMT, Inc.

**CMT**  
 CRAWFORD, MURPHY & TILLY, INC.  
 CONSULTING ENGINEERS  
 License No. 84-000613

DESIGN BY:	ARM
DRAWN BY:	JRO
CHECKED BY:	ARM
APPROVED BY:	
DATE:	03/04/05
JOB No:	03297-02
IL PROJECT: IGQ-3329 A.I.P. PROJECT: 3-17-0121-B21	
SHEET 40 OF 50 SHEETS	



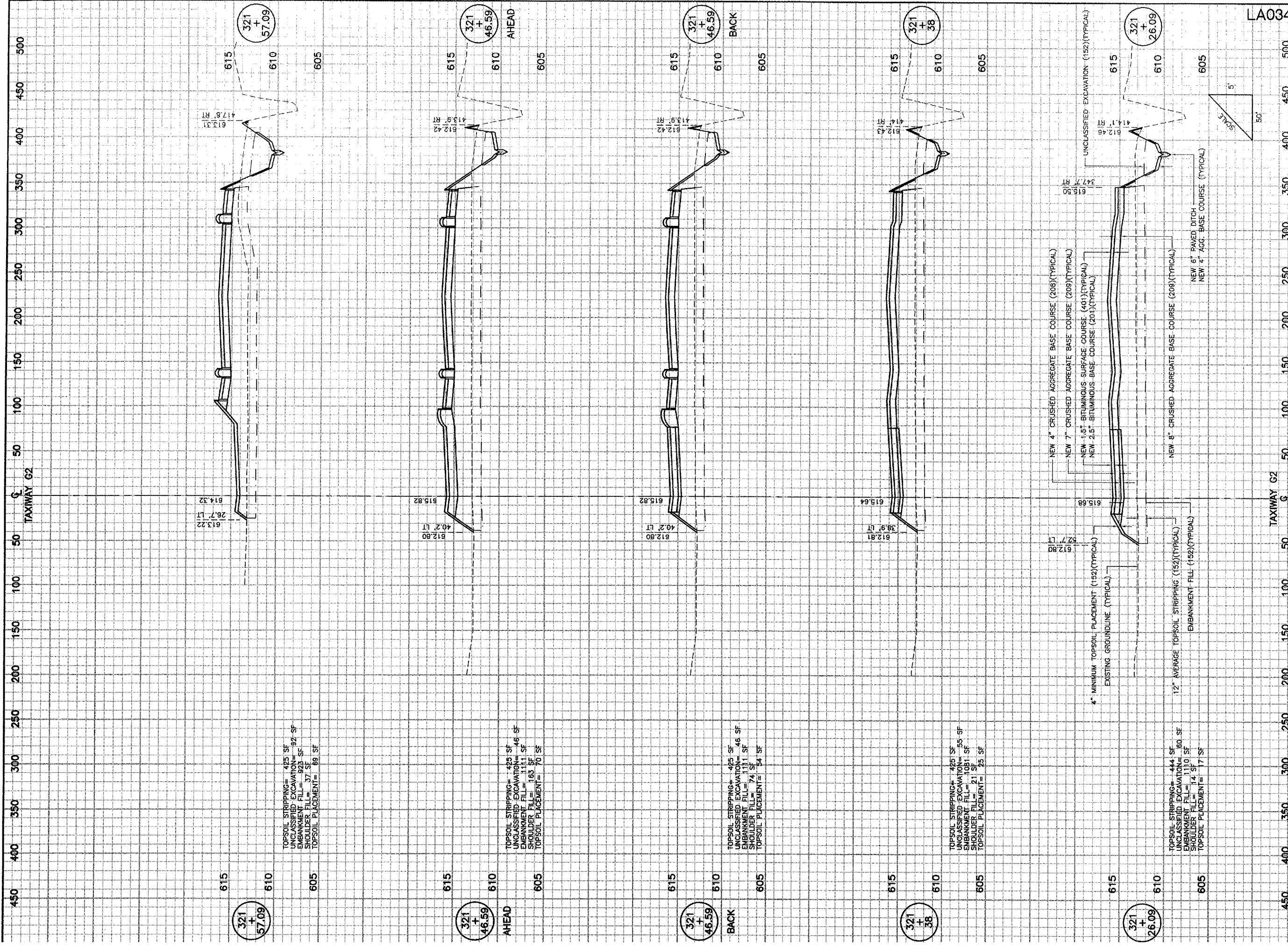

LA034

PATH: K:\LansingAp\0329702\draw\stee  
 FILE: xsec.dwg  
 UPDATE BY: johse  
 SURVEY BOOK #  
 XREF DWG:  
 XREF DWG:  
 DATE: Tue 5/4/04 8:53am

REVISIONS		
NUMBER	BY	DATE

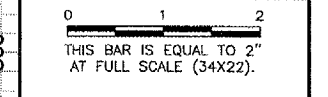

**LANSING MUNICIPAL AIRPORT**  
**LANSING, ILLINOIS**  
**NORTH QUADRANT SITEWORK - PHASE 1**  
**AND TAXIWAY G2 EXTENSION**  
**STA. 321+26.09 TO STA. 321+57.09**

© copyright CMT, Inc.



**CMT**  
 CRAWFORD, MURPHY & TILLY, INC.  
 CONSULTING ENGINEERS  
 License No. 184-000613



DESIGN BY:	ARM
DRAWN BY:	JRO
CHECKED BY:	ARM
APPROVED BY:	
DATE:	03/04/05
JOB No:	03297-02
IL PROJECT:	IGQ-3329
A.I.P. PROJECT:	3-17-0121-B21
SHEET	41 OF 50 SHEETS

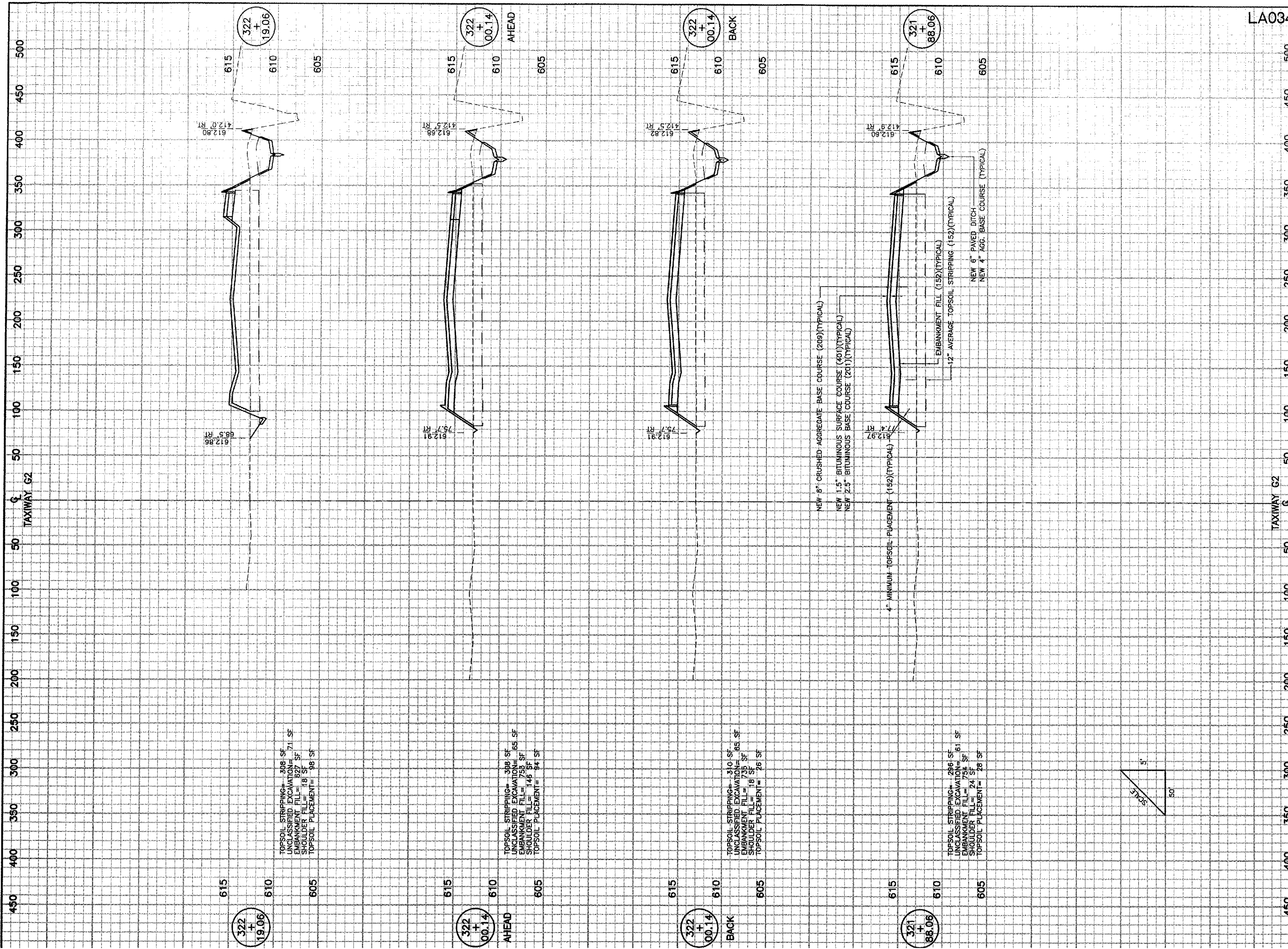

LA034

PATH: K:\LansingAp\0329702\draw\sheet  
 FILE: xsec.dwg  
 UPDATE BY: johse  
 SURVEY BOOK #  
 XREF DWG:  
 DATE: Tue 5/4/04 8:54am

REVISIONS		
NUMBER	BY	DATE

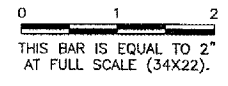

**LANSING MUNICIPAL AIRPORT**  
**LANSING, ILLINOIS**  
**NORTH QUADRANT SITEWORK - PHASE 1**  
**AND TAXIWAY G2 EXTENSION**  
**CROSS SECTIONS**  
**STA. 321+88.06 TO STA. 322+19.06**

© Copyright GMT, Inc.

**GMT**  
 CRAWFORD, MURPHY & TILLY, INC.  
 CONSULTING ENGINEERS  
 License No. 184-000513

DESIGN BY:	ARM
DRAWN BY:	JRO
CHECKED BY:	
APPROVED BY:	
DATE:	03/04/05
JOB No:	03297-02

IL PROJECT: IGO-3329  
 A.I.P. PROJECT: 3-17-0121-B21



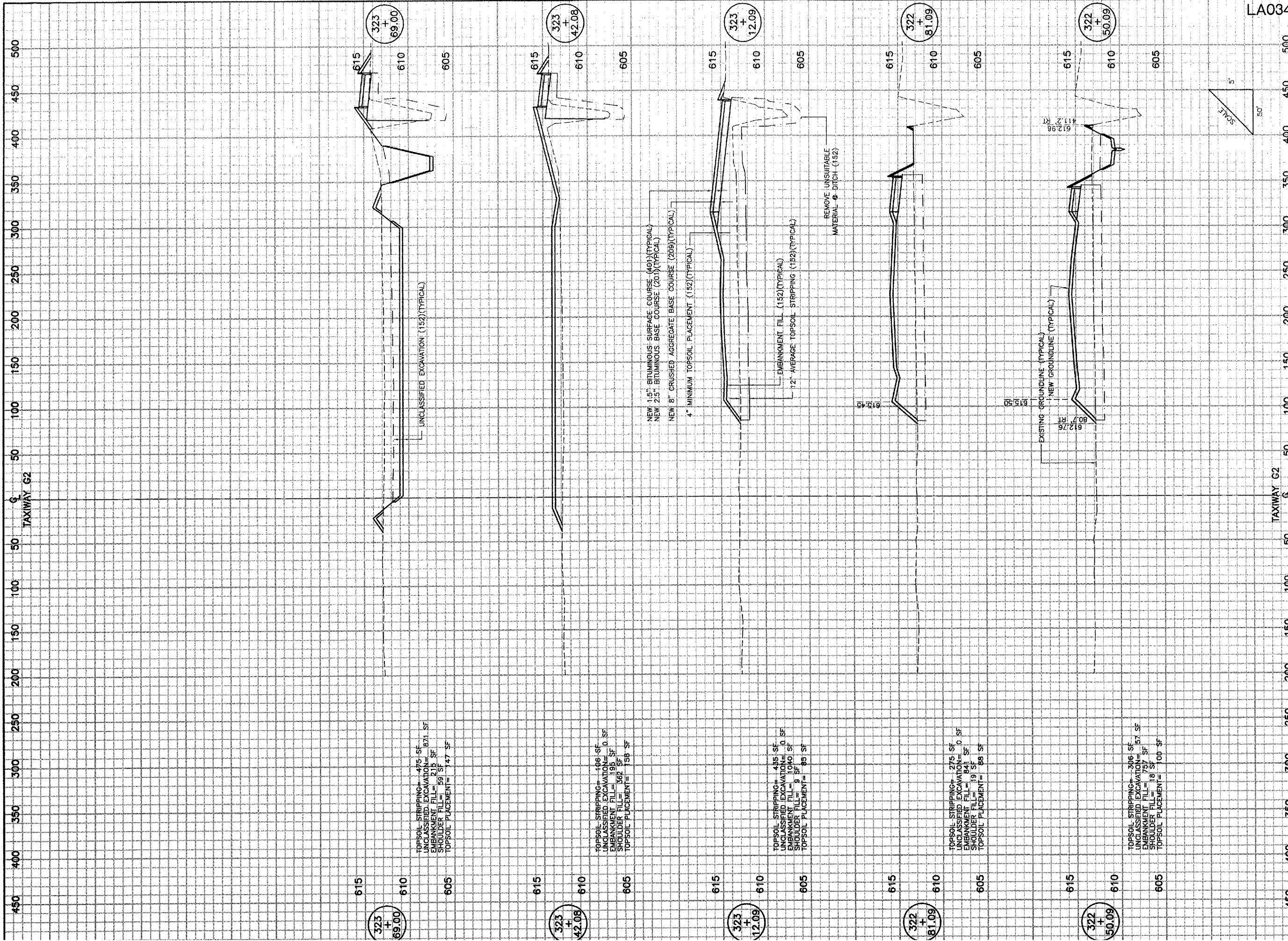

LA034

PATH: K:\LansingAp\0329702\draw\sheet  
 FILE: xsec.dwg  
 UPDATE BY: johse  
 SURVEY BOOK #  
 XREF DWG:  
 XREF DWG:  
 DATE: Tue 5/4/04 8:58am

REVISIONS		
NUMBER	BY	DATE

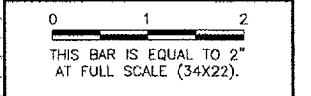

**LANSING MUNICIPAL AIRPORT**  
**LANSING, ILLINOIS**  
**NORTH QUADRANT SITEWORK - PHASE 1**  
**AND TAXIWAY G2 EXTENSION**  
**STA. 322+50.09 TO STA. 323+69.00**

© Copyright CMT, Inc.



**CMT**  
 CRAWFORD, MURPHY & TILLY, INC.  
 CONSULTING ENGINEERS  
 License No. 184-000613



DESIGN BY:	ARM
DRAWN BY:	JRO
CHECKED BY:	
APPROVED BY:	
DATE:	03/04/05
JOB No:	03297-02
IL PROJECT: IGQ-3329 A.I.P. PROJECT: 3-17-0121-B21	
SHEET 43 OF 50 SHEETS	

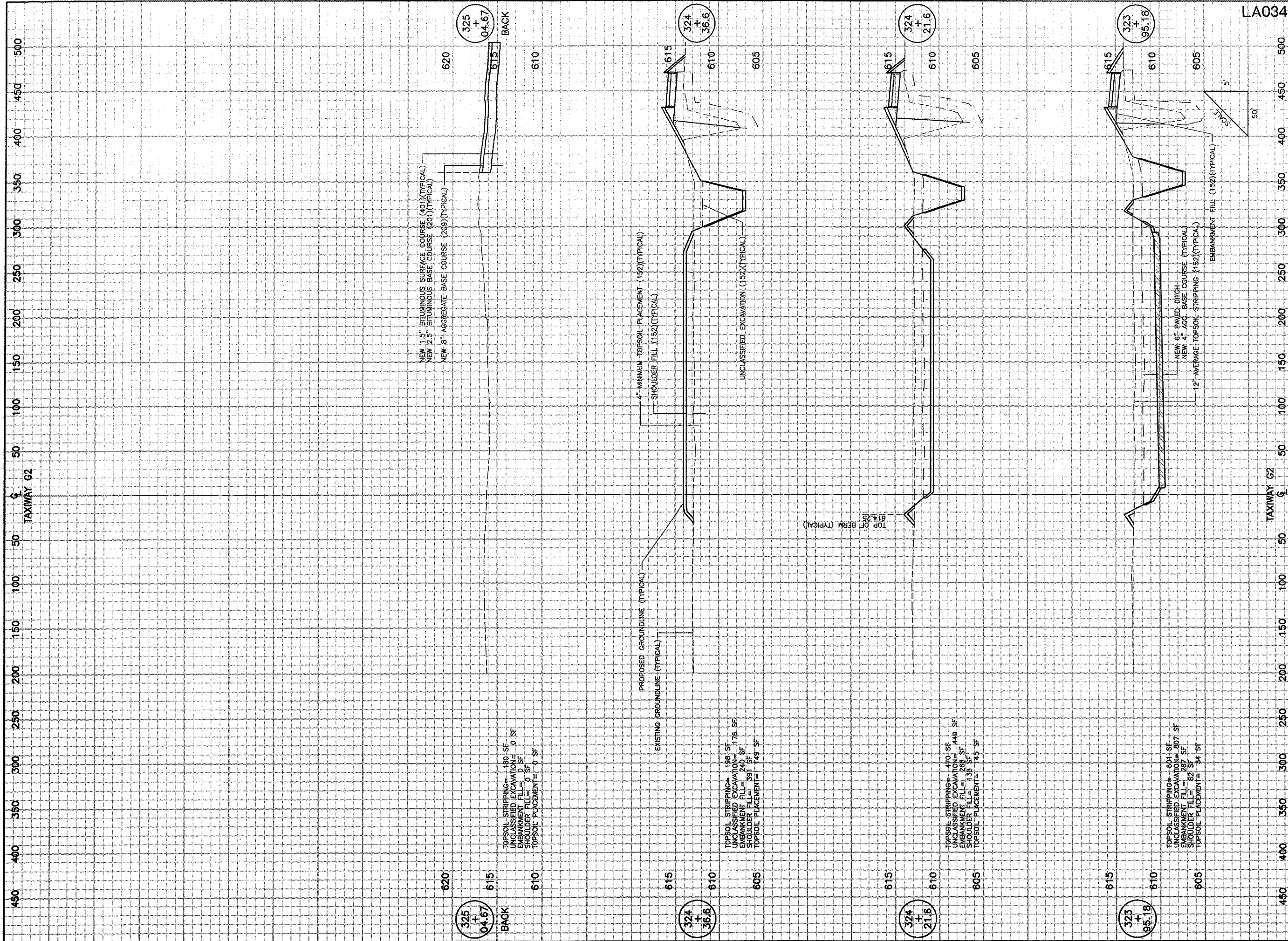

LA034  
 PATH: K:\LansingAp\0329702\draw\sheet  
 FILE: xsec.dwg  
 UPDATE BY: johse  
 SURVEY BOOK #  
 XREF DWG:  
 XREF DWG:  
 DATE: Tue 5/4/04 9:00am

REVISIONS		
NUMBER	BY	DATE

0 1 2  
 THIS BAR IS EQUAL TO 2"  
 AT FULL SCALE (34X22).





LANSING MUNICIPAL AIRPORT  
 LANSING, ILLINOIS  
 NORTH QUADRANT SITEWORK - PHASE 1  
 AND TAXIWAY G2 EXTENSION  
 STA. 323+95.18 TO STA. 325+04.67

© Copyright CMT, Inc.  
**CMT**  
 CRAWFORD, MURPHY & TILLY, INC.  
 CONSULTING ENGINEERS  
 License No. 164-00675

DESIGN BY:	ARM
DRAWN BY:	JRO
CHECKED BY:	
APPROVED BY:	
DATE:	03/04/05
JOB No:	03297-02
IL PROJECT:	IGQ-3329
A.I.P. PROJECT:	3-17-0121-B21
SHEET	44 OF 50 SHEETS



**LEGEND**

-  NEW PAVEMENT
-  FUTURE HANGAR
-  FUTURE PAVEMENT
-  PROPOSED SOIL BORING

**GEOTECHNICAL LAYOUT TABLE**

BORING/CORE NO.	STATION	OFFSET RUNWAY C	DEPTH	ELEVATION
B1	315+75 TXY G2	CL	10'	610.83
B2	319+00 TXY G2	CL	10'	613.18
B3	19+00 TXY A	310' LT.	10'	613.19
B4	24+80 TXY A	310' LT.	10'	613.18
B5	20+10 TXY A	515' LT.	10'	613.03
B6	23+00 TXY A	600' LT.	10'	612.95
B7	18+50 TXY A	710' LT.	10'	612.94
B8	319+00 TXY G2	600' RT.	10'	612.99
B9	322+50 TXY G2	810' RT.	10'	613.29

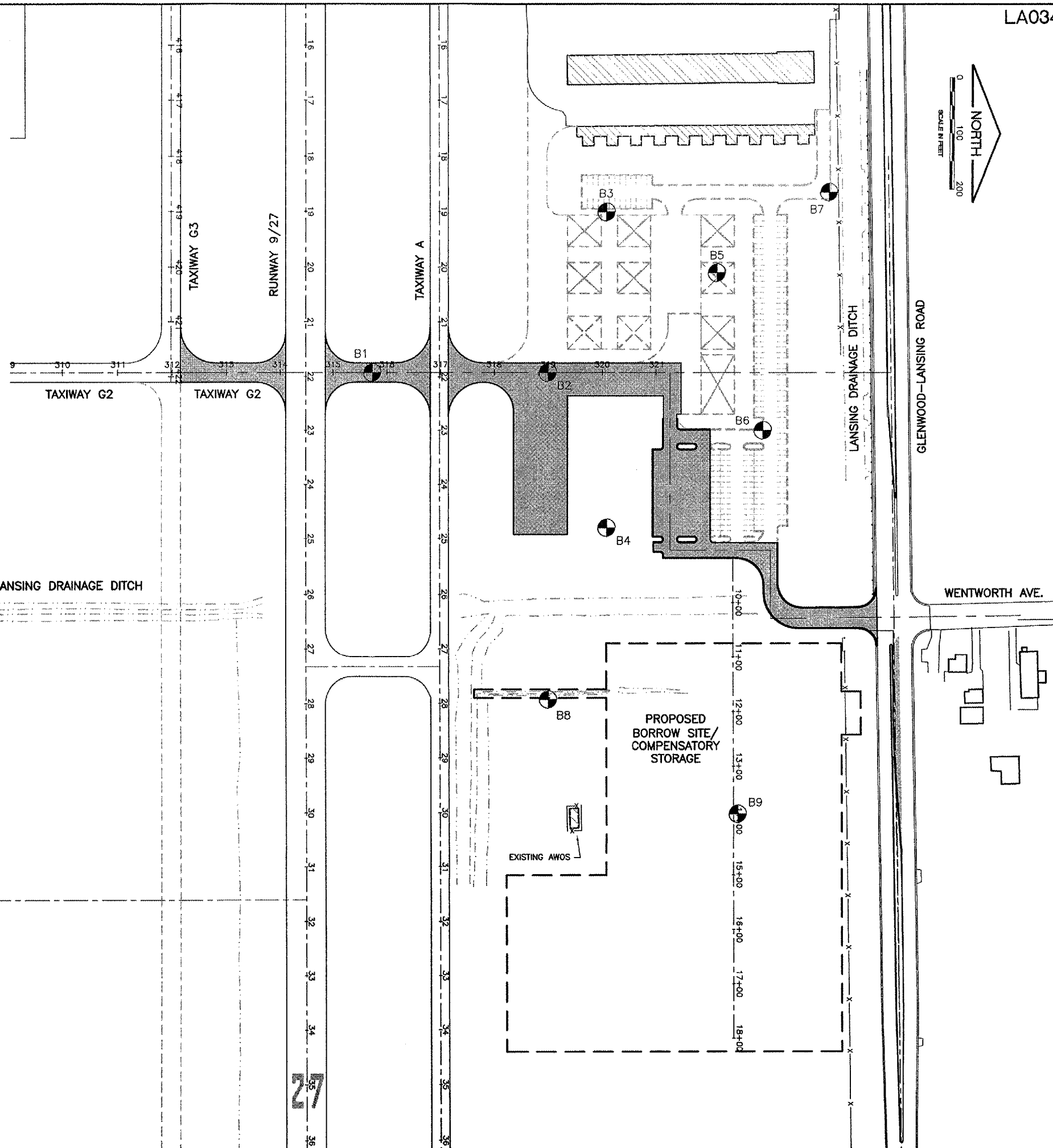

LA034

PATH: K:\0329702\sheet\  
 FILE: enginfo.dwg  
 UPDATE BY: Johse  
 SURVEY BOOK #  
 XREF DWG:  
 XREF DWG:  
 DATE: Fri 3/26/04 2:18pm

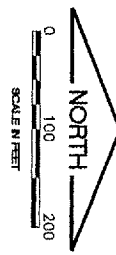

REVISIONS

NUMBER	BY	DATE

0 1 2  
 THIS BAR IS EQUAL TO 2"  
 AT FULL SCALE (34X22).

PROJECT Lansing Municipal Airport, N. Quadrant Hangar Development, Lansing, IL  
 CLIENT Crawford, Murphy & Tilly, Inc., Aurora, Illinois  
 BORING 1 DATE STARTED 11-12-03 DATE COMPLETED 11-12-03 JOB L-59,265  
 ELEVATIONS GROUND SURFACE 610.8 WHILE DRILLING Dry  
 END OF BORING 600.8 AT END OF BORING Dry  
 WATER LEVEL OBSERVATIONS Dry  
 TSC

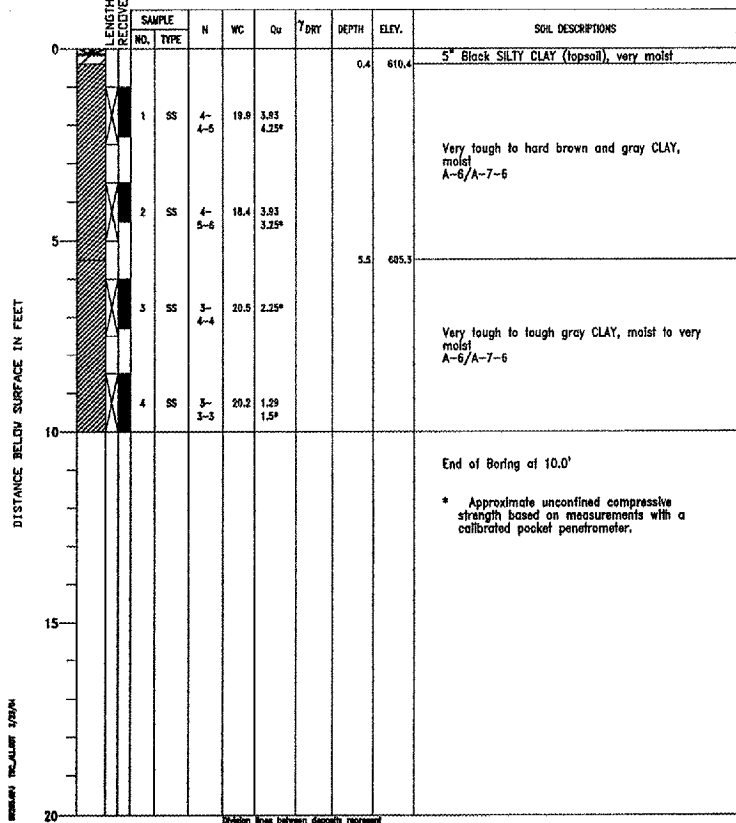

**LANSING MUNICIPAL AIRPORT  
 LANSING, ILLINOIS  
 NORTH QUADRANT SITEWORK - PHASE 1  
 AND TAXIWAY G2 EXTENSION  
 ENGINEERING INFORMATION - SHEET 1**

© Copyright GMT, Inc.  
**GMT**  
 CRAWFORD, MURPHY & TILLY, INC.  
 CONSULTING ENGINEERS  
 License No. 184-000613  

DESIGN BY:	ARM
DRAWN BY:	JRO
CHECKED BY:	ARM
APPROVED BY:	
DATE:	03/04/05
JOB No:	03297-02
IL PROJECT:	IGQ-3329
A.I.P. PROJECT:	3-17-0121-B21
SHEET	45 OF 50 SHEETS

PROJECT Lansing Municipal Airport, N. Quadrant Hangar Development, Lansing, IL  
 CLIENT Crawford, Murphy & Tilly, Inc., Aurora, Illinois  
 BORING 2 DATE STARTED 11-12-03 DATE COMPLETED 11-12-03 JOB L-59,265  
 ELEVATIONS  
 GROUND SURFACE 613.2  
 END OF BORING 603.2  
 WATER LEVEL OBSERVATIONS  
 WHILE DRILLING Dry  
 AT END OF BORING Dry  
 24 HOURS

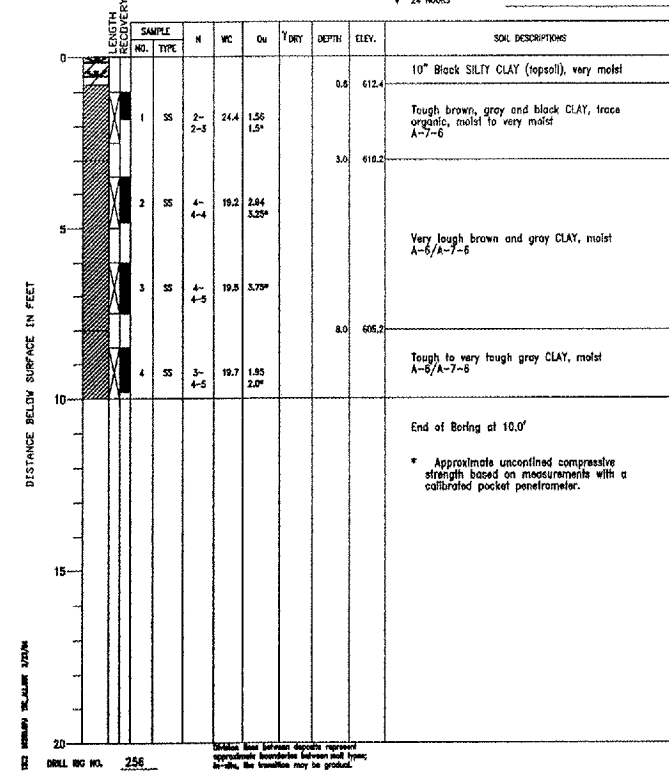

PROJECT Lansing Municipal Airport, N. Quadrant Hangar Development, Lansing, IL  
 CLIENT Crawford, Murphy & Tilly, Inc., Aurora, Illinois  
 BORING 3 DATE STARTED 11-12-03 DATE COMPLETED 11-12-03 JOB L-59,265  
 ELEVATIONS  
 GROUND SURFACE 613.2  
 END OF BORING 603.2  
 WATER LEVEL OBSERVATIONS  
 WHILE DRILLING Dry  
 AT END OF BORING Dry  
 24 HOURS

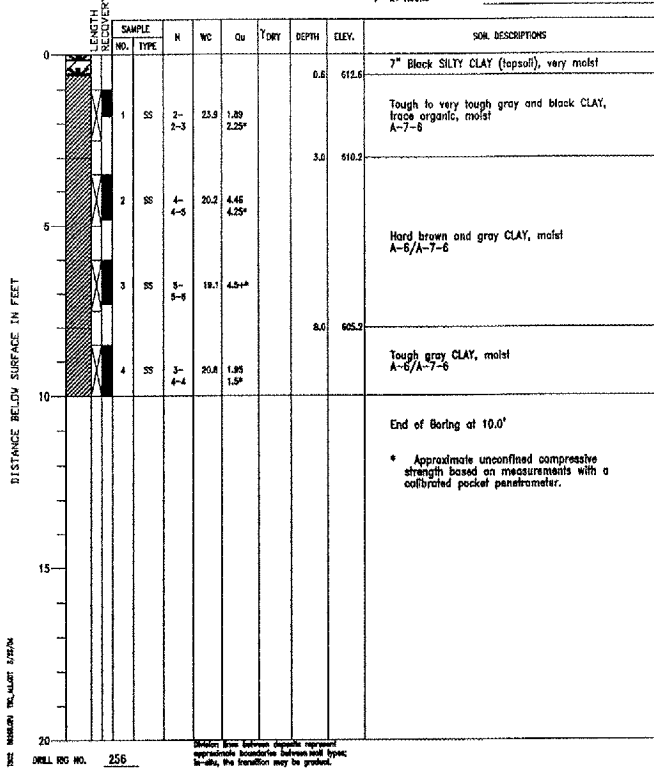

PROJECT Lansing Municipal Airport, N. Quadrant Hangar Development, Lansing, IL  
 CLIENT Crawford, Murphy & Tilly, Inc., Aurora, Illinois  
 BORING 4 DATE STARTED 11-12-03 DATE COMPLETED 11-12-03 JOB L-59,265  
 ELEVATIONS  
 GROUND SURFACE 613.2  
 END OF BORING 603.2  
 WATER LEVEL OBSERVATIONS  
 WHILE DRILLING Dry  
 AT END OF BORING Dry  
 24 HOURS

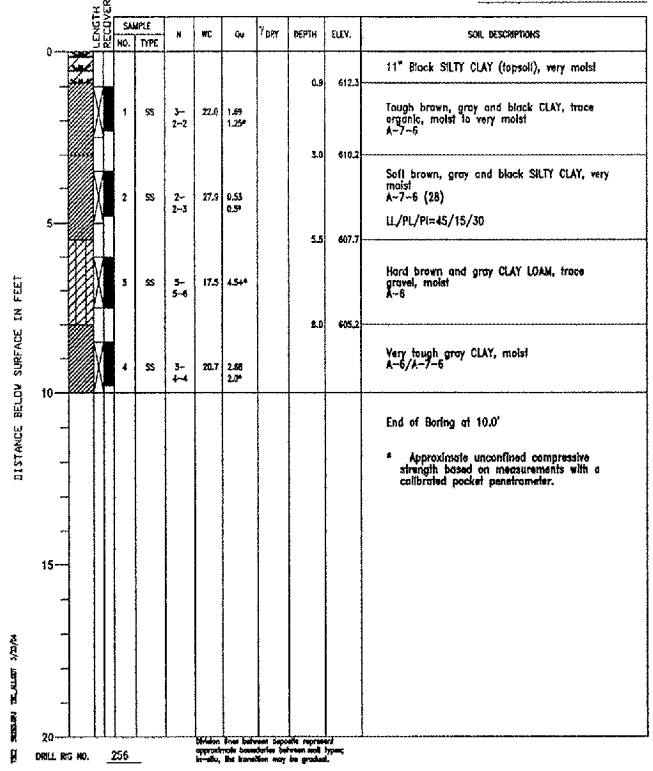

PROJECT Lansing Municipal Airport, N. Quadrant Hangar Development, Lansing, IL  
 CLIENT Crawford, Murphy & Tilly, Inc., Aurora, Illinois  
 BORING 5 DATE STARTED 11-12-03 DATE COMPLETED 11-12-03 JOB L-59,265  
 ELEVATIONS  
 GROUND SURFACE 613.0  
 END OF BORING 603.0  
 WATER LEVEL OBSERVATIONS  
 WHILE DRILLING Dry  
 AT END OF BORING Dry  
 24 HOURS

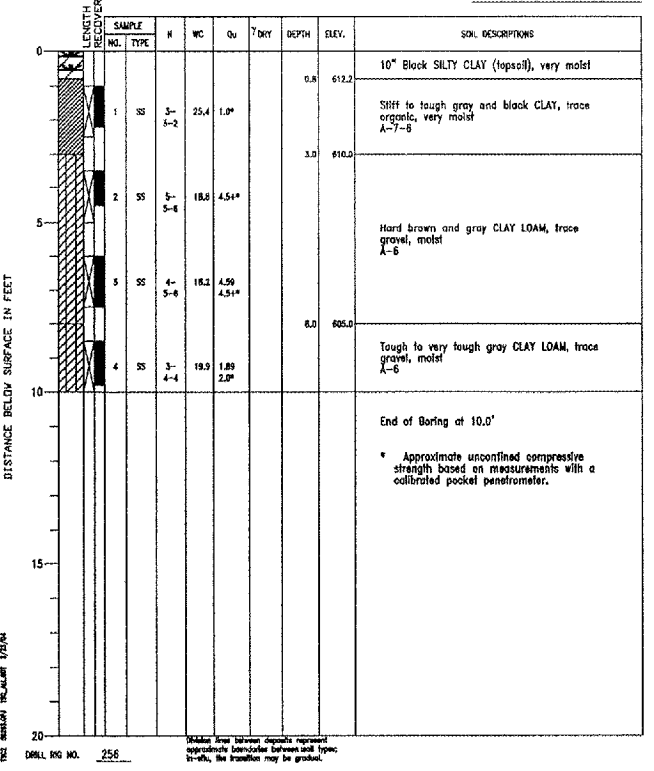

REVISIONS

NUMBER	BY	DATE

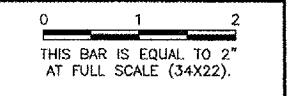

PROJECT Lansing Municipal Airport, N. Quadrant Hangar Development, Lansing, IL  
 CLIENT Crawford, Murphy & Tilly, Inc., Aurora, Illinois  
 BORING 6 DATE STARTED 11-12-03 DATE COMPLETED 11-12-03 JOB L-59,265  
 ELEVATIONS  
 GROUND SURFACE 613.0  
 END OF BORING 603.0  
 WATER LEVEL OBSERVATIONS  
 WHILE DRILLING Dry  
 AT END OF BORING Dry  
 24 HOURS

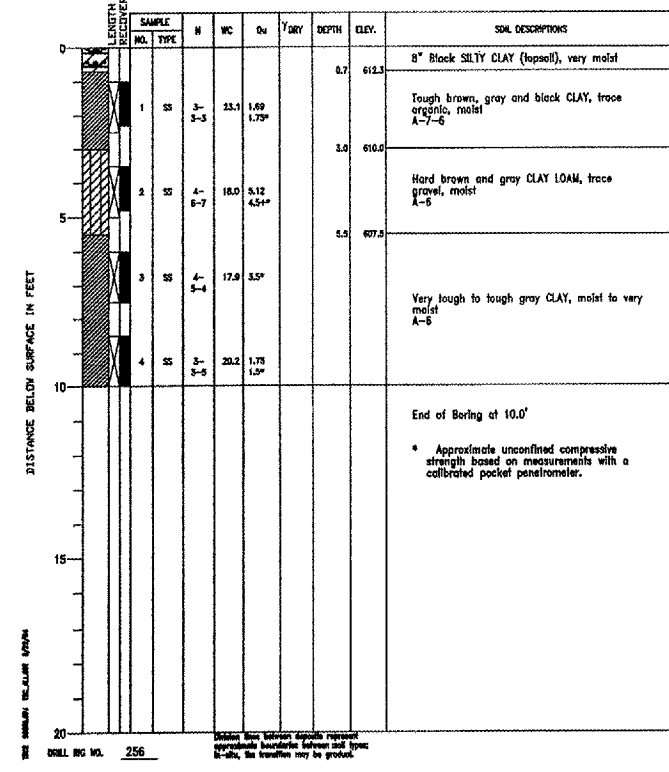

PROJECT Lansing Municipal Airport, N. Quadrant Hangar Development, Lansing, IL  
 CLIENT Crawford, Murphy & Tilly, Inc., Aurora, Illinois  
 BORING 7 DATE STARTED 11-12-03 DATE COMPLETED 11-12-03 JOB L-59,265  
 ELEVATIONS  
 GROUND SURFACE 612.9  
 END OF BORING 602.9  
 WATER LEVEL OBSERVATIONS  
 WHILE DRILLING Dry  
 AT END OF BORING Dry  
 24 HOURS

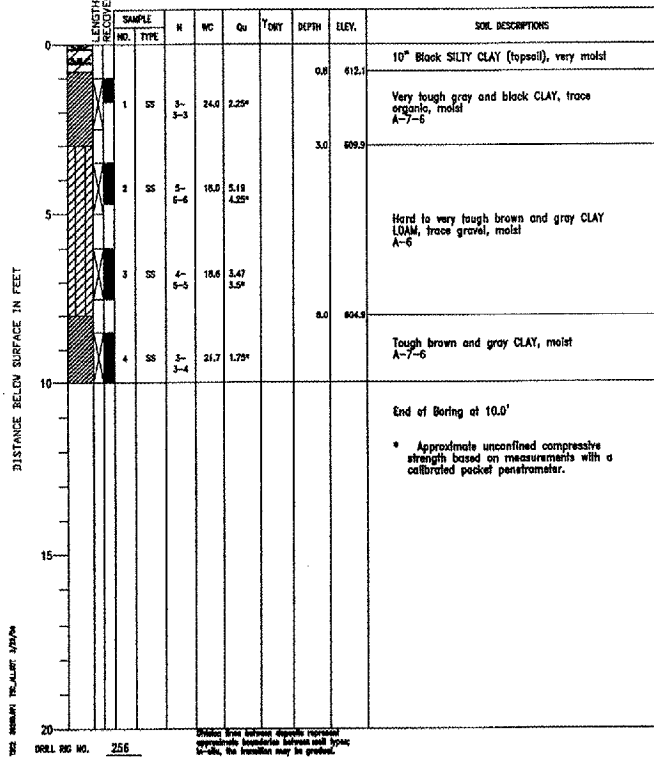

PROJECT Lansing Municipal Airport, N. Quadrant Hangar Development, Lansing, IL  
 CLIENT Crawford, Murphy & Tilly, Inc., Aurora, Illinois  
 BORING 8 DATE STARTED 11-12-03 DATE COMPLETED 11-12-03 JOB L-59,265  
 ELEVATIONS  
 GROUND SURFACE 613.0  
 END OF BORING 603.0  
 WATER LEVEL OBSERVATIONS  
 WHILE DRILLING Dry  
 AT END OF BORING Dry  
 24 HOURS

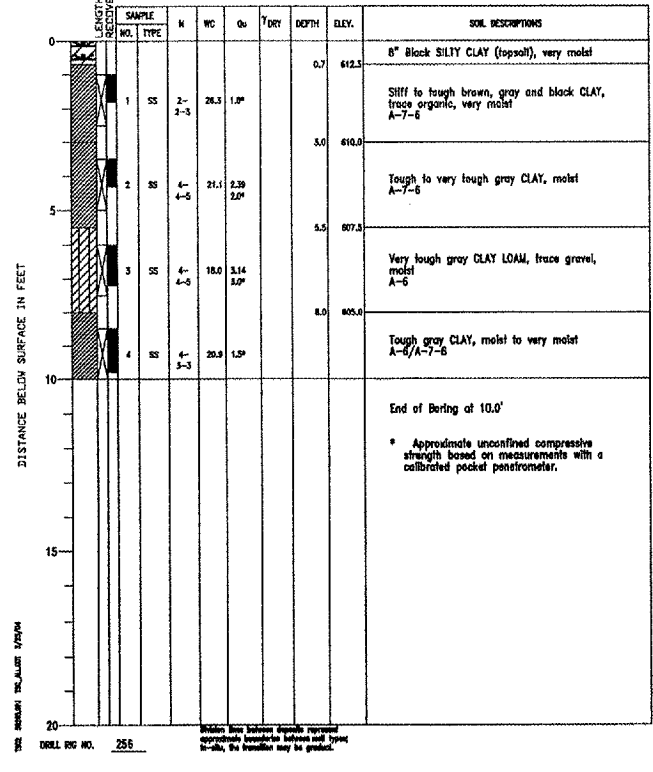

PROJECT Lansing Municipal Airport, N. Quadrant Hangar Development, Lansing, IL  
 CLIENT Crawford, Murphy & Tilly, Inc., Aurora, Illinois  
 BORING 9 DATE STARTED 11-12-03 DATE COMPLETED 11-12-03 JOB L-59,265  
 ELEVATIONS  
 GROUND SURFACE 613.0  
 END OF BORING 603.0  
 WATER LEVEL OBSERVATIONS  
 WHILE DRILLING Dry  
 AT END OF BORING Dry  
 24 HOURS

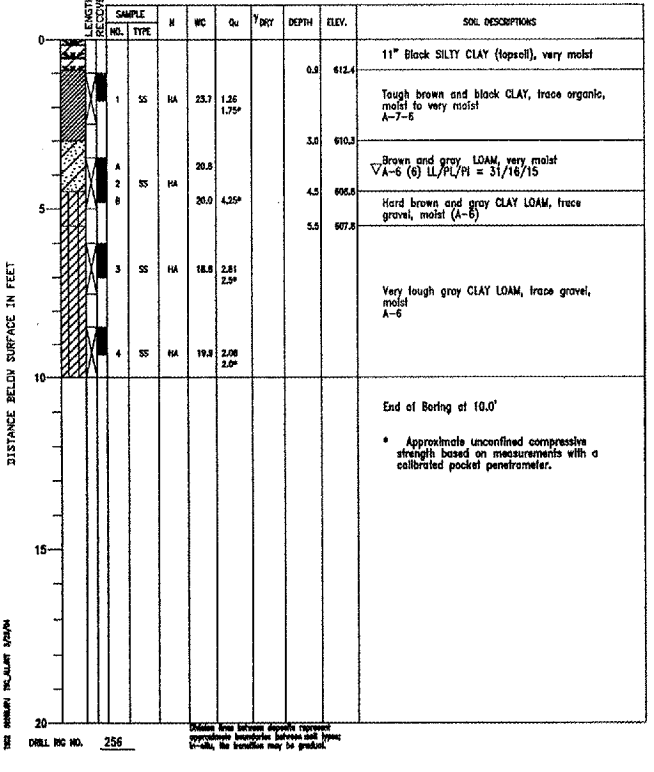

LANSING MUNICIPAL AIRPORT  
 LANSING, ILLINOIS  
 NORTH QUADRANT SITEWORK - PHASE 1  
 AND TAXIWAY G2 EXTENSION  
 ENGINEERING INFORMATION - SHEET 2

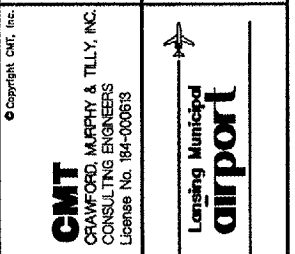

DESIGN BY: ARM  
 DRAWN BY: JRO  
 CHECKED BY: ARM  
 APPROVED BY:  
 DATE: 03/04/05  
 JOB No: 03297-02  
 IL PROJECT: IGQ-3329  
 A.I.P. PROJECT: 3-17-0121-B21

- NOTES**
- CONTRACTOR SHALL MAINTAIN INTERSECTION TRAFFIC WHEN POWER IS INTERRUPTED. (COST OF MAINTENANCE SHALL BE INCIDENTAL TO ITEMS 85000200 AND 89000100)
  - CONTRACTOR SHALL SAWCUT FULL DEPTH LIMITS OF ALL PROPOSED REMOVALS (COST INCIDENTAL TO THE RESPECTIVE PAY ITEM)
  - MATERIAL OBTAINED FROM REMOVAL OPERATIONS SHALL BE HAULED TO A DISPOSAL SITE OFF OF AIRPORT PROPERTY BY THE CONTRACTOR (COST INCIDENTAL TO RESPECTIVE PAY ITEM)

**REVISIONS**

NUMBER	BY	DATE

0 1 2  
 THIS BAR IS EQUAL TO 2" AT FULL SCALE (34X22).

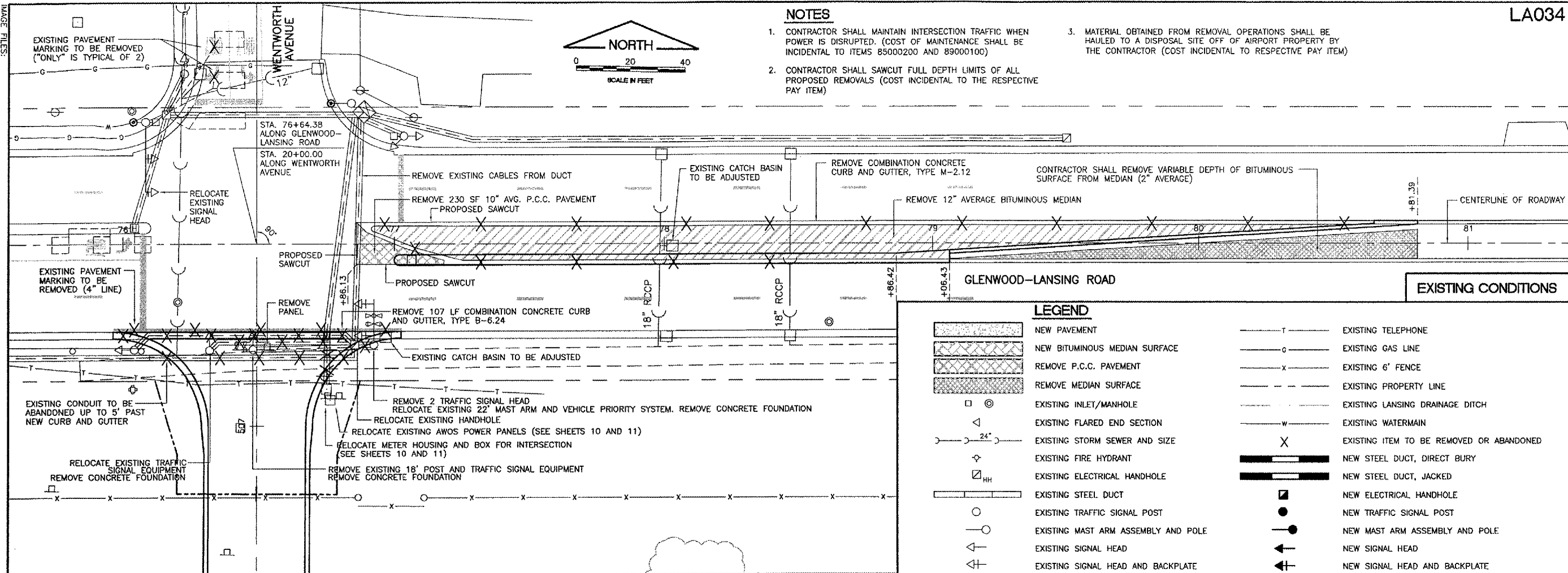

**LEGEND**

	NEW PAVEMENT		EXISTING TELEPHONE
	NEW BITUMINOUS MEDIAN SURFACE		EXISTING GAS LINE
	REMOVE P.C.C. PAVEMENT		EXISTING 6' FENCE
	REMOVE MEDIAN SURFACE		EXISTING PROPERTY LINE
	EXISTING INLET/MANHOLE		EXISTING LANSING DRAINAGE DITCH
	EXISTING FLARED END SECTION		EXISTING WATERMAIN
	EXISTING STORM SEWER AND SIZE		EXISTING ITEM TO BE REMOVED OR ABANDONED
	EXISTING FIRE HYDRANT		NEW STEEL DUCT, DIRECT BURY
	EXISTING ELECTRICAL HANDHOLE		NEW STEEL DUCT, JACKED
	EXISTING STEEL DUCT		NEW ELECTRICAL HANDHOLE
	EXISTING TRAFFIC SIGNAL POST		NEW TRAFFIC SIGNAL POST
	EXISTING MAST ARM ASSEMBLY AND POLE		NEW MAST ARM ASSEMBLY AND POLE
	EXISTING SIGNAL HEAD		NEW SIGNAL HEAD
	EXISTING SIGNAL HEAD AND BACKPLATE		NEW SIGNAL HEAD AND BACKPLATE
	EXISTING CONFIRMATION BEACON		NEW CONFIRMATION BEACON
	EXISTING EMERGENCY VEHICLE SYSTEM LIGHT DETECTOR		NEW EMERGENCY VEHICLE SYSTEM LIGHT DETECTOR
	EXISTING INTERSECTION CONTROLLER CABINET		NEW ELEVATION (616.30)
	EXISTING UNDERGROUND COMED ELECTRIC LINE		EXISTING ELEVATION (616.22)
	EXISTING OVERHEAD COMED ELECTRIC LINE		OVERLAN FLOW DIRECTION
	EXISTING COMED UTILITY POLE		

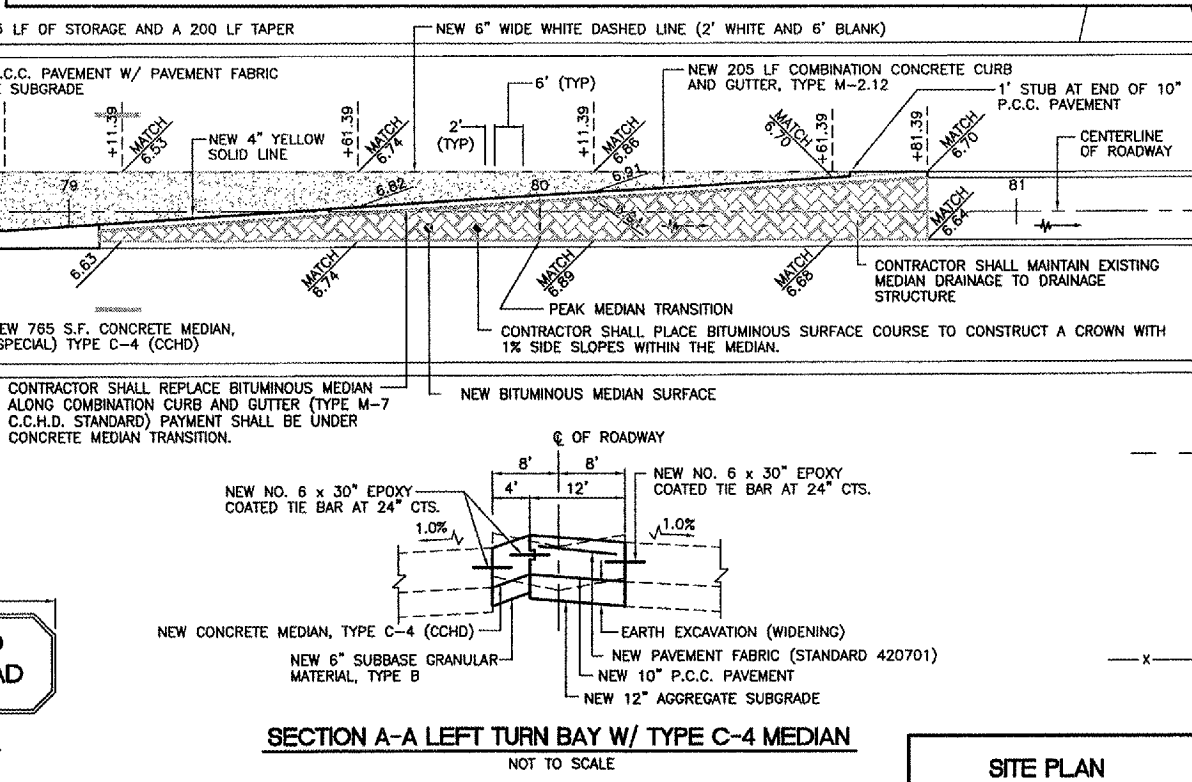
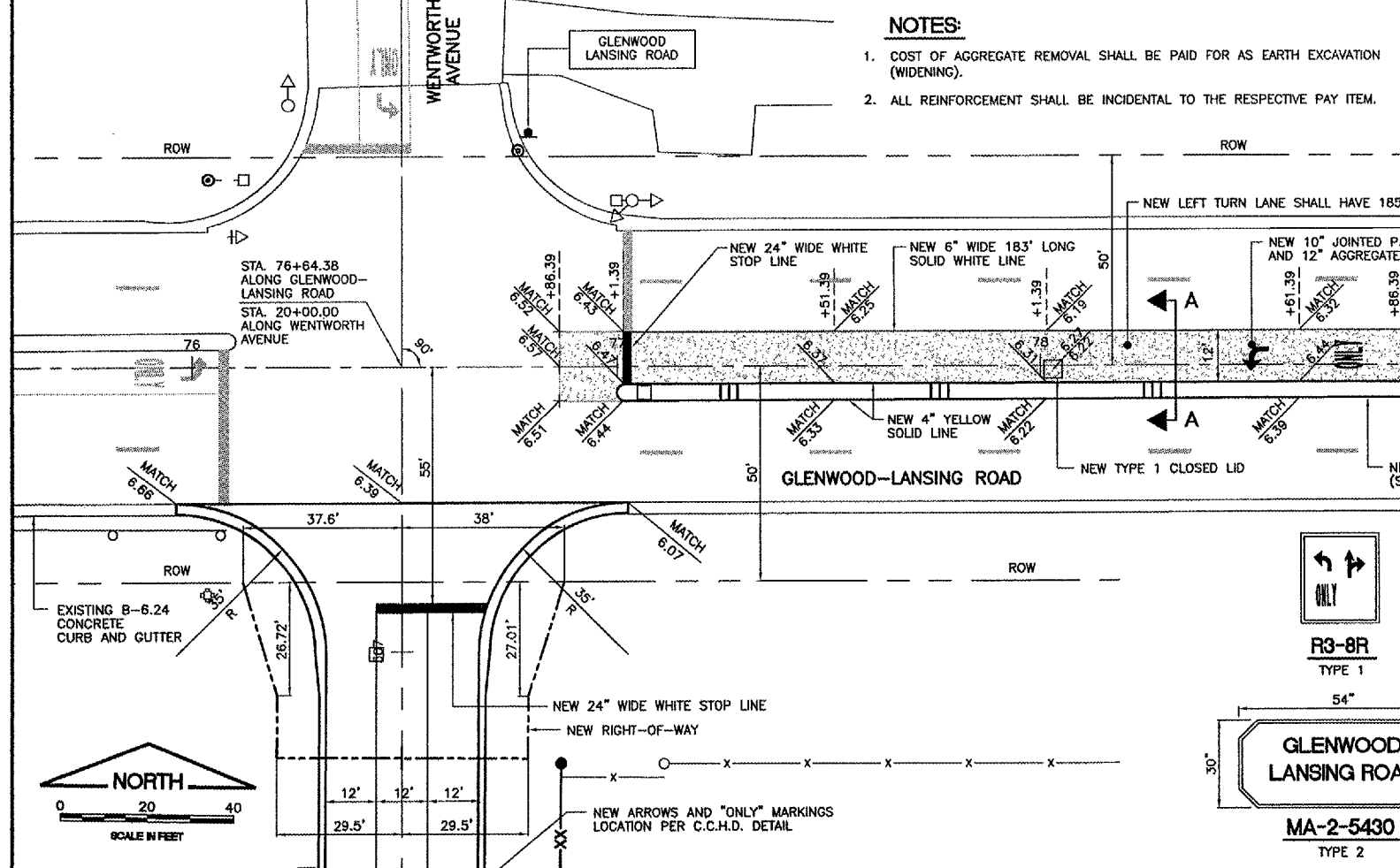

**LANSING MUNICIPAL AIRPORT**  
**LANSING, ILLINOIS**  
**NORTH QUADRANT SITEWORK - PHASE 1**  
**AND TAXIWAY G2 EXTENSION**  
**INTERSECTION IMPROVEMENTS**  
**EXISTING CONDITIONS AND SITE PLAN**

**CMT**  
 CRAWFORD, MURPHY & TILLY, INC.  
 CONSULTING ENGINEERS  
 License No. 984-000619

DESIGN BY: JRL  
 DRAWN BY: JRO  
 CHECKED BY:  
 APPROVED BY:  
 DATE: 03/04/05  
 JOB No: 03297-02

IL PROJECT: IGQ-3329  
 A.I.P. PROJECT: 3-17-0121-B21

SHEET 47 OF 50 SHEETS

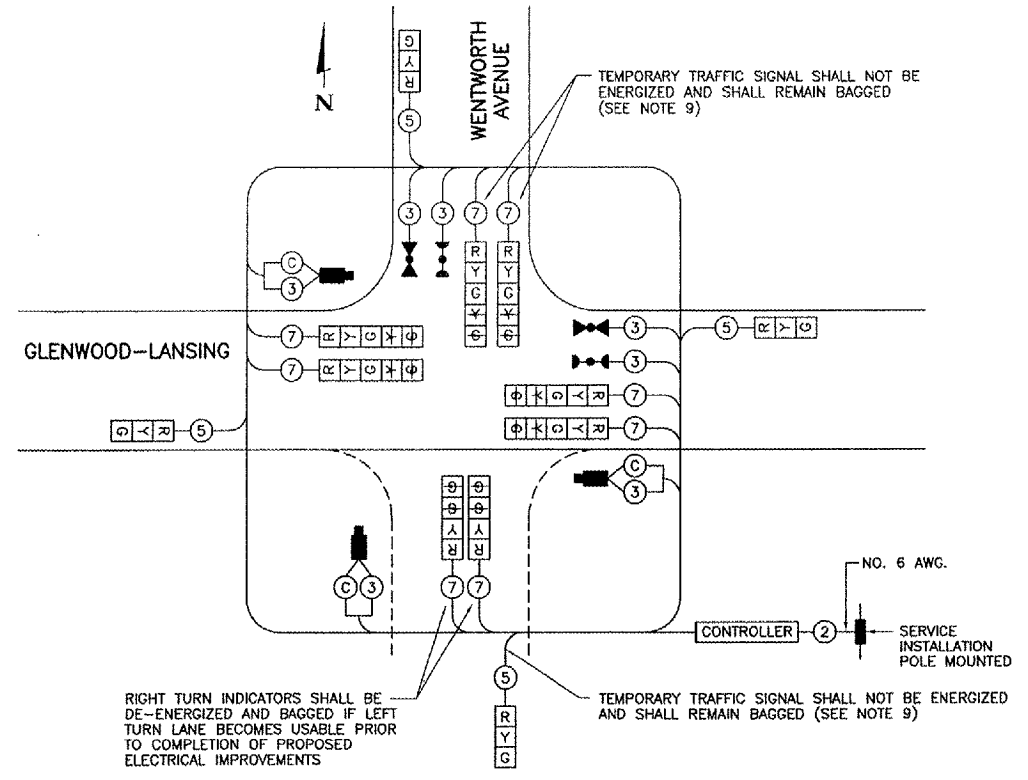

**TEMPORARY CABLE PLAN**  
 NOT TO SCALE

- SIGNAL LENSES**
- R RED
  - Y YELLOW
  - G GREEN
  - Y-G YELLOW TURN INDICATOR
  - G-G GREEN TURN INDICATOR
  - G-G GREEN TURN INDICATOR

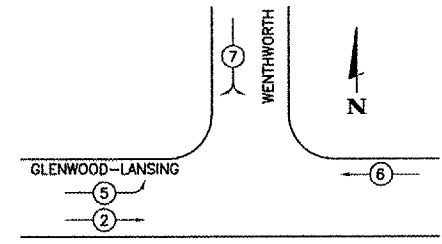
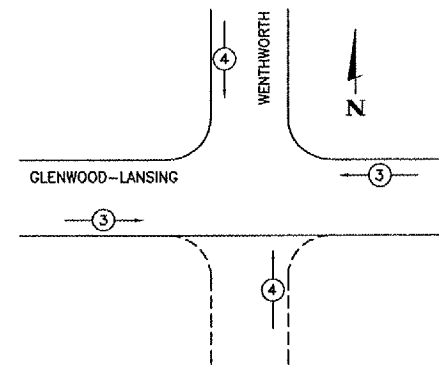

**TEMPORARY TRAFFIC SIGNAL LEGEND**

- TEMPORARY SPAN WIRE TETHER WIRE AND CABLE
- ⊠ EXISTING CONTROL CABINET
- ← TEMPORARY TRAFFIC SIGNAL HEAD SPAN WIRE MOUNTED
- ⊗ TEMPORARY WOOD POLE (CLASS 5 OR BETTER) 45 POST MINIMUM
- ⊠ EXISTING DOUBLE HANDHOLE
- ⊠ EMERGENCY VEHICLE LIGHT DETECTOR
- ⊠ CONFIRMATION BEACON
- ⊠ TEMPORARY CONTROLLER CABINET
- ⊠ MICROWAVE VEHICLE SENSOR/VIDEO DETECTION SYSTEM

**EXISTING EQUIPMENT TO BE REMOVED LEGEND**

- ← EXISTING SIGNAL HEAD TO BE REMOVED
- EXISTING SIGNAL POST AND FOUNDATION TO BE REMOVED
- ⊠ EXISTING HANDHOLE TO BE REMOVED
- ⊠ EXISTING VEHICLE LIGHT DETECTOR TO BE REMOVED
- ⊠ EXISTING CONFIRMATION BEACON TO BE REMOVED
- EXISTING STEEL MAST ARM POLE AND FOUNDATION TO BE REMOVED

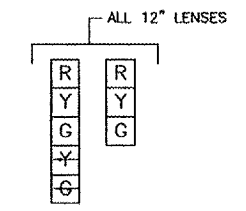

**SIGNAL FACES**

**LEGEND**

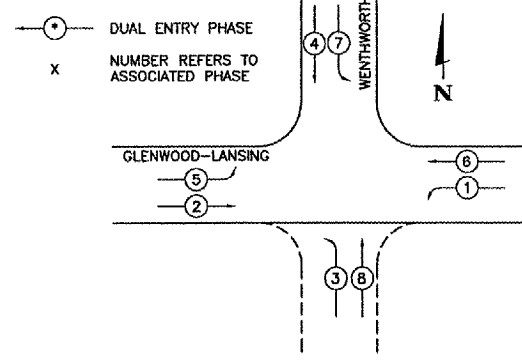

**TEMPORARY PHASE DESIGNATION DIAGRAM - 1B**  
 REFERING TO STANDARD 857001

PHASE 1B SHALL BE INCORPORATED INTO SEQUENCE, IF LEFT TURN LANE BECOMES USABLE PRIOR TO COMPLETION OF PROPOSED ELECTRICAL IMPROVEMENTS. (COST INCIDENTAL TO TEMPORARY TRAFFIC CONTROL)

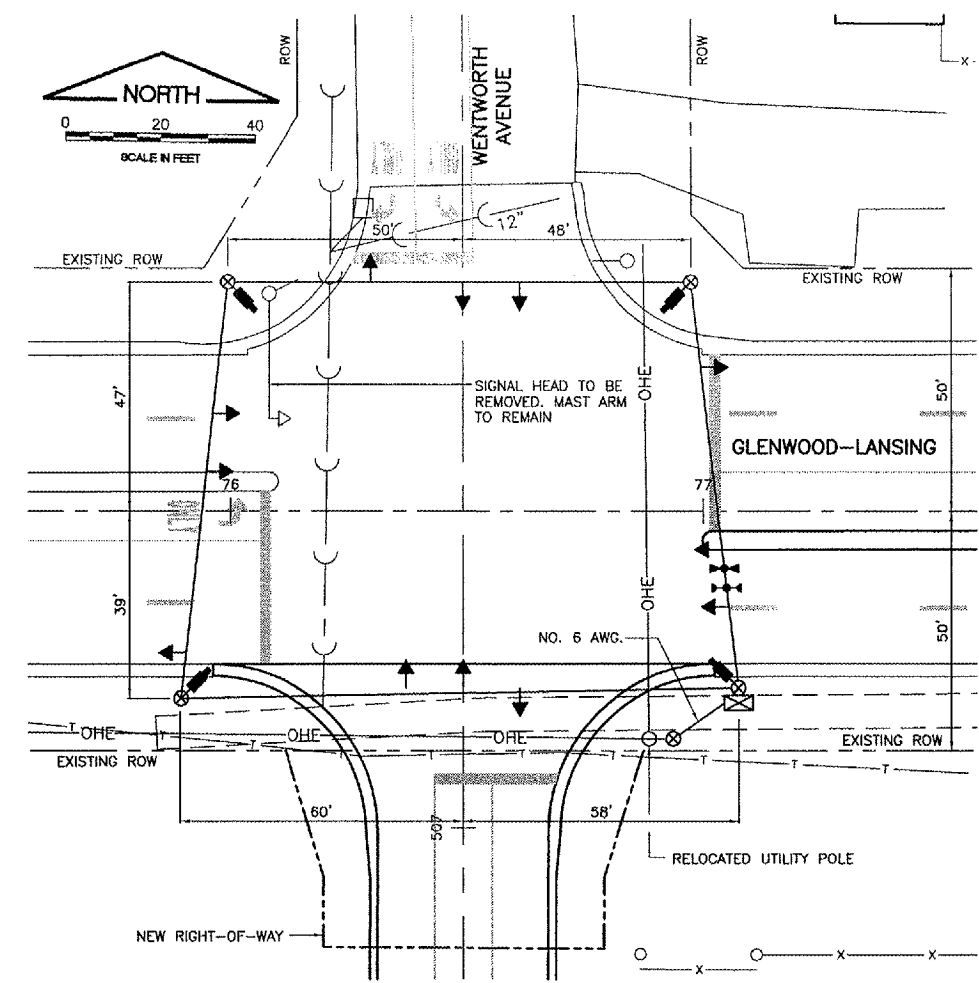

**NOTES FOR TEMPORARY TRAFFIC SIGNALS**

1. ALL CONTROL EQUIPMENT INCLUDING EMERGENCY PRE-EMPTION AND COMMUNICATION DEVICES FOR THE TEMPORARY TRAFFIC SIGNAL(S) SHALL BE FURNISHED BY THE CONTRACTOR UNLESS OTHERWISE STATED IN THE PLANS. ON PROJECTS WITH MULTIPLE TEMPORARY TRAFFIC SIGNAL INSTRUCTIONS, ALL CONTROLLERS SHALL BE THE SAME MANUFACTURER BRAND AND MODEL NUMBER WITH CURRENT SOFTWARE INSTALLED.
2. ALL CONTROLLERS USED FOR TEMPORARY TRAFFIC SIGNALS SHALL BE FULLY ACTUATED NEMA MICROPROCESSOR BASED INSTALLED IN CABINETS WITH 8 PHASE BACK PANELS. CAPABLE OF SUPPLYING 255 SECONDS OF CYCLE LENGTH AND INDIVIDUAL PHASE LENGTH SETTINGS UP TO 99 SECONDS. ON PROJECTS WITH ONE LANE OPEN AND TWO WAY TRAFFIC FLOW, SUCH AS BRIDGE DECK REPAIRS, TEMPORARY SIGNAL CONTROLLER SHALL BE CAPABLE OF PROVIDING ADJUSTABLE ALL RED CLEARANCE SETTINGS OF UP TO 30 SECONDS IN LENGTH.
3. ALL CONTROLLERS USED FOR TEMPORARY TRAFFIC SIGNALS SHALL MEET OR EXCEED THE REQUIREMENTS OF SECTION 857 OF THE STANDARD SPECIFICATIONS FOR ROAD AND BRIDGE CONSTRUCTION WITH REGARDS TO INTERNAL TIME BASE COORDINATION AND PREEMPTION.
4. ALL TRAFFIC SIGNAL SECTIONS AND PEDESTRIAN SIGNAL SECTIONS SHALL BE OF THE 12" TYPE. THE TEMPORARY TRAFFIC SIGNAL HEADS SHALL BE PLACED AS INDICATED ON THE TEMPORARY TRAFFIC SIGNAL PLAN OR AS DIRECTED BY THE ENGINEER. THE CONTRACTOR SHALL FURNISH ENOUGH CABLE SLACK TO RELOCATE HEADS TO ANY POSITION ON THE SPAN WIRE OR AT LOCATIONS ILLUSTRATED ON THE PLANS FOR CONSTRUCTION STAGING. THE TEMPORARY TRAFFIC SIGNAL SHALL REMAIN IN OPERATION DURING ALL SIGNAL HEAD RELOCATIONS. EACH TEMPORARY TRAFFIC SIGNAL HEAD HAVE ITS OWN CABLE FROM THE CONTROLLER CABINET TO THE SIGNAL HEAD.
5. ALL EXISTING STREET NAME AND INTERSECTION REGULATORY SIGNS SHALL BE REMOVED FROM EXISTING POLES AND RELOCATED AND SECURELY FASTENED TO THE SIGNAL SPAN WIRE.
6. ANY TEMPORARY TRAFFIC SECTIONS NOT IN USE DURING A STAGE OF CONSTRUCTION SHALL BE BAGGED AND REACTIVATED.
7. ALL LABOR AND MATERIAL REQUIRED TO COMPLY WITH THESE REQUIREMENTS SHALL BE CONSIDERED INCIDENTAL TO THE BID PRICE OF TEMPORARY TRAFFIC SIGNAL INSTALLATION.
8. TEMPORARY VIDEO DETECTION SYSTEM SHALL BE CONSIDERED AS PART OF THE PAY ITEM "TEMPORARY TRAFFIC SIGNAL INSTALLATION". ALL VIDEO DETECTION ZONES ARE TO BE REDEFINED DURING EACH STAGE OF CONSTRUCTION AND ARE INCIDENTAL TO THE COST OF THE TEMPORARY TRAFFIC SIGNAL INSTALLATION.
9. CONTRACTOR TO VERIFY LOCATION AND DIRECTION OF MAST ARMS AND CAMERAS.
10. CONTRACTOR SHALL ENERGIZE AND UNBAG LIGHTS. IF LEFT TURN LANE BECOMES OPERATIONAL BEFORE ALL PROPOSED ELECTRICAL IMPROVEMENTS ARE COMPLETED. CONTRACTOR SHALL COORDINATE WITH ENGINEER AND COOK COUNTY ENGINEER.

**ESTIMATED BILL OF MATERIALS - TEMPORARY**

TOTAL	UNIT	DESCRIPTION
1	EACH	8-PHASE CONTROLLER/CABINET WITH ALLIED EQUIPMENT
4	EACH	SIGNAL HEAD, ALUMMINUM, 1-FACE, 3-SECTION
8	EACH	SIGNAL HEAD, ALUMMINUM, 1-FACE, 5-SECTION
850	LIN.FT.	ELECTRIC CABLE OVERHEAD NO 14 - 7/C
450	LIN.FT.	ELECTRIC CABLE OVERHEAD NO 14 - 5/C
830	LIN.FT.	ELECTRIC CABLE OVERHEAD NO 14 - 3/C
190	LIN.FT.	ELECTRIC CABLE OVERHEAD NO 20 - 3/C
50	LIN.FT.	ELECTRIC CABLE 6 AWG - 2/C
800	LIN.FT.	COAXIAL CABLE
450	LIN.FT.	MESSENGER WIRE
450	LIN.FT.	TETHER WIRE
4	EACH	WOOD POLE
1	EACH	SERVICE INSTALLATION POLE MOUNTED
4	EACH	VEHICLE VIDEO DETECTOR
2	EACH	EMERGENCY VEHICLE LIGHT DETECTOR
2	EACH	CONFIRMATION BEACON

**REVISIONS**

NUMBER	BY	DATE

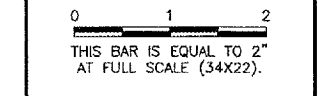

**LANSING MUNICIPAL AIRPORT  
 LANSING, ILLINOIS**

**NORTH QUADRANT SITEWORK - PHASE 1  
 AND TAXIWAY G2 EXTENSION**

**INTERSECTION IMPROVEMENTS  
 TEMPORARY SIGNAL INSTALLATION**

© Copyright CMT, Inc.

**CMT**  
 CRAWFORD, MURPHY & TILLY, INC.  
 CONSULTING ENGINEERS  
 License No. 184-006618

Lansing Municipal Airport

DESIGN BY:	DKP
DRAWN BY:	JRO
CHECKED BY:	ARM
APPROVED BY:	
DATE:	03/04/05
JOB No:	03297-02
IL PROJECT: IGQ-3329 A.I.P. PROJECT: 3-17-0121-B21	
SHEET 48 OF 50 SHEETS	



IMAGE FILES:

LA034

K:\LansingAp\0329702\draw\sheet\Intersec  
 FILE: NewIntersection-2.dwg  
 LAYOUT: Layout1  
 UPDATE BY: johse  
 SURVEY BOOK #  
 DATE: Fri 3/18/05 3:30pm  
 XREF DWG: tbcint.dwg  
 tb.dwg  
 netigr-base.dwg

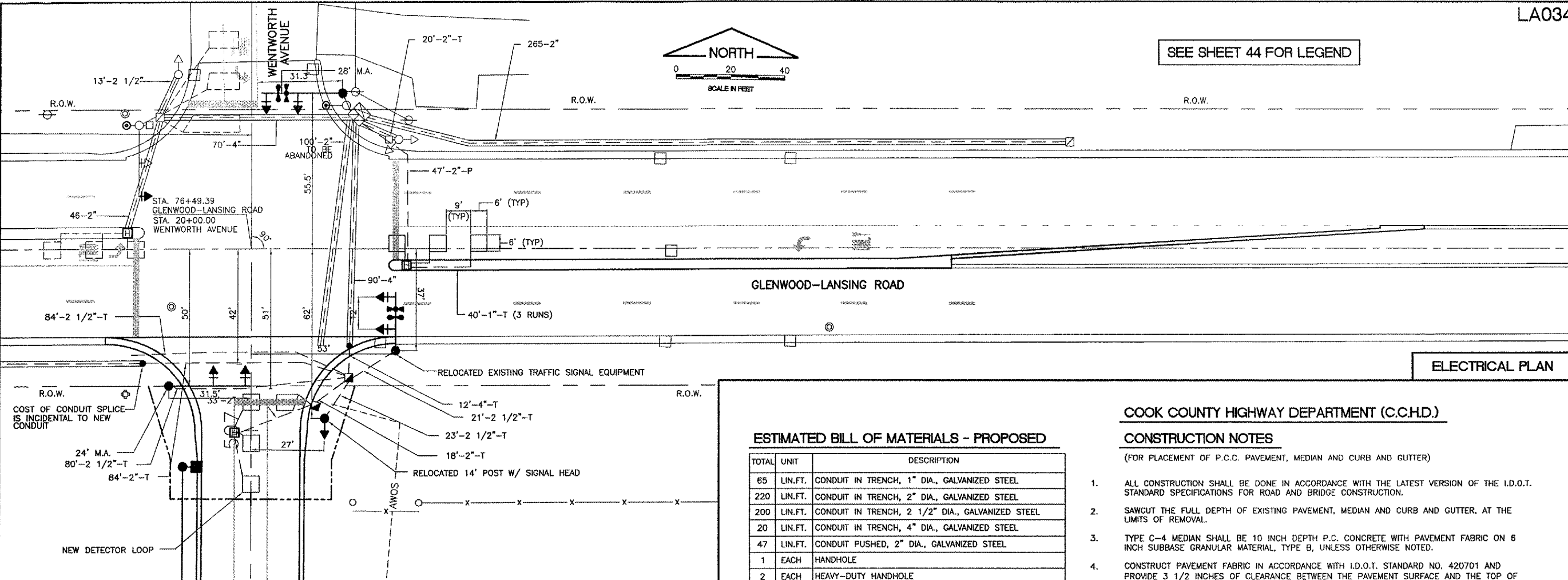

SEE SHEET 44 FOR LEGEND

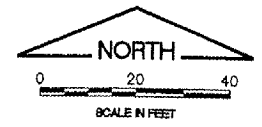

REVISIONS		
NUMBER	BY	DATE

0 1 2  
 THIS BAR IS EQUAL TO 2"  
 AT FULL SCALE (34X22).

ELECTRICAL PLAN

COUNTY GENERAL NOTES

- THE CONTRACTOR SHALL INFORM THE CCHD ENGINEER AT (312) 603-1730 PRIOR TO THE START OF ANY WORK ON THE CONTRACT. A MINIMUM OF FIVE (5) WORKING DAYS ADVANCE NOTICE IS REQUIRED.
- THE CONTRACTOR SHALL MARK LOCATIONS OF LOOPS AND CONTACT THE COUNTY ENGINEER AT (312) 603-1730 FOR LOCATION APPROVAL PRIOR TO CUTTING OF THE LOOPS. A MINIMUM OF FIVE (5) WORKING DAYS ADVANCED NOTICE IS REQUIRED.
- ALL MAST ARM MOUNTED SIGNAL HEADS ARE TO BE ATTACHED 2'-0" FROM END OF MAST ARM UNLESS OTHERWISE NOTED.
- ALL SIGNAL POSTS SHALL BE SET BACK FOUR (4) FEET MINIMUM AND ALL MAST ARM POLES SHALL BE SET BACK SIX (6) FEET MINIMUM FROM THEIR CENTERLINE TO THE BACK OF CURB UNLESS OTHERWISE NOTED. IN NON-CURBED AREAS THE MAST ARM POLE AND SIGNAL POST SHALL BE LOCATED A MINIMUM OF TEN (10) FEET BEHIND THE EDGE OF PAVEMENT OR TWO (2) FEET BEHIND THE EDGE OF SHOULDER, WHICHEVER DISTANCE IS GREATER.
- THE EXACT LOCATION OF ALL UTILITIES SHALL BE FIELD VERIFIED BY THE CONTRACTOR BEFORE THE INSTALLATION OF ANY COMPONENTS OF THE TRAFFIC SIGNAL SYSTEM. FOR EXACT LOCATIONS OF THE UTILITIES CALL J.U.L.I.E. TOLL FREE AT (800) 892-0123.
- IT IS CONTRACTORS' RESPONSIBILITY TO LOCATE EXISTING TRAFFIC SIGNAL CABLES AND CONDUITS.
- ALL ELECTRIC CABLE TO HAVE POLYVINYL CHLORIDE JACKET.
- CONDUITS UNDER ROADWAYS AND DRIVEWAYS SHOULD BE INSTALLED IN TRENCH BEFORE PAVEMENT IS PLACED.
- REFER TO THE IDOT "STANDARD SPECIFICATIONS FOR ROAD AND BRIDGE CONSTRUCTION," (RED BOOK) ADOPTED JANUARY 1, 2002 FOR SPECIFICATIONS ASSOCIATED WITH THIS IMPROVEMENT.
- VEHICLE LOOP DETECTOR SHALL BE COMPATIBLE WITH THE CONTROL EQUIPMENT.
- THE EXISTING TRAFFIC SIGNAL EQUIPMENT SHALL BE REMOVED BY THE CONTRACTOR, SHALL REMAIN THE PROPERTY OF THE COOK COUNTY HIGHWAY DEPARTMENT AND SHALL BE DELIVERED BY THE CONTRACTOR TO THE COUNTY'S TRAFFIC SIGNAL MAINTENANCE FACILITY AS PER THE TRAFFIC SIGNAL SPECIFICATIONS.
- ALL PROPOSED TRAFFIC SIGNALS SHALL BE LED.
- THE CONTRACTOR SHALL RETROFIT ALL EXISTING TRAFFIC EQUIPMENT TO REMAIN TO LED.

TRAFFIC SIGNAL LEGEND

PROPOSED	EXISTING	DESCRIPTION
		CONTROLLER
		SERVICE INSTALLATION
		SIGNAL HEAD
		SIGNAL HEAD WITH BACKPLATE
		SIGNAL HEAD, PEDESTRIAN
		SIGNAL POST
		MAST ARM ASSEMBLY AND POLE, STEEL
		UNIT DUCT
		COMMON TRENCH
		HANDHOLE
		HEAVY DUTY HANDHOLE
		DOUBLE HANDHOLE
		G.S. CONDUIT IN TRENCH (T) OR PUSHED (P)
		PEDESTRIAN PUSHBUTTON DETECTOR
		DETECTOR LOOP
		EMERGENCY VEHICLE LIGHT DETECTOR
		CONFIRMATION BEACON
		CONDUIT SPLICE
		WOOD POLE

ESTIMATED BILL OF MATERIALS - PROPOSED

TOTAL	UNIT	DESCRIPTION
65	LIN.FT.	CONDUIT IN TRENCH, 1" DIA., GALVANIZED STEEL
220	LIN.FT.	CONDUIT IN TRENCH, 2" DIA., GALVANIZED STEEL
200	LIN.FT.	CONDUIT IN TRENCH, 2 1/2" DIA., GALVANIZED STEEL
20	LIN.FT.	CONDUIT IN TRENCH, 4" DIA., GALVANIZED STEEL
47	LIN.FT.	CONDUIT PUSHED, 2" DIA., GALVANIZED STEEL
1	EACH	HANDHOLE
2	EACH	HEAVY-DUTY HANDHOLE
1	EACH	MAINTENANCE OF EXISTING TRAFFIC SIGNAL INSTALLATION
250	LIN.FT.	ELECTRIC CABLE IN CONDUIT, SIGNAL, #14, 3C
650	LIN.FT.	ELECTRIC CABLE IN CONDUIT, SIGNAL, #14, 5C
650	LIN.FT.	ELECTRIC CABLE IN CONDUIT, SIGNAL, #14, 7C
1440	LIN.FT.	ELECTRIC CABLE IN CONDUIT, LEAD-IN, #14 1 PAIR
250	LIN.FT.	ELECTRIC CABLE IN CONDUIT #20 3/C, TWISTED, SHIELDED
1	EACH	STEEL COMBINATION MAST ARM ASSEMBLY AND POLE, 24FT
1	EACH	STEEL COMBINATION MAST ARM ASSEMBLY AND POLE, 28FT
45	LIN.FT.	CONCRETE FOUNDATION, TYPE E 30-INCH DIAMETER
1	EACH	SIGNAL HEAD, 1-FACE, 3-SECTION, MAST ARM MOUNTED
3	EACH	SIGNAL HEAD, 1-FACE, 5-SECTION, MAST ARM MOUNTED
4	EACH	TRAFFIC SIGNAL BACKPLATE, LOUVERED, ALUMINUM
3	EACH	INDUCTIVE LOOP DETECTOR
350	LIN.FT.	DETECTOR LOOP, TYPE 1
1	EACH	LIGHT DETECTOR AMPLIFIER
1	EACH	TEMPORARY TRAFFIC SIGNAL INSTALLATION
1	EACH	RELOCATE EXISTING SIGNAL HEAD
2	EACH	RELOCATE EXISTING TRAFFIC SIGNAL EQUIPMENT
1	EACH	RELOCATE EXISTING EMERGENCY VEHICLE PRIORITY
1	EACH	MODIFY EXISTING CONTROLLER
1	EACH	REMOVE EXISTING TRAFFIC SIGNAL EQUIPMENT
3	EACH	REMOVE EXISTING CONCRETE FOUNDATION
6	EACH	LED SIGNAL FACE RETROFIT, YELLOW BALL
6	EACH	LED SIGNAL FACE RETROFIT, RED BALL
6	EACH	LED SIGNAL FACE RETROFIT, GREEN BALL
1	EACH	LED SIGNAL FACE RETROFIT, YELLOW ARROW
1	EACH	LED SIGNAL FACE RETROFIT, GREEN ARROW
2	EACH	LED SIGNAL FACE RETROFIT, WALK SIGNAL
2	EACH	LED SIGNAL FACE RETROFIT, DON'T WALK SIGNAL
1	EACH	RELOCATE EXISTING HANDHOLE

COOK COUNTY HIGHWAY DEPARTMENT (C.C.H.D.)

CONSTRUCTION NOTES

(FOR PLACEMENT OF P.C.C. PAVEMENT, MEDIAN AND CURB AND GUTTER)

- ALL CONSTRUCTION SHALL BE DONE IN ACCORDANCE WITH THE LATEST VERSION OF THE I.D.O.T. STANDARD SPECIFICATIONS FOR ROAD AND BRIDGE CONSTRUCTION.
- SAWCUT THE FULL DEPTH OF EXISTING PAVEMENT, MEDIAN AND CURB AND GUTTER, AT THE LIMITS OF REMOVAL.
- TYPE C-4 MEDIAN SHALL BE 10 INCH DEPTH P.C. CONCRETE WITH PAVEMENT FABRIC ON 6 INCH SUBBASE GRANULAR MATERIAL, TYPE B, UNLESS OTHERWISE NOTED.
- CONSTRUCT PAVEMENT FABRIC IN ACCORDANCE WITH I.D.O.T. STANDARD NO. 420701 AND PROVIDE 3 1/2 INCHES OF CLEARANCE BETWEEN THE PAVEMENT SURFACE AND THE TOP OF THE FABRIC.
- DISREGARD ALL DETAILS AND NOTES REGARDING PAVEMENT BLOCKOUTS ON I.D.O.T. STANDARD NO. 420701 AND COMPLY WITH I.D.O.T. STANDARD NO. 420111 AT ALL DRAINAGE/UTILITY STRUCTURE LOCATIONS.
- WHERE THE PROPOSED PAVEMENT OR TYPE C-4 MEDIAN ABUTS THE EXISTING PAVEMENT LONGITUDINALLY, PROVIDE A TIED LONGITUDINAL CONSTRUCTION JOINT IN ACCORDANCE WITH I.D.O.T. STANDARD NO. 420001, USING 3/4 INCH DIAMETER TIE BARS AT 24 INCH CENTERS.
- WHERE THE PROPOSED PAVEMENT OR TYPE C-4 MEDIAN ABUTS THE EXISTING PAVEMENT OR TYPE C-4 MEDIAN TRANSVERSELY, PROVIDE A TRANSVERSE JOINT IN ACCORDANCE WITH I.D.O.T. STANDARD NO. 442101, USING 1 1/2 INCH DIAMETER DOWEL BARS AT 12 INCH CENTERS.
- PROVIDE TRANSVERSE SAWED CONTRACTION JOINTS EVERY 20 FEET IN ACCORDANCE WITH I.D.O.T. STANDARD NO. 420001, USING 1 1/2 INCH DIAMETER DOWEL BARS AT 12 INCH CENTERS AND ALIGN PROPOSED JOINTS WITH EXISTING JOINTS. SAWED, GROOVE AND JOINT SEAL SHALL BE CONSTRUCTED IN ACCORDANCE WITH I.D.O.T. STANDARD 42 0001 (COST INCIDENTAL TO P.C.C. PAVEMENT).
- IF A PROPOSED TRANSVERSE SAW CUT IS LOCATED LESS THAN 10 FEET FROM AN EXISTING TRANSVERSE JOINT, THEN THE EXISTING PAVEMENT OR TYPE C-4 MEDIAN SHALL BE REMOVED AND REPLACED UP TO THE EXISTING TRANSVERSE JOINT.
- PAVEMENT PATCHES SHALL BE CLASS B, CONSTRUCTED IN ACCORDANCE WITH I.D.O.T. STANDARD NO. 442101 AND SHALL EXTEND THE FULL WIDTH OF THE EXISTING LANE(S). WHERE PATCHING MORE THAN ONE LANE WIDTH, PROVIDE A TIED LONGITUDINAL JOINT (CONSTRUCTION OR SAWED) BETWEEN LANES, IN ACCORDANCE WITH I.D.O.T. STANDARD NO. 420001. C.C.H.D. CONSTRUCTION NOTE NUMBERS 1 THROUGH 8 SHALL APPLY TO THE CONSTRUCTION OF CLASS B PATCHES.
- CURB AND GUTTER SHALL BE CONSTRUCTED AND TIED INTO ABUTTING EXISTING OR PROPOSED P.C.C. PAVEMENT IN ACCORDANCE WITH I.D.O.T. STANDARD NUMBERS 606001 AND 420001, USING 3/4 INCH DIAMETER TIE BARS AT 24 INCH CENTERS.
- CONSTRUCT TYPE C-4 AND TYPE M-7 MEDIANS IN ACCORDANCE WITH THE C.C.H.D. MEDIAN STANDARD.
- PLACEMENT OF CATCH BASINS WITHIN TYPE M-7 MEDIAN SHALL BE IN ACCORDANCE WITH THE C.C.H.D. "POLICY FOR DRAINING TYPE M-7 MEDIAN" STANDARD.
- WHERE A MEDIAN OPENING IS PROVIDED, THE PAVEMENT SHALL BE CROWNED AT THE CENTERLINE USING A ONE PERCENT CROSS SLOPE.
- ALL TRENCHES WITHIN THE COUNTY RIGHT OF WAY SHALL BE BACKFILLED WITH FA-6 SAND IN ACCORDANCE WITH ARTICLE 550.07 OF THE I.D.O.T. STANDARD SPECIFICATIONS. THE BACKFILLING MUST EXTEND UP TO THE PROPOSED SUBBASE IN PAVEMENT SECTIONS. COST SHALL BE INCIDENTAL TO RESPECTIVE PAY ITEM.
- ALL PAVEMENT MARKING WORK ALONG GLENWOOD-LANSING ROAD SHALL BE PER C.C.H.D. STANDARDS.
- ALL DISTURBED LAWN AREAS/SHOULDER AREAS WITHIN C.C.H.D. RIGHT-OF-WAY SHALL BE RESTORED WITH 4" TOPSOIL AND SOD PER THE STORM WATER POLLUTION PREVENTION PLAN. PAYMENT SHALL BE UNDER ITEM 905 AND ITEM 908 PER STANDARD SPECIFICATIONS OF CONSTRUCTION OF AIRPORTS.

LANSING MUNICIPAL AIRPORT  
 LANSING, ILLINOIS  
 NORTH QUADRANT SITEWORK - PHASE 1  
 AND TAXIWAY G2 EXTENSION  
 INTERSECTION IMPROVEMENTS  
 ELECTRICAL PLAN  
 AND MISCELLANEOUS DETAILS

Copyright CMT, Inc.  
  
 CMT  
 CRAWFORD, MURPHY & TILLY, INC.  
 CONSULTING ENGINEERS  
 License No. 184-000613

DESIGN BY:	JRL
DRAWN BY:	JRO
CHECKED BY:	
APPROVED BY:	
DATE:	03/04/05
JOB No:	03297-02
IL PROJECT:	IGQ-3329
A.I.P. PROJECT:	3-17-0121-B21
SHEET	49 OF 50 SHEETS

**NOTES**

- THIS A SYSTEM GROUND THAT SHALL INTERCONNECT ALL GROUND RODS WITH NO. 6 1/C SOLID COPPER AWG.
- ALL ELECTRICAL IMPROVEMENTS SHALL BE IN ACCORDANCE WITH THE FOLLOWING STANDARDS:
  - IDOT STANDARD 814001 CONCRETE HANDHOLES
  - IDOT STANDARD 857001 STANDARD PHASE DESIGNATION DIAGRAMS AND PHASE SEQUENCES
  - IDOT STANDARD 877007-02 STEEL MAST ARM ASSEMBLY AND POLE
  - IDOT STANDARD 878001-03 CONCRETE FOUNDATION DETAILS
  - IDOT STANDARD 880006 TRAFFIC SIGNAL MOUNTING DETAILS
  - IDOT STANDARD 880001 SPAN WIRE MOUNTED SIGNALS AND FLASHING BEACON INSTALLATION
  - IDOT STANDARD 886001 DETECTOR LOOP INSTALLATIONS
  - IDOT STANDARD 886006 TYPICAL LAYOUTS FOR DETECTION LOOPS

**CABLE PLAN LEGEND**

- 12" TRAFFIC SIGNAL SECTION
- CONTROLLER CABINET
- VEHICLE DETECTOR, INCLUDING LOOP
- DENOTES NUMBER OF CONDUCTORS (NEW)  
ALL LOOP DETECTOR CABLE TO BE TWISTED AND SHIELDED. ALL CABLE NO. 14 EXCEPT AS INDICATED
- SIGNAL FACE
- SIGNAL FACE WITH BACKPLATE
- GROUNDING SYSTEM CONNECTION
- SHIELDED AND TWISTED
- EXISTING SERVICE
- PEDESTRIAN SIGNAL HEAD
- PEDESTRIAN PUSHBUTTON
- EMERGENCY VEHICLE SYSTEM LIGHT DETECTOR
- ELECTRIC CABLE NO. 20 A.W.G.
- CONFIRMATION BEACON

REVISIONS

NUMBER	BY	DATE

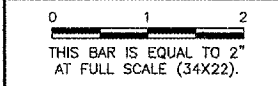

**LANSING MUNICIPAL AIRPORT**  
**LANSING, ILLINOIS**  
**NORTH QUADRANT SITEWORK - PHASE 1**  
**AND TAXIWAY G2 EXTENSION**  
**INTERSECTION IMPROVEMENTS**  
**TRAFFIC SIGNAL INSTALLATION**

© Copyright CMT, Inc.

**CMT**  
 CRAWFORD, MURPHY & TILLY, INC.  
 CONSULTING ENGINEERS  
 License No. 184-000613

Lansing Municipal Airport

DESIGN BY:	DKP
DRAWN BY:	JRO
CHECKED BY:	ARM
APPROVED BY:	
DATE:	03/04/05
JOB No:	03297-02
IL PROJECT:	IGQ-3329
A.I.P. PROJECT:	3-17-0121-B21

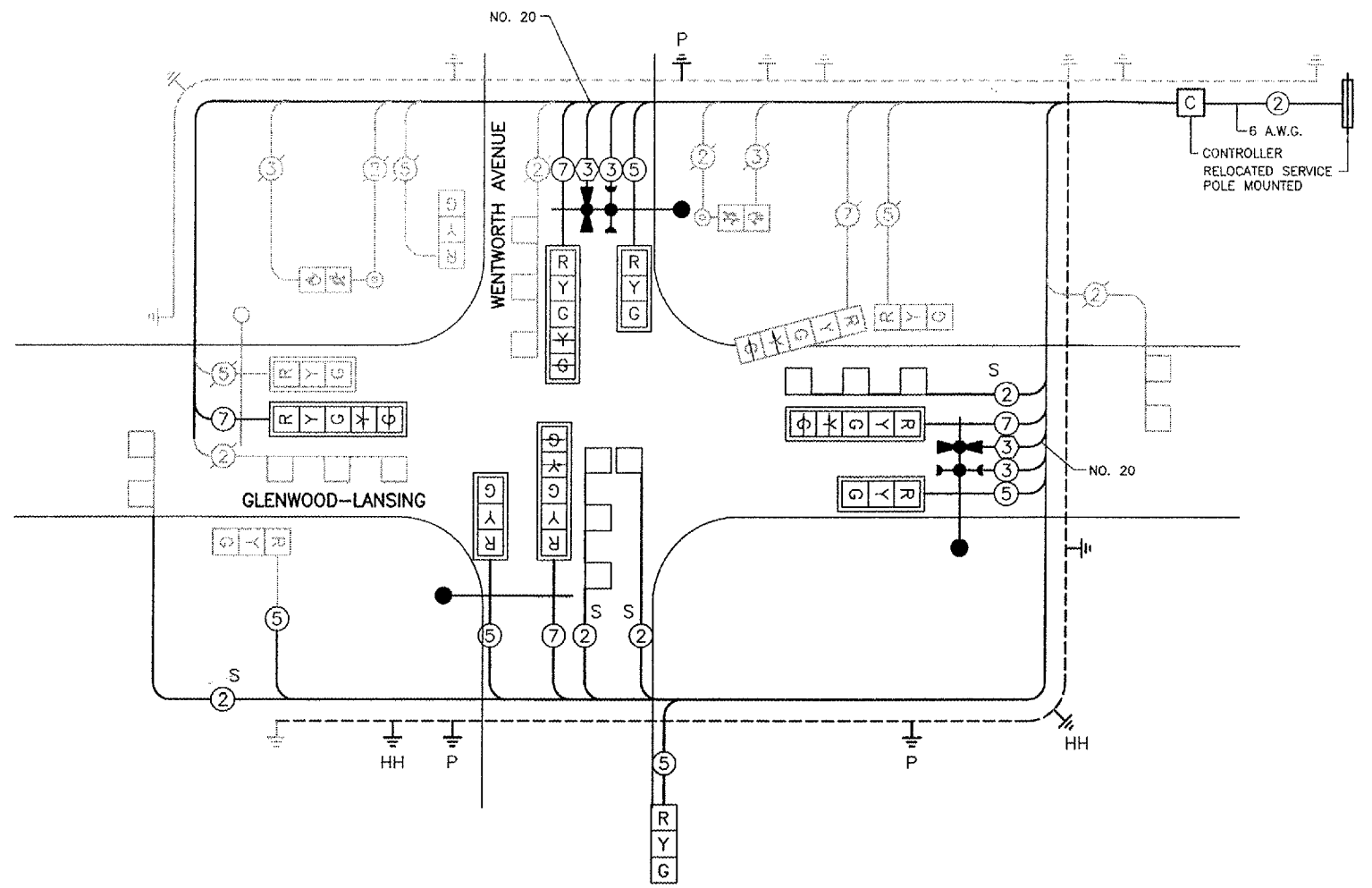

**CABLE PLAN**  
N.T.S.

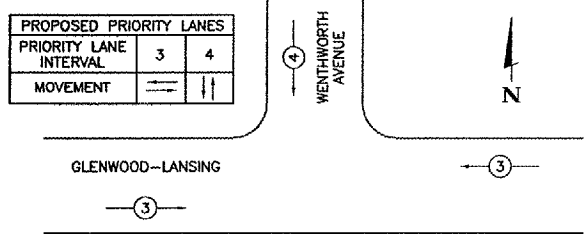

**EXISTING EMERGENCY VEHICLE PREEMPTION SEQUENCE**  
(N.T.S)

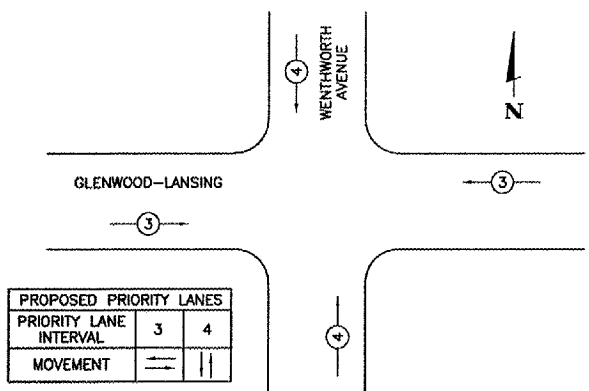

**PROPOSED EMERGENCY VEHICLE PREEMPTION SEQUENCE**  
(N.T.S)

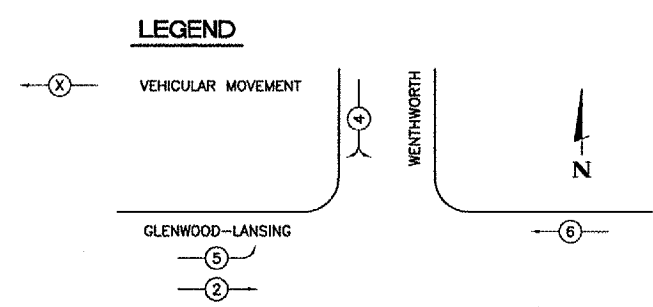

**EXISTING CONTROLLER SEQUENCE**  
(N.T.S)

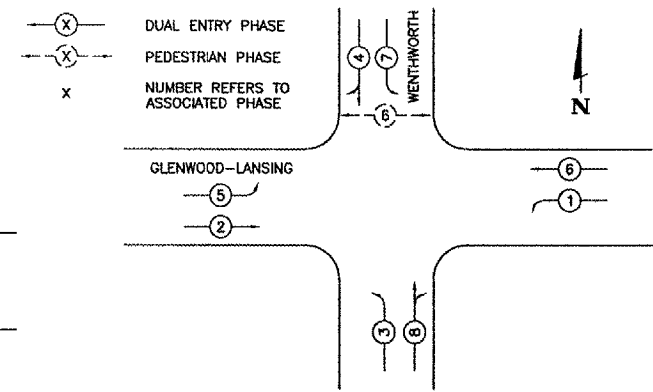

**PROPOSED CONTROLLER SEQUENCE**  
**PHASE DESIGNATION DIAGRAM**  
 DUAL ENTRY-ALL LEGS PROTECTED/PERMISSIVE LEFT TURN PHASING  
 (N.T.S)

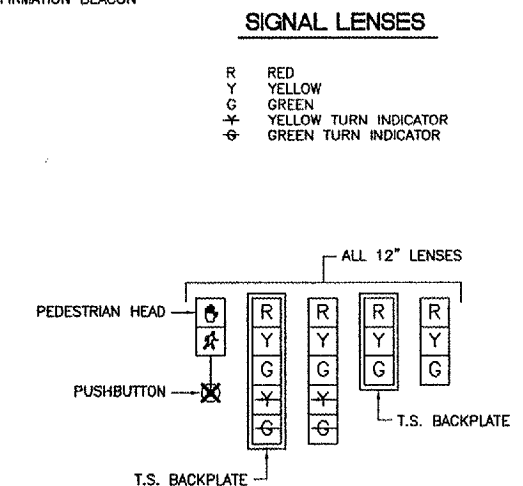

**SIGNAL FACES**