

**SECTION THRU SIDEWALK**

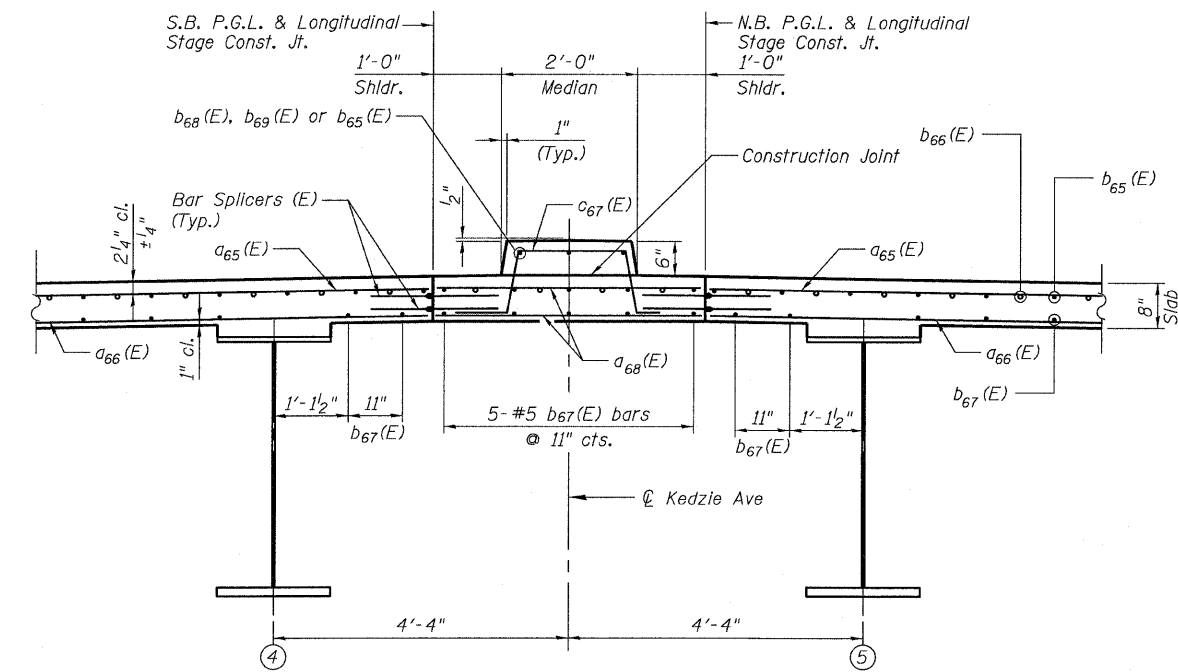

**SECTION THRU MEDIAN**

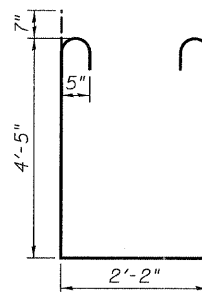

**BAR S62(E)**

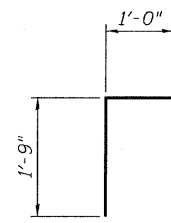

**BAR V63(E)**

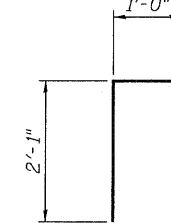

**BAR V64(E)**

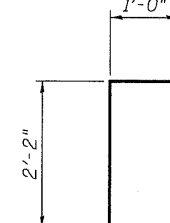

**BAR V65(E)**

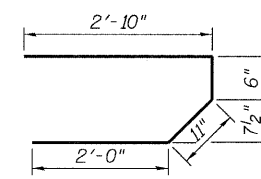

**BAR S60(E)**

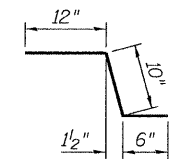

**BAR C65(E)**

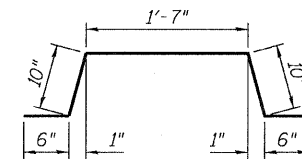

**BAR C67(E)**

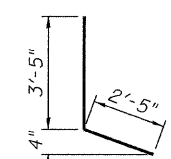

**BAR D65(E)**

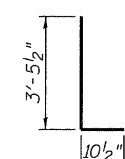

**BAR D66(E)**

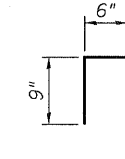

**BAR D67(E)**

**BILL OF MATERIAL**

Bar	No.	Size	Length	Shape
a65(E)	1250	#5	31'-7"	—
a66(E)	810	#5	30'-3"	—
a67(E)	72	#5	2'-0"	—
a68(E)	1030	#5	3'-8"	—
b65(E)	1050	#5	26'-10"	—
b66(E)	198	#6	33'-6"	—
b67(E)	693	#5	29'-0"	—
b68(E)	3	#5	19'-6"	—
b69(E)	3	#5	19'-4"	—
c65(E)	574	#5	2'-4"	—
c66(E)	574	#5	5'-8"	—
c67(E)	287	#5	4'-3"	—
d65(E)	570	#4	5'-10"	—
d66(E)	570	#6	4'-4"	—
d67(E)	128	#4	2'-0"	—
e65(E)	84	#4	17'-9"	—
e66(E)	12	#4	19'-6"	—
e67(E)	12	#4	19'-4"	—
e68(E)	84	#4	16'-10"	—
m58(E)	10	#6	35'-5"	—
m59(E)	32	#6	12'-2"	—
m60(E)	12	#6	8'-6"	—
m61(E)	4	#6	3'-6"	—
m62(E)	2	#6	2'-0"	—
m63(E)	2	#6	6'-2"	—
m64(E)	10	#6	32'-10"	—
s60(E)	142	#5	6'-3"	—
s62(E)	124	#5	12'-2"	—
v63(E)	41	#5	2'-9"	—
v64(E)	44	#5	3'-1"	—
v65(E)	55	#5	3'-2"	—
Item	Unit	Total		
Concrete Superstructure	Cu. Yd.	716.4		
Reinforcement Bars, Epoxy Coated	Pounds	150,420		
Bar Splicers	Each	2,214		

**TYLIN INTERNATIONAL**

USER NAME =	DESIGNED - JKO	REVISED -
PLOT SCALE =	CHECKED - CPT	REVISED -
PLOT DATE = 5/5/2011	DRAWN - TSK	REVISED -
	CHECKED - JKO	REVISED -

**STATE OF ILLINOIS  
DEPARTMENT OF TRANSPORTATION**

**SUPERSTRUCTURE DETAILS - 2  
STRUCTURE NO. 016-1196**

SHEET NO. 15 OF 40 SHEETS

F.A.I. RTE.	SECTION	COUNTY	TOTAL SHEETS	SHEET NO.
57	1313.1B-1	COOK	162	76
			CONTRACT NO. 60K14	
ILLINOIS FED. AID PROJECT				