

TYPICAL DRIVE DETAIL
(NOT TO SCALE)

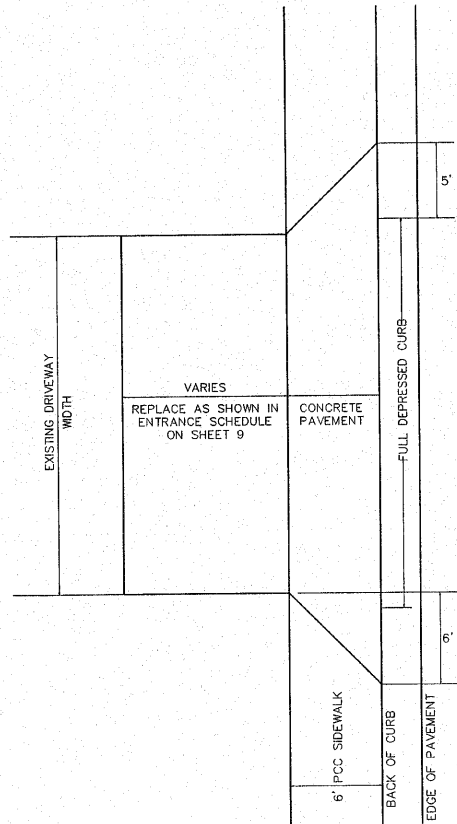

SIDEWALK/DOWNSPOUT CROSS DRAIN
(NOT TO SCALE)

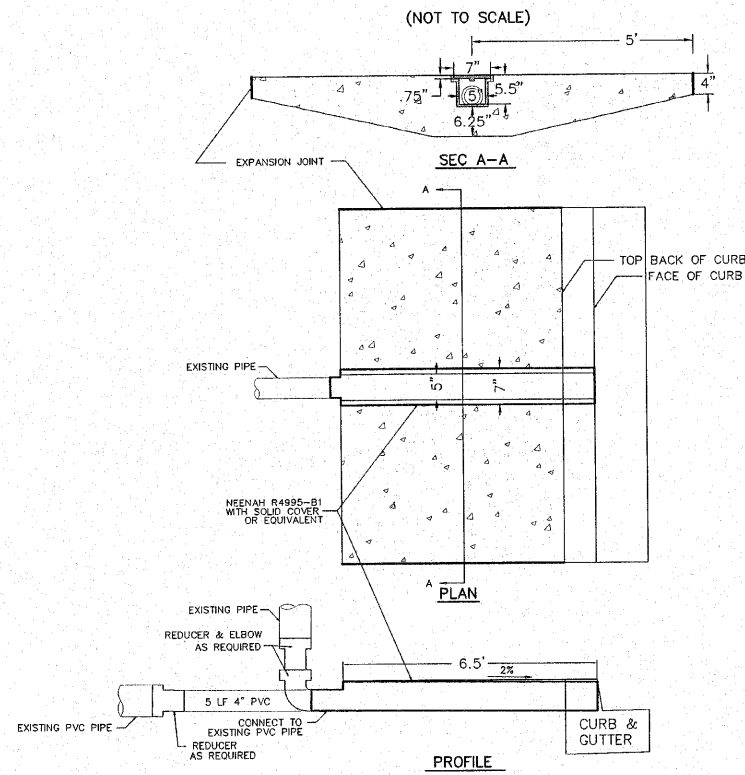

ELECTRICAL CONDUIT
STA. 10+80 to STA. 20+52 LT.
STA. 10+80 to STA. 20+62 RT.
(NOT TO SCALE)

STREET CROSSINGS

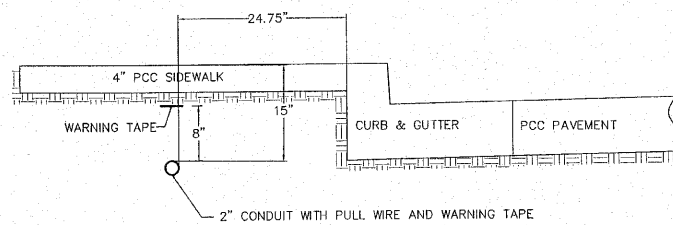
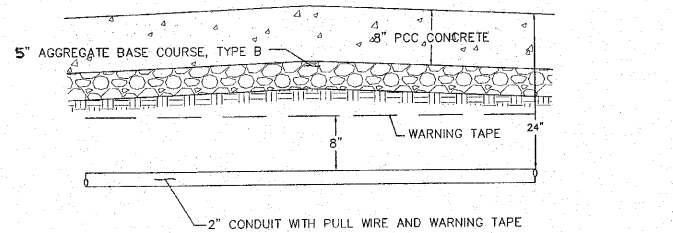

FEATHER EDGE DETAIL
(@ SIDE STREETS)
(NOT TO SCALE)

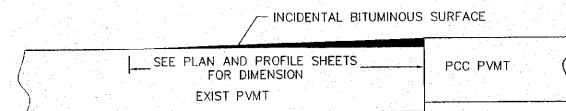

PROPOSED SANITARY AND STORM SEWER PROFILES

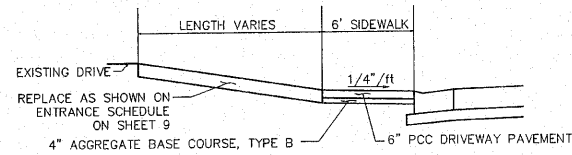
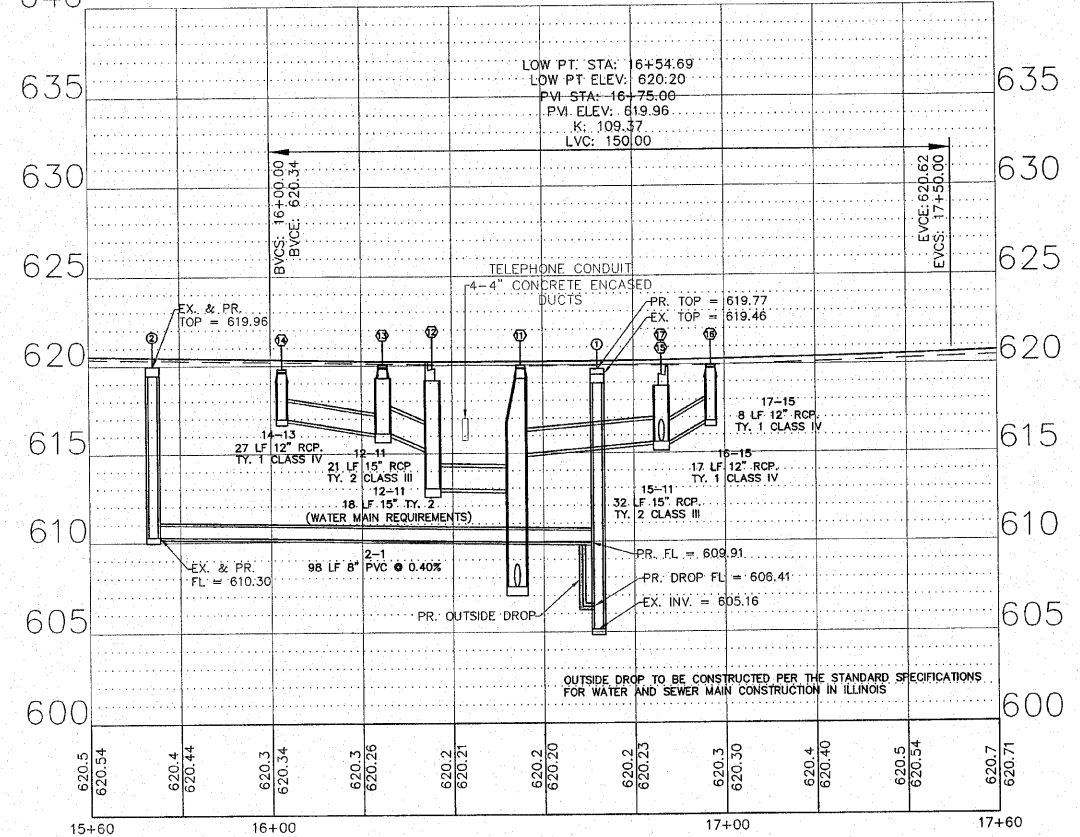

IN KIND DRIVEWAY REPLACEMENT
(NOT TO SCALE)

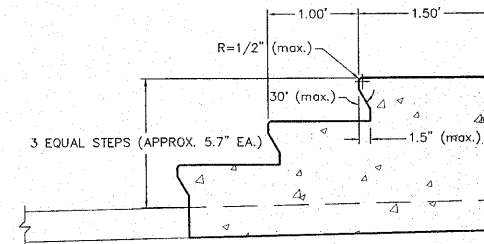
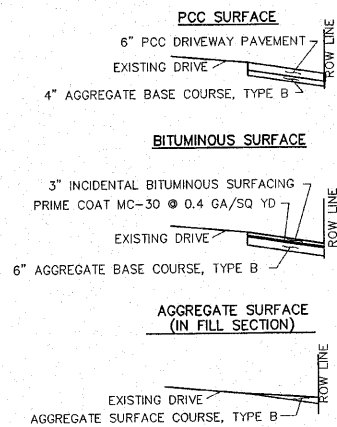

CONCRETE STEP DETAIL
(NOT TO SCALE)

BUTT JOINT DETAIL
(NOT TO SCALE)

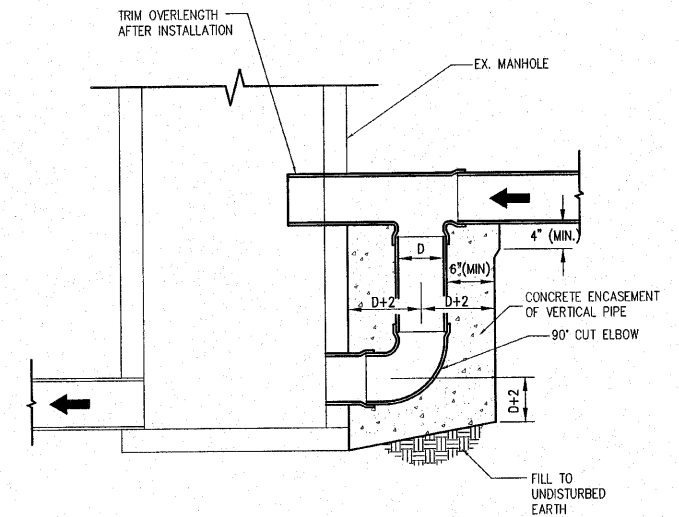
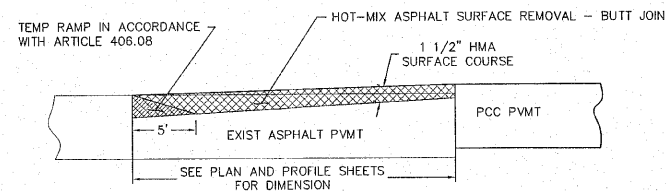

TYPICAL DROP MANHOLE DETAIL
(NOT TO SCALE)

FILE NAME = 01819-301	USER NAME = Horgan, Chris	DESIGNED - CSH	REVISED - 4/8/2010	STATE OF ILLINOIS DEPARTMENT OF TRANSPORTATION	DETAILS	F.A.U. RTE. 8136	SECTION 09-00036-02 PV	COUNTY MACOUPIN	TOTAL SHEETS 29	SHEET NO. 20			
	PLOT SCALE = 1:1	DRAWN - CAW	REVISED -			SCALE: NA	SHEET NO. 20 OF 29 SHEETS	STA. NA	TO STA. NA	CONTRACT NO. 93521			
	PLOT DATE = 4/8/2010	CHECKED - DLK	REVISED -			FED. ROAD DIST. NO. 6 ILLINOIS TIED AID PROJECT							
		DATE - 11/25/09	REVISED -										