

ROUTE NO.	SECTION	COUNTY	TOTAL SHEETS	SHEET NO.
F.A.P. 656	(11)	TAZEWELL	32	25
FED. ROAD DIST. NO. 4		ILLINOIS	FED. AID PROJECT	
CONTRACT NO. 68024				

SHEET NO. 14  
OF 18 SHEETS

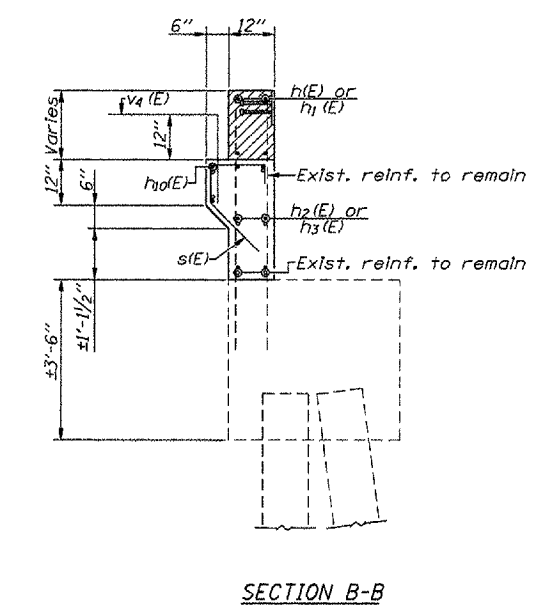

•• Epoxy grout #5v4(E) bars in 9" min. drilled holes according to Section 584 of the Standard Specifications. Cost included with Reinforcement Bars, Epoxy Coated.

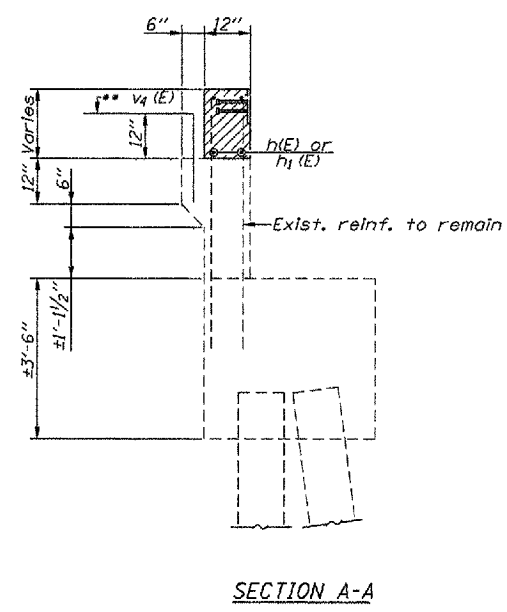
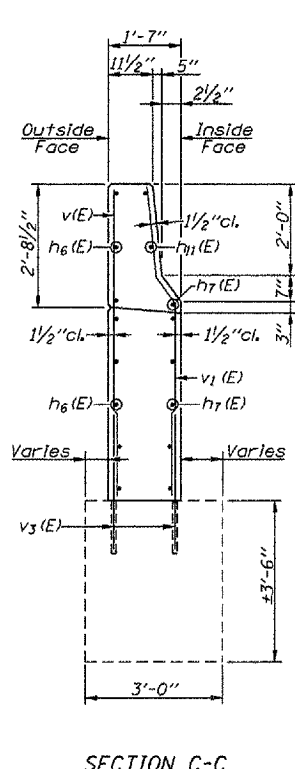
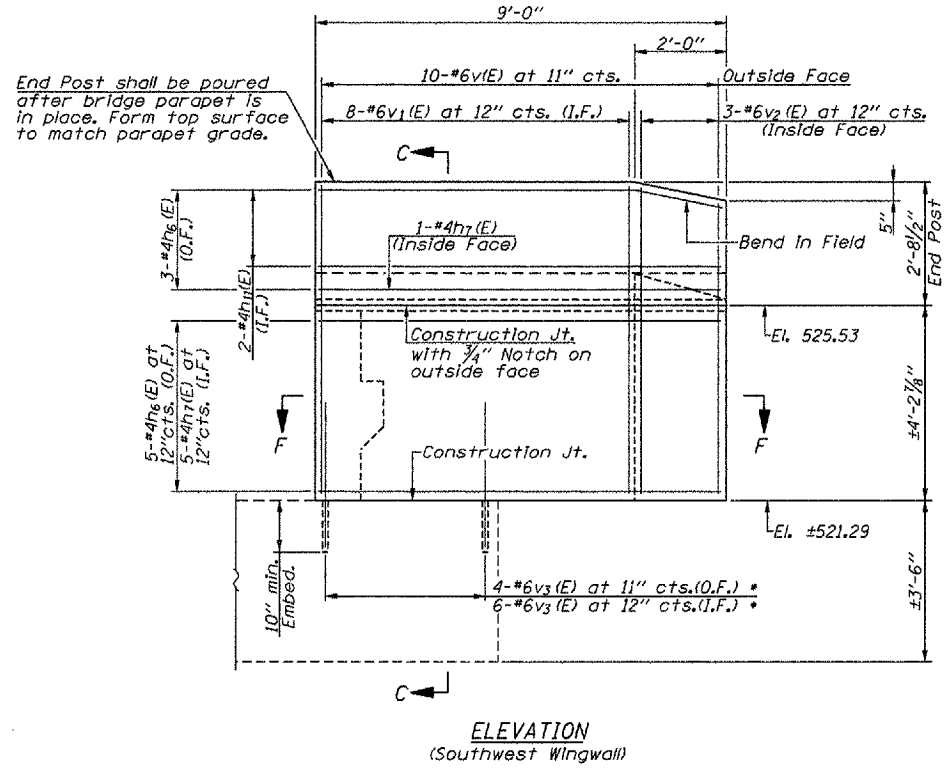
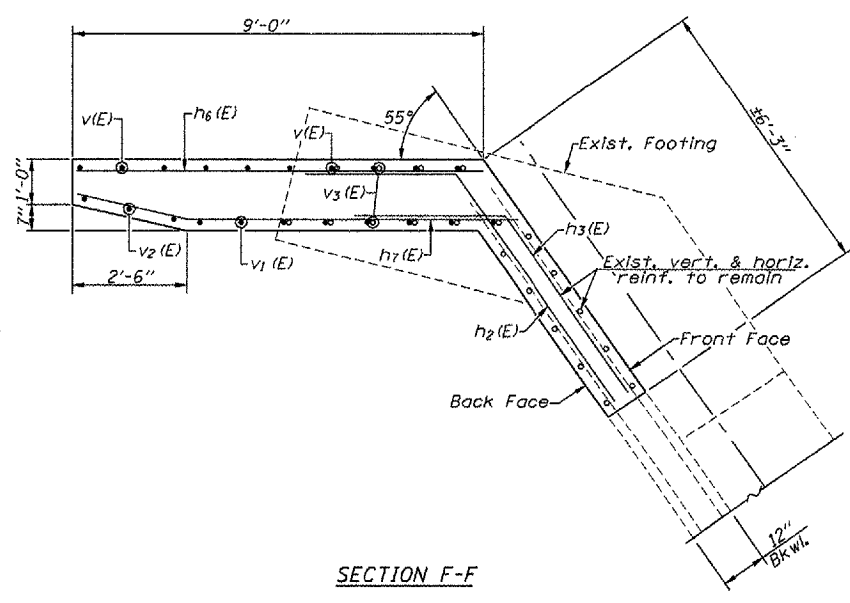
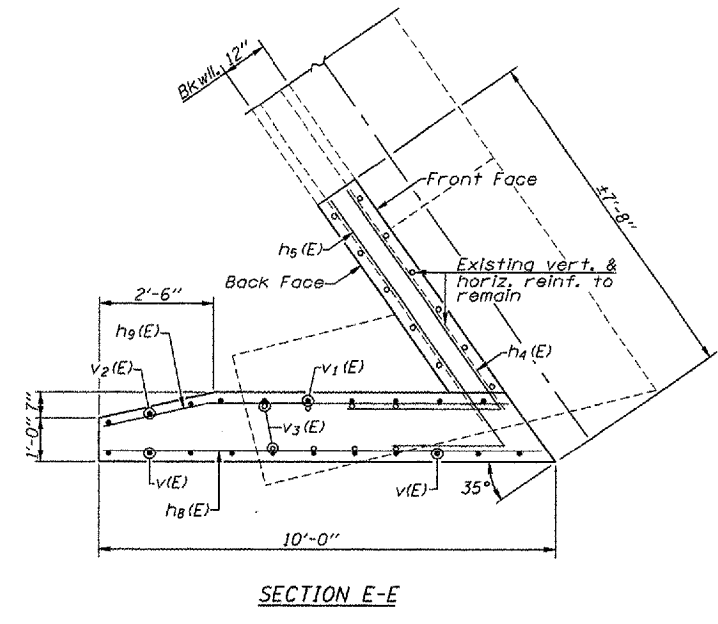
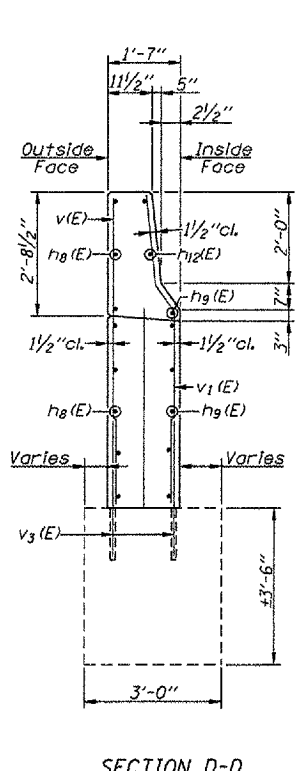
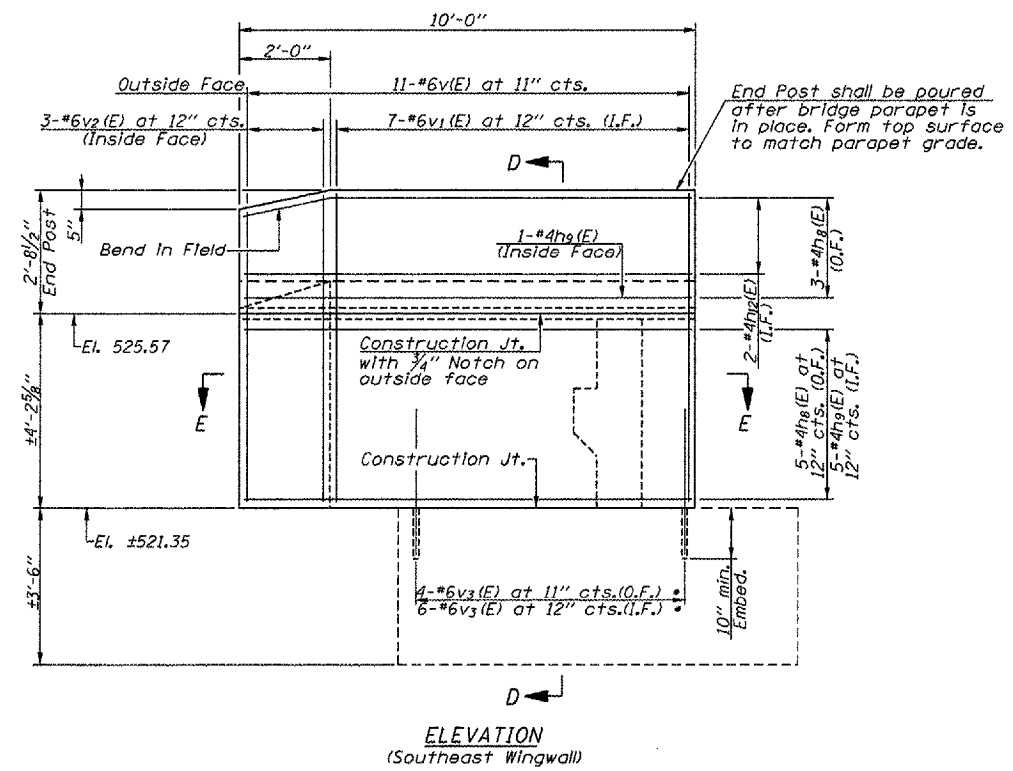

DESIGNED	- MAH
CHECKED	- APH
DRAWN	- JRP
CHECKED	- MAH

• Drill and epoxy grout v3(E) bars into existing footing according to Section 584 of the Standard Specifications. Cost included with Reinforcement Bars, Epoxy Coated.

SOUTH ABUTMENT DETAILS  
IL. ROUTE 29 OVER CRANE CREEK  
F.A.P. ROUTE 656 - SECTION (11)  
TAZEWELL COUNTY  
STA. 166+53.50  
S.N. 090-0053