

LIGHT POLE FOUNDATION DEPTH TABLE
12.192M (40 FT.) TO 14.478M (47.5 FT.) MOUNTING HEIGHT

| SOIL CONDITIONS | DESIGN DEPTH "D" OF FOUNDATION | |
|--------------------------------------|--------------------------------|-------------------|
| | SINGLE ARM POLE | TWIN ARM POLE |
| SOFT CLAY Cu = 0.375 TON/SO. FT. | 3.96M (13'-0") | 4.57M (15'-0") |
| MEDIUM CLAY Cu = 0.75 TON/SO. FT. | 2.09M (9'-6") | 3.23M (10'-9") |
| STIFF CLAY Cu = 1.50 TON/SO. FT. | 2.13M (7'-0") | 2.44M (8'-0") |
| LOOSE SAND φ = 34° | 2.74M (9'-0") | 3.05M (10'-0") |
| MEDIUM SAND φ = 37.5° | 2.52M (8'-3") | 2.74M (9'-0") |
| DENSE SAND φ = 40° | 2.36M (7'-9") | 2.74M (9'-0") |

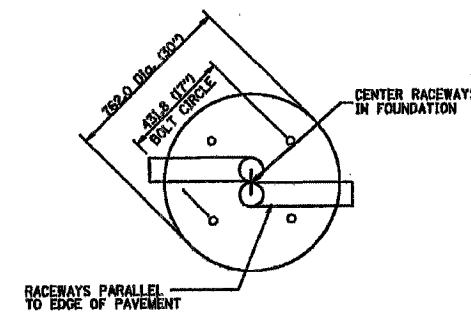
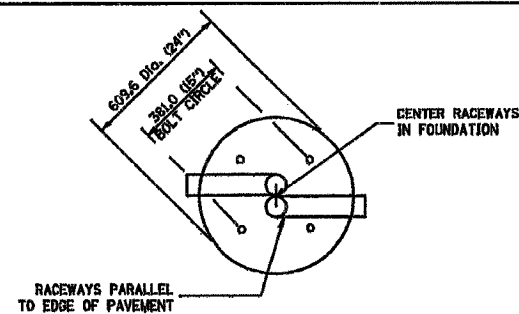

TOP VIEW

TOP VIEW

NOTES

- ALL DIMENSIONS ARE IN MILLIMETERS (INCHES) UNLESS OTHERWISE SHOWN.
- THE ANCHOR RODS AND RACEWAYS SHALL BE PROPERLY SECURED IN PLACE BEFORE THE CONCRETE IS PLACED.
- THE FOUNDATION SHALL NOT PROTRUDE MORE THAN 100MM (4 IN.) ABOVE THE FINISHED GRADE WITHIN A 1.5M (60 IN.) CHORD ACROSS THE FOUNDATION, WITH ANCHOR RODS INCLUDED, IN ACCORDANCE WITH AASHTO GUIDELINES. IF THE FOUNDATION HEIGHT, INCLUDING ANCHOR RODS, EXTENDS BEYOND THESE SPECIFIED LIMITS, THE FOUNDATION SHALL BE REPLACED AT THE CONTRACTOR'S EXPENSE. SEE FOUNDATION EXTENSION DETAIL.
- THE HOLE FOR THE FOUNDATION SHALL BE MADE BY DRILLING WITH AN AUGER, OF THE SAME DIAMETER AS THE FOUNDATION. IF SOIL CONDITIONS REQUIRE THE USE OF A LINER TO FORM THE HOLE, THE LINER SHALL BE WITHDRAWN AS THE CONCRETE IS DEPOSITED.
- THE TOP OF THE FOUNDATION SHALL BE CONSTRUCTED LEVEL. A LINER OR FORM SHALL BE USED TO PRODUCE A UNIFORM SMOOTH SIDE TO THE TOP OF THE FOUNDATION. FOUNDATION TOP SHALL BE CHAMFERED 20MM (3/4-IN.).
- THE CONCRETE SHALL BE CLASS SL. CONCRETE SHALL CURE ACCORDING TO ARTICLE 1020.13 BEFORE LIGHT POLES ARE INSTALLED.
- THE ANCHOR ROD SHALL BE A HOOK ROD TYPE. COLD BENDING OF THE ANCHOR ROD WILL NOT BE ALLOWED. THE RADIUS OF THE HOOK BEND SHALL NOT BE LESS THAN 4 TIMES THE NOMINAL DIAMETER OF THE ANCHOR ROD. A TACK WELDED ANCHOR ROD MAY BE SUBSTITUTED WITH THE APPROVAL OF THE ENGINEER.
- THE ANCHOR RODS SHALL BE ACCORDING TO ASTM F1654 GRADE 725 (GRADE 105). NUTS SHALL BE HEXAGON NUTS ACCORDING TO ASTM A 194 2H OR ASTM A 563 DH, AND WASHERS SHALL BE ACCORDING TO ASTM F 436.
- ANCHOR RODS, NUTS AND WASHERS SHALL BE COMPLETELY GALVANIZED BY EITHER THE HOT-DIPPED PROCESS CONFORMING WITH AASHTO M 232, THE MECHANICAL PLATING METHOD CONFORMING TO AASHTO M 298, CLASS 50 WITH A MAXIMUM COATING THICKNESS OF 150 UM(6 MILS) OR THE ELECTROLYTIC PROCESS ACCORDING TO ASTM F 1136.
- THE ANCHOR RODS SHALL BE THREADED A MINIMUM OF 150 MM (6 INCHES) WITH A MINIMUM OF 75 MM (3 INCHES) OF THREADED ANCHOR ROD EMBEDDED IN THE FOUNDATION.
- ANCHOR RODS SHALL PROJECT 69.9MM (2 3/4") ABOVE THE TOP OF THE FOUNDATION. IF BREAKAWAY COUPLINGS ARE SPECIFIED, THE CONTRACTOR SHALL CAREFULLY COORDINATE THE ANCHOR ROD PROJECTION WITH THE INSTALLATION REQUIREMENTS OF THE BREAKAWAY COUPLINGS.
- THE CONTRACTOR SHALL USE A #3 SPIRAL AT 162.4MM (6") PITCH OR MAY SUBSTITUTE #3 TIES AT 304.8MM (12") O.C. WITH THE APPROVAL OF THE ENGINEER.
- THE CABLE TRENCHES AND FOUNDATION SHALL BE BACK FILLED AND COMPACTED AS SPECIFIED BEFORE THE LIGHT POLE IS ERECTED.
- THE RACEWAYS SHALL PROJECT 25.4MM (1") ABOVE THE TOP OF THE FOUNDATION.
- TOP BOLT CIRCLE OF THE TRANSFORMER BASE TO MATCH EXISTING POLE. BOTTOM BOLT CIRCLE OF THE TRANSFORMER BASE IS TO MATCH THE FOUNDATION BOLT CIRCLE.

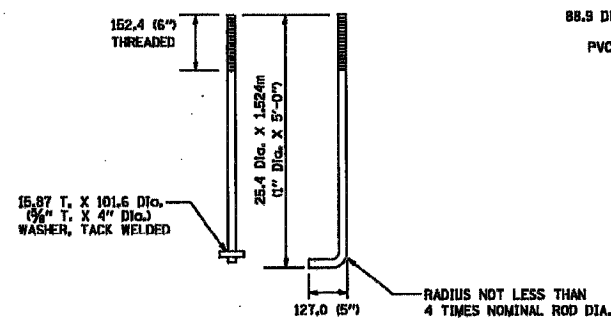

ANCHOR ROD DETAIL

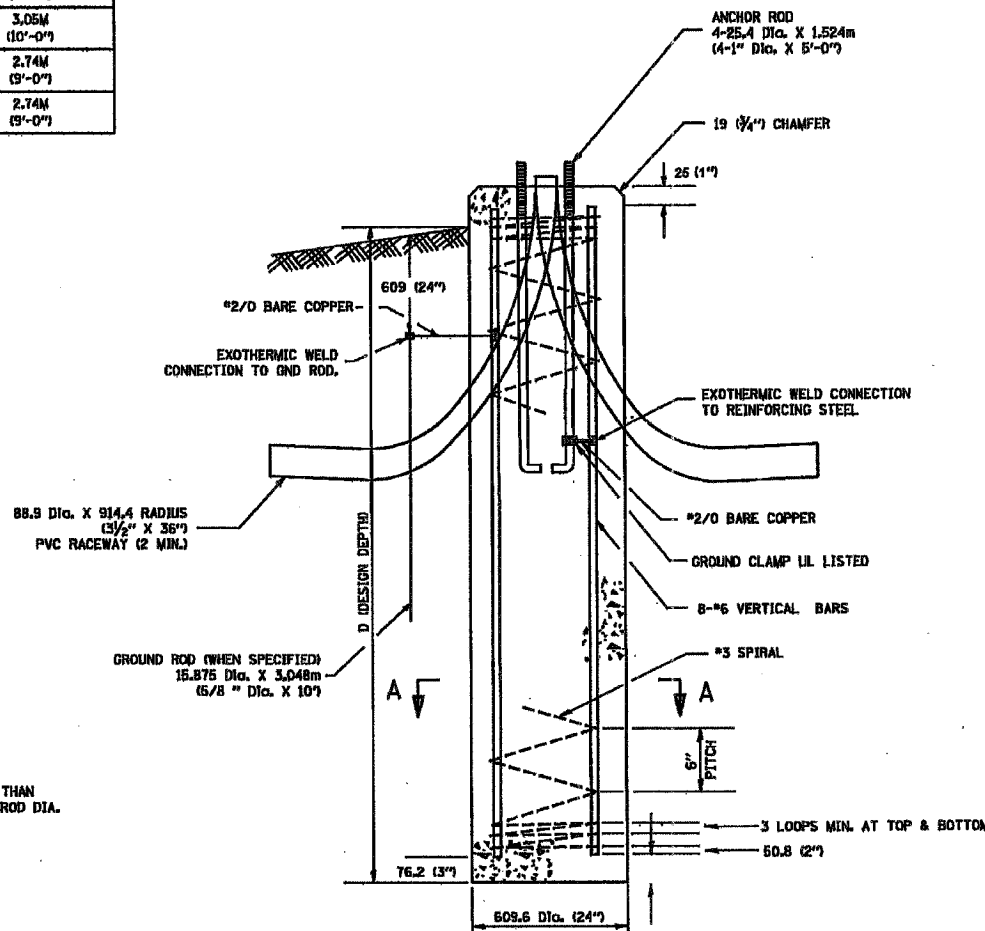

FOUNDATION DETAIL

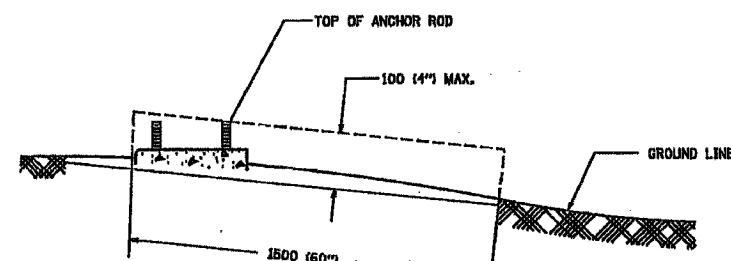

FOUNDATION EXTENSION DETAIL

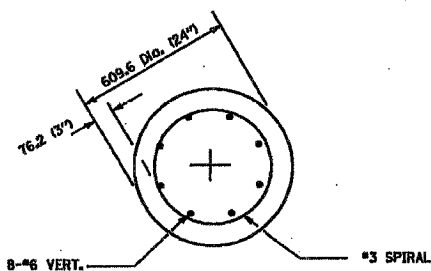

SECTION A-A

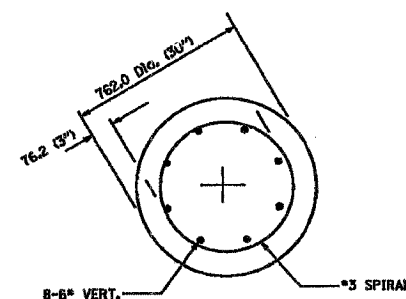

SECTION A-A

PLANT DATE: 2/15/2006
 FILE NAME: 2006032401.dwg
 USER: JMM
 PLOT NAME: 2006032401.dwg

| REVISIONS | |
|-----------|----------|
| NAME | DATE |
| NOTE 15 | 07/21/06 |
| | |
| | |
| | |
| | |
| | |
| | |
| | |
| | |
| | |

ILLINOIS DEPARTMENT OF TRANSPORTATION
 LIGHT POLE FOUNDATION
 12.192M (40') TO 14.478M (47 1/2') M.H.
 381 (15") BOLT CIRCLE

SCALE: NONE
 DATE: 7/21/2006

DRAWN BY
 CHECKED BY
 BE301
 REVISION DATE: 04/22/02

SINGH
 SINGH & ASSOCIATES, INC.
 CONSULTING ENGINEERS