

STATE OF ILLINOIS
DEPARTMENT OF TRANSPORTATION

ROUTE NO.	SECTION	COUNTY	TOTAL SHEETS	SHEET NO.
FAI-55	**	WILL	505	310
FED. ROAD DIST. NO. 7	ILLINOIS	FED. AID PROJECT		

SHEET NO. 13
44 SHEETS

** SECTION 2006-032 BY
CONTRACT NO. 60B86

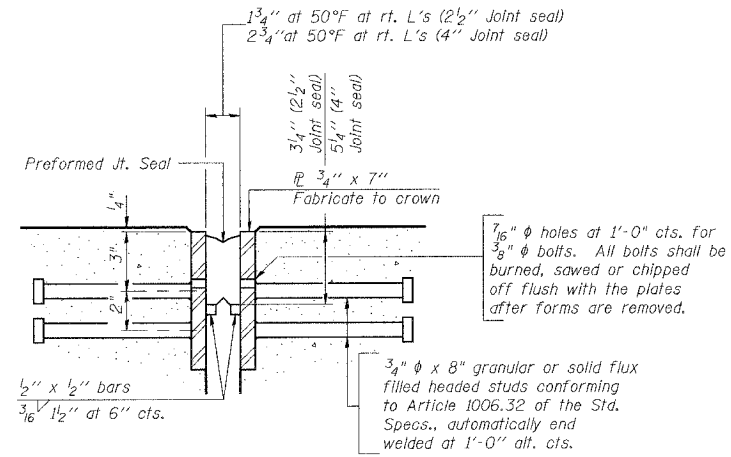

SECTION THRU EXPANSION JOINT

(288 Studs Required for SB Bridge)
(272 Studs Required for NB Bridge)

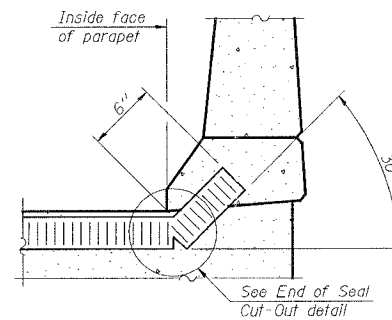

AT PARAPET

(Showing seal)

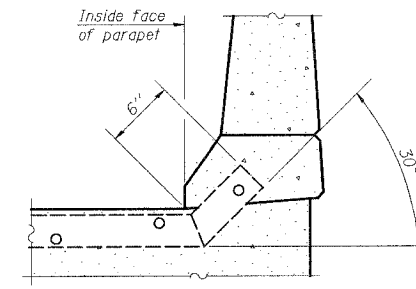

AT PARAPET

(Showing plate)

GENERAL NOTES

- Furnish steel plates in segments of 20 feet maximum length. Maximum space between installed segments shall be 3/16". Seal space with silicone sealant suitable for structural steel.

Bridge Joint System (Expansion)		
Design Movement	Required Preformed Joint Seal Size	Required Strip Seal Rated movement
1"	2 1/2"	1"
1 5/8"	4"	2"

TYPICAL END TREATMENTS

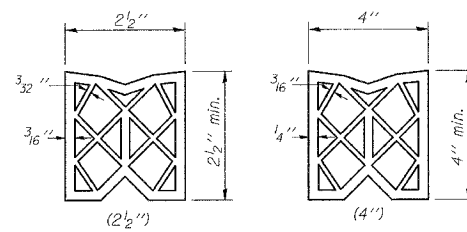

PREFORMED JOINT SEAL

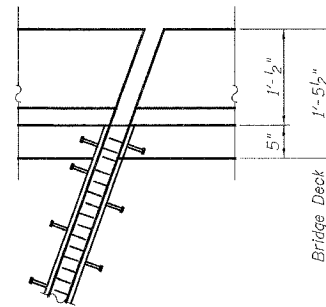

PLAN AT MEDIAN PARAPETS

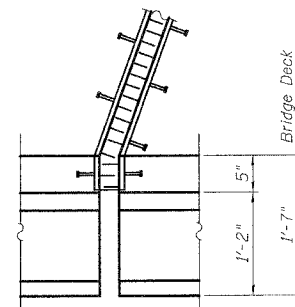

PLAN AT OUTSIDE PARAPETS

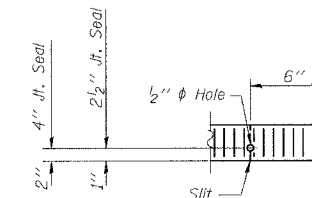

END OF SEAL CUT-OUT

**SB BRIDGE
BILL OF MATERIAL**

Item	Unit	Total
Bridge Joint System (Expansion), 1"	Foot	71.1
Bridge Joint System (Expansion), 1 5/8"	Foot	71.1

**NB BRIDGE
BILL OF MATERIAL**

Item	Unit	Total
Bridge Joint System (Expansion), 1"	Foot	66.6
Bridge Joint System (Expansion), 1 5/8"	Foot	66.6

(Sheet 1 of 2)
**BRIDGE JOINT SYSTEM - EXPANSION
(PREFORMED JOINT SEAL)**
I-55 OVER EJ&E R.R.
FAI ROUTE 55-SEC. 2006-032 BY
WILL COUNTY
STA. 609+29.37
STRUCTURE NO. 099-0018 (NB)
STRUCTURE NO. 099-0019 (SB)



DESIGNED	S.CHELBIAN
CHECKED	J.GRAINAWI
DRAWN	S.CHELBIAN
CHECKED	J.GRAINAWI

Date: 6/30/2006