

INDEX OF PLANS

SHEET NO.	DESCRIPTION
1	TITLE SHEET
2	TYPICAL SECTIONS, SUMMARY OF QUANTITIES, GENERAL NOTES, MISCELLANEOUS DETAILS
3	MISCELLANEOUS DETAILS AND SCHEDULES

F.A.S.	SECTION	COUNTY	TOTAL SHEETS	SHEET NO.
1884	07-00063-00-RS	EDWARDS	3	1
FED. ROAD DIST. NO. 7		ILLINOIS	RED HILL ROAD SOUTH	
CONTRACT NO. 95664				

STATE OF ILLINOIS
DEPARTMENT OF TRANSPORTATION
DIVISION OF HIGHWAYS

**PLANS FOR THE PROPOSED IMPROVEMENT OF FEDERAL AID
SECONDARY ROUTE FUNDS**

EDWARDS CO.

SECTION: 07-00063-00-RS ROUTE: FAS 1884

PROJECT NO. RS-1884(114) JOB NO. C-97-080-10

I.D.O.T. HIGHWAY STANDARDS

- 000001-06, STANDARD SYMBOLS, ABBREVIATIONS & PATTERNS
- 406201-01, MAILBOX TURNOUT
- 701006-03, OFF-RD OPERATIONS 2L, 2W, 4.5 m (15') TO PAVEMENT EDGE FOR SPEEDS ≥ 45 MPH
- 701301-04, LANE CLOSURE 2L, 2W, SHORT TIME OPERATIONS
- 701306-03, LANE CLOSURE 2L, 2W, SLOW MOVING OPERATIONS-DAY ONLY OR SPEEDS ≥ 45MPH
- 701311-03, LANE CLOSURE 2L, 2W MOVING OPERATIONS-DAY ONLY
- 701336-06, LANE CLOSURE 2L, 2W, WORK AREAS IN SERIES FOR SPEEDS ≥ 45 MPH
- 701901-01, TRAFFIC CONTROL DEVICES
- 780001-02, TYPICAL PAVEMENT MARKINGS
- 781001-03, TYPICAL APPLICATIONS RAISED REFLECTIVE MARKERS

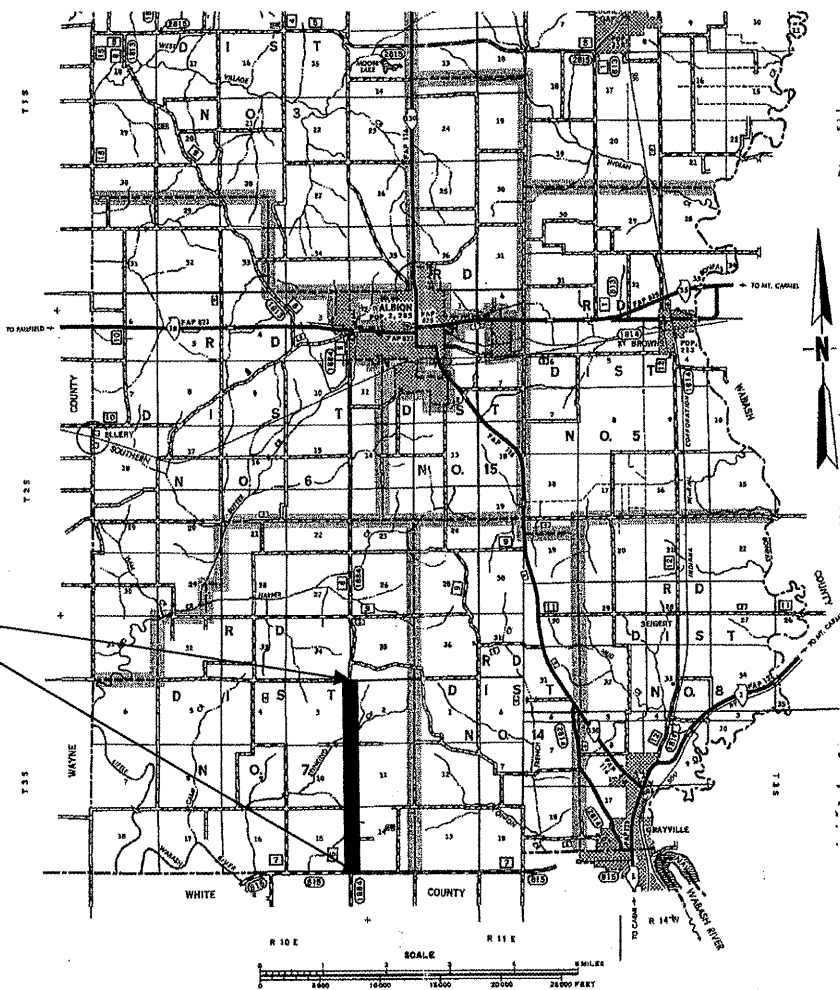

SECTION 07-00063-00-RS
BEGINS STA 288+00
ENDS STA 443+82



GROSS LENGTH: 15,582 FT 2.95 MI
OMISSION: 0.00 FT 0.00 MI
NET LENGTH: 15,582 FT 2.95 MI

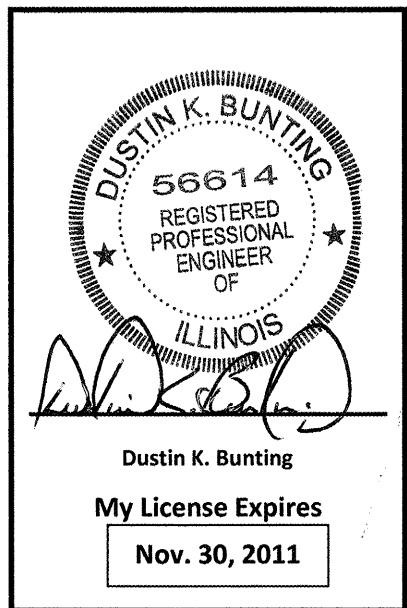

STATE OF ILLINOIS
DEPARTMENT OF TRANSPORTATION

APPROVED July 18 20 11
Dustin K. Bunting
COUNTY ENGINEER

PASSED 7-26-11 20
Maureen Keating
DISTRICT SEVEN ENGINEER OF
LOCAL ROADS & STREETS

Releasing For
Bid Based on
Limited Review 7-26-11 20
Tom L. Dickel
DEPUTY DIRECTOR OF HIGHWAYS,
REGION FOUR ENGINEER

CONTRACT NO. 95664
DESIGN CLASS – MAJOR COLLECTOR
CURRENT ADT = 400
DESIGN SPEED = 50 MPH

F.A.S.	SECTION	COUNTY	TOTAL SHEETS	SHEET NO.
1884	07-00063-00-RS	EDWARDS	3	2
FED. ROAD DIST. NO. 7		ILLINOIS	RED HILL ROAD SOUTH	
CONTRACT NO. 95664				

TYPICAL CROSS SECTION EXISTING

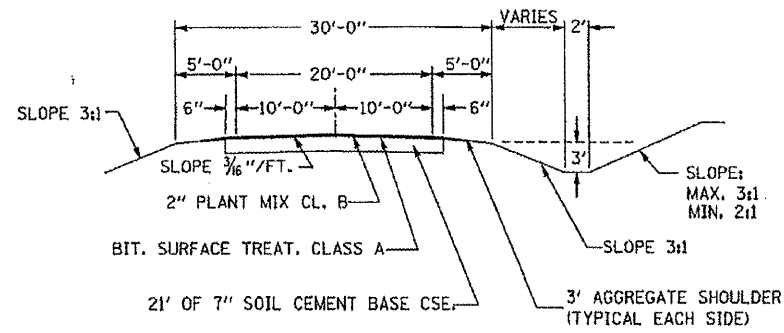

TYPICAL CROSS SECTION PROPOSED

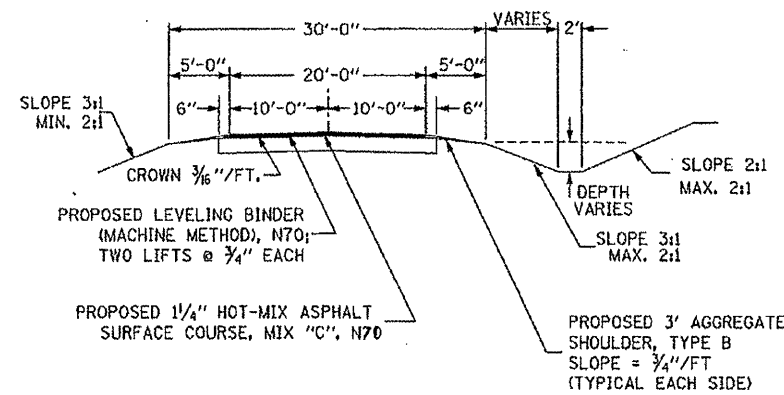

GENERAL NOTES

THIS SECTION CONSISTS OF PAVEMENT REMOVAL AND REPLACEMENT SPECIAL, LEVELING BINDER (MACHINE METHOD), N70, AND HOT-MIX ASPHALT SURFACE COURSE, MIX "C", N70, AGGREGATE SHOULDERS, AND OTHER MISCELLANEOUS ITEMS NECESSARY TO COMPLETE THE PROJECT, ALL IN ACCORDANCE WITH THE PLANS, SPECIAL PROVISIONS AND "STANDARD SPECIFICATIONS FOR ROAD AND BRIDGE CONSTRUCTION" ADOPTED JANUARY 1, 2007.

THE EXISTING GRADE, ALIGNMENT, DRAINAGE STRUCTURES, BASE AND SURFACE WERE CONSTRUCTED UNDER SECTIONS 28-1Q AND 28-26, 87-00044-00-RS AND 89-00045-00-RS AND SHALL REMAIN IN PLACE, ALL STATIONS REFERRED TO IN THE PLANS AND PROPOSAL ARE REFERENCED TO THE ABOVE MENTIONED SECTIONS.

- MAXIMUM PERCENT OF GRADE +7.00%
- MINIMUM STOPPING SIGHT DISTANCE 373 FT
- DESIGN SPEED 50 MPH
- CURRENT ADT 400 VPD
- DESIGN ADT (20 YR) 500 VPD

THE HOT-MIX ASPHALT SURFACE COURSE, MIX "C", N70 SHALL BE PLACED IN ONE LIFT WITH A MINIMUM THICKNESS OF 1 1/4".

THE QUANTITY SHOWN IN THE SUMMARY OF QUANTITIES FOR HOT-MIX ASPHALT SURFACE COURSE, MIX "C", N70 ALLOWS 96.3 TON FOR THE INTERSECTION, SIDEROADS, AND TAPER; 36 TON FOR THE ENTRANCES; 52 TON FOR THE MAILBOX TURNOUTS, AND 2424.3 TON FOR THE 1 1/4" HOT-MIX ASPHALT SURFACE COURSE, MIX "C", N70.

THE FOLLOWING RATES HAVE BEEN USED TO CALCULATE PLAN QUANTITIES:

- AGGREGATE SHOULDERS, TY B 1.8 T/CU YD
- HOT-MIX ASPHALT 0.0560 T/SQ YD*IN
- BITUMINOUS MATERIALS (PRIME COAT) 0.05 GAL/SQ YD

THE QUANTITY SHOWN IN THE SUMMARY OF QUANTITIES FOR GRADING AND SHAPING DITCHES ALLOWS 50 FOOT AT EACH END OF ALL PIPES TO BE REPLACED AT STATIONS SHOWN IN SCHEDULE OF AR PIPE CULVERTS, CLASS A.

SUMMARY OF QUANTITIES

QUANTITY	UNIT	ITEM	CODE NUMBER
400	FOOT	GRADING AND SHAPING DITCHES	21400100
1978	GALLON	BITUMINOUS MATERIALS (PRIME COAT)	40600100
3550	TON	LEVELING BINDER (MACHINE METHOD), N70	40600635
2609	TON	HOT-MIX ASPHALT SURFACE COURSE, MIX "C", N70	40603315
778	SQ YD	HOT-MIX ASPHALT SURFACE REMOVAL, 2 3/4"	44000160
1250	TON	AGGREGATE SHOULDERS, TYPE B	48101200
86	FOOT	PIPE CULVERTS, CLASS A, TYPE 1 36"	542A0241
128	FOOT	PIPE CULVERTS, CLASS A, TYPE 2 30"	542A1075
74	FOOT	PIPE CULVERTS, CLASS A, TYPE 2 42"	542A1087
1	L SUM	MOBILIZATION	67100100
1	L SUM	TRAFFIC CONTROL AND PROTECTION, STANDARD 701306	70100460
1	L SUM	TRAFFIC CONTROL AND PROTECTION, STANDARD 701336	70100600
4675	FOOT	SHORT-TERM PAVEMENT MARKING	70300100
49618	FOOT	PAINT PAVEMENT MARKING-LINE 4"	78001110*
200	EACH	RAISED REFLECTIVE PAVEMENT MARKER	78100100*
1558	FOOT	SHORT-TERM PAVEMENT MARKING REMOVAL	XX003140
118	TON	PAVEMENT REMOVAL AND REPLACEMENT (SPECIAL)	XX127400

NOTE: SEEDING TO BE DONE BY OTHERS

* SPECIALTY ITEMS

DETAIL OF PRIVATE AND FIELD ENTRANCES

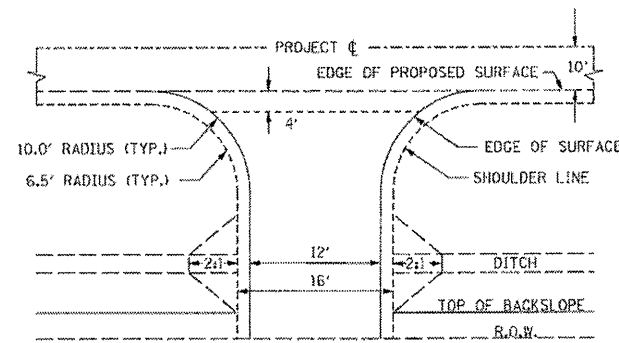

NOTE: THE 4' AREA FROM THE EDGE OF SURFACE, AS SHOWN ABOVE, SHALL BE HOT-MIX ASPHALT SURFACE COURSE, MIX "C", N70 FOR THE PRIVATE ENTRANCES AND THE FIELD ENTRANCES. THIS QUANTITY IS INCLUDED IN THE QUANTITY FOR HOT-MIX ASPHALT SURFACE COURSE, MIX "C", N70.

PRIVATE & FIELD ENTRANCE APPROACH DETAIL

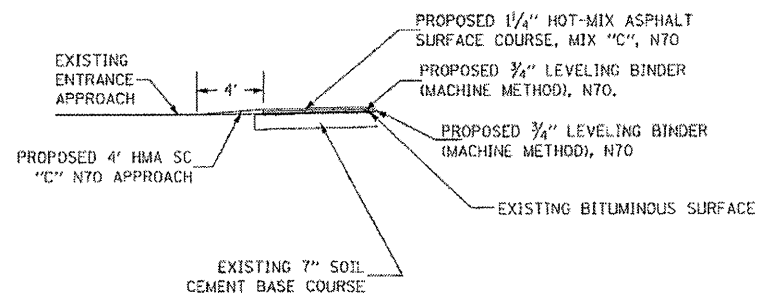

AGGREGATE SHOULDER DETAIL

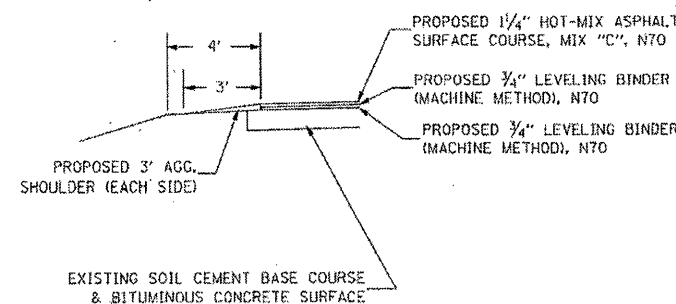

SCHEDULE FOR SUPERELEVATION RATES

CURVE #1

TANGENT RUNOFF BEGINS STA. 288+50.38
 S.E. RUNOFF BEGINS STA. 288+83.38
 FULL S.E. BEGINS STA. 289+16.38
 FULL S.E. ENDS STA. 294+76.61
 S.E. RUNOFF ENDS STA. 295+09.61
 TANGENT RUNOFF ENDS STA. 295+42.61
 S.E. RATE = 0.02 FT/FT

SURFACE REMOVAL TRANSITION DETAIL

BEGIN STA 330+92.9 END STA 332+75.9
 BEGIN STA 391+19.5 END STA 392+91.5

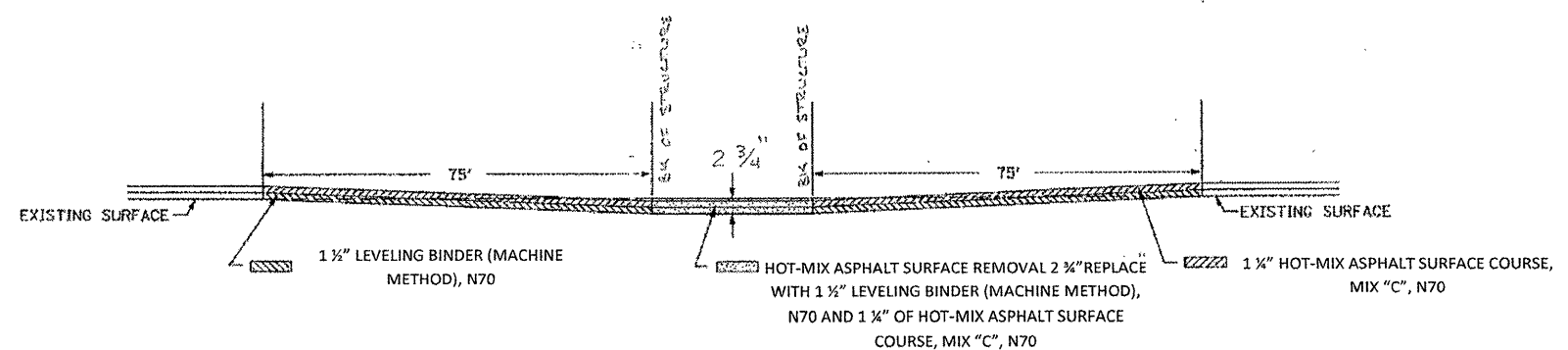

UTILITIES

WAYNE-WHITE ELECTRIC COOP.
 RT. 45 WEST
 FAIRFIELD, IL 62837
 618-842-2196

ELLERY WATER CORP.
 P.O. BOX 45
 ALBION, IL 62806
 618-445-4050

VERIZON TELEPHONE CO.
 225 EAST CHESTNUT
 ONLEY, IL 62450
 618-395-6191

J.U.L.I.E.
 800-892-0123

DETAIL OF INTERSECTION & SIDEROADS

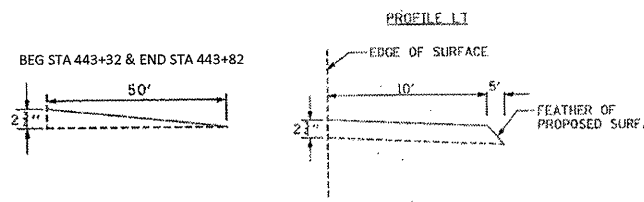
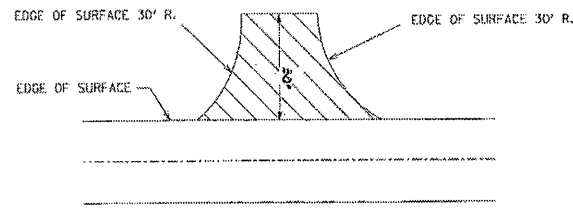

DETAIL OF TAPER STA. 288+00 TO STA. 288+50

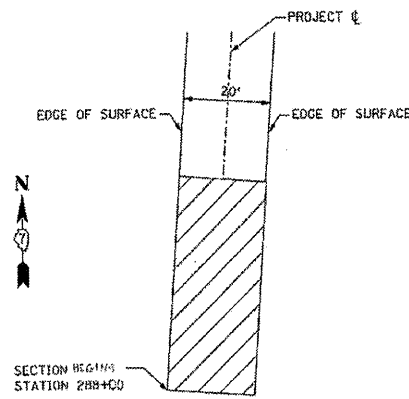

NOTE: THE QUANTITY SHOWN FOR HOT-MIX ASPHALT SURFACE COURSE, MIX "C", N50 INCLUDES 8.8 TONS OF MATERIAL FOR THE TAPER FROM STATION 288+00 TO STATION 288+50.

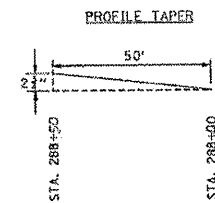

DETAIL OF PAVEMENT REMOVAL AND REPLACEMENT SPECIAL

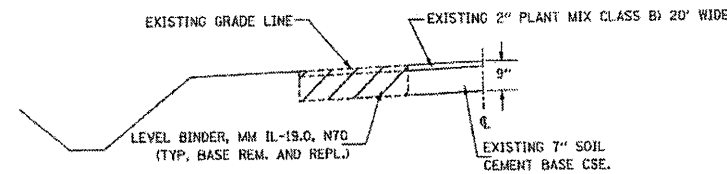

NOTE: IN THE TYPICAL DETAIL ABOVE THE DISTANCE FROM THE CENTERLINE LEFT OR RIGHT AND THE WIDTH OF PAVEMENT REMOVAL AND REPLACEMENT VARIES. SEE SCHEDULE OF PAVEMENT REMOVAL AND REPLACEMENT SPECIAL FOR PROPOSED LOCATIONS. SEE DETAIL OF ACROSS ROAD CULVERT PIPES

F.A.S.	SECTION	COUNTY	TOTAL SHEETS	SHEET NO.
1884	07-00063-00-RS	EDWARDS	3	3
FED. ROAD DIST. NO. 7		ILLINOIS	RED HILL ROAD SOUTH	
CONTRACT NO. 95664				

DETAIL OF ACROSS ROAD CULVERT PIPES

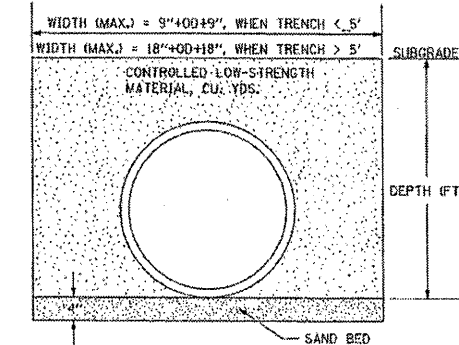

PROPOSED TYPICAL CROSS SECTION AT PIPE CULVERTS

FOR PAVEMENT REMOVAL AND REPLACEMENT (SPECIAL) SEE SCHEDULE

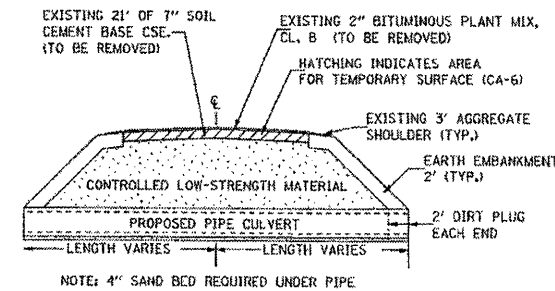

SCHEDULE OF PAV'T REMOVAL AND REPLACEMENT SPECIAL

STATION TO STATION	LOCATION	WIDTH (FEET)	SQ. YD.	TON
316+75	PIPE CULVERT	24	18.7	9.4
369+35	PIPE CULVERT	24	16	8.1
372+23	PIPE CULVERT	24	16	8.1
383+85	386+45 LT. EDGE	5	144.4	72.8
401+83	402+33 LT. EDGE	4	22.2	11.2
430+54	PIPE CULVERT	24	17.3	8.7
				118.3

THE SCHEDULE ABOVE REFLECTS APPROXIMATE LOCATION AND ESTIMATED QUANTITIES. THE ACTUAL AREAS SHALL BE LOCATED AND MARKED BY THE ENGINEER PRIOR TO CONSTRUCTION. THE ABOVE QUANTITY IS INCLUDED IN PAVEMENT REMOVAL AND REPLACEMENT SPECIAL IN THE SUMMARY OF QUANTITIES.

SCHEDULE OF PRIVATE AND FIELD ENTRANCES

STATION	LOCATION	EST. QUANTITY ALLOWED TONS
300+25	RT	3
353+10	LT	3
354+00	RT	3
360+80	LT	3
367+40	LT	3
375+30	LT	3
375+75	RT	3
377+00	RT	3
389+90	RT	3
404+80	LT	3
423+50	RT	3
441+70	LT	3
		36

THE ABOVE QUANTITY IS INCLUDED IN THE HOT-MIX ASPHALT SURFACE COURSE, MIX "C", N70 IN THE SUMMARY OF QUANTITIES.

SCHEDULE OF AR PIPE CULVERTS, CLASS A

STATION	SIZE	LENGTH	TYPE	SKEW	CLSM	TEMPORARY SURFACE (CA 6)
316+75	42"	74'	2	25°	49.3 CY	4 T
369+35	30"	62'	2	0°	43.9 CY	4 T
372+23	30"	66'	2	0°	63.7 CY	4 T
430+54	36"	86'	1	45°	34.7 CY	4 T

CULVERT FLOWLINES SHALL MATCH EXISTING FLOWLINES.

SCHEDULE OF MAILBOX TURNOUTS

STATION	LOCATION	EST. QUANTITY ALLOWED TONS
288+80	RT	4
299+94	RT	4
299+96	RT	4
339+00	RT	4
353+00	RT	4
356+20	RT	4
360+85	RT	4
367+40	RT	4
375+30	RT	4
376+85	RT	4
404+80	RT	4
423+85	RT	4
441+50	RT	4
		52

THE ABOVE QUANTITY IS INCLUDED IN THE HOT-MIX ASPHALT SURFACE COURSE, MIX "C", N70 IN THE SUMMARY OF QUANTITIES.

SCHEDULE OF PAVEMENT MARKINGS

STATION TO STATION	LOC.	LENGTH-FOOT
288+02	443+82 CENTERLINE	CL 2546
288+02	338+86 EDGELINE	RT 5084
339+44	391+48	RT 5204
392+06	443+82	RT 5176
288+02	338+86 EDGELINE	LT 5084
339+44	417+88	LT 7844
418+46	443+82	LT 2536
288+02	296+98 NO PASSING	RT 896
288+02	314+50	LT 2648
331+00	340+00	RT 900
340+00	349+00	LT 900
370+00	424+00	RT 5400
379+00	433+00	LT 5400
		TOTAL 49,618

THE ABOVE QUANTITY IS SHOWN IN THE PAVEMENT MARKING-LINE 4" IN THE SUMMARY OF QUANTITIES.