

BID PROPOSAL INSTRUCTIONS

ABOUT IDOT PROPOSALS: All proposals are potential bidding proposals. Each proposal contains all certifications and affidavits, a proposal signature sheet and a proposal bid bond.

PREQUALIFICATION

Any contractor who desires to become pre-qualified to bid on work advertised by IDOT must submit the properly completed pre-qualification forms to the Bureau of Construction no later than 4:30 p.m. prevailing time twenty-one days prior to the letting of interest. This pre-qualification requirement applies to first time contractors, contractors renewing expired ratings, contractors maintaining continuous pre-qualification or contractors requesting revised ratings. To be eligible to bid, existing pre-qualification ratings must be effective through the date of letting.

WHO CAN BID ?

Bids will be accepted from only those companies that request and receive written Authorization to Bid from IDOT's Central Bureau of Construction.

REQUESTS FOR AUTHORIZATION TO BID

Contractors wanting to bid on items included in a particular letting must submit the properly completed "Request for Authorization to Bid/or Not For Bid Status" (BDE 124) and the ORIGINAL "Affidavit of Availability" (BC 57) to the proper office no later than 4:30 p.m. prevailing time, three (3) days prior to the letting date.

WHAT CONSTITUTES WRITTEN AUTHORIZATION TO BID?

When a prospective prime bidder submits a "Request for Authorization to Bid/or Not For Bid Status"(BDE 124) he/she must indicate at that time which items are being requested For Bidding purposes. Only those items requested For Bidding will be analyzed. After the request has been analyzed, the bidder will be issued an **Authorization to Bid or Not for Bid Report**, approved by the Central Bureau of Construction and the Chief Procurement Officer that indicates which items have been approved For Bidding. If **Authorization to Bid** cannot be approved, the **Authorization to Bid or Not for Bid Report** will indicate the reason for denial.

ABOUT AUTHORIZATION TO BID

Firms that have not received an Authorization to Bid or Not For Bid Report within a reasonable time of complete and correct original document submittal should contact the Department as to the status. Firms unsure as to authorization status should call the Prequalification Section of the Bureau of Construction at the number listed at the end of these instructions.

ADDENDA AND REVISIONS

It is the bidder's responsibility to determine which, if any, addenda or revisions pertain to any project they may be bidding. Failure to incorporate all relevant addenda or revisions may cause the bid to be declared unacceptable.

Each addendum or revision will be included with the Electronic Plans and Proposals. Addenda and revisions will also be placed on the Addendum/Revision Checklist and each subscription service subscriber will be notified by e-mail of each addendum and revision issued.

The Internet is the Department's primary way of doing business. The subscription service emails are an added courtesy the Department provides. It is suggested that bidders check IDOT's website at <http://www.idot.illinois.gov/doing-business/procurements/construction-services/construction-bulletins/transportation-bulletin/index#TransportationBulletin> before submitting final bid information.

IDOT IS NOT RESPONSIBLE FOR ANY E-MAIL FAILURES.

Addenda questions may be directed to the Contracts Office at (217)782-7806 or DOT.DE-Contracts@illinois.gov

Technical questions about downloading these files may be directed to Tim Garman at (217)524-1642 or Timothy.Garman@illinois.gov.

STANDARD GUIDELINES FOR SUBMITTING PAPER BIDS

- All pages should be single sided.
- Use the Cover Page that is provided in the Bid Proposal (posted on the IDOT Web Site) as the first page of your submitted bid. It has the item number in large bold type in the upper left-hand corner and lines provided for your company name and address in the upper right-hand corner.
- Do not use report covers, presentation folders or special bindings and do not staple multiple times on left side like a book. Use only 1 staple in the upper left hand corner. Make sure all elements of your bid are stapled together including the bid bond or guaranty check (if required).
- **Do not include any certificates of eligibility, your authorization to bid, Addendum Letters or affidavit of availability.**
- Do not include the Subcontractor Documentation with your bid (pages i – iii and pages a – g). This documentation is required only if you are awarded the project.
- Use the envelope cover sheet (provided with the proposal) as the cover for the proposal envelope.
- Do not rely on overnight services to deliver your proposal prior to 10 AM on letting day. It will not be read if it is delivered after 10 AM.
- Do not submit your Substance Abuse Prevention Program (SAPP) with your bid. If you are awarded the contract this form is to be submitted to the district engineer at the pre-construction conference.

BID SUBMITTAL CHECKLIST

- Cover page** (the sheet that has the item number on it) – This should be the first page of your bid proposal, **followed by your bid (the Schedule of Prices/Pay Items)**. If you are using special software or CBID to generate your schedule of prices, do not include the blank pages of the schedule of prices that came with the proposal package.
- Page 4 (Item 9)** – Check “YES” if you will use a subcontractor(s) with an annual value over \$50,000. Include the subcontractor(s) name, address, general type of work to be performed and the dollar amount. If you will use subcontractor(s) but are uncertain who or the dollar amount; check “YES” but leave the lines blank.
- After page 4** – Insert the following documents: Cost Adjustments for Steel, Bituminous and Fuel (if applicable) and the Contractor Letter of Assent (if applicable). The general rule should be, if you don’t know where it goes, put it after page 4.
- Page 10 (Paragraph J)** – Check “YES” or “NO” whether your company has any business in Iran.
- Page 10 (Paragraph K)** – (Not applicable to federally funded projects) List the name of the apprenticeship and training program sponsor holding the certificate of registration from the US Department of Labor. If no applicable program exists, please indicate the work/job category. **Do not include certificates with your bid.** Keep the certificates in your office in case they are requested by IDOT.
- Page 11 (Paragraph L)** – Your State Board of Elections certificate of registration is no longer required with your bid.
- Page 11 (Paragraph M)** – Indicate if your company has hired a lobbyist in connection with the job for which you are submitting the bid proposal.
- Page 12 (Paragraph C)** – This is a work sheet to determine if a completed Form A is required. It is not part of the form and you do not need to make copies for each completed Form A.
- Pages 14-17 (Form A)** – One Form A (4 pages) is required for each applicable person in your company. Copies of the forms can be used and only need to be changed when the information changes. The certification signature and date must be original for each letting. **Do not staple the forms together.** If you answered “NO” to all of the questions in Paragraph C (page 12), complete the first section (page 14) with your company information and then sign and date the Not Applicable statement on page 17.
- Page 18 (Form B)** - If you check “YES” to having other current or pending contracts it is acceptable to use the phrase, “See Affidavit of Availability on file”. **Ownership Certification** (at the bottom of the page) - Check N/A if the Form A(s) you submitted accounts for 100 percent of the company ownership. Check YES if any percentage of ownership falls outside of the parameters that require reporting on the Form A. Checking NO indicates that the Form A(s) you submitted is not correct and you will be required to submit a revised Form A.
- Page 20 (Workforce Projection)** – Be sure to include the Duration of the Project. It is acceptable to use the phrase “Per Contract Specifications”.

- Proposal Bid Bond** – (Insert after the proposal signature page) Submit your Proposal Bid Bond (if applicable) using the current Proposal Bid Bond form provided in the proposal package. The Power of Attorney page should be stapled to the Proposal Bid Bond. If you are using an electronic bond, include your bid bond number on the Proposal Bid Bond and attach the Proof of Insurance printed from the Surety’s Web Site.
- Disadvantaged Business Utilization Plan and/or Good Faith Effort – Do Not Submit with Bid** The bidder shall submit a Disadvantaged Business Utilization Plan on completed Department forms SBE 2025 and 2026. (1) The final Utilization Plan must be submitted within five calendar days after the date of the letting. (2) To meet the five day requirement, the bidder may send the Utilization Plan electronically by scanning and sending to DOT.DBE.UP@illinois.gov or faxing to (217) 785-1524. The subject line must include the bid Item Number and the Letting date. The Utilization Plan should be sent as one .pdf file, rather than multiple files and emails for the same Item Number. It is the responsibility of the bidder to obtain confirmation of email or fax delivery.

Alternatively, the Utilization Plan may be sent by certified mail or delivery service within the five calendar day period. If a question arises concerning the mailing date of a Utilization Plan, the mailing date will be established by the U.S. Postal Service postmark on the certified mail receipt from the U.S. Postal Service or the receipt issued by a delivery service. It is the responsibility of the bidder to ensure the postmark or receipt date is affixed within the five days if the bidder intends to rely upon mailing or delivery to satisfy the submission day requirement. The Utilization Plan is to be submitted to:

Illinois Department of Transportation
 Bureau of Small Business Enterprises
 Contract Compliance Section
 2300 South Dirksen Parkway, Room 319
 Springfield, Illinois 62764

The Bid Letting is now available in streaming Audio/Video from the IDOT Web Site. A link to the stream will be placed on the main page of the current letting on the day of the Letting. The stream will not begin until 10 AM.

Following the Letting, the As-Read Tabulation of Bids will be posted by the end of the day. You will find the link on the main Web page for the current letting.

QUESTIONS: pre-letting up to execution of the contract

Contractor pre-qualification	217-782-3413
Small Business, Disadvantaged Business Enterprise (DBE)	217-785-4611
Contracts, Bids, Letting process or Internet downloads	217-782-7806
Estimates Unit.....	217-785-3483
Aeronautics.....	217-785-8515
IDNR (Land Reclamation, Water Resources, Natural Resources).....	217-782-6302

QUESTIONS: following contract execution

Subcontractor documentation, payments	217-782-3413
Railroad Insurance	217-785-0275

47

RETURN WITH BID

Proposal Submitted By
Name
Address
City

Letting November 4, 2016

NOTICE TO PROSPECTIVE BIDDERS

This proposal can be used for bidding purposes by only those companies that request and receive written AUTHORIZATION TO BID from IDOT's Central Bureau of Construction.

BIDDERS NEED NOT RETURN THE ENTIRE PROPOSAL

Notice to Bidders, Specifications, Proposal, Contract and Contract Bond



**Illinois Department
of Transportation**

Springfield, Illinois 62764

**Contract No. 64L73
HENRY County
Section D2 RS 2017-2
Routes FAU 5862 & 5863
District 2 Construction Funds**

PLEASE MARK THE APPROPRIATE BOX BELOW:

- A Bid Bond is included.
- A Cashier's Check or a Certified Check is included.
- An Annual Bid Bond is included or is on file with IDOT.

Plans Included
Herein

Prepared by

S

Checked by

(Printed by authority of the State of Illinois)

Page intentionally left blank

RETURN WITH BID



PROPOSAL

TO THE DEPARTMENT OF TRANSPORTATION

1. Proposal of _____

Taxpayer Identification Number (Mandatory) _____

For the improvement identified and advertised for bids in the Invitation for Bids as:

**Contract No. 64L73
HENRY County
Section D2 RS 2017-2
Routes FAU 5862 & 5863
District 2 Construction Funds**

This project consists of HMA resurfacing on Poppy Garden Road from IL 84 to Green River Road and on Green River Road from Exchange Street to US 6.

2. The undersigned bidder will furnish all labor, material and equipment to complete the above described project in a good and workmanlike manner as provided in the contract documents provided by the Department of Transportation. This proposal will become part of the contract and the terms and conditions contained in the contract documents will govern performance and payments.

RETURN WITH BID

3. **ASSURANCE OF EXAMINATION AND INSPECTION/WAIVER.** The undersigned bidder further declares that he/she has carefully examined the proposal, plans, specifications, addenda, form of contract and contract bond, and special provisions, and that he/she has inspected in detail the site of the proposed work, and that he/she has familiarized themselves with all of the local conditions affecting the contract and the detailed requirements of construction, and understands that in making this bid proposal he/she waives all right to plead any misunderstanding regarding the same.
4. **EXECUTION OF CONTRACT AND CONTRACT BOND.** The undersigned bidder further agrees to execute a contract for this work and present the same to the department within fifteen (15) days after the contract has been mailed to him/her. The undersigned further agrees that he/she and his/her surety will execute and present within fifteen (15) days after the contract has been mailed to him/her contract bond satisfactory to and in the form prescribed by the Department of Transportation, in the penal sum of the full amount of the contract, or as specified in the special provisions, guaranteeing the faithful performance of the work in accordance with the terms of the contract.
5. **PROPOSAL GUARANTY.** Accompanying this proposal is either a bid bond on the department form, executed by a corporate surety company satisfactory to the department, or a proposal guaranty check consisting of a bank cashier's check or a properly certified check for not less than 5 per cent of the amount bid or for the amount specified in the following schedule:

<u>Amount of Bid</u>	<u>Proposal Guaranty</u>	<u>Amount of Bid</u>	<u>Proposal Guaranty</u>
Up to \$5,000	to \$150	\$2,000,000	to \$100,000
\$5,000	to \$300	\$3,000,000	to \$150,000
\$10,000	to \$1,000	\$5,000,000	to \$250,000
\$50,000	to \$3,000	\$7,500,000	to \$400,000
\$100,000	to \$5,000	\$10,000,000	to \$500,000
\$150,000	to \$7,500	\$15,000,000	to \$600,000
\$250,000	to \$12,500	\$20,000,000	to \$700,000
\$500,000	to \$25,000	\$25,000,000	to \$800,000
\$1,000,000	to \$50,000	\$30,000,000	to \$900,000
\$1,500,000	to \$75,000	over \$35,000,000	\$1,000,000

Bank cashier's checks or properly certified checks accompanying bid proposals will be made payable to the Treasurer, State of Illinois.

If a combination bid is submitted, the proposal guaranties which accompany the individual bid proposals making up the combination will be considered as also covering the combination bid.

The amount of the proposal guaranty check is _____ \$(_____). If this proposal is accepted and the undersigned will fail to execute a contract bond as required herein, it is hereby agreed that the amount of the proposal guaranty will become the property of the State of Illinois, and shall be considered as payment of damages due to delay and other causes suffered by the State because of the failure to execute said contract and contract bond; otherwise, the bid bond will become void or the proposal guaranty check will be returned to the undersigned.

Attach Cashier's Check or Certified Check Here

In the event that one proposal guaranty check is intended to cover two or more bid proposals, the amount must be equal to the sum of the proposal guaranties which would be required for each individual proposal. If the guaranty check is placed in another bid proposal, state below where it may be found.

The proposal guaranty check will be found in the bid proposal for: Item _____

Section No. _____

County _____

Mark the proposal cover sheet as to the type of proposal guaranty submitted.

RETURN WITH BID

6. **COMBINATION BIDS.** The undersigned bidder further agrees that if awarded the contract for the sections contained in the following combination, he/she will perform the work in accordance with the requirements of each individual contract comprising the combination bid specified in the schedule below, and that the combination bid shall be prorated against each section in proportion to the bid submitted for the same. If an error is found to exist in the gross sum bid for one or more of the individual sections included in a combination, the combination bid shall be corrected as provided in the specifications.

When a combination bid is submitted, the schedule below must be completed in each proposal comprising the combination.

If alternate bids are submitted for one or more of the sections comprising the combination, a combination bid must be submitted for each alternate.

Schedule of Combination Bids

Combination No.	Sections Included in Combination	Combination Bid	
		Dollars	Cents

7. **SCHEDULE OF PRICES.** The undersigned bidder submits herewith, in accordance with the rules and instructions, a schedule of prices for the items of work for which bids are sought. The unit prices bid are in U.S. dollars and cents, and all extensions and summations have been made. The bidder understands that the quantities appearing in the bid schedule are approximate and are provided for the purpose of obtaining a gross sum for the comparison of bids. If there is an error in the extension of the unit prices, the unit prices will govern. Payment to the contractor awarded the contract will be made only for actual quantities of work performed and accepted or materials furnished according to the contract. The scheduled quantities of work to be done and materials to be furnished may be increased, decreased or omitted as provided elsewhere in the contract.
8. **AUTHORITY TO DO BUSINESS IN ILLINOIS.** Section 20-43 of the Illinois Procurement Code (the Code) (30 ILCS 500/20-43) provides that a person (other than an individual acting as a sole proprietor) must be a legal entity authorized to transact business or conduct affairs in the State of Illinois prior to submitting the bid.
9. **EXECUTION OF CONTRACT:** The Department of Transportation will, in accordance with the rules governing Department procurements, execute the contract and shall be the sole entity having the authority to accept performance and make payments under the contract. Execution of the contract by the Chief Procurement Officer (CPO) or the State Purchasing Officer (SPO) is for approval of the procurement process and execution of the contract by the Department. Neither the CPO nor the SPO shall be responsible for administration of the contract or determinations respecting performance or payment there under except as otherwise permitted in the Code.

10. **The services of a subcontractor will be used.**

Check box Yes
 Check box No

For known subcontractors with subcontracts with an annual value of more than \$50,000, the contract shall include their name, address, general type of work to be performed, and the dollar allocation for each subcontractor. (30 ILCS 500/20-120)

CONTRACT NUMBER

64L73

THIS IS THE TOTAL BID

\$ _____

NOTES:

1. Each PAY ITEM should have a UNIT PRICE and a TOTAL PRICE.
2. The UNIT PRICE shall govern if no TOTAL PRICE is shown or if there is a discrepancy between the product of the UNIT PRICE multiplied by the QUANTITY.
3. If a UNIT PRICE is omitted, the TOTAL PRICE will be divided by the QUANTITY in order to establish a UNIT PRICE.
4. A bid may be declared UNACCEPTABLE if neither a unit price nor a total price is shown.

RETURN WITH BID

STATE REQUIRED ETHICAL STANDARDS GOVERNING CONTRACT PROCUREMENT: ASSURANCES, CERTIFICATIONS AND DISCLOSURES

I. GENERAL

A. Article 50 of the Code establishes the duty of all State CPOs, SPOs, and their designees to maximize the value of the expenditure of public moneys in procuring goods, services, and contracts for the State of Illinois and to act in a manner that maintains the integrity and public trust of State government. In discharging this duty, they are charged by law to use all available information, reasonable efforts, and reasonable actions to protect, safeguard, and maintain the procurement process of the State of Illinois.

B. In order to comply with the provisions of Article 50 and to carry out the duty established therein, all bidders are to adhere to ethical standards established for the procurement process, and to make such assurances, disclosures and certifications required by law. Except as otherwise required in subsection III, paragraphs J-M, by execution of the Proposal Signature Sheet, the bidder indicates that each of the mandated assurances have been read and understood, that each certification is made and understood, and that each disclosure requirement has been understood and completed.

C. In addition to all other remedies provided by law, failure to comply with any assurance, failure to make any disclosure or the making of a false certification shall be grounds for the CPO to void the contract, and may result in the suspension or debarment of the bidder or subcontractor. If a false certification is made by a subcontractor the contractor's submitted bid and the executed contract may not be declared void unless the contractor refuses to terminate the subcontract upon the State's request after a finding that the subcontractor's certification was false.

I acknowledge, understand and accept these terms and conditions.

II. ASSURANCES

The assurances hereinafter made by the bidder are each a material representation of fact upon which reliance is placed should the Department enter into the contract with the bidder.

A. **Conflicts of Interest**

Section 50-13. Conflicts of Interest.

(a) Prohibition. It is unlawful for any person holding an elective office in this State, holding a seat in the General Assembly, or appointed to or employed in any of the offices or agencies of state government and who receives compensation for such employment in excess of 60% of the salary of the Governor of the State of Illinois, or who is an officer or employee of the Capital Development Board or the Illinois State Toll Highway Authority, or who is the spouse or minor child of any such person to have or acquire any contract, or any direct pecuniary interest in any contract therein, whether for stationery, printing, paper, or any services, materials, or supplies, that will be wholly or partially satisfied by the payment of funds appropriated by the General Assembly of the State of Illinois or in any contract of the Capital Development Board or the Illinois State Toll Highway Authority.

(b) Interests. It is unlawful for any firm, partnership, association or corporation, in which any person listed in subsection (a) is entitled to receive (i) more than 7 1/2% of the total distributable income or (ii) an amount in excess of the salary of the Governor, to have or acquire any such contract or direct pecuniary interest therein.

(c) Combined interests. It is unlawful for any firm, partnership, association, or corporation, in which any person listed in subsection (a) together with his or her spouse or minor children is entitled to receive (i) more than 15%, in the aggregate, of the total distributable income or (ii) an amount in excess of 2 times the salary of the Governor, to have or acquire any such contract or direct pecuniary interest therein.

(d) Securities. Nothing in this Section invalidates the provisions of any bond or other security previously offered or to be offered for sale or sold by or for the State of Illinois.

(e) Prior interests. This Section does not affect the validity of any contract made between the State and an officer or employee of the State or member of the General Assembly, his or her spouse, minor child or any combination of those persons if that contract was in existence before his or her election or employment as an officer, member, or employee. The contract is voidable, however, if it cannot be completed within 365 calendar days after the officer, member, or employee takes office or is employed. The current salary of the Governor is \$177,412.00. Sixty percent of the salary is \$106,447.20.

RETURN WITH BID

The bidder assures the Department that the award and execution of the contract would not cause a violation of Section 50-13, or that an effective exemption has been issued by the Board of Ethics to any individual subject to the Section 50-13 prohibitions pursuant to the provisions of Section 50-20 of the Code. Information concerning the exemption process is available from the Department upon request.

B. Negotiations

Section 50-15. Negotiations.

It is unlawful for any person employed in or on a continual contractual relationship with any of the offices or agencies of State government to participate in contract negotiations on behalf of that office or agency with any firm, partnership, association, or corporation with whom that person has a contract for future employment or is negotiating concerning possible future employment.

The bidder assures the Department that the award and execution of the contract would not cause a violation of Section 50-15, and that the bidder has no knowledge of any facts relevant to the kinds of acts prohibited therein.

C. Inducements

Section 50-25. Inducement.

Any person who offers or pays any money or other valuable thing to any person to induce him or her not to provide a submission to a vendor portal or to bid for a State contract or as recompense for not having bid on a State contract is guilty of a Class 4 felony. Any person who accepts any money or other valuable thing for not bidding for a State contract, not making a submission to a vendor portal, or who withholds a bid or submission to a vendor portal in consideration of the promise for the payment of money or other valuable thing is guilty of a Class 4 felony.

The bidder assures the Department that the award and execution of the contract would not cause a violation of Section 50-25, and that the bidder has no knowledge of any facts relevant to the kinds of acts prohibited therein.

D. Revolving Door Prohibition

Section 50-30. Revolving door prohibition.

CPOs, SPOs, procurement compliance monitors, their designees whose principal duties are directly related to State procurement, and executive officers confirmed by the Senate are expressly prohibited for a period of 2 years after terminating an affected position from engaging in any procurement activity relating to the State agency most recently employing them in an affected position for a period of at least 6 months. The prohibition includes, but is not limited to: lobbying the procurement process; specifying; bidding; proposing bid, proposal, or contract documents; on their own behalf or on behalf of any firm, partnership, association, or corporation. This Section applies only to persons who terminate an affected position on or after January 15, 1999.

The bidder assures the Department that the award and execution of the contract would not cause a violation of Section 50-30, and that the bidder has no knowledge of any facts relevant to the kinds of acts prohibited therein.

E. Reporting Anticompetitive Practices

Section 50-40. Reporting anticompetitive practices.

When, for any reason, any vendor, bidder, contractor, CPO, SPO, designee, elected official, or State employee suspects collusion or other anticompetitive practice among any bidders, offerors, contractors, proposers, or employees of the State, a notice of the relevant facts shall be transmitted to the Attorney General and the CPO.

The bidder assures the Department that it has not failed to report any relevant facts concerning the practices addressed in Section 50-40 which may involve the contract for which the bid or submission to a vendor portal is submitted.

F. Confidentiality

Section 50-45. Confidentiality.

Any CPO, SPO, designee, or executive officer who willfully uses or allows the use of specifications, competitive bid documents, proprietary competitive information, proposals, contracts, or selection information to compromise the fairness or integrity of the procurement, bidding, or contract process shall be subject to immediate dismissal, regardless of the Personnel code, any contract, or any collective bargaining agreement, and may in addition be subject to criminal prosecution.

The bidder assures the Department that it has no knowledge of any fact relevant to the practices addressed in Section 50-45 which may involve the contract for which the bid is submitted.

RETURN WITH BID

G. Insider Information

Section 50-50. Insider information.

It is unlawful for any current or former elected or appointed State official or State employee to knowingly use confidential information available only by virtue of that office or employment for actual or anticipated gain for themselves or another person.

The bidder assures the Department that it has no knowledge of any facts relevant to the practices addressed in Section 50-50 which may involve the contract for which the bid is submitted.

I acknowledge, understand and accept these terms and conditions for the above assurances.

III. CERTIFICATIONS

The certifications hereinafter made by the bidder are each a material representation of fact upon which reliance is placed should the Department enter into the contract with the bidder. Section 50-2 of the Code provides that every person that has entered into a multi-year contract and every subcontractor with a multi-year subcontract shall certify, by July 1 of each fiscal year covered by the contract after the initial fiscal year, to the responsible CPO whether it continues to satisfy the requirements of Article 50 pertaining to the eligibility for a contract award. If a contractor or subcontractor is not able to truthfully certify that it continues to meet all requirements, it shall provide with its certification a detailed explanation of the circumstances leading to the change in certification status. A contractor or subcontractor that makes a false statement material to any given certification required under Article 50 is, in addition to any other penalties or consequences prescribed by law, subject to liability under the Whistleblower Reward and Protection Act for submission of a false claim.

A. Bribery

Section 50-5. Bribery.

(a) Prohibition. No person or business shall be awarded a contract or subcontract under this Code who:

(1) has been convicted under the laws of Illinois or any other state of bribery or attempting to bribe an officer or employee of the State of Illinois or any other state in that officer's or employee's official capacity; or

(2) has made an admission of guilt of that conduct that is a matter of record but has not been prosecuted for that conduct.

(b) Businesses. No business shall be barred from contracting with any unit of State or local government, or subcontracting under such a contract, as a result of a conviction under this Section of any employee or agent of the business if the employee or agent is no longer employed by the business and:

(1) the business has been finally adjudicated not guilty; or

(2) the business demonstrates to the governmental entity with which it seeks to contract, or which is signatory to the contract which the subcontract relates, and that entity finds that the commission of the offense was not authorized, requested, commanded, or performed by a director, officer, or high managerial agent on behalf of the business as provided in paragraph (2) of subsection (a) of Section 5-4 of the Criminal Code of 2012.

(c) Conduct on behalf of business. For purposes of this Section, when an official, agent, or employee of a business committed the bribery or attempted bribery on behalf of the business and in accordance with the direction or authorization of a responsible official of the business, the business shall be chargeable with the conduct.

(d) Certification. Every bid submitted to and contract executed by the State, and every subcontract subject to Section 20-120 of the Code shall contain a certification by the contractor or the subcontractor, respectively, that the contractor or subcontractor is not barred from being awarded a contract or subcontract under this Section and acknowledges that the CPO may declare the related contract void if any certifications required by this Section are false. A contractor who makes a false statement, material to the certification, commits a Class 3 felony.

The contractor or subcontractor certifies that it is not barred from being awarded a contract under Section 50-5.

B. Felons

Section 50-10. Felons.

(a) Unless otherwise provided, no person or business convicted of a felony shall do business with the State of Illinois or any State agency, or enter into a subcontract, from the date of conviction until 5 years after the date of completion of the sentence for that felony, unless no person held responsible by a prosecutorial office for the facts upon which the conviction was based continues to have any involvement with the business.

(b) Certification. Every bid submitted to and contract executed by the State and every subcontract subject to Section 20-120 of the Code and every vendor's submission to a vendor portal shall contain a certification by the bidder or contractor or subcontractor, respectively, that the bidder, contractor, or subcontractor is not barred from being awarded a contract or subcontract under this Section and acknowledges that the CPO may declare the related contract void if any of the certifications required by this Section are false.

RETURN WITH BID

C. Debt Delinquency

Section 50-11 and 50-12. Debt Delinquency.

The contractor or bidder or subcontractor, respectively, certifies that it, or any affiliate, is not barred from being awarded a contract or subcontract under the Code. Section 50-11 prohibits a person from entering into a contract with a State agency, or entering into a subcontract, if it knows or should know that it, or any affiliate, is delinquent in the payment of any debt to the State as defined by the Debt Collection Board. Section 50-12 prohibits a person from entering into a contract with a State agency, or entering into a subcontract, if it, or any affiliate, has failed to collect and remit Illinois Use Tax on all sales of tangible personal property into the State of Illinois in accordance with the provisions of the Illinois Use Tax Act. The bidder or contractor or subcontractor, respectively, further acknowledges that the CPO may declare the related contract void if this certification is false or if the bidder, contractor, or subcontractor, or any affiliate, is determined to be delinquent in the payment of any debt to the State during the term of the contract.

D. Prohibited Bidders, Contractors and Subcontractors

Section 50-10.5 and 50-60(c). Prohibited bidders, contractors and subcontractors.

The bidder or contractor or subcontractor, respectively, certifies in accordance with Section 50-10.5 that no officer, director, partner or other managerial agent of the contracting business has been convicted of a felony under the Sarbanes-Oxley Act of 2002 or a Class 3 or Class 2 felony under the Illinois Securities Law of 1953 or if in violation of Subsection (c) for a period of five years from the date of conviction. Every bid submitted to and contract executed by the State and every subcontract subject to Section 20-120 of the Code shall contain a certification by the bidder, contractor, or subcontractor, respectively, that the bidder, contractor, or subcontractor is not barred from being awarded a contract or subcontract under this Section and acknowledges that the CPO shall declare the related contract void if any of the certifications completed pursuant to this Section are false.

E. Section 42 of the Environmental Protection Act

Section 50-14 Environmental Protection Act violations.

The bidder or contractor or subcontractor, respectively, certifies in accordance with Section 50-14 that the bidder, contractor, or subcontractor, is not barred from being awarded a contract or entering into a subcontract under this Section which prohibits the bidding on or entering into contracts with the State of Illinois or a State agency, or entering into any subcontract, that is subject to the Code by a person or business found by a court or the Pollution Control Board to have committed a willful or knowing violation of Section 42 of the Environmental Protection Act for a period of five years from the date of the order. The bidder or contractor or subcontractor, respectively, acknowledges that the CPO may declare the contract void if this certification is false.

F. Educational Loan

Section 3 of the Educational Loan Default Act, 5 ILCS 385/3.

Pursuant to the Educational Loan Default Act no State agency shall contract with an individual for goods or services if that individual is in default on an educational loan.

The bidder, if an individual as opposed to a corporation, partnership or other form of business organization, certifies that the bidder is not in default on an educational loan as provided in Section 3 of the Act.

G. Bid-Rigging/Bid Rotating

Section 33E-11 of the Criminal Code of 2012, 720 ILCS 5/33E-11.:

(a) Every bid submitted to and public contract executed pursuant to such bid by the State or a unit of local government shall contain a certification by the prime contractor that the prime contractor is not barred from contracting with any unit of State or local government as a result of a violation of either Section 33E-3 or 33E-4 of this Article

(b) A contractor who makes a false statement, material to the certification, commits a Class 3 felony.

A violation of Section 33E-3 would be represented by a conviction of the crime of bid-rigging which, in addition to Class 3 felony sentencing, provides that any person convicted of this offense or any similar offense of any state or the United States which contains the same elements as this offense shall be barred for 5 years from the date of conviction from contracting with any unit of State or local government. No corporation shall be barred from contracting with any unit of State or local government as a result of a conviction under this Section of any employee or agent of such corporation if the employee so convicted is no longer employed by the corporation and: (1) it has been finally adjudicated not guilty or (2) if it demonstrates to the governmental entity with which it seeks to contract and that entity finds that the commission of the offense was neither authorized, requested, commanded, nor performed by a director, officer or a high managerial agent in behalf of the corporation.

The bidder certifies that it is not barred from contracting with the Department by reason of a violation of either Section 33E-3 or Section 33E-4.

RETURN WITH BID

H. International Anti-Boycott

Section 5 of the International Anti-Boycott Certification Act provides every contract entered into by the State of Illinois for the manufacture, furnishing, or purchasing of supplies, material, or equipment or for the furnishing of work, labor, or services, in an amount exceeding the threshold for small purchases according to the purchasing laws of this State or \$10,000.00, whichever is less, shall contain certification, as a material condition of the contract, by which the contractor agrees that neither the contractor nor any substantially-owned affiliated company is participating or shall participate in an international boycott in violation of the provisions of the U.S. Export Administration Act of 1979 or the regulations of the U.S. Department of Commerce promulgated under that Act.

The bidder makes the certification set forth in Section 5 of the Act.

I. Drug Free Workplace

The Illinois "Drug Free Workplace Act" applies to this contract and it is necessary to comply with the provisions of the "Act" if the contractor is a corporation, partnership, or other entity (including a sole proprietorship) which has 25 or more employees.

The bidder certifies that if awarded a contract in excess of \$5,000 it will provide a drug free workplace in compliance with the provisions of the Act.

J. Disclosure of Business Operations in Iran

Section 50-36 of the Code provides that each bid, offer, or proposal submitted for a State contract shall include a disclosure of whether or not the Company acting as the bidder, offeror, or proposing entity, or any of its corporate parents or subsidiaries, within the 24 months before submission of the bid, offer, or proposal had business operations that involved contracts with or provision of supplies or services to the Government of Iran, companies in which the Government of Iran has any direct or indirect equity share, consortiums or projects commissioned by the Government of Iran, or companies involved in consortiums or projects commissioned by the Government of Iran and either of the following conditions apply:

- (1) More than 10% of the Company's revenues produced in or assets located in Iran involve oil-related activities or mineral-extraction activities; less than 75% of the Company's revenues produced in or assets located in Iran involve contracts with or provision of oil-related or mineral-extraction products or services to the Government of Iran or a project or consortium created exclusively by that government; and the Company has failed to take substantial action.
- (2) The Company has, on or after August 5, 1996, made an investment of \$20 million or more, or any combination of investments of at least \$10 million each that in the aggregate equals or exceeds \$20 million in any 12-month period, which directly or significantly contributes to the enhancement of Iran's ability to develop petroleum resources of Iran.

The terms "Business operations", "Company", "Mineral-extraction activities", "Oil-related activities", "Petroleum resources", and "Substantial action" are all defined in the Code.

Failure to make the disclosure required by the Code may cause the bid, offer or proposal to be considered not responsive. The disclosure will be considered when evaluating the bid or awarding the contract. The name of each Company disclosed as doing business or having done business in Iran will be provided to the State Comptroller.

Check the appropriate statement:

Company has no business operations in Iran to disclose.

Company has business operations in Iran as disclosed on the attached document.

RETURN WITH BID

K. Apprenticeship and Training Certification (Does not apply to federal aid projects)

In accordance with the provisions of Section 30-22 (6) of the Code, the bidder certifies that it is a participant, either as an individual or as part of a group program, in the approved apprenticeship and training programs applicable to each type of work or craft that the bidder will perform with its own forces. The bidder further certifies for work that will be performed by subcontract that each of its subcontractors submitted for approval either (a) is, at the time of such bid, participating in an approved, applicable apprenticeship and training program; or (b) will, prior to commencement of performance of work pursuant to this contract, begin participation in an approved apprenticeship and training program applicable to the work of the subcontract. The Department, at any time before or after award, may require the production of a copy of each applicable Certificate of Registration issued by the United States Department of Labor evidencing such participation by the contractor and any or all of its subcontractors. Applicable apprenticeship and training programs are those that have been approved and registered with the United States Department of Labor. The bidder shall list in the space below, the official name of the program sponsor holding the Certificate of Registration for all of the types of work or crafts in which the bidder is a participant and that will be performed with the bidder's forces. Types of work or craft work that will be subcontracted shall be included and listed as subcontract work. The list shall also indicate any type of work or craft job category that does not have an applicable apprenticeship or training program. **The bidder is responsible for making a complete report and shall make certain that each type of work or craft job category that will be utilized on the project as reported on the Construction Employee Workforce Projection (Form BC-1256) and returned with the bid is accounted for and listed.**

Additionally, Section 30-22 of the Code requires that the bidder certify that an Illinois office be maintained as the primary place of employment for persons employed for this contract.

The requirements of these certifications and disclosures are a material part of the contract, and the contractor shall require these certification provisions to be included in all approved subcontracts. In order to fulfill this requirement, it shall not be necessary that an applicable program sponsor be currently taking, or that it will take applications for apprenticeship, training or employment during the performance of the work of this contract.

TO BE RETURNED WITH BID

L. Political Contributions and Registration with the State Board of Elections

Sections 20-160 and 50-37 of the Code regulate political contributions from business entities and any affiliated entities or affiliated persons bidding on or contracting with the state. Generally under Section 50-37, any business entity, and any affiliated entity or affiliated person of the business entity, whose current year contracts with all state agencies exceed an awarded value of \$50,000, are prohibited from making any contributions to any political committees established to promote the candidacy of the officeholder responsible for the awarding of the contracts or any other declared candidate for that office for the duration of the term of office of the incumbent officeholder or a period 2 years after the termination of the contract, whichever is longer. Any business entity and affiliated entities or affiliated persons whose state contracts in the current year do not exceed an awarded value of \$50,000, but whose aggregate pending bids and proposals on state contracts exceed \$50,000, either alone or in combination with contracts not exceeding \$50,000, are prohibited from making any political contributions to any political committee established to promote the candidacy of the officeholder responsible for awarding the pending contract during the period beginning on the date the invitation for bids or request for proposals or any other procurement opportunity is issued and ending on the day after the date of award or selection if the entity was not awarded or selected. Section 20-160 requires certification of registration of affected business entities in accordance with procedures found in Section 9-35 of The Election Code.

By submission of a bid, the contractor business entity acknowledges and agrees that it has read and understands Sections 20-160 and 50-37 of the Code, and that it makes the following certification:

The undersigned bidder certifies that it has registered as a business with the State Board of Elections and acknowledges a continuing duty to update the registration in accordance with the above referenced statutes. If the business entity is required to register, the CPO shall verify that it is in compliance on the date the bid or proposal is due. The CPO shall not accept a bid or proposal if the business entity is not in compliance with the registration requirements.

These requirements and compliance with the above referenced statutory sections are a material part of the contract, and any breach thereof shall be cause to void the contract under Section 50-60 of the Code. This provision does not apply to Federal-aid contracts.

M. Lobbyist Disclosure

Section 50-38 of the Code requires that any bidder or offeror on a State contract that hires a person required to register under the Lobbyist Registration Act to assist in obtaining a contract shall:

- (i) Disclose all costs, fees, compensation, reimbursements, and other remunerations paid or to be paid to the lobbyist related to the contract,
- (ii) Not bill or otherwise cause the State of Illinois to pay for any of the lobbyist's costs, fees, compensation, reimbursements, or other remuneration, and
- (iii) Sign a verification certifying that none of the lobbyist's costs, fees, compensation, reimbursements, or other remuneration were billed to the State.

This information, along with all supporting documents, shall be filed with the agency awarding the contract and with the Secretary of State. The CPO shall post this information, together with the contract award notice, in the online Procurement Bulletin.

Pursuant to Subsection (c) of this Section, no person or entity shall retain a person or entity to attempt to influence the outcome of a procurement decision made under the Code for compensation contingent in whole or in part upon the decision or procurement. Any person who violates this subsection is guilty of a business offense and shall be fined not more than \$10,000.

Bidder acknowledges that it is required to disclose the hiring of any person required to register pursuant to the Illinois Lobbyist Registration Act (25 ILCS 170) in connection with this contract.

Bidder has not hired any person required to register pursuant to the Illinois Lobbyist Registration Act in connection with this contract.

Or

Bidder has hired the following persons required to register pursuant to the Illinois Lobbyist Registration Act in connection with the contract:

Name and address of person: _____
All costs, fees, compensation, reimbursements and other remuneration paid to said person: _____

I acknowledge, understand and accept these terms and conditions for the above certifications.

RETURN WITH BID

IV. DISCLOSURES

- A. The disclosures hereinafter made by the bidder are each a material representation of fact upon which reliance is placed should the Department enter into the contract with the bidder. The bidder further certifies that the Department has received the disclosure forms for each bid.

The CPO may void the bid, or contract, respectively, if it is later determined that the bidder or subcontractor rendered a false or erroneous disclosure. A contractor or subcontractor may be suspended or debarred for violations of the Code. Furthermore, the CPO may void the contract and the surety providing the performance bond shall be responsible for completion of the contract.

B. Financial Interests and Conflicts of Interest

1. Section 50-35 of the Code provides that all bids of more than \$50,000 and all submissions to a vendor portal shall be accompanied by disclosure of the financial interests of the bidder. This disclosed information for the successful bidder, will be maintained as public information subject to release by request pursuant to the Freedom of Information Act, filed with the Procurement Policy Board, and shall be incorporated as a material term of the contract. Furthermore, pursuant to Section 5-5, the Procurement Policy Board may review a proposal, bid, or contract and issue a recommendation to void a contract or reject a proposal or bid based on any violation of the Code or the existence of a conflict of interest as provided in subsections (b) and (d) of Section 50-35.

The financial interests to be disclosed shall include ownership or distributive income share that is in excess of 5%, or an amount greater than 60% of the annual salary of the Governor, of the bidding entity or its parent entity, whichever is less, unless the contractor or bidder is a publicly traded entity subject to Federal 10K reporting, in which case it may submit its 10K disclosure in place of the prescribed disclosure. If a bidder is a privately held entity that is exempt from Federal 10K reporting, but has more than 100 shareholders, it may submit the information that Federal 10K companies are required to report, and list the names of any person or entity holding any ownership share that is in excess of 5%. The disclosure shall include the names, addresses, and dollar or proportionate share of ownership of each individual making the disclosure, their instrument of ownership or beneficial relationship, and notice of any potential conflict of interest resulting from the current ownership or beneficial interest of each individual making the disclosure having any of the relationships identified in Section 50-35 and on the disclosure form.

The current annual salary of the Governor is \$177,412.00

In addition, all disclosures shall indicate any other current or pending contracts, proposals, leases, or other ongoing procurement relationships the bidding entity has with any other unit of state government and shall clearly identify the unit and the contract, proposal, lease, or other relationship.

2. Disclosure Forms. Disclosure Form A is attached for use concerning the individuals meeting the above ownership or distributive share requirements. A separate Disclosure Form A must be submitted with the bid for each individual meeting the above requirements. In addition, a second form (Disclosure Form B) provides for the disclosure of current or pending procurement relationships with other (non-IDOT) state agencies and a total ownership certification. **The forms must be included with each bid.**

C. Disclosure Form Instructions

Form A Instructions for Financial Information & Potential Conflicts of Interest

If the bidder is a publicly traded entity subject to Federal 10K reporting, the 10K Report may be submitted to meet the requirements of Form A. If a bidder is a privately held entity that is exempt from Federal 10K reporting, but has more than 100 shareholders, it may submit the information that Federal 10K companies are required to report, and list the names of any person or entity holding any ownership share that is in excess of 5%. If a bidder is not subject to Federal 10K reporting, the bidder must determine if any individuals are required by law to complete a financial disclosure form. To do this, the bidder should answer each of the following questions. A "YES" answer indicates Form A must be completed. If the answer to each of the following questions is "NO", then the NOT APPLICABLE STATEMENT on Form A must be signed and dated by an individual that is authorized to execute contracts for the bidding company. Note: These questions are for assistance only and are not required to be completed.

1. Does anyone in your organization have a direct or beneficial ownership share of greater than 5% of the bidding entity or parent entity? YES ___ NO ___
2. Does anyone in your organization have a direct or beneficial ownership share of less than 5%, but which has a value greater than 60% of the annual salary of the Governor? YES ___ NO ___
3. Does anyone in your organization receive more than 60% of the annual salary of the Governor of the bidding entity's or parent entity's distributive income? YES ___ NO ___

(Note: Distributive income is, for these purposes, any type of distribution of profits. An annual salary is not distributive income.)

4. Does anyone in your organization receive greater than 5% of the bidding entity's or parent entity's total distributive income, but which is less than 60% of the annual salary of the Governor? YES ___ NO ___

(Note: Only one set of forms needs to be completed per individual per bid even if a specific individual would require a yes answer to more than one question.)

A "YES" answer to any of these questions requires the completion of Form A. The bidder must determine each individual in the bidding entity or the bidding entity's parent company that would cause the questions to be answered "Yes". Each form must be signed and dated by an individual that is authorized to execute contracts for your organization. The individual signing can be, but does not have to be, the individual for which the form is being completed. The bidder is responsible for the accuracy of any information provided.

If the answer to each of the above questions is "NO", then the NOT APPLICABLE STATEMENT of Form A must be signed and dated by an individual that is authorized to execute contracts for your company.

RETURN WITH BID

Form B: Instructions for Identifying Other Contracts & Procurement Related Information

Disclosure Form B must be completed for each bid submitted by the bidding entity. *Note: Checking the NOT APPLICABLE STATEMENT on Form A does not allow the bidder to ignore Form B. Form B must be completed, checked, and dated or the bidder may be considered nonresponsive and the bid will not be accepted.*

The Bidder shall identify, by checking Yes or No on Form B, whether it has any pending contracts (including leases), bids, proposals, or other ongoing procurement relationship with any other (non-IDOT) State of Illinois agency. If "No" is checked, the bidder only needs to complete the check box on the bottom of Form B. If "Yes" is checked, the bidder must do one of the following:

Option I: If the bidder did not submit an Affidavit of Availability to obtain authorization to bid, the bidder must list all non-IDOT State of Illinois agency pending contracts, leases, bids, proposals, and other ongoing procurement relationships. These items may be listed on Form B or on an attached sheet(s). Do not include IDOT contracts. Contracts with cities, counties, villages, etc. are not considered State of Illinois agency contracts and are not to be included. Contracts with other State of Illinois agencies such as the Department of Natural Resources or the Capital Development Board must be included. Bidders who submit Affidavits of Availability are suggested to use Option II.

Option II: If the bidder is required and has submitted an Affidavit of Availability in order to obtain authorization to bid, the bidder may write or type "See Affidavit of Availability" which indicates that the Affidavit of Availability is incorporated by reference and includes all non-IDOT State of Illinois agency pending contracts, leases, bids, proposals, and other ongoing procurement relationships. For any contracts that are not covered by the Affidavit of Availability, the bidder must identify them on Form B or on an attached sheet(s). These might be such things as leases.

**ILLINOIS DEPARTMENT
OF TRANSPORTATION**

**Form A
Financial Information &
Potential Conflicts of Interest
Disclosure**

Contractor Name		
Legal Address		
City, State, Zip		
Telephone Number	Email Address	Fax Number (if available)

Disclosure of the information contained in this Form is required by Section 50-35 of the Code (30 ILCS 500). Vendors desiring to enter into a contract with the State of Illinois must disclose the financial information and potential conflict of interest information as specified in this Disclosure Form. This information shall become part of the publicly available contract file. This Form A must be completed for bids in excess of \$50,000, and for all open-ended contracts. **A publicly traded company may submit a 10K disclosure (or equivalent if applicable) in satisfaction of the requirements set forth in Form A. See Disclosure Form Instructions.**

The current annual salary of the Governor is \$177,412.00.

DISCLOSURE OF FINANCIAL INFORMATION

1. Disclosure of Financial Information. The individual named below has an interest in the BIDDER (or its parent) in terms of ownership or distributive income share in excess of 5%, or an interest which has a value of more than 60% of the annual salary of the Governor. **(Make copies of this form as necessary and attach a separate Disclosure Form A for each individual meeting these requirements)**

FOR INDIVIDUAL (type or print information)	
NAME:	_____
ADDRESS	_____
Type of ownership/distributable income share:	
stock _____ sole proprietorship _____ Partnership _____ other: (explain on separate sheet):	
% or \$ value of ownership/distributable income share:	_____

2. Disclosure of Potential Conflicts of Interest. Check "Yes" or "No" to indicate which, if any, of the following potential conflict of interest relationships apply. If the answer to any question is "Yes", please attach additional pages and describe.

(a) State employment, currently or in the previous 3 years, including contractual employment of services. Yes ___ No ___

If your answer is yes, please answer each of the following questions.

1. Are you currently an officer or employee of either the Capitol Development Board or the Illinois State Toll Highway Authority? Yes ___ No ___

2. Are you currently appointed to or employed by any agency of the State of Illinois? If you are currently appointed to or employed by any agency of the State of Illinois, and your annual salary exceeds 60% of the annual salary of the Governor, provide the name the State agency for which you are employed and your annual salary. _____

RETURN WITH BID

3. If you are currently appointed to or employed by any agency of the State of Illinois, and your annual salary exceeds 60% of the annual salary of the Governor, are you entitled to receive (i) more than 7 1/2% of the total distributable income of your firm, partnership, association or corporation, or (ii) an amount in excess of 100% of the annual salary of the Governor?
Yes ___ No ___

4. If you are currently appointed to or employed by any agency of the State of Illinois, and your annual salary exceeds 60% of the annual salary of the Governor, are you and your spouse or minor children entitled to receive (i) more than 15 % in the aggregate of the total distributable income of your firm, partnership, association or corporation, or (ii) an amount in excess of two times the salary of the Governor?
Yes ___ No ___

(b) State employment of spouse, father, mother, son, or daughter, including contractual employment for services in the previous 2 years.
Yes ___ No ___

If your answer is yes, please answer each of the following questions.

1. Is your spouse or any minor children currently an officer or employee of the Capitol Development Board or the Illinois State Toll Highway Authority?
Yes ___ No ___

2. Is your spouse or any minor children currently appointed to or employed by any agency of the State of Illinois? If your spouse or minor children is/are currently appointed to or employed by any agency of the State of Illinois, and his/her annual salary exceeds 60% of the annual salary of the Governor, provide the name of your spouse and/or minor children, the name of the State agency for which he/she is employed and his/her annual salary. _____

3. If your spouse or any minor children is/are currently appointed to or employed by any agency of the State of Illinois, and his/her annual salary exceeds 60% of the annual salary of the Governor, are you entitled to receive (i) more than 7 1/2% of the total distributable income of your firm, partnership, association or corporation, or (ii) an amount in excess of 100% of the annual salary of the Governor?
Yes ___ No ___

4. If your spouse or any minor children are currently appointed to or employed by any agency of the State of Illinois, and his/her annual salary exceeds 60% of the annual salary of the Governor, are you and your spouse or minor children entitled to receive (i) more than 15 % in the aggregate of the total distributable income of your firm, partnership, association or corporation, or (ii) an amount in excess of two times the salary of the Governor?
Yes ___ No ___

(c) Elective status; the holding of elective office of the State of Illinois, the government of the United States, any unit of local government authorized by the Constitution of the State of Illinois or the statutes of the State of Illinois currently or in the previous 3 years.
Yes ___ No ___

(d) Relationship to anyone holding elective office currently or in the previous 2 years; spouse, father, mother, son, or daughter.
Yes ___ No ___

(e) Appointive office; the holding of any appointive government office of the State of Illinois, the United States of America, or any unit of local government authorized by the Constitution of the State of Illinois or the statutes of the State of Illinois, which office entitles the holder to compensation in excess of the expenses incurred in the discharge of that office currently or in the previous 3 years.
Yes ___ No ___

(f) Relationship to anyone holding appointive office currently or in the previous 2 years; spouse, father, mother, son, or daughter.
Yes ___ No ___

(g) Employment, currently or in the previous 3 years, as or by any registered lobbyist of the State government.
Yes ___ No ___

RETURN WITH BID

- (h) Relationship to anyone who is or was a registered lobbyist in the previous 2 years; spouse, father, mother, son, or daughter. Yes ___ No ___

- (i) Compensated employment, currently or in the previous 3 years, by any registered election or reelection committee registered with the Secretary of State or any county clerk of the State of Illinois, or any political action committee registered with either the Secretary of State or the Federal Board of Elections. Yes ___ No ___

- (j) Relationship to anyone; spouse, father, mother, son, or daughter; who was a compensated employee in the last 2 years by any registered election or re-election committee registered with the Secretary of State or any county clerk of the State of Illinois, or any political action committee registered with either the Secretary of State or the Federal Board of Elections. Yes ___ No ___

3. Communication Disclosure.

Disclose the name and address of each lobbyist and other agent of the bidder or offeror who is not identified in Section 2 of this form, who is has communicated, is communicating, or may communicate with any State officer or employee concerning the bid or offer. This disclosure is a continuing obligation and must be promptly supplemented for accuracy throughout the process and throughout the term of the contract. If no person is identified, enter "None" on the line below:

Name and address of person(s): _____

RETURN WITH BID

4. Suspension or Debarment Disclosure. For each of the persons identified under Sections 2 and 3 of this form, disclose whether any of the following has occurred within the previous 10 years: suspension or debarment from contracting with any governmental entity; professional licensure discipline; bankruptcies; adverse civil judgments and administrative findings; and criminal felony convictions. This disclosure is a continuing obligation and must be promptly supplemented for accuracy throughout the procurement process and term of the contract. If no person is identified, enter "None" on the line below:

Name of person(s): _____

Nature of disclosure: _____

APPLICABLE STATEMENT

This Disclosure Form A is submitted on behalf of the INDIVIDUAL named on previous page. Under penalty of perjury, I certify the contents of this disclosure to be true and accurate to the best of my knowledge.

Completed by: _____ Date _____
Signature of Individual or Authorized Representative

NOT APPLICABLE STATEMENT

Under penalty of perjury, I have determined that no individuals associated with this organization meet the criteria that would require the completion of this Form A.

This Disclosure Form A is submitted on behalf of the CONTRACTOR listed on the previous page.

_____ Date _____
Signature of Authorized Representative

The bidder has a continuing obligation to supplement these disclosures under Sec. 50-35 of the Code.

RETURN WITH BID

ILLINOIS DEPARTMENT OF TRANSPORTATION

Form B Other Contracts & Financial Related Information Disclosure

Contractor Name, Legal Address, City, State, Zip, Telephone Number, Email Address, Fax Number (if available)

Disclosure of the information contained in this Form is required by Section 50-35 of the Code (30 ILCS 500). This information shall become part of the publicly available contract file. This Form B must be completed for all bids.

DISCLOSURE OF OTHER CONTRACTS AND PROCUREMENT RELATED INFORMATION

- 1. Identifying Other Contracts & Procurement Related Information. The BIDDER shall identify whether it has any pending contracts... 2. If "Yes" is checked. Identify each such relationship by showing State of Illinois agency name and other descriptive information...

THE FOLLOWING STATEMENT MUST BE CHECKED

Signature of Authorized Representative, Date

OWNERSHIP CERTIFICATION

Please certify that the following statement is true if the individuals for all submitted Form A disclosures do not total 100% of ownership.

Any remaining ownership interest is held by individuals receiving less than \$106,447.20 of the bidding entity's or parent entity's distributive income or holding less than a 5% ownership interest.

- Yes No N/A (Form A disclosure(s) established 100% ownership)

RETURN WITH BID

SPECIAL NOTICE TO CONTRACTORS

The following requirements of the Illinois Department of Human Rights Act are applicable to bidders on all construction contracts advertised by the Illinois Department of Transportation:

CONSTRUCTION EMPLOYEE UTILIZATION PROJECTION

- (a) All bidders on construction contracts shall complete and submit, along with and as part of their bids, a Bidder's Employee Utilization Form (Form BC-1256) setting forth a projection and breakdown of the total workforce intended to be hired and/or allocated to such contract work by the bidder including a projection of minority and female employee utilization in all job classifications on the contract project.
- (b) The Department of Transportation shall review the Employee Utilization Form, and workforce projections contained therein, of the contract awardee to determine if such projections reflect an underutilization of minority persons and/or women in any job classification in accordance with the Equal Employment Opportunity Clause and Title 44, Illinois Administrative Code, Section 750.120. If it is determined that the contract awardee's projections reflect an underutilization of minority persons and/or women in any job classification, it shall be advised in writing of the manner in which it is underutilizing and such awardee shall be considered to be in breach of the contract unless, prior to commencement of work on the contract project, it submits revised satisfactory projections or an acceptable written affirmative action plan to correct such underutilization including a specific timetable geared to the completion stages of the contract.
- (c) The Department of Transportation shall provide to the Department of Human Rights a copy of the contract awardee's Employee Utilization Form, a copy of any required written affirmative action plan, and any written correspondence related thereto. The Department of Human Rights may review and revise any action taken by the Department of Transportation with respect to these requirements.

RETURN WITH BID



Contract No. 64L73
HENRY County
Section D2 RS 2017-2
Routes FAU 5862 & 5863
District 2 Construction Funds

PART I. IDENTIFICATION

Dept. of Human Rights # _____ Duration of Project: _____

Name of Bidder: _____

PART II. WORKFORCE PROJECTION

A. The undersigned bidder has analyzed minority group and female populations, unemployment rates and availability of workers for the location in which this contract work is to be performed, and for the locations from which the bidder recruits employees, and hereby submits the following workforce projection including a projection for minority and female employee utilization in all job categories in the workforce to be allocated to this contract:

TABLE A

TOTAL Workforce Projection for Contract												
JOB CATEGORIES	TOTAL EMPLOYEES		MINORITY EMPLOYEES						TRAINEES			
			BLACK		HISPANIC		*OTHER MINOR.		APPRENTICES		ON THE JOB TRAINEES	
	M	F	M	F	M	F	M	F	M	F	M	F
OFFICIALS (MANAGERS)												
SUPERVISORS												
FOREMEN												
CLERICAL												
EQUIPMENT OPERATORS												
MECHANICS												
TRUCK DRIVERS												
IRONWORKERS												
CARPENTERS												
CEMENT MASONS												
ELECTRICIANS												
PIPEFITTERS, PLUMBERS												
PAINTERS												
LABORERS, SEMI-SKILLED												
LABORERS, UNSKILLED												
TOTAL												

TABLE B

CURRENT EMPLOYEES TO BE ASSIGNED TO CONTRACT			
TOTAL EMPLOYEES		MINORITY EMPLOYEES	
M	F	M	F

TABLE C

TOTAL Training Projection for Contract								
EMPLOYEES IN TRAINING	TOTAL EMPLOYEES		BLACK		HISPANIC		*OTHER MINOR.	
	M	F	M	F	M	F	M	F
APPRENTICES								
ON THE JOB TRAINEES								

FOR DEPARTMENT USE ONLY

* Other minorities are defined as Asians (A) or Native Americans (N).
Please specify race of each employee shown in Other Minorities column.

Note: See instructions on page 2

RETURN WITH BID

**Contract No. 64L73
HENRY County
Section D2 RS 2017-2
Routes FAU 5862 & 5863
District 2 Construction Funds**

PART II. WORKFORCE PROJECTION - continued

- B. Included in "Total Employees" under Table A is the total number of **new hires** that would be employed in the event the undersigned bidder is awarded this contract.

The undersigned bidder projects that: (number) _____ new hires would be recruited from the area in which the contract project is located; and/or (number) _____ new hires would be recruited from the area in which the bidder's principal office or base of operation is located.

- C. Included in "Total Employees" under Table A is a projection of numbers of persons to be employed directly by the undersigned bidder as well as a projection of numbers of persons to be employed by subcontractors.

The undersigned bidder estimates that (number) _____ persons will be directly employed by the prime contractor and that (number) _____ persons will be employed by subcontractors.

PART III. AFFIRMATIVE ACTION PLAN

- A. The undersigned bidder understands and agrees that in the event the foregoing minority and female employee utilization projection included under **PART II** is determined to be an underutilization of minority persons or women in any job category, and in the event that the undersigned bidder is awarded this contract, he/she will, prior to commencement of work, develop and submit a written Affirmative Action Plan including a specific timetable (geared to the completion stages of the contract) whereby deficiencies in minority and/or female employee utilization are corrected. Such Affirmative Action Plan will be subject to approval by the contracting agency and the **Illinois Department of Human Rights**.

- B. The undersigned bidder understands and agrees that the minority and female employee utilization projection submitted herein, and the goals and timetable included under an Affirmative Action Plan if required, are deemed to be part of the contract specifications.

Company _____

Telephone Number _____

Address _____

NOTICE REGARDING SIGNATURE

The Bidder's signature on the Proposal Signature Sheet will constitute the signing of this form. The following signature block needs to be completed if revisions are required.

Signature: _____ Title: _____ Date: _____

Instructions: All tables must include subcontractor personnel in addition to prime contractor personnel.

Table A - Include both the number of employees that would be hired to perform the contract work and the total number currently employed (Table B) that will be allocated to contract work, and include all apprentices and on-the-job trainees. The "Total Employees" column should include all employees including all minorities, apprentices and on-the-job trainees to be employed on the contract work.

Table B - Include all employees currently employed that will be allocated to the contract work including any apprentices and on-the-job trainees currently employed.

Table C - Indicate the racial breakdown of the total apprentices and on-the-job trainees shown in Table A.

RETURN WITH BID

Contract No. 64L73

HENRY County

Section D2 RS 2017-2

Routes FAU 5862 & 5863

District 2 Construction Funds

PROPOSAL SIGNATURE SHEET

The undersigned bidder hereby makes and submits this bid on the subject Proposal, thereby assuring the Department that all requirements of the Invitation for Bids and rules of the Department have been met, that there is no misunderstanding of the requirements of paragraph 3 of this Proposal, and that the contract will be executed in accordance with the rules of the Department if an award is made on this bid.

(IF AN INDIVIDUAL)

Firm Name _____

Signature of Owner _____

Business Address _____

(IF A CO-PARTNERSHIP)

Firm Name _____

By _____

Business Address _____

Name and Address of All Members of the Firm:

(IF A CORPORATION)

Corporate Name _____

By _____

Signature of Authorized Representative

Typed or printed name and title of Authorized Representative

Attest _____

Signature

(IF A JOINT VENTURE, USE THIS SECTION FOR THE MANAGING PARTY AND THE SECOND PARTY SHOULD SIGN BELOW)

Business Address _____

(IF A JOINT VENTURE)

Corporate Name _____

By _____

Signature of Authorized Representative

Typed or printed name and title of Authorized Representative

Attest _____

Signature

Business Address _____

If more than two parties are in the joint venture, please attach an additional signature sheet.



This Annual Proposal Bid Bond shall become effective at 12:01 AM (CDST) on _____ and shall be valid until _____ 11:59 PM (CDST).

KNOW ALL PERSONS BY THESE PRESENTS, That We _____

as PRINCIPAL, and _____

as SURETY, and held jointly, severally and firmly bound unto the STATE OF ILLINOIS in the penal sum of 5 percent of the total bid price, or for the amount specified in the bid proposal under "Proposal Guaranty" in effect on the date of the Invitation for Bids, whichever is the lesser sum, well and truly to be paid unto said STATE OF ILLINOIS, for the payment of which we bind ourselves, our heirs, executors, administrators, successors and assigns.

THE CONDITION OF THE FOREGOING OBLIGATION IS SUCH that whereas, the PRINCIPAL may submit bid proposal(s) to the STATE OF ILLINOIS, acting through the Department of Transportation, for various improvements published in the Transportation Bulletin during the effective term indicated above.

NOW, THEREFORE, if the Department shall accept the bid proposal(s) of the PRINCIPAL; and if the PRINCIPAL shall, within the time and as specified in the bidding and contract documents; and if, after award by the Department, the PRINCIPAL shall enter into a contract in accordance with the terms of the bidding and contract documents including evidence of the required insurance coverages and providing such bond as specified with good and sufficient surety for the faithful performance of such contract and for the prompt payment of labor and material furnished in the prosecution thereof; or if, in the event of the failure of the PRINCIPAL to enter into such contract and to give the specified bond, the PRINCIPAL pays to the Department the difference not to exceed the penalty hereof between the amount specified in the bid proposal and such larger amount for which the Department may contract with another party to perform the work covered by said bid proposal, then this obligation shall be null and void, otherwise, it shall remain in full force and effect.

IN THE EVENT the Department determines the PRINCIPAL has failed to comply with any requirement as set forth in the preceding paragraph, then Surety shall pay the penal sum to the Department within fifteen (15) days of written demand therefor. If Surety does not make full payment within such period of time, the Department may bring an action to collect the amount owed. Surety is liable to the Department for all its expenses, including attorney's fees, incurred in any litigation in which it prevails either in whole or in part.

In TESTIMONY WHEREOF, the said PRINCIPAL has caused this instrument to be signed by its officer _____ day of _____ A.D., _____.

In TESTIMONY WHEREOF, the said SURETY has caused this instrument to be signed by its officer _____ day of _____ A.D., _____.

(Company Name)

(Company Name)

By _____
(Signature and Title)

By _____
(Signature of Attorney-in-Fact)

Notary for PRINCIPAL

Notary for SURETY

STATE OF _____
COUNTY OF _____

STATE OF _____
COUNTY OF _____

Signed and attested before me on _____ (date)

Signed and attested before me on _____ (date)

by _____
(Name of Notary Public)

by _____
(Name of Notary Public)

(Seal) _____
(Signature of Notary Public)

(Seal) _____
(Signature of Notary Public)

(Date Commission Expires)

(Date Commission Expires)

In lieu of completing the above section of the Annual Proposal Bid Bond form, the Principal may file an Electronic Bid Bond. By signing the proposal(s) the Principal is ensuring the identified electronic bid bond has been executed and the Principal and Surety are firmly bound unto the State of Illinois under the conditions of the bid bond as shown above.

Electronic Bid Bond ID #	Company/Bidder Name	Signature and Title
--------------------------	---------------------	---------------------

This bond may be terminated, at Surety's request, upon giving not less than thirty (30) days prior written notice of the cancellation/termination of the bond. Said written notice shall be issued to the Illinois Department of Transportation, Chief Contracts Official, 2300 South Dirksen Parkway, Springfield, Illinois, 62764, and shall be served in person, by receipted courier delivery or certified or registered mail, return receipt requested. Said notice period shall commence on the first calendar day following the Department's receipt of written cancellation/termination notice. Surety shall remain firmly bound to all obligations herein for proposals submitted prior to the cancellation/termination. Surety shall be released and discharged from any obligation(s) for proposals submitted for any letting or date after the effective date of cancellation/termination.



Return with Bid

Division of Highways
Proposal Bid Bond

Item No. _____

Letting Date _____

KNOW ALL PERSONS BY THESE PRESENTS, That We _____

as PRINCIPAL, and _____

as SURETY, and held jointly, severally and firmly bound unto the STATE OF ILLINOIS in the penal sum of 5 percent of the total bid price, or for the amount specified in the bid proposal under "Proposal Guaranty" in effect on the date of the Invitation for Bids, whichever is the lesser sum, well and truly to be paid unto said STATE OF ILLINOIS, for the payment of which we bind ourselves, our heirs, executors, administrators, successors and assigns.

THE CONDITION OF THE FOREGOING OBLIGATION IS SUCH that whereas, the PRINCIPAL has submitted a bid proposal to the STATE OF ILLINOIS, acting through the Department of Transportation, for the improvement designated by the Transportation Bulletin Item Number and Letting Date indicated above.

NOW, THEREFORE, if the Department shall accept the bid proposal of the PRINCIPAL; and if the PRINCIPAL shall, within the time and as specified in the bidding and contract documents; and if, after award by the Department, the PRINCIPAL shall enter into a contract in accordance with the terms of the bidding and contract documents including evidence of the required insurance coverages and providing such bond as specified with good and sufficient surety for the faithful performance of such contract and for the prompt payment of labor and material furnished in the prosecution thereof; or if, in the event of the failure of the PRINCIPAL to enter into such contract and to give the specified bond, the PRINCIPAL pays to the Department the difference not to exceed the penalty hereof between the amount specified in the bid proposal and such larger amount for which the Department may contract with another party to perform the work covered by said bid proposal, then this obligation shall be null and void, otherwise, it shall remain in full force and effect.

IN THE EVENT the Department determines the PRINCIPAL has failed to comply with any requirement as set forth in the preceding paragraph, then Surety shall pay the penal sum to the Department within fifteen (15) days of written demand therefor. If Surety does not make full payment within such period of time, the Department may bring an action to collect the amount owed. Surety is liable to the Department for all its expenses, including attorney's fees, incurred in any litigation in which it prevails either in whole or in part.

In TESTIMONY WHEREOF, the said PRINCIPAL has caused this instrument to be signed by its officer _____ day of _____ A.D., _____.

In TESTIMONY WHEREOF, the said SURETY has caused this instrument to be signed by its officer _____ day of _____ A.D., _____.

(Company Name)

(Company Name)

By _____ (Signature and Title)

By _____ (Signature of Attorney-in-Fact)

Notary for PRINCIPAL

Notary for SURETY

STATE OF _____
COUNTY OF _____

STATE OF _____
COUNTY OF _____

Signed and attested before me on _____ (date)
by _____ (Name of Notary Public)

Signed and attested before me on _____ (date)
by _____ (Name of Notary Public)

(Seal) _____ (Signature of Notary Public)

(Seal) _____ (Signature of Notary Public)

(Date Commission Expires)

(Date Commission Expires)

In lieu of completing the above section of the Proposal Bid Bond form, the Principal may file an Electronic Bid Bond. By signing the proposal the Principal is ensuring the identified electronic bid bond has been executed and the Principal and Surety are firmly bound unto the State of Illinois under the conditions of the bid bond as shown above.

Electronic Bid Bond ID # _____ Company/Bidder Name _____ Signature and Title _____



(1) Policy

It is public policy that disadvantageded businesses as defined in 49 CFR Part 26 and the Special Provision shall have the maximum opportunity to participate in the performance of contracts financed in whole or in part with Federal or State funds. Consequently the requirements of 49 CFR Part 26 apply to this contract.

(2) Obligation

The contractor agrees to ensure that disadvantageded businesses as defined in 49 CFR Part 26 and the Special Provision have the maximum opportunity to participate in the performance of contracts or subcontracts financed in whole or in part with Federal or State funds. The contractor shall take all necessary and reasonable steps in accordance with 49 CFR Part 26 and the Special Provision to ensure that said businesses have the maximum opportunity to compete for and perform under this contract. The contractor shall not discriminate on the basis of race, color, national origin or sex in the award and performance of contracts.

(3) Project and Bid Identification

Complete the following information concerning the project and bid:

Route _____

Section _____

Project _____

County _____

Letting Date _____

Contract No. _____

Letting Item No. _____

Total Bid _____

Contract DBE Goal _____

(Percent) (Dollar Amount)

(4) Assurance

I, acting in my capacity as an officer of the undersigned bidder (or bidders if a joint venture), hereby assure the Department that on this project my company : (check one)

- Meets or exceeds contract award goals and has provided documented participation as follows:
Disadvantaged Business Participation _____ percent

Attached are the signed participation statements, forms SBE 2025, required by the Special Provision evidencing availability and use of each business participating in this plan and assuring that each business will perform a commercially useful function in the work of the contract.

- Failed to meet contract award goals and has included good faith effort documentation to meet the goals and that my company has provided participation as follows:
Disadvantaged Business Participation _____ percent

The contract goals should be accordingly modified or waived. Attached is all information required by the Special Provision in support of this request including good faith effort. Also attached are the signed participation statements, forms SBE 2025, required by the Special Provision evidencing availability and use of each business participating in this plan and assuring that each business will perform a commercially useful function in the work of the contract.

_____ Company

By _____

Title _____

Date _____

The "as read" Low Bidder is required to comply with the Special Provision.

Submit only one utilization plan for each project. The utilization plan shall be submitted in accordance with the special provision.

Bureau of Small Business Enterprises **Local Let Projects**
 2300 South Dirksen Parkway Submit forms to the
 Springfield, Illinois 62764 Local Agency

The Department of Transportation is requesting disclosure of information that is necessary to accomplish the purpose as outlined under State and Federal law. Disclosure of this information is **REQUIRED**. Failure to provide any information will result in the contract not being awarded. This form has been approved by the State Forms Manager Center.



Illinois Department of Transportation

DBE Participation Statement

Subcontractor Registration Number _____

Letting _____

Participation Statement

Item No. _____

(1) Instructions

Contract No. _____

This form must be completed for each disadvantaged business participating in the Utilization Plan. This form shall be submitted in accordance with the special provision and will be attached to the Utilization Plan form. If additional space is needed complete an additional form for the firm. Trucking participation items; description must list what is anticipated towards goal credit.

(2) Work:

Please indicate: J/V _____ Manufacturer _____ Supplier (60%) _____ Subcontractor _____ Trucking _____

Pay Item No.	Description (Anticipated items for trucking)*	Quantity	Unit Price	Total
Total				

(3) Partial Payment Items (For any of the above items which are partial pay items)

Description must be sufficient to determine a Commercially Useful Function, specifically describe the work and subcontract dollar amount:

*Applies to trucking only

(4) Commitment

When a DBE is to be a second-tier subcontractor, or if the first-tier DBE subcontractor is going to be subcontracting a portion of its subcontract, it must be clearly indicated on the DBE Participation Statement, and the details of the transaction fully explained.

In the event a DBE subcontractor second-tiers a portion of its subcontract to one or more subcontractors during the work of a contract, the prime must submit a DBE Participation Statement, with the details of the transaction(s) fully explained.

The undersigned certify that the information included herein is true and correct, and that the DBE firm listed below has agreed to perform a commercially useful function in the work of the contract item(s) listed above and to execute a contract with the prime contractor or 1st Tier subcontractor. The undersigned further understand that no changes to this statement may be made without prior approval from the Department's Bureau of Small Business Enterprises and that complete and accurate information regarding actual work performed on this project and the payment therefore must be provided to the Department.

Signature for Contractor __ 1st Tier __ 2nd Tier

Date _____

Contact Person _____

Title _____

Firm Name _____

Address _____

City/State/Zip _____

Phone _____

Email Address _____

Signature for DBE Firm __ 1st Tier __ 2nd Tier

Date _____

Contact Person _____

Title _____

Firm Name _____

Address _____

City/State/Zip _____

Phone _____

Email Address _____

E _____
WC _____

The Department of Transportation is requesting disclosure of information that is necessary to accomplish the statutory purpose as outlined under the state and federal law. Disclosure of this information is **REQUIRED**. Failure to provide any information will result in the contract not being awarded. This form has been approved by the State Forms Management Center.

PROPOSAL ENVELOPE



PROPOSALS

for construction work advertised for bids by the
Illinois Department of Transportation

Item No.	Item No.	Item No.

Submitted By:

Name:
Address:
Phone No.

Bidders should use an IDOT proposal envelope or affix this form to the front of a 10" x 13" envelope for the submittal of bids. If proposals are mailed, they should be enclosed in a second or outer envelope addressed to:

Engineer of Design and Environment - Room 326
Illinois Department of Transportation
2300 South Dirksen Parkway
Springfield, Illinois 62764

NOTICE

Individual bids, including Bid Bond and/or supplemental information if required, should be securely stapled.

CONTRACTOR OFFICE COPY OF CONTRACT SPECIFICATIONS

NOTICE

None of the following material needs to be returned with the bid package unless the special provisions require documentation and/or other information to be submitted.

**Contract No. 64L73
HENRY County
Section D2 RS 2017-2
Routes FAU 5862 & 5863
District 2 Construction Funds**



Illinois Department of Transportation

SUBCONTRACTOR DOCUMENTATION

Public Acts 96-0795, 96-0920, and 97-0895 enacted substantial changes to the provisions of the Code (30 ILCS 500). Among the changes are provisions affecting subcontractors. The Contractor awarded this contract will be required as a material condition of the contract to implement and enforce the contract requirements applicable to subcontractors that entered into a contractual agreement with a total value of \$50,000 or more with a person or entity who has a contract subject to the Code and approved in accordance with article 108.01 of the Standard Specifications for Road and Bridge Construction.

If the Contractor seeks approval of subcontractors to perform a portion of the work, and approval is granted by the Department, the Contractor shall provide a copy of the subcontract to the Illinois Department of Transportation's CPO upon request within 15 calendar days after execution of the subcontract.

Financial disclosures required pursuant to Sec. 50-35 of the Code must be submitted for all applicable subcontractors. The subcontract shall contain the certifications required to be made by subcontractors pursuant to Article 50 of the Code. This Notice to Bidders includes a document incorporating all required subcontractor certifications and disclosures for use by the Contractor in compliance with this mandate. The document is entitled State Required Ethical Standards Governing Subcontractors.

RETURN WITH SUBCONTRACT

STATE ETHICAL STANDARDS GOVERNING SUBCONTRACTORS

Article 50 of the Code establishes the duty of all State CPOs, SPOs, and their designees to maximize the value of the expenditure of public moneys in procuring goods, services, and contracts for the State of Illinois and to act in a manner that maintains the integrity and public trust of State government. In discharging this duty, they are charged by law to use all available information, reasonable efforts, and reasonable actions to protect, safeguard, and maintain the procurement process of the State of Illinois.

The certifications hereinafter made by the subcontractor are each a material representation of fact upon which reliance is placed should the Department approve the subcontractor. The CPO may terminate or void the contract approval if it is later determined that the bidder or subcontractor rendered a false or erroneous certification. If a false certification is made by a subcontractor the contractor's submitted bid and the executed contract may not be declared void unless the contractor refuses to terminate the subcontract upon the State's request after a finding that the subcontractor's certification was false.

Section 50-2 of the Code provides that every person that has entered into a multi-year contract and every subcontractor with a multi-year subcontract shall certify, by July 1 of each fiscal year covered by the contract after the initial fiscal year, to the responsible CPO whether it continues to satisfy the requirements of Article 50 pertaining to the eligibility for a contract award. If a contractor or subcontractor is not able to truthfully certify that it continues to meet all requirements, it shall provide with its certification a detailed explanation of the circumstances leading to the change in certification status. A contractor or subcontractor that makes a false statement material to any given certification required under Article 50 is, in addition to any other penalties or consequences prescribed by law, subject to liability under the Whistleblower Reward and Protection Act for submission of a false claim.

A. Bribery

Section 50-5. Bribery.

(a) Prohibition. No person or business shall be awarded a contract or subcontract under this Code who:

(1) has been convicted under the laws of Illinois or any other state of bribery or attempting to bribe an officer or employee of the State of Illinois or any other state in that officer's or employee's official capacity; or

(2) has made an admission of guilt of that conduct that is a matter of record but has not been prosecuted for that conduct.

(b) Businesses. No business shall be barred from contracting with any unit of State or local government, or subcontracting under such a contract, as a result of a conviction under this Section of any employee or agent of the business if the employee or agent is no longer employed by the business and:

(1) the business has been finally adjudicated not guilty; or

(2) the business demonstrates to the governmental entity with which it seeks to contract, or which is signatory to the contract to which the subcontract relates, and that entity finds that the commission of the offense was not authorized, requested, commanded, or performed by a director, officer, or high managerial agent on behalf of the business as provided in paragraph (2) of subsection (a) of Section 5-4 of the Criminal Code of 2012.

(c) Conduct on behalf of business. For purposes of this Section, when an official, agent, or employee of a business committed the bribery or attempted bribery on behalf of the business and in accordance with the direction or authorization of a responsible official of the business, the business shall be chargeable with the conduct.

(d) Certification. Every bid submitted to and contract executed by the State, and every subcontract subject to Section 20-120 of the Code shall contain a certification by the contractor or the subcontractor, respectively, that the contractor or subcontractor is not barred from being awarded a contract or subcontract under this Section and acknowledges that the CPO may declare the related contract void if any certifications required by this Section are false. A contractor who makes a false statement, material to the certification, commits a Class 3 felony.

The contractor or subcontractor certifies that it is not barred from being awarded a contract under Section 50-5.

B. Felons

Section 50-10. Felons.

Unless otherwise provided, no person or business convicted of a felony shall do business with the State of Illinois or any State agency, or enter into a subcontract, from the date of conviction until 5 years after the date of completion of the sentence for that felony, unless no person held responsible by a prosecutorial office for the facts upon which the conviction was based continues to have any involvement with the business.

Certification. Every bid submitted to and contract executed by the State and every subcontract subject to Section 20-120 of the Code shall contain a certification by the bidder or contractor or subcontractor, respectively, that the bidder, contractor, or subcontractor is not barred from being awarded a contract or subcontract under this Section and acknowledges that the CPO may declare the related contract void if any of the certifications required by this Section are false.

RETURN WITH SUBCONTRACT

C. Debt Delinquency

Section 50-11 and 50-12. Debt Delinquency.

The contractor or bidder or subcontractor, respectively, certifies that it, or any affiliate, is not barred from being awarded a contract or subcontract under the Code. Section 50-11 prohibits a person from entering into a contract with a State agency, or entering into a subcontract, if it knows or should know that it, or any affiliate, is delinquent in the payment of any debt to the State as defined by the Debt Collection Board. Section 50-12 prohibits a person from entering into a contract with a State agency, or entering into a subcontract, if it, or any affiliate, has failed to collect and remit Illinois Use Tax on all sales of tangible personal property into the State of Illinois in accordance with the provisions of the Illinois Use Tax Act. The bidder or contractor or subcontractor, respectively, further acknowledges that the CPO may declare the related contract void if this certification is false or if the bidder, contractor, or subcontractor, or any affiliate, is determined to be delinquent in the payment of any debt to the State during the term of the contract.

D. Prohibited Bidders, Contractors and Subcontractors

Section 50-10.5 and 50-60(c). Prohibited bidders, contractors and subcontractors.

The bidder or contractor or subcontractor, respectively, certifies in accordance with 30 ILCS 500/50-10.5 that no officer, director, partner or other managerial agent of the contracting business has been convicted of a felony under the Sarbanes-Oxley Act of 2002 or a Class 3 or Class 2 felony under the Illinois Securities Law of 1953 or if in violation of Subsection (c) for a period of five years from the date of conviction. Every bid submitted to and contract executed by the State and every subcontract subject to Section 20-120 of the Code shall contain a certification by the bidder, contractor, or subcontractor, respectively, that the bidder, contractor, or subcontractor is not barred from being awarded a contract or subcontract under this Section and acknowledges that the CPO shall declare the related contract void if any of the certifications completed pursuant to this Section are false.

E. Section 42 of the Environmental Protection Act

The bidder or contractor or subcontractor, respectively, certifies in accordance with 30 ILCS 500/50-14 that the bidder, contractor, or subcontractor, is not barred from being awarded a contract or entering into a subcontract under this Section which prohibits the bidding on or entering into contracts with the State of Illinois or a State agency, or entering into any subcontract, that is subject to the Code by a person or business found by a court or the Pollution Control Board to have committed a willful or knowing violation of Section 42 of the Environmental Protection Act for a period of five years from the date of the order. The bidder or contractor or subcontractor, respectively, acknowledges that the CPO may declare the contract void if this certification is false.

The undersigned, on behalf of the subcontracting company, has read and understands the above certifications and makes the certifications as required by law.

Name of Subcontracting Company

Authorized Officer

Date

RETURN WITH SUBCONTRACT
SUBCONTRACTOR DISCLOSURES

I. DISCLOSURES

A. The disclosures hereinafter made by the subcontractor are each a material representation of fact upon which reliance is placed. The subcontractor further certifies that the Department has received the disclosure forms for each subcontract.

The CPO may void the bid, contract, or subcontract, respectively, if it is later determined that the bidder or subcontractor rendered a false or erroneous disclosure. A contractor or subcontractor may be suspended or debarred for violations of the Code. Furthermore, the CPO may void the contract.

B. Financial Interests and Conflicts of Interest

1. Section 50-35 of the Code provides that all subcontracts with a total value of \$50,000 or more from subcontractors identified in Section 20-120 of the Code, shall be accompanied by disclosure of the financial interests of the subcontractor. This disclosed information for the subcontractor, will be maintained as public information subject to release by request pursuant to the Freedom of Information Act, filed with the Procurement Policy Board, and shall be incorporated as a material term of the Prime Contractor's contract. Furthermore, pursuant to this Section, the Procurement Policy Board may recommend to allow or void a contract or subcontract based on a potential conflict of interest.

The financial interests to be disclosed shall include ownership or distributive income share that is in excess of 5%, or an amount greater than 60% of the annual salary of the Governor, of the subcontracting entity or its parent entity, whichever is less, unless the subcontractor is a publicly traded entity subject to Federal 10K reporting, in which case it may submit its 10K disclosure in place of the prescribed disclosure. If a subcontractor is a privately held entity that is exempt from Federal 10K reporting, but has more than 100 shareholders, it may submit the information that Federal 10K companies are required to report, and list the names of any individual or entity holding any ownership share that is in excess of 5%. The disclosure shall include the names, addresses, and dollar or proportionate share of ownership of each individual making the disclosure, their instrument of ownership or beneficial relationship, and notice of any potential conflict of interest resulting from the current ownership or beneficial interest of each individual making the disclosure having any of the relationships identified in Section 50-35 and on the disclosure form.

The current annual salary of the Governor is \$177,412.00.

In addition, all disclosures shall indicate any other current or pending contracts, subcontracts, proposals, leases, or other ongoing procurement relationships the subcontracting entity has with any other unit of state government and shall clearly identify the unit and the contract, subcontract, proposal, lease, or other relationship.

2. Disclosure Forms. Disclosure Form A is attached for use concerning the individuals meeting the above ownership or distributive share requirements. A separate Disclosure Form A must be submitted with the bid for each individual meeting the above requirements. In addition, a second form (Disclosure Form B) provides for the disclosure of current or pending procurement relationships with other (non-IDOT) state agencies and a total ownership certification.

C. Disclosure Form Instructions

Form A Instructions for Financial Information & Potential Conflicts of Interest

If the subcontractor is a publicly traded entity subject to Federal 10K reporting, the 10K Report may be submitted to meet the requirements of Form A. If a subcontractor is a privately held entity that is exempt from Federal 10K reporting, but has more than 100 shareholders, it may submit the information that Federal 10K companies are required to report, and list the names of any individual or entity holding any ownership share that is in excess of 5%. If a subcontractor is not subject to Federal 10K reporting, the subcontractor must determine if any individuals are required by law to complete a financial disclosure form. To do this, the subcontractor should answer each of the following questions. A "YES" answer indicates Form A must be completed. If the answer to each of the following questions is "NO", then the **NOT APPLICABLE STATEMENT** on the second page of Form A must be signed and dated by an individual that is authorized to execute contracts for the subcontracting company. Note: These questions are for assistance only and are not required to be completed.

1. Does anyone in your organization have a direct or beneficial ownership share of greater than 5% of the bidding entity or parent entity? YES ___ NO ___
2. Does anyone in your organization have a direct or beneficial ownership share of less than 5%, but which has a value greater than 60% of the annual salary of the Governor? YES ___ NO ___
3. Does anyone in your organization receive more than 60% of the annual salary of the Governor of the subcontracting entity's or parent entity's distributive income? YES ___ NO ___

(Note: Distributive income is, for these purposes, any type of distribution of profits. An annual salary is not distributive income.)

4. Does anyone in your organization receive greater than 5% of the subcontracting entity's or parent entity's total distributive income, but which is less than 60% of the annual salary of the Governor? YES ___ NO ___

(Note: Only one set of forms needs to be completed per individual per subcontract even if a specific individual would require a yes answer to more than one question.)

A "YES" answer to any of these questions requires the completion of Form A. The subcontractor must determine each individual in the subcontracting entity or the subcontracting entity's parent company that would cause the questions to be answered "Yes". Each form must be signed and dated by an individual that is authorized to execute contracts for your organization. The individual signing can be, but does not have to be, the individual for which the form is being completed. The subcontractor is responsible for the accuracy of any information provided.

If the answer to each of the above questions is "NO", then the **NOT APPLICABLE STATEMENT** on page 2 of Form A must be signed and dated by an individual that is authorized to execute contracts for your company.

RETURN WITH SUBCONTRACT

Form B: Instructions for Identifying Other Contracts & Procurement Related Information

Disclosure Form B must be completed for each subcontract submitted by the subcontracting entity. *Note: Checking the NOT APPLICABLE STATEMENT on Form A does not allow the subcontractor to ignore Form B. Form B must be completed, checked, and dated or the subcontract will not be approved.*

The Subcontractor shall identify, by checking Yes or No on Form B, whether it has any pending contracts, subcontracts, leases, bids, proposals, or other ongoing procurement relationship with any other (non-IDOT) State of Illinois agency. If "No" is checked, the subcontractor only needs to complete the check box on the bottom of Form B. If "Yes" is checked, the subcontractor must list all non-IDOT State of Illinois agency pending contracts, subcontracts, leases, bids, proposals, and other ongoing procurement relationships. These items may be listed on Form B or on an attached sheet(s). Contracts with cities, counties, villages, etc. are not considered State of Illinois agency contracts and are not to be included. Contracts or subcontracts with other State of Illinois agencies such as the Department of Natural Resources or the Capital Development Board must be included.

**ILLINOIS DEPARTMENT
OF TRANSPORTATION**

**Form A
Subcontractor: Financial
Information & Potential Conflicts
of Interest Disclosure**

Subcontractor Name		
Legal Address		
City, State, Zip		
Telephone Number	Email Address	Fax Number (if available)

Disclosure of the information contained in this Form is required by Section 50-35 of the Code (30 ILCS 500). Subcontractors desiring to enter into a subcontract of a State of Illinois contract must disclose the financial information and potential conflict of interest information as specified in this Disclosure Form. This information shall become part of the publicly available contract file. This Form A must be completed for subcontracts with a total value of \$50,000 or more, from subcontractors identified in Section 20-120 of the Code, and for all open-ended contracts. **A publicly traded company may submit a 10K disclosure (or equivalent if applicable) in satisfaction of the requirements set forth in Form A. See Disclosure Form Instructions.**

The current annual salary of the Governor is \$177,412.00.

DISCLOSURE OF FINANCIAL INFORMATION

1. Disclosure of Financial Information. The individual named below has an interest in the SUBCONTRACTOR (or its parent) in terms of ownership or distributive income share in excess of 5%, or an interest which has a value of more than 60% of the annual salary of the Governor. **(Make copies of this form as necessary and attach a separate Disclosure Form A for each individual meeting these requirements)**

FOR INDIVIDUAL (type or print information)	
NAME:	_____
ADDRESS	_____
Type of ownership/distributable income share:	
stock _____ sole proprietorship _____ Partnership _____ other: (explain on separate sheet):	
% or \$ value of ownership/distributable income share:	_____

2. Disclosure of Potential Conflicts of Interest. Check "Yes" or "No" to indicate which, if any, of the following potential conflict of interest relationships apply. If the answer to any question is "Yes", please attach additional pages and describe.

(a) State employment, currently or in the previous 3 years, including contractual employment of services.

Yes ___ No ___

If your answer is yes, please answer each of the following questions.

1. Are you currently an officer or employee of either the Capitol Development Board or the Illinois State Toll Highway Authority? Yes ___ No ___

2. Are you currently appointed to or employed by any agency of the State of Illinois? If you are currently appointed to or employed by any agency of the State of Illinois, and your annual salary exceeds 60% of the annual salary of the Governor, provide the name the State agency for which you are employed and your annual salary. _____

RETURN WITH SUBCONTRACT

3. If you are currently appointed to or employed by any agency of the State of Illinois, and your annual salary exceeds 60% of the annual salary of the Governor, are you entitled to receive (i) more than 7 1/2% of the total distributable income of your firm, partnership, association or corporation, or (ii) an amount in excess of 100% of the annual salary of the Governor?
Yes ___ No ___

4. If you are currently appointed to or employed by any agency of the State of Illinois, and your annual salary exceeds 60% of the annual salary of the Governor, are you and your spouse or minor children entitled to receive (i) more than 15 % in the aggregate of the total distributable income of your firm, partnership, association or corporation, or (ii) an amount in excess of two times the salary of the Governor?
Yes ___ No ___

(b) State employment of spouse, father, mother, son, or daughter, including contractual employment services in the previous 2 years.

Yes ___ No ___

If your answer is yes, please answer each of the following questions.

1. Is your spouse or any minor children currently an officer or employee of the Capitol Development Board or the Illinois Toll Highway Authority?
Yes ___ No ___

2. Is your spouse or any minor children currently appointed to or employed by any agency of the State of Illinois? If your spouse or minor children is/are currently appointed to or employed by any agency of the State of Illinois, and his/her annual salary exceeds 60% of the annual salary of the Governor, provide the name of your spouse and/or minor children, the name of the State agency for which he/she is employed and his/her annual salary. _____

3. If your spouse or any minor children is/are currently appointed to or employed by any agency of the State of Illinois, and his/her annual salary exceeds 60% of the annual salary of the Governor, as of 7/1/07) are you entitled to receive (i) more then 7 1/2% of the total distributable income of your firm, partnership, association or corporation, or (ii) an amount in excess of 100% of the annual salary of the Governor?
Yes ___ No ___

4. If your spouse or any minor children are currently appointed to or employed by any agency of the State of Illinois, and his/her annual salary exceeds 60% of the annual salary of the Governor, are you and your spouse or minor children entitled to receive (i) more than 15 % in the aggregate of the total distributable income of your firm, partnership, association or corporation, or (ii) an amount in excess of two times the annual salary of the Governor?
Yes ___ No ___

(c) Elective status; the holding of elective office of the State of Illinois, the government of the United States, any unit of local government authorized by the Constitution of the State of Illinois or the statutes of the State of Illinois currently or in the previous 3 years.
Yes ___ No ___

(d) Relationship to anyone holding elective office currently or in the previous 2 years; spouse, father, mother, son, or daughter.
Yes ___ No ___

(e) Appointive office; the holding of any appointive government office of the State of Illinois, the United States of America, or any unit of local government authorized by the Constitution of the State of Illinois or the statutes of the State of Illinois, which office entitles the holder to compensation in excess of the expenses incurred in the discharge of that office currently or in the previous 3 years.
Yes ___ No ___

(f) Relationship to anyone holding appointive office currently or in the previous 2 years; spouse, father, mother, son, or daughter.
Yes ___ No ___

(g) Employment, currently or in the previous 3 years, as or by any registered lobbyist of the State government.
Yes ___ No ___

RETURN WITH SUBCONTRACT

(h) Relationship to anyone who is or was a registered lobbyist in the previous 2 years; spouse, father, mother, son, or daughter. Yes ___ No ___

(i) Compensated employment, currently or in the previous 3 years, by any registered election or reelection committee registered with the Secretary of State or any county clerk of the State of Illinois, or any political action committee registered with either the Secretary of State or the Federal Board of Elections. Yes ___ No ___

(j) Relationship to anyone; spouse, father, mother, son, or daughter; who was a compensated employee in the last 2 years by any registered election or re-election committee registered with the Secretary of State or any county clerk of the State of Illinois, or any political action committee registered with either the Secretary of State or the Federal Board of Elections. Yes ___ No ___

3 Communication Disclosure.

Disclose the name and address of each lobbyist and other agent of the bidder or offeror who is not identified in Section 2 of this form, who is has communicated, is communicating, or may communicate with any State officer or employee concerning the bid or offer. This disclosure is a continuing obligation and must be promptly supplemented for accuracy throughout the process and throughout the term of the contract. If no person is identified, enter "None" on the line below:

Name and address of person(s): _____

RETURN WITH SUBCONTRACT

4. Suspension or Debarment Disclosure. For each of the persons identified under Sections 2 and 3 of this form, disclose whether any of the following has occurred within the previous 10 years: suspension or debarment from contracting with any governmental entity; professional licensure discipline; bankruptcies; adverse civil judgments and administrative findings; and criminal felony convictions. This disclosure is a continuing obligation and must be promptly supplemented for accuracy throughout the procurement process and term of the contract. If no person is identified, enter "None" on the line below:

Name of person(s): _____

Nature of disclosure: _____

APPLICABLE STATEMENT

This Disclosure Form A is submitted on behalf of the INDIVIDUAL named on previous page. Under penalty of perjury, I certify the contents of this disclosure to be true and accurate to the best of my knowledge.

Completed by: _____ Date _____
Signature of Individual or Authorized Officer

NOT APPLICABLE STATEMENT

Under penalty of perjury, I have determined that no individuals associated with this organization meet the criteria that would require the completion of this Form A.

This Disclosure Form A is submitted on behalf of the SUBCONTRACTOR listed on the previous page.

_____ Date _____
Signature of Authorized Officer

RETURN WITH SUBCONTRACT

ILLINOIS DEPARTMENT OF TRANSPORTATION

Form B
Subcontractor: Other Contracts & Financial Related Information Disclosure

Form with fields: Subcontractor Name, Legal Address, City, State, Zip, Telephone Number, Email Address, Fax Number (if available)

Disclosure of the information contained in this Form is required by Section 50-35 of the Code (30 ILCS 500). This information shall become part of the publicly available contract file. This Form B must be completed for subcontracts with a total value of \$50,000 or more, from subcontractors identified in Section 20-120 of the Code, and for all open-ended contracts.

DISCLOSURE OF OTHER CONTRACTS, SUBCONTRACTS, AND PROCUREMENT RELATED INFORMATION

1. Identifying Other Contracts & Procurement Related Information. The SUBCONTRACTOR shall identify whether it has any pending contracts, subcontracts, including leases, bids, proposals, or other ongoing procurement relationship with any other State of Illinois agency: Yes ___ No ___

If "No" is checked, the subcontractor only needs to complete the signature box on this page.

2. If "Yes" is checked. Identify each such relationship by showing State of Illinois agency name and other descriptive information such as bid or project number (attach additional pages as necessary). SEE DISCLOSURE FORM INSTRUCTIONS:

THE FOLLOWING STATEMENT MUST BE CHECKED

Signature box with fields: Signature of Authorized Representative, Date

OWNERSHIP CERTIFICATION

Please certify that the following statement is true if the individuals for all submitted Form A disclosures do not total 100% of ownership

Any remaining ownership interest is held by individuals receiving less than \$106,447.20 of the bidding entity's or parent entity's distributive income or holding less than a 5% ownership interest.

Yes No N/A (Form A disclosure(s) established 100% ownership)



NOTICE TO BIDDERS

1. TIME AND PLACE OF OPENING BIDS. Sealed proposals for the improvement described herein will be received by the Department of Transportation. Electronic bids are to be submitted to the electronic bidding system (iCX-Integrated Contractors Exchange). Paper-based bids are to be submitted to the Chief Procurement Officer for the Department of Transportation in care of the Chief Contracts Official at the Harry R. Hanley Building, 2300 South Dirksen Parkway, in Springfield, Illinois until 10:00 a.m. November 4, 2016. All bids will be gathered, sorted, publicly opened and read in the auditorium at the Department of Transportation's Harry R. Hanley Building shortly after 10:00 a.m.

2. DESCRIPTION OF WORK. The proposed improvement is identified and advertised for bids in the Invitation for Bids as:

**Contract No. 64L73
HENRY County
Section D2 RS 2017-2
Routes FAU 5862 & 5863
District 2 Construction Funds**

This project consists of HMA resurfacing on Poppy Garden Road from IL 84 to Green River Road and on Green River Road from Exchange Street to US 6.

3. INSTRUCTIONS TO BIDDERS. (a) This Notice, the invitation for bids, proposal and letter of award shall, together with all other documents in accordance with Article 101.09 of the Standard Specifications for Road and Bridge Construction, become part of the contract. Bidders are cautioned to read and examine carefully all documents, to make all required inspections, and to inquire or seek explanation of the same prior to submission of a bid.

(b) State law, and, if the work is to be paid wholly or in part with Federal-aid funds, Federal law requires the bidder to make various certifications as a part of the proposal and contract. By execution and submission of the proposal, the bidder makes the certification contained therein. A false or fraudulent certification shall, in addition to all other remedies provided by law, be a breach of contract and may result in termination of the contract.

4. AWARD CRITERIA AND REJECTION OF BIDS. This contract will be awarded to the lowest responsive and responsible bidder considering conformity with the terms and conditions established by the Department in the rules, Invitation for Bids and contract documents. The issuance of plans and proposal forms for bidding based upon a prequalification rating shall not be the sole determinant of responsibility. The Department reserves the right to determine responsibility at the time of award, to reject any or all proposals, to readvertise the proposed improvement, and to waive technicalities.

By Order of the
Illinois Department of Transportation

Randall S. Blankenhorn,
Secretary

INDEX
FOR
SUPPLEMENTAL SPECIFICATIONS
AND RECURRING SPECIAL PROVISIONS

Adopted April 1, 2016

This index contains a listing of SUPPLEMENTAL SPECIFICATIONS, frequently used RECURRING SPECIAL PROVISIONS, and LOCAL ROADS AND STREETS RECURRING SPECIAL PROVISIONS.

No ERRATA this year.

SUPPLEMENTAL SPECIFICATIONS

Std. Spec. Sec.

Page No.

No Supplemental Specifications this year.

RECURRING SPECIAL PROVISIONS

The following RECURRING SPECIAL PROVISIONS indicated by an "X" are applicable to this contract and are included by reference:

<u>CHECK SHEET #</u>		<u>PAGE NO.</u>
1	Additional State Requirements for Federal-Aid Construction Contracts	1
2	Subletting of Contracts (Federal-Aid Contracts)	4
3	X EEO	5
4	X Specific EEO Responsibilities Non Federal-Aid Contracts	15
5	X Required Provisions - State Contracts	20
6	Asbestos Bearing Pad Removal	26
7	Asbestos Waterproofing Membrane and Asbestos HMA Surface Removal	27
8	Temporary Stream Crossings and In-Stream Work Pads	28
9	Construction Layout Stakes Except for Bridges	29
10	Construction Layout Stakes	32
11	Use of Geotextile Fabric for Railroad Crossing	35
12	Subsealing of Concrete Pavements	37
13	Hot-Mix Asphalt Surface Correction	41
14	Pavement and Shoulder Resurfacing	43
15	Patching with Hot-Mix Asphalt Overlay Removal	44
16	Polymer Concrete	45
17	PVC Pipeliner	47
18	Bicycle Racks	48
19	Temporary Portable Bridge Traffic Signals	50
20	Work Zone Public Information Signs	52
21	Nighttime Inspection of Roadway Lighting	53
22	English Substitution of Metric Bolts	54
23	Calcium Chloride Accelerator for Portland Cement Concrete	55
24	Quality Control of Concrete Mixtures at the Plant	56
25	Quality Control/Quality Assurance of Concrete Mixtures	64
26	Digital Terrain Modeling for Earthwork Calculations	80
27	Pavement Marking Removal	82
28	Preventive Maintenance – Bituminous Surface Treatment	83
29	Preventive Maintenance – Cape Seal	89
30	Preventive Maintenance – Micro-Surfacing	104
31	Preventive Maintenance – Slurry Seal	115
32	Temporary Raised Pavement Markers	125
33	Restoring Bridge Approach Pavements Using High-Density Foam	126

TABLE OF CONTENTS

LOCATION OF PROJECT	1
DESCRIPTION OF PROJECT	1
TRAFFIC CONTROL PLAN	1
HOT-MIX ASPHALT SURFACE COURSE, LEVEL BINDER, AND BINDER	4
HOT-MIX ASPHALT MIXTURE IL-9.5FG (BMPR)	4
RAILROAD PROTECTIVE LIABILITY INSURANCE (5 AND 10) (BDE)	8
AUTOMATED FLAGGER ASSISTANCE DEVICES (BDE)	9
BUTT JOINTS (BDE)	10
COARSE AGGREGATE QUALITY (BDE)	12
DISADVANTAGED BUSINESS ENTERPRISE PARTICIPATION (BDE)	13
EQUAL EMPLOYMENT OPPORTUNITY (BDE)	25
ERRATA FOR THE 2016 STANDARD SPECIFICATIONS (BDE)	28
HOT-MIX ASPHALT - DENSITY TESTING OF LONGITUDINAL JOINTS (BDE)	31
HOT-MIX ASPHALT – TACK COAT (BDE)	32
PROGRESS PAYMENTS (BDE)	32
RECLAIMED ASPHALT PAVEMENT AND RECLAIMED ASPHALT SHINGLES (BDE)	33
WARM MIX ASPHALT (BDE)	43
WEEKLY DBE TRUCKING REPORTS (BDE)	45
WORKING DAYS (BDE)	45
BITUMINOUS MATERIALS COST ADJUSTMENTS (BDE) (RETURN FORM WITH BID)	45
VETERAN BUSINESS PROGRAM	48

STATE OF ILLINOIS

SPECIAL PROVISIONS

The following Special Provisions supplement the “Standard Specifications for Road and Bridge Construction, Adopted April 1, 2016”, the latest edition of the “Manual on Uniform Traffic Control Devices for Streets and Highways”, and the “Manual of Test Procedures for Materials” in effect on the date of invitation for bids, and the “Supplemental Specifications and Recurring Special Provisions” indicated on the Check Sheet included herein, which apply to and govern the construction of FAU Route 5862 (Poppy Garden Road), FAU Route 5863 (Green River Road), Section D2 RS 2017-2, Henry County, Contract No. 64L73, and in case of conflict with any part, or parts, of said Specifications, the said Special Provisions shall take precedence and shall govern.

LOCATION OF PROJECT

Poppy Garden Road from IL 84 to Green River Road, Green River Road from Exchange Street to US 6.

DESCRIPTION OF PROJECT

Hot-mix asphalt resurfacing.

TRAFFIC CONTROL PLAN

Effective: January 14, 1999

Revised: July 20, 2016

Traffic Control shall be according to the applicable sections of the Standard Specifications for Road and Bridge Construction, the applicable guidelines contained in the National Manual on Uniform Traffic Control Devices for Streets and Highways, Illinois Supplement to the National Manual on Uniform Traffic Control Devices, these special provisions, and any special details and Highway Standards contained herein and in the plans.

Special attention is called to Articles 107.09 and 107.14 of the Standard Specifications for Road and Bridge Construction and the following Highway Standards relating to traffic control.

Standards:

701006 701301 701306 701311 701901

Signs:

No bracing shall be allowed on post-mounted signs.

Post-mounted signs shall be installed using standard 720011, 728001, 729001, on 4"x4" wood posts, or on any other "break away" connection if accepted by the FHWA and corresponding letter is provided to the resident.

"BUMP" (W8-1(O)48) signs shall be installed as directed by the Engineer.

"UNEVEN LANES" W8-11(O)48 signs shall be installed at 1 mile intervals or as directed by the Engineer.

"LOW SHOULDER" W8-9(O)48 signs shall be installed at 1 mile intervals or as directed by the Engineer.

"NO PASSING ZONES NOT STRIPED NEXT ___ MILES" (G20-I 100(O)) signs shall be 60" x 36".

When covering existing Department signs, no tape shall be used on the reflective portion of the sign. Contact the District sign shop for covering techniques.

All regulatory signs shall be maintained at a 5 foot minimum bottom (rural), 7 foot minimum (urban).

Any plates or direct applied sheeting used to alter signs shall have the same sheeting as the base sign.

No more than one kind of alteration shall be used to alter a sign.

Any post stubs without a sign in place and visible shall have a reflector placed on each post.

Devices:

Cones or reflectorized cones shall not be used during hours of darkness.

A minimum of 3 drums spaced at 4 feet shall be placed at each return when the sideroad is open.

On all standards and devices listed in Section 701 of the Standard Specifications, the device spacing shall be revised to the following dimensions:

Where the spacing shown on the standard is 25 feet, the devices shall be placed at 20 feet.
Where the spacing shown on the standard is 50 feet, the devices shall be placed at 40 feet.
Where the spacing shown on the standard is 100 feet, the devices shall be placed at 80 feet.

Flaggers:

Flagger at Sideroads and Commercial Entrances:

Effective: August 1, 2011

Revised: December 29, 2015

Flaggers shall comply with all requirements and signaling methods contained in the Department's latest edition of the "Traffic Control Field Manual" current at the time of letting. The flagger equipment listed for flaggers employed by the Illinois Department of Transportation shall apply to all flaggers

All workers and flaggers shall wear ANSI Class E pants and an ANSI Class 2 vest that in combination meet the requirements of ANSI/ISEA 107-2004 for Conspicuity Class 3 garments during hours of darkness.

In addition to the flaggers shown on applicable standards, on major sideroads, flaggers shall be required on all legs of the intersection. Major intersections for this project shall be US 6 & Green River Road, IL 84 & Poppy Garden Road, and Poppy Garden Road & Green River Road.

In addition to the flaggers shown on applicable standards, a flagger shall be required on high volume commercial entrances listed below. High volume commercial entrances for this project shall be none.

When the mainline flagger is within 200 feet of an intersection, the sideroad flagger shall be required.

When the road is closed to through traffic and it is necessary to provide access for local traffic, all flaggers as shown on the applicable standards will be required. No reduction in the number of flaggers shall be allowed.

Revise Article 701.20(i) of the Standard Specifications to read:

"Signs, barricades, other traffic control devices, or flaggers required by the Engineer, over and above those shown in the contract documents, will be paid for according to Article 109.04."

Pavement Marking:

Short term pavement markings on a milled surface shall be paint.

Maintenance of Traffic:

The mainline shall be kept open to one-way traffic at all times during working hours and two-way traffic during non-working hours.

The Contractor shall have all lanes open from 7:00 PM Friday until 6:00 AM Monday, unless prior approval is obtained from the Resident Engineer.

The milling, resurfacing and placing of shoulder aggregate shall be completed using Traffic Control and Protection Standard 701306.

Placing and removing pavement marking shall be completed using Traffic Control and Protection Standard 701306 or 701311.

HOT-MIX ASPHALT SURFACE COURSE, LEVEL BINDER, AND BINDER

Effective: June 15, 2010

Revised: June 23, 2014

The maximum allowed average bulk specific gravity for the approved mix design (Gmb) will be:

2.460 for Mixture C

2.470 for Mixture D

2.610 for Mixture E

2.710 for Mixture F

The maximum allowed average bulk specific gravity for the approved mix design (Gmb) for all other uses will be 2.470.

HOT-MIX ASPHALT MIXTURE IL-9.5FG (BMPR)

Effective: July 1, 2005

Revised: December 28, 2010

Description. This work shall consist of constructing fine graded hot-mix asphalt (HMA) surface course or leveling binder with an IL-9.5FG mixture. Work shall be according to Sections 406, 407 and 1030 of the Standard Specifications, except as modified herein.

Materials. Revise Article 1003.03(c) of the Standard Specifications to read:

“(c) Gradation. The fine aggregate gradation for all HMA shall be FA 1, FA 2, FA 20, or FA 21. For mixture IL-9.5FG, the fine aggregate fraction shall consist of at least 67 percent manufactured sand meeting FA 20 gradation. The manufactured sand shall be stone sand, slag sand, steel slag sand, or combinations thereof.”

Mixture Design. Add the following to the table in Article 1030.04(a)(1):

"High ESAL, MIXTURE COMPOSITION (% PASSING) ^{1/}		
Sieve Size	IL-9.5FG	
	min	max
1 1/2 in (37.5 mm)		
1 in. (25 mm)		
3/4 in. (19 mm)		
1/2 in. (12.5 mm)		100
3/8 in. (9.5 mm)	90	100
#4 (4.75 mm)	60 ^{4/}	75 ^{4/}
#8 (2.36 mm)	45 ^{4/}	60 ^{4/}
#16 (1.18 mm)	25	40
#30 (600 μm)	15	30
#50 (300 μm)	8	15
#100 (150 μm)	6	10
#200 (75 μm)	4	6.5
Ratio Dust/Asphalt Binder		1.0

4/ When used as level binder placed less than 1 in. (25 mm) thick, the min and max percent passing shall each be increased 5%.

Revise the table in Article 1030.04(b)(1) of the Standard Specifications to read:

"VOLUMETRIC REQUIREMENTS High ESAL					
N _{design}	Voids in the Mineral Aggregate (VMA), % minimum				Voids Filled with Asphalt Binder (VFA), %
	IL-25.0	IL-19.0	IL-12.5	IL-9.5	
50	12.0	13.0	14.0	15 ^{1/}	65 - 78
70					65 - 75 ^{2/}
90					
105					

1/ The VMA for IL-9.5FG shall be a minimum of 15.0 percent.

2/ The VFA range for IL-9.5FG shall be 65 - 78 percent."

Quality Control/Quality Assurance (QC/QA). Revise the second table in Article 1030.05(d)(4) to read:

DENSITY CONTROL LIMITS			
Mixture Composition		Parameter	Individual Test ^{3/}
IL-9.5FG	Lifts < 1.25 in. (32 mm)	N _{design} 50 - 105	91.0 – 97.0% ^{2/}
	Lifts ≥ 1.25 in. (32 mm)	N _{design} 50 - 105	93.0 – 97.0%
IL-9.5, IL-12.5		N _{design} ≥ 90	92.0 – 96.0 %
IL-9.5, IL-9.5L, IL-12.5		N _{design} < 90	92.5 – 97.4 %
IL-19.0, IL-25.0		N _{design} ≥ 90	93.0 – 96.0 %
IL-19.0, IL-19.0L, IL-25.0		N _{design} < 90	93.0 – 97.4 %
All Other		N _{design} = 30	93.0 ^{1/} - 97.4 %

- 1/ 92.0 % when placed as first lift on an unimproved subgrade.
- 2/ Density shall be determined by cores or by correlated, approved thin lift nuclear gauge.
- 3/ Bulk Specific Gravity and Density that are determined using coated samples must be in accordance with ASTM 1188-96.

CONSTRUCTION REQUIREMENTS

Leveling Binder. Revise the table and second paragraph of Article 406.05(c) of the Standard Specifications to read:

"Leveling Binder	
Nominal, Compacted, Leveling Binder Thickness, in. (mm)	Mixture Composition
≤ 1 1/4 (32)	IL-9.5, IL-9.5 FG, or IL-9.5L
> 1 1/4 to 2 (32 to 50)	IL-9.5, IL-9.5FG, IL-9.5L, or IL-12.5

The density requirements of Article 1030.05(d)(4) shall apply for leveling binder, machine method, when the nominal, compacted thickness is: 3/4 in. (19 mm) or greater for IL-9.5FG mixtures, 1 1/4 in. (32 mm) or greater for IL-9.5 and IL-9.5L mixtures, and 1 1/2 in. (38 mm) or greater for IL-12.5 mixtures."

Compaction. Revise Table 1 in Article 406.07(a) of the Standard Specifications to read:

"TABLE 1 - MINIMUM ROLLER REQUIREMENTS FOR HMA				
	Breakdown Roller (one of the following)	Intermediate Roller	Final Roller (one or more of the following)	Density Requirement
Level Binder: (When the density requirements of Article 406.05(c) do not apply.)	P 3/	- -	VS, P 3/, TB, TF, 3W	To the satisfaction of the Engineer.
Level Binder: (When placed at $\leq 1 \frac{1}{4}$ (32 mm) and density requirements apply.)	TB, 3W	P 3/	VS, TB, TF	As specified in Articles: 1030.05(d)(3), (d)(4), and (d)(7).
Binder and Surface 1/ (When the density requirements of Article 406.05(c) apply.)	VD, P 3/, TB, 3W	P 3/	VS, TB, TF	As specified in Articles: 1030.05(d)(3), (d)(4), and (d)(7).
Bridge Decks 2/	TB	- -	TF	As specified in Articles: 582.05 and 582.06.

- 1/ If the average delivery at the job site is 85 ton/hr (75 metric ton/hr) or less, any roller combination may be used provided it includes a steel wheeled roller and the required density and smoothness is obtained.
- 2/ One TB may be used for both breakdown and final rolling on bridge decks 300 ft (90 m) or less in length, except when the air temperature is less than 60 °F (15 °C).
- 3/ A vibratory roller (VD) may be used in lieu of the pneumatic-tired roller on mixtures containing polymer modified asphalt binder.

Basis of Payment. Add the following two paragraphs after the third paragraph of Article 406.14 of the Standard Specifications:

"Mixture IL-9.5FG will be paid for at the contract unit price per ton (metric ton) for LEVELING BINDER (HAND METHOD), IL-9.5FG, of the Ndesign specified; LEVELING BINDER (MACHINE METHOD), IL-9.5FG, of the Ndesign specified; or HOT-MIX ASPHALT SURFACE COURSE, IL-9.5FG, of the Ndesign specified.

Mixture IL-9.5FG in which polymer modified asphalt binders are required will be paid for at the contract unit price per ton (metric ton) for POLYMERIZED LEVELING BINDER (HAND METHOD), IL-9.5FG, of the Ndesign specified; POLYMERIZED LEVELING BINDER (MACHINE METHOD), IL-9.5FG, of the Ndesign specified; or POLYMERIZED HOT-MIX ASPHALT SURFACE COURSE, IL-9.5FG, of the Ndesign specified."

RAILROAD PROTECTIVE LIABILITY INSURANCE (5 AND 10) (BDE)

Effective: January 1, 2006

Description. Railroad Protective Liability and Property Damage Liability Insurance shall be carried according to Article 107.11 of the Standard Specifications, except the limits shall be a minimum of \$5,000,000 combined single limit per occurrence for bodily injury liability and property damage liability with an aggregate limit of \$10,000,000 over the life of the policy. A separate policy is required for each railroad unless otherwise noted.

<u>NUMBER & SPEED OF NAMED INSURED & ADDRESS</u>	<u>NUMBER & SPEED OF PASSENGER TRAINS</u>	<u>FREIGHT TRAINS</u>
The BNSF Railway Company 80 – 44 th Avenue N.E. Minneapolis, Minnesota 55421	0	27 per day at 30 MPH

Calvin Nutt, Manager of Public Projects – IA, IL,WI

DOT/AAR No.: 065 664U RR Mile Post: 39.98
RR Division: Chicago RR Sub-Division: Barstow

For Freight/Passenger Information Contact: Brian Langloss Phone: (406)670-9935
Manager of Track Maintenance (MTM) brian.langloss@bnsf.com

For Insurance Information Contact: Rosa Martinez at Marsh USA Phone: (214)303-8519

Comments:

Railroad flaggers are required if working within 25 feet of the tracks. Contact Travis Boardman at least one week in advance to schedule a flagger.

Approval of Insurance. The original and one certified copy of each required policy shall be submitted to the following address for approval:

Illinois Department of Transportation
Bureau of Design and Environment
2300 South Dirksen Parkway, Room 326
Springfield, Illinois 62764

The Contractor will be advised when the Department has received approval of the insurance from the railroad(s). Before any work begins on railroad right-of-way, the Contractor shall submit to the Engineer evidence that the required insurance has been approved by the railroad(s). The Contractor shall also provide the Engineer with the expiration date of each required policy.

Basis of Payment. Providing Railroad Protective Liability and Property Damage Liability Insurance will be paid for at the contract unit price per Lump Sum for RAILROAD PROTECTIVE LIABILITY INSURANCE.

AUTOMATED FLAGGER ASSISTANCE DEVICES (BDE)

Effective: January 1, 2008

Description. This work shall consist of furnishing and operating automated flagger assistance devices (AFADs) as part of the work zone traffic control and protection for two-lane highways where two-way traffic is maintained over one lane of pavement. Use of these devices shall be at the option of the Contractor.

Equipment. AFADs shall be according to the FHWA memorandum, "MUTCD - Revised Interim Approval for the use of Automated Flagger Assistance Devices in Temporary Traffic Control Zones (IA-4R)", dated January 28, 2005. The devices shall be mounted on a trailer or a moveable cart and shall meet the requirements of NCHRP 350, Category 4.

The AFAD shall be the Stop/Slow type. This device uses remotely controlled "STOP" and "SLOW" signs to alternately control right-of-way.

Signs for the AFAD shall be according to Article 701.03 of the Standard Specifications and the MUTCD. The signs shall be 24 x 24 in. (600 x 600 mm) having an octagon shaped "STOP" sign on one side and a diamond shaped "SLOW" sign on the opposite side. The letters on the signs shall be 8 in. (200 mm) high. If the "STOP" sign has louvers, the full sign face shall be visible at a distance of 50 ft (15 m) and greater.

The signs shall be supplemented with one of the following types of lights.

- (a) Flashing Lights. When flashing lights are used, white or red flashing lights shall be mounted within the "STOP" sign face and white or yellow flashing lights within the "SLOW" sign face.
- (b) Stop and Warning Beacons. When beacons are used, a stop beacon shall be mounted 24 in. (600 mm) or less above the "STOP" sign face and a warning beacon mounted 24 in. (600 mm) or less above, below, or to the side of the "SLOW" sign face. As an option, a Type B warning light may be used in lieu of the warning beacon.

A "WAIT ON STOP" sign shall be placed on the right hand side of the roadway at a point where drivers are expected to stop. The sign shall be 24 x 30 in. (600 x 750 mm) with a black legend and border on a white background. The letters shall be at least 6 in. (150 mm) high.

This device may include a gate arm or mast arm that descends to a horizontal position when the "STOP" sign is displayed and rises to a vertical position when the "SLOW" sign is displayed. When included, the end of the arm shall reach at least to the center of the lane being controlled. The arm shall have alternating red and white retroreflective stripes, on both sides, sloping downward at 45 degrees toward the side on which traffic will pass. The stripes shall be 6 in. (150 mm) in width and at least 2 in. (50 mm) in height.

Flagging Requirements. Flaggers and flagging requirements shall be according to Article 701.13 of the Standard Specifications and the following.

AFADs shall be placed at each end of the traffic control, where a flagger is shown on the plans. The flaggers shall be able to view the face of the AFAD and approaching traffic during operation.

To stop traffic, the "STOP" sign shall be displayed, the corresponding lights/beacon shall flash, and when included, the gate arm shall descend to a horizontal position. To permit traffic to move, the "SLOW" sign shall be displayed, the corresponding lights/beacon shall flash, and when included, the gate arm shall rise to a vertical position.

If used at night, the AFAD location shall be illuminated according to Section 701 of the Standard Specifications.

When not in use, AFADs will be considered nonoperating equipment and shall be stored according to Article 701.11 of the Standard Specifications.

Basis of Payment. This work will not be paid for separately but shall be considered as included in the cost of the various traffic control items included in the contract.

BUTT JOINTS (BDE)

Effective: July 1, 2016

Add the following to Article 406.08 of the Standard Specifications.

- "(c) Temporary Plastic Ramps. Temporary plastic ramps shall be made of high density polyethylene meeting the properties listed below. Temporary plastic ramps shall only be used on roadways with permanent posted speeds of 55 mph or less. The ramps shall have a minimum taper rate of 1:30 (V:H). The leading edge of the plastic ramp shall have a maximum thickness of 1/4 in. (6 mm) and the trailing edge shall match the height of the adjacent pavement \pm 1/4 in. (\pm 6 mm).

The ramp will be accepted by certification. The Contractor shall furnish a certification from the manufacturer stating the temporary plastic ramp meets the following requirements.

Physical Property	Test Method	Requirement
Melt Index	ASTM D 1238	8.2 g/10 minutes
Density	ASTM D 1505	0.965 g/cc
Tensile Strength @ Break	ASTM D 638	2223 psi (15 MPa)
Tensile Strength @ Yield	ASTM D 638	4110 psi (28 MPa)
Elongation @ Yield ^{1/} , percent	ASTM D 638	7.3 min.
Durometer Hardness, Shore D	ASTM D 2240	65
Heat Deflection Temperature, 66 psi	ASTM D 648	176 °F (80 °C)
Low Temperature Brittleness, F ₅₀	ASTM D 746	<-105 °F (<-76 °C)

1/ Crosshead speed -2 in./minute

The temporary plastic ramps shall be installed according to the manufacturer's specifications and fastened with anchors meeting the manufacturer's recommendations. Temporary plastic ramps that fail to stay in place or create a traffic hazard shall be replaced immediately with temporary HMA ramps at the Contractor's expense."

COARSE AGGREGATE QUALITY (BDE)

Effective: July 1, 2015

Revise Article 1004.01(b) of the Standard Specifications to read:

“(b) Quality. The coarse aggregate shall be according to the quality standards listed in the following table.

COARSE AGGREGATE QUALITY				
QUALITY TEST	CLASS			
	A	B	C	D
Na ₂ SO ₄ Soundness 5 Cycle, ITP 104 ^{1/} , % Loss max.	15	15	20	25 ^{2/}
Los Angeles Abrasion, ITP 96 ^{11/} , % Loss max.	40 ^{3/}	40 ^{4/}	40 ^{5/}	45
Minus No. 200 (75 µm) Sieve Material, ITP 11	1.0 ^{6/}	---	2.5 ^{7/}	---
Deleterious Materials ^{10/}				
Shale, % max.	1.0	2.0	4.0 ^{8/}	---
Clay Lumps, % max.	0.25	0.5	0.5 ^{8/}	---
Coal & Lignite, % max.	0.25	---	---	---
Soft & Unsound Fragments, % max.	4.0	6.0	8.0 ^{8/}	---
Other Deleterious, % max.	4.0 ^{9/}	2.0	2.0 ^{8/}	---
Total Deleterious, % max.	5.0	6.0	10.0 ^{8/}	---
Oil-Stained Aggregate ^{10/} , % max	5.0	---	---	

1/ Does not apply to crushed concrete.

2/ For aggregate surface course and aggregate shoulders, the maximum percent loss shall be 30.

3/ For portland cement concrete, the maximum percent loss shall be 45.

4/ Does not apply to crushed slag or crushed steel slag.

5/ For hot-mix asphalt (HMA) binder mixtures, except when used as surface course, the maximum percent loss shall be 45.

6/ For crushed aggregate, if the material finer than the No. 200 (75 µm) sieve consists of the dust from fracture, essentially free from clay or silt, this percentage may be increased to 2.5.

7/ Does not apply to aggregates for HMA binder mixtures.

- 8/ Does not apply to Class A seal and cover coats.
- 9/ Includes deleterious chert. In gravel and crushed gravel aggregate, deleterious chert shall be the lightweight fraction separated in a 2.35 heavy media separation. In crushed stone aggregate, deleterious chert shall be the lightweight fraction separated in a 2.55 heavy media separation. Tests shall be run according to ITP 113.
- 10/ Test shall be run according to ITP 203.
- 11/ Does not apply to crushed slag.

All varieties of chert contained in gravel coarse aggregate for portland cement concrete, whether crushed or uncrushed, pure or impure, and irrespective of color, will be classed as chert and shall not be present in the total aggregate in excess of 25 percent by weight (mass).

Aggregates used in Class BS concrete (except when poured on subgrade), Class PS concrete, and Class PC concrete (bridge superstructure products only, excluding the approach slab) shall contain no more than two percent by weight (mass) of deleterious materials. Deleterious materials shall include substances whose disintegration is accompanied by an increase in volume which may cause spalling of the concrete.”

DISADVANTAGED BUSINESS ENTERPRISE PARTICIPATION (BDE)

Effective: September 1, 2000

Revised: July 2, 2016

FEDERAL OBLIGATION. The Department of Transportation, as a recipient of federal financial assistance, is required to take all necessary and reasonable steps to ensure nondiscrimination in the award and administration of contracts. Consequently, the federal regulatory provisions of 49 CFR Part 26 apply to this contract concerning the utilization of disadvantaged business enterprises. For the purposes of this Special Provision, a disadvantaged business enterprise (DBE) means a business certified by the Department in accordance with the requirements of 49 CFR Part 26 and listed in the Illinois Unified Certification Program (IL UCP) DBE Directory.

STATE OBLIGATION. This Special Provision will also be used by the Department to satisfy the requirements of the Business Enterprise for Minorities, Females, and Persons with Disabilities Act, 30 ILCS 575. When this Special Provision is used to satisfy state law requirements on 100 percent state-funded contracts, the federal government has no involvement in such contracts (not a federal-aid contract) and no responsibility to oversee the implementation of this Special Provision by the Department on those contracts. DBE participation on 100 percent state-funded contracts will not be credited toward fulfilling the Department’s annual overall DBE goal required by the US Department of Transportation to comply with the federal DBE program requirements.

CONTRACTOR ASSURANCE. The Contractor makes the following assurance and agrees to include the assurance in each subcontract that the Contractor signs with a subcontractor.

The Contractor, subrecipient, or subcontractor shall not discriminate on the basis of race, color, national origin, or sex in the performance of this contract. The Contractor shall carry out applicable requirements of 49 CFR Part 26 in the award and administration of contracts funded in whole or in part with federal or state funds. Failure by the Contractor to carry out these requirements is a material breach of this contract, which may result in the termination of this contract or such other remedy as the recipient deems appropriate, which may include, but is not limited to:

- (a) Withholding progress payments;
- (b) Assessing sanctions;
- (c) Liquidated damages; and/or
- (d) Disqualifying the Contractor from future bidding as non-responsible.

OVERALL GOAL SET FOR THE DEPARTMENT. As a requirement of compliance with 49 CFR Part 26, the Department has set an overall goal for DBE participation in its federally assisted contracts. That goal applies to all federal-aid funds the Department will expend in its federally assisted contracts for the subject reporting fiscal year. The Department is required to make a good faith effort to achieve the overall goal. The dollar amount paid to all approved DBE companies performing work called for in this contract is eligible to be credited toward fulfillment of the Department's overall goal.

CONTRACT GOAL TO BE ACHIEVED BY THE CONTRACTOR. This contract includes a specific DBE utilization goal established by the Department. The goal has been included because the Department has determined that the work of this contract has subcontracting opportunities that may be suitable for performance by DBE companies. The determination is based on an assessment of the type of work, the location of the work, and the availability of DBE companies to do a part of the work. The assessment indicates that, in the absence of unlawful discrimination, and in an arena of fair and open competition, DBE companies can be expected to perform **3.00%** of the work. This percentage is set as the DBE participation goal for this contract. Consequently, in addition to the other award criteria established for this contract, the Department will only award this contract to a bidder who makes a good faith effort to meet this goal of DBE participation in the performance of the work. A bidder makes a good faith effort for award consideration if either of the following is done in accordance with the procedures set for in this Special Provision:

- (a) The bidder documents that enough DBE participation has been obtained to meet the goal or,
- (b) The bidder documents that a good faith effort has been made to meet the goal, even though the effort did not succeed in obtaining enough DBE participation to meet the goal.

DBE LOCATOR REFERENCES. Bidders shall consult the IL UCP DBE Directory as a reference source for DBE-certified companies. In addition, the Department maintains a letting and item specific DBE locator information system whereby DBE companies can register their interest in providing quotes on particular bid items advertised for letting. Information concerning DBE companies willing to quote work for particular contracts may be obtained by contacting the Department's Bureau of Small Business Enterprises at telephone number (217) 785-4611, or by visiting the Department's website at: <http://www.idot.illinois.gov/doing-business/certifications/disadvantaged-business-enterprise-certification/il-ucp-directory/index>.

BIDDING PROCEDURES. Compliance with this Special Provision is required prior to the award of the contract and the failure of the low bidder to comply will render the bid not responsive.

In order to assure the timely award of the contract, the low bidder shall submit:

- (a) The bidder shall submit a DBE Utilization Plan on completed Department forms SBE 2025 and 2026.
 - (1) The final Utilization Plan must be submitted within five calendar days after the date of the letting in accordance with subsection (a)(2) of Bidding Procedures herein.
 - (2) To meet the five day requirement, the bidder may send the Utilization Plan electronically by scanning and sending to **DOT.DBE.UP@illinois.gov** or faxing to (217) 785-1524. The subject line must include the bid Item Number and the Letting date. The Utilization Plan should be sent as one .pdf file, rather than multiple files and emails for the same Item Number. It is the responsibility of the bidder to obtain confirmation of email or fax delivery.

Alternatively, the Utilization Plan may be sent by certified mail or delivery service within the five calendar day period. If a question arises concerning the mailing date of a Utilization Plan, the mailing date will be established by the U.S. Postal Service postmark on the certified mail receipt from the U.S. Postal Service or the receipt issued by a delivery service when the Utilization Plan is received by the Department. It is the responsibility of the bidder to ensure the postmark or receipt date is affixed within the five days if the bidder intends to rely upon mailing or delivery to satisfy the submission day requirement. The Utilization Plan is to be submitted to:

Illinois Department of Transportation
Bureau of Small Business Enterprises
Contract Compliance Section
2300 South Dirksen Parkway, Room 319
Springfield, Illinois 62764

The Department will not accept a Utilization Plan if it does not meet the five day submittal requirement and the bid will be declared not responsive. In the event the bid is declared not responsive due to a failure to submit a Utilization Plan or failure to comply with the bidding procedures set forth herein, the Department may elect to cause the forfeiture of the penal sum of the bidder's proposal guaranty, and may deny authorization to bid the project if re-advertised for bids. The Department reserves the right to invite any other bidder to submit a Utilization Plan at any time for award consideration.

- (b) The Utilization Plan shall indicate that the bidder either has obtained sufficient DBE participation commitments to meet the contract goal or has not obtained enough DBE participation commitments in spite of a good faith effort to meet the goal. The Utilization Plan shall further provide the name, telephone number, and telefax number of a responsible official of the bidder designated for purposes of notification of Utilization Plan approval or disapproval under the procedures of this Special Provision.
- (c) The Utilization Plan shall include a DBE Participation Commitment Statement, Department form SBE 2025, for each DBE proposed for the performance of work to achieve the contract goal. For bidding purposes, submission of the completed SBE 2025 forms, signed by the DBEs and scanned or faxed to the bidder will be acceptable as long as the original is available and provided upon request. All elements of information indicated on the said form shall be provided, including but not limited to the following:
 - (1) The names and addresses of DBE firms that will participate in the contract;
 - (2) A description, including pay item numbers, of the work each DBE will perform;
 - (3) The dollar amount of the participation of each DBE firm participating. The dollar amount of participation for identified work shall specifically state the quantity, unit price, and total subcontract price for the work to be completed by the DBE. If partial pay items are to be performed by the DBE, indicate the portion of each item, a unit price where appropriate and the subcontract price amount;
 - (4) DBE Participation Commitment Statements, form SBE 2025, signed by the bidder and each participating DBE firm documenting the commitment to use the DBE subcontractors whose participation is submitted to meet the contract goal;
 - (5) If the bidder is a joint venture comprised of DBE companies and non-DBE companies, the Utilization Plan must also include a clear identification of the portion of the work to be performed by the DBE partner(s); and,
 - (6) If the contract goal is not met, evidence of good faith efforts; the documentation of good faith efforts must include copies of each DBE and non-DBE subcontractor quote submitted to the bidder when a non-DBE subcontractor is selected over a DBE for work on the contract.

GOOD FAITH EFFORT PROCEDURES. The contract will not be awarded until the Utilization Plan submitted by the apparent successful bidder is approved. All information submitted by the bidder must be complete, accurate and adequately document that enough DBE participation has been obtained or document that good faith efforts of the bidder, in the event enough DBE participation has not been obtained, before the Department will commit to the performance of the contract by the bidder. The Utilization Plan will be approved by the Department if the Utilization Plan documents sufficient commercially useful DBE work to meet the contract goal or the bidder submits sufficient documentation of a good faith effort to meet the contract goal pursuant to 49 CFR Part 26, Appendix A. The Utilization Plan will not be approved by the Department if the Utilization Plan does not document sufficient DBE participation to meet the contract goal unless the apparent successful bidder documented in the Utilization Plan that it made a good faith effort to meet the goal. This means that the bidder must show that all necessary and reasonable steps were taken to achieve the contract goal. Necessary and reasonable steps are those which, by their scope, intensity and appropriateness to the objective, could reasonably be expected to obtain sufficient DBE participation, even if they were not successful. The Department will consider the quality, quantity, and intensity of the kinds of efforts that the bidder has made. Mere *pro forma* efforts, in other words, efforts done as a matter of form, are not good faith efforts; rather, the bidder is expected to have taken genuine efforts that would be reasonably expected of a bidder actively and aggressively trying to obtain DBE participation sufficient to meet the contract goal.

- (a) The following is a list of types of action that the Department will consider as part of the evaluation of the bidder's good faith efforts to obtain participation. These listed factors are not intended to be a mandatory checklist and are not intended to be exhaustive. Other factors or efforts brought to the attention of the Department may be relevant in appropriate cases, and will be considered by the Department.
 - (1) Soliciting through all reasonable and available means (e.g. attendance at pre-bid meetings, advertising and/or written notices) the interest of all certified DBE companies that have the capability to perform the work of the contract. The bidder must solicit this interest within sufficient time to allow the DBE companies to respond to the solicitation. The bidder must determine with certainty if the DBE companies are interested by taking appropriate steps to follow up initial solicitations.
 - (2) Selecting portions of the work to be performed by DBE companies in order to increase the likelihood that the DBE goals will be achieved. This includes, where appropriate, breaking out contract work items into economically feasible units to facilitate DBE participation, even when the prime Contractor might otherwise prefer to perform these work items with its own forces.
 - (3) Providing interested DBE companies with adequate information about the plans, specifications, and requirements of the contract in a timely manner to assist them in responding to a solicitation.

- (4) a. Negotiating in good faith with interested DBE companies. It is the bidder's responsibility to make a portion of the work available to DBE subcontractors and suppliers and to select those portions of the work or material needs consistent with the available DBE subcontractors and suppliers, so as to facilitate DBE participation. Evidence of such negotiation includes the names, addresses, and telephone numbers of DBE companies that were considered; a description of the information provided regarding the plans and specifications for the work selected for subcontracting; and evidence as to why additional agreements could not be reached for DBE companies to perform the work.
 - b. A bidder using good business judgment would consider a number of factors in negotiating with subcontractors, including DBE subcontractors, and would take a firm's price and capabilities as well as contract goals into consideration. However, the fact that there may be some additional costs involved in finding and using DBE companies is not in itself sufficient reason for a bidder's failure to meet the contract DBE goal, as long as such costs are reasonable. Also the ability or desire of a bidder to perform the work of a contract with its own organization does not relieve the bidder of the responsibility to make good faith efforts. Bidders are not, however, required to accept higher quotes from DBE companies if the price difference is excessive or unreasonable. In accordance with subsection (c)(6) of the above Bidding Procedures, the documentation of good faith efforts must include copies of each DBE and non-DBE subcontractor quote submitted to the bidder when a non-DBE subcontractor was selected over a DBE for work on the contract.
- (5) Not rejecting DBE companies as being unqualified without sound reasons based on a thorough investigation of their capabilities. The bidder's standing within its industry, membership in specific groups, organizations, or associations and political or social affiliations (for example union vs. non-union employee status) are not legitimate causes for the rejection or non-solicitation of bids in the bidder's efforts to meet the project goal.
 - (6) Making efforts to assist interested DBE companies in obtaining bonding, lines of credit, or insurance as required by the recipient or Contractor.
 - (7) Making efforts to assist interested DBE companies in obtaining necessary equipment, supplies, materials, or related assistance or services.
 - (8) Effectively using the services of available minority/women community organizations; minority/women contractors' groups; local, state, and federal minority/women business assistance offices; and other organizations as allowed on a case-by-case basis to provide assistance in the recruitment and placement of DBE companies.

- (b) If the Department determines that the apparent successful bidder has made a good faith effort to secure the work commitment of DBE companies to meet the contract goal, the Department will award the contract provided that it is otherwise eligible for award. If the Department determines that the bidder has failed to meet the requirements of this Special Provision or that a good faith effort has not been made, the Department will notify the responsible company official designated in the Utilization Plan that the bid is not responsive. The notification shall include a statement of reasons for the determination. If the Utilization Plan is not approved because it is deficient as a technical matter, unless waived by the Department, the bidder will be notified and will be allowed no more than a five calendar day period in order to cure the deficiency.
- (c) The bidder may request administrative reconsideration of a determination adverse to the bidder within the five working days after the receipt of the notification date of the determination by delivering the request to the Department of Transportation, Bureau of Small Business Enterprises, Contract Compliance Section, 2300 South Dirksen Parkway, Room 319, Springfield, Illinois 62764 (Telefax: (217) 785-1524). Deposit of the request in the United States mail on or before the fifth business day shall not be deemed delivery. The determination shall become final if a request is not made and delivered. A request may provide additional written documentation or argument concerning the issues raised in the determination statement of reasons, provided the documentation and arguments address efforts made prior to submitting the bid. The request will be forwarded to the Department's Reconsideration Officer. The Reconsideration Officer will extend an opportunity to the bidder to meet in person in order to consider all issues of documentation and whether the bidder made a good faith effort to meet the goal. After the review by the Reconsideration Officer, the bidder will be sent a written decision within ten working days after receipt of the request for consideration, explaining the basis for finding that the bidder did or did not meet the goal or make adequate good faith efforts to do so. A final decision by the Reconsideration Officer that a good faith effort was made shall approve the Utilization Plan submitted by the bidder and shall clear the contract for award. A final decision that a good faith effort was not made shall render the bid not responsive.

CALCULATING DBE PARTICIPATION. The Utilization Plan values represent work anticipated to be performed and paid for upon satisfactory completion. The Department is only able to count toward the achievement of the overall goal and the contract goal the value of payments made for the work actually performed by DBE companies. In addition, a DBE must perform a commercially useful function on the contract to be counted. A commercially useful function is generally performed when the DBE is responsible for the work and is carrying out its responsibilities by actually performing, managing, and supervising the work involved. The Department and Contractor are governed by the provisions of 49 CFR Part 26.55(c) on questions of commercially useful functions as it affects the work. Specific counting guidelines are provided in 49 CFR Part 26.55, the provisions of which govern over the summary contained herein.

- (a) DBE as the Contractor: 100 percent goal credit for that portion of the work performed by the DBE's own forces, including the cost of materials and supplies. Work that a DBE subcontracts to a non-DBE does not count toward the DBE goals.

- (b) DBE as a joint venture Contractor: 100 percent goal credit for that portion of the total dollar value of the contract equal to the distinct, clearly defined portion of the work performed by the DBE's own forces.
- (c) DBE as a subcontractor: 100 percent goal credit for the work of the subcontract performed by the DBE's own forces, including the cost of materials and supplies, excluding the purchase of materials and supplies or the lease of equipment by the DBE subcontractor from the prime Contractor or its affiliates. Work that a DBE subcontractor in turn subcontracts to a non-DBE does not count toward the DBE goal.
- (d) DBE as a trucker: 100 percent goal credit for trucking participation provided the DBE is responsible for the management and supervision of the entire trucking operation for which it is responsible. At least one truck owned, operated, licensed, and insured by the DBE must be used on the contract. Credit will be given for the following:
 - (1) The DBE may lease trucks from another DBE firm, including an owner-operator who is certified as a DBE. The DBE who leases trucks from another DBE receives credit for the total value of the transportation services the lessee DBE provides on the contract.
 - (2) The DBE may also lease trucks from a non-DBE firm, including from an owner-operator. The DBE who leases trucks from a non-DBE is entitled to credit only for the fee or commission is receives as a result of the lease arrangement.
- (e) DBE as a material supplier:
 - (1) 60 percent goal credit for the cost of the materials or supplies purchased from a DBE regular dealer.
 - (2) 100 percent goal credit for the cost of materials of supplies obtained from a DBE manufacturer.
 - (3) 100 percent credit for the value of reasonable fees and commissions for the procurement of materials and supplies if not a DBE regular dealer or DBE manufacturer.

CONTRACT COMPLIANCE. Compliance with this Special Provision is an essential part of the contract. The Department is prohibited by federal regulations from crediting the participation of a DBE included in the Utilization Plan toward either the contract goal or the Department's overall goal until the amount to be applied toward the goals has been paid to the DBE. The following administrative procedures and remedies govern the compliance by the Contractor with the contractual obligations established by the Utilization Plan. After approval of the Utilization Plan and award of the contract, the Utilization Plan and individual DBE Participation Statements become part of the contract. If the Contractor did not succeed in obtaining enough DBE participation to achieve the advertised contract goal, and the Utilization Plan was approved and contract awarded based upon a determination of good faith, the total dollar value of DBE work calculated in the approved Utilization Plan as a percentage of the awarded contract value shall become the amended contract goal. All work indicated for performance by an approved DBE shall be performed, managed, and supervised by the DBE executing the DBE Participation Commitment Statement.

- (a) NO AMENDMENT. No amendment to the Utilization Plan may be made without prior written approval from the Department's Bureau of Small Business Enterprises. All requests for amendment to the Utilization Plan shall be submitted to the Department of Transportation, Bureau of Small Business Enterprises, Contract Compliance Section, 2300 South Dirksen Parkway, Room 319, Springfield, Illinois 62764. Telephone number (217) 785-4611. Telefax number (217) 785-1524.
- (b) CHANGES TO WORK. Any deviation from the DBE condition-of-award or contract plans, specifications, or special provisions must be approved, in writing, by the Department as provided elsewhere in the Contract. The Contractor shall notify affected DBEs in writing of any changes in the scope of work which result in a reduction in the dollar amount condition-of-award to the contract. Where the revision includes work committed to a new DBE subcontractor, not previously involved in the project, then a Request for Approval of Subcontractor, Department form BC 260A or AER 260A, must be signed and submitted. If the commitment of work is in the form of additional tasks assigned to an existing subcontract, then a new Request for Approval of Subcontractor shall not be required. However, the Contractor must document efforts to assure that the existing DBE subcontractor is capable of performing the additional work and has agreed in writing to the change.
- (c) SUBCONTRACT. The Contractor must provide DBE subcontracts to IDOT upon request. Subcontractors shall ensure that all lower tier subcontracts or agreements with DBEs to supply labor or materials be performed in accordance with this Special Provision.

- (d) ALTERNATIVE WORK METHODS. In addition to the above requirements for reductions in the condition of award, additional requirements apply to the two cases of Contractor-initiated work substitution proposals. Where the contract allows alternate work methods which serve to delete or create underruns in condition of award DBE work, and the Contractor selects that alternate method or, where the Contractor proposes a substitute work method or material that serves to diminish or delete work committed to a DBE and replace it with other work, then the Contractor must demonstrate one of the following:
- (1) That the replacement work will be performed by the same DBE (as long as the DBE is certified in the respective item of work) in a modification of the condition of award; or
 - (2) That the DBE is aware that its work will be deleted or will experience underruns and has agreed in writing to the change. If this occurs, the Contractor shall substitute other work of equivalent value to a certified DBE or provide documentation of good faith efforts to do so; or
 - (3) That the DBE is not capable of performing the replacement work or has declined to perform the work at a reasonable competitive price. If this occurs, the Contractor shall substitute other work of equivalent value to a certified DBE or provide documentation of good faith efforts to do so.
- (e) TERMINATION AND REPLACEMENT PROCEDURES. The Contractor shall not terminate or replace a DBE listed on the approved Utilization Plan, or perform with other forces work designated for a listed DBE except as provided in this Special Provision. The Contractor shall utilize the specific DBEs listed to perform the work and supply the materials for which each is listed unless the Contractor obtains the Department's written consent as provided in subsection (a) of this part. Unless Department consent is provided for termination of a DBE subcontractor, the Contractor shall not be entitled to any payment for work or material unless it is performed or supplied by the DBE in the Utilization Plan.

As stated above, the Contractor shall not terminate or replace a DBE subcontractor listed in the approved Utilization Plan without prior written consent. This includes, but is not limited to, instances in which the Contractor seeks to perform work originally designated for a DBE subcontractor with its own forces or those of an affiliate, a non-DBE firm, or with another DBE firm. Written consent will be granted only if the Bureau of Small Business Enterprises agrees, for reasons stated in its concurrence document, that the Contractor has good cause to terminate or replace the DBE firm. Before transmitting to the Bureau of Small Business Enterprises any request to terminate and/or substitute a DBE subcontractor, the Contractor shall give notice in writing to the DBE subcontractor, with a copy to the Bureau, of its intent to request to terminate and/or substitute, and the reason for the request. The Contractor shall give the DBE five days to respond to the Contractor's notice. The DBE so notified shall advise the Bureau and the Contractor of the reasons, if any, why it objects to the proposed termination of its subcontract and why the Bureau should not approve the Contractor's action. If required in a particular case as a matter of public necessity, the Bureau may provide a response period shorter than five days.

For purposes of this paragraph, good cause includes the following circumstances:

- (1) The listed DBE subcontractor fails or refuses to execute a written contract;
- (2) The listed DBE subcontractor fails or refuses to perform the work of its subcontract in a way consistent with normal industry standards. Provided, however, that good cause does not exist if the failure or refusal of the DBE subcontractor to perform its work on the subcontract results from the bad faith or discriminatory action of the prime contractor;
- (3) The listed DBE subcontractor fails or refuses to meet the prime Contractor's reasonable, nondiscriminatory bond requirements;
- (4) The listed DBE subcontractor becomes bankrupt, insolvent, or exhibits credit unworthiness;
- (5) The listed DBE subcontractor is ineligible to work on public works projects because of suspension and debarment proceedings pursuant 2 CFR Parts 180, 215 and 1200 or applicable state law.
- (6) You have determined that the listed DBE subcontractor is not a responsible contractor;
- (7) The listed DBE subcontractor voluntarily withdraws from the projects and provides to you written notice of its withdrawal;
- (8) The listed DBE is ineligible to receive DBE credit for the type of work required;
- (9) A DBE owner dies or becomes disabled with the result that the listed DBE subcontractor is unable to complete its work on the contract;
- (10) Other documented good cause that compels the termination of the DBE subcontractor. Provided, that good cause does not exist if the prime Contractor seeks to terminate a DBE it relied upon to obtain the contract so that the prime Contractor can self-perform the work for which the DBE contractor was engaged or so that the prime Contractor can substitute another DBE or non-DBE contractor after contract award.

When a DBE is terminated, or fails to complete its work on the Contract for any reason the Contractor shall make a good faith effort to find another DBE to substitute for the original DBE to perform at least the same amount of work under the contract as the terminated DBE to the extent needed to meet the established Contract goal. The good faith efforts shall be documented by the Contractor. If the Department requests documentation under this provision, the Contractor shall submit the documentation within seven days, which may be extended for an additional seven days if necessary at the request of the Contractor. The Department shall provide a written determination to the Contractor stating whether or not good faith efforts have been demonstrated.

- (f) PAYMENT RECORDS. The Contractor shall maintain a record of payments for work performed to the DBE participants. The records shall be made available to the Department for inspection upon request. After the performance of the final item of work or delivery of material by a DBE and final payment therefore to the DBE by the Contractor, but not later than thirty calendar days after payment has been made by the Department to the Contractor for such work or material, the Contractor shall submit a DBE Payment Agreement on Department form SBE 2115 to the Resident Engineer. If full and final payment has not been made to the DBE, the DBE Payment Agreement shall indicate whether a disagreement as to the payment required exists between the Contractor and the DBE or if the Contractor believes that the work has not been satisfactorily completed. If the Contractor does not have the full amount of work indicated in the Utilization Plan performed by the DBE companies indicated in the Utilization Plan and after good faith efforts are reviewed, the Department may deduct from contract payments to the Contractor the amount of the goal not achieved as liquidated and ascertained damages. The Contractor may request an administrative reconsideration of any amount deducted as damages pursuant to subsection (h) of this part.
- (g) ENFORCEMENT. The Department reserves the right to withhold payment to the Contractor to enforce the provisions of this Special Provision. Final payment shall not be made on the contract until such time as the Contractor submits sufficient documentation demonstrating achievement of the goal in accordance with this Special Provision or after liquidated damages have been determined and collected.
- (h) RECONSIDERATION. Notwithstanding any other provision of the contract, including but not limited to Article 109.09 of the Standard Specifications, the Contractor may request administrative reconsideration of a decision to deduct the amount of the goal not achieved as liquidated damages. A request to reconsider shall be delivered to the Contract Compliance Section and shall be handled and considered in the same manner as set forth in paragraph (c) of "Good Faith Effort Procedures" of this Special Provision, except a final decision that a good faith effort was not made during contract performance to achieve the goal agreed to in the Utilization Plan shall be the final administrative decision of the Department. The result of the reconsideration process is not administratively appealable to the U.S. Department of Transportation.

EQUAL EMPLOYMENT OPPORTUNITY (BDE)

Effective: April 1, 2015

FEDERAL AID CONTRACTS. Revise the following section of Check Sheet #1 of the Recurring Special Provisions to read:

"EQUAL EMPLOYMENT OPPORTUNITY

In the event of the Contractor's noncompliance with the provisions of this Equal Employment Opportunity Clause, the Illinois Human Rights Act, or the Illinois Department of Human Rights Rules and Regulations, the Contractor may be declared ineligible for future contracts or subcontracts with the State of Illinois or any of its political sub-divisions or municipal corporations, and the contract may be cancelled or voided in whole or in part, and such other sanctions or penalties may be imposed or remedies invoked as provided by statute or regulation.

During the performance of this Contract, the Contractor agrees as follows:

- (1) That it will not discriminate against any employee or applicant for employment because of race, color, religion, sex, sexual orientation, marital status, order of protection status, national origin or ancestry, citizenship status, age, physical or mental disability unrelated to ability, military status, or an unfavorable discharge from military service; and further that it will examine all job classifications to determine if minority persons or women are underutilized and will take appropriate affirmative action to rectify any such underutilization.
- (2) That, if it hires additional employees in order to perform this contract or any portion hereof, it will determine the availability (according to the Illinois Department of Human Rights Rules and Regulations) of minorities and women in the area(s) from which it may reasonably recruit and it will hire for each job classification for which employees are hired in such a way that minorities and women are not underutilized.
- (3) That, in all solicitations or advertisements for employees placed by it or on its behalf, it will state that all applicants will be afforded equal opportunity without discrimination because of race, color, religion, sex, sexual orientation, marital status, order of protection status, national origin or ancestry, citizenship status, age, physical or mental disability unrelated to ability, military status or an unfavorable discharge from military service.

- (4) That it will send to each labor organization or representative of workers with which it has or is bound by a collective bargaining or other agreement or understanding, a notice advising such labor organization or representative of the Contractor's obligations under the Illinois Human Rights Act and the Illinois Department of Human Rights Rules and Regulations. If any labor organization or representative fails or refuses to cooperate with the Contractor in its efforts to comply with such Act and Rules and Regulations, the Contractor will promptly so notify the Illinois Department of Human Rights and IDOT and will recruit employees from other sources when necessary to fulfill its obligations thereunder.
- (5) That it will submit reports as required by the Illinois Department of Human Rights Rules and Regulations, furnish all relevant information as may from time to time be requested by the Illinois Department of Human Rights or IDOT, and in all respects comply with the Illinois Human Rights Act and the Illinois Department of Human Rights Rules and Regulations.
- (6) That it will permit access to all relevant books, records, accounts, and work sites by personnel of IDOT and the Illinois Department of Human Rights for purposes of investigation to ascertain compliance with the Illinois Human Rights Act and the Illinois Department of Human Rights Rules and Regulations.
- (7) That it will include verbatim or by reference the provisions of this clause in every subcontract it awards under which any portion of the contract obligations are undertaken or assumed, so that the provisions will be binding upon the subcontractor. In the same manner as with other provisions of this contract, the Contractor will be liable for compliance with applicable provisions of this clause by subcontractors; and further it will promptly notify IDOT and the Illinois Department of Human Rights in the event any subcontractor fails or refuses to comply with these provisions. In addition, the Contractor will not utilize any subcontractor declared by the Illinois Human Rights Commission to be ineligible for contracts or subcontracts with the State of Illinois or any of its political subdivisions or municipal corporations."

STATE CONTRACTS. Revise Section II of Check Sheet #5 of the Recurring Special Provisions to read:

"II. EQUAL EMPLOYMENT OPPORTUNITY

In the event of the Contractor's noncompliance with the provisions of this Equal Employment Opportunity Clause, the Illinois Human Rights Act or the Illinois Department of Human Rights Rules and Regulations, the Contractor may be declared ineligible for future contracts or subcontracts with the State of Illinois or any of its political sub-divisions or municipal corporations, and the contract may be cancelled or voided in whole or in part, and such other sanctions or penalties may be imposed or remedies invoked as provided by statute or regulation.

During the performance of this Contract, the Contractor agrees as follows:

1. That it will not discriminate against any employee or applicant for employment because of race, color, religion, sex, sexual orientation, marital status, order of protection status, national origin or ancestry, citizenship status, age, physical or mental disability unrelated to ability, military status, or an unfavorable discharge from military service; and further that it will examine all job classifications to determine if minority persons or women are underutilized and will take appropriate affirmative action to rectify any such underutilization.
2. That, if it hires additional employees in order to perform this contract or any portion hereof, it will determine the availability (according to the Illinois Department of Human Rights Rules and Regulations) of minorities and women in the area(s) from which it may reasonably recruit and it will hire for each job classification for which employees are hired in such a way that minorities and women are not underutilized.
3. That, in all solicitations or advertisements for employees placed by it or on its behalf, it will state that all applicants will be afforded equal opportunity without discrimination because of race, color, religion, sex, sexual orientation, marital status, order of protection status, national origin or ancestry, citizenship status, age, physical or mental disability unrelated to ability, military status, or an unfavorable discharge from military service.
4. That it will send to each labor organization or representative of workers with which it has or is bound by a collective bargaining or other agreement or understanding, a notice advising such labor organization or representative of the Contractor's obligations under the Illinois Human Rights Act and the Illinois Department of Human Rights Rules and Regulations. If any labor organization or representative fails or refuses to cooperate with the Contractor in its efforts to comply with such Act and Rules and Regulations, the Contractor will promptly so notify the Illinois Department of Human Rights and IDOT and will recruit employees from other sources when necessary to fulfill its obligations thereunder.
5. That it will submit reports as required by the Illinois Department of Human Rights Rules and Regulations, furnish all relevant information as may from time to time be requested by the Illinois Department of Human Rights or IDOT, and in all respects comply with the Illinois Human Rights Act and the Illinois Department of Human Rights Rules and Regulations.
6. That it will permit access to all relevant books, records, accounts and work sites by personnel of IDOT and the Illinois Department of Human Rights for purposes of investigation to ascertain compliance with the Illinois Human Rights Act and the Illinois Department of Human Rights Rules and Regulations.

7. That it will include verbatim or by reference the provisions of this clause in every subcontract it awards under which any portion of the contract obligations are undertaken or assumed, so that the provisions will be binding upon the subcontractor. In the same manner as with other provisions of this contract, the Contractor will be liable for compliance with applicable provisions of this clause by subcontractors; and further it will promptly notify IDOT and the Illinois Department of Human Rights in the event any subcontractor fails or refuses to comply with these provisions. In addition, the Contractor will not utilize any subcontractor declared by the Illinois Human Rights Commission to be ineligible for contracts or subcontracts with the State of Illinois or any of its political subdivisions or municipal corporations.”

ERRATA FOR THE 2016 STANDARD SPECIFICATIONS (BDE)

Effective: April 1, 2016

- Page 84 Article 204.02. In the seventh line of the first paragraph change “AASHTO T 99 (Method C)” to “Illinois Modified AASHTO T 99 (Method C)”.
- Page 90 Article 205.06. In the first sentence of the third paragraph change “AASHTO T 99 (Method C)” to “Illinois Modified AASHTO T 99 (Method C)”.
- Page 91 Article 205.06. In the first sentence of the fourth paragraph change “AASHTO T 99 (Method C)” to “Illinois Modified AASHTO T 99 (Method C)”, and in the second sentence change “AASHTO T 224” to “Illinois Modified AASHTO T 99 (Annex A1)”.
- Page 91 Article 205.06. In the second line of the fifth paragraph change “AASHTO T 191” to “Illinois Modified AASHTO T 191”.
- Page 91 Article 205.06. In the sixth line of the eighth paragraph change “AASHTO T 99 (Method C)” to “Illinois Modified AASHTO T 99 (Method C)”.
- Page 148 Article 302.09. In the second sentence of the fifth paragraph change “AASHTO T 191” to “Illinois Modified AASHTO T 191”, and in the third sentence change “AASHTO T 99” to “Illinois Modified AASHTO T 99”.
- Page 152 Article 310.09. In the second sentence of the second paragraph change “AASHTO T 191” to “Illinois Modified AASHTO T 191”, and in the third sentence change “AASHTO T 99” to “Illinois Modified AASHTO T 99”.
- Page 155 Article 311.05(a). In the first sentence of the fifth paragraph change “AASHTO T 99 (Method C)” to “Illinois Modified AASHTO T 99 (Method C)”, and in the second sentence change “AASHTO T 224” to “Illinois Modified AASHTO T 99 (Annex A1)”.
- Page 155 Article 311.05(a). In the second line of the sixth paragraph change “AASHTO T 191” to “Illinois Modified AASHTO T 191”.

- Page 163 Article 351.05(a). In the second sentence of the fifth paragraph change “AASHTO T 99 (Method C)” to “Illinois Modified AASHTO T 99 (Method C)”, and in the third sentence change “AASHTO T 224” to “Illinois Modified AASHTO T 99 (Annex A1)”.
- Page 163 Article 351.05(a). In the second line of the sixth paragraph change “AASHTO T 191” to “Illinois Modified AASHTO T 191”.
- Page 169 Article 352.11. In the second sentence of the fourth paragraph change “AASHTO T 191” to “Illinois Modified AASHTO T 191”, and in the third sentence change “AASHTO T 134 (Method B)” to “Illinois Modified AASHTO T 134 (Method B)”.
- Page 169 Article 352.12. In the first sentence of the first paragraph change “AASHTO T 22” to “Illinois Modified AASHTO T 22”, and in the second sentence change “AASHTO T 134 (Method B)” to “Illinois Modified AASHTO T 134 (Method B)”.
- Page 196 Article 406.07(a). After the footnotes in Table 1 - Minimum Roller Requirements for HMA add the following:

“EQUIPMENT DEFINITION

- V_s - Vibratory roller, static mode, minimum 125 lb/in. (2.2 kg/mm) of roller width. Maximum speed = 3 mph (5 km/h) or 264 ft/min (80 m/min). If the vibratory roller does not eliminate roller marks, its use shall be discontinued and a tandem roller, adequately ballasted to remove roller marks, shall be used.
- V_D - Vibratory roller, dynamic mode, operated at a speed to produce not less than 10 impacts/ft (30 impacts/m).
- P - Pneumatic-tired roller, max. speed 3 1/2 mph (5.5 km/h) or 308 ft/min (92 m/min). The pneumatic-tired roller shall have a minimum tire pressure of 80 psi (550 kPa) and shall be equipped with heat retention shields. The self-propelled pneumatic-tired roller shall develop a compression of not less than 300 lb (53 N) nor more than 500 lb (88 N) per in. (mm) of width of the tire tread in contact with the HMA surface.
- T_B - Tandem roller for breakdown rolling, 8 to 12 tons (7 to 11 metric tons), 250 to 400 lb/in. (44 to 70 N/mm) of roller width, max. speed = 3 1/2 mph (5.5 km/h) or 308 ft/min (92 m/min).
- T_F - Tandem roller for final rolling, 200 to 400 lb/in. (35 to 70 N/mm) of roller width with minimum roller width of 50 in. (1.25 m). Ballast shall be increased if roller marks are not eliminated. Ballast shall be decreased if the mat shoves or distorts.
- 3W- Three wheel roller, max. speed = 3 mph (5 km/h) or 264 ft/min (80 m/min), 300 to 400 lb/in. (53 to 70 N/mm) of roller width. The three-wheel roller shall weigh 10 to 12 tons (9 to 11 metric tons).”

- Page 331 Article 505.04(p). Under Range of Clearance in the first table change “in. x 10⁻⁶” to “in. x 10⁻³”.
- Page 444 Article 542.03. In the Notes in Table IIIB add “CPP Corrugated Polypropylene (CPP) pipe with smooth interior”.
- Page 445 Article 542.03. In the fourth column in Table IIIB (metric) change the heading for Type 5 pipe from “CPE” to “CPP”.
- Page 445 Article 542.03. In the Notes in Table IIIB (metric) change “PE Polyethylene (PE) pipe with a smooth interior” to “CPP Corrugated Polypropylene (CPP) pipe with smooth interior”.
- Page 449 Article 542.04(f)(2). In the third line of the second paragraph change “AASHTO T 99 (Method C)” to “Illinois Modified AASHTO T 99 (Method C)”.
- Page 544 Article 639.03. In the first sentence of the first paragraph change “AASHTO Standard Specifications for Structural Supports for Highway Signs, Luminaires, Traffic Signals,” to “AASHTO “LRFD Specifications for Structural Supports for Highway Signs, Luminaires, and Traffic Signals,””.
- Page 546 Article 640.03. In the first sentence of the first paragraph change “AASHTO Standard Specifications for Structural Supports for Highway Signs, Luminaires, and Traffic Signals” to “AASHTO “LRFD Specifications for Structural Supports for Highway Signs, Luminaires, and Traffic Signals””.
- Page 548 Article 641.03. In the first sentence of the first paragraph change “AASHTO Standard Specifications for Structural Supports for Highway Signs, Luminaire and Traffic Signals,” to “AASHTO “LRFD Specifications for Structural Supports for Highway Signs, Luminaires, and Traffic Signals,””.
- Page 621 Article 727.03. In the first sentence of the third paragraph change “AASHTO Standard Specifications for Structural Supports for Highway Signs, Luminaires and Traffic Signals” to “AASHTO “LRFD Specifications for Structural Supports for Highway Signs, Luminaires, and Traffic Signals””.
- Page 629 Article 734.03(a). In the fourth line of the second paragraph change “AASHTO T 99 (Method C)” to “Illinois Modified AASHTO T 99 (Method C)”.
- Page 649 Article 801.02. In the first sentence of the first paragraph change “AASHTO’s Standard Specifications for Structural Supports for Highway Signs, Luminaires, and Traffic Signals” to “AASHTO “LRFD Specifications for Structural Supports for Highway Signs, Luminaires, and Traffic Signals””.
- Page 742 Article 1003.04(c). Under Gradation in the table change “(see Article 1003.02(c))” to “(see Article 1003.01(c))”.

- Page 755 Article 1004.03(b). Revise the third sentence of the first paragraph to read “For Class A (seal or cover coat), and other binder courses, the coarse aggregate shall be Class C quality or better.”.
- Page 809 Article 1020.04(e). In the third line of the first paragraph change “ITP SCC-3” to “ITP SCC-4”.
- Page 945 Article 1069.05. In the first sentence of the tenth paragraph change ““Standard Specifications for Structural Supports for Highway Signs, Luminaires, and Traffic Signals”” to “AASHTO “LRFD Specifications for Structural Supports for Highway Signs, Luminaires, and Traffic Signals””.
- Page 961 Article 1070.04(b)(1). In the third sentence of the first paragraph change ““Standard Specifications of Structural Supports for Highway Signs, Luminaires and Traffic Signals” published by AASHTO” to “AASHTO “LRFD Specifications for Structural Supports for Highway Signs, Luminaires, and Traffic Signals””.
- Page 989 Article 1077.01. In the second sentence of the first paragraph change “Standard Specifications for Structural Supports for Highway Signs, Luminaires, and Traffic Signals, as published by AASHTO” to “AASHTO “LRFD Specifications for Structural Supports for Highway Signs, Luminaires, and Traffic Signals””.
- Page 1121 Article 1103.13(a). In the first line of the first paragraph change “Bridge Deck Approach Slabs.” to “Bridge Deck and Approach Slabs.”.

HOT-MIX ASPHALT - DENSITY TESTING OF LONGITUDINAL JOINTS (BDE)

Effective: January 1, 2010

Revised: April 1, 2016

Description. This work shall consist of testing the density of longitudinal joints as part of the quality control/quality assurance (QC/QA) of hot-mix asphalt (HMA). Work shall be according to Section 1030 of the Standard Specifications except as follows.

Quality Control/Quality Assurance (QC/QA). Delete the second and third sentence of the third paragraph of Article 1030.05(d)(3) of the Standard Specifications.

Add the following paragraphs to the end of Article 1030.05(d)(3) of the Standard Specifications:

“Longitudinal joint density testing shall be performed at each random density test location. Longitudinal joint testing shall be located at a distance equal to the lift thickness or a minimum of 4 in. (100 mm), from each pavement edge. (i.e. for a 5 in. (125 mm) lift the near edge of the density gauge or core barrel shall be within 5 in. (125 mm) from the edge of pavement.) Longitudinal joint density testing shall be performed using either a correlated nuclear gauge or cores.

a. Confined Edge. Each confined edge density shall be represented by a one-minute nuclear density reading or a core density and shall be included in the average of density readings or core densities taken across the mat which represents the Individual Test.

b. Unconfined Edge. Each unconfined edge joint density shall be represented by an average of three one-minute density readings or a single core density at the given density test location and shall meet the density requirements specified herein. The three one-minute readings shall be spaced 10 ft (3 m) apart longitudinally along the unconfined pavement edge and centered at the random density test location.”

Revise the Density Control Limits table in Article 1030.05(d)(4) of the Standard Specifications to read:

Mixture Composition	Parameter	Individual Test (includes confined edges)	Unconfined Edge Joint Density Minimum
IL-4.75	Ndesign = 50	93.0 – 97.4% ^{1/}	91.0%
IL-9.5	Ndesign = 90	92.0 – 96.0%	90.0%
IL-9.5,IL-9.5L	Ndesign < 90	92.5 – 97.4%	90.0%
IL-19.0	Ndesign = 90	93.0 – 96.0%	90.0%
IL-19.0, IL-19.0L	Ndesign < 90	93.0 ^{2/} – 97.4%	90.0%
SMA	Ndesign = 50 & 80	93.5 – 97.4%	91.0%”

HOT-MIX ASPHALT – TACK COAT (BDE)

Effective: November 1, 2016

Revise Article 1032.06(a) of the Standard Specifications to read:

“(a) Anionic Emulsified Asphalt. Anionic emulsified asphalts shall be according to AASHTO M 140. SS-1h emulsions used as a tack coat shall have the cement mixing test waived.”

PROGRESS PAYMENTS (BDE)

Effective: November 2, 2013

Revise Article 109.07(a) of the Standard Specifications to read:

“(a) Progress Payments. At least once each month, the Engineer will make a written estimate of the quantity of work performed in accordance with the contract, and the value thereof at the contract unit prices. The amount of the estimate approved as due for payment will be vouchered by the Department and presented to the State Comptroller for payment. No amount less than \$1000.00 will be approved for payment other than the final payment.

Progress payments may be reduced by liens filed pursuant to Section 23(c) of the Mechanics’ Lien Act, 770 ILCS 60/23(c).

If a Contractor or subcontractor has defaulted on a loan issued under the Department's Disadvantaged Business Revolving Loan Program (20 ILCS 2705/2705-610), progress payments may be reduced pursuant to the terms of that loan agreement. In such cases, the amount of the estimate related to the work performed by the Contractor or subcontractor, in default of the loan agreement, will be offset, in whole or in part, and vouchered by the Department to the Working Capital Revolving Fund or designated escrow account. Payment for the work shall be considered as issued and received by the Contractor or subcontractor on the date of the offset voucher. Further, the amount of the offset voucher shall be a credit against the Department's obligation to pay the Contractor, the Contractor's obligation to pay the subcontractor, and the Contractor's or subcontractor's total loan indebtedness to the Department. The offset shall continue until such time as the entire loan indebtedness is satisfied. The Department will notify the Contractor and Fund Control Agent in a timely manner of such offset. The Contractor or subcontractor shall not be entitled to additional payment in consideration of the offset.

The failure to perform any requirement, obligation, or term of the contract by the Contractor shall be reason for withholding any progress payments until the Department determines that compliance has been achieved."

RECLAIMED ASPHALT PAVEMENT AND RECLAIMED ASPHALT SHINGLES (BDE)

Effective: November 1, 2012

Revise: April 1, 2016

Revise Section 1031 of the Standard Specifications to read:

"SECTION 1031. RECLAIMED ASPHALT PAVEMENT AND RECLAIMED ASPHALT SHINGLES

1031.01 Description. Reclaimed asphalt pavement and reclaimed asphalt shingles shall be according to the following.

- (a) Reclaimed Asphalt Pavement (RAP). RAP is the material produced by cold milling or crushing an existing hot-mix asphalt (HMA) pavement. The Contractor shall supply written documentation that the RAP originated from routes or airfields under federal, state, or local agency jurisdiction.

(b) Reclaimed Asphalt Shingles (RAS). Reclaimed asphalt shingles (RAS). RAS is from the processing and grinding of preconsumer or post-consumer shingles. RAS shall be a clean and uniform material with a maximum of 0.5 percent unacceptable material, as defined in Bureau of Materials and Physical Research Policy Memorandum, "Reclaimed Asphalt Shingle (RAS) Sources", by weight of RAS. All RAS used shall come from a Bureau of Materials and Physical Research approved processing facility where it shall be ground and processed to 100 percent passing the 3/8 in. (9.5 mm) sieve and 93 percent passing the #4 (4.75 mm) sieve based on a dry shake gradation. RAS shall be uniform in gradation and asphalt binder content and shall meet the testing requirements specified herein. In addition, RAS shall meet the following Type 1 or Type 2 requirements.

- (1) Type 1. Type 1 RAS shall be processed, preconsumer asphalt shingles salvaged from the manufacture of residential asphalt roofing shingles.
- (2) Type 2. Type 2 RAS shall be processed post-consumer shingles only, salvaged from residential, or four unit or less dwellings not subject to the National Emission Standards for Hazardous Air Pollutants (NESHAP).

1031.02 Stockpiles. RAP and RAS stockpiles shall be according to the following.

(a) RAP Stockpiles. The Contractor shall construct individual, sealed RAP stockpiles meeting one of the following definitions. No additional RAP shall be added to the pile after the pile has been sealed. Stockpiles shall be sufficiently separated to prevent intermingling at the base. Stockpiles shall be identified by signs indicating the type as listed below (i.e. "Homogeneous Surface").

Prior to milling, the Contractor shall request the District provide documentation on the quality of the RAP to clarify the appropriate stockpile.

(1) Fractionated RAP (FRAP). FRAP shall consist of RAP from Class I, HMA (High and Low ESAL) mixtures. The coarse aggregate in FRAP shall be crushed aggregate and may represent more than one aggregate type and/or quality, but shall be at least C quality. All FRAP shall be fractionated prior to testing by screening into a minimum of two size fractions with the separation occurring on or between the #4 (4.75 mm) and 1/2 in. (12.5 mm) sieves. Agglomerations shall be minimized such that 100 percent of the RAP shall pass the sieve size specified below for the mix into which the FRAP will be incorporated.

Mixture FRAP will be used in:	Sieve Size that 100 % of FRAP Shall Pass
IL-19.0	1 1/2 in. (40 mm)
IL-9.5	3/4 in. (20 mm)
IL-4.75	1/2 in. (13 mm)

- (2) Homogeneous. Homogeneous RAP stockpiles shall consist of RAP from Class I, HMA (High and Low ESAL) mixtures and represent: 1) the same aggregate quality, but shall be at least C quality; 2) the same type of crushed aggregate (either crushed natural aggregate, ACBF slag, or steel slag); 3) similar gradation; and 4) similar asphalt binder content. If approved by the Engineer, combined single pass surface/binder millings may be considered "homogeneous" with a quality rating dictated by the lowest coarse aggregate quality present in the mixture.
- (3) Conglomerate. Conglomerate RAP stockpiles shall consist of RAP from Class I, HMA (High and Low ESAL) mixtures. The coarse aggregate in this RAP shall be crushed aggregate and may represent more than one aggregate type and/or quality, but shall be at least C quality. This RAP may have an inconsistent gradation and/or asphalt binder content prior to processing. All conglomerate RAP shall be processed prior to testing by crushing to where all RAP shall pass the 5/8 in. (16 mm) or smaller screen. Conglomerate RAP stockpiles shall not contain steel slag.
- (4) Non-Quality. RAP stockpiles that do not meet the requirements of the stockpile categories listed above shall be classified as "Non-Quality".

RAP/FRAP containing contaminants, such as earth, brick, sand, concrete, sheet asphalt, bituminous surface treatment (i.e. chip seal), pavement fabric, joint sealants, etc., will be unacceptable unless the contaminants are removed to the satisfaction of the Engineer. Sheet asphalt shall be stockpiled separately.

- (b) RAS Stockpiles. Type 1 and Type 2 RAS shall be stockpiled separately and shall not be intermingled. Each stockpile shall be signed indicating what type of RAS is present.

Unless otherwise specified by the Engineer, mechanically blending manufactured sand (FM 20 or FM 22) up to an equal weight of RAS with the processed RAS will be permitted to improve workability. The sand shall be "B Quality" or better from an approved Aggregate Gradation Control System source. The sand shall be accounted for in the mix design and during HMA production.

Records identifying the shingle processing facility supplying the RAS, RAS type, and lot number shall be maintained by project contract number and kept for a minimum of three years.

1031.03 Testing. RAP/FRAP and RAS testing shall be according to the following.

- (a) RAP/FRAP Testing. When used in HMA, the RAP/FRAP shall be sampled and tested either during or after stockpiling.
 - (1) During Stockpiling. For testing during stockpiling, washed extraction samples shall be run at the minimum frequency of one sample per 500 tons (450 metric tons) for the first 2000 tons (1800 metric tons) and one sample per 2000 tons (1800 metric tons) thereafter. A minimum of five tests shall be required for stockpiles less than 4000 tons (3600 metric tons).

- (2) After Stockpiling. For testing after stockpiling, the Contractor shall submit a plan for approval to the District proposing a satisfactory method of sampling and testing the RAP/FRAP pile either in-situ or by restockpiling. The sampling plan shall meet the minimum frequency required above and detail the procedure used to obtain representative samples throughout the pile for testing.

Each sample shall be split to obtain two equal samples of test sample size. One of the two test samples from the final split shall be labeled and stored for Department use. The Contractor shall extract the other test sample according to Department procedure. The Engineer reserves the right to test any sample (split or Department-taken) to verify Contractor test results.

- (b) RAS Testing. RAS or RAS blended with manufactured sand shall be sampled and tested during stockpiling according to Bureau of Materials and Physical Research Policy Memorandum, "Reclaimed Asphalt Shingle (RAS) Source".

Samples shall be collected during stockpiling at the minimum frequency of one sample per 200 tons (180 metric tons) for the first 1000 tons (900 metric tons) and one sample per 250 tons (225 metric tons) thereafter. A minimum of five samples are required for stockpiles less than 1000 tons (900 metric tons). Once a ≤ 1000 ton (900 metric ton), five-sample/test stockpile has been established it shall be sealed. Additional incoming RAS or RAS blended with manufactured sand shall be stockpiled in a separate working pile as designated in the Quality Control plan and only added to the sealed stockpile when the test results of the working pile are complete and are found to meet the tolerances specified herein for the original sealed RAS stockpile.

Before testing, each sample shall be split to obtain two test samples. One of the two test samples from the final split shall be labeled and stored for Department use. The Contractor shall perform a washed extraction and test for unacceptable materials on the other test sample according to Department procedures. The Engineer reserves the right to test any sample (split or Department-taken) to verify Contractor test results.

If the sampling and testing was performed at the shingle processing facility in accordance with the QC Plan, the Contractor shall obtain and make available all of the test results from start of the initial stockpile.

1031.04 Evaluation of Tests. Evaluation of test results shall be according to the following.

- (a) Evaluation of RAP/FRAP Test Results. All of the extraction results shall be compiled and averaged for asphalt binder content and gradation, and when applicable G_{mm} . Individual extraction test results, when compared to the averages, will be accepted if within the tolerances listed below.

Parameter	FRAP/Homogeneous/ Conglomerate
1 in. (25 mm)	
1/2 in. (12.5 mm)	± 8 %
No. 4 (4.75 mm)	± 6 %
No. 8 (2.36 mm)	± 5 %
No. 16 (1.18 mm)	
No. 30 (600 μm)	± 5 %
No. 200 (75 μm)	± 2.0 %
Asphalt Binder	± 0.4 % ^{1/}
G_{mm}	± 0.03

1/ The tolerance for FRAP shall be ± 0.3 %.

If more than 20 percent of the individual sieves and/or asphalt binder content tests are out of the above tolerances, the RAP/FRAP shall not be used in HMA unless the RAP/FRAP representing the failing tests is removed from the stockpile. All test data and acceptance ranges shall be sent to the District for evaluation.

With the approval of the Engineer, the ignition oven may be substituted for extractions according to the ITP, "Calibration of the Ignition Oven for the Purpose of Characterizing Reclaimed Asphalt Pavement (RAP)".

- (b) Evaluation of RAS and RAS Blended with Manufactured Sand Test Results. All of the test results, with the exception of percent unacceptable materials, shall be compiled and averaged for asphalt binder content and gradation. Individual test results, when compared to the averages, will be accepted if within the tolerances listed below.

Parameter	RAS
No. 8 (2.36 mm)	± 5 %
No. 16 (1.18 mm)	± 5 %
No. 30 (600 μm)	± 4 %
No. 200 (75 μm)	± 2.0 %
Asphalt Binder Content	± 1.5 %

If more than 20 percent of the individual sieves and/or asphalt binder content tests are out of the above tolerances, or if the percent unacceptable material exceeds 0.5 percent by weight of material retained on the # 4 (4.75 mm) sieve, the RAS or RAS blend shall not be used in Department projects. All test data and acceptance ranges shall be sent to the District for evaluation.

1031.05 Quality Designation of Aggregate in RAP/FRAP.

(a) RAP. The aggregate quality of the RAP for homogeneous and conglomerate stockpiles shall be set by the lowest quality of coarse aggregate in the RAP stockpile and are designated as follows.

(1) RAP from Class I, Superpave/HMA (High ESAL), or (Low ESAL) IL-9.5L surface mixtures are designated as containing Class B quality coarse aggregate.

(2) RAP from Class I binder, Superpave/HMA (High ESAL) binder, or (Low ESAL) IL-19.0L binder mixtures are designated as containing Class C quality coarse aggregate.

(b) FRAP. If the Engineer has documentation of the quality of the FRAP aggregate, the Contractor shall use the assigned quality provided by the Engineer.

If the quality is not known, the quality shall be determined as follows. Coarse and fine FRAP stockpiles containing plus #4 (4.75 mm) sieve coarse aggregate shall have a maximum tonnage of 5000 tons (4500 metric tons). The Contractor shall obtain a representative sample witnessed by the Engineer. The sample shall be a minimum of 50 lb (25 kg). The sample shall be extracted according to Illinois Modified AASHTO T 164 by a consultant laboratory prequalified by the Department for the specified testing. The consultant laboratory shall submit the test results along with the recovered aggregate to the District Office. The cost for this testing shall be paid by the Contractor. The District will forward the sample to the Bureau of Materials and Physical Research Aggregate Lab for MicroDeval Testing, according to ITP 327. A maximum loss of 15.0 percent will be applied for all HMA applications.

1031.06 Use of RAP/FRAP and/or RAS in HMA. The use of RAP/FRAP and/or RAS shall be the Contractor's option when constructing HMA in all contracts.

(a) RAP/FRAP. The use of RAP/FRAP in HMA shall be as follows.

(1) Coarse Aggregate Size. The coarse aggregate in all RAP shall be equal to or less than the nominal maximum size requirement for the HMA mixture to be produced.

(2) Steel Slag Stockpiles. Homogeneous RAP stockpiles containing steel slag will be approved for use in all HMA (High ESAL and Low ESAL) Surface and Binder Mixture applications.

(3) Use in HMA Surface Mixtures (High and Low ESAL). RAP/FRAP stockpiles for use in HMA surface mixtures (High and Low ESAL) shall be FRAP or homogeneous in which the coarse aggregate is Class B quality or better. RAP/FRAP from Conglomerate stockpiles shall be considered equivalent to limestone for frictional considerations. Known frictional contributions from plus #4 (4.75 mm) homogeneous RAP and FRAP stockpiles will be accounted for in meeting frictional requirements in the specified mixture.

- (4) Use in HMA Binder Mixtures (High and Low ESAL), HMA Base Course, and HMA Base Course Widening. RAP/FRAP stockpiles for use in HMA binder mixtures (High and Low ESAL), HMA base course, and HMA base course widening shall be FRAP, homogeneous, or conglomerate, in which the coarse aggregate is Class C quality or better.
- (5) Use in Shoulders and Subbase. RAP/FRAP stockpiles for use in HMA shoulders and stabilized subbase (HMA) shall be FRAP, homogeneous, or conglomerate.
- (6) When the Contractor chooses the RAP option, the percentage of RAP shall not exceed the amounts indicated in Article 1031.06(c)(1) below for a given Ndesign.
- (b) RAS. RAS meeting Type 1 or Type 2 requirements will be permitted in all HMA applications as specified herein.
- (c) RAP/FRAP and/or RAS Usage Limits. Type 1 or Type 2 RAS may be used alone or in conjunction with RAP or FRAP in HMA mixtures up to a maximum of 5.0 percent by weight of the total mix.
 - (1) RAP/RAS. When RAP is used alone or RAP is used in conjunction with RAS, the percentage of virgin asphalt binder replacement shall not exceed the amounts listed in the Max RAP/RAS ABR table listed below for the given Ndesign.

RAP/RAS Maximum Asphalt Binder Replacement (ABR) Percentage

HMA Mixtures <i>1/, 2/</i>	RAP/RAS Maximum ABR %		
	Ndesign	Binder/Leveling Binder	Surface
30	30	30	10
50	25	15	10
70	15	10	10
90	10	10	10

- 1/ For Low ESAL HMA shoulder and stabilized subbase, the RAP/RAS ABR shall not exceed 50 percent of the mixture.
- 2/ When RAP/RAS ABR exceeds 20 percent, the high and low virgin asphalt binder grades shall each be reduced by one grade (i.e. 25 percent ABR would require a virgin asphalt binder grade of PG 64-22 to be reduced to a PG 58-28). If warm mix asphalt (WMA) technology is utilized and production temperatures do not exceed 275 °F (135 °C), the high and low virgin asphalt binder grades shall each be reduced by one grade when RAP/RAS ABR exceeds 25 percent (i.e. 26 percent RAP/RAS ABR would require a virgin asphalt binder grade of PG 64-22 to be reduced to a PG 58-28).

- (2) FRAP/RAS. When FRAP is used alone or FRAP is used in conjunction with RAS, the percentage of virgin asphalt binder replacement shall not exceed the amounts listed in the FRAP/RAS table listed below for the given Ndesign.

FRAP/RAS Maximum Asphalt Binder Replacement (ABR) Percentage

HMA Mixtures <i>1/, 2/</i>	FRAP/RAS Maximum ABR %		
	Ndesign	Binder/Leveling Binder	Surface
30	50	40	10
50	40	35	10
70	40	30	10
90	40	30	10

- 1/ For Low ESAL HMA shoulder and stabilized subbase, the FRAP/RAS ABR shall not exceed 50 percent of the mixture.
- 2/ When FRAP/RAS ABR exceeds 20 percent for all mixes, the high and low virgin asphalt binder grades shall each be reduced by one grade (i.e. 25 percent ABR would require a virgin asphalt binder grade of PG 64-22 to be reduced to a PG 58-28). If warm mix asphalt (WMA) technology is utilized and production temperatures do not exceed 275 °F (135 °C), the high and low virgin asphalt binder grades shall each be reduced by one grade when FRAP/RAS ABR exceeds 25 percent (i.e. 26 percent ABR would require a virgin asphalt binder grade of PG 64-22 to be reduced to a PG 58-28).
- 3/ For SMA the FRAP/RAS ABR shall not exceed 20 percent.
- 4/ For IL-4.75 mix the FRAP/RAS ABR shall not exceed 30 percent.

1031.07 HMA Mix Designs. At the Contractor’s option, HMA mixtures may be constructed utilizing RAP/FRAP and/or RAS material meeting the detailed requirements specified herein.

- (a) RAP/FRAP and/or RAS. RAP/FRAP and/or RAS mix designs shall be submitted for verification. If additional RAP/FRAP and/or RAS stockpiles are tested and found that no more than 20 percent of the results, as defined under “Testing” herein, are outside of the control tolerances set for the original RAP/FRAP and/or RAS stockpile and HMA mix design, and meets all of the requirements herein, the additional RAP/FRAP and/or RAS stockpiles may be used in the original mix design at the percent previously verified.
- (b) RAS. Type 1 and Type 2 RAS are not interchangeable in a mix design. A RAS stone bulk specific gravity (Gsb) of 2.300 shall be used for mix design purposes.

1031.08 HMA Production. HMA production utilizing RAP/FRAP and/or RAS shall be as follows.

- (a) RAP/FRAP. The coarse aggregate in all RAP/FRAP used shall be equal to or less than the nominal maximum size requirement for the HMA mixture being produced.

To remove or reduce agglomerated material, a scalping screen, gator, crushing unit, or comparable sizing device approved by the Engineer shall be used in the RAP feed system to remove or reduce oversized material. If material passing the sizing device adversely affects the mix production or quality of the mix, the sizing device shall be set at a size specified by the Engineer.

If the RAP/FRAP control tolerances or QC/QA test results require corrective action, the Contractor shall cease production of the mixture containing RAP/FRAP and either switch to the virgin aggregate design or submit a new RAP/FRAP design.

- (b) RAS. RAS shall be incorporated into the HMA mixture either by a separate weight depletion system or by using the RAP weigh belt. Either feed system shall be interlocked with the aggregate feed or weigh system to maintain correct proportions for all rates of production and batch sizes. The portion of RAS shall be controlled accurately to within ± 0.5 percent of the amount of RAS utilized. When using the weight depletion system, flow indicators or sensing devices shall be provided and interlocked with the plant controls such that the mixture production is halted when RAS flow is interrupted.

- (c) RAP/FRAP and/or RAS. HMA plants utilizing RAP/FRAP and/or RAS shall be capable of automatically recording and printing the following information.

(1) Dryer Drum Plants.

- a. Date, month, year, and time to the nearest minute for each print.
- b. HMA mix number assigned by the Department.
- c. Accumulated weight of dry aggregate (combined or individual) in tons (metric tons) to the nearest 0.1 ton (0.1 metric ton).
- d. Accumulated dry weight of RAP/FRAP/RAS in tons (metric tons) to the nearest 0.1 ton (0.1 metric ton).
- e. Accumulated mineral filler in revolutions, tons (metric tons), etc. to the nearest 0.1 unit.
- f. Accumulated asphalt binder in gallons (liters), tons (metric tons), etc. to the nearest 0.1 unit.

- g. Residual asphalt binder in the RAP/FRAP material as a percent of the total mix to the nearest 0.1 percent.
- h. Aggregate and RAP/FRAP moisture compensators in percent as set on the control panel. (Required when accumulated or individual aggregate and RAP/FRAP are printed in wet condition.)

(2) Batch Plants.

- a. Date, month, year, and time to the nearest minute for each print.
- b. HMA mix number assigned by the Department.
- c. Individual virgin aggregate hot bin batch weights to the nearest pound (kilogram).
- d. Mineral filler weight to the nearest pound (kilogram).
- e. RAP/FRAP/RAS weight to the nearest pound (kilogram).
- f. Virgin asphalt binder weight to the nearest pound (kilogram).
- g. Residual asphalt binder in the RAP/FRAP/RAS material as a percent of the total mix to the nearest 0.1 percent.

The printouts shall be maintained in a file at the plant for a minimum of one year or as directed by the Engineer and shall be made available upon request. The printing system will be inspected by the Engineer prior to production and verified at the beginning of each construction season thereafter.

1031.09 RAP in Aggregate Surface Course and Aggregate Wedge Shoulders, Type B.

The use of RAP in aggregate surface course (temporary access entrances only) and aggregate wedge shoulders, Type B shall be as follows.

- (a) Stockpiles and Testing. RAP stockpiles may be any of those listed in Article 1031.02, except "Non-Quality" and "FRAP". The testing requirements of Article 1031.03 shall not apply. RAP used shall be according to the current Bureau of Materials and Physical Research Policy Memorandum, "Reclaimed Asphalt Pavement (RAP) for Aggregate Applications".
- (b) Gradation. One hundred percent of the RAP material shall pass the 1 1/2 in. (37.5 mm) sieve. The RAP material shall be reasonably well graded from coarse to fine. RAP material that is gap-graded or single sized will not be accepted."

WARM MIX ASPHALT (BDE)

Effective: January 1, 2012

Revised: April 1, 2016

Description. This work shall consist of designing, producing and constructing Warm Mix Asphalt (WMA) in lieu of Hot Mix Asphalt (HMA) at the Contractor's option. Work shall be according to Sections 406, 407, 408, 1030, and 1102 of the Standard Specifications, except as modified herein. In addition, any references to HMA in the Standard Specifications, or the special provisions shall be construed to include WMA.

WMA is an asphalt mixture which can be produced at temperatures lower than allowed for HMA utilizing approved WMA technologies. WMA technologies are defined as the use of additives or processes which allow a reduction in the temperatures at which HMA mixes are produced and placed. WMA is produced by the use of additives, a water foaming process, or combination of both. Additives include minerals, chemicals or organics incorporated into the asphalt binder stream in a dedicated delivery system. The process of foaming injects water into the asphalt binder stream, just prior to incorporation of the asphalt binder with the aggregate.

Approved WMA technologies may also be used in HMA provided all the requirements specified herein, with the exception of temperature, are met. However, asphalt mixtures produced at temperatures in excess of 275 °F (135 °C) will not be considered WMA when determining the grade reduction of the virgin asphalt binder grade.

Equipment.

Revise the first paragraph of Article 1102.01 of the Standard Specifications to read:

“1102.01 Hot-Mix Asphalt Plant. The hot-mix asphalt (HMA) plant shall be the batch-type, continuous-type, or dryer drum plant. The plants shall be evaluated for prequalification rating and approval to produce HMA according to the current Bureau of Materials and Physical Research Policy Memorandum, “Approval of Hot-Mix Asphalt Plants and Equipment”. Once approved, the Contractor shall notify the Bureau of Materials and Physical Research to obtain approval of all plant modifications. The plants shall not be used to produce mixtures concurrently for more than one project or for private work unless permission is granted in writing by the Engineer. The plant units shall be so designed, coordinated and operated that they will function properly and produce HMA having uniform temperatures and compositions within the tolerances specified. The plant units shall meet the following requirements.”

Add the following to Article 1102.01(a) of the Standard Specifications.

“(11) Equipment for Warm Mix Technologies.

- a. Foaming. Metering equipment for foamed asphalt shall have an accuracy of ± 2 percent of the actual water metered. The foaming control system shall be electronically interfaced with the asphalt binder meter.
- b. Additives. Additives shall be introduced into the plant according to the supplier’s recommendations and shall be approved by the Engineer. The system for introducing the WMA additive shall be interlocked with the aggregate feed or weigh system to maintain correct proportions for all rates of production and batch sizes.”

Mix Design Verification.

Add the following to Article 1030.04 of the Standard Specifications.

“(e) Warm Mix Technologies.

- (1) Foaming. WMA mix design verification will not be required when foaming technology is used alone (without WMA additives). However, the foaming technology shall only be used on HMA designs previously approved by the Department.
- (2) Additives. WMA mix designs utilizing additives shall be submitted to the Engineer for mix design verification.”

Construction Requirements.

Revise the second paragraph of Article 406.06(b)(1) of the Standard Specifications to read:

“The HMA shall be delivered at a temperature of 250 to 350 °F (120 to 175 °C).
WMA shall be delivered at a minimum temperature of 215 °F (102 °C).”

Basis of Payment.

This work will be paid at the contract unit price bid for the HMA pay items involved. Anti-strip will not be paid for separately, but shall be considered as included in the cost of the work.

WEEKLY DBE TRUCKING REPORTS (BDE)

Effective: June 2, 2012

Revised: April 2, 2015

The Contractor shall submit a weekly report of Disadvantaged Business Enterprise (DBE) trucks hired by the Contractor or subcontractors (i.e. not owned by the Contractor or subcontractors) that are used for DBE goal credit.

The report shall be submitted to the Engineer on Department form "SBE 723" within ten business days following the reporting period. The reporting period shall be Monday through Sunday for each week reportable trucking activities occur.

Any costs associated with providing weekly DBE trucking reports shall be considered as included in the contract unit prices bid for the various items of work involved and no additional compensation will be allowed.

WORKING DAYS (BDE)

Effective: January 1, 2002

The Contractor shall complete the work within **25** working days.

BITUMINOUS MATERIALS COST ADJUSTMENTS (BDE) (RETURN FORM WITH BID)

Effective: November 2, 2006

Revised: July 1, 2015

Description. Bituminous material cost adjustments will be made to provide additional compensation to the Contractor, or credit to the Department, for fluctuations in the cost of bituminous materials when optioned by the Contractor. The bidder shall indicate on the attached form whether or not this special provision will be part of the contract and submit the completed form with his/her bid. Failure to submit the form, or failure to fill out the form completely, shall make this contract exempt of bituminous materials cost adjustments.

The adjustments shall apply to permanent and temporary hot-mix asphalt (HMA) mixtures, bituminous surface treatments (cover and seal coats), and preventative maintenance type surface treatments that are part of the original proposed construction, or added as extra work and paid for by agreed unit prices. The adjustments shall not apply to bituminous prime coats, tack coats, crack filling/sealing, joint filling/sealing, or extra work paid for at a lump sum price or by force account.

Method of Adjustment. Bituminous materials cost adjustments will be computed as follows.

$$CA = (BPI_P - BPI_L) \times (\%AC_V / 100) \times Q$$

- Where: CA = Cost Adjustment, \$.
BPI_P = Bituminous Price Index, as published by the Department for the month the work is performed, \$/ton (\$/metric ton).
BPI_L = Bituminous Price Index, as published by the Department for the month prior to the letting for work paid for at the contract price; or for the month the agreed unit price letter is submitted by the Contractor for extra work paid for by agreed unit price, \$/ton (\$/metric ton).
%AC_V = Percent of virgin Asphalt Cement in the Quantity being adjusted. For HMA mixtures, the % AC_V will be determined from the adjusted job mix formula. For bituminous materials applied, a performance graded or cutback asphalt will be considered to be 100% AC_V and undiluted emulsified asphalt will be considered to be 65% AC_V.
Q = Authorized construction Quantity, tons (metric tons) (see below).

For HMA mixtures measured in square yards: $Q, \text{ tons} = A \times D \times (G_{mb} \times 46.8) / 2000$. For HMA mixtures measured in square meters: $Q, \text{ metric tons} = A \times D \times (G_{mb} \times 1) / 1000$. When computing adjustments for full-depth HMA pavement, separate calculations will be made for the binder and surface courses to account for their different G_{mb} and % AC_V.

For bituminous materials measured in gallons: $Q, \text{ tons} = V \times 8.33 \text{ lb/gal} \times SG / 2000$
For bituminous materials measured in liters: $Q, \text{ metric tons} = V \times 1.0 \text{ kg/L} \times SG / 1000$

- Where: A = Area of the HMA mixture, sq yd (sq m).
D = Depth of the HMA mixture, in. (mm).
G_{mb} = Average bulk specific gravity of the mixture, from the approved mix design.
V = Volume of the bituminous material, gal (L).
SG = Specific Gravity of bituminous material as shown on the bill of lading.

Basis of Payment. Bituminous materials cost adjustments may be positive or negative but will only be made when there is a difference between the BPI_L and BPI_P in excess of five percent, as calculated by:

$$\text{Percent Difference} = \{(BPI_L - BPI_P) \div BPI_L\} \times 100$$

Bituminous materials cost adjustments will be calculated for each calendar month in which applicable bituminous material is placed; and will be paid or deducted when all other contract requirements for the work placed during the month are satisfied. The adjustments shall not apply during contract time subject to liquidated damages for completion of the entire contract.

Return With Bid

**ILLINOIS DEPARTMENT
OF TRANSPORTATION**

**OPTION FOR
BITUMINOUS MATERIALS COST ADJUSTMENTS**

The bidder shall submit this completed form with his/her bid. Failure to submit the form, or failure to fill out the form completely, shall make this contract exempt of bituminous materials cost adjustments. After award, this form, when submitted, shall become part of the contract.

Contract No.: _____

Company Name: _____

Contractor's Option:

Is your company opting to include this special provision as part of the contract?

Yes No

Signature: _____ **Date:** _____

VETERAN BUSINESS PROGRAM

Effective: November 6, 2014

STATE OBLIGATION. This special provision will be used by the Department to satisfy the requirements of the Illinois Procurement Code, 30 ILCS 500/45-57. It is the goal of the State to promote and encourage the continued economic development of small businesses owned and controlled by qualified veterans and that qualified Service-Disabled Veteran-Owned Small Businesses (SDVOSB) and Veteran-Owned Small Businesses (VOSB) participate in the State's procurement process as both prime contractors and subcontractors.

CONTRACT GOAL TO BE ACHIEVED BY THE CONTRACTOR. This contract includes a specific Veteran Small Business participation goal of **0.00%** based on the availability of CMS certified veteran-owned and service-disabled veteran-owned small business (VOSB/SDVOSB) vendors to perform or provide the anticipated services and/or supplies required by this contract.

The Veteran Small Business participation goal is applicable to all bids. In addition to the other award criteria established for this contract, the Department will award this contract to a Vendor that meets the goal or makes good faith efforts to meet the goal. This goal is also applicable to change orders and allowances within the scope of work provided by the certified VOSB/SDVOSB vendor. If Vendor is a CMS certified VOSB/SDVOSB vendor, the entire goal is met and no subcontracting with a CMS certified VOSB/SDVOSB vendor is required; however, Vendor must submit a Utilization Plan indicating that the goal will be met by self-performance.

VETERAN SMALL BUSINESS CERTIFIED VENDOR LOCATOR REFERENCES. Vendors may consult CMS' Veteran Small Business Vendor Directory at www.sell2.illinois.gov/cms/business as well as the directories of other certifying agencies, but firms must be certified with CMS as VOSB/SDVOSB vendors at the time of bid/offer (see Title 44 Illinois Administrative Code Sec. 20.530).

BIDDING PROCEDURES. Compliance with this Special Provision is a material bidding requirement. The failure of the bidder to comply with this special provision will render the bid nonresponsive or not responsible.

At the time of the bid, Vendor, or Vendor's proposed subcontractor, must be certified with CMS as a VOSB or SDVOSB.

Following are guidelines for Vendor's completion of the Utilization Plan.

- (a) The bidder shall submit a Veteran Business Program (VBP) Utilization Plan. The format for the VBP Utilization Plan is included in this special provision.
- (b) Vendor should include any additional information that will add clarity to Vendor's proposed utilization of certified Veteran Small Business vendors to meet the targeted goal. The Utilization Plan must demonstrate that Vendor has either:
 - (1) met the entire contract goal;
 - (2) made good faith efforts towards meeting the entire goal; or
 - (3) made good faith efforts towards meeting a portion of the goal. Any submission of good faith efforts by Vendor shall be considered as a request for a full or partial waiver.
- (c) If the bidder is a joint venture comprised of Veteran Business Enterprises (VBE) companies and non-VBE companies, the plan must also include:
 - (1) A clear identification of the portion of work to be performed by the VOSB/SDVOSB partner(s); and
 - (2) An agreement between a vendor and a certified VOSB/SDVOSB vendor in which a certified VOSB/SDVOSB vendor promises not to provide subcontracting or pricing quotations to other vendors is prohibited. The Department may request additional information to demonstrate compliance. Vendor agrees to cooperate promptly with the Department in submitting to interviews, allowing entry to places of business, providing further documentation, and to soliciting the cooperation of a proposed certified VOSB/SDVOSB vendor. Failure to cooperate by Vendor and certified VOSB/SDVOSB vendor may render the bidder nonresponsive or not responsible. The contract will not be awarded to Vendor unless Vendor's Utilization Plan is approved.

GOOD FAITH EFFORT PROCEDURES. Vendor must submit a Utilization Plans and Letters of Intent that meet or exceed the published goal. If Vendor cannot meet the stated goal, Vendor must document and explain within the Utilization Plan the good faith efforts it undertook to meet the goal. Utilization Plans are due at the time of bid. Vendors may not be permitted to correct goal deficiencies after bid due dates. The Department will consider the quality, quantity, and intensity of Vendor's efforts but if the Department determines that a Vendor did not demonstrate good faith efforts towards meeting the goal on the bid, the bid may be deemed nonresponsive or not responsible.

The Utilization Plan contains a checklist of actions that the Department will consider as evidence of Vendor's good faith efforts to meet the goal. Other factors or efforts brought to the attention of the Department may be relevant in appropriate cases.

- (a) In evaluating Vendor's good faith efforts, the Department may consider whether the ability of other bidders to meet the contract goal suggests that good faith efforts could have resulted in Vendor meeting the goal.
- (b) If the Department determines that Vendor has made good faith efforts to meet the goal, the Department may award the contract provided that Vendor is otherwise eligible for award.
- (c) If the Department determines that good faith efforts have not been met, the bidder may be determined to be nonresponsive or not responsible.

CALCULATING CERTIFIED VOSB/SDVOSB VENDOR PARTICIPATION. The Utilization Plan documents work anticipated to be performed by all certified VOSB/SDVOSB vendors and paid for upon satisfactory completion. The Department is only able to count toward the achievement of the overall goal and the contract goal the value of payments made for the work actually performed by the VOSB/SDVOSB vendors. Applicable guidelines for counting payments attributable to contract goals are listed below:

- (a) A Vendor shall count towards the goal only expenditures to firms that perform a commercially useful function in the work of the contract.
 - (1) A firm is considered to perform a commercially useful function when it is responsible for execution of a distinct element of the work of a contract and carries out its responsibilities by actually performing, managing, and supervising the work involved. The certified VOSB/SDVOSB vendor must also be responsible, with respect to materials or supplies used on the contract, for negotiating price, determining quality and quantity, ordering the materials or supplies, and installing the materials (where applicable) and paying for the material or supplies. To determine whether a firm is performing a commercially useful function, the Department shall evaluate the amount of work subcontracted, whether the amount the firm is to be paid under the contract is commensurate with the work it is actually performing and the credit claimed for its performance of the work, industry practices, and other relevant factors.
 - (2) A certified VOSB/SDVOSB vendor does not perform a commercially useful function if its role is limited to that of an extra participant in a transaction or contract through which funds are passed through in order to obtain certified VOSB/SDVOSB vendor participation. In determining whether a certified VOSB/SDVOSB vendor is such an extra participant, the Department shall examine similar transactions, particularly those in which certified VOSB/SDVOSB vendors do not participate, and industry practices.

- (b) The value of the work actually performed or goods/equipment provided by the certified VOSB/SDVOSB vendor shall be counted towards the goal. The entire amount of that portion of the contract that is performed by the certified VOSB/SDVOSB vendor, including supplies purchased or equipment leased by the certified VOSB/SDVOSB vendor shall be counted, except supplies purchased and equipment rented from the Prime Vendor submitting this bid.
- (c) A vendor shall count the portion of the total dollar value of the Veteran Small Business contract equal to the distinct, clearly defined portion of the work of the contract that the certified VOSB/SDVOSB vendor performs toward the goal. A vendor shall also count the dollar value of work subcontracted to other certified VOSB/SDVOSB vendor. Work performed by the non-certified VOSB/SDVOSB party shall not be counted toward the goal. Work that a certified VOSB/SDVOSB vendor subcontracts to a non-certified VOSB/SDVOSB vendor will not count towards the goal.
- (d) A Vendor shall count toward the goal 100% of its expenditures for materials and supplies required under the contract and obtained from a certified VOSB/SDVOSB vendor manufacturer, regular dealer, or supplier. A Vendor shall count toward the goal the following expenditures to certified VOSB/SDVOSB vendors that are not manufacturers, regular dealers, or suppliers.
 - (1) The fees or commissions charged for providing a bona fide service, such as professional, technical, consultant or managerial services and assistance in the procurement of essential personnel, facilities, equipment, materials or supplies required for performance of the contract, provided that the fee or commission is determined by the Department to be reasonable and not excessive as compared with fees customarily allowed for similar services.
 - (2) The fees charged for delivery of materials and supplies required by the contract (but not the cost of the materials and supplies themselves) when the hauler, trucker, or delivery service is not also the manufacturer or a supplier of the materials and supplies being procured, provided that the fee is determined by the Department to be reasonable and not excessive as compared with fees customarily allowed for similar services. The certified VOSB/SDVOSB vendor's trucking firm must be responsible for the management and supervision of the entire trucking operation for which it is responsible on the contract, and must itself own and operate at least one fully licensed, insured and operational truck used on the contract.
 - (3) The fees or commissions charged for providing any bonds or insurance specifically required for the performance of the contract, provided that the fee or commission is determined by the Department to be reasonable and not excessive as compared with fees customarily allowed for similar services.
- (e) Certified VOSB/SDVOSB vendors who are performing on contract as second tier subcontractors may be counted in meeting the established Veteran Small Business goal for this contract as long as the Prime Vendor can provide documentation indicating the utilization of these vendors.

- (f) A Vendor shall not count towards the goal expenditures that are not direct, necessary and related to the work of the contract. Only the amount of services or goods that are directly attributable to the performance of the contract shall be counted. Ineligible expenditures include general office overhead or other Vendor support activities.

CONTRACT COMPLIANCE. Compliance with this section is an essential part of the contract. The following administrative procedures and remedies govern Vendor's compliance with the contractual obligations established by the Utilization Plan. After approval of the Plan and award of the contract, the Utilization Plan becomes part of the contract. If Vendor did not succeed in obtaining certified VOSB/SDVOSB vendor participation to achieve the goal and the Utilization Plan was approved and contract awarded based upon a determination of good faith, the total dollar value of certified VOSB/SDVOSB vendor work calculated in the approved Utilization Plan as a percentage of the awarded contract value shall become the contract goal. Vendors are encouraged to seek VOSB/SDVOSB firms during the course of performing the contract.

- (a) **NO AMENDMENT.** The Utilization Plan may not be amended after contract execution without the Department's prior written approval.
- (b) **CHANGES TO WORK.** Vendor may not make changes to its contractual certified VOSB/SDVOSB vendor commitments or substitute certified VOSB/SDVOSB vendors without the prior written approval of the Department. Unauthorized changes or substitutions, including performing the work designated for a certified VOSB/SDVOSB vendor with Vendor's own forces, shall be a violation of the utilization plan and a breach of the contract, and shall be cause to terminate the contract, and/or seek other contract remedies or sanctions. The facts supporting the request for changes must not have been known nor reasonably should have been known by the parties prior to entering into the subcontract. Vendor must negotiate with the certified VOSB/SDVOSB vendor to resolve the problem. Where there has been a mistake or disagreement about the scope of work or goods/equipment, provided the certified VOSB/SDVOSB vendor can be substituted only where agreement cannot be reached for a reasonable price or schedule for the correct scope of work, goods or equipment.

Substitutions of a certified VOSB/SDVOSB vendor may be permitted under the following circumstances and possibly others on a case-by-case basis:

- (1) Unavailability after receipt of reasonable notice to proceed;
- (2) Failure of performance;
- (3) Financial incapacity;
- (4) Refusal by the certified VOSB/SDVOSB vendor to honor the bid or proposal price or scope;
- (5) Material mistake of fact or law about the elements of the scope of work of a solicitation where a reasonable price cannot be agreed;
- (6) Failure of the certified VOSB/SDVOSB vendor to meet insurance, licensing or bonding requirements;

- (7) The certified VOSB/SDVOSB vendor's withdrawal of its bid or offer; or
- (8) Decertification of the certified VOSB/SDVOSB vendor.

If it becomes necessary to substitute a certified VOSB/SDVOSB vendor or otherwise change the Utilization Plan, Vendor must notify the Department in writing of the request to substitute a certified VOSB/SDVOSB vendor or otherwise change the Utilization Plan. The request must state specific reasons for the substitution or change. The Department will approve or deny a request for substitution or other change in the Utilization Plan within five business days of receipt of the request.

Where Vendor has established the basis for the substitution to the Department's satisfaction, it must make good faith efforts to meet the contract goal by substituting a certified VOSB/SDVOSB vendor. Documentation of a replacement certified VOSB/SDVOSB vendor, or of good faith efforts to replace the certified VOSB/SDVOSB vendor, must meet the requirements of the initial Utilization Plan. If the goal cannot be reached and good faith efforts have been made, Vendor may substitute with a non-certified VOSB/SDVOSB vendor or Vendor may perform the work.

When adding a VOSB/SDVOSB, a new certified VOSB/SDVOSB vendor agreement should be executed and submitted to the Department with the appropriate subcontractor approval forms prior to the subcontractor's performance of work on the project.

Vendor shall maintain a record of all relevant data with respect to the utilization of certified VOSB/SDVOSB vendors. Full access to these records shall be granted by Vendor upon 48 hours written demand by the Department to any duly authorized representative thereof, or to any municipal, state or federal authorities. The Department shall have the right to obtain from Vendor any additional data reasonably related or necessary to verify any representations by Vendor. After the performance of the final item of work or delivery of material by the certified VOSB/SDVOSB vendor and final payment to the certified VOSB/SDVOSB vendor by Vendor, but not later than 15 calendar days after such payment, Vendor shall submit a statement confirming the final payment and the total payments made to the certified VOSB/SDVOSB vendor under the contract.

The Department will periodically review Vendor's compliance with these provisions and the terms of its contract. Without limitation, Vendor's failure to comply with these provisions or its contractual commitments as contained in the Utilization Plan, failure to cooperate in providing information regarding its compliance with these provisions or its Utilization Plan, or provision of false or misleading information or statements concerning compliance, certification status or eligibility of the certified VOSB/SDVOSB vendor, good faith efforts or any other material fact or representation shall constitute a material breach of this contract and entitle the Department to declare a default, terminate the contract, or exercise those remedies provided for in the contract or at law or in equity.

The Department reserves the right to withhold payment to Vendor to enforce these provisions and Vendor's contractual commitments. Final payment shall not be made pursuant to the contract until Vendor submits sufficient documentation demonstrating compliance with its Utilization Plan.

****RETURN WITH BID****

VETERAN BUSINESS PROGRAM (VBP) UTILIZATION PLAN

The VBP Utilization Plan includes the Letters of Intent and Good Faith Efforts.

(Vendor)_____ submits the following Utilization Plan as part of our bid or offer in accordance with the requirements of the (VBP). We understand that all subcontractors must be certified with the CMS Veteran Small Business Program at the time of submission of all bids. We understand that compliance with this section is an essential part of this contract and that the Utilization Plan will become a part of the contract, if awarded.

Vendor submits the following statement:

- ___ Vendor is a certified VOSB/SDVOSB and plans to fully meet the goal through self-performance.
- ___ Vendor has identified certified VOSB/SDVOSB subcontractor(s) to fully meet the established goal and submits the attached completed Letter(s) of Intent; or
- ___ Vendor has made good faith efforts towards meeting the entire goal, or a portion of the goal, and hereby requests a waiver (complete checklist below).

****RETURN WITH BID****

Vendor's person responsible for compliance:

Name: Title:
Telephone: Email

DEMONSTRATION OF GOOD FAITH EFFORTS TO ACHIEVE GOAL AND REQUEST FOR WAIVER

If the Veteran Small Business participation goal was not achieved, the Good Faith Efforts Procedures and Guidelines outlined in Contract Compliance will be used to evaluate submitted utilization plans. Vendors providing Good Faith Effort documentation and request for waiver must complete and submit the Good Faith Effort Contact Log with the bid or offer. Failure to submit Good Faith Effort documentation in its entirety shall render Vendor's bid nonresponsive or not responsible and cause it to be rejected or render Vendor ineligible for contract award. Insufficient Good Faith Effort documentation may render the bidder nonresponsive or not responsible.

Below is a checklist of actions that will be used to evaluate a Vendor's Demonstration of Good Faith Efforts and Request for Waiver. Please check the actions which you completed. If any of the following actions are not completed, please attach a detailed written explanation indicating why such action was not completed. If any other efforts were made to obtain Veteran Small Business participation in addition to the items listed below, attach a detailed description of such efforts.

- _____ Utilize the Sell2Illinois website: www2.illinois.gov/cms/business to identify certified VOSB/SDVOSB vendors within the respective commodity/service codes denoted above and at a minimum email all listed vendors and solicit quotes from all vendors who express an interest via follow-up emails or telephone calls.
- _____ Solicit through all reasonable and available means (e.g., attendance at a vendor conference, advertising and/or written notices) the interest of certified VOSB/SDVOSB vendors that have the capability to perform the work of the contract. Vendor must solicit this interest within sufficient time to allow the certified VOSB/SDVOSB vendors to respond to the solicitation. Vendor must determine with certainty if the certified VOSB/SDVOSB vendors are interested by taking appropriate steps to follow up initial solicitations and encourage them to submit a bid or proposal. Vendor must provide interested certified VOSB/SDVOSB vendors with adequate information about the plans, specifications, and requirements of the contract in a timely manner to assist them in responding promptly to the solicitation.
- _____ Select portions of the work to be performed by certified VOSB/SDVOSB vendors in order to increase the likelihood that the goal will be achieved. This includes, where appropriate, breaking out contract work items into economically feasible units to facilitate certified VOSB/SDVOSB vendor participation, even when Vendor might otherwise prefer to perform these work items with its own forces.
- _____ Make a portion of the work available to certified VOSB/SDVOSB vendors and selecting those portions of the work or material needs consistent with their availability, so as to facilitate certified VOSB/SDVOSB vendor participation.

****RETURN WITH BID****

- _____ Negotiate in good faith with interested certified VOSB/SDVOSB vendors. Evidence of such negotiation must include the names, addresses, email addresses, and telephone numbers of certified VOSB/SDVOSB vendors that were considered; a description of the information provided regarding the plans and specifications for the work selected for subcontracting and evidence as to why additional agreements could not be reached for certified VOSB/SDVOSB vendors to perform the work. A Vendor using good business judgment may consider a number of factors in negotiating with certified VOSB/SDVOSB vendors and may take a firm's price and capabilities into consideration. The fact that there may be some additional costs involved in finding and using certified VOSB/SDVOSB vendors may not be in itself sufficient reason for a Vendor's failure to meet the goal, as long as such costs are reasonable. Vendors are not required to accept higher quotes from certified VOSB/SDVOSB vendors if the price difference is excessive or unreasonable.

- _____ Thoroughly investigate the capabilities of certified VOSB/SDVOSB vendors and not reject them as unqualified without documented reasons.

- _____ Make efforts to assist interested certified VOSB/SDVOSB vendors in obtaining lines of credit or insurance as required by the State.

- _____ Make efforts to assist interested certified VOSB/SDVOSB vendors in obtaining necessary equipment, supplies, materials, or related assistance or services.

****RETURN WITH BID****

GOOD FAITH EFFORTS CONTACT LOG

Use this Log to document all contacts and responses (telephone, e-mail, fax, etc.) regarding the solicitation of certified VOSB/SDVOSB vendors within the specific scope of work selected. It is not necessary to show contacts with certified VOSB/SDVOSB vendors who are identified on the Letter(s) of Intent. Keep and submit copies of all emails sent and received from prospective vendors. Include a copy of the commodity list or scope of work you solicited prospective vendors to perform. Duplicate this log as necessary; do not limit your contacts to the number of spaces shown.

Name of Certified Veteran Small Business Vendor	Date	Method of Contact	Scope of Work Solicited	Reason Agreement Was Not Reached

****RETURN WITH BID****

LETTER OF INTENT (LOI)

BETWEEN PRIME VENDOR AND CERTIFIED VETERAN SMALL BUSINESS VENDOR

Instructions: The Bidder is required to submit a separate, signed LOI from each identified certified VOSB/SDVOSB vendor (hereinafter "certified vendors"). **LOIs must be submitted with the Bid and must be signed by both parties.** The Prime Bidder shall not prohibit or otherwise limit certified vendor(s) from providing bids or quotes to other potential bidders. Each LOI shall include the dollar amount, percentage, and scope of work to be performed by each identified certified vendor. All LOI's shall be subject to Department approval.

Any changes involving or affecting the identified certified vendor(s) may not be permitted without written approval of the Department.

Contract Number:

Name of Vendor:

Name of Contact Person:

Address:

City, State and Zip:

Telephone: Fax: Email:

Name of Certified Veteran Small Business Vendor: Name of Contact Person:

Address:

City, State and Zip:

Telephone: Fax: Email:

Proposed % of Contract to be performed by the certified vendor firm: _____%

Proposed dollar amount of Contract to be performed by the certified vendor: \$_____

Description of work to be performed by the certified vendor firm:

Vendor and the Certified vendor above hereby agree that upon the execution of a contract for the above-named project between Bidder and the State of Illinois, the certified vendor will perform the scope of work for the percentage as indicated above.

Bidder (Company Name or D/B/A):

Certified Vendor (Company Name or D/B/A):

Signature:

Signature:

Printed Name:

Printed Name:

Title:

Title:

Date:

Date:

FOR INDEX OF SHEETS & STATE STANDARDS
SEE SHEET NO. 2

STATE OF ILLINOIS
DEPARTMENT OF TRANSPORTATION
DIVISION OF HIGHWAYS

CONTRACT NO. 64L73
D-92-094-16

PROJECT ENGINEER: SCOTT KULLERSTRAND

SQUAD LEADER: LANCE NICKLAUS 815-284-5407

PROPOSED HIGHWAY PLANS
F.A.U. ROUTE 5862 (POPPY GARDEN ROAD)
F.A.U. ROUTE 5863 (GREEN RIVER ROAD)
SECTION D2 RS 2017-2
HENRY COUNTY
C-92-105-16

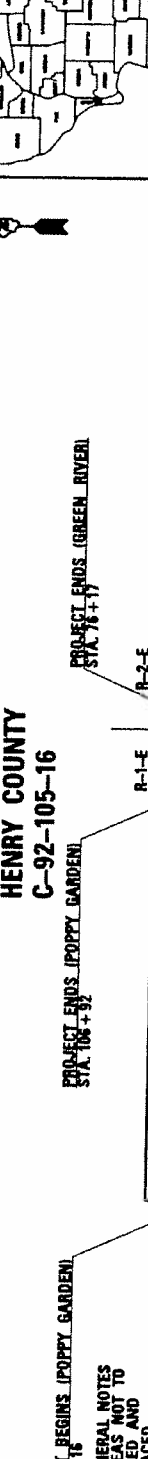
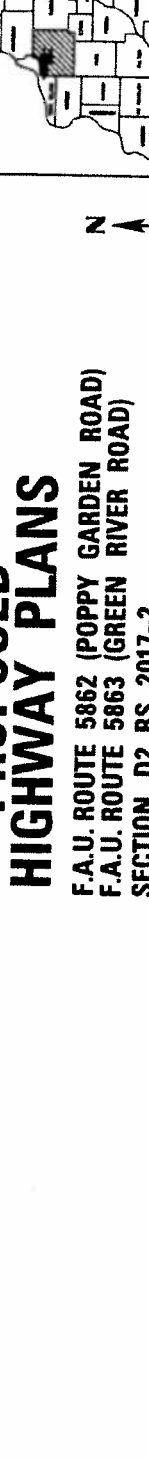

PROJECT BEGINS (POPPY GARDEN)
STA. 0+16

PROJECT ENDS (POPPY GARDEN)
STA. 106+92

PROJECT BEGINS (GREEN RIVER)
STA. 0+16

PROJECT ENDS (GREEN RIVER)
STA. 16+17

SEE GENERAL NOTES FOR AREAS NOT TO BE MILLED AND RESURFACED

SEE GENERAL NOTES FOR AREAS NOT TO BE MILLED AND RESURFACED

SEE GENERAL NOTES FOR AREAS NOT TO BE MILLED AND RESURFACED

TOWNSHIP (SECTION):
COLONA (11,12,13,14)
EDFORD (7,18)

POPPI GARDEN ROAD:
GROSS LENGTH OF PROJECT = 10,676 FOOT = 2.02 MILES
NET LENGTH OF PROJECT = 10,676 FOOT = 2.02 MILES

GREEN RIVER ROAD:
GROSS LENGTH OF PROJECT = 7,602 FOOT = 1.44 MILES
NET LENGTH OF PROJECT = 7,602 FOOT = 1.44 MILES

CONTRACT NO. 64L73
F.A.U. ROUTE 5862 & 5863 (POPPY GARDEN ROAD & GREEN RIVER ROAD)

SECTION D2 RS 2017-2 HENRY COUNTY

STATE OF ILLINOIS
DEPARTMENT OF TRANSPORTATION
DIVISION OF HIGHWAYS

SUBMITTED July 27 2016

DEPUTY DIRECTOR OF HIGHWAYS, REGION ENGINEER

ENGINEER OF DESIGN AND ENVIRONMENT

DIRECTOR OF HIGHWAYS, CHIEF ENGINEER

PRINTED BY THE AUTHORITY OF THE STATE OF ILLINOIS

INDEX

FAU 5862 (POPPY GARDEN ROAD)
FAU 5863 (GREEN RIVER ROAD)
SECTION D2 RS 2017-2
HENRY COUNTY
CONTRACT NO. 64L73
Sheet 2 of 40

1	Cover Sheet
2	Index of Sheets / State Standards
3-4	Summary of Quantities
5-6	General Notes
7-9	Typical Sections
10-28	Plan Sheets
29-31	Schedule Of Quantities
32	Hot Mix Asphalt Schedule
33	Safety Edge (3P Projects) (49.2)
34-37	Work Zone Sign Details (34.1)
38-40	Typical Pavement Markings (41.1)

STATE STANDARDS

701006-05	OFF-ROAD OPERATIONS, 2L, 2W, 15'(4.5M) TO 24'(600M) FROM PAVEMENT EDGE
701301-04	LANE CLOSURE, 2L, 2W, SHORT TIME OPERATIONS
701306-03	LANE CLOSURE, 2L, 2W, SLOW MOVING OPERATIONS DAY ONLY, FOR SPEEDS \geq 45 MPH
701311-03	LANE CLOSURE, 2L, 2W, MOVING OPERATIONS, DAY ONLY
701901-05	TRAFFIC CONTROL DEVICES
720011-01	METAL POST FOR SIGNS, MARKERS AND DELINEATORS
728001-01	TELESCOPING STEEL SIGN SUPPORT
729001-01	APPLICATIONS OF TYPES A AND B METAL POST (FOR SIGNS & MARKERS)
780001-05	TYPICAL PAVEMENT MARKINGS

SUMMARY OF QUANTITIES

FAU 5862 (Poppy Garden Road)
 FAU 5863 (Green River Road)
 SECTION D2 RS 2017-2
 HENRY COUNTY
 CONTRACT #64L73
 SHEET 3 OF 40

CODE NO.	ITEM	UNIT	POPPY GARDEN	GREEN RIVER	URBAN
			FAU 5862	FAU 5863	100% State 0005
			FAU 5862	FAU 5863	TOTAL QUANTITY
40600275	BITUMINOUS MATERIALS (PRIME COAT)	POUND	13680	13313	26993
40600627	LEVELING BINDER (MACHINE METHOD), IL 9.5FG, N50	TON	1169	1137	2306
40600990	TEMPORARY RAMP	SQ YD	173	183	356
40603310	HOT-MIX ASPHALT SURFACE COURSE, MIX "C", N50	TON	1462	1422	2884
44000157	HOT-MIX ASPHALT SURFACE REMOVAL 2"	SQ YD	20266	19722	39988
48102100	AGGREGATE WEDGE SHOULDERS, TYPE B	TON	939	648	1587
67100100	MOBILIZATION	L SUM	0.5	0.5	1
70100460	TRAFFIC CONTROL AND PROTECTION, STANDARD 701306	L SUM	0.5	0.5	1

CP

SUMMARY OF QUANTITIES

FAU 5862 (Poppy Garden Road)
 FAU 5863 (Green River Road)
 SECTION D2 RS 2017-2
 HENRY COUNTY
 CONTRACT #64L73
 SHEET 4 OF 40

CODE NO.	ITEM	UNIT	POPPY GARDEN		GREEN RIVER		URBAN	
			FAU 5862	FAU 5863	FAU 5862	FAU 5863	100% State	0005
70300100	SHORT TERM PAVEMENT MARKING	FOOT	3224	2984				6208
70300150	SHORT TERM PAVEMENT MARKING REMOVAL	SQ FT	269	249				518
78000100	THERMOPLASTIC PAVEMENT MARKING - LETTERS AND SYMBOLS	SQ FT	122.4					122.4
78000650	THERMOPLASTIC PAVEMENT MARKING - LINE 24"	FOOT	66					66
78001110	PAINT PAVEMENT MARKING- LINE 4 INCH	FOOT	73514	56272				129786
Z0048665	RAILROAD PROTECTIVE LIABILITY INSURANCE	L SUM	1					1

* * * * *
 * * * * *
 * * * * *
 * * * * *
 * * * * *

* * * * *
 * * * * *

GENERAL NOTES

The final top 4 inches of soil in any right-of-way area disturbed by the Contractor must be capable of supporting vegetation. The soil must be from the A horizon (zero to 2' deep) of soil profiles of local soils. The cost of this work shall be included in the unit prices bid and no additional compensation will be allowed.

All Borrow/Waste/Use sites must be approved by the Department prior to removing any material from the project or initiating any earthmoving activities, including temporary stockpiling outside the limits of construction.

The Contractor shall seed all disturbed areas within the project limits. Seeding Class 4 or 2A shall be used, except in front of properties where the grass will be mowed, then use Seeding, Class 1A. Class 2A shall be used on front slopes and ditch bottoms. Class 4 shall be used behind Type A gutter, on all backslopes and areas behind the backslope, and beyond the toe of front slope on fill sections without ditches. This work will be included in the contract unit price per Cubic Ton for AGGREGATE WEDGE SHOULDERS, TYPE B.

Fertilizer shall be applied to all disturbed areas and incorporated into the seedbed prior to seeding or placement of sod at the rate specified in Sections 250 and 252 of the Standard Specifications. This work shall be included in the cost of AGGREGATE WEDGE SHOULDERS, TYPE B.

Mulch Method II shall be applied over all seeded areas. This shall be included in the cost of the AGGREGATE WEDGE SHOULDERS, TYPE B.

Milling machines on this project shall be capable of removing a layer of bituminous a minimum 6' wide and 1½ inches in depth in a single pass.

The following Mixture Requirements are applicable for this project:
 Poppy Garden & Green River

Mixture Uses(s):	SURFACE	LEVEL BINDER	
PG:	PG 64-22	PG-64-22	
Design Air Voids	3.0 @ N50	3.0 @ N50	
Mixture Composition (Gradation Mixture)	IL 9.5	IL 9.5 FG	
Friction Aggregate	C	N/A	
20 Year ESAL	0.4/0.3	0.4/0.3	
Quality Management Program to be Used	QC/QA	QC/QA	
Sublot Tonnage	N/A	N/A	

The Contractor will be required to furnish 5 1/2" high brass stencils as approved by the Engineer and install stationing at 250' intervals. Stationing shall be placed on both lanes of 2-lane highways and on the outside lanes in both directions on 4-lane highways. The stations shall be placed 6" inside the pavement marking edge so they can be read from the shoulder. This work will be included in the cost of the final pavement surface.

The area to be tacked or primed shall be limited to that which can be covered with HMA on the next day's production, but no more than five days in advance of the placement of the HMA, unless approved by the Engineer.

FAU Route 5862 (Poppy Garden Road)
FAU Route 5863 (Green River Road)
Section D2 RS 2017-2
Henry County
Contract #64L73

If, during the grinding or resurfacing operations, the existing mailboxes become a hindrance, the Contractor shall be required to carefully remove and reinstall the mailboxes as directed by the Engineer. This work shall be included in the contract unit price for the HOT-MIX ASPHALT SURFACE COURSE OF THE TYPE SPECIFIED.

Pavement Marking shall be done according to Standard 780001, except as follows:

1. All words, such as ONLY, shall be 8 feet high.
2. All non-freeway arrows shall be the large size
3. The distance between yellow no-passing lines shall be 8 inches, not 7 inches, as shown in the Detail of Typical Lane and Edge Lines.
4. Centerline Skip Dash Pavement Marking on multi-lane divided, multi-lane undivided, and One-way roadway shall be according to District Standard 41.1.

The Contractor shall be responsible for locating and protecting utility property during construction operations as outlined in Article 107.39 of the Standard Specifications. A minimum of 48 hours advance notice is required for non-emergency work. The JULIE number is 800-892-0123. The following listed utilities located within the project limits or immediately adjacent to the project construction limits are members of JULIE:

IDOT is not a member of JULIE. If you are near any overhead lighting, intersection lighting or traffic signals, contact the IDOT Traffic Office at 815/284-5469 at least 48 hours prior to work.

Milling and resurfacing shall be omitted within the project limits at the following locations:

Poppy Garden Road:
Station 6+20 – 6+26
Station 8+59 – 10+73
Station 36+48 – 64+28

Green River Road:
Station 23+63 – 25+08

All pavement markings and aggregate shoulders shall be placed within the areas listed above.

Before placement of the HMA Surface Course, the contractor shall string line from the railroad track crossing surface a distance of 60 foot to ensure a smooth transition taper from the crossing surface to the HMA surface.

Entrances that are behind concrete gutter shall not be milled and resurfaced. All concrete entrances and side roads shall not be milled or resurfaced rather milling operations shall butt right up to the face of the entrance or side road.

SHEET NO. 64.73		CONTRACT NO. 64.73	
SECTION	COUNTY	SECTION	COUNTY
OF NO. 2017-2	NEWBY	OF NO. 2017-2	NEWBY
TO STA.		TO STA.	
FOR DIST. NO.	ILLINOIS	FED. AID PROJECT	

TYPICAL SECTIONS

EXISTING POPPY GARDEN RD
 STA. 0+16 - 106+92
 & 200+00 - 500+80

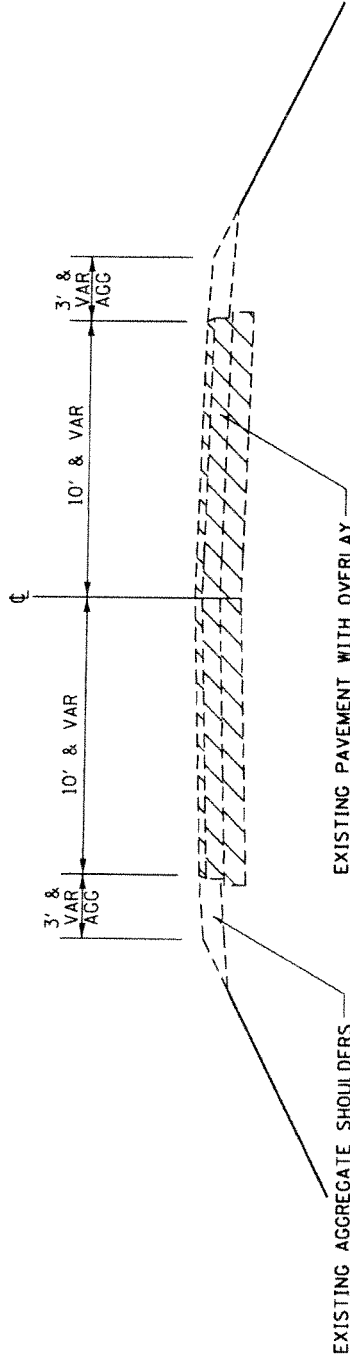

PROPOSED POPPY GARDEN RD
 STA. 0+16 - 106+92
 & 200+00 - 500+80

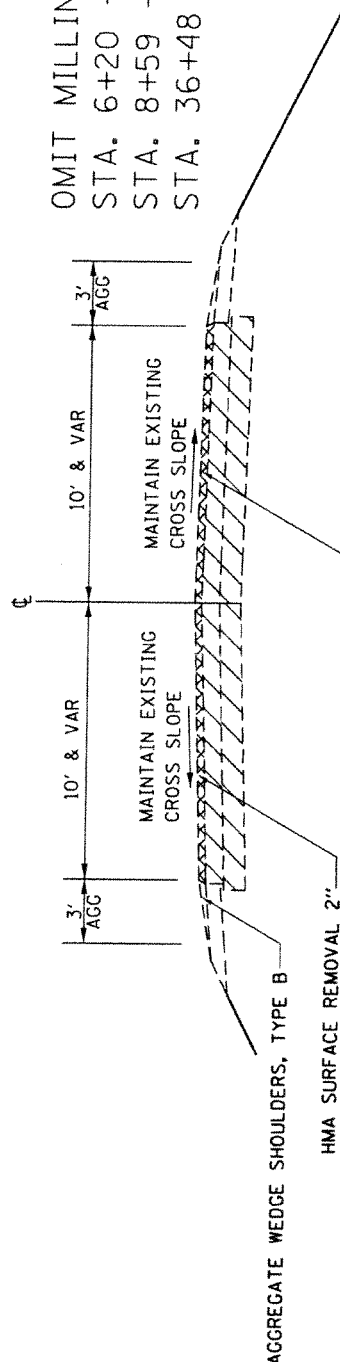

LEVELLING BINDER (MM) IL 9.5FG, N50
 HMA SURFACE COURSE, MIX "C", N50

OMIT MILLING AND RESURFACING:
 STA. 6+20 - 6+26
 STA. 8+59 - 10+73
 STA. 36+48 - 64+28

SURFACE COURSE & LEVELLING BINDER
 112 LBS/SQ YD/IN

REVISIONS

NO.	DATE	DESCRIPTION
1		
2		
3		
4		
5		
6		
7		
8		
9		
10		

CONTRACT NO. 64.15	
SECTION	COUNTY
DATE OF ISSUE	DATE
BY	FOR
NO.	NO.
NO.	NO.
NO.	NO.
NO.	NO.

TYPICAL SECTIONS

EXISTING GREEN RIVER RD
 STA. 0+15 - 76+17
 & 100+40 - 400+00

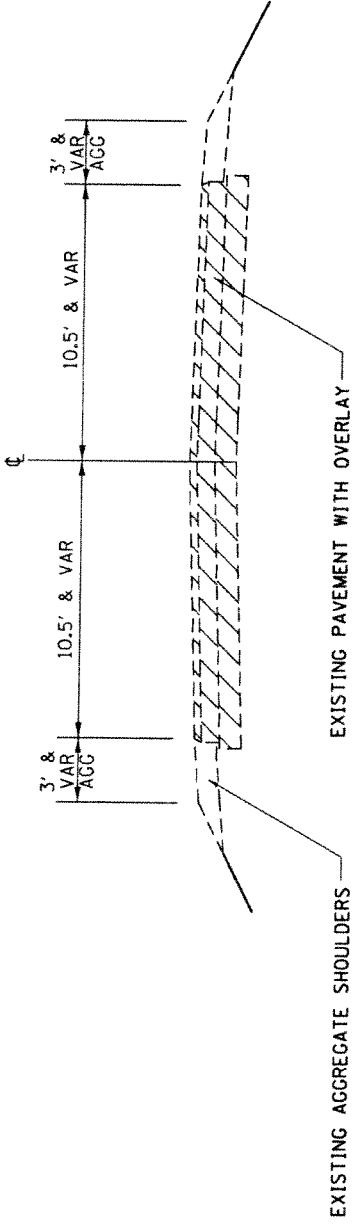

EXISTING AGGREGATE SHOULDERS

EXISTING PAVEMENT WITH OVERLAY

TYPE A GUTTER:
 STA. 18+91 - 23+29 LT
 STA. 19+96 - 23+29 RT

CURB AND GUTTER:
 STA. 69+29 - 76+17 LT
 STA. 68+91 - 76+17 RT

HMA SHOULDERS

VAR. WIDTH:

STA. 18+91 - 28+78 LT
 STA. 19+96 - 23+64 RT
 AREA FIGURED IN MAINLINE
 AREA QUANTITIES

PROPOSED GREEN RIVER RD
 STA. 0+15 - 76+17
 & 100+40 - 400+00

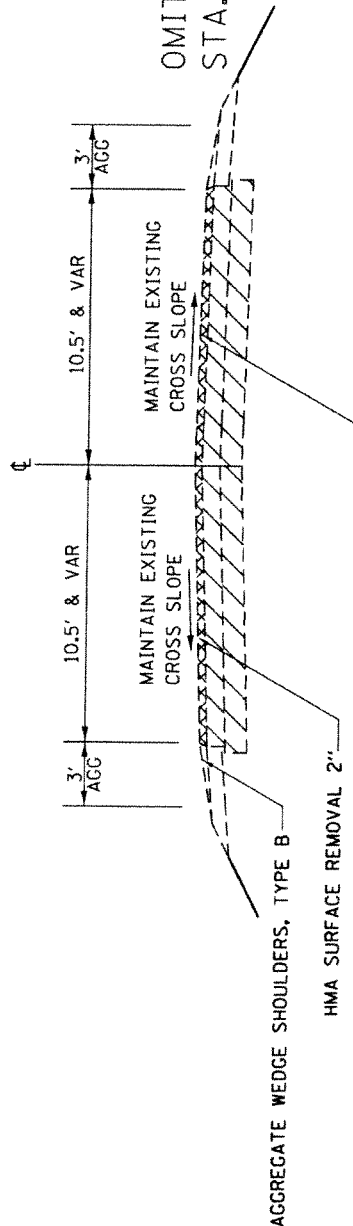

AGGREGATE WEDGE SHOULDERS, TYPE B

HMA SURFACE REMOVAL 2"

LEVELING BINDER (MM) IL 9.5FG, N50
 HMA SURFACE COURSE, MIX "C", N50

MAINTAIN EXISTING CROSS SLOPE

MAINTAIN EXISTING CROSS SLOPE

OMIT MILLING AND RESURFACING:

STA. 23+63 - 25+08

SURFACE COURSE & LEVELING BINDER
 112 LBS/SQ YD/IN

ILLINOIS DEPARTMENT OF TRANSPORTATION
 TYPICAL SECTIONS

TYPICAL SECTION HMA ENTRANCES AND SIDE ROADS

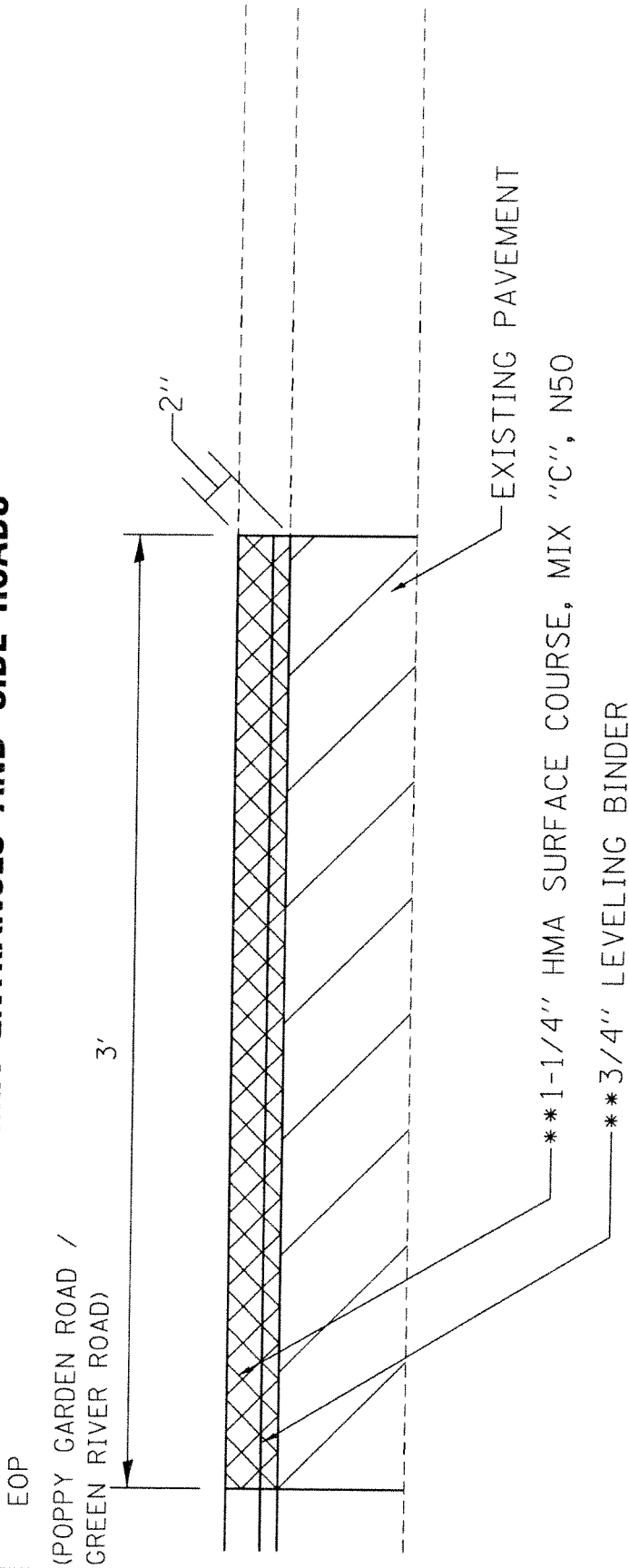

MILL FROM EOP FOR A DISTANCE OF 3' BACK INTO ENTRANCE OR SIDEROAD. INCLUDED IN COST OF HMA SURFACE REMOVAL 2"

ENTRANCES WITHIN THE CURB AND GUTTER SECTIONS SHALL NOT BE MILLED AND RESURFACED

EXISTING

** SURFACE COURSE & LEVELING BINDER
112 LBS/SQ YD/IN

FILE NO. -	DESIGNED -	REVISIONS -	SCALE -	SHEET NO. OF SHEETS -	DATE -	SECTION -	COUNTY -	TOTAL SHEET NO. -
DATE -	DRAWN -	REVISIONS -	SCALE -	SHEET NO. OF SHEETS -	DATE -	SECTION -	COUNTY -	TOTAL SHEET NO. -
FILE NO. -	DESIGNED -	REVISIONS -	SCALE -	SHEET NO. OF SHEETS -	DATE -	SECTION -	COUNTY -	TOTAL SHEET NO. -
FILE NO. -	DESIGNED -	REVISIONS -	SCALE -	SHEET NO. OF SHEETS -	DATE -	SECTION -	COUNTY -	TOTAL SHEET NO. -

STATE OF ILLINOIS
DEPARTMENT OF TRANSPORTATION

PLAN SHEET POPPY GARDEN ROAD

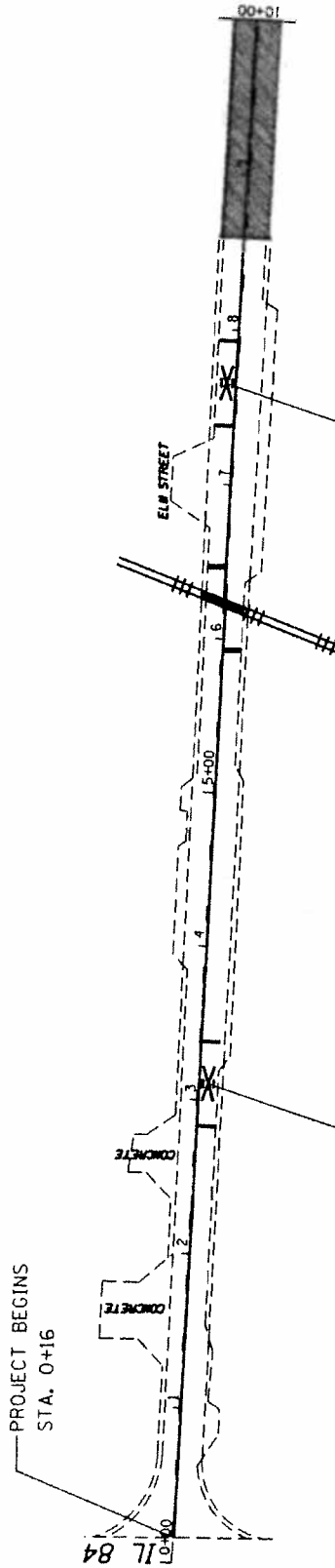

THERMOPLASTIC L&S
STA. 3+10 RR & X
THERMOPLASTIC LINE 24"
STA. 2+82, 3+35, & 5+93

THERMOPLASTIC L&S
STA. 3+10 RR & X
THERMOPLASTIC LINE 24"
STA. 2+82, 3+35, & 5+93

HATCHED AREAS TO BE
OMITTED FROM PAVING
OPERATIONS ONLY.



FILE NO. 5862 A 5863 COUNTY [] DISTRICT [] SHEET NO. [] OF [] SHEETS DATE []		STATE OF ILLINOIS DEPARTMENT OF TRANSPORTATION	
CHECKED BY [] DATE []	REVISIONS [] BY [] DATE []	DRAWN BY [] DATE []	PROJECT NO. [] SHEET NO. [] OF [] SHEETS

**PLAN SHEET
POPPY GARDEN ROAD**

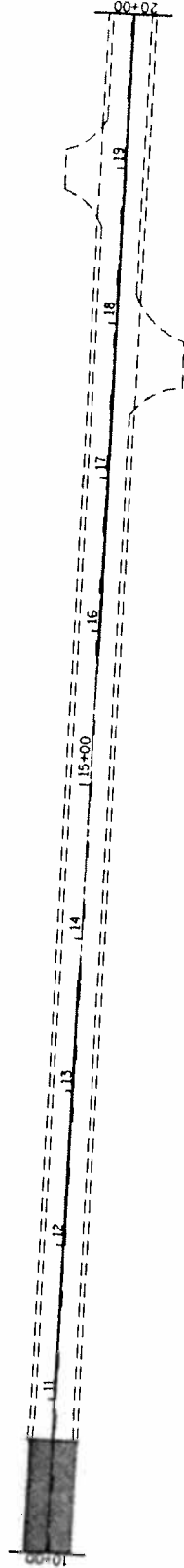

HATCHED AREAS TO BE
OMITTED FROM PAVING
OPERATIONS ONLY.

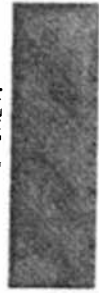

FILE NO. 45862 & 5863 STATE OF ILLINOIS DEPARTMENT OF TRANSPORTATION		SHEET NO. 11 OF 11	
DATE 11/15/11	SECTION 11	COUNTY DECATUR	DISTRICT 11
SCALE 1" = 40'	SHEET NO. 11 OF 11	PROJECT NO. 11-11-11	
DESIGNER [REDACTED]	CHECKED [REDACTED]	DATE 11/15/11	[REDACTED]
DRAWN BY [REDACTED]	CHECKED [REDACTED]	DATE 11/15/11	[REDACTED]
PLOT NO. 11-11-11	CHECKED [REDACTED]	DATE 11/15/11	[REDACTED]

PLAN SHEET POPPY GARDEN ROAD

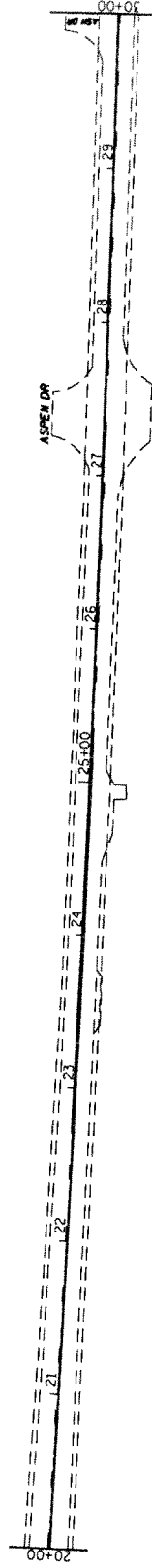
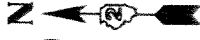

FILE NO. 1	DESIGNED -	REVISION -	+5862 & 5863	
DATE 10/20/17	DRAWN -	CHECKED -	SECTION	CONTRACT NO. 6A17
PROJECT NO. 17-0000000000	CHECKED -	REVISION -	NO. 1	NO. 40
DATE 10/20/17	DATE	DATE	DATE 07/25/2017	DATE 07/25/2017
STATE OF ILLINOIS DEPARTMENT OF TRANSPORTATION	SHEET 1 OF 1		SHEET 1 OF 1	
SCALE: _____ TO STA. _____				

**PLAN SHEET
POPPY GARDEN ROAD**

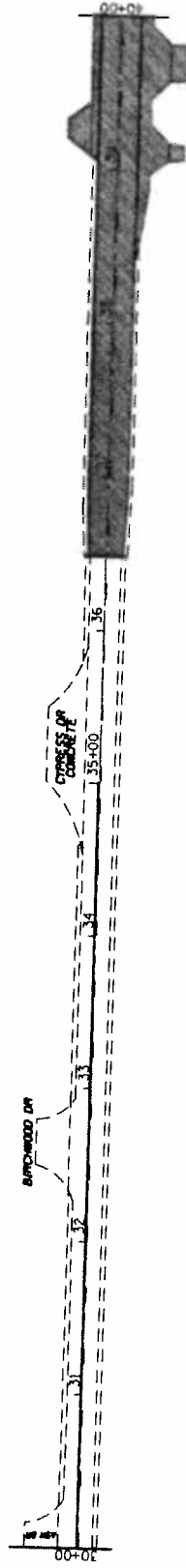

HATCHED AREAS TO BE
OMITTED FROM PAVING
OPERATIONS ONLY.

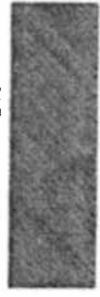

FILE NAME: _____ DRAWN BY: _____ DATE: _____		SHEET NO. _____ OF _____ SHEETS SCALE: _____ TO 1" = _____		COUNTY: _____ DISTRICT: _____ SECTION: _____ BEING PAVED: _____ TOTAL LENGTH: _____	
REVISIONS: 1. _____ 2. _____ 3. _____	REVISIONS: 1. _____ 2. _____ 3. _____	REVISIONS: 1. _____ 2. _____ 3. _____	REVISIONS: 1. _____ 2. _____ 3. _____	STATE OF ILLINOIS DEPARTMENT OF TRANSPORTATION	

**PLAN SHEET
POPPY GARDEN ROAD**

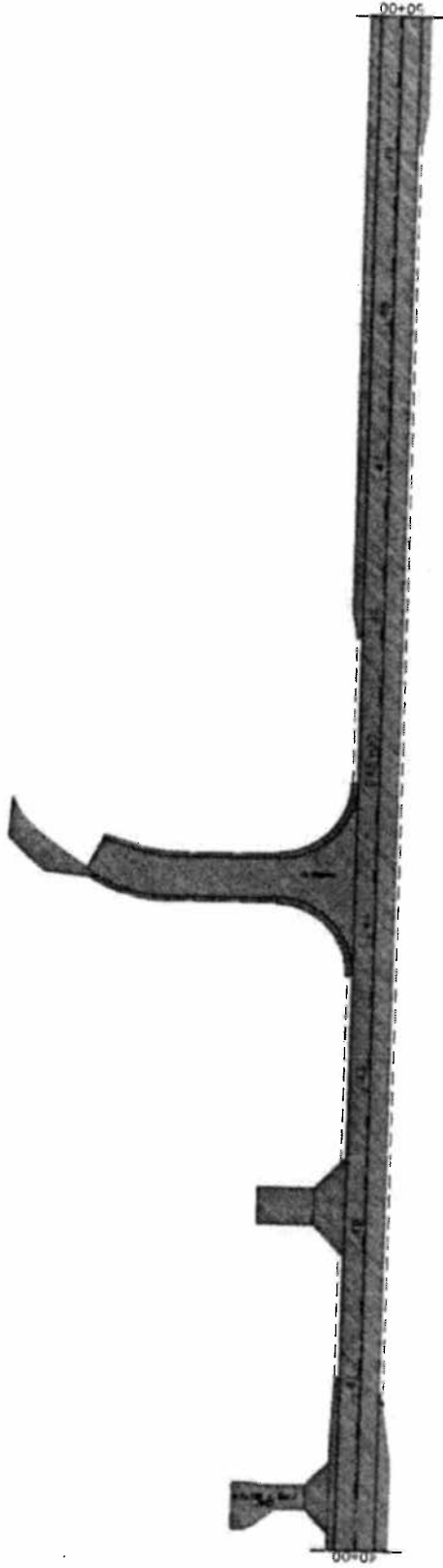

HATCHED AREAS TO BE
OMITTED FROM PAVING
OPERATIONS ONLY.



STATE OF ILLINOIS DEPARTMENT OF TRANSPORTATION		SHEET NO. 5862 & 5863 OF 58 201-2		COUNTY NO.	DISTRICT NO.
DATE 1951	DRAWN BY S. J. ...	CHECKED BY ...	REVISIONS NO. 1 DATE	SCALE 1" = 40'	PROJECT NO. TO STATE

**PLAN SHEET
POPPY GARDEN ROAD**



HATCHED AREAS TO BE
OMITTED FROM PAVING
OPERATIONS ONLY.



FILE NO. 5862 & 5863 COUNTY [] DISTRICT [] SECTION [] TOWNSHIP [] RANGE [] MERIDIAN []		STATE OF ILLINOIS DEPARTMENT OF TRANSPORTATION		SHEET [] OF [] SHEETS SCALE [] TO S.I.T.	
DESIGNED BY [] CHECKED BY [] DATE []	DRAWN BY [] CHECKED BY [] DATE []	ESTIMATED COST [] ESTIMATED QUANTITY [] ESTIMATED DATE []	ESTIMATED COST [] ESTIMATED QUANTITY [] ESTIMATED DATE []	ESTIMATED COST [] ESTIMATED QUANTITY [] ESTIMATED DATE []	ESTIMATED COST [] ESTIMATED QUANTITY [] ESTIMATED DATE []

**PLAN SHEET
POPPY GARDEN ROAD**

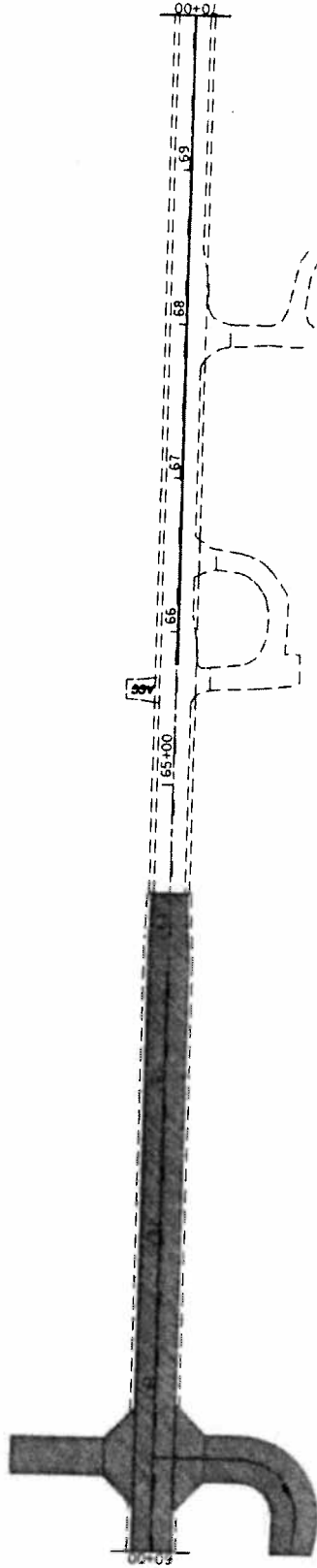

HATCHED AREAS TO BE
OMITTED FROM PAVING
OPERATIONS ONLY.



STATE OF ILLINOIS DEPARTMENT OF TRANSPORTATION	SHEET NO. 2 OF 2	PROJECT NO. 10-111	SCALE 1" = 40'
PROJECT NO. 10-111 CONTRACT NO. 10-111	SECTION NO. 2 OF 2	COUNTY COOK TOWNSHIP 12N RANGE 14E SECTION 36	DATE 10/1/11
DESIGNER CHECKED SURVEYED REVISIONS	DATE DATE DATE	REVISIONS REVISIONS REVISIONS	DATE DATE DATE

PLAN SHEET
POPPY GARDEN ROAD

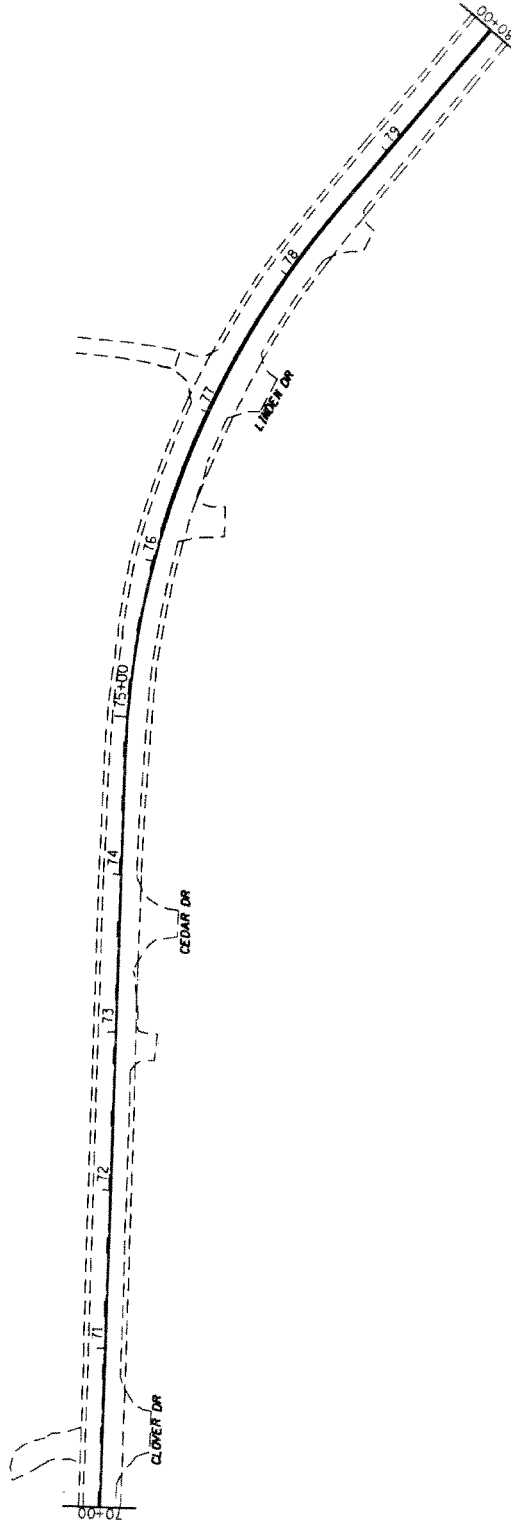

FILE NAME	45862 & 5863	SHEET	OF	SHEETS	STA.	TO STA.
DATE	DATE OF 2017	CONTRACT NO.	NO.	NO.	NO.	NO.
SCALE	SCALE	SCALE	SCALE	SCALE	SCALE	SCALE
DESIGNED	DRAWN	CHECKED	DATE	DATE	DATE	DATE
REVISION	REVISION	REVISION	REVISION	REVISION	REVISION	REVISION
STATE OF ILLINOIS	DEPARTMENT OF TRANSPORTATION					

PLAN SHEET POPPY GARDEN ROAD

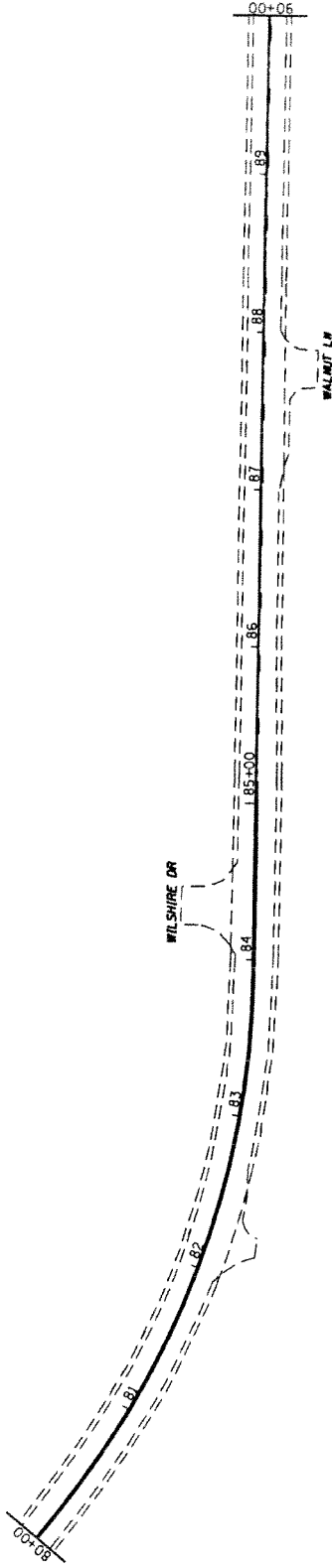

SHEET NO. 2 OF 2		CONTRACT NO. 5862 & 5863	
SECTION DR. NO. 201-2		CONTRACT NO. 5863	
SCALE: 1" = 40'		SHEETS 2 OF 2	
STATE OF ILLINOIS DEPARTMENT OF TRANSPORTATION			
DESIGNED - DRAWN - CHECKED - DATE -	REVISED - REVISED - REVISED - REVISED -	TOTAL SHEET NO. 2 TOTAL SHEETS 2 CONTRACT NO. 5863	

**PLAN SHEET
POPPY GARDEN ROAD**

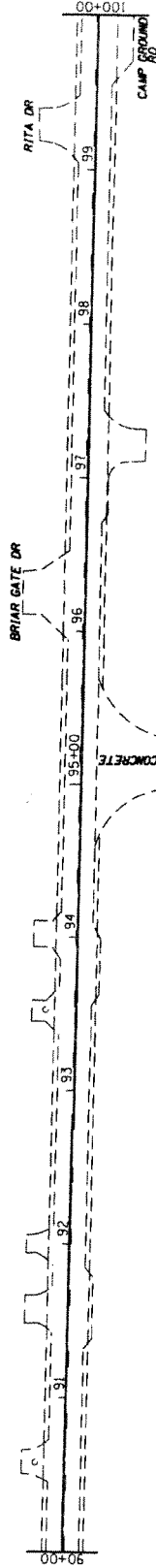
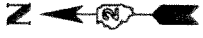

FILE NAME: DRAWN: CHECKED: DATE:		DESIGNED: REVISION:		STATE OF ILLINOIS DEPARTMENT OF TRANSPORTATION		SCALE: SHEET OF SHEETS: 3/4 TO 5/4		PROJECT NO.: 5862 & 5863		COUNTY: TOWNSHIP: SECTION: CONTRACT NO.: 64.13	
---	--	------------------------	--	---	--	---------------------------------------	--	--------------------------	--	---	--

PLAN SHEET POPPY GARDEN ROAD

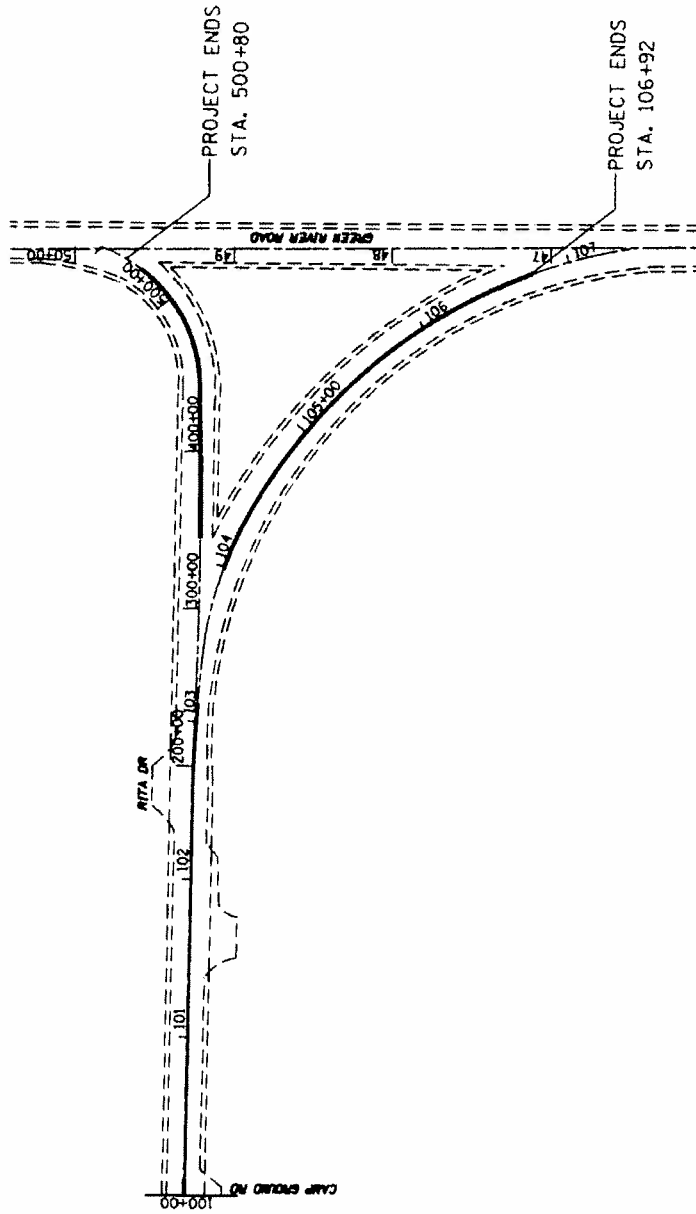

DATE: 10/15/2014 DRAWN BY: [Name] CHECKED BY: [Name] SCALE: AS SHOWN SHEET NO. 1 OF 1		PROJECT NO. 100-000-000 COUNTY: [County] DATE: 10/15/2014	
STATE OF ILLINOIS DEPARTMENT OF TRANSPORTATION			
REVIEWED: [Name] DATE: [Date]	CHECKED: [Name] DATE: [Date]	DESIGNED: [Name] DATE: [Date]	DRAWN: [Name] DATE: [Date]

Plot Date = Jul-26-2018 09:44:03 AM

REVISIONS	NO.	DESCRIPTION	DATE
REVISIONS	1	REVISED	
REVISIONS	2	REVISED	
REVISIONS	3	REVISED	
REVISIONS	4	REVISED	
REVISIONS	5	REVISED	
REVISIONS	6	REVISED	
REVISIONS	7	REVISED	
REVISIONS	8	REVISED	
REVISIONS	9	REVISED	
REVISIONS	10	REVISED	
REVISIONS	11	REVISED	
REVISIONS	12	REVISED	
REVISIONS	13	REVISED	
REVISIONS	14	REVISED	
REVISIONS	15	REVISED	
REVISIONS	16	REVISED	
REVISIONS	17	REVISED	
REVISIONS	18	REVISED	
REVISIONS	19	REVISED	
REVISIONS	20	REVISED	
REVISIONS	21	REVISED	
REVISIONS	22	REVISED	
REVISIONS	23	REVISED	
REVISIONS	24	REVISED	
REVISIONS	25	REVISED	
REVISIONS	26	REVISED	
REVISIONS	27	REVISED	
REVISIONS	28	REVISED	
REVISIONS	29	REVISED	
REVISIONS	30	REVISED	
REVISIONS	31	REVISED	
REVISIONS	32	REVISED	
REVISIONS	33	REVISED	
REVISIONS	34	REVISED	
REVISIONS	35	REVISED	
REVISIONS	36	REVISED	
REVISIONS	37	REVISED	
REVISIONS	38	REVISED	
REVISIONS	39	REVISED	
REVISIONS	40	REVISED	
REVISIONS	41	REVISED	
REVISIONS	42	REVISED	
REVISIONS	43	REVISED	
REVISIONS	44	REVISED	
REVISIONS	45	REVISED	
REVISIONS	46	REVISED	
REVISIONS	47	REVISED	
REVISIONS	48	REVISED	
REVISIONS	49	REVISED	
REVISIONS	50	REVISED	
REVISIONS	51	REVISED	
REVISIONS	52	REVISED	
REVISIONS	53	REVISED	
REVISIONS	54	REVISED	
REVISIONS	55	REVISED	
REVISIONS	56	REVISED	
REVISIONS	57	REVISED	
REVISIONS	58	REVISED	
REVISIONS	59	REVISED	
REVISIONS	60	REVISED	
REVISIONS	61	REVISED	
REVISIONS	62	REVISED	
REVISIONS	63	REVISED	
REVISIONS	64	REVISED	
REVISIONS	65	REVISED	
REVISIONS	66	REVISED	
REVISIONS	67	REVISED	
REVISIONS	68	REVISED	
REVISIONS	69	REVISED	
REVISIONS	70	REVISED	
REVISIONS	71	REVISED	
REVISIONS	72	REVISED	
REVISIONS	73	REVISED	
REVISIONS	74	REVISED	
REVISIONS	75	REVISED	
REVISIONS	76	REVISED	
REVISIONS	77	REVISED	
REVISIONS	78	REVISED	
REVISIONS	79	REVISED	
REVISIONS	80	REVISED	
REVISIONS	81	REVISED	
REVISIONS	82	REVISED	
REVISIONS	83	REVISED	
REVISIONS	84	REVISED	
REVISIONS	85	REVISED	
REVISIONS	86	REVISED	
REVISIONS	87	REVISED	
REVISIONS	88	REVISED	
REVISIONS	89	REVISED	
REVISIONS	90	REVISED	
REVISIONS	91	REVISED	
REVISIONS	92	REVISED	
REVISIONS	93	REVISED	
REVISIONS	94	REVISED	
REVISIONS	95	REVISED	
REVISIONS	96	REVISED	
REVISIONS	97	REVISED	
REVISIONS	98	REVISED	
REVISIONS	99	REVISED	
REVISIONS	100	REVISED	

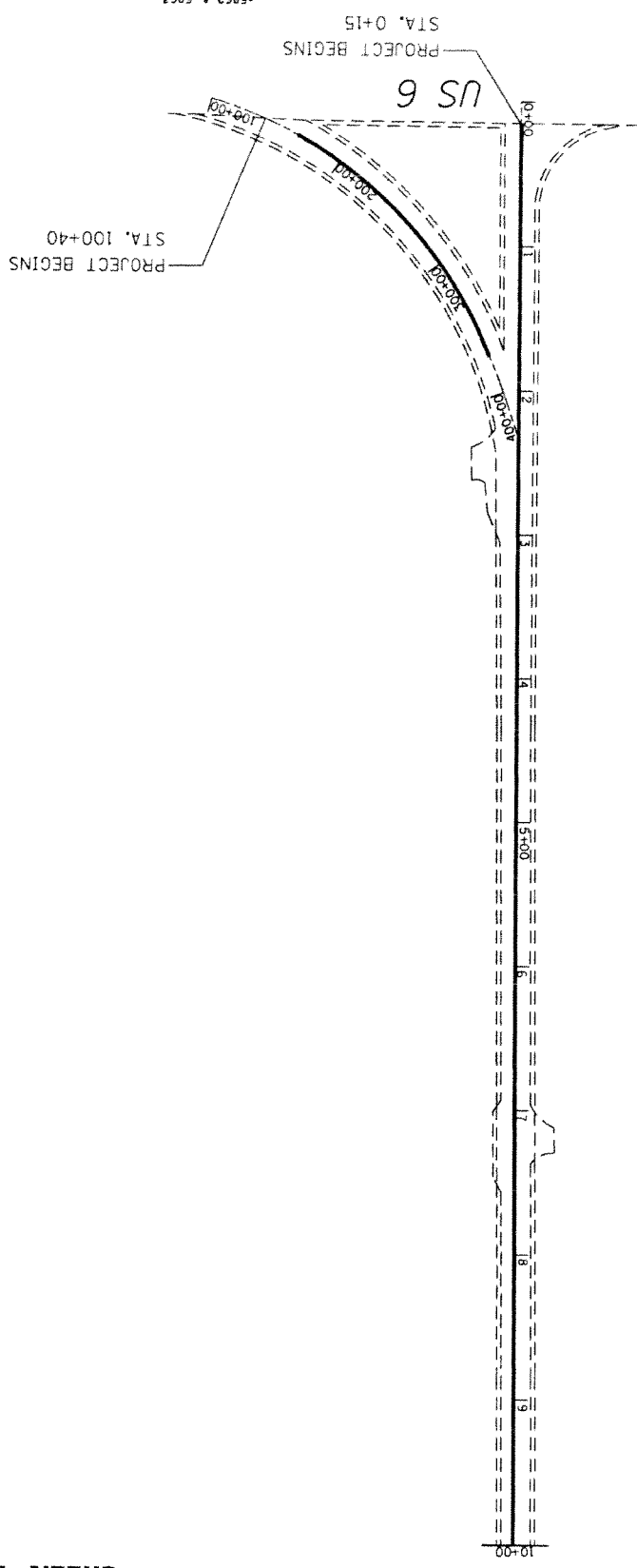

**PLAN SHEET
GREEN RIVER ROAD**



5862 & 5863

PLOT DATE = JUL-26-2018 09:44:15 AM

REVISIONS	SCALE: 3/16"=1'-0"	SHEET NO. 7	OF 7 SHEETS	STA. TO STA.	FED. ROAD DIST. NO. ILLINOIS FED. AID PROJECT
REVISIONS					CONTRACT # 64L73
REVISIONS					HENRY AD 22
REVISIONS					D2 R5 2017-2
REVISIONS					SECTION
REVISIONS					COUNTY
REVISIONS					TOTAL SHEETS

*5862 & 5863

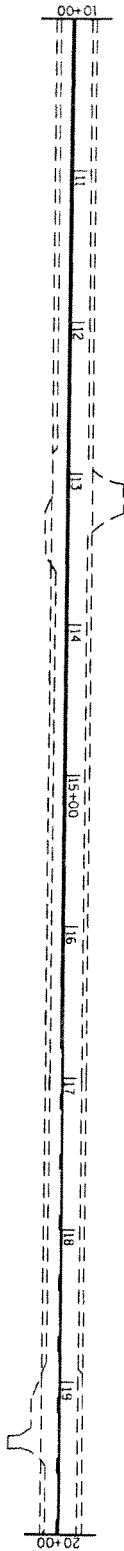

**PLAN SHEET
GREEN RIVER ROAD**

REVISION	SCALE: 1/4" = 1'-0"	SHEET NO. 7	OF 7	SHEETS	STA. TO STA.	FED. ROAD DIST. NO. ILLINOIS FED. AID PROJECT
REVISION						CONTRACT #64173
REVISION						HENRY
REVISION						02 RS 2017-2
REVISION						COUNTY
REVISION						SECTION
REVISION						F.A.U. RTE. #
REVISION						TOTAL SHEET SHEETS NO. 40 23

*5662 A 5663



HATCHED AREAS TO BE OMITTED FROM PAVING OPERATIONS ONLY.

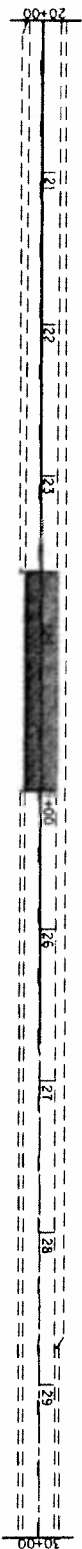

PLAN SHEET GREEN RIVER ROAD

REVISIONS	SCALE: 1/8" = 1'-0"	SHEET NO. OF SHEETS	STA. TO STA.	FED. ROAD DIST. NO.	ILLINOIS FED. AID PROJECT
REVISIONS				CONTRACT # 64L73	
REVISIONS				HENRY	
REVISIONS				02 RS 2017-2	
REVISIONS				SECTION	
REVISIONS				COUNTY	
REVISIONS				TOTAL SHEETS	24
REVISIONS				SHEETS NO.	40

5862 & 5863

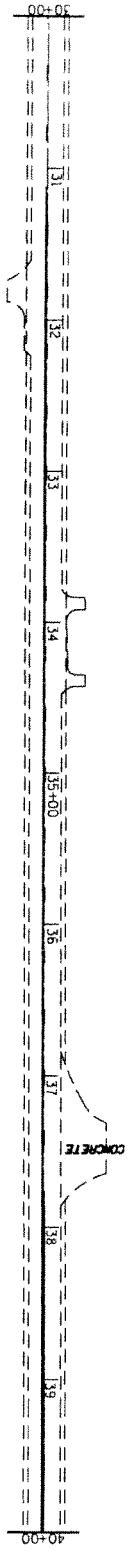

**PLAN SHEET
GREEN RIVER ROAD**

PLOT DATE * JUL-26-2018 09:44:58 AM

REVISIO	SCALE: 3/16"=1'-0"	SHEET NO. 7	OF 7 SHEETS	STA. TO STA.	FED. ROAD DIST. NO. ILLINOIS FED. AID PROJECT
REVISIO					CONTRACT # 64L73
REVISIO					HENRY COUNTY
REVISIO					D2 RS 2017-2
REVISIO					SECTION
REVISIO					F.A.U. R.T.E. *
REVISIO					COUNTY
REVISIO					40
REVISIO					25
REVISIO					TOTAL SHEET NO.

*5862 & 5863

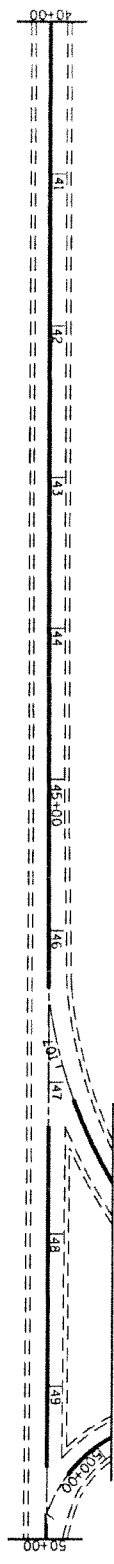

**PLAN SHEET
GREEN RIVER ROAD**



REVISED -	SCALE: 81/2"=1'	SHEET NO. OF SHEETS	STA. TO STA.	FED. ROAD DIST. NO.	ILLINOIS FED. AID PROJECT
REVISED -				CONTRACT #54173	
REVISED -				RD NO. 26	
REVISED -				SECTION	
REVISED -				COUNTY	
REVISED -				TOTAL SHEET NO.	

•5862 & 5863

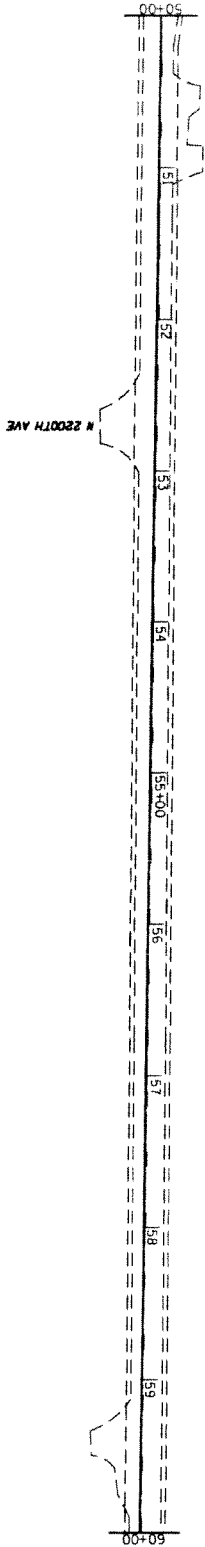

PLAN SHEET
GREEN RIVER ROAD

REVISION	SCALE: 31:298 7/16	SHEET NO. OF SHEETS	STA.	TO STA.	FED. ROAD DIST. NO. ILLINOIS FED. AID PROJECT
REVISION					CONTRACT #64LTJ
REVISION					HENRY
REVISION					SECTION
REVISION					ROUTE
					COUNTY
					TOTAL SHEETS
					40
					27

-5862 & 5863

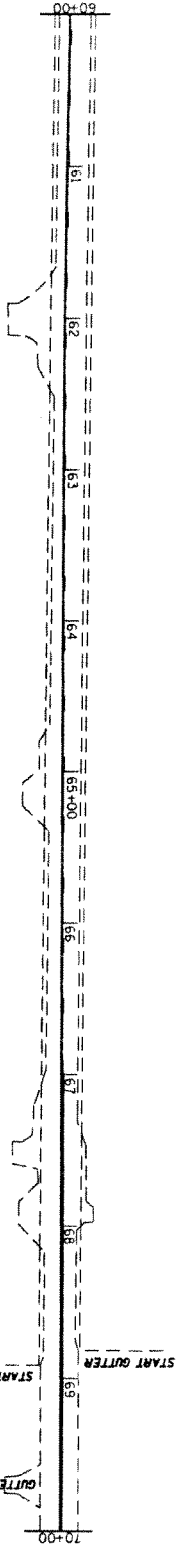

PLAN SHEET
GREEN RIVER ROAD

REVISION	SCALE: 1"=40'	SHEET NO. 7	OF 7 SHEETS	STA. TO STA.	FED. ROAD DIST. NO.	ILLINOIS FED. AID PROJECT
REVISION					DZ HS 2017-2	CONTRACT # 64L73
REVISION					SECTION	COUNTY SHEETS NO. 40
REVISION					F.A.U. RTE.	TOTAL SHEET NO. 28

•5862 & 5863

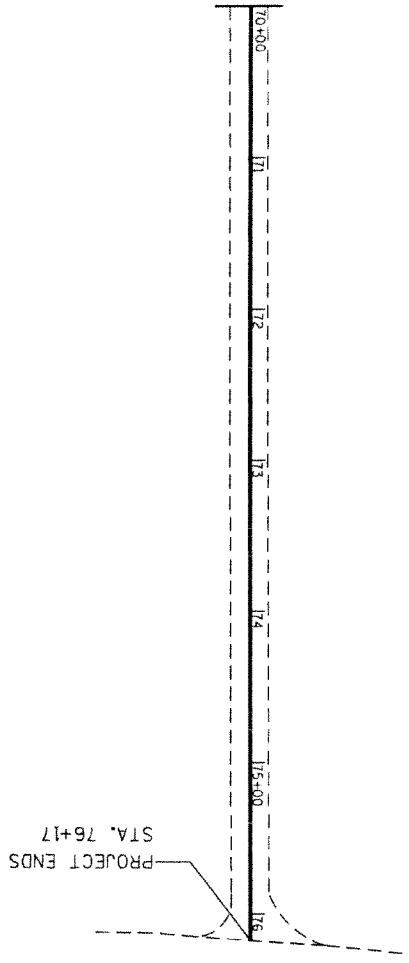

**PLAN SHEET
GREEN RIVER ROAD**

SCHEDULE OF QUANTITIES

40600990 TEMPORARY RAMP

<u>LOCATION</u>	<u>SQ YD</u>
POPPY GARDEN ROAD	
STA. 0+16 - 0+23	60
STA. 6+13 - 6+20	20
STA. 6+26 - 6+33	20
STA. 8+52 - 8+59	21
STA. 10+73 - 10+80	20
STA. 36+41 - 36+48	16
STA. 64+28 - 64+35	16
GREEN RIVER ROAD	
STA. 0+15 - 0+22	47
STA. 100+40 - 100+47	53
STA. 23+56 - 23+63	16
STA. 25+08 - 25+15	16
STA. 76+10 - 76+17	51
TOTAL	356

70300100 SHORT TERM PAVEMENT MARKING

<u>LOCATION</u>	<u>FOOT</u>	<u>REMARKS</u>
POPPY GARDEN ROAD		
STA. 0+16 - 106+92	3224	4 Applications
GREEN RIVER ROAD		
STA. 0+15 - 76+17	2984	4 Applications
TOTAL	6208	

70300150 SHORT TERM PAVEMENT MARKING REMOVAL

<u>LOCATION</u>	<u>SQ FT</u>
POPPY GARDEN ROAD	
STA. 0+16 - 106+92	269
GREEN RIVER ROAD	
STA. 0+15 - 76+17	249
TOTAL	518

SCHEDULE OF QUANTITIES

78000100 THERMOPLASTIC PAVEMENT MARKING - LETTERS AND SYMBOLS

<u>LOCATION</u>	<u>SQ.FT</u>	
POPPY GARDEN ROAD		
STA. 3+10	61.2	Railroad RR & X
STA. 7+67	<u>61.2</u>	Railroad RR & X
TOTAL	122.4	

78000650 THERMOPLASTIC PAVEMENT MARKING - LINE 24 "

<u>LOCATION</u>	<u>FOOT</u>	
POPPY GARDEN ROAD		
STA. 2+82	11	Railroad Stop Bar
STA. 3+35	11	Railroad Stop Bar
STA. 5+93	11	Railroad Stop Bar
STA. 6+47	11	Railroad Stop Bar
STA. 7+42	11	Railroad Stop Bar
STA. 7+92	<u>11</u>	Railroad Stop Bar
TOTAL	66	

78001110 PAINT PAVEMENT MARKING - LINE 4 FOOT REMARKS

<u>LOCATION</u>	<u>FOOT</u>	<u>REMARKS</u>
POPPY GARDEN ROAD		
(YELLOW) 2 Applications		
STA. 0+16 - 6+23	1518	SOLID RT / SKIP LT
STA. 6+23 - 13+72	1872	SKIP RT / SOLID LT
STA. 13+72 - 15+84	106	SKIP DASH
STA. 15+84 - 22+70	1716	SOLID RT / SKIP LT
STA. 22+70 - 25+25	1020	DOUBLE YELLOW
STA. 25+25 - 35+00	2438	SKIP RT / SOLID LT
STA. 35+00 - 40+34	268	SKIP DASH
STA. 40+34 - 50+26	2480	SOLID RT / SKIP LT
STA. 50+26 - 54+37	1644	DOUBLE YELLOW
STA. 54+37 - 63+78	2352	SKIP RT / SOLID LT
STA. 63+78 - 65+78	100	SKIP DASH
STA. 65+78 - 76+19	2602	SOLID RT / SKIP LT
STA. 76+19 - 85+04	3540	DOUBLE YELLOW
STA. 85+04 - 92+75	1928	SKIP RT / SOLID LT
STA. 92+75 - 102+63	2470	SOLID RT / SKIP LT
STA. 102+63 - 106+92	1716	DOUBLE YELLOW
STA. 200+00 - 500+80	1520	DOUBLE YELLOW
SUB TOTAL (YELLOW)	<u>29290</u>	

SCHEDULE OF QUANTITIES

PAINT CONTINUED:

<u>LOCATION</u>	<u>FOOT</u>	<u>REMARKS</u>
POPPY GARDEN ROAD		
(WHITE) 2 Applications		
STA. 0+16 - 106+92	42704	EDGE LINE LT & RT
STA. 200+00 - 500+80	1520	EDGE LINE LT & RT
SUB TOTAL (WHITE)	44224	
SUB TOTAL (YELLOW AND WHITE)	73514	
POPPY GARDEN ROAD		

LOCATION

GREEN RIVER ROAD

(YELLOW) 2 Applications		
STA. 0+15 - 16+80	6660	DOUBLE YELLOW
STA. 100+40 - 400+00	1040	DOUBLE YELLOW
STA. 16+80 - 26+75	2488	SKIP RT / SOLID LT
STA. 26+75 - 31+22	224	SKIP DASH
STA. 31+22 - 37+85	1658	SOLID RT / SKIP LT
STA. 37+85 - 49+83	4792	DOUBLE YELLOW
STA. 49+83 - 67+00	4294	SOLID RT / SKIP LT
STA. 67+00 - 76+17	3668	DOUBLE YELLOW
SUB TOTAL (YELLOW)	24824	

<u>LOCATION</u>	<u>FOOT</u>	<u>REMARKS</u>
GREEN RIVER ROAD		
(WHITE) 2 Applications		
STA. 0+15 - 76+17	30408	EDGE LINE LT & RT
STA. 100+40 - 400+00	1040	EDGE LINE LT & RT
SUB TOTAL (WHITE)	31448	
SUB TOTAL (YELLOW AND WHITE)	56272	
GREEN RIVER ROAD		
PAINT GRAND TOTAL	129786	

FAU 5862 (POPPY GARDEN ROAD)
 FAU 5863 (GREEN RIVER ROAD)
 SECTION D2 RS 2017-2
 HENRY COUNTY
 CONTRACT #64L73
 SHEET 32 OF 40

HOT-MIXED ASPHALT SCHEDULE

STATIONING	REMARKS	LENGTH	PROPOSED SURFACE		BIT MATS PRIME COAT POUND	HOT MIX ASPHALT MIX "C" N50 TON	AGG WEDGE SHLDS TYPE B TON	HMA SURF REMOVAL 2 INCH SQ. YD.	LEVEL BINDER IL9.5FG, N50 MACHINE METH TON
			WIDTH	SQ YD					
MAINLINE									
POPPY GARDEN ROAD									
0+16 - 6+20		604	VAR	1838	1241	129		1838	
6+26 - 8+59		233	VAR	761	514	53		761	103
10+73 - 36+48		2575	VAR	6431	4341	450		6431	43
64+28 - 106+92		4264	VAR	11236	7584	787		11236	360
0+16 - 106+92	PLUS 3% SAFETY EDGE LT & RT					43			629
GREEN RIVER ROAD							939		34
0+15 - 23+63		2348	VAR	6423	4336	450		6423	360
25+08 - 76+17		5109	VAR	13299.00	8977.00	931		13299	745
0+15 - 76+17	PLUS 3% SAFETY EDGE LT & RT					42			33
				39988	26993	2884		39988	2306
TOTAL				39988	26993	2884	1587	39988	2306

POPPY GARDEN ROAD QUANTITIES FOR 64+28 - 106+92 INCLUDE STATION 200+00 - 500+80. SHOULDERS CARRIED THROUGH ENTIRE LENGTH
 GREEN RIVER ROAD QUANTITIES FOR 0+15 - 23+63 INCLUDE STATION 100+40 - 400+00. SHOULDERS CARRIED THROUGH ENTIRE LENGTH

SAFETY EDGE (3P PROJECTS)

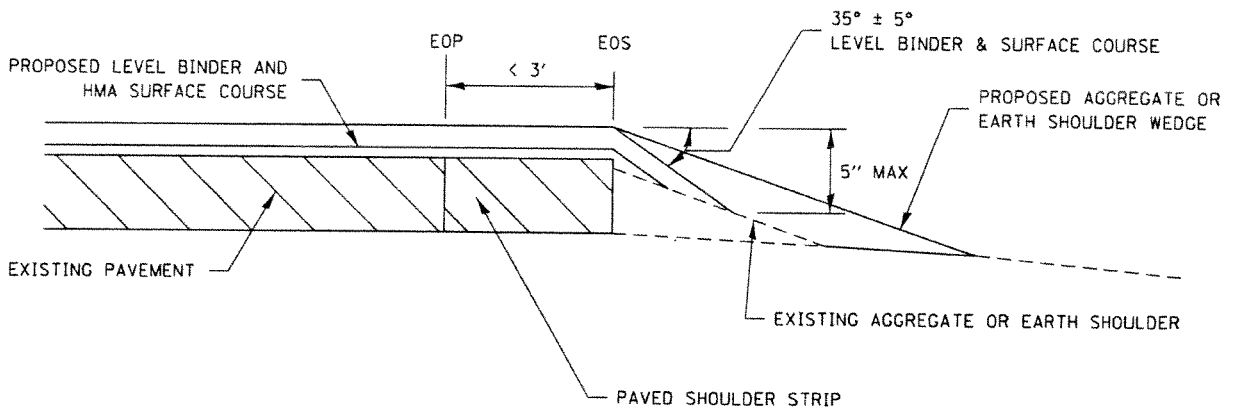

NO MILLING: ADJACENT SHOULDER FLUSH WITH OR LOWER THAN EXISTING PAVEMENT

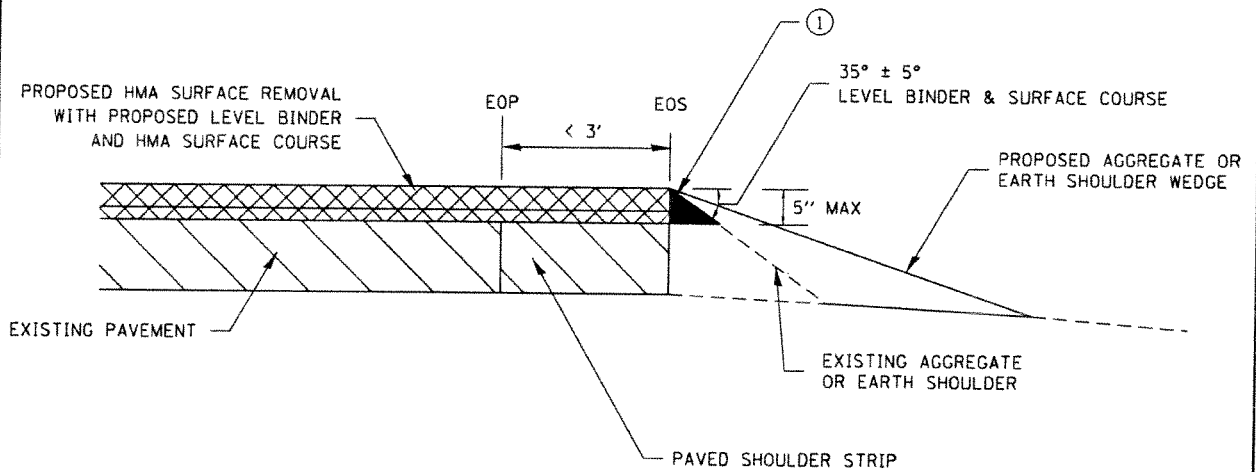

MILLING: WITH ADJACENT SHOULDER FLUSH WITH OR HIGHER THAN MILLED SURFACE

NOTES : THE DEVICE WHICH FORMS THE SAFETY EDGE SHALL BE MOUNTED ON THE PAVER SCREED AGAINST THE END GATE AND SHALL BE REMOVABLE OR BE ABLE TO BE LIFTED WHEN NOT IN USE. THE DEVICE SHALL BE DESIGNED TO MAINTAIN CONTACT WITH SURFACE OF THE SHOULDER AND ALLOW AUTOMATIC TRANSITION TO CROSS ROADS, DRIVEWAYS AND OBSTRUCTIONS. THE DEVICE SHALL ALSO CONSTRAIN THE HMA MATERIAL AND INCREASE THE CONSOLIDATION OF THE EXTRUDED PROFILE. THE USE OF A CONVENTIONAL SINGLE PLATE STRIKE-OFF WILL NOT BE ALLOWED.

① PRIOR TO THE PLACEMENT OF THE HMA SAFETY EDGE, IF THE ADJACENT AGGREGATE OR EARTH SHOULDER IS HIGHER THAN THE MILLED SURFACE, THE AREA REQUIRED FOR PLACEMENT OF THE SAFETY EDGE SHALL BE BROUGHT FLUSH WITH THE MILLED SURFACE IN A MANNER APPROVED BY THE ENGINEER. THIS WORK SHALL BE CONSIDERED INCLUDED IN THE CONTRACT UNIT PRICE PER TON FOR HOT-MIX ASPHALT SURFACE COURSE OF THE TYPE SPECIFIED.

ROLLERS WILL NOT BE ALLOWED ON THE SLOPED FACE OF THE SAFETY EDGE.

*5862 & 5863

REVISED - 1-05-16	REGION 2 / DISTRICT 2 STANDARD	F.A.U. RTE.	SECTION	COUNTY	TOTAL SHEETS	SHEET NO.
REVISED - 10-11-13		*	02 RS 2017-2	HENRY	40	33
REVISED -		CONTRACT NO. 64L73				
REVISED -		FED. ROAD DIST. NO. ILLINOIS FED. AID PROJECT				
SCALE: 1/8" = 1'-0"		SHEET NO. OF SHEETS		STA. TO STA.		

WORK ZONE SIGN DETAILS

ILLINOIS STANDARD G20-1100

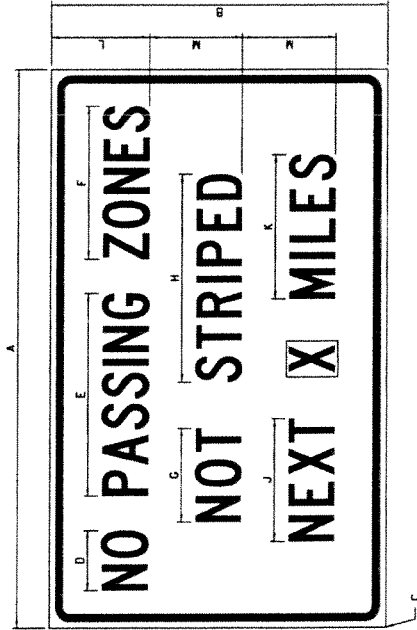

COLOR LEGEND AND BORDER BACKGROUND BLACK ORANGE NON-REFLECTORIZED REFLECTORIZED

SIGN SIZE	DIMENSIONS											
	A	B	C	D	E	F	G	H	J	K	L	M
60 x 36	60.00	36.00	2.25	6.4	21.80	16.40	10.00	22.40	13.20	15.50	10.50	10.00

SIGN SIZE	SERIES BY LINE			MARGIN	BORDER
	1	2	3		
60 x 36	5C	5C	5C	0.625	0.875

Sign not to scale

GENERAL NOTES

- All work to furnish and install these signs shall be included in the cost of the specified traffic control standards and shall not be paid separately.
- All Illinois Standard signs shall conform to the latest edition of the "Illinois Standard Highway Signs Book" in effect on the date of invitation for bids.
- Signs shall meet the applicable portions of Sections 701 and 720 of the Standard Specifications.
- All dimensions are in inches unless otherwise noted.

ILLINOIS STANDARD W9-1107

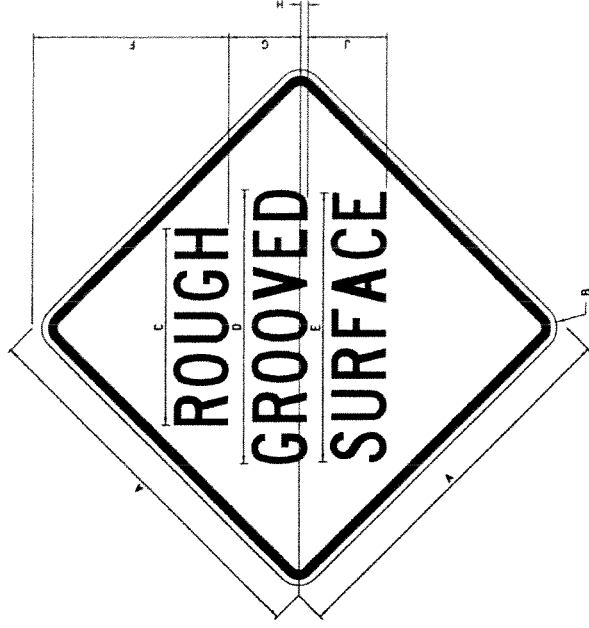

COLOR LEGEND AND BORDER BACKGROUND BLACK ORANGE NON-REFLECTORIZED REFLECTORIZED

SIGN SIZE	DIMENSIONS									
	A	B	C	D	E	F	G	H	J	
48 x 48	48.00	3.00	25.00	34.80	34.20	24.94	9.00	1.00	10.00	

SIGN SIZE	SERIES BY LINE			MARGIN	BORDER
	1	2	3		
48 x 48	7C	7C	7C	1.250	0.750

Sign not to scale

FILE NO. 1	DESIGNED	REVISION	3-10-15
DATE	DRAWN	REVISION	
PROJECT NO. 17	CHECKED	REVISION	
PROJECT NAME	DATE	REVISION	
STATE OF ILLINOIS		DEPARTMENT OF TRANSPORTATION	
REGION 2 / DISTRICT 2 STANDARD		SHEET NO. 4 OF 4	
SCALE: 1" = 12"		SHEETS 1 OF 4	
COUNTY		SECTION	
TOWNSHIP		RANGE	
CONTRACT NO. 6-4-13		SHEET NO. 4 OF 4	

WORK ZONE SIGN DETAILS SHEET 1 OF 4 34.1

WORK ZONE SIGN DETAILS

ILLINOIS STANDARD W12-1102

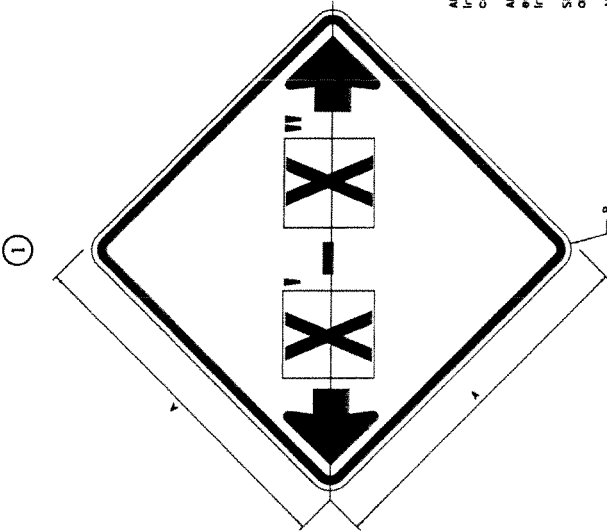

COLOR LEGEND AND BORDER
 BACKGROUND BLACK FL ORANGE NON-REFLECTORIZED REFLECTORIZED

SIGN SIZE	DIMENSIONS	
	A	B
48 x 48	48.00	3.00

SIGN SIZE	SERIES BY LINE		MARGIN	BORDER
	1	12C		
48 x 48			0.750	1.250

Sign not to scale

USER NAME: jacob@state.gov	DESIGNED: 3/25/18	REVISED: 3/25/18
DATE: 3/25/18	DRAWN: jacob	REVISED: 3/25/18
PLOT SCALE: 1/8" = 1'-0"	CHECKED: jacob	REVISED: 3/25/18
PLOT DATE: JUNE 2018	DATE: 3/25/18	REVISED: 3/25/18

ILLINOIS STANDARD W12-1103

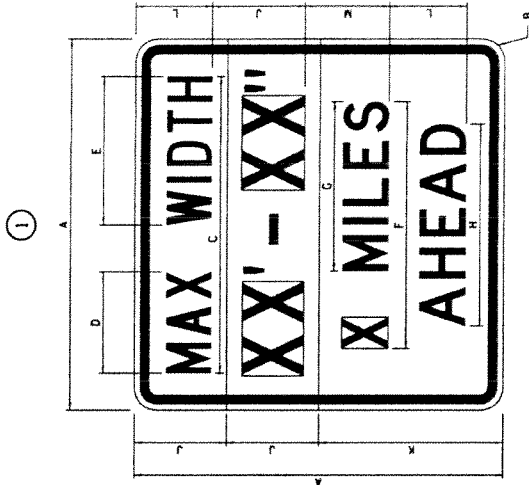

COLOR LEGEND AND BORDER
 BACKGROUND BLACK FL ORANGE NON-REFLECTORIZED REFLECTORIZED

SIGN SIZE	DIMENSIONS												
	A	B	C	D	E	F	G	H	J	K	L	M	
48 x 48	48.00	3.00	38.40	13.20	19.20	32.00	22.00	26.20	12.00	24.00	10.00	11.00	

SIGN SIZE	SERIES BY LINE				MARGIN	BORDER
	1	2	3	4		
48 x 48	6C	80	60	60	0.750	1.250

Sign not to scale

FILE NAME: W12-1103.dwg	DESIGNED: 3/25/18	REVISED: 3/25/18
DATE: 3/25/18	DRAWN: jacob	REVISED: 3/25/18
PLOT SCALE: 1/8" = 1'-0"	CHECKED: jacob	REVISED: 3/25/18
PLOT DATE: JUNE 2018	DATE: 3/25/18	REVISED: 3/25/18

GENERAL NOTES
 All work to furnish and install these signs shall be included in the cost of the specified traffic control standards and shall not be paid separately. All Illinois Standard signs shall conform to the latest edition of the "Illinois Standard Highway Signs Book" in effect on the date of invitation for bids. Signs shall meet the applicable portions of Sections 701 and 720 of the Standard Specifications. All dimensions are in inches unless otherwise noted.

(1) Illinois Standard signs W12-1102 and W12-1103 shall be used as described in the special provisions.

Sign not to scale
 TOP AND BOTTOM OF BACKGROUND WHITE. #5862 A 5863

STATE OF ILLINOIS DEPARTMENT OF TRANSPORTATION	REGION 2 / DISTRICT 2 STANDARD	COUNTY: HENRY
SCALE: 1/8" = 1'-0"	SHEET NO. OF SHEETS: 51A TO 51A	CONTRACT NO. 64R13

WORK ZONE SIGN DETAILS

STOP LINE SIGN FOR TEMPORARY SIGNALS

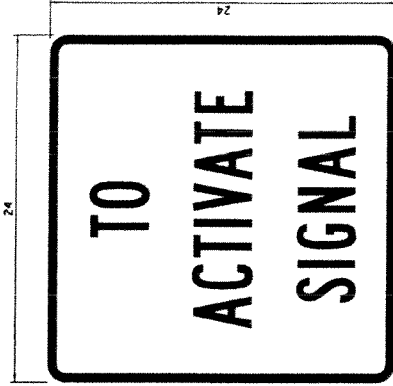

COLOR LEGEND AND BORDER BACKGROUND BLACK WHITE
 NON-REFLECTORIZED REFLECTORIZED

SIGN SIZE	SERIES BY LINE		
24 X 24	4C	4C	4C
	1	2	3

Sign not to scale

GENERAL NOTES

All work to furnish and install these signs shall be included in the cost of the specified traffic control standards and shall not be paid separately.

All Illinois Standard signs shall conform to the latest edition of the "Illinois Standard Highway Signs Book" in effect on the date of invitation for bids.

Signs shall meet the applicable portions of Sections 701 and 720 of the Standard Specifications.

All dimensions are in inches unless otherwise noted.

ROAD CLOSED TO OVERSIZED LOADS

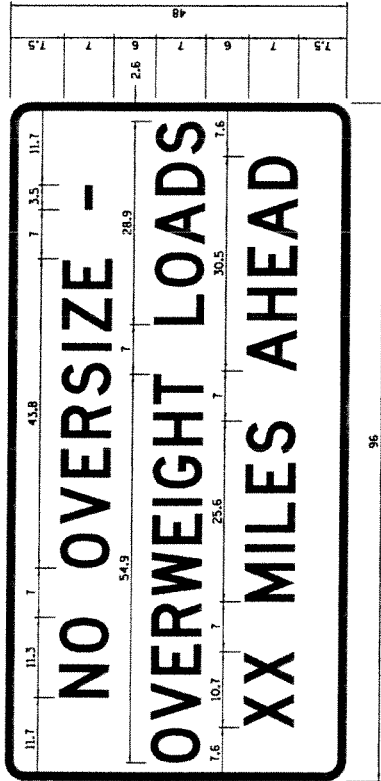

COLOR LEGEND AND BORDER BACKGROUND BLACK ORANGE
 NON-REFLECTORIZED REFLECTORIZED

Permit Loads - Loads Over 13 Feet, 3.0" Radius, 1.3" Border;
 END OVERSIZE - 1) DOWNGRADE LOADS TO 65% SPACING (XX) MILES AHEAD D;
 Table of letter and object heights.

N	O	O	V	E	R	S	I	Z	E	-
11.7	18.1	30.0	36.2	42.8	48.4	54.4	60.7	63.5	69.5	80.8

O	V	E	R	W	E	I	G	H	T	L	O	A	D	S
2.6	8.6	15.0	20.4	26.2	33.4	38.8	41.3	47.4	53.2	64.5	69.9	75.9	82.9	88.7

X	X	M	I	L	E	S	A	H	E	A	D
7.6	13.6	25.3	32.3	35.1	40.6	46.2	57.9	55.1	71.4	76.6	83.7

Sign not to scale

FILE NAME: 11/20/2017 10:00 AM	DESIGNED: 11/20/2017 10:00 AM	REVISED: 11/20/2017 10:00 AM	PROJECT: 5862 & 5863
DRAWN: 11/20/2017 10:00 AM	CHECKED: 11/20/2017 10:00 AM	REVISED: 11/20/2017 10:00 AM	SHEET NO. OF SHEETS: 3 OF 4
DATE: 11/20/2017 10:00 AM			
STATE OF ILLINOIS DEPARTMENT OF TRANSPORTATION		REGION 2 / DISTRICT 2 STANDARD	
SCALE: 1" = 12"		CONTRACT NO. 58.13	

TYPICAL PAVEMENT MARKINGS

MEDIAN PAVEMENT MARKING

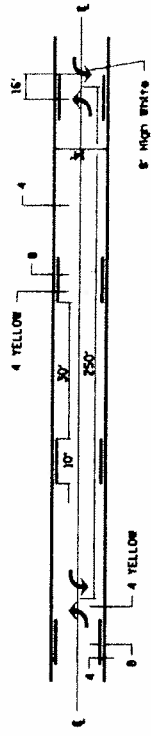

TYPICAL PAVEMENT MARKING FOR FLUSH MEDIAN AT LEFT TURN LANE

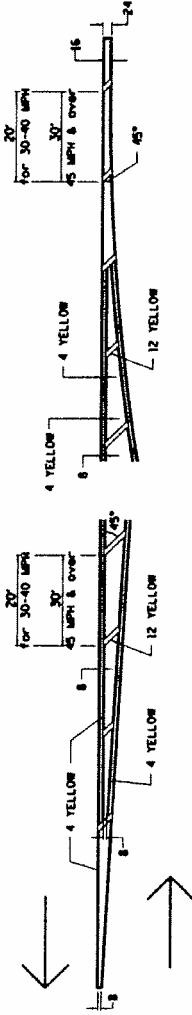

TYPICAL ISLAND OFFSET SHOULDER WIDTH

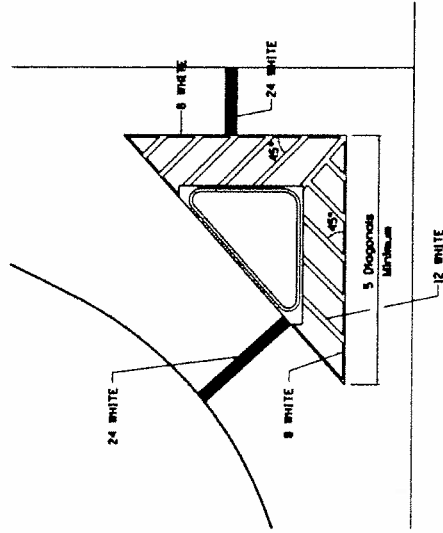

TYPICAL MARKING FOR PAINTED ISLANDS

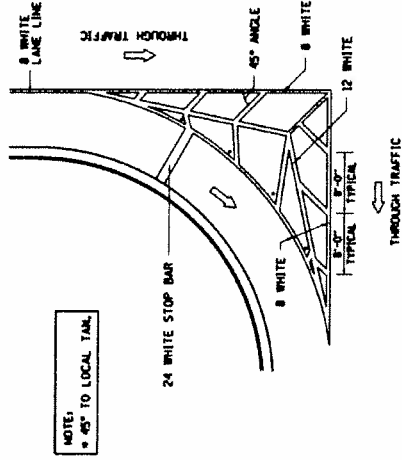

STANDARD CROSSWALK MARKING

See Schedule for Locations

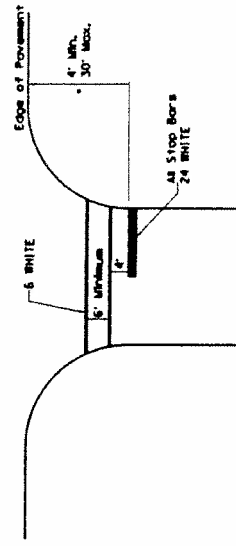

* Distance to the nearest edge of the intersecting roadway in the absence of a marked crosswalk.

** ALL DIMENSIONS ARE IN INCHES UNLESS OTHERWISE NOTED.

FILE NAME	DESIGNED	DATE	REVISIONS	SCALE	SHEET NO.	TOTAL SHEETS	PROJECT	CONTRACT	NO.	DATE
DESIGNED BY: [Name]	DESIGNED	12-14	REVISIONS	AS SHOWN	1	1	REGION 2 / DISTRICT 2 STANDARD	10/11/12	10/11/12	10/11/12
DESIGNED BY: [Name]	DESIGNED	5-12-12	REVISIONS	AS SHOWN	1	1	REGION 2 / DISTRICT 2 STANDARD	10/11/12	10/11/12	10/11/12
DESIGNED BY: [Name]	DESIGNED	5-12-12	REVISIONS	AS SHOWN	1	1	REGION 2 / DISTRICT 2 STANDARD	10/11/12	10/11/12	10/11/12
DESIGNED BY: [Name]	DESIGNED	5-12-12	REVISIONS	AS SHOWN	1	1	REGION 2 / DISTRICT 2 STANDARD	10/11/12	10/11/12	10/11/12

TYPICAL PAVEMENT MARKINGS

ARROW LAYOUT

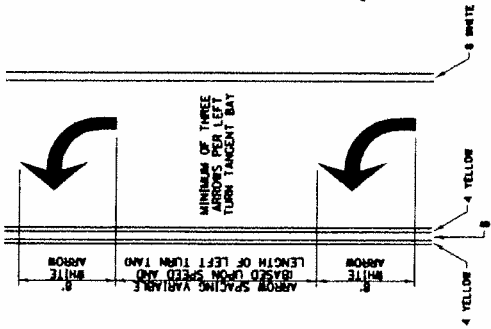

- ◀ ONE-BAY AMBER MARKER
- ◁ ONE-BAY CRYSTAL MARKER
- ◊ TANGENT TANGENT BAY AMBER MARKER

ALL DIMENSIONS ARE IN INCHES UNLESS OTHERWISE NOTED.

TYPICAL PAVEMENT MARKING FOR FLUSH MEDIAN

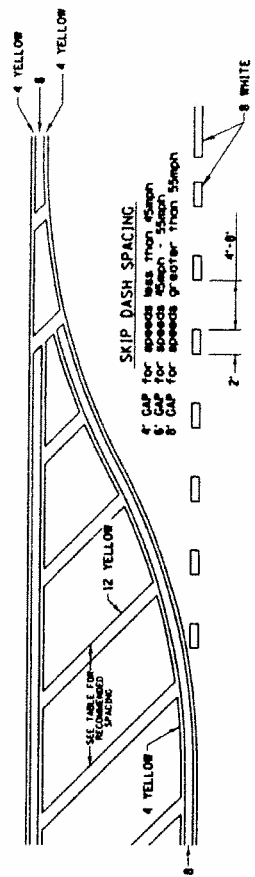

RECOMMENDED SPACING BETWEEN DIAGONALS (IN FEET)

Speed Limit Range	Continuous Median Area	Intersection Channelization	Objects (UMBACDA)
less than 30MPH	50'	15'	10'
30-40MPH	75'	20'	15'
45MPH & over	75'	30'	20'

NOTE: If the spacing recommended in the Table does not permit at least five diagonal lines in the area being marked, the spacing between the next lowest speed range should be used. The recommended spacing is measured parallel to the pavement center line.

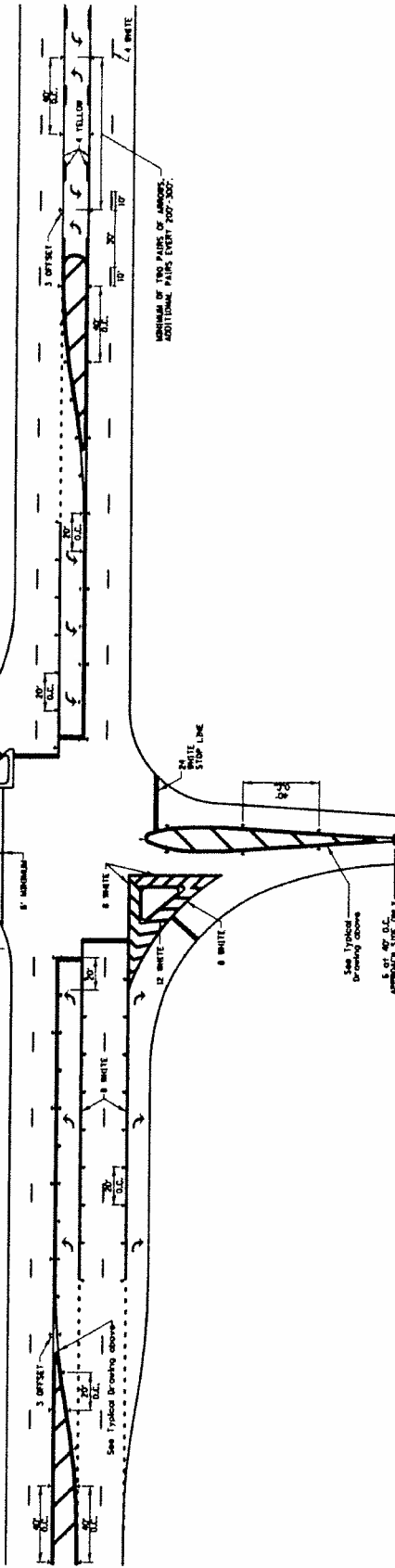

5862 & 5863

REGION 2 / DISTRICT 2 STANDARD

STATE OF ILLINOIS DEPARTMENT OF TRANSPORTATION

SCALE: SHEET NO. OF SHEETS TOTAL TO BE

CONTRACT NO. SA 13

DATE: 8-27-14

DATE: 3-8-12

DATE:

DATE:

TYPICAL PAVEMENT MARKINGS

TYPICAL PARKING SPACING

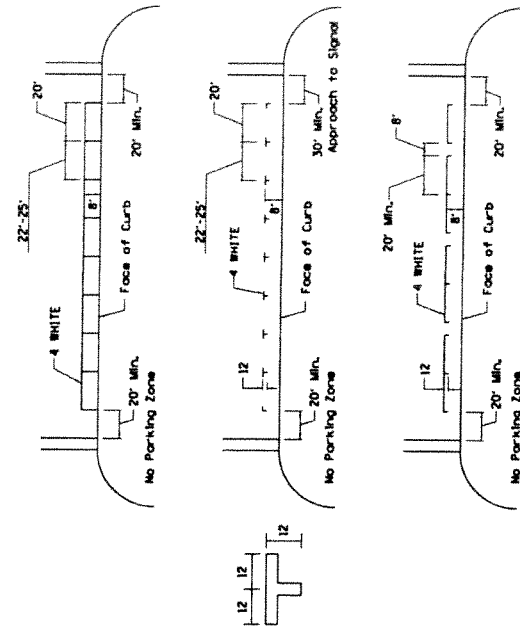

TYPICAL PAVEMENT MARKING FOR TWO LANE SECTION - NO PASSING ZONES

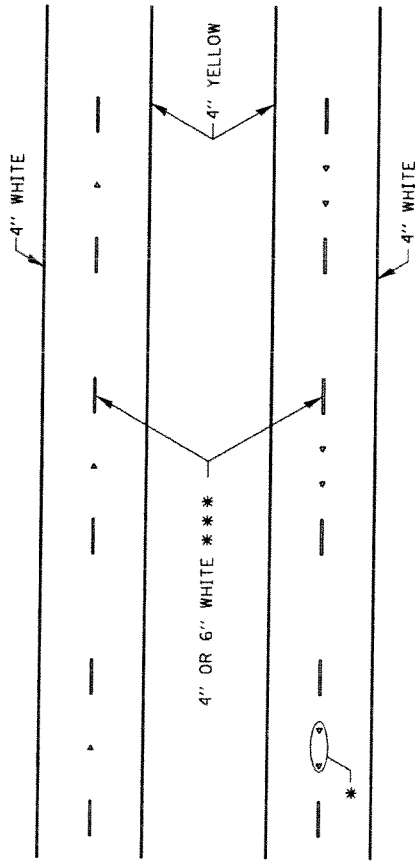
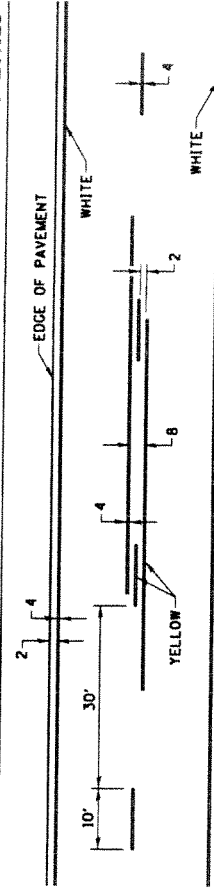

* SEE HIGHWAY STANDARD 781001 FOR SPACING DETAILS. USE DOUBLE MARKERS WHEN ADT > 20,000.

MULTI-LANE / DIVIDED

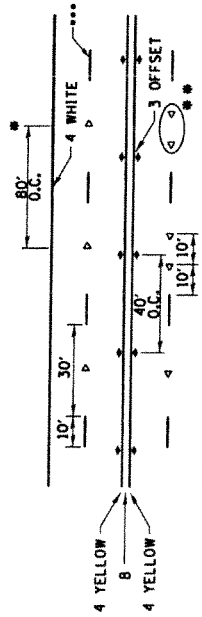

- * REDUCE TO 40' O.C. ON CURVES WHERE ADVISORY SPEEDS ARE 10 MPH LOWER THAN POSTED SPEEDS.
- ** USE DOUBLE MARKERS WHEN ADT > 20,000
- *** CENTERLINE SKIP DASH PAVEMENT MARKING SPEED LIMIT LESS THAN 40 MPH USE 4" LINE. SPEED LIMIT 40 MPH AND OVER USE 6" LINE.

MULTI-LANE / UNDIVIDED & ONE WAY

(FOR MULTI-LANE UNDIVIDED HIGHWAYS USE THIS DETAIL NOT HIGHWAY STANDARD 781001)

SYMBOLS

FILE NO. 1	DESIGNED - 8-27-14	REVISION - 8-27-14	TOTAL SHEETS 4
OWNER - ILLINOIS DEPARTMENT OF TRANSPORTATION	CHECKED - 11-28-12	REVISION - 11-28-12	SHEET NO. 3
PROJECT NO. 11-12-2005 BROADWAY	DATE	REVISION	CONTRACT NO. 6A.13
SCALE: 1" = 40'		SHEETS 1 STA. TO STA.	
REGION 2 / DISTRICT 2 STANDARD		SECTION	
STATE OF ILLINOIS DEPARTMENT OF TRANSPORTATION		COUNTY	
+5862 & 5863		SHEET NO. 3	
TYPICAL PAVEMENT MARKINGS		SHEET 3 OF 3	

REVISIONS TO THE ILLINOIS PREVAILING WAGE RATES

The Prevailing rates of wages are included in the Contract proposals which are subject to Check Sheet #5 of the Supplemental Specifications and Recurring Special Provisions. The rates have been ascertained and certified by the Illinois Department of Labor for the locality in which the work is to be performed and for each craft or type of work or mechanic needed to execute the work of the Contract. As required by Prevailing Wage Act (820 ILCS 130/0.01, et seq.) and Check Sheet #5 of the Contract, not less than the rates of wages ascertained by the Illinois Department of Labor and as revised during the performance of a Contract shall be paid to all laborers, workers and mechanics performing work under the Contract. Post the scale of wages in a prominent and easily accessible place at the site of work.

If the Illinois Department of Labor revises the prevailing rates of wages to be paid as listed in the specification of rates, the contractor shall post the revised rates of wages and shall pay not less than the revised rates of wages. Current wage rate information shall be obtained by visiting the Illinois Department of Labor web site at <http://www.state.il.us/agency/idol/> or by calling 312-793-2814. It is the responsibility of the contractor to review the rates applicable to the work of the contract at regular intervals in order to insure the timely payment of current rates. Provision of this information to the contractor by means of the Illinois Department of Labor web site satisfies the notification of revisions by the Department to the contractor pursuant to the Act, and the contractor agrees that no additional notice is required. The contractor shall notify each of its subcontractors of the revised rates of wages.