

STATE OF ILLINOIS  
DEPARTMENT OF TRANSPORTATION

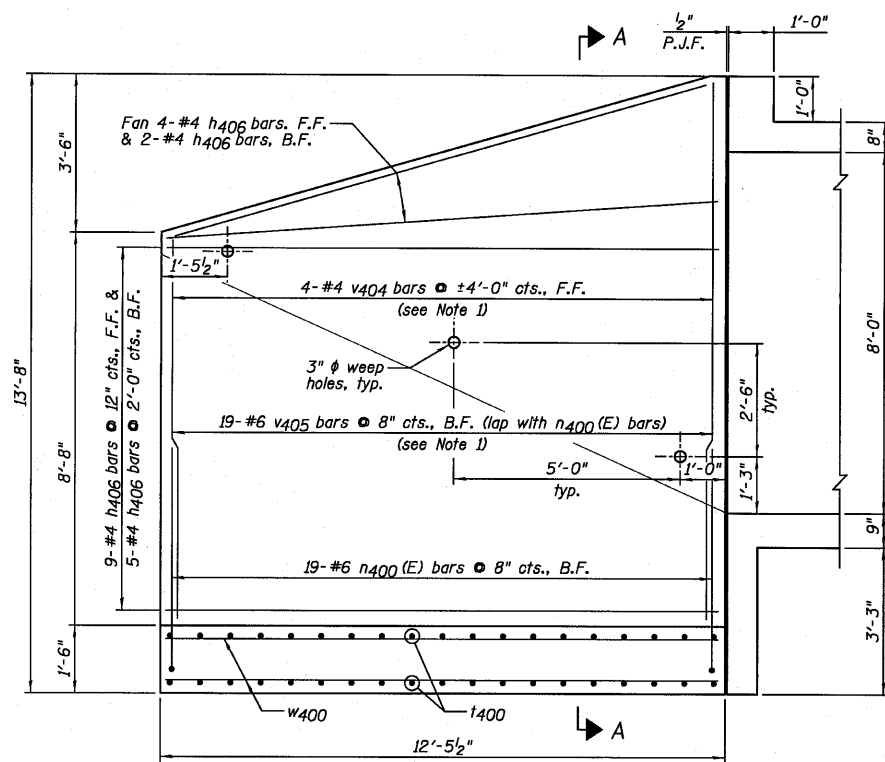

NORTH END WINGWALL ELEVATION

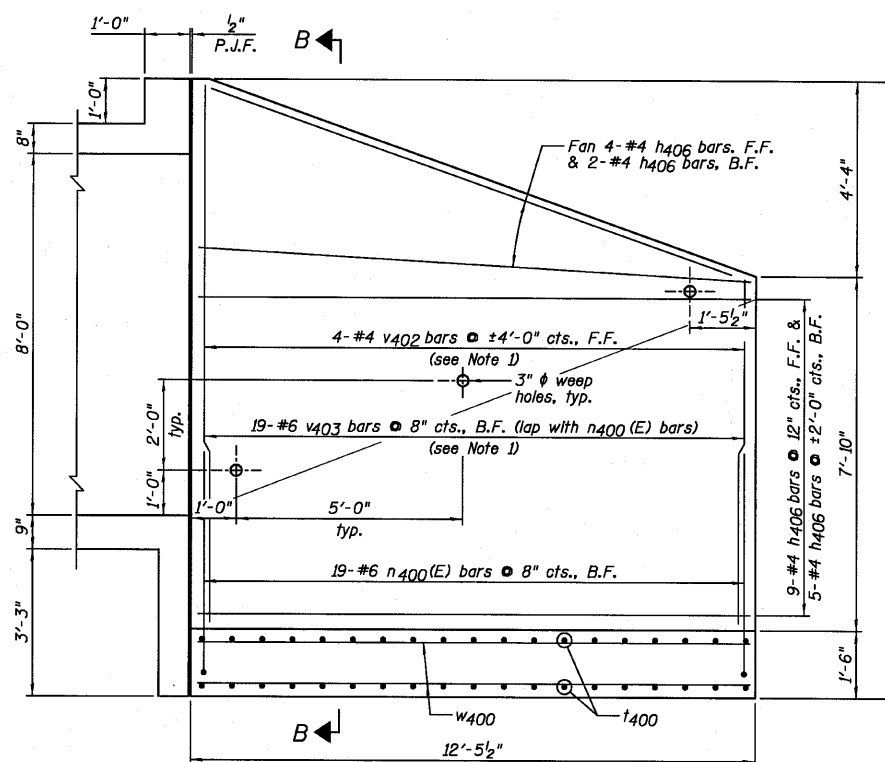

SOUTH END WINGWALL ELEVATION

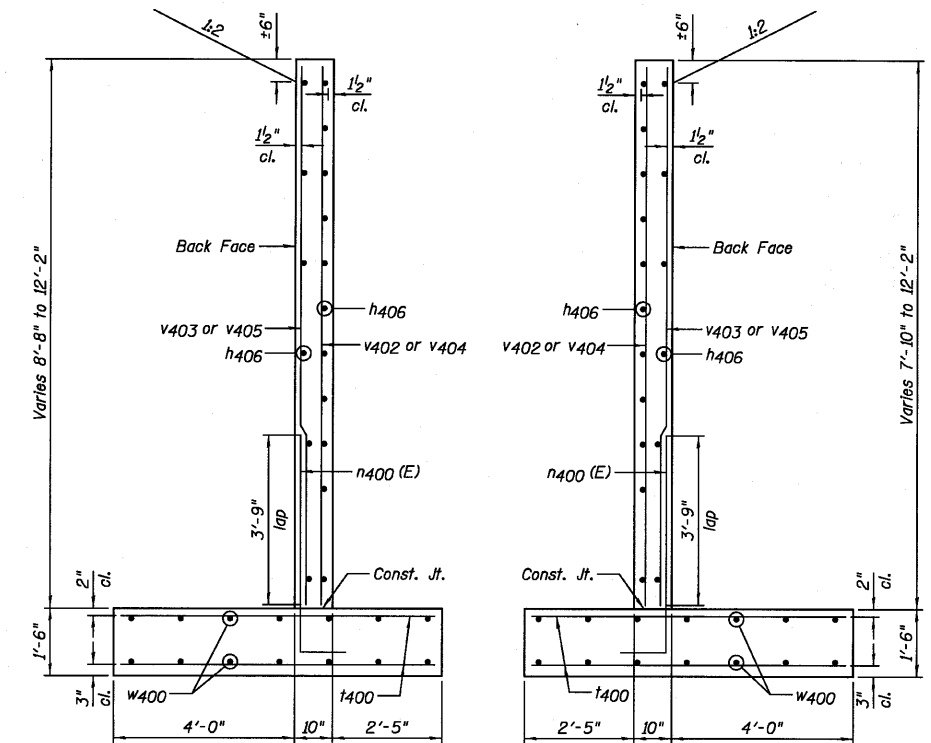

SECTION A-A  
(Calc. Max Soil Pressure = 2840 psf)

SECTION B-B  
(Calc. Max Soil Pressure = 2840 psf)

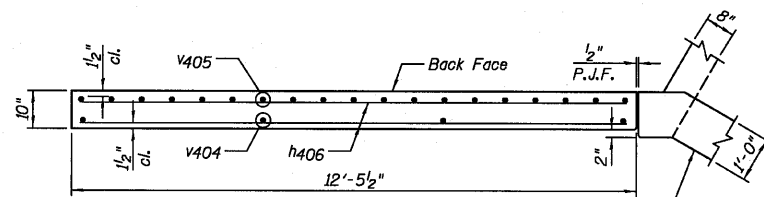

UPPER WINGWALL PLAN

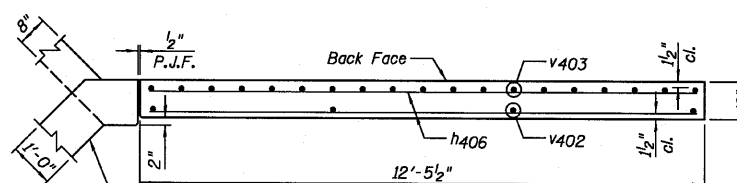

UPPER WINGWALL PLAN

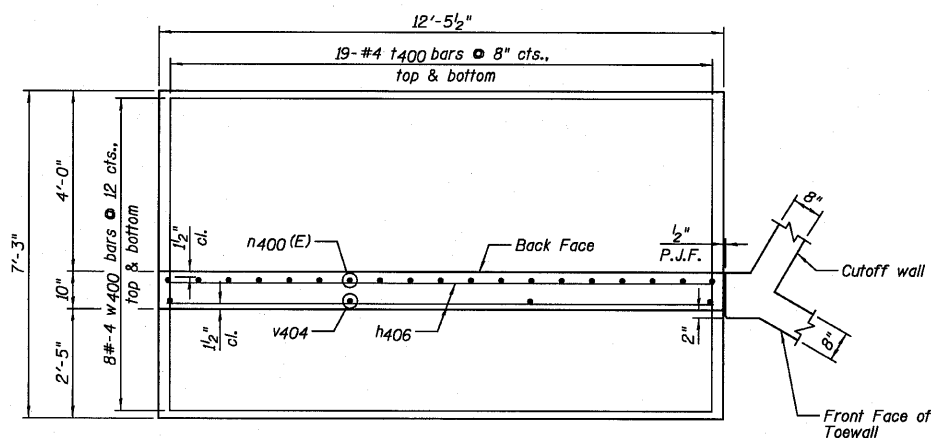

LOWER WINGWALL PLAN

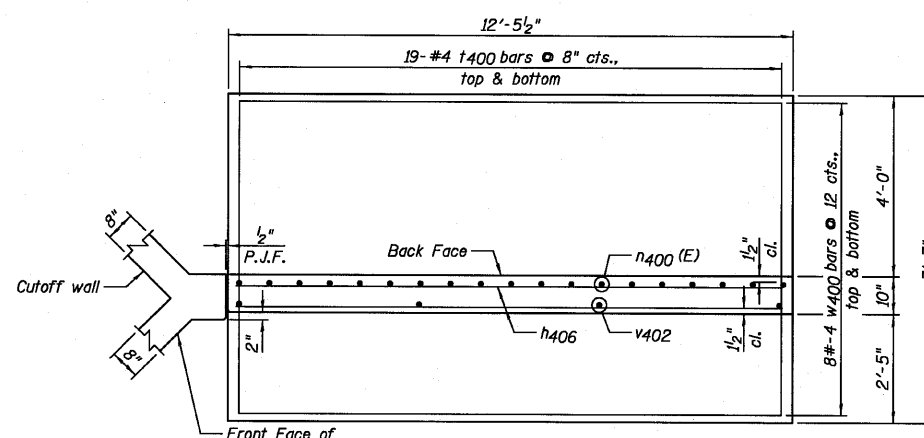

LOWER WINGWALL PLAN

NOTES:

- 1.) Order v402, v403, v404 and v405 bars full length, cut according to Bar Cutting Diagram on Sheet F3. Use remainder of bars in opposite wingwall.
- 2.) For Bill of Material, see Sheet F3.
- 3.) F.F. denotes Front Face and B.F. denotes Back Face.

DESIGNED	SDH
CHECKED	JML
DRAWN	JWK/DJM
CHECKED	MSW

DATE 08/04/10

WINGWALLS  
STRUCTURE NO. 038-2549

<b>Farnsworth</b> GROUP, INC. 2709 McGraw Drive Bloomington, Illinois 61704 309/663-8435, 309/663-1571 fax	SHEET NO. F8	F.A.P. RTE.	SECTION	COUNTY	TOTAL SHEETS	SHEET NO.
	10 SHEETS	681	*	FORD/IROQUOIS	146	111
		FED. ROAD DIST. NO.		ILLINOIS		FED. AID PROJECT
				CONTRACT NO. 66880		