

STATE OF ILLINOIS
DEPARTMENT OF TRANSPORTATION

Notes:
Existing horizontal and vertical reinforcement extending into new construction shall be cleaned, straightened, and incorporated into the new construction. Cost included with Concrete Removal.
Existing reinforcement not extending into new construction shall be cut off and covered with a 2" layer of cement grout. Cost shall be included with the cost of Concrete Removal.
Cost of 1" PJF is included with Concrete Structures.
Cost of 2" cement grout is included with Concrete Removal.

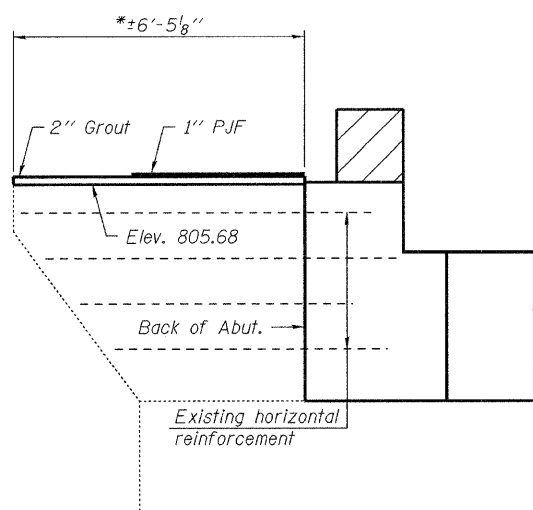

**EAST WINGWALL
ELEVATION**

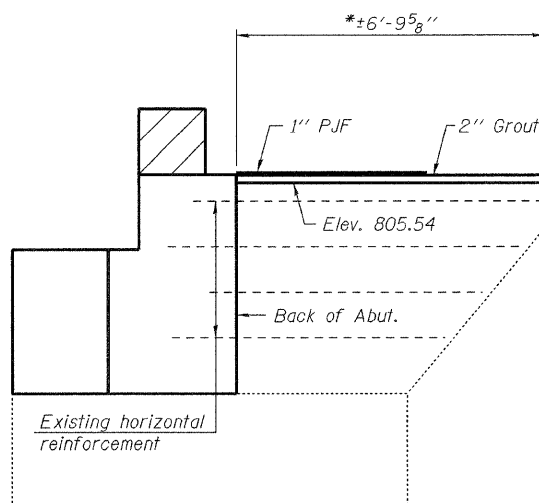

**WEST WINGWALL
ELEVATION**

* Measured along outside face of wingwall.

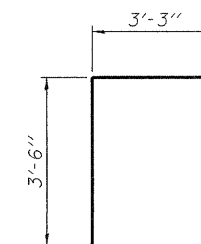

BAR s(E)

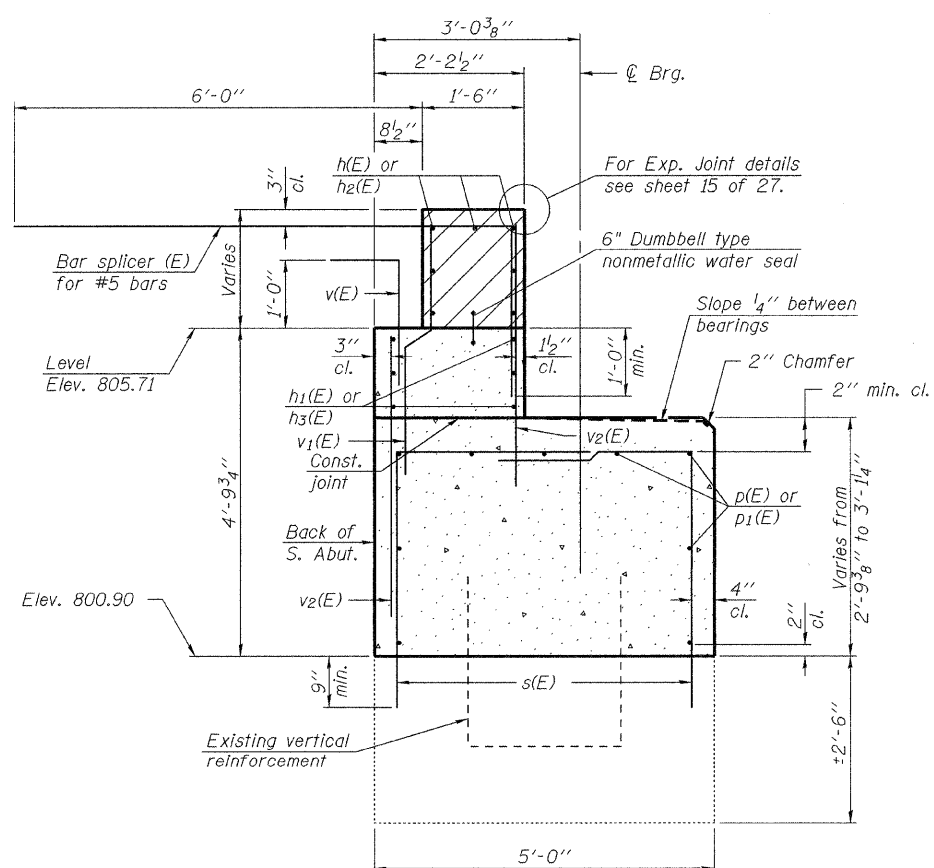

**SECTION THRU
ABUTMENT**

(Horizontal dims. are at right angles)

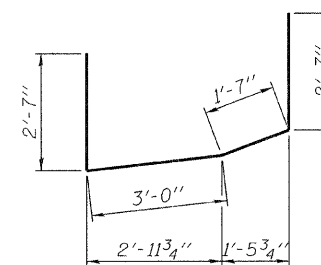

BAR u2(E)

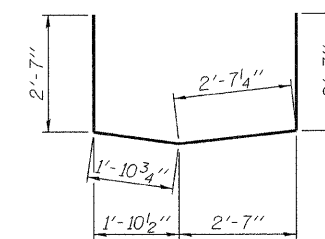

BAR u3(E)

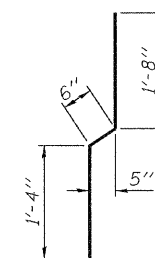

BAR v1(E)

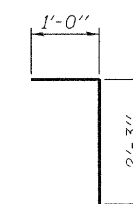

BAR v(E)

**SOUTH ABUTMENT
BILL OF MATERIAL**

Bar	No.	Size	Length	Shape
d2(E)	4	#5	7'-11"	Δ
h(E)	7	#6	24'-5"	—
h1(E)	6	#5	24'-5"	—
h2(E)	7	#6	20'-5"	—
h3(E)	6	#5	20'-5"	—
p(E)	9	#7	24'-5"	—
p1(E)	9	#7	20'-5"	—
s(E)	90	#5	6'-9"	└
u2(E)	4	#6	9'-9"	└
u3(E)	4	#6	9'-8"	└
v(E)	47	#5	3'-3"	└
v1(E)	47	#4	3'-6"	└
v2(E)	94	#5	3'-11"	└
Structure Excavation			Cu. Yd.	93
Concrete Structures			Cu. Yd.	31.9
Reinforcement Bars, Epoxy Coated			Pound	3,010
Concrete Sealer			Sq. Ft.	209

For details of Bar Splacers, see sheet 26 of 27.
For d2(E) bar bending diagram, see sheet 14 of 27.

DESIGNED Nicholas R. Barnett
CHECKED Michael D. Rolape
DRAWN Michael B. Mossman
CHECKED N.R.B./M.D.R./G.R.A.

September 29, 2009
EXAMINED Thomas J. Demagalicki
PASSED Ralph E. Anderson
ENGINEER OF BRIDGES AND STRUCTURES

**SOUTH ABUTMENT
STRUCTURE NO. 037-0017 (S.B.)**

SHEET NO. 25	F.A.I. RTE.	SECTION	COUNTY	TOTAL SHEETS	SHEET NO.
27 SHEETS	74	37-4HB-1	HENRY	148	91
					CONTRACT NO. 64264
ILLINOIS FED. AID PROJECT					