

**PARAPET TO CURB TRANSITION  
PILE BENT ABUTMENT**

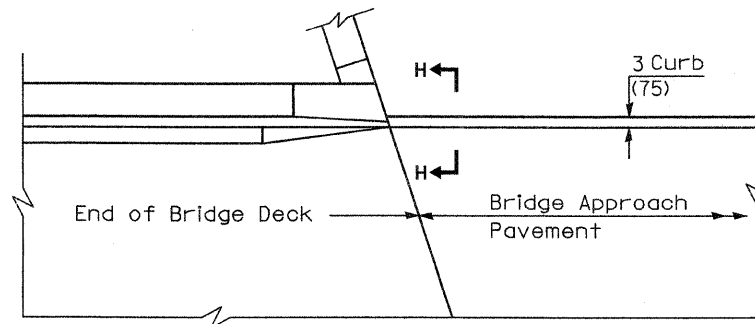

**PARAPET TO CURB TRANSITION  
INTEGRAL ABUTMENT**

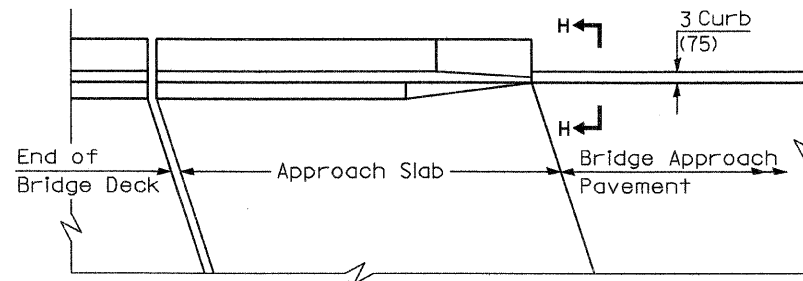

**PARAPET TO CURB TRANSITION  
VAULTED ABUTMENT**

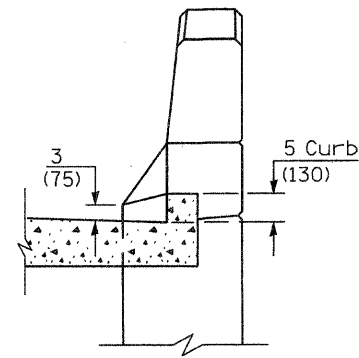

**SECTION I - I**

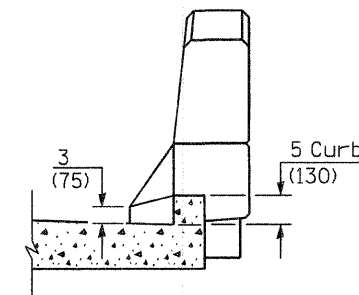

**SECTION H - H**

Illinois Department of Transportation  
 APPROVED January 1, 2008  
*Ralph E. Anderson*  
 ENGINEER OF BRIDGES AND STRUCTURES  
 APPROVED January 1, 2008  
*Ken E. Han*  
 ENGINEER OF DESIGN AND ENVIRONMENT

ISSUED 1-1-97

**BRIDGE APPROACH PAVEMENT**

(Sheet 4 of 4)

Contract 74232 Sheet 45d.