

ROUTE NO.	SECTION	COUNTY	TOTAL SHEETS	SHEET NO.
C.H. 22	05-00907-00-BR	CHAMPAIGN	36	16
STA.		TO STA.		
F.H.W.A. REG.		ILLINOIS PROJECT		

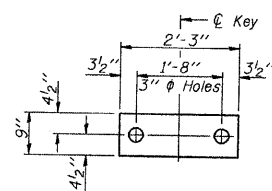

**FABRIC BEARING PAD**  
(Interior)

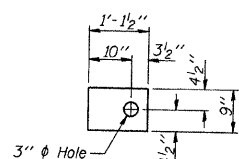

**FABRIC BEARING PAD**  
(Exterior)

**FIXED**

Note: Omit holes when using expansion bearings.

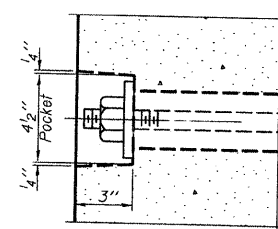

**SECTION A-A**

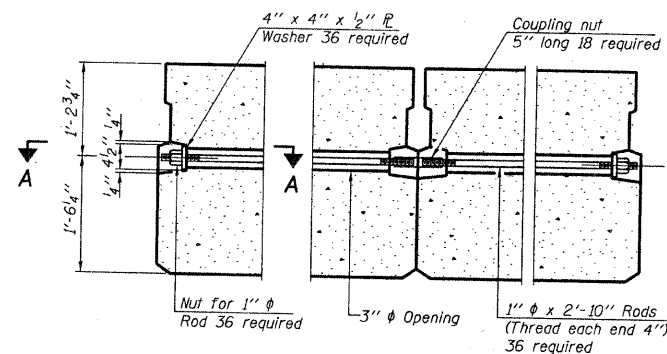

**TYPICAL TRANSVERSE TIE ASSEMBLY**

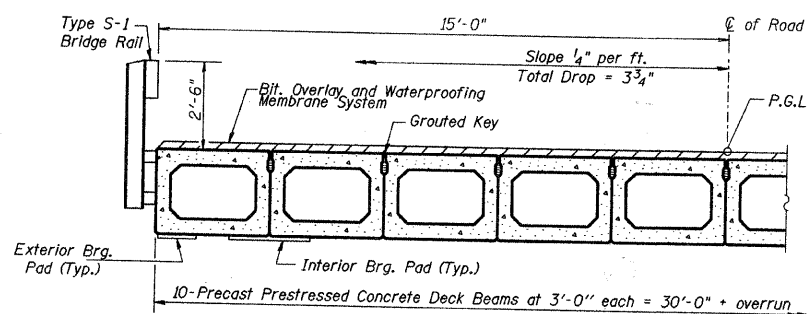

**HALF CROSS SECTION**

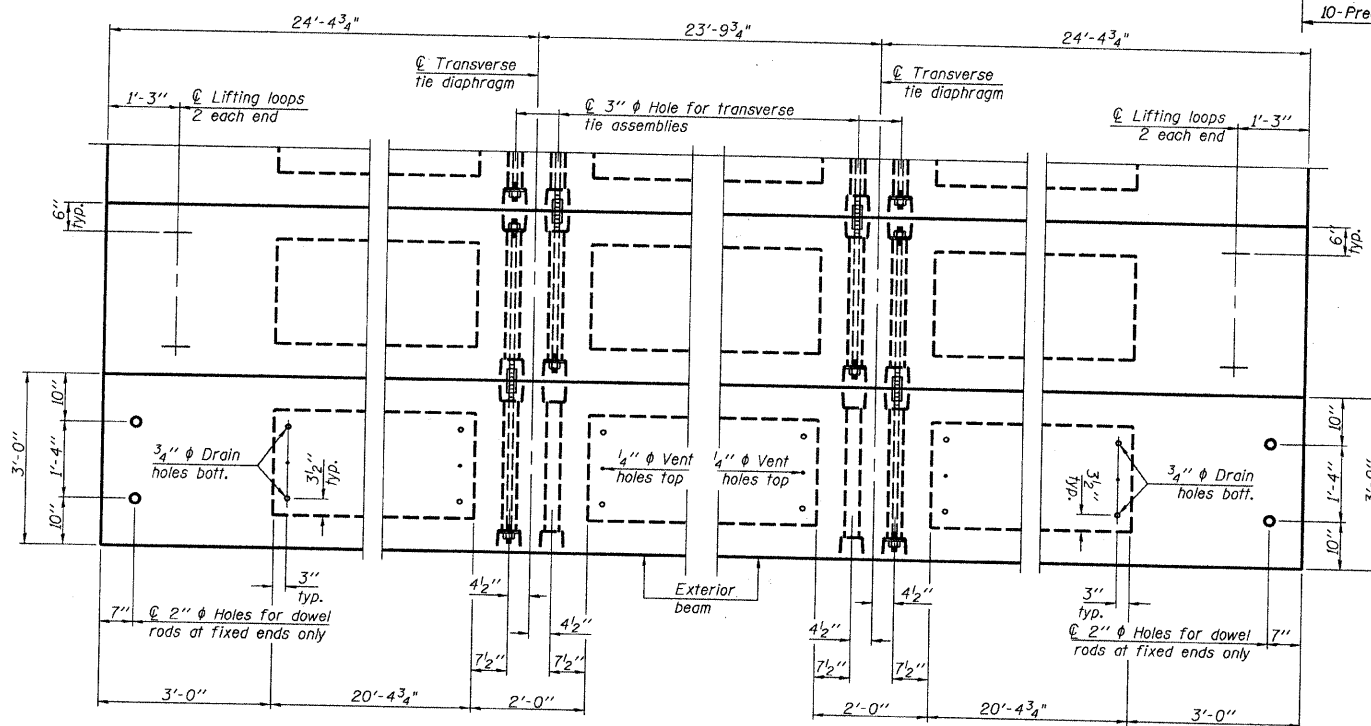

**PLAN VIEW**

Note: Connect beams in pairs with the transverse tie configuration shown.

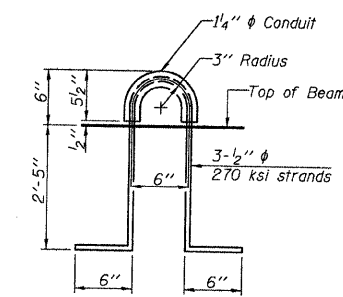
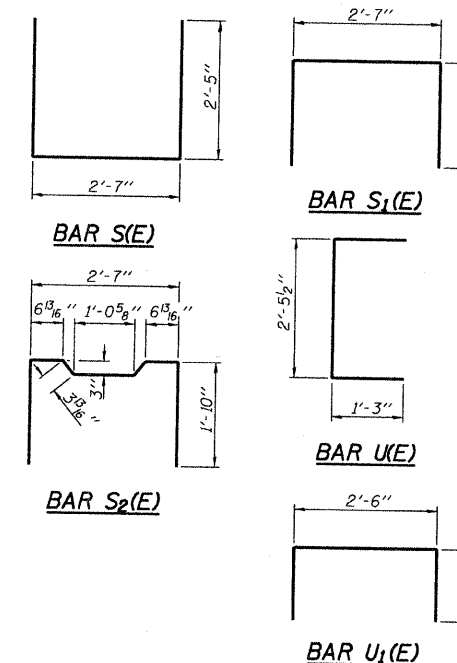

**LIFTING LOOP DETAIL**

**NOTES**

Prestressing steel shall be uncoated high strength, low relaxation 7-wire strand, Grade 270. The nominal diameter shall be 1/2" and the nominal cross-sectional area shall be 0.153 sq. in. The 1" diameter rods in the transverse tie assembly shall be tightened to a snug fit and the threads set. Pockets on exterior faces of bridge shall be filled with grout after transverse tie assembly is in place.

Reinforcement bars shall conform to ASTM A 706 (IL MOD), Grade 60. (See Special Provisions) Two 1/8" fabric adjusting shims of the dimensions of the exterior bearing pad shall be provided for each bearing pad location.

A minimum 2-1/2" diameter lifting pin shall be used to engage the lifting loops during handling.

Corrosion Inhibitor, per Article 1020.05(b)(12) and 1021.06 of the Standard Specifications, shall be used in the concrete for precast prestressed concrete deck beams.

Compressive strength of prestressed concrete, f'c, shall be 6000 psi.

Compressive strength of prestressed concrete at release, f'ci, shall be 5000 psi.

**BILL OF MATERIAL**

Precast Prestressed Conc. Deck Bms. (33" depth)	Sq. Ft.	8713
<b>33" X 36" PPC DECK BEAM DETAILS</b>		

SPANS 1, 2, 3, & 4

<b>SUPER STRUCTURE</b>
SECTION: 05-00907-00-BR
CHAMPAIGN COUNTY
CL STATION 10+00

PD-3336-OD 8-29-07