

ROUTE NO.	SECTION	COUNTY	TOTAL SHEETS	SHEET NO.
TR 512	08-08123-00-BR	FAYETTE	14	9
FED. ROAD DIST. NO.		ILLINOIS	PROJECT	

CONTRACT NO. 95595

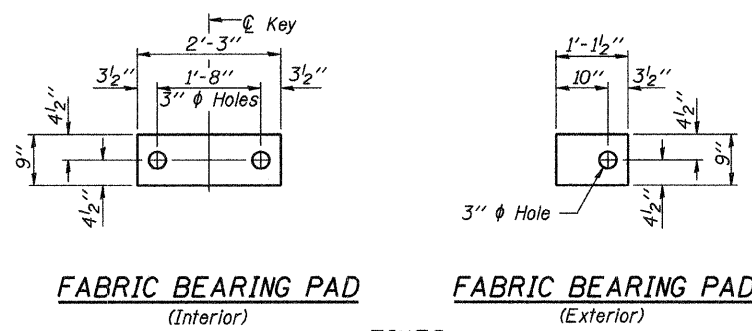

FIXED

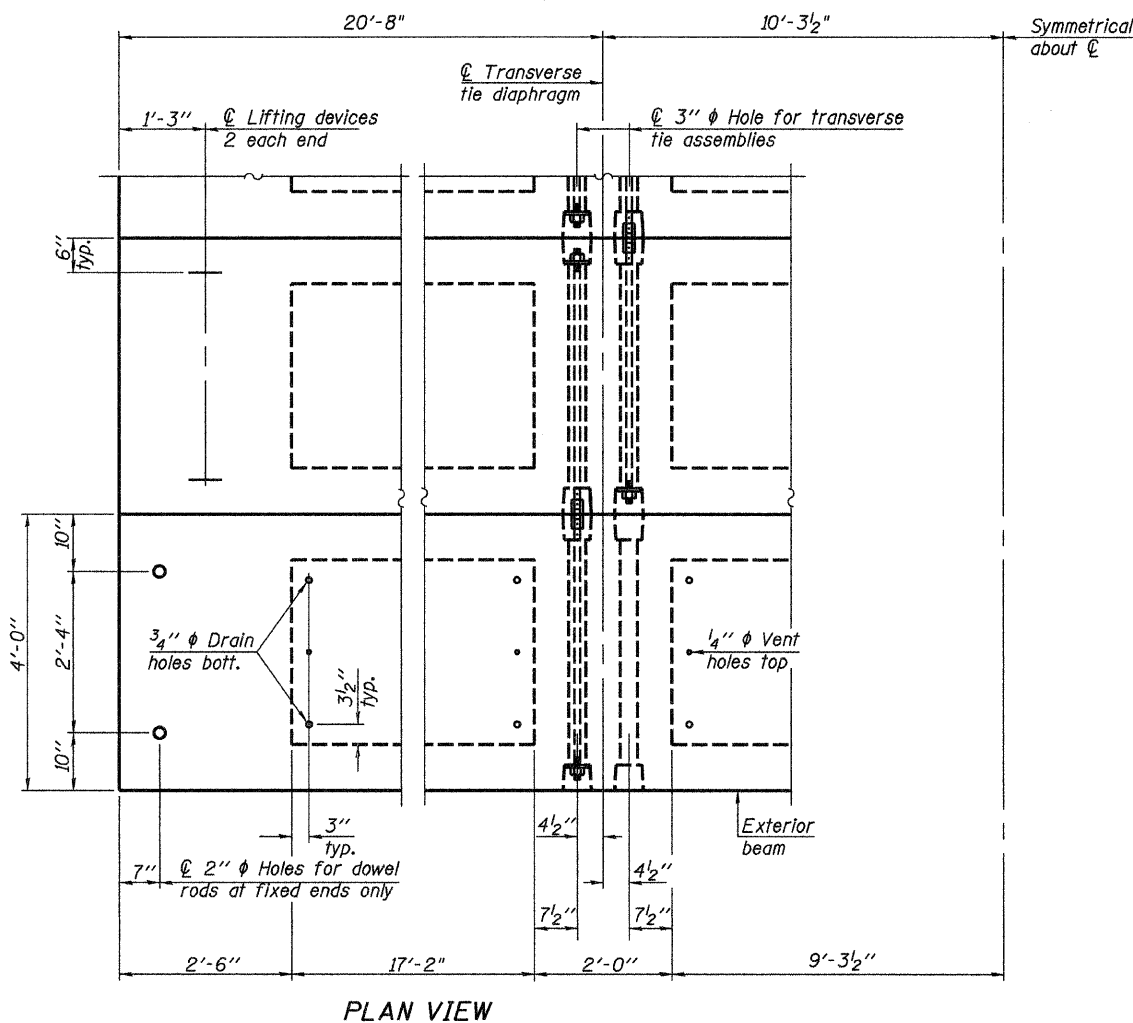
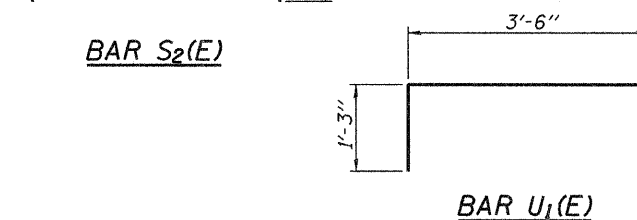
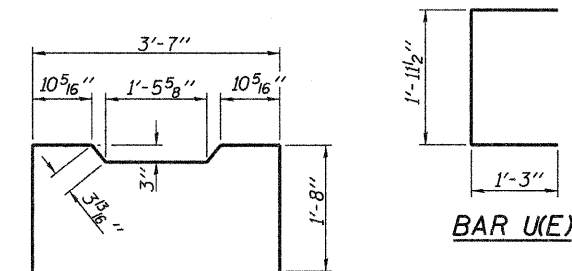
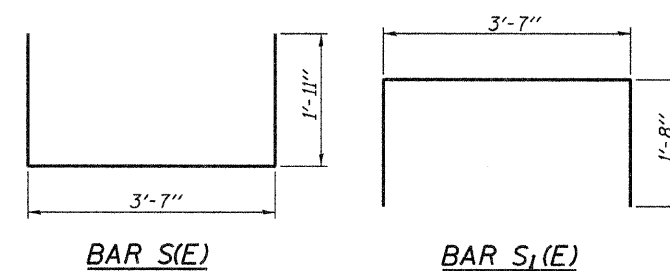
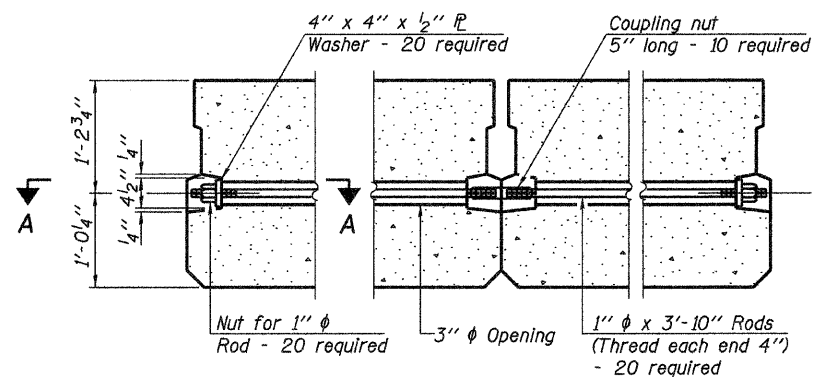
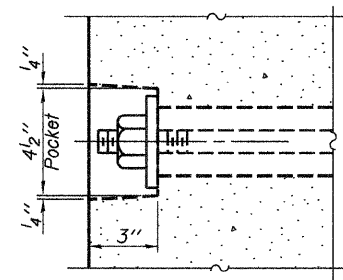

Note: Connect beams in pairs with the transverse tie configuration shown.

NOTES

Prestressing steel shall be uncoated high strength, low relaxation 7-wire strand, Grade 270. The nominal diameter shall be 1/2" and the nominal cross-sectional area shall be 0.153 sq. in. The 1" diameter rods in the transverse tie assembly shall be tightened to a snug fit and the threads set. Pockets on exterior faces of bridge shall be filled with grout after transverse tie assembly is in place. Reinforcement bars shall conform to ASTM A 706, Grade 60. (See Special Provisions). Two 1/8" fabric adjusting shims of the dimensions of the exterior bearing pad shall be provided for each bearing pad location. Corrosion Inhibitor, per Article 1020.05(b)(12) and 1021.06 of the Standard Specifications, shall be used in the concrete for precast prestressed concrete deck beams. Compressive strength of prestressed concrete, f'c, shall be 6000 psi. Compressive strength of prestressed concrete at release, f'ci, shall be 5000 psi. Rail post anchor devices shall be cast into outside beam as elsewhere specified. Keyway surfaces shall be cleaned to remove form oil or other bond breaking material prior to shipment of the beams. Cleaning shall be done by sandblasting the keyway areas between the top of the beam and the bottom edge of the key.

DESIGN STRESSES

- f's = 270,000 p.s.i. (1/2" diameter Strand)
- f'sl = 201,960 p.s.i. (1/2" diameter Strand)
- F1 = 30,900 lbs per strand
- f'y = 60,000 p.s.i. Reinf. bars
- f'c = 6,000 p.s.i.
- f'ci = 5,000 p.s.i.

Note: See sheet SLM-CS-2427-62 for Bill of Material.

AECOM 2524 S. Broadway Salem, Illinois 62281 618.548.3500 IL Design Firm Reg. No. 194-003706 www.aecom.com	SLM-PD-2748-0D P.P.C. DECK BEAM DETAILS AND NOTES
	Date: 07/27/09 Design: MRQ Drawn: BLT Job No.: 200804643