

**LIST OF STANDARDS**

- 280001-04 TEMPORARY EROSION CONTROL SYSTEMS
- 424001-05 CURB RAMPS FOR SIDEWALKS
- 542301-01 PRECAST REINFORCED CONCRETE FLARED END SECTION
- 602301-01 INLET, TYPE A
- 602306-01 INLET, TYPE B
- 604036-01 GRATE TYPE B
- 701301-02 LANE CLOSURE, 2L, 2W, SHORT TIME OPERATIONS
- 701901 TRAFFIC CONTROL DEVICES

**MIXES AND APPLICATION RATE TABLES**

PRIME APPLICATION RATES			
BIT MATLS PR CT	BIT MATLS C&S CT	COVER COAT AGG	SEAL COAT AGG
0.375 GAL/SQ YD	0.375 LB/SQ YD	20 LB/SQ YD	25 LB/SQ YD

**GENERAL NOTES**

- 1) ALL ELEVATIONS ARE REFERENCED TO ELEVATIONS ESTABLISHED BY VASCONCELLES ENGINEERING CORP.
- 2) WHERE SECTION OR SUBSECTION MONUMENTS ARE ENCOUNTERED, THE ENGINEER SHALL BE NOTIFIED BEFORE SUCH MONUMENTS ARE REMOVED. THE CONTRACTOR SHALL PROTECT AND CAREFULLY PRESERVE ALL PROPERTY MARKERS AND MONUMENTS UNTIL THE OWNER AND AUTHORIZED SURVEYOR OR AGENT HAS WITNESSED OR OTHERWISE REFERENCED THEIR LOCATION. IF THE ENGINEER DECIDES TO HAVE THE CONTRACTOR RESET THE MONUMENT, THIS WORK WILL BE PAID FOR IN ACCORDANCE WITH ARTICLE 109.04.
- 3) THE CONTRACTOR SHALL CONTACT J.U.L.I.E. PRIOR TO ANY EXCAVATION TO HAVE ALL PUBLIC AND PRIVATE UTILITIES LOCATED.
- 4) THE CONTRACTOR SHALL BE RESPONSIBLE FOR PROTECTING UTILITY PROPERTY FROM CONSTRUCTION OPERATIONS AS OUTLINED IN ARTICLE 107.26 OF THE STANDARD SPECIFICATIONS. THE J.U.L.I.E. NUMBER IS (800) 892-0123. A MINIMUM OF 48 HOURS ADVANCE NOTICE IS REQUIRED. SEE SPECIAL PROVISIONS FOR STATUS OF UTILITIES, WITH UTILITY COMPANIES LISTED.
- 5) ANY REFERENCE TO THE STANDARDS THROUGHOUT THE PLANS SHALL BE INTERPRETED TO BE THE LATEST STANDARDS OF THE DEPARTMENT AS INCLUDED IN THE PLANS.
- 6) ALL DETAILS IN THE PLANS SHALL GOVERN CONSTRUCTION OF THIS PROJECT, AND IN CASE OF CONFLICT WITH ANY STANDARD DRAWINGS INCLUDED, THE SAID DETAILS SHALL TAKE PRECEDENCE AND GOVERN.

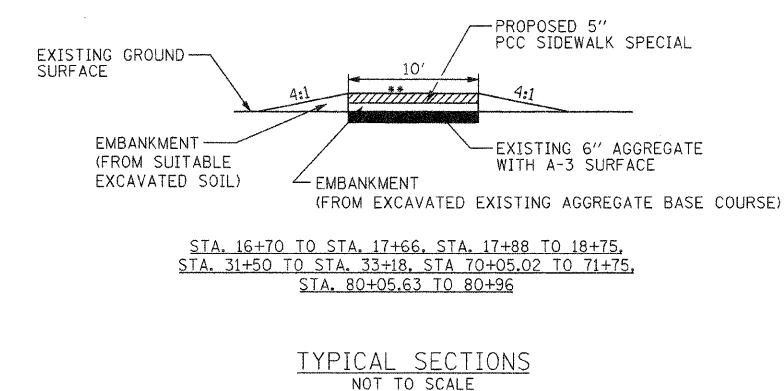
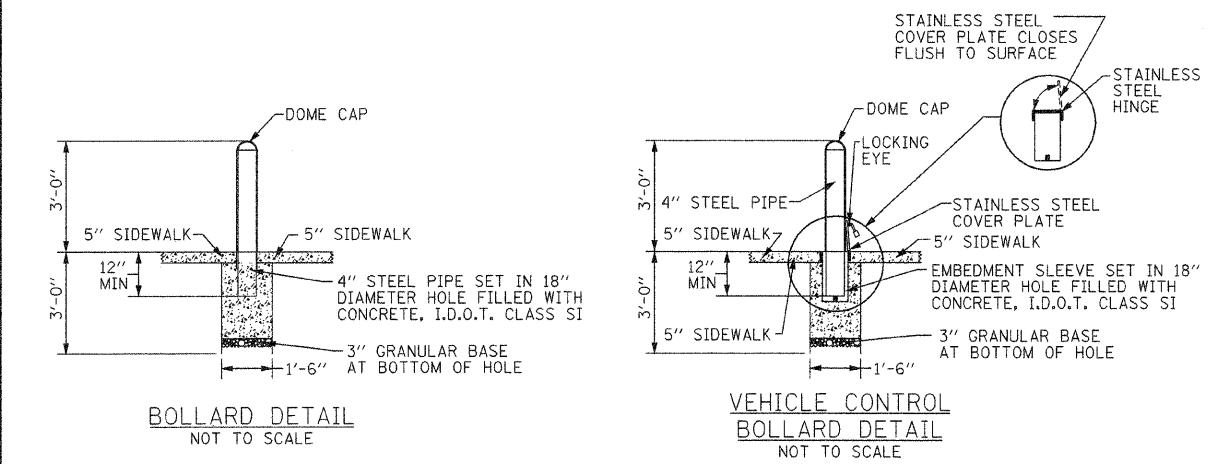
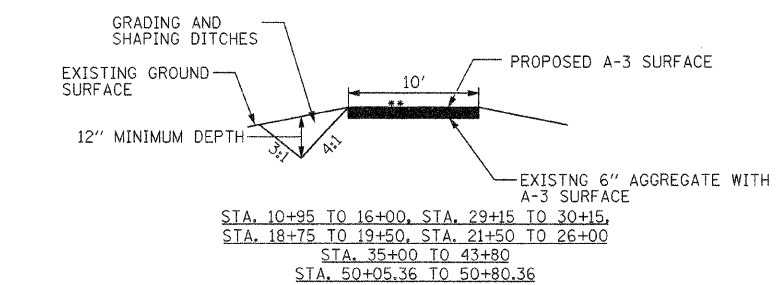
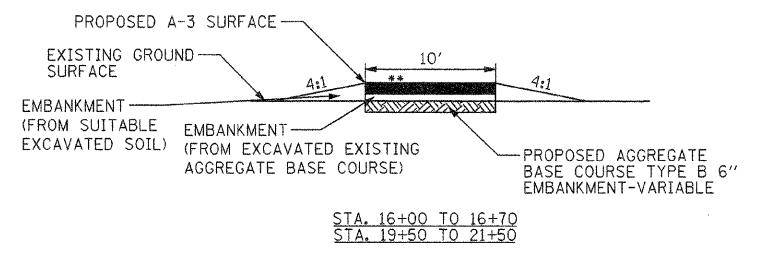
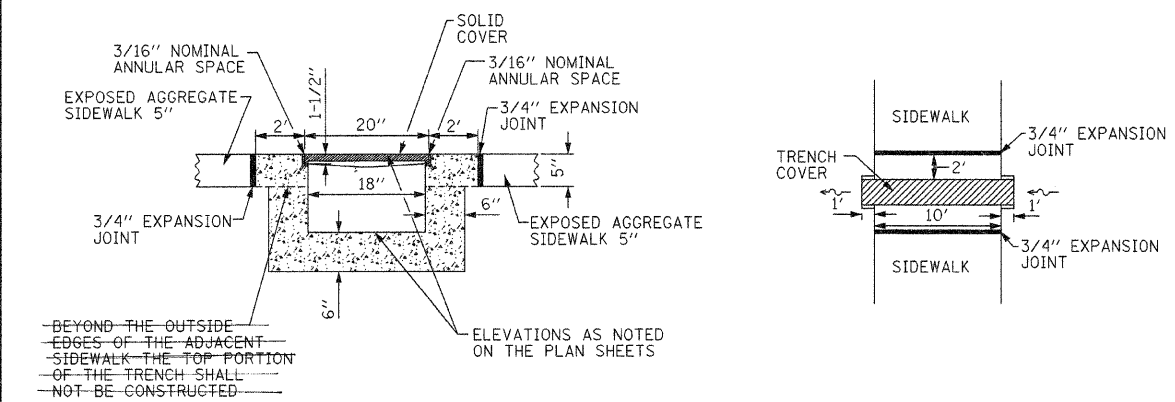
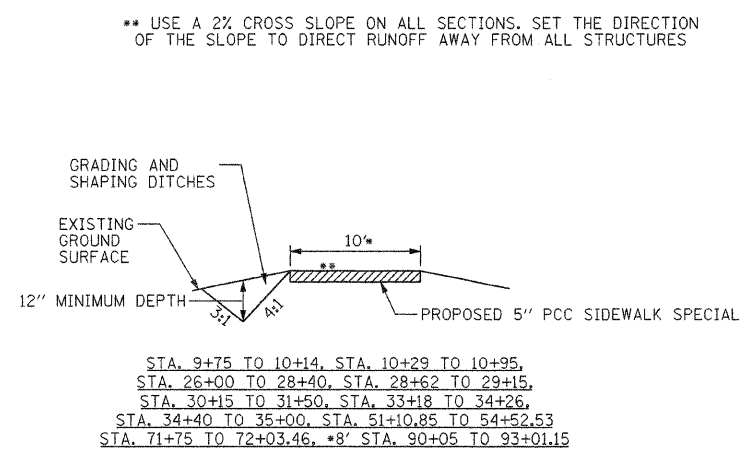
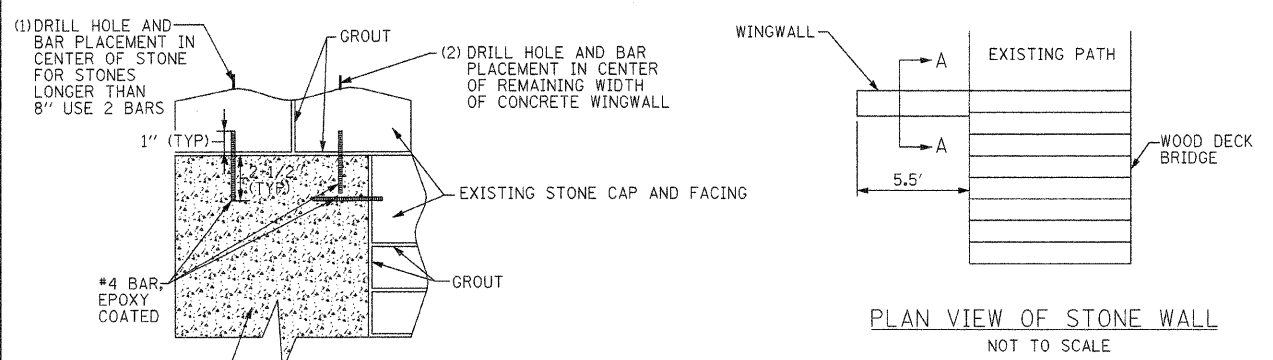

FILE NAME =	USER NAME = #USER#	DESIGNED - T.T.P.	REVISED -
#FILE#		DRAWN - S.D.K.	REVISED -
	PLOT SCALE = #SCALE#	CHECKED - T.T.P.	REVISED -
	PLOT DATE = #DATE#	DATE - 2/27/08	REVISED -

**STATE OF ILLINOIS**  
**DEPARTMENT OF TRANSPORTATION**

**NOTES & VARIOUS DETAILS**  
**LINCOLN LOG CABIN STATE HISTORIC SITE**

SCALE: SHEET NO. 4 OF 12 SHEETS STA. TO STA.

F.A. RTE.	SECTION	COUNTY	TOTAL SHEETS	SHEET NO.
		COLES	12	4
CONTRACT NO. 46002			ILLINOIS FED. AID PROJECT	