

Notes:
All bearing pads shall be 1" thick.

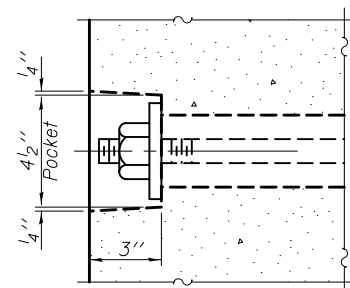

SECTION A-A

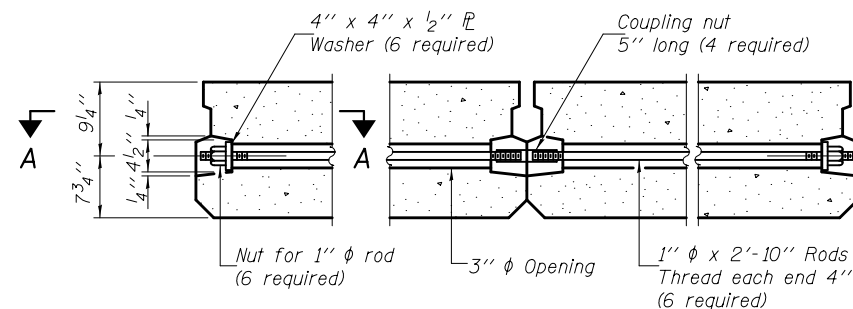

TYPICAL TRANSVERSE TIE ASSEMBLY

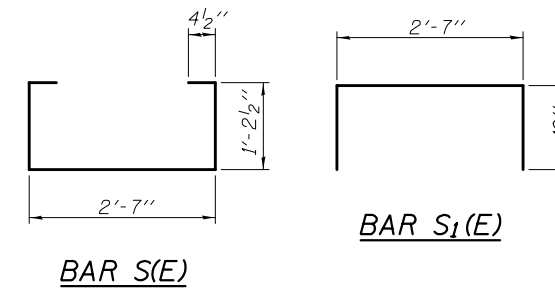

BAR S(E)

BAR S1(E)

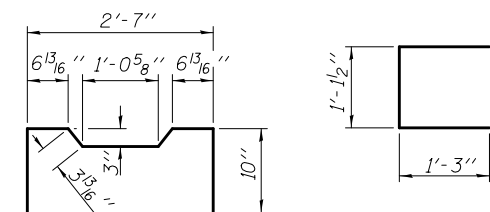

BAR S2(E)

BAR U(E)

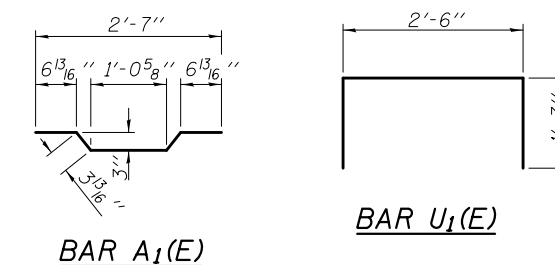

BAR A1(E)

BAR U1(E)

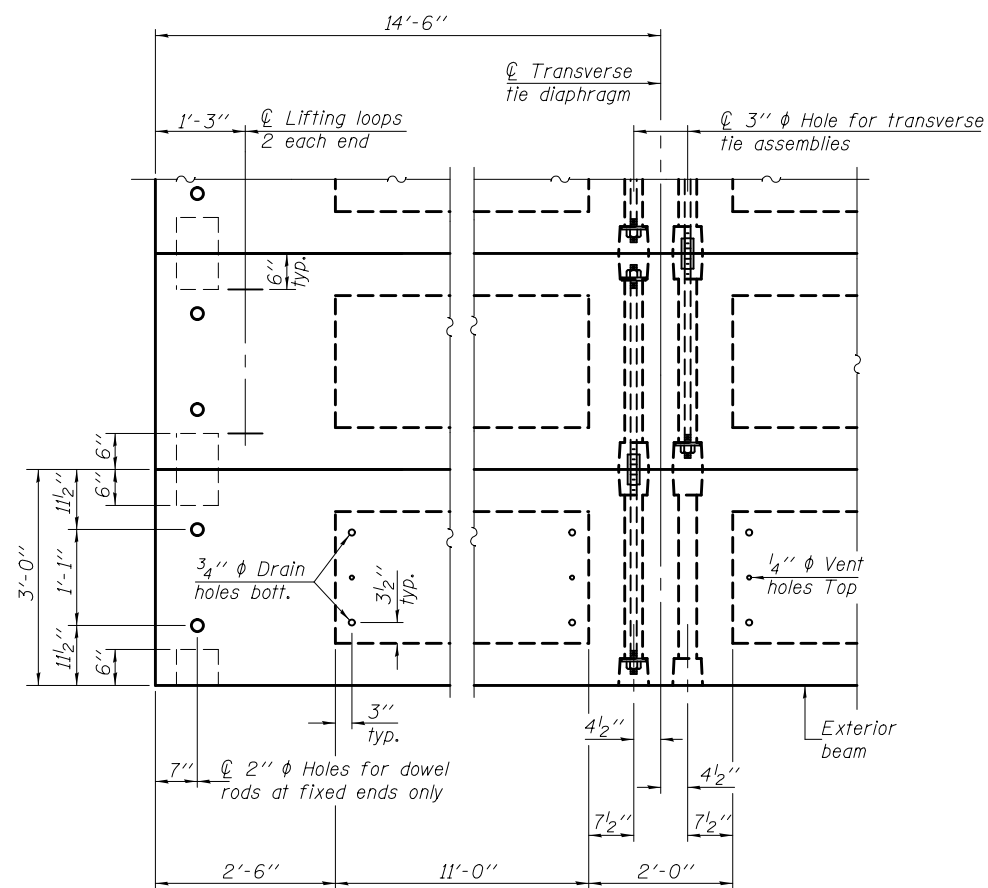

PLAN VIEW

Note: Connect beams in pairs with the transverse tie configuration shown.

NOTES

- Prestressing steel shall be uncoated high strength, low relaxation 7-wire strand, Grade 270. The nominal diameter shall be 1/2" and the nominal cross-sectional area shall be 0.153 sq. in.
- The 1" rods in the transverse tie assembly shall be tightened to a snug fit and the threads set. Pockets on exterior faces of bridge shall be filled with grout after transverse tie assembly is in place.
- Reinforcement bars shall conform to ASTM A 706, Grade 60.
- Two 1/8" fabric adjusting shims of the dimensions of the exterior bearing pad shall be provided for each bearing pad location.
- A minimum 2 1/2" lifting pin shall be used to engage the lifting loops during handling.
- Corrosion Inhibitor, per Article 1020.05(b)(12) and 1021.06 of the Standard Specifications, shall be used in the concrete for precast prestressed concrete deck beams.
- Compressive strength of prestressed concrete, f'c, shall be 6000 psi.
- Compressive strength of prestressed concrete at release, f'ci, shall be 5000 psi.

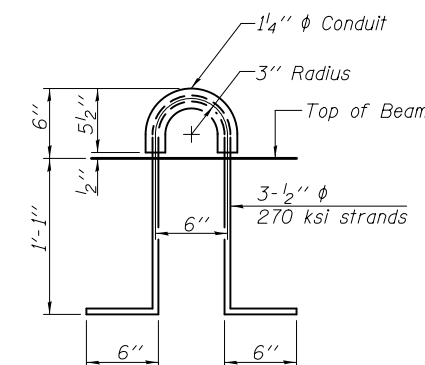

LIFTING LOOP DETAIL

BILL OF MATERIAL

Precast Prestressed Conc. Deck Bms. (17" depth)	Sq. Ft.	348
---	---------	-----

PD-1736-0D 7-1-10

DESIGNED - Eass Teklehmanot	EXAMINED - <i>Joanne F. [Signature]</i>	DATE - OCTOBER 1, 2013
CHECKED - Ray Ahanchi	PASSED - <i>Carl [Signature]</i>	REVISED -
DRAWN - b.t. duong	ACTING ENGINEER OF BRIDGES AND STRUCTURES	REVISED -
CHECKED - ETZGRA		

STATE OF ILLINOIS
DEPARTMENT OF TRANSPORTATION

17" x 36" PPC DECK BEAM DETAILS (SPAN 2)
STRUCTURE NO. 046-0109

SHEET NO. 13 OF 22 SHEETS

F.A.S. RTE.	SECTION	COUNTY	TOTAL SHEETS	SHEET NO.
1323	102-BR	KANKAKEE	53	29
CONTRACT NO. 66B66				
ILLINOIS FED. AID PROJECT				