

RETURN WITH BID

State of _____)
) ss.
County of _____)

AFFIDAVIT

_____ (name of affiant), of _____,

_____, being first duly sworn upon oath, states as follows:

1. That I am the _____ (officer or position) of _____ (bidder) and have personal knowledge of the facts herein stated.
2. That, if selected under this proposal, _____ (bidder) will maintain a business office in the State of Illinois which will be located in _____ County, Illinois.
3. That this business office will serve as the primary place of employment for any persons employed in the construction contemplated by this proposal.
4. That this Affidavit is given as a requirement of state law as provided in Section 30-22(8) of the Illinois Procurement Code.

Signature

Print Name of Affiant

This instrument was acknowledged before me on the _____ day of _____, 20__ by _____.

Notary Public

(SEAL)

INSTRUCTIONS

ABOUT IDOT PROPOSALS: All proposals are potential bidding proposals. Each proposal contains all certifications and affidavits, a proposal signature sheet and a proposal bid bond.

PREQUALIFICATION

Any contractor who desires to become pre-qualified to bid on work advertised by IDOT must submit the properly completed pre-qualification forms to the Bureau of Construction no later than 4:30 p.m. prevailing time twenty-one days prior to the letting of interest. This pre-qualification requirement applies to first time contractors, contractors renewing expired ratings, contractors maintaining continuous pre-qualification or contractors requesting revised ratings. To be eligible to bid, existing pre-qualification ratings must be effective through the date of letting.

WHO CAN BID ?

Bids will be accepted from only those companies that request and receive written Authorization to Bid from IDOT's Central Bureau of Construction. This does not apply to Small Business Set-Asides.

REQUESTS FOR AUTHORIZATION TO BID

Contractors wanting to bid on items included in a particular letting must submit the properly completed "Request for Authorization to Bid/or Not For Bid Status" (BDE 124) and the ORIGINAL "Affidavit of Availability" (BC 57) to the proper office no later than 4:30 p.m. prevailing time, three (3) days prior to the letting date. This does not apply to Small Business Set-Asides.

WHAT CONSTITUTES WRITTEN AUTHORIZATION TO BID?: When a prospective prime bidder submits a "Request for Authorization to Bid/or Not For Bid Status"(BDE 124) he/she must indicate at that time which items are being requested For Bidding purposes. Only those items requested For Bidding will be analyzed. After the request has been analyzed, the bidder will be issued an **Authorization to Bid or Not for Bid Report**, approved by the Central Bureau of Construction and the Chief Procurement Officer that indicates which items have been approved For Bidding. If **Authorization to Bid** cannot be approved, the **Authorization to Bid or Not for Bid Report** will indicate the reason for denial.

ABOUT AUTHORIZATION TO BID: Firms that have not received an Authorization to Bid or Not For Bid Report within a reasonable time of complete and correct original document submittal should contact the department as to the status. Firms unsure as to authorization status should call the Prequalification Section of the Bureau of Construction at the number listed at the end of these instructions. These documents must be received three days before the letting date.

ADDENDA AND REVISIONS: It is the bidder's responsibility to determine which, if any, addenda or revisions pertain to any project they may be bidding. Failure to incorporate all relevant addenda or revisions may cause the bid to be declared unacceptable.

Each addendum or revision will be included with the Electronic Plans and Proposals. Addenda and revisions will also be placed on the Addendum/Revision Checklist and each subscription service subscriber will be notified by e-mail of each addendum and revision issued.

The Internet is the Department's primary way of doing business. The subscription server e-mails are an added courtesy the Department provides. It is suggested that bidders check IDOT's website at <http://www.dot.il.gov/desenv/delett.html> before submitting final bid information.

IDOT IS NOT RESPONSIBLE FOR ANY E-MAIL FAILURES.

Addenda questions may be directed to the Contracts Office at (217)782-7806 or D&Econtracts@dot.il.gov

Technical questions about downloading these files may be directed to Tim Garman at (217)524-1642 or Timothy.Garman@illinois.gov.

BID SUBMITTAL GUIDELINES AND CHECKLIST

In an effort to eliminate confusion and standardize the bid submission process the Contracts Office has created the following guidelines and checklist for submitting bids.

This information has been compiled from questions received from contractors and from inconsistencies noted on submitted bids. If you have additional questions please refer to the contact information listed below.

ABOUT SUBMITTING BIDS: It is recommended that bidders deliver bid proposals in person to ensure they arrive at the proper location prior to the time specified for the receipt of bids. Any proposals received at the place of letting after the time specified will not be read.

STANDARD GUIDELINES FOR SUBMITTING BIDS

- All pages should be single sided.
- Use the Cover Page that is provided in the Bid Proposal (posted on the IDOT Web Site) as the first page of your submitted bid. This page has the Item number in the upper left-hand corner and lines provided for your company name and address in the upper right-hand corner.
- Do not use report covers, presentation folders or special bindings and do not staple multiple times on left side like a book. Use only 1 staple in the upper left hand corner. Make sure all elements of your bid are stapled together including the bid bond or guaranty check (if required).
- Do not include any certificates of eligibility, your authorization to bid, Addendum Letters or affidavit of availability.
- Do not include the Subcontractor Documentation with your bid (pages i – iii and pages a – g). This documentation is required only after you are awarded the contract.
- Use the envelope cover sheet (provided with the proposal) as the cover for the proposal envelope.
- Do not rely on overnight services to deliver your proposal prior to 10 AM on letting day. It will not be read if it is delivered after 10 AM.
- Do not submit your Substance Abuse Prevention Program (SAPP) with your bid. If you are awarded the contract this form is to be submitted to the district engineer at the pre-construction conference.

Use the following checklist to ensure completeness and the correct order in assembling your bid

Illinois Office Affidavit (Not applicable to federally funded projects) insert your affidavit after page 4 along with your Cost Adjustments for Steel, Bituminous and Fuel (if applicable).

Cover page (the sheet that has the item number on it) **followed by your bid (the Pay Items)**. If you are using special software or CBID to generate your schedule of prices, do not include the blank pages of the schedule of prices that came with the proposal package.

Page 4 (Item 9) – Check “YES” if you will use a subcontractor(s). Include the subcontractor(s) name, address, general type of work to be performed and the dollar amount (if over \$50,000). If you will use subcontractor(s) but are uncertain who or the dollar amount; check “YES” but leave the lines blank.

Page 10 (Paragraph J) – Check “YES” or “NO” whether your company has any business in Iran.

Page 10 (Paragraph K) – (Not applicable to federally funded projects) List the Union Local Name and number or certified training programs that you have in place. **Your bid will not be read if this is not completed.** Do not include certificates with your bid. Keep the certificates in your office in case they are requested by IDOT.

Page 11 (Paragraph L) - A copy of your State Board of Elections certificate of registration is no longer required with your bid.

Page 11 (Paragraph M) – Indicate if your company has hired a lobbyist in connection with the job for which you are submitting the bid proposal.

Page 12 (Paragraph C) – This is a work sheet to determine if a completed Form A is required. It is not part of the form and you do not need to make copies for each Form A that is filled out.

Pages 14-17 (Form A) – One Form A (4 pages) is required for each applicable person in your company. Copies of the Forms can be used and only need to be changed when the financial information changes. The certification signature and date must be original for each letting. Do not staple the forms together.

If you answered “NO” to all of the questions in Paragraph C (page 12), complete the first section (page 14) with your company information and then sign and date the Not Applicable statement on page 17.

Page 18 (Form B) - If you check “YES” to having other current or pending contracts it is acceptable to use the phrase, “See Affidavit of Availability on file”. **Ownership Certification** (at the bottom of the page) - Check N/A if the Form A you submitted accounts for 100 percent of the company ownership. Check YES if any percentage of ownership falls outside of the parameters that require reporting on the Form A. Checking NO indicates that the Form A you submitted is not correct and you will be required to submit a revised Form A.

Page 20 (Workforce Projection) – Be sure to include the Duration of the Project. It is acceptable to use the phrase “Per Contract Specifications”.

Bid Bond – Submit your bid bond using the current Bid Bond Form provided in the proposal package. The Power of Attorney page should be stapled to the Bid Bond. If you are using an electronic bond, include your bid bond number on the form and attach the Proof of Insurance printed from the Surety 2000 Web Site.

Disadvantaged Business Utilization Plan and/or Good Faith Effort – The last item in your bid should be the DBE Utilization Plan (SBE 2026), followed by the DBE Participation Statement (SBE 2025) and supporting paperwork. If you have documentation for a Good Faith Effort, it should follow the SBE Forms.

The Bid Letting is now available in streaming Audio/Video from the IDOT Web Site. A link to the stream will be placed on the main page of the current letting on the day of the Letting. The stream will not begin until 10 AM. The actual reading of the bids does not begin until approximately 10:20 AM.

Following the Letting, the As-Read Tabulation of Bids will be posted by the end of the day. You will find the link on the main page of the current letting.

QUESTIONS: pre-letting up to execution of the contract

Contractor/Subcontractor pre-qualification -----217-782-3413
Small Business, Disadvantaged Business Enterprise (DBE) -----217-785-4611
Contracts, Bids, Letting process or Internet downloads-----217-782-7806
Estimates Unit -----217-785-3483
Aeronautics -----217-785-8515
IDNR (Land Reclamation, Water Resources, Natural Resources) -----217-782-6302

QUESTIONS: following contract execution

Including Subcontractor documentation, payments-----217-782-3413
Railroad Insurance -----217-785-0275

16

RETURN WITH BID

Proposal Submitted By
Name
Address
City

Letting November 9, 2012

NOTICE TO PROSPECTIVE BIDDERS

This proposal can be used for bidding purposes by only those companies that request and receive written AUTHORIZATION TO BID from IDOT's Central Bureau of Construction. This does not apply to Small Business Set-Asides.

BIDDERS NEED NOT RETURN THE ENTIRE PROPOSAL

Notice to Bidders, Specifications, Proposal, Contract and Contract Bond



**Illinois Department
of Transportation**

Springfield, Illinois 62764

**Contract No. 64J11
WINNEBAGO County
Section D2 PATCHING 2013-1
Route FAI 39
District 2 Construction Funds**

PLEASE MARK THE APPROPRIATE BOX BELOW:

- A Bid Bond is included.
- A Cashier's Check or a Certified Check is included.

Plans Included
Herein

Prepared by

Checked by

S

(Printed by authority of the State of Illinois)

Page intentionally left blank

RETURN WITH BID



PROPOSAL

TO THE DEPARTMENT OF TRANSPORTATION

1. Proposal of _____

Taxpayer Identification Number (Mandatory) _____ a

For the improvement identified and advertised for bids in the Invitation for Bids as:

**Contract No. 64J11
WINNEBAGO County
Section D2 PATCHING 2013-1
Route FAI 39
District 2 Construction Funds**

Pavement patching and HMA surface on the I-39 Interchange ramps at Baxter Rd. in Winnebago County.

2. The undersigned bidder will furnish all labor, material and equipment to complete the above described project in a good and workmanlike manner as provided in the contract documents provided by the Department of Transportation. This proposal will become part of the contract and the terms and conditions contained in the contract documents shall govern performance and payments.

RETURN WITH BID

3. **ASSURANCE OF EXAMINATION AND INSPECTION/WAIVER.** The undersigned further declares that he/she has carefully examined the proposal, plans, specifications, addenda, form of contract and contract bond, and special provisions, and that he/she has inspected in detail the site of the proposed work, and that he/she has familiarized themselves with all of the local conditions affecting the contract and the detailed requirements of construction, and understands that in making this proposal he/she waives all right to plead any misunderstanding regarding the same.
4. **EXECUTION OF CONTRACT AND CONTRACT BOND.** The undersigned further agrees to execute a contract for this work and present the same to the department within fifteen (15) days after the contract has been mailed to him/her. The undersigned further agrees that he/she and his/her surety will execute and present within fifteen (15) days after the contract has been mailed to him/her contract bond satisfactory to and in the form prescribed by the Department of Transportation, in the penal sum of the full amount of the contract, guaranteeing the faithful performance of the work in accordance with the terms of the contract.
5. **PROPOSAL GUARANTY.** Accompanying this proposal is either a bid bond on the department form, executed by a corporate surety company satisfactory to the department, or a proposal guaranty check consisting of a bank cashier's check or a properly certified check for not less than 5 per cent of the amount bid or for the amount specified in the following schedule:

<u>Amount of Bid</u>		<u>Proposal Guaranty</u>	<u>Amount of Bid</u>		<u>Proposal Guaranty</u>	
Up to	\$5,000	\$150	\$2,000,000	to	\$3,000,000	\$100,000
\$5,000	to \$10,000	\$300	\$3,000,000	to	\$5,000,000	\$150,000
\$10,000	to \$50,000	\$1,000	\$5,000,000	to	\$7,500,000	\$250,000
\$50,000	to \$100,000	\$3,000	\$7,500,000	to	\$10,000,000	\$400,000
\$100,000	to \$150,000	\$5,000	\$10,000,000	to	\$15,000,000	\$500,000
\$150,000	to \$250,000	\$7,500	\$15,000,000	to	\$20,000,000	\$600,000
\$250,000	to \$500,000	\$12,500	\$20,000,000	to	\$25,000,000	\$700,000
\$500,000	to \$1,000,000	\$25,000	\$25,000,000	to	\$30,000,000	\$800,000
\$1,000,000	to \$1,500,000	\$50,000	\$30,000,000	to	\$35,000,000	\$900,000
\$1,500,000	to \$2,000,000	\$75,000	over		\$35,000,000	\$1,000,000

Bank cashier's checks or properly certified checks accompanying proposals shall be made payable to the Treasurer, State of Illinois, when the state is awarding authority; the county treasurer, when a county is the awarding authority; or the city, village, or town treasurer, when a city, village, or town is the awarding authority.

If a combination bid is submitted, the proposal guaranties which accompany the individual proposals making up the combination will be considered as also covering the combination bid.

The amount of the proposal guaranty check is _____ \$(_____). If this proposal is accepted and the undersigned shall fail to execute a contract bond as required herein, it is hereby agreed that the amount of the proposal guaranty shall become the property of the State of Illinois, and shall be considered as payment of damages due to delay and other causes suffered by the State because of the failure to execute said contract and contract bond; otherwise, the bid bond shall become void or the proposal guaranty check shall be returned to the undersigned.

Attach Cashier's Check or Certified Check Here	
In the event that one proposal guaranty check is intended to cover two or more proposals, the amount must be equal to the sum of the proposal guaranties which would be required for each individual proposal. If the guaranty check is placed in another proposal, state below where it may be found.	
The proposal guaranty check will be found in the proposal for:	Item _____
	Section No. _____
	County _____

Mark the proposal cover sheet as to the type of proposal guaranty submitted.

RETURN WITH BID

6. **COMBINATION BIDS.** The undersigned further agrees that if awarded the contract for the sections contained in the following combination, he/she will perform the work in accordance with the requirements of each individual proposal comprising the combination bid specified in the schedule below, and that the combination bid shall be prorated against each section in proportion to the bid submitted for the same. If an error is found to exist in the gross sum bid for one or more of the individual sections included in a combination, the combination bid shall be corrected as provided in the specifications.

When a combination bid is submitted, the schedule below must be completed in each proposal comprising the combination.

If alternate bids are submitted for one or more of the sections comprising the combination, a combination bid must be submitted for each alternate.

Schedule of Combination Bids

Combination No.	Sections Included in Combination	Combination Bid	
		Dollars	Cents

7. **SCHEDULE OF PRICES.** The undersigned bidder submits herewith, in accordance with the rules and instructions, a schedule of prices for the items of work for which bids are sought. The unit prices bid are in U.S. dollars and cents, and all extensions and summations have been made. The bidder understands that the quantities appearing in the bid schedule are approximate and are provided for the purpose of obtaining a gross sum for the comparison of bids. If there is an error in the extension of the unit prices, the unit prices shall govern. Payment to the contractor awarded the contract will be made only for actual quantities of work performed and accepted or materials furnished according to the contract. The scheduled quantities of work to be done and materials to be furnished may be increased, decreased or omitted as provided elsewhere in the contract.

8. **AUTHORITY TO DO BUSINESS IN ILLINOIS.** Section 20-43 of the Illinois Procurement Code (the Code) (30 ILCS 500/20-43) provides that a person (other than an individual acting as a sole proprietor) must be a legal entity authorized to do business in the State of Illinois prior to submitting the bid.

9. **The services of a subcontractor will be used.**

Check box Yes
 Check box No

For known subcontractors with subcontracts with an annual value of more than \$50,000, the contract shall include their name, address, general type of work to be performed, and the dollar allocation for each subcontractor.
 (30 ILCS 500/20-120)

10. **EXECUTION OF CONTRACT:** The Department of Transportation will, in accordance with the rules governing Department procurements, execute the contract and shall be the sole entity having the authority to accept performance and make payments under the contract. Execution of the contract by the Chief Procurement Officer (CPO) or the State Purchasing Officer (SPO) is for approval of the procurement process and execution of the contract by the Department. Neither the CPO nor the SPO shall be responsible for administration of the contract or determinations respecting performance or payment there under except as otherwise permitted in the Code.

ILLINOIS DEPARTMENT OF TRANSPORTATION
 SCHEDULE OF PRICES
 CONTRACT
 NUMBER -

64J11

State Job # - C-92-161-12

Project Number

Route

County Name - WINNEBAGO - -

FAI 39

Code - 201 - -

District - 2 - -

Section Number - D2 PATCHING 2013-1

Item Number	Pay Item Description	Unit of Measure	Quantity	x	Unit Price	=	Total Price
X4060995	TEMPORARY RAMP SPL	SQ YD	107.000				
Z0028415	GEOTECHNICAL REINF	SQ YD	313.000				
20200600	EXC & GR EX SHOULDER	UNIT	2.000				
30300001	AGG SUBGRADE IMPROVE	CU YD	52.000				
31100910	SUB GRAN MAT A 12	SQ YD	115.000				
40603310	HMA SC "C" N50	TON	10.000				
42001200	PAVEMENT FABRIC	SQ YD	313.000				
44200976	CL B PATCH T4 10	SQ YD	313.000				
44201299	DOWEL BARS 1 1/2	EACH	190.000				
44213200	SAW CUTS	FOOT	261.000				
44213208	TIE BARS 1 1/4	EACH	103.000				
48102100	AGG WEDGE SHLD TYPE B	TON	61.000				
48203023	HMA SHOULDERS 6 1/2	SQ YD	115.000				
60107600	PIPE UNDERDRAINS 4	FOOT	192.000				
67100100	MOBILIZATION	L SUM	1.000				

ILLINOIS DEPARTMENT OF TRANSPORTATION
 SCHEDULE OF PRICES
 CONTRACT
 NUMBER - 64J11

State Job # - C-92-161-12

Project Number

Route

County Name - WINNEBAGO - -

FAI 39

Code - 201 - -

District - 2 - -

Section Number - D2 PATCHING 2013-1

Item Number	Pay Item Description	Unit of Measure	Quantity	x	Unit Price	=	Total Price
70100450	TRAF CONT-PROT 701201	L SUM	1.000				
70100500	TRAF CONT-PROT 701326	L SUM	1.000				
70100825	TRAF CONT-PROT 701456	L SUM	1.000				
70103815	TR CONT SURVEILLANCE	CAL DA	6.000				
78001110	PAINT PVT MK LINE 4	FOOT	1,082.000				
78001140	PAINT PVT MK LINE 8	FOOT	270.000				
78001150	PAINT PVT MK LINE 12	FOOT	66.000				
78001180	PAINT PVT MK LINE 24	FOOT	80.000				

RETURN WITH BID

STATE REQUIRED ETHICAL STANDARDS GOVERNING CONTRACT PROCUREMENT: ASSURANCES, CERTIFICATIONS AND DISCLOSURES

I. GENERAL

A. Article 50 of the Code establishes the duty of all State CPOs, SPOs, and their designees to maximize the value of the expenditure of public moneys in procuring goods, services, and contracts for the State of Illinois and to act in a manner that maintains the integrity and public trust of State government. In discharging this duty, they are charged by law to use all available information, reasonable efforts, and reasonable actions to protect, safeguard, and maintain the procurement process of the State of Illinois.

B. In order to comply with the provisions of Article 50 and to carry out the duty established therein, all bidders are to adhere to ethical standards established for the procurement process, and to make such assurances, disclosures and certifications required by law. Except as otherwise required in subsection III, paragraphs J-M, by execution of the Proposal Signature Sheet, the bidder indicates that each of the mandated assurances have been read and understood, that each certification is made and understood, and that each disclosure requirement has been understood and completed.

C. In addition to all other remedies provided by law, failure to comply with any assurance, failure to make any disclosure or the making of a false certification shall be grounds for the CPO to void the contract, and may result in the suspension or debarment of the bidder or subcontractor. If a false certification is made by a subcontractor the contractor's submitted bid and the executed contract may not be declared void unless the contractor refuses to terminate the subcontract upon the State's request after a finding that the subcontractor's certification was false.

II. ASSURANCES

The assurances hereinafter made by the bidder are each a material representation of fact upon which reliance is placed should the Department enter into the contract with the bidder.

A. Conflicts of Interest

1. The Code provides in pertinent part:

Section 50-13. Conflicts of Interest.

(a) Prohibition. It is unlawful for any person holding an elective office in this State, holding a seat in the General Assembly, or appointed to or employed in any of the offices or agencies of state government and who receives compensation for such employment in excess of 60% of the salary of the Governor of the State of Illinois, or who is an officer or employee of the Capital Development Board or the Illinois Toll Highway Authority, or who is the spouse or minor child of any such person to have or acquire any contract, or any direct pecuniary interest in any contract therein, whether for stationery, printing, paper, or any services, materials, or supplies, that will be wholly or partially satisfied by the payment of funds appropriated by the General Assembly of the State of Illinois or in any contract of the Capital Development Board or the Illinois Toll Highway authority.

(b) Interests. It is unlawful for any firm, partnership, association or corporation, in which any person listed in subsection (a) is entitled to receive (i) more than 7 1/2% of the total distributable income or (ii) an amount in excess of the salary of the Governor, to have or acquire any such contract or direct pecuniary interest therein.

(c) Combined interests. It is unlawful for any firm, partnership, association, or corporation, in which any person listed in subsection (a) together with his or her spouse or minor children is entitled to receive (i) more than 15%, in the aggregate, of the total distributable income or (ii) an amount in excess of 2 times the salary of the Governor, to have or acquire any such contract or direct pecuniary interest therein.

(d) Securities. Nothing in this Section invalidates the provisions of any bond or other security previously offered or to be offered for sale or sold by or for the State of Illinois.

(e) Prior interests. This Section does not affect the validity of any contract made between the State and an officer or employee of the State or member of the General Assembly, his or her spouse, minor child or any combination of those persons if that contract was in existence before his or her election or employment as an officer, member, or employee. The contract is voidable, however, if it cannot be completed within 365 days after the officer, member, or employee takes office or is employed.

The current salary of the Governor is \$177,412.00. Sixty percent of the salary is \$106,447.20.

RETURN WITH BID

2. The bidder assures the Department that the award and execution of the contract would not cause a violation of Section 50-13, or that an effective exemption has been issued by the Board of Ethics to any individual subject to the Section 50-13 prohibitions pursuant to the provisions of Section 50-20 of the Code and Executive Order Number 3 (1998). Information concerning the exemption process is available from the Department upon request.

B. Negotiations

1. The Code provides in pertinent part:

Section 50-15. Negotiations.

(a) It is unlawful for any person employed in or on a continual contractual relationship with any of the offices or agencies of State government to participate in contract negotiations on behalf of that office or agency with any firm, partnership, association, or corporation with whom that person has a contract for future employment or is negotiating concerning possible future employment.

2. The bidder assures the Department that the award and execution of the contract would not cause a violation of Section 50-15, and that the bidder has no knowledge of any facts relevant to the kinds of acts prohibited therein.

C. Inducements

1. The Code provides:

Section 50-25. Inducement. Any person who offers or pays any money or other valuable thing to any person to induce him or her not to bid for a State contract or as recompense for not having bid on a State contract is guilty of a Class 4 felony. Any person who accepts any money or other valuable thing for not bidding for a State contract or who withholds a bid in consideration of the promise for the payment of money or other valuable thing is guilty of a Class 4 felony.

2. The bidder assures the Department that the award and execution of the contract would not cause a violation of Section 50-25, and that the bidder has no knowledge of any facts relevant to the kinds of acts prohibited therein.

D. Revolving Door Prohibition

1. The Code provides:

Section 50-30. Revolving door prohibition. CPOs, SPOs, procurement compliance monitors, their designees whose principal duties are directly related to State procurement, and executive officers confirmed by the Senate are expressly prohibited for a period of 2 years after terminating an affected position from engaging in any procurement activity relating to the State agency most recently employing them in an affected position for a period of at least 6 months. The prohibition includes, but is not limited to: lobbying the procurement process; specifying; bidding; proposing bid, proposal, or contract documents; on their own behalf or on behalf of any firm, partnership, association, or corporation. This Section applies only to persons who terminate an affected position on or after January 15, 1999.

2. The bidder assures the Department that the award and execution of the contract would not cause a violation of Section 50-30, and that the bidder has no knowledge of any facts relevant to the kinds of acts prohibited therein.

E. Reporting Anticompetitive Practices

1. The Code provides:

Section 50-40. Reporting anticompetitive practices. When, for any reason, any vendor, bidder, contractor, CPO, SPO, designee, elected official, or State employee suspects collusion or other anticompetitive practice among any bidders, offerors, contractors, proposers, or employees of the State, a notice of the relevant facts shall be transmitted to the Attorney General and the CPO.

2. The bidder assures the Department that it has not failed to report any relevant facts concerning the practices addressed in Section 50-40 which may involve the contract for which the bid is submitted.

F. Confidentiality

1. The Code provides:

Section 50-45. Confidentiality. Any CPO, SPO, designee, or executive officer who willfully uses or allows the use of specifications, competitive bid documents, proprietary competitive information, proposals, contracts, or selection information to compromise the fairness or integrity of the procurement, bidding, or contract process shall be subject to immediate dismissal, regardless of the Personnel code, any contract, or any collective bargaining agreement, and may in addition be subject to criminal prosecution.

2. The bidder assures the Department that it has no knowledge of any fact relevant to the practices addressed in Section 50-45 which may involve the contract for which the bid is submitted.

RETURN WITH BID

G. Insider Information

1. The Code provides:

Section 50-50. Insider information. It is unlawful for any current or former elected or appointed State official or State employee to knowingly use confidential information available only by virtue of that office or employment for actual or anticipated gain for themselves or another person.

2. The bidder assures the Department that it has no knowledge of any facts relevant to the practices addressed in Section 50-50 which may involve the contract for which the bid is submitted.

III. CERTIFICATIONS

The certifications hereinafter made by the bidder are each a material representation of fact upon which reliance is placed should the Department enter into the contract with the bidder. Section 50-2 of the Code provides that every person that has entered into a multi-year contract and every subcontractor with a multi-year subcontract shall certify, by July 1 of each fiscal year covered by the contract after the initial fiscal year, to the responsible CPO whether it continues to satisfy the requirements of Article 50 pertaining to the eligibility for a contract award. If a contractor or subcontractor is not able to truthfully certify that it continues to meet all requirements, it shall provide with its certification a detailed explanation of the circumstances leading to the change in certification status. A contractor or subcontractor that makes a false statement material to any given certification required under Article 50 is, in addition to any other penalties or consequences prescribed by law, subject to liability under the Whistleblower Reward and Protection Act for submission of a false claim.

A. Bribery

1. The Code provides:

Section 50-5. Bribery.

(a) Prohibition. No person or business shall be awarded a contract or subcontract under this Code who:

(1) has been convicted under the laws of Illinois or any other state of bribery or attempting to bribe an officer or employee of the State of Illinois or any other state in that officer's or employee's official capacity; or

(2) has made an admission of guilt of that conduct that is a matter of record but has not been prosecuted for that conduct.

(b) Businesses. No business shall be barred from contracting with any unit of State or local government, or subcontracting under such a contract, as a result of a conviction under this Section of any employee or agent of the business if the employee or agent is no longer employed by the business and:

(1) the business has been finally adjudicated not guilty; or

(2) the business demonstrates to the governmental entity with which it seeks to contract, or which is signatory to the contract which the subcontract relates, and that entity finds that the commission of the offense was not authorized, requested, commanded, or performed by a director, officer, or high managerial agent on behalf of the business as provided in paragraph (2) of subsection (a) of Section 5-4 of the Criminal Code of 1961.

(c) Conduct on behalf of business. For purposes of this Section, when an official, agent, or employee of a business committed the bribery or attempted bribery on behalf of the business and in accordance with the direction or authorization of a responsible official of the business, the business shall be chargeable with the conduct.

(d) Certification. Every bid submitted to and contract executed by the State, and every subcontract subject to Section 20-120 of the Code shall contain a certification by the contractor or the subcontractor, respectively, that the contractor or subcontractor is not barred from being awarded a contract or subcontract under this Section and acknowledges that the CPO may declare the related contract void if any certifications required by this Section are false. A contractor who makes a false statement, material to the certification, commits a Class 3 felony.

2. The contractor or subcontractor certifies that it is not barred from being awarded a contract under Section 50.5.

B. Felons

1. The Code provides:

Section 50-10. Felons. Unless otherwise provided, no person or business convicted of a felony shall do business with the State of Illinois or any State agency, or enter into a subcontract, from the date of conviction until 5 years after the date of completion of the sentence for that felony, unless no person held responsible by a prosecutorial office for the facts upon which the conviction was based continues to have any involvement with the business.

2. Certification. Every bid submitted to and contract executed by the State and every subcontract subject to Section 20-120 of the Code shall contain a certification by the bidder or contractor or subcontractor, respectively, that the bidder, contractor, or subcontractor is not barred from being awarded a contract or subcontract under this Section and acknowledges that the CPO may declare the related contract void if any of the certifications required by this Section are false.

RETURN WITH BID

C. Debt Delinquency

1. The Code provides:

Section 50-11 and 50-12. Debt Delinquency.

The contractor or bidder or subcontractor, respectively, certifies that it, or any affiliate, is not barred from being awarded a contract or subcontract under the Code. Section 50-11 prohibits a person from entering into a contract with a State agency, or entering into a subcontract, if it knows or should know that it, or any affiliate, is delinquent in the payment of any debt to the State as defined by the Debt Collection Board. Section 50-12 prohibits a person from entering into a contract with a State agency, or entering into a subcontract, if it, or any affiliate, has failed to collect and remit Illinois Use Tax on all sales of tangible personal property into the State of Illinois in accordance with the provisions of the Illinois Use Tax Act. The bidder or contractor or subcontractor, respectively, further acknowledges that the CPO may declare the related contract void if this certification is false or if the bidder, contractor, or subcontractor, or any affiliate, is determined to be delinquent in the payment of any debt to the State during the term of the contract.

D. Prohibited Bidders, Contractors and Subcontractors

1. The Code provides:

Section 50-10.5 and 50-60(c). Prohibited bidders, contractors and subcontractors.

The bidder or contractor or subcontractor, respectively, certifies in accordance with 30 ILCS 500/50-10.5 that no officer, director, partner or other managerial agent of the contracting business has been convicted of a felony under the Sarbanes-Oxley Act of 2002 or a Class 3 or Class 2 felony under the Illinois Securities Law of 1953 or if in violation of Subsection (c) for a period of five years from the date of conviction. Every bid submitted to and contract executed by the State and every subcontract subject to Section 20-120 of the Code shall contain a certification by the bidder, contractor, or subcontractor, respectively, that the bidder, contractor, or subcontractor is not barred from being awarded a contract or subcontract under this Section and acknowledges that the CPO shall declare the related contract void if any of the certifications completed pursuant to this Section are false.

E. Section 42 of the Environmental Protection Act

The bidder or contractor or subcontractor, respectively, certifies in accordance with 30 ILCS 500/50-12 that the bidder, contractor, or subcontractor, is not barred from being awarded a contract or entering into a subcontract under this Section which prohibits the bidding on or entering into contracts with the State of Illinois or a State agency, or entering into any subcontract, that is subject to the Code by a person or business found by a court or the Pollution Control Board to have committed a willful or knowing violation of Section 42 of the Environmental Protection Act for a period of five years from the date of the order. The bidder or contractor or subcontractor, respectively, acknowledges that the CPO may declare the contract void if this certification is false.

F. Educational Loan

1. Section 3 of the Educational Loan Default Act provides:

§ 3. No State agency shall contract with an individual for goods or services if that individual is in default, as defined in Section 2 of this Act, on an educational loan. Any contract used by any State agency shall include a statement certifying that the individual is not in default on an educational loan as provided in this Section.

2. The bidder, if an individual as opposed to a corporation, partnership or other form of business organization, certifies that the bidder is not in default on an educational loan as provided in Section 3 of the Act.

G. Bid-Rigging/Bid Rotating

1. Section 33E-11 of the Criminal Code of 1961 provides:

§ 33E-11. (a) Every bid submitted to and public contract executed pursuant to such bid by the State or a unit of local government shall contain a certification by the prime contractor that the prime contractor is not barred from contracting with any unit of State or local government as a result of a violation of either Section 33E-3 or 33E-4 of this Article. The State and units of local government shall provide the appropriate forms for such certification.

(b) A contractor who makes a false statement, material to the certification, commits a Class 3 felony.

A violation of Section 33E-3 would be represented by a conviction of the crime of bid-rigging which, in addition to Class 3 felony sentencing, provides that any person convicted of this offense or any similar offense of any state or the United States which contains the same elements as this offense shall be barred for 5 years from the date of conviction from contracting with any unit of State or local government. No corporation shall be barred from contracting with any unit of State or local government as a result of a conviction under this Section of any employee or agent of such corporation if the employee so convicted is no longer employed by the corporation and: (1) it has been finally adjudicated not guilty or (2) if it demonstrates to the governmental entity with which it seeks to contract and that entity finds that the commission of the offense was neither authorized, requested, commanded, nor performed by a director, officer or a high managerial agent in behalf of the corporation.

RETURN WITH BID

A violation of Section 33E-4 would be represented by a conviction of the crime of bid-rotating which, in addition to Class 2 felony sentencing, provides that any person convicted of this offense or any similar offense of any state or the United States which contains the same elements as this offense shall be permanently barred from contracting with any unit of State or local government. No corporation shall be barred from contracting with any unit of State or local government as a result of a conviction under this Section of any employee or agent of such corporation if the employee so convicted is no longer employed by the corporation and: (1) it has been finally adjudicated not guilty or (2) if it demonstrates to the governmental entity with which it seeks to contract and that entity finds that the commission of the offense was neither authorized, requested, commanded, nor performed by a director, officer or a high managerial agent in behalf of the corporation.

2. The bidder certifies that it is not barred from contracting with the Department by reason of a violation of either Section 33E-3 or Section 33E-4.

H. International Anti-Boycott

1. Section 5 of the International Anti-Boycott Certification Act provides:

§ 5. State contracts. Every contract entered into by the State of Illinois for the manufacture, furnishing, or purchasing of supplies, material, or equipment or for the furnishing of work, labor, or services, in an amount exceeding the threshold for small purchases according to the purchasing laws of this State or \$10,000.00, whichever is less, shall contain certification, as a material condition of the contract, by which the contractor agrees that neither the contractor nor any substantially-owned affiliated company is participating or shall participate in an international boycott in violation of the provisions of the U.S. Export Administration Act of 1979 or the regulations of the U.S. Department of Commerce promulgated under that Act.

2. The bidder makes the certification set forth in Section 5 of the Act.

I. Drug Free Workplace

1. The Illinois "Drug Free Workplace Act" applies to this contract and it is necessary to comply with the provisions of the "Act" if the contractor is a corporation, partnership, or other entity (including a sole proprietorship) which has 25 or more employees.

2. The bidder certifies that if awarded a contract in excess of \$5,000 it will provide a drug free workplace by:

(a) Publishing a statement notifying employees that the unlawful manufacture, distribution, dispensation, possession or use of a controlled substance, including cannabis, is prohibited in the contractor's workplace; specifying the actions that will be taken against employees for violations of such prohibition; and notifying the employee that, as a condition of employment on such contract, the employee shall abide by the terms of the statement, and notify the employer of any criminal drug statute conviction for a violation occurring in the workplace no later than five (5) days after such conviction.

(b) Establishing a drug free awareness program to inform employees about the dangers of drug abuse in the workplace; the contractor's policy of maintaining a drug free workplace; any available drug counseling, rehabilitation, and employee assistance programs; and the penalties that may be imposed upon employees for drug violations.

(c) Providing a copy of the statement required by subparagraph (1) to each employee engaged in the performance of the contract and to post the statement in a prominent place in the workplace.

(d) Notifying the Department within ten (10) days after receiving notice from an employee or otherwise receiving actual notice of the conviction of an employee for a violation of any criminal drug statute occurring in the workplace.

(e) Imposing or requiring, within 30 days after receiving notice from an employee of a conviction or actual notice of such a conviction, an appropriate personnel action, up to and including termination, or the satisfactory participation in a drug abuse assistance or rehabilitation program approved by a federal, state or local health, law enforcement or other appropriate agency.

(f) Assisting employees in selecting a course of action in the event drug counseling, treatment, and rehabilitation is required and indicating that a trained referral team is in place.

(g) Making a good faith effort to continue to maintain a drug free workplace through implementation of the actions and efforts stated in this certification.

RETURN WITH BID

J. Disclosure of Business Operations in Iran

Section 50-36 of the Code, 30ILCS 500/50-36 provides that each bid, offer, or proposal submitted for a State contract shall include a disclosure of whether or not the Company acting as the bidder, offeror, or proposing entity, or any of its corporate parents or subsidiaries, within the 24 months before submission of the bid, offer, or proposal had business operations that involved contracts with or provision of supplies or services to the Government of Iran, companies in which the Government of Iran has any direct or indirect equity share, consortiums or projects commissioned by the Government of Iran, or companies involved in consortiums or projects commissioned by the Government of Iran and either of the following conditions apply:

- (1) More than 10% of the Company's revenues produced in or assets located in Iran involve oil-related activities or mineral-extraction activities; less than 75% of the Company's revenues produced in or assets located in Iran involve contracts with or provision of oil-related or mineral-extraction products or services to the Government of Iran or a project or consortium created exclusively by that government; and the Company has failed to take substantial action.
- (2) The Company has, on or after August 5, 1996, made an investment of \$20 million or more, or any combination of investments of at least \$10 million each that in the aggregate equals or exceeds \$20 million in any 12-month period, which directly or significantly contributes to the enhancement of Iran's ability to develop petroleum resources of Iran.

The terms "Business operations", "Company", "Mineral-extraction activities", "Oil-related activities", "Petroleum resources", and "Substantial action" are all defined in the Code.

Failure to make the disclosure required by the Code shall cause the bid, offer or proposal to be considered not responsive. The disclosure will be considered when evaluating the bid, offer, or proposal or awarding the contract. The name of each Company disclosed as doing business or having done business in Iran will be provided to the State Comptroller.

Check the appropriate statement:

Company has no business operations in Iran to disclose.

Company has business operations in Iran as disclosed the attached document.

K. Apprenticeship and Training Certification (Does not apply to federal aid projects)

In accordance with the provisions of Section 30-22 (6) of the Code, the bidder certifies that it is a participant, either as an individual or as part of a group program, in the approved apprenticeship and training programs applicable to each type of work or craft that the bidder will perform with its own forces. The bidder further certifies for work that will be performed by subcontract that each of its subcontractors submitted for approval either (a) is, at the time of such bid, participating in an approved, applicable apprenticeship and training program; or (b) will, prior to commencement of performance of work pursuant to this contract, begin participation in an approved apprenticeship and training program applicable to the work of the subcontract. The Department, at any time before or after award, may require the production of a copy of each applicable Certificate of Registration issued by the United States Department of Labor evidencing such participation by the contractor and any or all of its subcontractors. Applicable apprenticeship and training programs are those that have been approved and registered with the United States Department of Labor. The bidder shall list in the space below, the official name of the program sponsor holding the Certificate of Registration for all of the types of work or crafts in which the bidder is a participant and that will be performed with the bidder's forces. Types of work or craft work that will be subcontracted shall be included and listed as subcontract work. The list shall also indicate any type of work or craft job category that does not have an applicable apprenticeship or training program. **The bidder is responsible for making a complete report and shall make certain that each type of work or craft job category that will be utilized on the project as reported on the Construction Employee Workforce Projection (Form BC-1256) and returned with the bid is accounted for and listed.**

The requirements of this certification and disclosure are a material part of the contract, and the contractor shall require this certification provision to be included in all approved subcontracts. In order to fulfill this requirement, it shall not be necessary that an applicable program sponsor be currently taking or that it will take applications for apprenticeship, training or employment during the performance of the work of this contract.

TO BE RETURNED WITH BID

L. Political Contributions and Registration with the State Board of Elections

Sections 20-160 and 50-37 of the Code regulate political contributions from business entities and any affiliated entities or affiliated persons bidding on or contracting with the state. Generally under Section 50-37, any business entity, and any affiliated entity or affiliated person of the business entity, whose current year contracts with all state agencies exceed an awarded value of \$50,000, are prohibited from making any contributions to any political committees established to promote the candidacy of the officeholder responsible for the awarding of the contracts or any other declared candidate for that office for the duration of the term of office of the incumbent officeholder or a period 2 years after the termination of the contract, whichever is longer. Any business entity and affiliated entities or affiliated persons whose state contracts in the current year do not exceed an awarded value of \$50,000, but whose aggregate pending bids and proposals on state contracts exceed \$50,000, either alone or in combination with contracts not exceeding \$50,000, are prohibited from making any political contributions to any political committee established to promote the candidacy of the officeholder responsible for awarding the pending contract during the period beginning on the date the invitation for bids or request for proposals is issued and ending on the day after the date of award or selection if the entity was not awarded or selected. Section 20-160 requires certification of registration of affected business entities in accordance with procedures found in Section 9-35 of The Election Code.

By submission of a bid, the contractor business entity acknowledges and agrees that it has read and understands Sections 20-160 and 50-37 of the Code, and that it makes the following certification:

The undersigned business entity certifies that it has registered as a business with the State Board of Elections and acknowledges a continuing duty to update the registration in accordance with the above referenced statutes. If the business entity is required to register, the CPO shall verify that it is in compliance on the date the bid or proposal is due. The CPO shall not accept a bid or proposal if the business entity is not in compliance with the registration requirements.

These requirements and compliance with the above referenced statutory sections are a material part of the contract, and any breach thereof shall be cause to void the contract under Section 50-60 of the Code. This provision does not apply to Federal-aid contracts.

M. Lobbyist Disclosure

Section 50-38 of the Code requires that any bidder or offeror on a State contract that hires a person required to register under the Lobbyist Registration Act to assist in obtaining a contract shall:

- (i) Disclose all costs, fees, compensation, reimbursements, and other remunerations paid or to be paid to the lobbyist related to the contract,
- (ii) Not bill or otherwise cause the State of Illinois to pay for any of the lobbyist's costs, fees, compensation, reimbursements, or other remuneration, and
- (iii) Sign a verification certifying that none of the lobbyist's costs, fees, compensation, reimbursements, or other remuneration were billed to the State.

This information, along with all supporting documents, shall be filed with the agency awarding the contract and with the Secretary of State. The CPO shall post this information, together with the contract award notice, in the online Procurement Bulletin.

Pursuant to Subsection (c) of this Section, no person or entity shall retain a person or entity to attempt to influence the outcome of a procurement decision made under the Code for compensation contingent in whole or in part upon the decision or procurement. Any person who violates this subsection is guilty of a business offense and shall be fined not more than \$10,000.

Bidder acknowledges that it is required to disclose the hiring of any person required to register pursuant to the Illinois Lobbyist Registration Act (25 ILCS 170) in connection with this contract.

Bidder has not hired any person required to register pursuant to the Illinois Lobbyist Registration Act in connection with this contract.

Or

Bidder has hired the following persons required to register pursuant to the Illinois Lobbyist Registration Act in connection with the contract:

Name and address of person: _____
All costs, fees, compensation, reimbursements and other remuneration paid to said person: _____

RETURN WITH BID

IV. DISCLOSURES

- A. The disclosures hereinafter made by the bidder are each a material representation of fact upon which reliance is placed should the Department enter into the contract with the bidder. The bidder further certifies that the Department has received the disclosure forms for each bid.

The CPO may void the bid, or contract, respectively, if it is later determined that the bidder or subcontractor rendered a false or erroneous disclosure. A contractor or subcontractor may be suspended or debarred for violations of the Code. Furthermore, the CPO may void the contract and the surety providing the performance bond shall be responsible for completion of the contract.

B. Financial Interests and Conflicts of Interest

1. Section 50-35 of the Code provides that all bids of more than \$25,000 shall be accompanied by disclosure of the financial interests of the bidder. This disclosed information for the successful bidder, will be maintained as public information subject to release by request pursuant to the Freedom of Information Act, filed with the Procurement Policy Board, and shall be incorporated as a material term of the contract. Furthermore, pursuant to Section 5-5, the Procurement Policy Board may review a proposal, bid, or contract and issue a recommendation to void a contract or reject a proposal or bid based on any violation of the Code or the existence of a conflict of interest as provided in subsections (b) and (d) of Section 50-35.

The financial interests to be disclosed shall include ownership or distributive income share that is in excess of 5%, or an amount greater than 60% of the annual salary of the Governor, of the bidding entity or its parent entity, whichever is less, unless the contractor or bidder is a publicly traded entity subject to Federal 10K reporting, in which case it may submit its 10K disclosure in place of the prescribed disclosure. If a bidder is a privately held entity that is exempt from Federal 10K reporting, but has more than 200 shareholders, it may submit the information that Federal 10K companies are required to report, and list the names of any person or entity holding any ownership share that is in excess of 5%. The disclosure shall include the names, addresses, and dollar or proportionate share of ownership of each person making the disclosure, their instrument of ownership or beneficial relationship, and notice of any potential conflict of interest resulting from the current ownership or beneficial interest of each person making the disclosure having any of the relationships identified in Section 50-35 and on the disclosure form.
The current annual salary of the Governor is \$177,412.00

In addition, all disclosures shall indicate any other current or pending contracts, proposals, leases, or other ongoing procurement relationships the bidding entity has with any other unit of state government and shall clearly identify the unit and the contract, proposal, lease, or other relationship.

2. Disclosure Forms. Disclosure Form A is attached for use concerning the individuals meeting the above ownership or distributive share requirements. A separate Disclosure Form A must be submitted with the bid for each individual meeting the above requirements. In addition, a second form (Disclosure Form B) provides for the disclosure of current or pending procurement relationships with other (non-IDOT) state agencies and a total ownership certification. **The forms must be included with each bid.**

C. Disclosure Form Instructions

Form A Instructions for Financial Information & Potential Conflicts of Interest

If the bidder is a publicly traded entity subject to Federal 10K reporting, the 10K Report may be submitted to meet the requirements of Form A. If a bidder is a privately held entity that is exempt from Federal 10K reporting, but has more than 200 shareholders, it may submit the information that Federal 10K companies are required to report, and list the names of any person or entity holding any ownership share that is in excess of 5%. If a bidder is not subject to Federal 10K reporting, the bidder must determine if any individuals are required by law to complete a financial disclosure form. To do this, the bidder should answer each of the following questions. A "YES" answer indicates Form A must be completed. If the answer to each of the following questions is "NO", then the NOT APPLICABLE STATEMENT on Form A must be signed and dated by a person that is authorized to execute contracts for the bidding company. Note: These questions are for assistance only and are not required to be completed.

1. Does anyone in your organization have a direct or beneficial ownership share of greater than 5% of the bidding entity or parent entity? YES ___ NO ___
2. Does anyone in your organization have a direct or beneficial ownership share of less than 5%, but which has a value greater than 60% of the annual salary of the Governor? YES ___ NO ___
3. Does anyone in your organization receive more than 60% of the annual salary of the Governor of the bidding entity's or parent entity's distributive income? YES ___ NO ___

(Note: Distributive income is, for these purposes, any type of distribution of profits. An annual salary is not distributive income.)

4. Does anyone in your organization receive greater than 5% of the bidding entity's or parent entity's total distributive income, but which is less than 60% of the annual salary of the Governor? YES ___ NO ___

(Note: Only one set of forms needs to be completed per person per bid even if a specific individual would require a yes answer to more than one question.)

A "YES" answer to any of these questions requires the completion of Form A. The bidder must determine each individual in the bidding entity or the bidding entity's parent company that would cause the questions to be answered "Yes". Each form must be signed and dated by a person that is authorized to execute contracts for your organization. **Photocopied or stamped signatures are not acceptable.** The person signing can be, but does not have to be, the person for which the form is being completed. The bidder is responsible for the accuracy of any information provided.

If the answer to each of the above questions is "NO", then the NOT APPLICABLE STATEMENT of Form A must be signed and dated by a person that is authorized to execute contracts for your company.

RETURN WITH BID

Form B: Instructions for Identifying Other Contracts & Procurement Related Information

Disclosure Form B must be completed for each bid submitted by the bidding entity. *Note: Checking the NOT APPLICABLE STATEMENT on Form A does not allow the bidder to ignore Form B. Form B must be completed, checked, and dated or the bidder may be considered nonresponsive and the bid will not be accepted.*

The Bidder shall identify, by checking Yes or No on Form B, whether it has any pending contracts (including leases), bids, proposals, or other ongoing procurement relationship with any other (non-IDOT) State of Illinois agency. If "No" is checked, the bidder only needs to complete the check box on the bottom of Form B. If "Yes" is checked, the bidder must do one of the following:

Option I: If the bidder did not submit an Affidavit of Availability to obtain authorization to bid, the bidder must list all non-IDOT State of Illinois agency pending contracts, leases, bids, proposals, and other ongoing procurement relationships. These items may be listed on Form B or on an attached sheet(s). Do not include IDOT contracts. Contracts with cities, counties, villages, etc. are not considered State of Illinois agency contracts and are not to be included. Contracts with other State of Illinois agencies such as the Department of Natural Resources or the Capital Development Board must be included. Bidders who submit Affidavits of Availability are suggested to use Option II.

Option II: If the bidder is required and has submitted an Affidavit of Availability in order to obtain authorization to bid, the bidder may write or type "See Affidavit of Availability" which indicates that the Affidavit of Availability is incorporated by reference and includes all non-IDOT State of Illinois agency pending contracts, leases, bids, proposals, and other ongoing procurement relationships. For any contracts that are not covered by the Affidavit of Availability, the bidder must identify them on Form B or on an attached sheet(s). These might be such things as leases.

**ILLINOIS DEPARTMENT
OF TRANSPORTATION**

**Form A
Financial Information &
Potential Conflicts of Interest
Disclosure**

Contractor Name		
Legal Address		
City, State, Zip		
Telephone Number	Email Address	Fax Number (if available)

Disclosure of the information contained in this Form is required by the Section 50-35 of the Code (30 ILCS 500). Vendors desiring to enter into a contract with the State of Illinois must disclose the financial information and potential conflict of interest information as specified in this Disclosure Form. This information shall become part of the publicly available contract file. This Form A must be completed for bids in excess of \$25,000, and for all open-ended contracts. **A publicly traded company may submit a 10K disclosure (or equivalent if applicable) in satisfaction of the requirements set forth in Form A. See Disclosure Form Instructions.**

The current annual salary of the Governor is \$177,412.00.

DISCLOSURE OF FINANCIAL INFORMATION

1. Disclosure of Financial Information. The individual named below has an interest in the BIDDER (or its parent) in terms of ownership or distributive income share in excess of 5%, or an interest which has a value of more than 60% of the annual salary of the Governor. **(Make copies of this form as necessary and attach a separate Disclosure Form A for each individual meeting these requirements)**

FOR INDIVIDUAL (type or print information)	
NAME:	_____
ADDRESS	_____
Type of ownership/distributable income share:	
stock _____ sole proprietorship _____ Partnership _____ other: (explain on separate sheet):	
% or \$ value of ownership/distributable income share:	_____

2. Disclosure of Potential Conflicts of Interest. Check "Yes" or "No" to indicate which, if any, of the following potential conflict of interest relationships apply. If the answer to any question is "Yes", please attach additional pages and describe.

(a) State employment, currently or in the previous 3 years, including contractual employment of services. Yes ___ No ___

If your answer is yes, please answer each of the following questions.

1. Are you currently an officer or employee of either the Capitol Development Board or the Illinois State Toll Highway Authority? Yes ___ No ___

2. Are you currently appointed to or employed by any agency of the State of Illinois? If you are currently appointed to or employed by any agency of the State of Illinois, and your annual salary exceeds 60% of the annual salary of the Governor, provide the name the State agency for which you are employed and your annual salary. _____

RETURN WITH BID

3. If you are currently appointed to or employed by any agency of the State of Illinois, and your annual salary exceeds 60% of the annual salary of the Governor, are you entitled to receive (i) more than 7 1/2% of the total distributable income of your firm, partnership, association or corporation, or (ii) an amount in excess of 100% of the annual salary of the Governor?
Yes ___ No ___

4. If you are currently appointed to or employed by any agency of the State of Illinois, and your annual salary exceeds 60% of the annual salary of the Governor, are you and your spouse or minor children entitled to receive (i) more than 15 % in the aggregate of the total distributable income of your firm, partnership, association or corporation, or (ii) an amount in excess of two times the salary of the Governor?
Yes ___ No ___

(b) State employment of spouse, father, mother, son, or daughter, including contractual employment services in the previous 2 years.

Yes ___ No ___

If your answer is yes, please answer each of the following questions.

1. Is your spouse or any minor children currently an officer or employee of the Capitol Development Board or the Illinois State Toll Highway Authority?
Yes ___ No ___

2. Is your spouse or any minor children currently appointed to or employed by any agency of the State of Illinois? If your spouse or minor children is/are currently appointed to or employed by any agency of the State of Illinois, and his/her annual salary exceeds 60% of the annual salary of the Governor, provide the name of your spouse and/or minor children, the name of the State agency for which he/she is employed and his/her annual salary. _____

3. If your spouse or any minor children is/are currently appointed to or employed by any agency of the State of Illinois, and his/her annual salary exceeds 60% of the annual salary of the Governor, are you entitled to receive (i) more than 7 1/2% of the total distributable income of your firm, partnership, association or corporation, or (ii) an amount in excess of 100% of the annual salary of the Governor?
Yes ___ No ___

4. If your spouse or any minor children are currently appointed to or employed by any agency of the State of Illinois, and his/her annual salary exceeds 60% of the annual salary of the Governor, are you and your spouse or minor children entitled to receive (i) more than 15 % in the aggregate of the total distributable income of your firm, partnership, association or corporation, or (ii) an amount in excess of 2 times the salary of the Governor?
Yes ___ No ___

(c) Elective status; the holding of elective office of the State of Illinois, the government of the United States, any unit of local government authorized by the Constitution of the State of Illinois or the statutes of the State of Illinois currently or in the previous 3 years.
Yes ___ No ___

(d) Relationship to anyone holding elective office currently or in the previous 2 years; spouse, father, mother, son, or daughter.
Yes ___ No ___

(e) Appointive office; the holding of any appointive government office of the State of Illinois, the United States of America, or any unit of local government authorized by the Constitution of the State of Illinois or the statutes of the State of Illinois, which office entitles the holder to compensation in excess of the expenses incurred in the discharge of that office currently or in the previous 3 years.
Yes ___ No ___

(f) Relationship to anyone holding appointive office currently or in the previous 2 years; spouse, father, mother, son, or daughter.
Yes ___ No ___

(g) Employment, currently or in the previous 3 years, as or by any registered lobbyist of the State government.
Yes ___ No ___

RETURN WITH BID

(h) Relationship to anyone who is or was a registered lobbyist in the previous 2 years; spouse, father, mother, son, or daughter. Yes ___ No ___

(i) Compensated employment, currently or in the previous 3 years, by any registered election or reelection committee registered with the Secretary of State or any county clerk of the State of Illinois, or any political action committee registered with either the Secretary of State or the Federal Board of Elections. Yes ___ No ___

(j) Relationship to anyone; spouse, father, mother, son, or daughter; who was a compensated employee in the last 2 years by any registered election or re-election committee registered with the Secretary of State or any county clerk of the State of Illinois, or any political action committee registered with either the Secretary of State or the Federal Board of Elections. Yes ___ No ___

3. Communication Disclosure.

Disclose the name and address of each lobbyist and other agent of the bidder or offeror who is not identified in Section 2 of this form, who is has communicated, is communicating, or may communicate with any State officer or employee concerning the bid or offer. This disclosure is a continuing obligation and must be promptly supplemented for accuracy throughout the process and throughout the term of the contract. If no person is identified, enter "None" on the line below:

Name and address of person(s): _____

RETURN WITH BID

4. Debarment Disclosure. For each of the persons identified under Sections 2 and 3 of this form, disclose whether any of the following has occurred within the previous 10 years: debarment from contracting with any governmental entity; professional licensure discipline; bankruptcies; adverse civil judgments and administrative findings; and criminal felony convictions. This disclosure is a continuing obligation and must be promptly supplemented for accuracy throughout the procurement process and term of the contract. If no person is identified, enter "None" on the line below:

Name of person(s): _____

Nature of disclosure: _____

APPLICABLE STATEMENT

This Disclosure Form A is submitted on behalf of the INDIVIDUAL named on previous page. Under penalty of perjury, I certify the contents of this disclosure to be true and accurate to the best of my knowledge.

Completed by: _____ Date _____
Signature of Individual or Authorized Representative

NOT APPLICABLE STATEMENT

Under penalty of perjury, I have determined that no individuals associated with this organization meet the criteria that would require the completion of this Form A.

This Disclosure Form A is submitted on behalf of the CONTRACTOR listed on the previous page.

_____ Date _____
Signature of Authorized Representative

The bidder has a continuing obligation to supplement these disclosures under Sec. 50-35 of the Code.

RETURN WITH BID

ILLINOIS DEPARTMENT OF TRANSPORTATION

Form B Other Contracts & Financial Related Information Disclosure

Contractor Name, Legal Address, City, State, Zip, Telephone Number, Email Address, Fax Number (if available)

Disclosure of the information contained in this Form is required by the Section 50-35 of the Code (30 ILCS 500). This information shall become part of the publicly available contract file. This Form B must be completed for bids in excess of \$25,000, and for all open-ended contracts.

DISCLOSURE OF OTHER CONTRACTS AND PROCUREMENT RELATED INFORMATION

1. Identifying Other Contracts & Procurement Related Information. The BIDDER shall identify whether it has any pending contracts (including leases), bids, proposals, or other ongoing procurement relationship with any other State of Illinois agency: Yes ___ No ___

If "No" is checked, the bidder only needs to complete the signature box on the bottom of this page.

2. If "Yes" is checked. Identify each such relationship by showing State of Illinois agency name and other descriptive information such as bid or project number (attach additional pages as necessary). SEE DISCLOSURE FORM INSTRUCTIONS:

THE FOLLOWING STATEMENT MUST BE CHECKED

Signature of Authorized Representative, Date

OWNERSHIP CERTIFICATION

Please certify that the following statement is true if the individuals for all submitted Form A disclosures do not total 100% of ownership.

Any remaining ownership interest is held by individuals receiving less than \$106,447.20 of the bidding entity's or parent entity's distributive income or holding less than a 5% ownership interest.

Yes No N/A (Form A disclosure(s) established 100% ownership)

RETURN WITH BID

SPECIAL NOTICE TO CONTRACTORS

The following requirements of the Illinois Department of Human Rights' Rules and Regulations are applicable to bidders on all construction contracts advertised by the Illinois Department of Transportation:

CONSTRUCTION EMPLOYEE UTILIZATION PROJECTION

- (a) All bidders on construction contracts shall complete and submit, along with and as part of their bids, a Bidder's Employee Utilization Form (Form BC-1256) setting forth a projection and breakdown of the total workforce intended to be hired and/or allocated to such contract work by the bidder including a projection of minority and female employee utilization in all job classifications on the contract project.
- (b) The Department of Transportation shall review the Employee Utilization Form, and workforce projections contained therein, of the contract awardee to determine if such projections reflect an underutilization of minority persons and/or women in any job classification in accordance with the Equal Employment Opportunity Clause and Section 7.2 of the Illinois Department of Human Rights' Rules and Regulations for Public Contracts adopted as amended on September 17, 1980. If it is determined that the contract awardee's projections reflect an underutilization of minority persons and/or women in any job classification, it shall be advised in writing of the manner in which it is underutilizing and such awardee shall be considered to be in breach of the contract unless, prior to commencement of work on the contract project, it submits revised satisfactory projections or an acceptable written affirmative action plan to correct such underutilization including a specific timetable geared to the completion stages of the contract.
- (c) The Department of Transportation shall provide to the Department of Human Rights a copy of the contract awardee's Employee Utilization Form, a copy of any required written affirmative action plan, and any written correspondence related thereto. The Department of Human Rights may review and revise any action taken by the Department of Transportation with respect to these requirements.

RETURN WITH BID

**Contract No. 64J11
WINNEBAGO County
Section D2 PATCHING 2013-1
Route FAI 39
District 2 Construction Funds**

PART II. WORKFORCE PROJECTION - continued

- B. Included in "Total Employees" under Table A is the total number of **new hires** that would be employed in the event the undersigned bidder is awarded this contract.

The undersigned bidder projects that: (number) _____ new hires would be recruited from the area in which the contract project is located; and/or (number) _____ new hires would be recruited from the area in which the bidder's principal office or base of operation is located.

- C. Included in "Total Employees" under Table A is a projection of numbers of persons to be employed directly by the undersigned bidder as well as a projection of numbers of persons to be employed by subcontractors.

The undersigned bidder estimates that (number) _____ persons will be directly employed by the prime contractor and that (number) _____ persons will be employed by subcontractors.

PART III. AFFIRMATIVE ACTION PLAN

- A. The undersigned bidder understands and agrees that in the event the foregoing minority and female employee utilization projection included under **PART II** is determined to be an underutilization of minority persons or women in any job category, and in the event that the undersigned bidder is awarded this contract, he/she will, prior to commencement of work, develop and submit a written Affirmative Action Plan including a specific timetable (geared to the completion stages of the contract) whereby deficiencies in minority and/or female employee utilization are corrected. Such Affirmative Action Plan will be subject to approval by the contracting agency and the **Department of Human Rights**.
- B. The undersigned bidder understands and agrees that the minority and female employee utilization projection submitted herein, and the goals and timetable included under an Affirmative Action Plan if required, are deemed to be part of the contract specifications.

Company _____ Telephone Number _____

Address _____

NOTICE REGARDING SIGNATURE

The Bidder's signature on the Proposal Signature Sheet will constitute the signing of this form. The following signature block needs to be completed if revisions are required.

Signature: _____ Title: _____ Date: _____

- Instructions: All tables must include subcontractor personnel in addition to prime contractor personnel.
- Table A - Include both the number of employees that would be hired to perform the contract work and the total number currently employed (Table B) that will be allocated to contract work, and include all apprentices and on-the-job trainees. The "Total Employees" column should include all employees including all minorities, apprentices and on-the-job trainees to be employed on the contract work.
 - Table B - Include all employees currently employed that will be allocated to the contract work including any apprentices and on-the-job trainees currently employed.
 - Table C - Indicate the racial breakdown of the total apprentices and on-the-job trainees shown in Table A.

RETURN WITH BID

Contract No. 64J11

WINNEBAGO County

Section D2 PATCHING 2013-1

Route FAI 39

District 2 Construction Funds

PROPOSAL SIGNATURE SHEET

The undersigned bidder hereby makes and submits this bid on the subject Proposal, thereby assuring the Department that all requirements of the Invitation for Bids and rules of the Department have been met, that there is no misunderstanding of the requirements of paragraph 3 of this Proposal, and that the contract will be executed in accordance with the rules of the Department if an award is made on this bid.

(IF AN INDIVIDUAL) Firm Name _____
Signature of Owner _____
Business Address _____

(IF A CO-PARTNERSHIP) Firm Name _____
By _____
Business Address _____
Name and Address of All Members of the Firm:

(IF A CORPORATION)
(IF A JOINT VENTURE, USE THIS SECTION FOR THE MANAGING PARTY AND THE SECOND PARTY SHOULD SIGN BELOW) Corporate Name _____
By _____
Signature of Authorized Representative _____
Typed or printed name and title of Authorized Representative _____
Attest _____
Signature _____
Business Address _____

(IF A JOINT VENTURE) Corporate Name _____
By _____
Signature of Authorized Representative _____
Typed or printed name and title of Authorized Representative _____
Attest _____
Signature _____
Business Address _____

If more than two parties are in the joint venture, please attach an additional signature sheet.



Return with Bid

Division of Highways
Proposal Bid Bond
(Effective November 1, 1992)

Item No.
Letting Date

KNOW ALL MEN BY THESE PRESENTS, That We

as PRINCIPAL, and

as SURETY, are held jointly, severally and firmly bound unto the STATE OF ILLINOIS in the penal sum of 5 percent of the total bid price, or for the amount specified in the bid proposal under "Proposal Guaranty" in effect on the date of the Invitation for Bids, whichever is the lesser sum, well and truly to be paid unto said STATE OF ILLINOIS, for the payment of which we bind ourselves, our heirs, executors, administrators, successors and assigns.

THE CONDITION OF THE FOREGOING OBLIGATION IS SUCH, that whereas, the PRINCIPAL has submitted a bid proposal to the STATE OF ILLINOIS, acting through the Department of Transportation, for the improvement designated by the Transportation Bulletin Item Number and Letting Date indicated above.

NOW, THEREFORE, if the Department shall accept the bid proposal of the PRINCIPAL; and if the PRINCIPAL shall, within the time and as specified in the bidding and contract documents, submit a DBE Utilization Plan that is accepted and approved by the Department; and if, after award by the Department, the PRINCIPAL shall enter into a contract in accordance with the terms of the bidding and contract documents including evidence of the required insurance coverages and providing such bond as specified with good and sufficient surety for the faithful performance of such contract and for the prompt payment of labor and material furnished in the prosecution thereof; or if, in the event of the failure of the PRINCIPAL to make the required DBE submission or to enter into such contract and to give the specified bond, the PRINCIPAL pays to the Department the difference not to exceed the penalty hereof between the amount specified in the bid proposal and such larger amount for which the Department may contract with another party to perform the work covered by said bid proposal, then this obligation shall be null and void, otherwise, it shall remain in full force and effect.

IN THE EVENT the Department determines the PRINCIPAL has failed to comply with any requirement as set forth in the preceding paragraph, then Surety shall pay the penal sum to the Department within fifteen (15) days of written demand therefor. If Surety does not make full payment within such period of time, the Department may bring an action to collect the amount owed. Surety is liable to the Department for all its expenses, including attorney's fees, incurred in any litigation in which it prevails either in whole or in part.

In TESTIMONY WHEREOF, the said PRINCIPAL and the said SURETY have caused this instrument to be signed by their respective officers this day of A.D.,

PRINCIPAL SURETY
(Company Name) (Company Name)
By (Signature & Title) By: (Signature of Attorney-in-Fact)

Notary Certification for Principal and Surety

STATE OF ILLINOIS,
County of
I, a Notary Public in and for said County, do hereby certify that
and
(Insert names of individuals signing on behalf of PRINCIPAL & SURETY)

who are each personally known to me to be the same persons whose names are subscribed to the foregoing instrument on behalf of PRINCIPAL and SURETY, appeared before me this day in person and acknowledged respectively, that they signed and delivered said instrument as their free and voluntary act for the uses and purposes therein set forth.

Given under my hand and notarial seal this day of A.D.

My commission expires Notary Public

In lieu of completing the above section of the Proposal Bid Form, the Principal may file an Electronic Bid Bond. By signing the proposal and marking the check box next to the Signature and Title line below, the Principal is ensuring the identified electronic bid bond has been executed and the Principal and Surety are firmly bound unto the State of Illinois under the conditions of the bid bond as shown above.

Electronic Bid Bond ID# Company / Bidder Name Signature and Title

(1) Policy

It is public policy that disadvantageded businesses as defined in 49 CFR Part 26 and the Special Provision shall have the maximum opportunity to participate in the performance of contracts financed in whole or in part with Federal or State funds. Consequently the requirements of 49 CFR Part 26 apply to this contract.

(2) Obligation

The contractor agrees to ensure that disadvantageded businesses as defined in 49 CFR Part 26 and the Special Provision have the maximum opportunity to participate in the performance of contracts or subcontracts financed in whole or in part with Federal or State funds. The contractor shall take all necessary and reasonable steps in accordance with 49 CFR Part 26 and the Special Provision to ensure that said businesses have the maximum opportunity to compete for and perform under this contract. The contractor shall not discriminate on the basis of race, color, national origin or sex in the award and performance of contracts.

(3) Project and Bid Identification

Complete the following information concerning the project and bid:

Route _____

Section _____

Project _____

County _____

Letting Date _____

Contract No. _____

Letting Item No. _____

Total Bid _____

Contract DBE Goal _____

(Percent) (Dollar Amount)

(4) Assurance

I, acting in my capacity as an officer of the undersigned bidder (or bidders if a joint venture), hereby assure the Department that on this project my company : (check one)

- Meets or exceeds contract award goals and has provided documented participation as follows:
Disadvantaged Business Participation _____ percent

Attached are the signed participation statements, forms SBE 2025, required by the Special Provision evidencing availability and use of each business participating in this plan and assuring that each business will perform a commercially useful function in the work of the contract.

- Failed to meet contract award goals and has included good faith effort documentation to meet the goals and that my company has provided participation as follows:
Disadvantaged Business Participation _____ percent

The contract goals should be accordingly modified or waived. Attached is all information required by the Special Provision in support of this request including good faith effort. Also attached are the signed participation statements, forms SBE 2025, required by the Special Provision evidencing availability and use of each business participating in this plan and assuring that each business will perform a commercially useful function in the work of the contract.

Company

By _____

Title _____

Date _____

The "as read" Low Bidder is required to comply with the Special Provision.

Submit only one utilization plan for each project. The utilization plan shall be submitted in accordance with the special provision.

Bureau of Small Business Enterprises **Local Let Projects**
2300 South Dirksen Parkway Submit forms to the
Springfield, Illinois 62764 Local Agency



Subcontractor Registration _____

Letting _____

Participation Statement

Item No. _____

(1) Instructions

Contract _____

This form must be completed for each disadvantaged business participating in the Utilization Plan. This form shall be submitted in accordance with the special provision and will be attached to the Utilization Plan form. If additional space is needed complete an additional form for the firm.

(2) Work

Pay Item No.	Description	Quantity	Unit Price	Total
Total				

(3) Partial Payment Items

For any of the above items which are partial pay items, specifically describe the work and subcontract dollar amount:

(4) Commitment

The undersigned certify that the information included herein is true and correct, and that the DBE firm listed below has agreed to perform a commercially useful function in the work of the contract item(s) listed above and to execute a contract with the prime contractor. The undersigned further understand that no changes to this statement may be made without prior approval from the Department's Bureau of Small Business Enterprises and that complete and accurate information regarding actual work performed on this project and the payment therefore must be provided to the Department.

Signature for Prime Contractor

Signature for DBE Firm

Title _____

Title _____

Date _____

Date _____

Contact _____

Contact _____

Phone _____

Phone _____

Firm Name _____

Firm Name _____

Address _____

Address _____

City/State/Zip _____

City/State/Zip _____

E _____

WC _____

The Department of Transportation is requesting disclosure of information that is necessary to accomplish the statutory purpose as outlined under the state and federal law. Disclosure of this information is **REQUIRED**. Failure to provide any information will result in the contract not being awarded. This form has been approved by the State Forms Management Center.

PROPOSAL ENVELOPE



PROPOSALS

for construction work advertised for bids by the
Illinois Department of Transportation

Item No.	Item No.	Item No.

Submitted By:

Name:
Address:
Phone No.

Bidders should use an IDOT proposal envelope or affix this form to the front of a 10" x 13" envelope for the submittal of bids. If proposals are mailed, they should be enclosed in a second or outer envelope addressed to:

Engineer of Design and Environment - Room 326
Illinois Department of Transportation
2300 South Dirksen Parkway
Springfield, Illinois 62764

NOTICE

Individual bids, including Bid Bond and/or supplemental information if required, should be securely stapled.

CONTRACTOR OFFICE COPY OF CONTRACT SPECIFICATIONS

NOTICE

None of the following material needs to be returned with the bid package unless the special provisions require documentation and/or other information to be submitted.

**Contract No. 64J11
WINNEBAGO County
Section D2 PATCHING 2013-1
Route FAI 39
District 2 Construction Funds**



Illinois Department of Transportation

SUBCONTRACTOR DOCUMENTATION

Public Acts 96-0795, 96-0920, and 97-0895 enacted substantial changes to the provisions of the Code (30 ILCS 500). Among the changes are provisions affecting subcontractors. The Contractor awarded this contract will be required as a material condition of the contract to implement and enforce the contract requirements applicable to subcontractors that entered into a contractual agreement with a total value of \$50,000 or more with a person or entity who has a contract subject to the Code and approved in accordance with article 108.01 of the Standard Specifications for Road and Bridge Construction.

If the Contractor seeks approval of subcontractors to perform a portion of the work, and approval is granted by the Department, the Contractor shall provide a copy of the subcontract to the Illinois Department of Transportation's CPO upon request within 15 calendar days after execution of the subcontract.

Financial disclosures required pursuant to Sec. 50-35 of the Code must be submitted for all applicable subcontractors. The subcontract shall contain the certifications required to be made by subcontractors pursuant to Article 50 of the Code. This Notice to Bidders includes a document incorporating all required subcontractor certifications and disclosures for use by the Contractor in compliance with this mandate. The document is entitled State Required Ethical Standards Governing Subcontractors.

RETURN WITH SUBCONTRACT

STATE ETHICAL STANDARDS GOVERNING SUBCONTRACTORS

Article 50 of the Code establishes the duty of all State CPOs, SPOs, and their designees to maximize the value of the expenditure of public moneys in procuring goods, services, and contracts for the State of Illinois and to act in a manner that maintains the integrity and public trust of State government. In discharging this duty, they are charged by law to use all available information, reasonable efforts, and reasonable actions to protect, safeguard, and maintain the procurement process of the State of Illinois.

The certifications hereinafter made by the subcontractor are each a material representation of fact upon which reliance is placed should the Department approve the subcontractor. The CPO may terminate or void the contract approval if it is later determined that the bidder or subcontractor rendered a false or erroneous certification. If a false certification is made by a subcontractor the contractor's submitted bid and the executed contract may not be declared void unless the contractor refuses to terminate the subcontract upon the State's request after a finding that the subcontractor's certification was false.

Section 50-2 of the Code provides that every person that has entered into a multi-year contract and every subcontractor with a multi-year subcontract shall certify, by July 1 of each fiscal year covered by the contract after the initial fiscal year, to the responsible CPO whether it continues to satisfy the requirements of Article 50 pertaining to the eligibility for a contract award. If a contractor or subcontractor is not able to truthfully certify that it continues to meet all requirements, it shall provide with its certification a detailed explanation of the circumstances leading to the change in certification status. A contractor or subcontractor that makes a false statement material to any given certification required under Article 50 is, in addition to any other penalties or consequences prescribed by law, subject to liability under the Whistleblower Reward and Protection Act for submission of a false claim.

A. Bribery

1. The Code provides:

Section 50-5. Bribery.

(a) Prohibition. No person or business shall be awarded a contract or subcontract under this Code who:

(1) has been convicted under the laws of Illinois or any other state of bribery or attempting to bribe an officer or employee of the State of Illinois or any other state in that officer's or employee's official capacity; or

(2) has made an admission of guilt of that conduct that is a matter of record but has not been prosecuted for that conduct.

(b) Businesses. No business shall be barred from contracting with any unit of State or local government, or subcontracting under such a contract, as a result of a conviction under this Section of any employee or agent of the business if the employee or agent is no longer employed by the business and:

(1) the business has been finally adjudicated not guilty; or

(2) the business demonstrates to the governmental entity with which it seeks to contract, or which is signatory to the contract to which the subcontract relates, and that entity finds that the commission of the offense was not authorized, requested, commanded, or performed by a director, officer, or high managerial agent on behalf of the business as provided in paragraph (2) of subsection (a) of Section 5-4 of the Criminal Code of 1961.

(c) Conduct on behalf of business. For purposes of this Section, when an official, agent, or employee of a business committed the bribery or attempted bribery on behalf of the business and in accordance with the direction or authorization of a responsible official of the business, the business shall be chargeable with the conduct.

(d) Certification. Every bid submitted to and contract executed by the State, and every subcontract subject to Section 20-120 of the Code shall contain a certification by the contractor or the subcontractor, respectively, that the contractor or subcontractor is not barred from being awarded a contract or subcontract under this Section and acknowledges that the CPO may declare the related contract void if any certifications required by this Section are false. A contractor who makes a false statement, material to the certification, commits a Class 3 felony.

2. The contractor or subcontractor certifies that it is not barred from being awarded a contract under Section 50.5.

B. Felons

1. The Code provides:

Section 50-10. Felons. Unless otherwise provided, no person or business convicted of a felony shall do business with the State of Illinois or any State agency, or enter into a subcontract, from the date of conviction until 5 years after the date of completion of the sentence for that felony, unless no person held responsible by a prosecutorial office for the facts upon which the conviction was based continues to have any involvement with the business.

2. Certification. Every bid submitted to and contract executed by the State and every subcontract subject to Section 20-120 of the Code shall contain a certification by the bidder or contractor or subcontractor, respectively, that the bidder, contractor, or subcontractor is not barred from being awarded a contract or subcontract under this Section and acknowledges that the CPO may declare the related contract void if any of the certifications required by this Section are false.

RETURN WITH SUBCONTRACT

C. Debt Delinquency

1. The Code provides:

Section 50-11 and 50-12. Debt Delinquency.

The contractor or bidder or subcontractor, respectively, certifies that it, or any affiliate, is not barred from being awarded a contract or subcontract under the Code. Section 50-11 prohibits a person from entering into a contract with a State agency, or entering into a subcontract, if it knows or should know that it, or any affiliate, is delinquent in the payment of any debt to the State as defined by the Debt Collection Board. Section 50-12 prohibits a person from entering into a contract with a State agency, or entering into a subcontract, if it, or any affiliate, has failed to collect and remit Illinois Use Tax on all sales of tangible personal property into the State of Illinois in accordance with the provisions of the Illinois Use Tax Act. The bidder or contractor or subcontractor, respectively, further acknowledges that the CPO may declare the related contract void if this certification is false or if the bidder, contractor, or subcontractor, or any affiliate, is determined to be delinquent in the payment of any debt to the State during the term of the contract.

D. Prohibited Bidders, Contractors and Subcontractors

1. The Code provides:

Section 50-10.5 and 50-60(c). Prohibited bidders, contractors and subcontractors.

The bidder or contractor or subcontractor, respectively, certifies in accordance with 30 ILCS 500/50-10.5 that no officer, director, partner or other managerial agent of the contracting business has been convicted of a felony under the Sarbanes-Oxley Act of 2002 or a Class 3 or Class 2 felony under the Illinois Securities Law of 1953 or if in violation of Subsection (c) for a period of five years from the date of conviction. Every bid submitted to and contract executed by the State and every subcontract subject to Section 20-120 of the Code shall contain a certification by the bidder, contractor, or subcontractor, respectively, that the bidder, contractor, or subcontractor is not barred from being awarded a contract or subcontract under this Section and acknowledges that the CPO shall declare the related contract void if any of the certifications completed pursuant to this Section are false.

E. Section 42 of the Environmental Protection Act

The bidder or contractor or subcontractor, respectively, certifies in accordance with 30 ILCS 500/50-12 that the bidder, contractor, or subcontractor, is not barred from being awarded a contract or entering into a subcontract under this Section which prohibits the bidding on or entering into contracts with the State of Illinois or a State agency, or entering into any subcontract, that is subject to the Code by a person or business found by a court or the Pollution Control Board to have committed a willful or knowing violation of Section 42 of the Environmental Protection Act for a period of five years from the date of the order. The bidder or contractor or subcontractor, respectively, acknowledges that the CPO may declare the contract void if this certification is false.

The undersigned, on behalf of the subcontracting company, has read and understands the above certifications and makes the certifications as required by law.

Name of Subcontracting Company

Authorized Officer

Date

RETURN WITH SUBCONTRACT
SUBCONTRACTOR DISCLOSURES

I. DISCLOSURES

- A.** The disclosures hereinafter made by the subcontractor are each a material representation of fact upon which reliance is placed. The subcontractor further certifies that the Department has received the disclosure forms for each subcontract.

The CPO may void the bid, contract, or subcontract, respectively, if it is later determined that the bidder or subcontractor rendered a false or erroneous disclosure. A contractor or subcontractor may be suspended or debarred for violations of the Code. Furthermore, the CPO may void the contract.

B. Financial Interests and Conflicts of Interest

1. Section 50-35 of the Code provides that all subcontracts with a total value of \$50,000 or more from subcontractors identified in Section 20-120 of the Code, shall be accompanied by disclosure of the financial interests of the subcontractor. This disclosed information for the subcontractor, will be maintained as public information subject to release by request pursuant to the Freedom of Information Act, filed with the Procurement Policy Board, and shall be incorporated as a material term of the Prime Contractor's contract. Furthermore, pursuant to this Section, the Procurement Policy Board may recommend to allow or void a contract or subcontract based on a potential conflict of interest.

The financial interests to be disclosed shall include ownership or distributive income share that is in excess of 5%, or an amount greater than 60% of the annual salary of the Governor, of the subcontracting entity or its parent entity, whichever is less, unless the subcontractor is a publicly traded entity subject to Federal 10K reporting, in which case it may submit its 10K disclosure in place of the prescribed disclosure. If a subcontractor is a privately held entity that is exempt from Federal 10K reporting, but has more than 200 shareholders, it may submit the information that Federal 10K companies are required to report, and list the names of any person or entity holding any ownership share that is in excess of 5%. The disclosure shall include the names, addresses, and dollar or proportionate share of ownership of each person making the disclosure, their instrument of ownership or beneficial relationship, and notice of any potential conflict of interest resulting from the current ownership or beneficial interest of each person making the disclosure having any of the relationships identified in Section 50-35 and on the disclosure form.

The current annual salary of the Governor is \$177,412.00.

In addition, all disclosures shall indicate any other current or pending contracts, subcontracts, proposals, leases, or other ongoing procurement relationships the subcontracting entity has with any other unit of state government and shall clearly identify the unit and the contract, subcontract, proposal, lease, or other relationship.

2. Disclosure Forms. Disclosure Form A is attached for use concerning the individuals meeting the above ownership or distributive share requirements. A separate Disclosure Form A must be submitted with the bid for each individual meeting the above requirements. In addition, a second form (Disclosure Form B) provides for the disclosure of current or pending procurement relationships with other (non-IDOT) state agencies and a total ownership certification. **The forms must be included with each bid.**

C. Disclosure Form Instructions

Form A Instructions for Financial Information & Potential Conflicts of Interest

If the subcontractor is a publicly traded entity subject to Federal 10K reporting, the 10K Report may be submitted to meet the requirements of Form A. If a subcontractor is a privately held entity that is exempt from Federal 10K reporting, but has more than 200 shareholders, it may submit the information that Federal 10K companies are required to report, and list the names of any person or entity holding any ownership share that is in excess of 5%. If a subcontractor is not subject to Federal 10K reporting, the subcontractor must determine if any individuals are required by law to complete a financial disclosure form. To do this, the subcontractor should answer each of the following questions. A "YES" answer indicates Form A must be completed. If the answer to each of the following questions is "NO", then the **NOT APPLICABLE STATEMENT** on the second page of Form A must be signed and dated by a person that is authorized to execute contracts for the subcontracting company. Note: These questions are for assistance only and are not required to be completed.

1. Does anyone in your organization have a direct or beneficial ownership share of greater than 5% of the bidding entity or parent entity? YES ___ NO ___
2. Does anyone in your organization have a direct or beneficial ownership share of less than 5%, but which has a value greater than 60% of the annual salary of the Governor? YES ___ NO ___
3. Does anyone in your organization receive more than 60% of the annual salary of the Governor of the subcontracting entity's or parent entity's distributive income? YES ___ NO ___

(Note: Distributive income is, for these purposes, any type of distribution of profits. An annual salary is not distributive income.)

4. Does anyone in your organization receive greater than 5% of the subcontracting entity's or parent entity's total distributive income, but which is less than 60% of the annual salary of the Governor? YES ___ NO ___

(Note: Only one set of forms needs to be completed per person per subcontract even if a specific individual would require a yes answer to more than one question.)

A "YES" answer to any of these questions requires the completion of Form A. The subcontractor must determine each individual in the subcontracting entity or the subcontracting entity's parent company that would cause the questions to be answered "Yes". Each form must be signed and dated by a person that is authorized to execute contracts for your organization. **Photocopied or stamped signatures are not acceptable.** The person signing can be, but does not have to be, the person for which the form is being completed. The subcontractor is responsible for the accuracy of any information provided.

If the answer to each of the above questions is "NO", then the **NOT APPLICABLE STATEMENT** on page 2 of Form A must be signed and dated by a person that is authorized to execute contracts for your company.

RETURN WITH SUBCONTRACT

Form B: Instructions for Identifying Other Contracts & Procurement Related Information

Disclosure Form B must be completed for each subcontract submitted by the subcontracting entity. *Note: Checking the NOT APPLICABLE STATEMENT on Form A does not allow the subcontractor to ignore Form B. Form B must be completed, checked, and dated or the subcontract will not be approved.*

The Subcontractor shall identify, by checking Yes or No on Form B, whether it has any pending contracts, subcontracts, leases, bids, proposals, or other ongoing procurement relationship with any other (non-IDOT) State of Illinois agency. If "No" is checked, the subcontractor only needs to complete the check box on the bottom of Form B. If "Yes" is checked, the subcontractor must list all non-IDOT State of Illinois agency pending contracts, subcontracts, leases, bids, proposals, and other ongoing procurement relationships. These items may be listed on Form B or on an attached sheet(s). Contracts with cities, counties, villages, etc. are not considered State of Illinois agency contracts and are not to be included. Contracts or subcontracts with other State of Illinois agencies such as the Department of Natural Resources or the Capital Development Board must be included.

**ILLINOIS DEPARTMENT
OF TRANSPORTATION**

**Form A
Subcontractor: Financial
Information & Potential Conflicts
of Interest Disclosure**

Subcontractor Name		
Legal Address		
City, State, Zip		
Telephone Number	Email Address	Fax Number (if available)

Disclosure of the information contained in this Form is required by the Section 50-35 of the Code (30 ILCS 500). Subcontractors desiring to enter into a subcontract of a State of Illinois contract must disclose the financial information and potential conflict of interest information as specified in this Disclosure Form. This information shall become part of the publicly available contract file. This Form A must be completed for subcontracts with a total value of \$50,000 or more, from subcontractors identified in Section 20-120 of the Code, and for all open-ended contracts. **A publicly traded company may submit a 10K disclosure (or equivalent if applicable) in satisfaction of the requirements set forth in Form A. See Disclosure Form Instructions.**

The current annual salary of the Governor is \$177,412.00.

DISCLOSURE OF FINANCIAL INFORMATION

1. Disclosure of Financial Information. The individual named below has an interest in the SUBCONTRACTOR (or its parent) in terms of ownership or distributive income share in excess of 5%, or an interest which has a value of more than 60% of the annual salary of the Governor. **(Make copies of this form as necessary and attach a separate Disclosure Form A for each individual meeting these requirements)**

FOR INDIVIDUAL (type or print information)	
NAME:	_____
ADDRESS	_____
Type of ownership/distributable income share:	
stock _____ sole proprietorship _____ Partnership _____ other: (explain on separate sheet):	
% or \$ value of ownership/distributable income share:	_____

2. Disclosure of Potential Conflicts of Interest. Check "Yes" or "No" to indicate which, if any, of the following potential conflict of interest relationships apply. If the answer to any question is "Yes", please attach additional pages and describe.

(a) State employment, currently or in the previous 3 years, including contractual employment of services. Yes ___ No ___

If your answer is yes, please answer each of the following questions.

1. Are you currently an officer or employee of either the Capitol Development Board or the Illinois State Toll Highway Authority? Yes ___ No ___

2. Are you currently appointed to or employed by any agency of the State of Illinois? If you are currently appointed to or employed by any agency of the State of Illinois, and your annual salary exceeds 60% of the annual salary of the Governor, provide the name the State agency for which you are employed and your annual salary. _____

RETURN WITH SUBCONTRACT

3. If you are currently appointed to or employed by any agency of the State of Illinois, and your annual salary exceeds 60% of the annual salary of the Governor, are you entitled to receive (i) more than 7 1/2% of the total distributable income of your firm, partnership, association or corporation, or (ii) an amount in excess of 100% of the annual salary of the Governor?
Yes ___ No ___

4. If you are currently appointed to or employed by any agency of the State of Illinois, and your annual salary exceeds 60% of the annual salary of the Governor, are you and your spouse or minor children entitled to receive (i) more than 15 % in the aggregate of the total distributable income of your firm, partnership, association or corporation, or (ii) an amount in excess of two times the salary of the Governor?
Yes ___ No ___

(b) State employment of spouse, father, mother, son, or daughter, including contractual employment services in the previous 2 years.

Yes ___ No ___

If your answer is yes, please answer each of the following questions.

1. Is your spouse or any minor children currently an officer or employee of the Capitol Development Board or the Illinois Toll Highway Authority?
Yes ___ No ___

2. Is your spouse or any minor children currently appointed to or employed by any agency of the State of Illinois? If your spouse or minor children is/are currently appointed to or employed by any agency of the State of Illinois, and his/her annual salary exceeds 60% of the annual salary of the Governor, provide the name of your spouse and/or minor children, the name of the State agency for which he/she is employed and his/her annual salary. _____

3. If your spouse or any minor children is/are currently appointed to or employed by any agency of the State of Illinois, and his/her annual salary exceeds 60% of the annual salary of the Governor, as of 7/1/07) are you entitled to receive (i) more then 7 1/2% of the total distributable income of your firm, partnership, association or corporation, or (ii) an amount in excess of 100% of the annual salary of the Governor?
Yes ___ No ___

4. If your spouse or any minor children are currently appointed to or employed by any agency of the State of Illinois, and his/her annual salary exceeds 60% of the annual salary of the Governor, are you and your spouse or minor children entitled to receive (i) more than 15 % in the aggregate of the total distributable income of your firm, partnership, association or corporation, or (ii) an amount in excess of two times the annual salary of the Governor?
Yes ___ No ___

(c) Elective status; the holding of elective office of the State of Illinois, the government of the United States, any unit of local government authorized by the Constitution of the State of Illinois or the statutes of the State of Illinois currently or in the previous 3 years.
Yes ___ No ___

(d) Relationship to anyone holding elective office currently or in the previous 2 years; spouse, father, mother, son, or daughter.
Yes ___ No ___

(e) Appointive office; the holding of any appointive government office of the State of Illinois, the United States of America, or any unit of local government authorized by the Constitution of the State of Illinois or the statutes of the State of Illinois, which office entitles the holder to compensation in excess of the expenses incurred in the discharge of that office currently or in the previous 3 years.
Yes ___ No ___

(f) Relationship to anyone holding appointive office currently or in the previous 2 years; spouse, father, mother, son, or daughter.
Yes ___ No ___

(g) Employment, currently or in the previous 3 years, as or by any registered lobbyist of the State government.
Yes ___ No ___

RETURN WITH SUBCONTRACT

(h) Relationship to anyone who is or was a registered lobbyist in the previous 2 years; spouse, father, mother, son, or daughter. Yes ___ No ___

(i) Compensated employment, currently or in the previous 3 years, by any registered election or reelection committee registered with the Secretary of State or any county clerk of the State of Illinois, or any political action committee registered with either the Secretary of State or the Federal Board of Elections. Yes ___ No ___

(j) Relationship to anyone; spouse, father, mother, son, or daughter; who was a compensated employee in the last 2 years by any registered election or re-election committee registered with the Secretary of State or any county clerk of the State of Illinois, or any political action committee registered with either the Secretary of State or the Federal Board of Elections. Yes ___ No ___

3 Communication Disclosure.

Disclose the name and address of each lobbyist and other agent of the bidder or offeror who is not identified in Section 2 of this form, who is has communicated, is communicating, or may communicate with any State officer or employee concerning the bid or offer. This disclosure is a continuing obligation and must be promptly supplemented for accuracy throughout the process and throughout the term of the contract. If no person is identified, enter "None" on the line below:

Name and address of person(s): _____

RETURN WITH SUBCONTRACT

4. Debarment Disclosure. For each of the persons identified under Sections 2 and 3 of this form, disclose whether any of the following has occurred within the previous 10 years: debarment from contracting with any governmental entity; professional licensure discipline; bankruptcies; adverse civil judgments and administrative findings; and criminal felony convictions. This disclosure is a continuing obligation and must be promptly supplemented for accuracy throughout the procurement process and term of the contract. If no person is identified, enter "None" on the line below:

Name of person(s): _____

Nature of disclosure: _____

APPLICABLE STATEMENT

This Disclosure Form A is submitted on behalf of the INDIVIDUAL named on previous page. Under penalty of perjury, I certify the contents of this disclosure to be true and accurate to the best of my knowledge.

Completed by: _____ Date _____
Signature of Individual or Authorized Officer

NOT APPLICABLE STATEMENT

Under penalty of perjury, I have determined that no individuals associated with this organization meet the criteria that would require the completion of this Form A.

This Disclosure Form A is submitted on behalf of the SUBCONTRACTOR listed on the previous page.

_____ Date _____
Signature of Authorized Officer

RETURN WITH SUBCONTRACT

ILLINOIS DEPARTMENT OF TRANSPORTATION

Form B
Subcontractor: Other Contracts & Financial Related Information Disclosure

Form with fields: Subcontractor Name, Legal Address, City, State, Zip, Telephone Number, Email Address, Fax Number (if available)

Disclosure of the information contained in this Form is required by the Section 50-35 of the Code (30 ILCS 500). This information shall become part of the publicly available contract file. This Form B must be completed for subcontracts with a total value of \$50,000 or more, from subcontractors identified in Section 20-120 of the Code, and for all open-ended contracts.

DISCLOSURE OF OTHER CONTRACTS, SUBCONTRACTS, AND PROCUREMENT RELATED INFORMATION

1. Identifying Other Contracts & Procurement Related Information. The SUBCONTRACTOR shall identify whether it has any pending contracts, subcontracts, including leases, bids, proposals, or other ongoing procurement relationship with any other State of Illinois agency: Yes ___ No ___

If "No" is checked, the subcontractor only needs to complete the signature box on the bottom of this page.

2. If "Yes" is checked. Identify each such relationship by showing State of Illinois agency name and other descriptive information such as bid or project number (attach additional pages as necessary). SEE DISCLOSURE FORM INSTRUCTIONS:

THE FOLLOWING STATEMENT MUST BE CHECKED

Signature box with fields: Signature of Authorized Representative, Date

OWNERSHIP CERTIFICATION

Please certify that the following statement is true if the individuals for all submitted Form A disclosures do not total 100% of ownership

Any remaining ownership interest is held by individuals receiving less than \$106,447.20 of the bidding entity's or parent entity's distributive income or holding less than a 5% ownership interest.

Yes No N/A (Form A disclosure(s) established 100% ownership)



- 1. TIME AND PLACE OF OPENING BIDS.** Sealed proposals for the improvement described herein will be received by the Department of Transportation at the Harry R. Hanley Building, 2300 South Dirksen Parkway, in Springfield, Illinois until 10:00 o'clock a.m., November 9, 2012. All bids will be gathered, sorted, publicly opened and read in the auditorium at the Department of Transportation's Harry R. Hanley Building shortly after the 10:00 a.m. cut off time.
- 2. DESCRIPTION OF WORK.** The proposed improvement is identified and advertised for bids in the Invitation for Bids as:

**Contract No. 64J11
WINNEBAGO County
Section D2 PATCHING 2013-1
Route FAI 39
District 2 Construction Funds**

Pavement patching and HMA surface on the I-39 Interchange ramps at Baxter Rd. in Winnebago County.

- 3. INSTRUCTIONS TO BIDDERS.** (a) This Notice, the invitation for bids, proposal and letter of award shall, together with all other documents in accordance with Article 101.09 of the Standard Specifications for Road and Bridge Construction, become part of the contract. Bidders are cautioned to read and examine carefully all documents, to make all required inspections, and to inquire or seek explanation of the same prior to submission of a bid.

(b) State law, and, if the work is to be paid wholly or in part with Federal-aid funds, Federal law requires the bidder to make various certifications as a part of the proposal and contract. By execution and submission of the proposal, the bidder makes the certification contained therein. A false or fraudulent certification shall, in addition to all other remedies provided by law, be a breach of contract and may result in termination of the contract.
- 4. AWARD CRITERIA AND REJECTION OF BIDS.** This contract will be awarded to the lowest responsive and responsible bidder considering conformity with the terms and conditions established by the Department in the rules, Invitation for Bids and contract documents. The issuance of plans and proposal forms for bidding based upon a prequalification rating shall not be the sole determinant of responsibility. The Department reserves the right to determine responsibility at the time of award, to reject any or all proposals, to readvertise the proposed improvement, and to waive technicalities.

By Order of the
Illinois Department of Transportation

Ann L. Schneider,
Secretary

INDEX
FOR
SUPPLEMENTAL SPECIFICATIONS
AND RECURRING SPECIAL PROVISIONS

Adopted January 1, 2012

This index contains a listing of SUPPLEMENTAL SPECIFICATIONS and frequently used RECURRING SPECIAL PROVISIONS.

SUPPLEMENTAL SPECIFICATIONS

Std. Spec. Sec.

Page No.

No Supplemental Specifications this year.

RECURRING SPECIAL PROVISIONS

The following RECURRING SPECIAL PROVISIONS indicated by an "X" are applicable to this contract and are included by reference:

<u>CHECK SHEET #</u>	<u>PAGE NO.</u>
1	1
2	4
3 X	5
4 X	15
5 X	20
6	25
7	26
8	27
9	28
10	31
11	34
12	36
13	40
14	42
15	43
16	45
17	46
18	48
19	49
20	50
21	54
22	56
23	58
24	60
25	61
26	62
27	63
28	64
29	65
30	68
31	76

TABLE OF CONTENTS

LOCATION OF PROJECT	1
DESCRIPTION OF PROJECT	1
TRAFFIC CONTROL PLAN	1
GEOTECHNICAL REINFORCEMENT	4
ADJUSTED PLAN QUANTITY FOR SURFACE COURSE MIXTURES	5
TRAFFIC CONTROL SURVEILLANCE	6
AGREEMENT TO PLAN QUANTITY (BDE).....	6
CONCRETE MIX DESIGN – DEPARTMENT PROVIDED (BDE).....	6
CONSTRUCTION AIR QUALITY - DIESEL VEHICLE EMISSIONS CONTROL (BDE)	6
CONSTRUCTION AIR QUALITY - IDLING RESTRICTIONS (BDE).....	8
DISADVANTAGED BUSINESS ENTERPRISE PARTICIPATION (BDE)	9
ERRATA FOR THE 2012 STANDARD SPECIFICATIONS (BDE).....	18
FRICTION AGGREGATE (BDE)	18
PAVEMENT PATCHING (BDE).....	22
PAYMENTS TO SUBCONTRACTORS (BDE)	22
PAYROLLS AND PAYROLL RECORDS (BDE).....	23
PORTLAND CEMENT CONCRETE (BDE)	24
QUALITY CONTROL/QUALITY ASSURANCE OF CONCRETE MIXTURES (BDE)	58
RECLAIMED ASPHALT PAVEMENT AND RECLAIMED ASPHALT SHINGLES (BDE)	70
REMOVAL AND DISPOSAL OF REGULATED SUBSTANCES (BDE)	80
REMOVAL AND DISPOSAL OF SURPLUS MATERIALS (BDE)	84
SUBCONTRACTOR MOBILIZATION PAYMENTS (BDE).....	85
TRACKING THE USE OF PESTICIDES (BDE).....	85
TRAFFIC CONTROL DEFICIENCY DEDUCTION (BDE).....	85
UTILITY COORDINATION AND CONFLICTS (BDE).....	86
WARM MIX ASPHALT (BDE).....	91
WEEKLY DBE TRUCKING REPORTS (BDE).....	95
WORKING DAYS (BDE).....	96

STATE OF ILLINOIS

SPECIAL PROVISIONS

The following Special Provisions supplement the "Standard Specifications for Road and Bridge Construction," adopted January 1, 2012, the latest edition of the "Manual on Uniform Traffic Control Devices for Streets and Highways," and the "Manual of Test Procedures for Materials" in effect on the date of invitation for bids, and the Supplemental Specifications and Recurring Special Provisions indicated on the Check Sheet included herein which apply to and govern the construction of FAI 39 (I-39), Section D2 Patching 2013-1, Winnebago County, Contract 64J11, and in case of conflict with any part or parts of said Specifications, the said Special Provisions shall take precedence and shall govern.

LOCATION OF PROJECT

The I-39 off ramp from I-39 (SB) to Baxter Road, and the I-39 on ramp from Baxter Road to I-39 (SB).

DESCRIPTION OF PROJECT

Pavement patching and hot-mix asphalt shoulders on the SB off ramp and SB on ramp.

TRAFFIC CONTROL PLAN

Effective January 14, 1999

Traffic Control shall be according to the applicable sections of the Standard Specifications for Road and Bridge Construction, the applicable guidelines contained in the National Manual on Uniform Traffic Control Devices for Streets and Highways, Illinois Supplement to the National Manual on Uniform Traffic Control Devices, these special provisions, and any special details and Highway Standards contained herein and in the plans.

Special attention is called to Articles 107.09 and 107.14 of the Standard Specifications for Road and Bridge Construction and the following Highway Standards relating to traffic control.

Standards:

701006 701011 701201 701311 701326 701456
701901

Details:

Signs:

No bracing shall be allowed on post-mounted signs.

Post-mounted signs shall be installed using standard 720011, 728001, 729001, on 4"x4" wood posts, or on any other "break away" connection if accepted by the FHWA and corresponding letter is provided to the resident.

"LOW SHOULDER" W8-9(O)48 signs shall be installed at 1 mile intervals or as directed by the Engineer.

When covering existing Department signs, no tape shall be used on the reflective portion of the sign. Contact the District sign shop for covering techniques.

All regulatory signs shall be maintained at a 5 foot minimum bottom (rural), 7 foot minimum (urban).

Plate altering signs shall have the same sheeting as the base sign.

No more than one (1) plate shall be used to alter a sign.

Any post stubs without a sign in place and visible shall have a reflector placed on each post.

Devices:

A minimum of 3 drums spaced at 4 feet shall be placed at each return when the sideroad is open.

On all standards, the device spacing shall be revised to the following dimensions:

Where the spacing shown on the standard is 25 feet, the devices shall be placed at 20 feet.

Where the spacing shown on the standard is 50 feet, the devices shall be placed at 40 feet.

Where the spacing shown on the standard is 100 feet, the devices shall be placed at 80 feet.

Flaggers:

Flagger at Sideroads and Commercial Entrances:

Effective: August 1, 2011

Flaggers shall comply with all requirements contained in the Department's "Flagger Handbook" dated September 2011. The flagger equipment listed for flaggers employed by the Illinois Department of Transportation shall apply to all flaggers.

All workers and flaggers shall wear ANSI Class E pants and an ANSI Class 2 vest that in combination meet the requirements of ANSI/ISEA 107-2004 for Conspicuity Class 3 garments during hours of darkness.

In addition to the flaggers shown on applicable standards, on major sideroads flaggers shall be required on all legs of the intersection. Major sideroad for this project shall be Baxter Road.

When the mainline flagger is within 200 feet of an intersection, the sideroad flagger shall be required.

When the road is closed to through traffic and it is necessary to provide access for local traffic, all flaggers as shown on the applicable standards will be required. No reduction in the number of flaggers shall be allowed.

Revise the first and second paragraph of Article 701.20(i) of the Standard Specifications to read:

“Signs, barricades, or other traffic control devices required by the Engineer, over and above those shown on the standard or detailed in the plans and provisions, will be paid for according to Article 109.04. All flaggers required at sideroads and commercial entrances remaining open to traffic not shown on the Highway Standards, required by article 701.13(a) or listed above, shall be paid for according to Article 109.04.”

Traffic Control and Protection, Standard 701326: This work shall be done according to Section 701 of the Standard Specifications and the Typical Applications of Traffic Control Devices for Highway Construction, Standard 701326, and as specified herein.

Additional barricades, flagger signs, Yield or Stop signs and flaggers shall be required at the intersections. Barricade spacing shall be at 15 foot centers within these intersections and Yield or Stop signs shall be used to control traffic.

When work is within 200 feet of an intersection, flagger signs and flaggers shall be required on the sideroad at the discretion of the Engineer.

These additional devices shall be paid for as part of Traffic Control and Protection 701326 and not as an addition to the contract.

Maintenance of Traffic: The patching on the ramps shall be staged so that the ramps are kept open to one-way traffic at all times.

The Contractor shall be required to notify the Winnebago County Highway Department, the corresponding Township Commissioner, emergency response agencies (i.e.: fire, ambulance, police), school bus companies and the Department of Transportation (Bureau of Project Implementation) regarding any changes in traffic control.

The pavement patch removal and replacement shall be completed using Traffic Control and Protection Standard 701456.

The striping shall be completed using Traffic Control and Protection Standard 701311.

The shoulder removal and replacement shall be completed using Traffic Control and Protection Standard 701326 and 701456 on the ramps, and Traffic Control and Protection Standard 701201 on Baxter Road.

GEOTECHNICAL REINFORCEMENT

Effective: November 30, 2010

Biaxial Geogrid Flat Installation

This work consists of furnishing and installing an integrally-formed polypropylene geotechnical grid reinforcement material. The geogrid shall have an aperture, rib and junction cross section sufficient to permit significant mechanical interlock with the material being reinforced. There shall be a high continuity of tensile strength through all ribs and junctions of the grid material to reinforce the subbase or subgrade as shown on the plans and specifications.

MATERIAL CHARACTERISTICS	TEST METHOD	DATA
polymer type		polypropylene
carbon black content	ASTM D 4218	0.50% (min.)

DIMENSIONAL CHARACTERISTICS	TEST METHOD	UNIT	DATA
open area	CW 02215	%	75 (max.)
unit weight	ASTM D 5261	oz/yd ²	5.0 (min.)

TECHNICAL CHARACTERISTICS	TEST METHOD	UNIT	DATA
junction efficiency	GRI-GG2	%	90 (min.)

The supplier should provide a certification that their product meets the above requirements.

The geotechnical reinforcement shall be placed as described herein or as shown on the cross sections.

Geogrid shall be delivered to the jobsite in such a manner as to facilitate handling and incorporation into the work without damage. Material shall be stored in such a manner as to prevent exposure to direct sunlight and damage by other construction activities.

Prior to the installation of the geogrid, the application surface shall be cleared of debris, sharp objects and trees. Tree stumps shall be cut to the level of the ground surface. If the stumps cannot be cut to the ground level, they shall be completely removed. In the case of subgrades, all wheel tracks or ruts in excess of 3 inches in depth shall be graded smooth or otherwise filled with soil to provide a reasonably smooth surface.

The geotechnical reinforcement shall be placed with the “roll length” parallel to the pavement. Fabric of insufficient width or length to fully cover the specified area shall be lapped a minimum of 24 inches. The geogrid should be secured in place.

Installation:

The granular blanket shall be constructed to the width and depth required on the plans. Unless otherwise specified, the material shall be back-dumped on the Geogrid in a sequence of operations beginning at the outer edges of the treatment area with subsequent placement towards the middle.

Placement of material on the Geogrid shall be accomplished by spreading dumped material off of previously placed material with a bulldozer blade or endloader, in such a manner as to prevent tearing or shoving of the Geogrid. Dumping of material directly on the Geogrid will only be permitted to establish an initial working platform. No construction equipment shall be allowed on the Geogrid prior to placement of the granular blanket. If the geogrid develops wrinkles or moves significantly, an alternative method of securing it shall be used.

Unless otherwise specified in the plans or Special Provisions, the granular material, shall be placed to the full required thickness and compacted to the satisfaction of the Engineer.

Geogrid which is damaged during installation or subsequent placement of granular material, due to failure of the Contractor to comply with these provisions, shall be repaired or replaced at his expense, including costs of removal and replacement of the granular material.

Torn Geogrid may be patched in-place by cutting and placing a piece of the same Geogrid over the tear. The dimensions of the patch shall be at least 2 feet larger than the largest dimension of the tear and it shall be weighted or otherwise secured to prevent the granular material from causing lap separation.

Method of Measurement: Geotechnical Reinforcement will be measured in square yards for the surface area placed. The excavation, replacement and compaction of the granular layer shall be paid for separately.

Basis of Payment: This work will be measured in place and the area computed in square yards. The work will be paid for at the contract unit price per Square Yard for GEOTECHNICAL REINFORCEMENT.

ADJUSTED PLAN QUANTITY FOR SURFACE COURSE MIXTURES

Effective: June 15, 2010

The adjusted plan quantity for surface course mixtures shall be calculated according to Article 406.13(b) and the following. The maximum allowed average bulk specific gravity for the approved mix design (Gmb) will be:

2.460 for Mixture C

2.470 for Mixture D

2.610 for Mixture E

2.710 for Mixture F

TRAFFIC CONTROL SURVEILLANCE

Effective: January 1, 2011

Revise the first sentence of the first paragraph of Article 701.10 of the Standard Specifications to read:

“When open holes, broken pavement, trenches over 3 in. deep and 4 in. wide or other hazards are present within 8 ft of the edge of an open lane, the Contractor shall furnish traffic control surveillance at all times, whether or not the Contractor is engaged in construction operations.”

AGREEMENT TO PLAN QUANTITY (BDE)

Effective: January 1, 2012

Revise the second paragraph of Article 202.07(a) of the Standard Specifications to read:

“When the plans or work have been altered, or when disagreement exists between the Contractor and the Engineer as to the accuracy of the plan quantities, either party shall, before any work is started which would affect the measurement, have the right to request in writing and thereby cause the quantities involved to be measured. When plan quantities are revised by the issuance of revised plan sheets that are made part of the contract, and the Contractor and the Engineer have agreed in writing that the revised quantities are accurate, no further measurement will be required and payment will be made for the revised quantities shown.”

CONCRETE MIX DESIGN – DEPARTMENT PROVIDED (BDE)

Effective: January 1, 2012

For the “Portland Cement Concrete (BDE)” special provision included in this project, specifically Article 1020.05(a), the Contractor has the option to request the Engineer determine mix design material proportions for Class PV, PP, RR, BS, DS, SC, and SI concrete. A single mix design for each class of concrete will be provided. Acceptance by the Contractor to use the mix design developed by the Engineer shall not relieve the Contractor from meeting specification requirements.

CONSTRUCTION AIR QUALITY - DIESEL VEHICLE EMISSIONS CONTROL (BDE)

Effective: April 1, 2009

Revised: January 2, 2012

Diesel Vehicle Emissions Control. The reduction of construction air emissions shall be accomplished by using cleaner burning diesel fuel. The term “equipment” refers to any and all diesel fuel powered devices rated at 50 hp and above, to be used on the project site in excess of seven calendar days over the course of the construction period on the project site (including any “rental” equipment).

All equipment on the jobsite, with engine ratings of 50 hp and above, shall be required to: use Ultra Low Sulfur Diesel fuel (ULSD) exclusively (15 ppm sulfur content or less).

Diesel powered equipment in non-compliance will not be allowed to be used on the project site, and is also subject to a notice of non-compliance as outlined below.

The Contractor shall certify that only ULSD will be used in all jobsite equipment. The certification shall be presented to the Department prior to the commencement of the work.

If any diesel powered equipment is found to be in non-compliance with any portion of this specification, the Engineer will issue the Contractor a notice of non-compliance and identify an appropriate period of time, as outlined below under environmental deficiency deduction, in which to bring the equipment into compliance or remove it from the project site.

Any costs associated with bringing any diesel powered equipment into compliance with these diesel vehicle emissions controls shall be considered as included in the contract unit prices bid for the various items of work involved and no additional compensation will be allowed. The Contractor's compliance with this notice and any associated regulations shall also not be grounds for a claim.

Environmental Deficiency Deduction. When the Engineer is notified, or determines that an environmental control deficiency exists, he/she will notify the Contractor in writing, and direct the Contractor to correct the deficiency within a specified time period. The specified time-period, which begins upon Contractor notification, will be from 1/2 hour to 24 hours long, based on the urgency of the situation and the nature of the deficiency. The Engineer shall be the sole judge regarding the time period.

The deficiency will be based on lack of repair, maintenance and diesel vehicle emissions control.

If the Contractor fails to correct the deficiency within the specified time frame, a daily monetary deduction will be imposed for each calendar day or fraction thereof the deficiency continues to exist. The calendar day(s) will begin when the time period for correction is exceeded and end with the Engineer's written acceptance of the correction. The daily monetary deduction will be \$1,000.00 for each deficiency identified.

If a Contractor or subcontractor accumulates three environmental deficiency deductions in a contract period, the Contractor will be shutdown until the deficiency is corrected. Such a shutdown will not be grounds for any extension of contract time, waiver of penalties, or be grounds for any claim.

CONSTRUCTION AIR QUALITY - IDLING RESTRICTIONS (BDE)

Effective: April 1, 2009

Idling Restrictions. The Contractor shall establish truck-staging areas for all diesel powered vehicles that are waiting to load or unload material at the jobsite. Staging areas shall be located where the diesel emissions from the equipment will have a minimum impact on adjacent sensitive receptors. The Department will review the selection of staging areas, whether within or outside the existing highway right-of-way, to avoid locations near sensitive areas or populations to the extent possible. Sensitive receptors include, but are not limited to, hospitals, schools, residences, motels, hotels, daycare facilities, elderly housing and convalescent facilities. Diesel powered engines shall also be located as far away as possible from fresh air intakes, air conditioners, and windows. The Engineer will approve staging areas before implementation.

Diesel powered vehicle operators may not cause or allow the motor vehicle, when it is not in motion, to idle for more than a total of 10 minutes within any 60 minute period, except under any of the following circumstances:

- 1) The motor vehicle has a gross vehicle weight rating of less than 8000 lb (3630 kg).
- 2) The motor vehicle idles while forced to remain motionless because of on-highway traffic, an official traffic control device or signal, or at the direction of a law enforcement official.
- 3) The motor vehicle idles when operating defrosters, heaters, air conditioners, or other equipment solely to prevent a safety or health emergency.
- 4) A police, fire, ambulance, public safety, other emergency or law enforcement motor vehicle, or any motor vehicle used in an emergency capacity, idles while in an emergency or training mode and not for the convenience of the vehicle operator.
- 5) The primary propulsion engine idles for maintenance, servicing, repairing, or diagnostic purposes if idling is necessary for such activity.
- 6) A motor vehicle idles as part of a government inspection to verify that all equipment is in good working order, provided idling is required as part of the inspection.
- 7) When idling of the motor vehicle is required to operate auxiliary equipment to accomplish the intended use of the vehicle (such as loading, unloading, mixing, or processing cargo; controlling cargo temperature; construction operations, lumbering operations; oil or gas well servicing; or farming operations), provided that this exemption does not apply when the vehicle is idling solely for cabin comfort or to operate non-essential equipment such as air conditioning, heating, microwave ovens, or televisions.
- 8) When the motor vehicle idles due to mechanical difficulties over which the operator has no control.
- 9) The outdoor temperature is less than 32 °F (0 °C) or greater than 80 °F (26 °C).

When the outdoor temperature is greater than or equal to 32 °F (0 °C) or less than or equal to 80 °F (26 °C), a person who operates a motor vehicle operating on diesel fuel shall not cause or allow the motor vehicle to idle for a period greater than 30 minutes in any 60 minute period while waiting to weigh, load, or unload cargo or freight, unless the vehicle is in a line of vehicles that regularly and periodically moves forward.

The above requirements do not prohibit the operation of an auxiliary power unit or generator set as an alternative to idling the main engine of a motor vehicle operating on diesel fuel.

Environmental Deficiency Deduction. When the Engineer is notified, or determines that an environmental control deficiency exists based on non-compliance with the idling restrictions, he/she will notify the Contractor, and direct the Contractor to correct the deficiency.

If the Contractor fails to correct the deficiency a monetary deduction will be imposed. The monetary deduction will be \$1,000.00 for each deficiency identified.

DISADVANTAGED BUSINESS ENTERPRISE PARTICIPATION (DBE)

Effective: September 1, 2000

Revised: August 2, 2011

FEDERAL OBLIGATION. The Department of Transportation, as a recipient of federal financial assistance, is required to take all necessary and reasonable steps to ensure nondiscrimination in the award and administration of contracts. Consequently, the federal regulatory provisions of 49 CFR Part 26 apply to this contract concerning the utilization of disadvantaged business enterprises. For the purposes of this Special Provision, a disadvantaged business enterprise (DBE) means a business certified by the Department in accordance with the requirements of 49 CFR Part 26 and listed in the Illinois Unified Certification Program (IL UCP) DBE Directory.

STATE OBLIGATION. This Special Provision will also be used by the Department to satisfy the requirements of the Business Enterprise for Minorities, Females, and Persons with Disabilities Act, 30 ILCS 575. When this Special Provision is used to satisfy state law requirements on 100 percent state-funded contracts, the federal government has no involvement in such contracts (not a federal-aid contract) and no responsibility to oversee the implementation of this Special Provision by the Department on those contracts. DBE participation on 100 percent state-funded contracts will not be credited toward fulfilling the Department's annual overall DBE goal required by the US Department of Transportation to comply with the federal DBE program requirements.

CONTRACTOR ASSURANCE. The Contractor makes the following assurance and agrees to include the assurance in each subcontract that the Contractor signs with a subcontractor.

The Contractor, subrecipient, or subcontractor shall not discriminate on the basis of race, color, national origin, or sex in the performance of this contract. The Contractor shall carry out applicable requirements of 49 CFR Part 26 in the award and administration of contracts funded in whole or in part with federal or state funds. Failure by the Contractor to carry out these requirements is a material breach of this contract, which may result in the termination of this contract or such other remedy as the recipient deems appropriate.

OVERALL GOAL SET FOR THE DEPARTMENT. As a requirement of compliance with 49 CFR Part 26, the Department has set an overall goal for DBE participation in its federally assisted contracts. That goal applies to all federal-aid funds the Department will expend in its federally assisted contracts for the subject reporting fiscal year. The Department is required to make a good faith effort to achieve the overall goal. The dollar amount paid to all approved DBE companies performing work called for in this contract is eligible to be credited toward fulfillment of the Department's overall goal.

CONTRACT GOAL TO BE ACHIEVED BY THE CONTRACTOR. This contract includes a specific DBE utilization goal established by the Department. The goal has been included because the Department has determined that the work of this contract has subcontracting opportunities that may be suitable for performance by DBE companies. The determination is based on an assessment of the type of work, the location of the work, and the availability of DBE companies to do a part of the work. The assessment indicates that, in the absence of unlawful discrimination, and in an arena of fair and open competition, DBE companies can be expected to perform 0.00% of the work. This percentage is set as the DBE participation goal for this contract. Consequently, in addition to the other award criteria established for this contract, the Department will only award this contract to a bidder who makes a good faith effort to meet this goal of DBE participation in the performance of the work. A bidder makes a good faith effort for award consideration if either of the following is done in accordance with the procedures set for in this Special Provision:

- (a) The bidder documents that enough DBE participation has been obtained to meet the goal: or
- (b) The bidder documents that a good faith effort has been made to meet the goal, even though the effort did not succeed in obtaining enough DBE participation to meet the goal.

DBE LOCATOR REFERENCES. Bidders shall consult the IL UCP DBE Directory as a reference source for DBE-certified companies. In addition, the Department maintains a letting and item specific DBE locator information system whereby DBE companies can register their interest in providing quotes on particular bid items advertised for letting. Information concerning DBE companies willing to quote work for particular contracts may be obtained by contacting the Department's Bureau of Small Business Enterprises at telephone number (217)785-4611, or by visiting the Department's website at www.dot.il.gov.

BIDDING PROCEDURES. Compliance with this Special Provision is a material bidding requirement. The failure of the bidder to comply will render the bid not responsive.

- (a) The bidder shall submit a Disadvantaged Business Utilization Plan on Department forms SBE 2025 and 2026 with the bid.
- (b) The Utilization Plan shall indicate that the bidder either has obtained sufficient DBE participation commitments to meet the contract goal or has not obtained enough DBE participation commitments in spite of a good faith effort to meet the goal. The Utilization Plan shall further provide the name, telephone number, and telefax number of a responsible official of the bidder designated for purposes of notification of plan approval or disapproval under the procedures of this Special Provision.
- (c) The Utilization Plan shall include a DBE Participation Commitment Statement, Department form SBE 2025, for each DBE proposed for the performance of work to achieve the contract goal. For bidding purposes, submission of the completed SBE 2025 forms, signed by the DBEs and faxed to the bidder will be acceptable as long as the original is available and provided upon request. All elements of information indicated on the said form shall be provided, including but not limited to the following:

- (1) The names and addresses of DBE firms that will participate in the contract;
- (2) A description, including pay item numbers, of the work each DBE will perform;
- (3) The dollar amount of the participation of each DBE firm participating. The dollar amount of participation for identified work shall specifically state the quantity, unit price, and total subcontract price for the work to be completed by the DBE. If partial pay items are to be performed by the DBE, indicate the portion of each item, a unit price where appropriate and the subcontract price amount;
- (4) DBE Participation Commitment Statements, form SBE 2025, signed by the bidder and each participating DBE firm documenting the commitment to use the DBE subcontractors whose participation is submitted to meet the contract goal;
- (5) if the bidder is a joint venture comprised of DBE companies and non-DBE companies, the plan must also include a clear identification of the portion of the work to be performed by the DBE partner(s); and,
- (6) If the contract goal if not met, evidence of good faith efforts.

GOOD FAITH EFFORT PROCEDURES. The contract will not be awarded until the Utilization Plan submitted by the apparent successful bidder is approved. All information submitted by the bidder must be complete, accurate and adequately document that enough DBE participation has been obtained or document that good faith efforts of the bidder, in the event enough DBE participation has not been obtained, before the Department will commit to the performance of the contract by the bidder. The Utilization Plan will be approved by the Department if the Utilization Plan documents sufficient commercially useful DBE work performance to meet the contract goal or the bidder submits sufficient documentation of a good faith effort to meet the contract goal pursuant to 49 CFR Part 26, Appendix A. The Utilization Plan will not be approved by the Department if the Utilization Plan does not document sufficient DBE participation to meet the contract goal unless the apparent successful bidder documented in the Utilization Plan that it made a good faith effort to meet the goal. This means that the bidder must show that all necessary and reasonable steps were taken to achieve the contract goal. Necessary and reasonable steps are those which, by their scope, intensity and appropriateness to the objective, could reasonably be expected to obtain sufficient DBE participation, even if they were not successful. The Department will consider the quality, quantity, and intensity of the kinds of efforts that the bidder has made. Mere *pro forma* efforts, in other words, efforts done as a matter of form, are not good faith efforts; rather, the bidder is expected to have taken genuine efforts that would be reasonably expected of a bidder actively and aggressively trying to obtain DBE participation sufficient to meet the contract goal.

- (a) The following is a list of types of action that the Department will consider as part of the evaluation of the bidder's good faith efforts to obtain participation. These listed factors are not intended to be a mandatory checklist and are not intended to be exhaustive. Other factors or efforts brought to the attention of the Department may be relevant in appropriate cases, and will be considered by the Department.

- (1) Soliciting through all reasonable and available means (e.g. attendance at pre-bid meetings, advertising and/or written notices) the interest of all certified DBE companies that have the capability to perform the work of the contract. The bidder must solicit this interest within sufficient time to allow the DBE companies to respond to the solicitation. The bidder must determine with certainty if the DBE companies are interested by taking appropriate steps to follow up initial solicitations.
- (2) Selecting portions of the work to be performed by DBE companies in order to increase the likelihood that the DBE goals will be achieved. This includes, where appropriate, breaking out contract work items into economically feasible units to facilitate DBE participation, even when the prime Contractor might otherwise prefer to perform these work items with its own forces.
- (3) Providing interested DBE companies with adequate information about the plans, specifications, and requirements of the contract in a timely manner to assist them in responding to a solicitation.
- (4) a. Negotiating in good faith with interested DBE companies. It is the bidder's responsibility to make a portion of the work available to DBE subcontractors and suppliers and to select those portions of the work or material needs consistent with the available DBE subcontractors and suppliers, so as to facilitate DBE participation. Evidence of such negotiation includes the names, addresses, and telephone numbers of DBE companies that were considered; a description of the information provided regarding the plans and specifications for the work selected for subcontracting; and evidence as to why additional agreements could not be reached for DBE companies to perform the work.

b. A bidder using good business judgment would consider a number of factors in negotiating with subcontractors, including DBE subcontractors, and would take a firm's price and capabilities as well as contract goals into consideration. However, the fact that there may be some additional costs involved in finding and using DBE companies is not in itself sufficient reason for a bidder's failure to meet the contract DBE goal, as long as such costs are reasonable. Also the ability or desire of a bidder to perform the work of a contract with its own organization does not relieve the bidder of the responsibility to make good faith efforts. Bidders are not, however, required to accept higher quotes from DBE companies if the price difference is excessive or unreasonable.
- (5) Not rejecting DBE companies as being unqualified without sound reasons based on a thorough investigation of their capabilities. The bidder's standing within its industry, membership in specific groups, organizations, or associations and political or social affiliations (for example union vs. non-union employee status) are not legitimate causes for the rejection or non-solicitation of bids in the bidder's efforts to meet the project goal.
- (6) Making efforts to assist interested DBE companies in obtaining bonding, lines of credit, or insurance as required by the recipient or Contractor.

- (7) Making efforts to assist interested DBE companies in obtaining necessary equipment, supplies, materials, or related assistance or services.
 - (8) Effectively using the services of available minority/women community organizations; minority/women contractors' groups; local, state, and federal minority/women business assistance offices; and other organizations as allowed on a case-by-case basis to provide assistance in the recruitment and placement of DBE companies.
- (b) If the Department determines that the apparent successful bidder has made a good faith effort to secure the work commitment of DBE companies to meet the contract goal, the Department will award the contract provided that it is otherwise eligible for award. If the Department determines that the bidder has failed to meet the requirements of this Special Provision or that a good faith effort has not been made, the Department will notify the responsible company official designated in the Utilization Plan that the bid is not responsive. The notification shall include a statement of reasons for the determination.
- (c) The bidder may request administrative reconsideration of a determination adverse to the bidder within the five working days after the receipt of the notification date of the determination by delivering the request to the Department of Transportation, Bureau of Small Business Enterprises, Contract Compliance Section, 2300 South Dirksen Parkway, Room 319, Springfield, Illinois 62764 (Telefax: (217)785-1524). Deposit of the request in the United States mail on or before the fifth business day shall not be deemed delivery. The determination shall become final if a request is not made and delivered. A request may provide additional written documentation and/or argument concerning the issues raised in the determination statement of reasons, provided the documentation and arguments address efforts made prior to submitting the bid. The request will be forwarded to the Department's Reconsideration Officer. The Reconsideration Officer will extend an opportunity to the bidder to meet in person in order to consider all issues of documentation and whether the bidder made a good faith effort to meet the goal. After the review by the Reconsideration Officer, the bidder will be sent a written decision within ten working days after receipt of the request for consideration, explaining the basis for finding that the bidder did or did not meet the goal or make adequate good faith efforts to do so. A final decision by the Reconsideration Officer that a good faith effort was made shall approve the Utilization Plan submitted by the bidder and shall clear the contract for award. A final decision that a good faith effort was not made shall render the bid not responsive.

CALCULATING DBE PARTICIPATION. The Utilization Plan values represent work anticipated to be performed and paid for upon satisfactory completion. The Department is only able to count toward the achievement of the overall goal and the contract goal the value of payments made for the work actually performed by DBE companies. In addition, a DBE must perform a commercially useful function on the contract to be counted. A commercially useful function is generally performed when the DBE is responsible for the work and is carrying out its responsibilities by actually performing, managing, and supervising the work involved. The Department and Contractor are governed by the provisions of 49 CFR Part 26.55(c) on questions of commercially useful functions as it affects the work. Specific counting guidelines are provided in 49 CFR Part 26.55, the provisions of which govern over the summary contained herein.

- (a) DBE as the Contractor: 100 percent goal credit for that portion of the work performed by the DBE's own forces, including the cost of materials and supplies. Work that a DBE subcontracts to a non-DBE does not count toward the DBE goals.
- (b) DBE as a joint venture Contractor: 100 percent goal credit for that portion of the total dollar value of the contract equal to the distinct, clearly defined portion of the work performed by the DBE's own forces.
- (c) DBE as a subcontractor: 100 percent goal credit for the work of the subcontract performed by the DBE's own forces, including the cost of materials and supplies, excluding the purchase of materials and supplies or the lease of equipment by the DBE subcontractor from the prime Contractor or its affiliates. Work that a DBE subcontractor in turn subcontracts to a non-DBE does not count toward the DBE goal.
- (d) DBE as a trucker: 100 percent goal credit for trucking participation provided the DBE is responsible for the management and supervision of the entire trucking operation for which it is responsible. At least one truck owned, operated, licensed, and insured by the DBE must be used on the contract. Credit will be given for the following:
 - (1) The DBE may lease trucks from another DBE firm, including an owner-operator who is certified as a DBE. The DBE who leases trucks from another DBE receives credit for the total value of the transportation services the lessee DBE provides on the contract.
 - (2) The DBE may also lease trucks from a non-DBE firm, including from an owner-operator. The DBE who leases trucks from a non-DBE is entitled to credit only for the fee or commission is receives as a result of the lease arrangement.
- (e) DBE as a material supplier:
 - (1) 60 percent goal credit for the cost of the materials or supplies purchased from a DBE regular dealer.
 - (2) 100 percent goal credit for the cost of materials of supplies obtained from a DBE manufacturer.
 - (3) 100 percent credit for the value of reasonable fees and commissions for the procurement of materials and supplies if not a regular dealer or manufacturer.

CONTRACT COMPLIANCE. Compliance with this Special Provision is an essential part of the contract. The Department is prohibited by federal regulations from crediting the participation of a DBE included in the Utilization Plan toward either the contract goal or the Department's overall goal until the amount to be applied toward the goals has been paid to the DBE. The following administrative procedures and remedies govern the compliance by the Contractor with the contractual obligations established by the Utilization Plan. After approval of the Utilization Plan and award of the contract, the Utilization Plan and individual DBE Participation Statements become part of the contract. If the Contractor did not succeed in obtaining enough DBE participation to achieve the advertised contract goal, and the Utilization Plan was approved and contract awarded based upon a determination of good faith, the total dollar value of DBE work calculated in the approved Utilization Plan as a percentage of the awarded contract value shall become the amended contract goal. All work indicated for performance by an approved DBE shall be performed, managed, and supervised by the DBE executing the Participation Statement.

- (a) NO AMENDMENT. No amendment to the Utilization Plan may be made without prior written approval from the Department's Bureau of Small Business Enterprises. All requests for amendment to the Utilization Plan shall be submitted to the Department of Transportation, Bureau of Small Business Enterprises, Contract Compliance Section, 2300 South Dirksen Parkway, Room 319, Springfield, Illinois 62764. Telephone number (217)785-4611. Telefax number (217)785-1524.
- (b) TERMINATION OR REPLACEMENT. The Contractor shall not terminate or replace a DBE listed on the approved Utilization Plan, or perform with other forces work designated for a listed DBE except as provided in the Special Provision.
- (c) CHANGES TO WORK. Any deviation from the DBE condition-of-award or contract plans, specifications, or special provisions must be approved, in writing, by the Department as provided elsewhere in the Contract. The Contractor shall notify affected DBEs in writing of any changes in the scope of work which result in a reduction in the dollar amount condition-of-award to the contract. Where the revision includes work committed to a new DBE subcontractor, not previously involved in the project, then a Request for Approval of Subcontractor, Department form BC 260A, must be signed and submitted. If the commitment of work is in the form of additional tasks assigned to an existing subcontract, then a new Request for Approval of Subcontractor shall not be required. However, the Contractor must document efforts to assure that the existing DBE subcontractor is capable of performing the additional work and has agreed in writing to the change.
- (d) ALTERNATIVE WORK METHODS. In addition to the above requirements for reductions in the condition of award, additional requirements apply to the two cases of Contractor-initiated work substitution proposals. Where the contract allows alternate work methods which serve to delete or create underruns in condition of award DBE work, and the Contractor selects that alternate method or, where the Contractor proposes a substitute work method or material that serves to diminish or delete work committed to a DBE and replace it with other work, then the Contractor must demonstrate one of the following:
- (1) That the replacement work will be performed by the same DBE (as long as the DBE is certified in the respective item of work) in a modification of the condition of award;
or
 - (2) That the DBE is aware that its work will be deleted or will experience underruns and has agreed in writing to the change. If this occurs, the Contractor shall substitute other work of equivalent value to a certified DBE or provide documentation of good faith efforts to do so; or
 - (3) That the DBE is not capable of performing the replacement work or has declined to perform the work at a reasonable competitive price. If this occurs, the Contractor shall substitute other work of equivalent value to a certified DBE or provide documentation of good faith efforts to do so.

(e) TERMINATION AND REPLACEMENT PROCEDURES. The Contractor shall not terminate or replace a DBE subcontractor listed in the approved Utilization Plan without prior written consent. This includes, but is not limited to, instances in which the Contractor seeks to perform work originally designated for a DBE subcontractor with its own forces or those of an affiliate, a non-DBE firm, or with another DBE firm. Written consent will be granted only if the Bureau of Small Business Enterprises agrees, for reasons stated in its concurrence document, that the Contractor has good cause to terminate or replace the DBE firm. Before transmitting to the Bureau of Small Business Enterprises any request to terminate and/or substitute a DBE subcontractor, the Contractor shall give notice in writing to the DBE subcontractor, with a copy to the Bureau, of its intent to request to terminate and/or substitute, and the reason for the request. The Contractor shall give the DBE five days to respond to the Contractor's notice. The DBE so notified shall advise the Bureau and the Contractor of the reasons, if any, why it objects to the proposed termination of its subcontract and why the Bureau should not approve the Contractor's action. If required in a particular case as a matter of public necessity, the Bureau may provide a response period shorter than five days.

For purposes of this paragraph, good cause includes the following circumstances:

- (1) The listed DBE subcontractor fails or refuses to execute a written contract;
- (2) The listed DBE subcontractor fails or refuses to perform the work of its subcontract in a way consistent with normal industry standards. Provided, however, that good cause does not exist if the failure or refusal of the DBE subcontractor to perform its work on the subcontract results from the bad faith or discriminatory action of the prime contractor;
- (3) The listed DBE subcontractor fails or refuses to meet the prime Contractor's reasonable, nondiscriminatory bond requirements;
- (4) The listed DBE subcontractor becomes bankrupt, insolvent, or exhibits credit unworthiness;
- (5) The listed DBE subcontractor is ineligible to work on public works projects because of suspension and debarment proceedings pursuant 2 CFR Parts 180, 215 and 1,200 or applicable state law.
- (6) You have determined that the listed DBE subcontractor is not a responsible contractor;
- (7) The listed DBE subcontractor voluntarily withdraws from the projects and provides to you written notice of its withdrawal;
- (8) The listed DBE is ineligible to receive DBE credit for the type of work required;
- (9) A DBE owner dies or becomes disabled with the result that the listed DBE contractor is unable to complete its work on the contract;

- (10) Other documented good cause that compels the termination of the DBE subcontractor. Provided, that good cause does not exist if the prime Contractor seeks to terminate a DBE it relied upon to obtain the contract so that the prime Contractor can self-perform the work for which the DBE contractor was engaged or so that the prime Contractor can substitute another DBE or non-DBE contractor after contract award.

When a DBE is terminated, or fails to complete its work on the Contract for any reason the Contractor shall make a good faith effort to find another DBE to substitute for the original DBE to perform at least the same amount of work under the contract as the terminated DBE to the extent needed to meet the established Contract goal.

- (f) PAYMENT RECORDS. The Contractor shall maintain a record of payments for work performed to the DBE participants. The records shall be made available to the Department for inspection upon request. After the performance of the final item of work or delivery of material by a DBE and final payment therefore to the DBE by the Contractor, but not later than thirty calendar days after payment has been made by the Department to the Contractor for such work or material, the Contractor shall submit a DBE Payment Agreement on Department form SBE 2115 to the Regional Engineer. If full and final payment has not been made to the DBE, the DBE Payment Agreement shall indicate whether a disagreement as to the payment required exists between the Contractor and the DBE or if the Contractor believes that the work has not been satisfactorily completed. If the Contractor does not have the full amount of work indicated in the Utilization Plan performed by the BDE companies indicated in the Utilization Plan and after good faith efforts are reviewed, the Department may deduct from contract payments to the Contractor the amount of the goal not achieved as liquidated and ascertained damages. The Contractor may request an administrative reconsideration of any amount deducted as damages pursuant to subsection (h) of this part.
- (g) ENFORCEMENT. The Department reserves the right to withhold payment to the Contractor to enforce the provisions of this Special Provision. Final payment shall not be made on the contract until such time as the Contractor submits sufficient documentation demonstrating achievement of the goal in accordance with this Special Provision or after liquidated damages have been determined and collected.
- (h) RECONSIDERATION. Notwithstanding any other provision of the contract, including but not limited to Article 109.09 of the Standard Specifications, the Contractor may request administrative reconsideration of a decision to deduct the amount of the goal not achieved as liquidated damages. A request to reconsider shall be delivered to the Contract Compliance Section and shall be handled and considered in the same manner as set forth in paragraph (c) of "Good Faith Effort Procedures" of this Special Provision, except a final decision that a good faith effort was not made during contract performance to achieve the goal agreed to in the Utilization Plan shall be the final administrative decision of the Department.

ERRATA FOR THE 2012 STANDARD SPECIFICATIONS (BDE)

Effective: April 1, 2012

Revised: August 1, 2012

- Page 182 Article 354.12. In the second line of the first paragraph change “Article 353.12” to “Article 353.13”.
- Page 183 Article 355.10. In the second line of the first paragraph change “Article 353.12” to “Article 353.13”.
- Page 185 Article 356.10. In the second line of the first paragraph change “Article 353.12” to “Article 353.13”.
- Page 337 Article 505.04. Revise the subparagraph “(i) Match Making.” to “(i) Match Marking.”.
- Page 360 Article 506.07. In the first line of the second paragraph change “AASHTO/AWS D1.5/D1.5.” to “AASHTO/AWS D1.5M/D1.5.”.
- Page 361 Article 506.08. In the third line of the sixth paragraph change “506.08(a)” to “506.08(b)”.
- Page 531 Article 609.07. In the first paragraph delete “TYPE B, C, or D INLET BOX STANDARD 609001 or”.
- Page 601 Article 701.18(h). In the first line of the first paragraph change “Standard 701426.” to “Standard 701426 and 701427.”.
- Page 609 Article 703.05. In the first line of the second paragraph delete “or Type II”.
- Page 989 Article 1083.02(a). In the seventh line of the first paragraph change “Table 14.7.5.2-2” to “Table 14.7.5.2-1”.
- Page 1019 Article 1095.01(b)(1)e. In the table for daylight reflectance for the color yellow, change “75 % min.” to “45 % min.”.

FRICITION AGGREGATE (BDE)

Effective: January 1, 2011

Revise Article 1004.01(a)(4) of the Standard Specifications to read:

“(4)Crushed Stone. Crushed stone shall be the angular fragments resulting from crushing undisturbed, consolidated deposits of rock by mechanical means. Crushed stone shall be divided into the following, when specified.

- a. Carbonate Crushed Stone. Carbonate crushed stone shall be either dolomite or limestone. Dolomite shall contain 11.0 percent or more magnesium oxide (MgO). Limestone shall contain less than 11.0 percent magnesium oxide (MgO).
- b. Crystalline Crushed Stone. Crystalline crushed stone shall be either metamorphic or igneous stone, including but is not limited to, quartzite, granite, rhyolite and diabase.”

Revise Article 1004.03(a) of the Standard Specifications to read:

“1004.03 Coarse Aggregate for Hot-Mix Asphalt (HMA). The aggregate shall be according to Article 1004.01 and the following.

- (a) Description. The coarse aggregate for HMA shall be according to the following table.

Use	Mixture	Aggregates Allowed						
Class A	Seal or Cover	<u>Allowed Alone or in Combination:</u> Gravel Crushed Gravel Carbonate Crushed Stone Crystalline Crushed Stone Crushed Sandstone Crushed Slag (ACBF) Crushed Steel Slag Crushed Concrete						
HMA All Other	Stabilized Subbase or Shoulders	<u>Allowed Alone or in Combination:</u> Gravel Crushed Gravel Carbonate Crushed Stone Crystalline Crushed Stone Crushed Sandstone Crushed Slag (ACBF) Crushed Steel Slag ^{1/} Crushed Concrete						
HMA High ESAL Low ESAL	Binder IL-25.0, IL-19.0, or IL-19.0L SMA Binder	<u>Allowed Alone or in Combination:</u> Crushed Gravel Carbonate Crushed Stone ^{2/} Crystalline Crushed Stone Crushed Sandstone Crushed Slag (ACBF) Crushed Concrete ^{3/}						
HMA High ESAL Low ESAL	C Surface and Leveling Binder IL-12.5,IL-9.5, or IL-9.5L SMA Ndesign 50 Surface	<u>Allowed Alone or in Combination:</u> Crushed Gravel Carbonate Crushed Stone ^{2/} Crystalline Crushed Stone Crushed Sandstone Crushed Slag (ACBF) Crushed Steel Slag ^{4/} Crushed Concrete ^{3/}						
HMA High ESAL	D Surface and Leveling Binder IL-12.5 or IL-9.5 SMA Ndesign 50 Surface	<u>Allowed Alone or in Combination:</u> Crushed Gravel Carbonate Crushed Stone (other than Limestone) ^{2/} Crystalline Crushed Stone Crushed Sandstone Crushed Slag (ACBF) ^{5/} Crushed Steel Slag ^{4/ 5/} Crushed Concrete ^{3/}						
		<u>Other Combinations Allowed:</u>						
		<table border="1" style="width: 100%;"> <tr> <td style="width: 50%;"><i>Up to...</i></td> <td style="width: 50%;"><i>With...</i></td> </tr> <tr> <td>25% Limestone</td> <td>Dolomite</td> </tr> <tr> <td>50% Limestone</td> <td>Any Mixture D aggregate other than Dolomite</td> </tr> </table>	<i>Up to...</i>	<i>With...</i>	25% Limestone	Dolomite	50% Limestone	Any Mixture D aggregate other than Dolomite
<i>Up to...</i>	<i>With...</i>							
25% Limestone	Dolomite							
50% Limestone	Any Mixture D aggregate other than Dolomite							

Use	Mixture	Aggregates Allowed	
		75% Limestone	Crushed Slag (ACBF) ^{5/} or Crushed Sandstone
HMA High ESAL	E Surface IL-12.5 or IL-9.5 SMA Ndesign 80 Surface	<u>Allowed Alone or in Combination:</u> Crushed Gravel Crystalline Crushed Stone Crushed Sandstone Crushed Slag (ACBF) ^{5/} Crushed Steel Slag ^{5/} Crushed Concrete ^{3/} No Limestone.	
		<u>Other Combinations Allowed:</u>	
		<i>Up to...</i>	<i>With...</i>
		50% Dolomite ^{2/}	Any Mixture E aggregate
		75% Dolomite ^{2/}	Crushed Sandstone, Crushed Slag (ACBF) ^{5/} , Crushed Steel Slag ^{5/} , or Crystalline Crushed Stone
75% Crushed Gravel or Crushed Concrete ^{3/}	Crushed Sandstone, Crystalline Crushed Stone, Crushed Slag (ACBF) ^{5/} , or Crushed Steel Slag ^{5/}		
HMA High ESAL	F Surface IL-12.5 or IL-9.5 SMA Ndesign 80 Surface	<u>Allowed Alone or in Combination:</u> Crystalline Crushed Stone Crushed Sandstone Crushed Slag (ACBF) ^{5/} Crushed Steel Slag ^{5/} No Limestone.	
		<u>Other Combinations Allowed:</u>	
		<i>Up to...</i>	<i>With...</i>
		50% Crushed Gravel, Crushed Concrete ^{3/} , or Dolomite ^{2/}	Crushed Sandstone, Crushed Slag (ACBF) ^{5/} , Crushed Steel Slag ^{5/} , or Crystalline Crushed Stone

- 1/ Crushed steel slag allowed in shoulder surface only.
- 2/ Carbonate crushed stone shall not be used in SMA Ndesign 80. In SMA Ndesign 50, carbonate crushed stone shall not be blended with any of the other aggregates allowed alone in Ndesign 50 SMA binder or Ndesign 50 SMA surface.
- 3/ Crushed concrete will not be permitted in SMA mixes.
- 4/ Crushed steel slag shall not be used as leveling binder.
- 5/ When either slag is used, the blend percentages listed shall be by volume.”

PAVEMENT PATCHING (BDE)

Effective: January 1, 2010

Revise the first sentence of the second paragraph of Article 701.17(e)(1) of the Standard Specifications to read:

“In addition to the traffic control and protection shown elsewhere in the contract for pavement, two devices shall be placed immediately in front of each open patch, open hole, and broken pavement where temporary concrete barriers are not used to separate traffic from the work area.”

PAYMENTS TO SUBCONTRACTORS (BDE)

Effective: June 1, 2000

Revised: January 1, 2006

Federal regulations found at 49 CFR §26.29 mandate the Department to establish a contract clause to require Contractors to pay subcontractors for satisfactory performance of their subcontracts and to set the time for such payments.

State law also addresses the timing of payments to be made to subcontractors and material suppliers. Section 7 of the Prompt Payment Act, 30 ILCS 540/7, requires that when a Contractor receives any payment from the Department, the Contractor shall make corresponding, proportional payments to each subcontractor and material supplier performing work or supplying material within 15 calendar days after receipt of the Department payment. Section 7 of the Act further provides that interest in the amount of two percent per month, in addition to the payment due, shall be paid to any subcontractor or material supplier by the Contractor if the payment required by the Act is withheld or delayed without reasonable cause. The Act also provides that the time for payment required and the calculation of any interest due applies to transactions between subcontractors and lower-tier subcontractors and material suppliers throughout the contracting chain.

This Special Provision establishes the required federal contract clause, and adopts the 15 calendar day requirement of the State Prompt Payment Act for purposes of compliance with the federal regulation regarding payments to subcontractors. This contract is subject to the following payment obligations.

When progress payments are made to the Contractor according to Article 109.07 of the Standard Specifications, the Contractor shall make a corresponding payment to each subcontractor and material supplier in proportion to the work satisfactorily completed by each subcontractor and for the material supplied to perform any work of the contract. The proportionate amount of partial payment due to each subcontractor and material supplier throughout the contracting chain shall be determined by the quantities measured or otherwise determined as eligible for payment by the Department and included in the progress payment to the Contractor. Subcontractors and material suppliers shall be paid by the Contractor within 15 calendar days after the receipt of payment from the Department. The Contractor shall not hold retainage from the subcontractors. These obligations shall also apply to any payments made by subcontractors and material suppliers to their subcontractors and material suppliers; and to all payments made to lower tier subcontractors and material suppliers throughout the contracting chain. Any payment or portion of a payment subject to this provision may only be withheld from the subcontractor or material supplier to whom it is due for reasonable cause.

This Special Provision does not create any rights in favor of any subcontractor or material supplier against the State or authorize any cause of action against the State on account of any payment, nonpayment, delayed payment, or interest claimed by application of the State Prompt Payment Act. The Department will not approve any delay or postponement of the 15 day requirement except for reasonable cause shown after notice and hearing pursuant to Section 7(b) of the State Prompt Payment Act. State law creates other and additional remedies available to any subcontractor or material supplier, regardless of tier, who has not been paid for work properly performed or material furnished. These remedies are a lien against public funds set forth in Section 23(c) of the Mechanics Lien Act, 770 ILCS 60/23(c), and a recovery on the Contractor's payment bond according to the Public Construction Bond Act, 30 ILCS 550.

PAYROLLS AND PAYROLL RECORDS (BDE)

Effective: January 2, 2012

Revise Section IV of Check Sheet #5 of the Recurring Special Provisions to read:

"IV. COMPLIANCE WITH THE PREVAILING WAGE ACT

1. **Prevailing Wages.** All wages paid by the Contractor and each subcontractor shall be in compliance with The Prevailing Wage Act (820 ILCS 130), as amended, except where a prevailing wage violates a federal law, order, or ruling, the rate conforming to the federal law, order, or ruling shall govern. The Contractor shall be responsible to notify each subcontractor of the wage rates set forth in this contract and any revisions thereto. If the Department of Labor revises the wage rates, the Contractor will not be allowed additional compensation on account of said revisions.
2. **Payroll Records.** The Contractor and each subcontractor shall make and keep, for a period of three years from the later of the date of final payment under the contract or completion of the contract, records of the wages paid to his/her workers. The payroll records shall include each worker's name, address, telephone number, social security number, classification, rate of pay, number of hours worked each day, starting and ending times of work each day, total hours worked each week, itemized deductions made, and actual wages paid. Upon seven business days' notice, these records shall be available at a location within the State, during reasonable hours, for inspection by the Department; the Department of Labor; and Federal, State or local law enforcement agencies and prosecutors.
3. **Submission of Payroll Records.** The Contractor and each subcontractor shall submit payroll records to the Engineer each week from the start to the completion of their respective work, except that full social security numbers and home addresses shall not be included on weekly transmittals. Instead the payrolls shall include an identification number for each employee (e.g., the last four digits of the employee's social security number). In addition, starting and ending times of work each day may be omitted from the payroll records submitted to the Engineer. The submittals shall be on the Department's form SBE 48, or an approved facsimile. When there has been no activity during a work week, a payroll record shall still be submitted with the appropriate box ("No Work", "Suspended", or "Complete") checked on the form.

Each submittal shall be accompanied by a statement signed by the Contractor or subcontractor, or an officer, employee or officer thereof, which avers that: (i) he or she has examined the records and such records are true and accurate; (ii) the hourly rate paid to each worker is not less than the general prevailing rate of hourly wages required by the Act; and (iii) the Contractor or subcontractor is aware that filing a payroll record that he/she knows to be false is a Class A misdemeanor.

4. Employee Interviews. The Contractor and each subcontractor shall permit his/her employees to be interviewed on the job, during working hours, by compliance investigators of the Department or the Department of Labor.”

PORTLAND CEMENT CONCRETE (BDE)

Effective: January 1, 2012

Revise Notes 1 and 2 of Article 312.24 of the Standard Specifications to read:

- “Note 1. Coarse aggregate shall be gradation CA 6, CA 7, CA 9, CA 10, or CA 11, Class D quality or better. Article 1020.05(d) shall apply.
Note 2. Fine aggregate shall be FA 1 or FA 2. Article 1020.05(d) shall apply.”

Revise the first paragraph of Article 312.26 of the Standard Specifications to read:

“**312.26 Proportioning and Mix Design.** At least 60 days prior to start of placing CAM II, the Contractor shall submit samples of materials for proportioning and testing. The mixture shall contain a minimum of 200 lb (90 kg) of cement per cubic yard (cubic meter). Portland cement may be replaced with fly ash according to Article 1020.05(c)(1). Blends of coarse and fine aggregates will be permitted, provided the volume of fine aggregate does not exceed the volume of coarse aggregate. The Engineer will determine the proportions of materials for the mixture. However, the Contractor may substitute their own mix design. Article 1020.05(a) shall apply and a Level III PCC Technician shall develop the mix design.”

Revise the second paragraph of Article 503.22 of the Standard Specifications to read:

Other cast-in-place concrete for structures will be paid for at the contract unit price per cubic yard (cubic meter) for CONCRETE HANDRAIL, CONCRETE ENCASMENT, and SEAL COAT CONCRETE.”

Add the following to Article 1003.02 of the Standard Specifications:

- (e) Alkali Reaction.

- (1) ASTM C 1260. Each fine aggregate will be tested by the Department for alkali reaction according to ASTM C 1260. The test will be performed with Type I or II portland cement having a total equivalent alkali content ($\text{Na}_2\text{O} + 0.658\text{K}_2\text{O}$) of 0.90 percent or greater. The Engineer will determine the assigned expansion value for each aggregate, and these values will be made available on the Department's Alkali-Silica Potential Reactivity Rating List. The Engineer may differentiate aggregate based on ledge, production method, gradation number, or other factors. An expansion value of 0.03 percent will be assigned to limestone or dolomite fine aggregates (manufactured stone sand). However, the Department reserves the right to perform the ASTM C 1260 test.
- (2) ASTM C 1293 by Department. In some instances, such as chert natural sand or other fine aggregates, testing according to ASTM C 1260 may not provide accurate test results. In this case, the Department may only test according to ASTM C 1293.
- (3) ASTM C 1293 by Contractor. If an individual aggregate has an ASTM C 1260 expansion value that is unacceptable to the Contractor, an ASTM C 1293 test may be performed by the Contractor to evaluate the Department's ASTM C 1260 test result. The laboratory performing the ASTM C 1293 test shall be approved by the Department according to the current Bureau of Materials and Physical Research Policy Memorandum "Minimum Laboratory Requirements for Alkali-Silica Reactivity (ASR) Testing".

The ASTM C 1293 test shall be performed with Type I or II portland cement having a total equivalent alkali content ($\text{Na}_2\text{O} + 0.658\text{K}_2\text{O}$) of 0.80 percent or greater. The interior vertical wall of the ASTM C 1293 recommended container (pail) shall be half covered with a wick of absorbent material consisting of blotting paper. If the testing laboratory desires to use an alternate container, wick of absorbent material, or amount of coverage inside the container with blotting paper, ASTM C 1293 test results with an alkali-reactive aggregate of known expansion characteristics shall be provided to the Engineer for review and approval. If the expansion is less than 0.040 percent after one year, the aggregate will be assigned an ASTM C 1260 expansion value of 0.08 percent that will be valid for two years, unless the Engineer determines the aggregate has changed significantly. If the aggregate is manufactured into multiple gradation numbers, and the other gradation numbers have the same or lower ASTM C 1260 value, the ASTM C 1293 test result may apply to multiple gradation numbers.

The Engineer reserves the right to verify a Contractor's ASTM C 1293 test result. When the Contractor performs the test, a split sample shall be provided to the Engineer. The Engineer may also independently obtain a sample at any time. The aggregate will be considered reactive if the Contractor or Engineer obtains an expansion value of 0.040 percent or greater.

Revise Article 1004.02(d) of the Standard Specifications to read:

- "(d)Combining Sizes. Each size shall be stored separately and care shall be taken to prevent them from being mixed until they are ready to be proportioned. Separate compartments shall be provided to proportion each size.

- (1) When Class BS concrete is to be pumped, the coarse aggregate gradation shall have a minimum of 45 percent passing the 1/2 in. (12.5 mm) sieve. The Contractor may combine two or more coarse aggregate sizes, consisting of CA 7, CA 11, CA 13, CA 14, and CA 16, provided a CA 7 or CA 11 is included in the blend.
- (2) If the coarse aggregate is furnished in separate sizes, they shall be combined in proportions to provide a uniformly graded coarse aggregate grading within the following limits.

Class of Concrete ^{1/}	Combined Sizes	Sieve Size and Percent Passing						
		2 1/2 in.	2 in.	1 3/4 in.	1 1/2 in.	1 in.	1/2 in.	No. 4
PV ^{2/}	CA 5 & CA 7	---	---	100	98±2	72±22	22±12	3±3
	CA 5 & CA 11	---	---	100	98±2	72±22	22±12	3±3
SI and SC ^{2/}	CA 3 & CA 7	100	95±5	---	---	55±25	20±10	3±3
	CA 3 & CA 11	100	95±5	---	---	55±25	20±10	3±3
	CA 5 & CA 7	---	---	100	98±2	72±22	22±12	3±3
	CA 5 & CA 11	---	---	100	98±2	72±22	22±12	3±3

Class of Concrete ^{1/}	Combined Sizes	Sieve Size (metric) and Percent Passing						
		63 mm	50 mm	45 mm	37.5 mm	25 mm	12.5 mm	4.75 mm
PV ^{2/}	CA 5 & CA 7	---	---	100	98±2	72±22	22±12	3±3
	CA 5 & CA 11	---	---	100	98±2	72±22	22±12	3±3
SI and SC ^{2/}	CA 3 & CA 7	100	95±5	---	---	55±25	20±10	3±3
	CA 3 & CA 11	100	95±5	---	---	55±25	20±10	3±3
	CA 5 & CA 7	---	---	100	98±2	72±22	22±12	3±3
	CA 5 & CA 11	---	---	100	98±2	72±22	22±12	3±3

1/ See Table 1 of Article 1020.04.

2/ Any of the listed combination of sizes may be used.”

Add the following to Article 1004.02 of the Standard Specifications:

(g) Alkali Reaction.

- (1) Each coarse aggregate will be tested by the Department for alkali reaction according to ASTM C 1260. The test will be performed with Type I or II portland cement having a total equivalent alkali content (Na₂O + 0.658K₂O) of 0.90 percent or greater. The Engineer will determine the assigned expansion value for each aggregate, and these values will be made available on the Department’s Alkali-Silica Potential Reactivity Rating List. The Engineer may differentiate aggregate based on ledge, production method, gradation number, or other factors. An expansion value of 0.05 percent will be assigned to limestone or dolomite coarse aggregates. However, the Department reserves the right to perform the ASTM C 1260 test.
- (2) ASTM C 1293 by Department. In some instances testing a coarse aggregate according to ASTM C 1260 may not provide accurate test results. In this case, the Department may only test according to ASTM C 1293.

(3) ASTM C 1293 by Contractor. If an individual aggregate has an ASTM C 1260 expansion value that is unacceptable to the Contractor, an ASTM C 1293 test may be performed by the Contractor according to Article 1003.02(e)(3).

Revise the first paragraph of Article 1019.06 of the Standard Specifications to read:

“1019.06 Contractor Mix Design. A Contractor may submit their own mix design and may propose alternate fine aggregate materials, fine aggregate gradations, or material proportions. Article 1020.05(a) shall apply and a Level III PCC Technician shall develop the mix design.”

Revise Section 1020 of the Standard Specifications to read:

“SECTION 1020. PORTLAND CEMENT CONCRETE

1020.01 Description. This item shall consist of the materials, mix design, production, testing, curing, low air temperature protection, and temperature control of concrete.

1020.02 Materials. Materials shall be according to the following.

Item	Article/Section
(a) Cement	1001
(b) Water	1002
(c) Fine Aggregate	1003
(d) Coarse Aggregate	1004
(e) Concrete Admixtures	1021
(f) Finely Divided Minerals	1010
(g) Concrete Curing Materials	1022
(h) Straw	1081.06(a)(1)
(i) Calcium Chloride	1013.01

1020.03 Equipment. Equipment shall be according to the following.

Item	Article/Section
(a) Concrete Mixers and Trucks	1103.01
(b) Batching and Weighing Equipment	1103.02
(c) Automatic and Semi-Automatic Batching Equipment	1103.03
(d) Water Supply Equipment	1103.11
(e) Membrane Curing Equipment	1101.09
(f) Mobile Portland Cement Concrete Plants	1103.04

1020.04 Concrete Classes and General Mix Design Criteria. The classes of concrete shown in Table 1 identify the various mixtures by the general uses and mix design criteria. If the class of concrete for a specific item of construction is not specified, Class SI concrete shall be used.

For the minimum cement factor in Table 1, it shall apply to portland cement, portland-pozzolan cement, and portland blast-furnace slag except when a particular cement is specified in the Table.

The Contractor shall not assume that the minimum cement factor indicated in Table 1 will produce a mixture that will meet the specified strength. In addition, the Contractor shall not assume that the maximum finely divided mineral allowed in a mix design according to Article 1020.05(c) will produce a mixture that will meet the specified strength. The Contractor shall select a cement factor within the allowable range that will obtain the specified strength. The Contractor shall take into consideration materials selected, seasonal temperatures, and other factors which may require the Contractor to submit multiple mix designs.

For a portland-pozzolan cement, portland blast-furnace slag cement, or when replacing portland cement with finely divided minerals per Articles 1020.05(c) and 1020.05(d), the portland cement content in the mixture shall be a minimum of 375 lbs/cu yd (222 kg/cu m). When the total of organic processing additions, inorganic processing additions, and limestone addition exceed 5.0 percent in the cement, the minimum portland cement content in the mixture shall be 400 lbs/cu yd (237 kg/cu m). When calculating the portland cement portion in the portland-pozzolan or portland blast-furnace slag cement, the AASHTO M 240 tolerance may be ignored.

Special classifications may be made for the purpose of including the concrete for a particular use or location as a separate pay item in the contract. The concrete used in such cases shall conform to this section.

FAI 39 (I-39)
Section D2 Patching 2013-1
Winnebago County
Contract 64J11

TABLE 1. CLASSES OF CONCRETE AND MIX DESIGN CRITERIA											
Class of Conc.	Use	Specification Section Reference	Cement Factor		Water / Cement Ratio lb/lb	S l u m p in. (4)	Mix Design Compressive Strength (Flexural Strength)			Air Content %	Coarse Aggregate Gradations (14)
			cwt/cu yd (3)				psi, minimum				
			Min.	Max			Days				
						3	14	28			
PV	Pavement Base Course	420 or 421 353	5.65 (1) 6.05 (2)	7.05	0.32 - 0.42	2 - 4 (5)	Ty III 3500 (650)	3500 (650)		5.0 - 8.0	CA 5 & CA 7, CA 5 & CA 11, CA 7, CA 11, or CA 14
	Base Course Widening	354									
	Driveway Pavement	423									
	Shoulders	483									
	Shoulder Curb	662									
PP	Pavement Patching Bridge Deck Patching (10)	442					3200 (600) Article 701.17(e)(3)b.				
	PP-1		6.50 6.20 (Ty III)	7.50 7.20 (Ty III)	0.32 - 0.44	2 - 4	at 48 hours			4.0 - 7.0	CA 7, CA 11, CA 13, CA 14, or CA 16
	PP-2		7.35	7.35	0.32 - 0.38	2 - 6	at 24 hours			4.0 - 6.0	
	PP-3		7.35 (Ty III) (8)	7.35 (Ty III) (8)	0.32 - 0.35	2 - 4	at 16 hours			4.0 - 6.0	
	PP-4		6.00 (9)	6.25 (9)	0.32 - 0.50	2 - 6	at 8 hours			4.0 - 6.0	
	PP-5		6.75 (9)	6.75 (9)	0.32 - 0.40	2 - 8	at 4 hours			4.0 - 6.0	
RR	Railroad Crossing	422	6.50 6.20 (Ty III)	7.50 7.20 (Ty III)	0.32 - 0.44	2 - 4	3500 (650) at 48 hours			4.0 - 7.0	CA 7, CA 11, or CA 14
BS	Bridge Superstructure Bridge Approach Slab	503	6.05	7.05	0.32 - 0.44	2 - 4 (5)	4000 (675)			5.0 - 8.0	CA 7, CA 11, or CA 14 (7)
PC	Various Precast Concrete Items Wet Cast Dry Cast	1042	5.65 5.65 (TY III)	7.05 7.05 (TY III)	0.32 - 0.44 0.25 - 0.40	1 - 4 0 - 1	See Section 1042			5.0 - 8.0 N/A	CA 7, CA 11, CA 13, CA 14, CA 16, or CA 7 & CA 16
PS	Precast Prestressed Members	504	5.65 5.65 (TY III)	7.05 7.05 (TY III)	0.32 - 0.44	1 - 4			Plans 5000 3500	5.0 - 8.0	CA 11 (11), CA 13, CA 14 (11), or CA 16
	Precast Prestressed Piles and Extensions	512									
	Precast Prestressed Sight Screen	639									

TABLE 1. CLASSES OF CONCRETE AND MIX DESIGN CRITERIA											
Class of Conc.	Use	Specification Section Reference	Cement Factor		Water / Cement Ratio lb/lb	S l u m p in. (4)	Mix Design Compressive Strength (Flexural Strength)			Air Content %	Coarse Aggregate Gradations (14)
			cwt/cu yd (3)				psi, minimum				
			Min.	Max			Days				
						3	14	28			
DS	Drilled Shaft (12) Metal Shell Piles (12) Sign Structures Drilled Shaft (12) Light Tower Foundation (12)	516 512 734 837	6.65	7.05	0.32 - 0.44	6 - 8 (6)	4000 (675)			5.0 - 8.0	CA 13, CA 14, CA 16, or a blend of these gradations.
SC	Seal Coat	503	5.65 (1) 6.05 (2)	7.05	0.32 - 0.44	3 - 5	3500 (650)			Optional 6.0 max.	CA 3 & CA 7, CA 3 & CA 11, CA 5 & CA 7, CA 7 & CA 11, CA 7, or CA 11
SI	Structures (except Superstructure) Sidewalk Slope Wall Encasement Box Culverts End Section and Collar Curb, Gutter, Curb & Gutter, Median, and Paved Ditch Concrete Barrier Sign Structures Spread Footing Concrete Foundation Pole Foundation (12) Traffic Signal Foundation Drilled Shaft (12) Square or Rectangular	503 424 511 512 540 542 606 637 734 836 878	5.65 (1) 6.05 (2)	7.05	0.32 - 0.44	2 - 4 (5)	3500 (650)			5.0 - 8.0	CA 3 & CA 7, CA 3 & CA 11, CA 5 & CA 7, CA 5 & CA 11, CA 7, CA 11, CA 13, CA 14, or CA 16 (13)

- Notes:
- (1) Central-mixed.
 - (2) Truck-mixed or shrink-mixed. Shrink-mixed concrete will not be permitted for Class PV concrete.
 - (3) For Class SC concrete and for any other class of concrete that is to be placed underwater, except Class DS concrete, the cement factor shall be increased by ten percent.
 - (4) The maximum slump may be increased to 7 in. when a high range water-reducing admixture is used for all classes of concrete, except Class PV, SC, and PP. For Class SC, the maximum slump may be increased to 8 in. For Class PP-1, the maximum slump may be increased to 6 in. For Class PS, the 7 in. maximum slump may be increased to 8 1/2 in. if the high range water-reducing admixture is the polycarboxylate type.
 - (5) The slump range for slipform construction shall be 1/2 to 1 1/2 in.
 - (6) If concrete is placed to displace drilling fluid, or against temporary casing, the slump shall be 8 - 10 in. at the point of placement. If a water-reducing admixture is used in lieu of a high range water-reducing admixture according to Article 1020.05(b)(7), the slump shall be 2 - 4 in.
 - (7) For Class BS concrete used in bridge deck patching, the coarse aggregate gradation shall be CA 13, CA 14, or CA 16, except CA 11 may be used for full-depth patching.
 - (8) In addition to the Type III portland cement, 100 lb/cu yd of ground granulated blast-furnace slag and 50 lb/cu yd of microsilica (silica fume) shall be used. For an air temperature greater than 85 °F, the Type III portland cement may be replaced with Type I or II portland cement.
 - (9) The cement shall be a rapid hardening cement from the Department's "Approved List of Packaged, Dry, Rapid Hardening Cementitious Materials for Concrete Repairs" for PP-4 and calcium aluminate cement for PP-5.
 - (10) For Class PP concrete used in bridge deck patching, the aggregate gradation shall be CA 13, CA 14, or CA 16, except CA 11 may be used for full-depth patching. In addition, the mix design shall have 72 hours to obtain a 4,000 psi compressive or 675 psi flexural strength for all PP mix designs.
 - (11) The nominal maximum size permitted is 3/4 in. Nominal maximum size is defined as the largest sieve which retains any of the aggregate sample particles.
 - (12) The concrete mix shall be designed to remain fluid throughout the anticipated duration of the pour plus one hour. At the Engineer's discretion, the Contractor may be required to conduct a minimum 2 cu yd trial batch to verify the mix design.
 - (13) CA 3 or CA 5 may be used when the nominal maximum size does not exceed two-thirds the clear distance between parallel reinforcement bars, or between the reinforcement bar and the form. Nominal maximum size is defined in Note 11.
 - (14) Alternate combinations of gradations sizes may be used with the approval of the Engineer. Refer also to Article 1004.02(d) for additional information on combining sizes.

TABLE 1. CLASSES OF CONCRETE AND MIX DESIGN CRITERIA (metric)											
Class of Conc.	Use	Specification Section Reference	Cement Factor		Water / Cement Ratio kg/kg	S l u m p mm (4)	Mix Design Compressive Strength (Flexural Strength)			Air Content %	Coarse Aggregate Gradations (14)
			kg/cu m (3)				kPa, minimum				
			Min.	Max			Days				
						3 14 28					
PV	Pavement Base Course	420 or 421 353	335 (1) 360 (2)	418	0.32 - 0.42	50 - 100 (5)	Ty III 24,000 (4500)	24,000 (4500)		5.0 - 8.0	CA 5 & CA 7, CA 5 & CA 11, CA 7, CA 11, or CA 14
	Base Course Widening	354									
	Driveway Pavement	423									
	Shoulders Shoulder Curb	483 662									
PP	Pavement Patching Bridge Deck Patching (10)	442					22,100 (4150) Article 701.17(e)(3)b.				
	PP-1		385 365 (Ty III)	445 425 (Ty III)	0.32 - 0.44	50 - 100	at 48 hours			4.0 - 7.0	CA 7, CA 11, CA 13, CA 14, or CA 16
	PP-2		435	435	0.32 - 0.38	50 - 150	at 24 hours			4.0 - 6.0	
	PP-3		435 (Ty III) (8)	435 (Ty III) (8)	0.32 - 0.35	50 - 100	at 16 hours			4.0 - 6.0	
	PP-4		355 (9)	370 (9)	0.32 - 0.50	50 - 150	at 8 hours			4.0 - 6.0	CA 13, CA 14, or CA 16
	PP-5		400 (9)	400 (9)	0.32 - 0.40	50 - 200	at 4 hours			4.0 - 6.0	
RR	Railroad Crossing	422	385 365 (Ty III)	445 425 (Ty III)	0.32 - 0.44	50 - 100	24,000 (4500) at 48 hours			4.0 - 7.0	CA 7, CA 11, or CA 14
BS	Bridge Superstructure Bridge Approach Slab	503	360	418	0.32 - 0.44	50 - 100 (5)	27,500 (4650)			5.0 - 8.0	CA 7, CA 11, or CA 14 (7)
PC	Various Precast Concrete Items Wet Cast Dry Cast	1042	335 335 (TY III)	418 418 (TY III)	0.32 - 0.44 0.25 - 0.40	25 - 100 0 - 25	See Section 1042			5.0 - 8.0 N/A	CA7, CA11, CA13, CA 14, CA 16, or CA 7 & CA 16
PS	Precast Prestressed Members	504	335 335 (TY III)	418 418 (TY III)	0.32 - 0.44	25 - 100			Plans 34,500 24,000	5.0 - 8.0	CA 11 (11), CA 13, CA 14 (11), or CA 16
	Precast Prestressed Piles and Extensions	512									
	Precast Prestressed Sight Screen	639									

TABLE 1. CLASSES OF CONCRETE AND MIX DESIGN CRITERIA (metric)											
Class of Conc.	Use	Specification Section Reference	Cement Factor		Water / Cement Ratio kg/kg	S l u m p mm (4)	Mix Design Compressive Strength (Flexural Strength)			Air Content %	Coarse Aggregate Gradations (14)
			kg/cu m (3)				kPa, minimum				
			Min.	Max			Days				
						3 14 28					
DS	Drilled Shaft (12)	516	395	418	0.32 - 0.44	150 - 200 (6)		27,500 (4650)		5.0 - 8.0	CA 13, CA 14, CA 16, or a blend of these gradations.
	Metal Shell Piles (12)	512									
	Sign Structures Drilled Shaft (12)	734									
	Light Tower Foundation (12)	837									
SC	Seal Coat	503	335 (1) 360 (2)	418	0.32 - 0.44	75 - 125	24,000 (4500)		Optional 6.0 max.	CA 3 & CA 7, CA 3 & CA 11, CA 5 & CA 7, CA 7 & CA 11, CA 7, or CA 11	
SI	Structures (except Superstructure)	503	335 (1) 360 (2)	418	0.32 - 0.44	50 - 100 (5)		24,000 (4500)		5.0 - 8.0	CA 3 & CA 7, CA 3 & CA 11, CA 5 & CA 7, CA 5 7 CA 11, CA 7, CA 11, CA 13, CA 14, or CA 16 (13)
	Sidewalk	424									
	Slope Wall	511									
	Encasement	512									
	Box Culverts	540									
	End Section and Collar	542									
	Curb, Gutter, Curb & Gutter, Median, and Paved Ditch	606									
	Concrete Barrier	637									
	Sign Structures	734									
	Spread Footing Concrete Foundation	836									
	Pole Foundation (12)	878									
	Traffic Signal Foundation Drilled Shaft (12)										
	Square or Rectangular										

- Notes:
- (1) Central-mixed.
 - (2) Truck-mixed or shrink-mixed. Shrink-mixed concrete will not be permitted for Class PV concrete.
 - (3) For Class SC concrete and for any other class of concrete that is to be placed underwater, except Class DS concrete, the cement factor shall be increased by ten percent.
 - (4) The maximum slump may be increased to 175 mm when a high range water-reducing admixture is used for all classes of concrete except Class PV, SC, and PP. For Class SC, the maximum slump may be increased to 200 mm. For Class PP-1, the maximum slump may be increased to 150 mm. For Class PS, the 175 mm maximum slump may be increased to 215 mm if the high range water-reducing admixture is the polycarboxylate type.
 - (5) The slump range for slipform construction shall be 13 to 40 mm.
 - (6) If concrete is placed to displace drilling fluid, or against temporary casing, the slump shall be 200 - 250 mm at the point of placement. If a water-reducing admixture is used in lieu of a high range water-reducing admixture according to Article 1020.05(b)(7), the slump shall be 50 – 100 mm.
 - (7) For Class BS concrete used in bridge deck patching, the coarse aggregate gradation shall be CA 13, CA 14, or CA 16, except CA 11 may be used for full-depth patching.
 - (8) In addition to the Type III portland cement, 60 kg/cu m of ground granulated blast-furnace slag and 30 kg/cu m of microsilica (silica fume) shall be used. For an air temperature greater than 30 °C, the Type III portland cement may be replaced with Type I or II portland cement.
 - (9) The cement shall be a rapid hardening cement from the Department's "Approved List of Packaged, Dry, Rapid Hardening Cementitious Materials for Concrete Repairs" for PP-4 and calcium aluminate cement for PP-5.
 - (10) For Class PP concrete used in bridge deck patching, the aggregate gradation shall be CA 13, CA 14, or CA 16, except CA 11 may be used for full-depth patching. In addition, the mix design shall have 72 hours to obtain a 27,500 kPa compressive or 4,650 kPa flexural.
 - (11) The nominal maximum size permitted is 19 mm. Nominal maximum size is defined as the largest sieve which retains any of the aggregate sample particles.
 - (12) The concrete mix shall be designed to remain fluid throughout the anticipated duration of the pour plus one hour. At the Engineer's discretion, the Contractor may be required to conduct a minimum 1.5 cu m trial batch to verify the mix design.
 - (13) CA 3 or CA 5 may be used when the nominal maximum size does not exceed two-thirds the clear distance between parallel reinforcement bars, or between the reinforcement bar and the form. Nominal maximum size is defined in Note 11.
 - (14) Alternate combinations of gradation sizes may be used with the approval of the Engineer. Refer also to Article 1004.02(d) for additional information on combining sizes.

1020.05 Other Concrete Criteria. The concrete shall be according to the following.

- (a) Proportioning and Mix Design. For all Classes of concrete, it shall be the Contractors responsibility to determine mix design material proportions and to proportion each batch of concrete. A Level III PCC Technician shall develop the mix design for all Classes of concrete, except Classes PC and PS. The mix design, submittal information, trial batch, and Engineer verification shall be according to the "Portland Cement Concrete Level III Technician" course material.

The Contractor shall provide the mix designs a minimum of 45 calendar days prior to production. More than one mix design may be submitted for each class of concrete.

The Engineer will verify the mix design submitted by the Contractor. Verification of a mix design shall in no manner be construed as acceptance of any mixture produced. Once a mix design has been verified, the Engineer shall be notified of any proposed changes.

Tests performed at the jobsite will determine if a mix design can meet specifications. If the tests indicate it cannot, the Contractor shall make adjustments to a mix design, or submit a new mix design if necessary, to comply with the specifications.

- (b) Admixtures. The Contractor shall be responsible for using admixtures and determining dosages for all Classes of concrete, cement aggregate mixture II, and controlled low-strength material that will produce a mixture with suitable workability, consistency, and plasticity. In addition, admixture dosages shall result in the mixture meeting the specified plastic and hardened properties. The Contractor shall obtain approval from the Engineer to use an accelerator when the concrete temperature is greater than 60 °F (16 °C). However, this accelerator approval will not be required for Class PP, RR, PC, and PS concrete. The accelerator shall be the non-chloride type unless otherwise specified in the contract plans.

The Department will maintain an Approved List of Corrosion Inhibitors. Corrosion inhibitor dosage rates shall be according to Article 1020.05(b)(10). For information on approved controlled low-strength material air-entraining admixtures, refer to Article 1019.02. The Department will also maintain an Approved List of Concrete Admixtures, and an admixture technical representative shall be consulted by the Contractor prior to the pour when determining an admixture dosage from this list or when making minor admixture dosage adjustments at the jobsite. The dosage shall be within the range indicated on the approved list unless the influence by other admixtures, jobsite conditions (such as a very short haul time), or other circumstances warrant a dosage outside the range. The Engineer shall be notified when a dosage is proposed outside the range. To determine an admixture dosage, air temperature, concrete temperature, cement source and quantity, finely divided mineral sources and quantity, influence of other admixtures, haul time, placement conditions, and other factors as appropriate shall be considered. The Engineer may request the Contractor to have a batch of concrete mixed in the lab or field to verify the admixture dosage is correct. An admixture dosage or combination of admixture dosages shall not delay the initial set of concrete by more than one hour. When a retarding admixture is required or appropriate for a bridge deck or bridge deck overlay pour, the initial set time shall be delayed until the deflections due to the concrete dead load are no longer a concern for inducing cracks in the completed work. However, a retarding admixture shall not be used to further extend the pour time and justify the alteration of a bridge deck pour sequence.

When determining water in admixtures for water/cement ratio, the Contractor shall calculate 70 percent of the admixture dosage as water, except a value of 50 percent shall be used for a latex admixture used in bridge deck latex concrete overlays.

The sequence, method, and equipment for adding the admixtures shall be approved by the Engineer. Admixtures shall be added to the concrete separately. An accelerator shall always be added prior to a high range water-reducing admixture, if both are used.

Admixture use shall be according to the following.

- (1) When the atmosphere or concrete temperature is 65 °F (18 °C) or higher, a retarding admixture shall be used in the Class BS concrete and concrete bridge deck overlays. The proportions of the ingredients of the concrete shall be the same as without the retarding admixture, except that the amount of mixing water shall be reduced, as may be necessary, in order to maintain the consistency of the concrete as required. In addition, a high range water-reducing admixture shall be used in bridge deck concrete. At the option of the Contractor, a water-reducing admixture may be used with the high range water-reducing admixture in Class BS concrete.

- (2) At the Contractor's option, admixtures in addition to an air-entraining admixture may be used for Class PP-1 or RR concrete. When the air temperature is less than 55 °F (13 °C) and an accelerator is used, the non-chloride accelerator shall be calcium nitrite.
- (3) When Class C fly ash or ground granulated blast-furnace slag is used in Class PP-1 or RR concrete, a water-reducing or high range water-reducing admixture shall be used.
- (4) For Class PP-2 or PP-3 concrete, a non-chloride accelerator followed by a high range water-reducing admixture shall be used, in addition to the air-entraining admixture. The Contractor has the option to use a water-reducing admixture with the high range water-reducing admixture. For Class PP-3 concrete, the non-chloride accelerator shall be calcium nitrite. For Class PP-2 concrete, the non-chloride accelerator shall be calcium nitrite when the air temperature is less than 55 °F (13 °C).
- (5) For Class PP-4 concrete, a high range water-reducing admixture shall be used in addition to the air-entraining admixture. The Contractor has the option to use a water-reducing admixture with the high range water-reducing admixture. An accelerator shall not be used. For stationary or truck-mixed concrete, a retarding admixture shall be used to allow for haul time. The Contractor has the option to use a mobile portland cement concrete plant, but a retarding admixture shall not be used unless approved by the Engineer.

For PP-5 concrete, a non-chloride accelerator, high range water-reducing admixture, and air-entraining admixture shall be used. The accelerator, high range water-reducing admixture, and air-entraining admixture shall be per the Contractor's recommendation and dosage. The approved list of concrete admixtures shall not apply. A mobile portland cement concrete plant shall be used to produce the patching mixture.

- (6) When a calcium chloride accelerator is specified in the contract, the maximum chloride dosage shall be 1.0 quart (1.0 L) of solution per 100 lb (45 kg) of cement. The dosage may be increased to a maximum 2.0 quarts (2.0 L) per 100 lb (45 kg) of cement if approved by the Engineer. When a calcium chloride accelerator for Class PP-2 concrete is specified in the contract, the maximum chloride dosage shall be 1.3 quarts (1.3 L) of solution per 100 lb (45 kg) of cement. The dosage may be increased to a maximum 2.6 quarts (2.6 L) per 100 lb (45 kg) of cement if approved by the Engineer.
- (7) For Class DS concrete a retarding admixture and a high range water-reducing admixture shall be used. For dry excavations that are 10 ft (3 m) or less, the high range water-reducing admixture may be replaced with a water-reducing admixture if the concrete is vibrated. The use of admixtures shall take into consideration the slump loss limits specified in Article 516.12 and the fluidity requirement in Article 1020.04 (Note 12).

- (8) At the Contractor's option, when a water-reducing admixture or a high range water-reducing admixture is used for Class PV, PP-1, RR, SC, and SI concrete, the cement factor may be reduced a maximum 0.30 hundredweight/cu yd (18 kg/cu m). However, a cement factor reduction will not be allowed for concrete placed underwater.
- (9) When Type F or Type G high range water-reducing admixtures are used, the initial slump shall be a minimum of 1 1/2 in. (40 mm) prior to addition of the Type F or Type G admixture, except as approved by the Engineer.
- (10) When specified, a corrosion inhibitor shall be added to the concrete mixture utilized in the manufacture of precast, prestressed concrete members and/or other applications. It shall be added, at the same rate, to all grout around post-tensioning steel when specified.

When calcium nitrite is used, it shall be added at the rate of 4 gal/cu yd (20 L/cu m), and shall be added to the mix immediately after all compatible admixtures have been introduced to the batch.

When Rheocrete 222+ is used, it shall be added at the rate of 1.0 gal/cu yd (5.0 L/cu m), and the batching sequence shall be according to the manufacturer's instructions.

- (c) Finely Divided Minerals. Use of finely divided minerals shall be according to the following.

- (1) Fly Ash. At the Contractor's option, fly ash from approved sources may partially replace portland cement in cement aggregate mixture II, Class PV, PP-1, PP-2, RR, BS, PC, PS, DS, SC, and SI concrete.

The use of fly ash shall be according to the following.

- a. Measurements of fly ash and portland cement shall be rounded up to the nearest 5 lb (2.5 kg).
 - b. When Class F fly ash is used in cement aggregate mixture II, Class PV, BS, PC, PS, DS, SC, and SI concrete, the amount of portland cement replaced shall not exceed 25 percent by weight (mass).
 - c. When Class C fly ash is used in cement aggregate mixture II, Class PV, PP-1, PP-2, RR, BS, PC, PS, DS, SC, and SI concrete, the amount of portland cement replaced shall not exceed 30 percent by weight (mass).
 - d. Fly ash may be used in concrete mixtures when the air temperature is below 40 °F (4 °C), but the Engineer may request a trial batch of the concrete mixture to show the mix design strength requirement will be met.
- (2) Ground Granulated Blast-Furnace (GGBF) Slag. At the Contractor's option, GGBF slag may partially replace portland cement in concrete mixtures, for Class PV, PP-1, PP-2, RR, BS, PC, PS, DS, SC, and SI concrete. For Class PP-3 concrete, GGBF slag shall be used according to Article 1020.04.

The use of GGBF slag shall be according to the following.

- a. Measurements of GGBF slag and portland cement shall be rounded up to the nearest 5 lb (2.5 kg).
 - b. When GGBF slag is used in Class PV, PP-1, PP-2, RR, BS, PC, PS, DS, SC and SI concrete, the amount of portland cement replaced shall not exceed 35 percent by weight (mass).
 - c. GGBF slag may be used in concrete mixtures when the air temperature is below 40 °F (4 °C), but the Engineer may request a trial batch of the concrete mixture to show the mix design strength requirement will be met.
- (3) Microsilica. At the Contractor's option, microsilica may be added at a maximum of 5.0 percent by weight (mass) of the cement and finely divided minerals summed together.

Microsilica shall be used in Class PP-3 concrete according to Article 1020.04.

- (4) High Reactivity Metakaolin (HRM). At the Contractor's option, HRM may be added at a maximum of 5.0 percent by weight (mass) of the cement and finely divided minerals summed together.
- (5) Mixtures with Multiple Finely Divided Minerals. Except as specified for Class PP-3 concrete, the Contractor has the option to use more than one finely divided mineral in Class PV, PP-1, PP-2, RR, BS, PC, PS, DS, SC, and SI concrete as follows.
- a. The mixture shall contain a maximum of two finely divided minerals. The finely divided mineral in portland-pozzolan cement or portland blast-furnace slag cement shall count toward the total number of finely divided minerals allowed. The finely divided minerals shall constitute a maximum of 35.0 percent of the total cement plus finely divided minerals. The fly ash portion shall not exceed 30.0 percent for Class C fly ash or 25.0 percent for Class F fly ash. The Class C and F fly ash combination shall not exceed 30.0 percent. The ground granulated blast-furnace slag portion shall not exceed 35.0 percent. The microsilica or high-reactivity metakaolin portion used together or separately shall not exceed ten percent. The finely divided mineral in the portland-pozzolan cement or portland blast-furnace slag blended cement shall apply to the maximum 35.0 percent.
 - b. Central Mixed. For Class PV, SC, and SI concrete, the mixture shall contain a minimum of 565 lbs/cu yd (335 kg/cu m) of cement and finely divided minerals summed together. If a water-reducing or high-range water-reducing admixture is used, the Contractor has the option to use a minimum of 535 lbs/cu yd (320 kg/cu m).
 - c. Truck-Mixed or Shrink-Mixed. For Class PV (only truck-mixed permitted), SC, and SI concrete, the mixture shall contain a minimum of 605 lbs/cu yd (360 kg/cu m) of cement and finely divided minerals summed together. If a water-reducing or high-range water-reducing admixture is used, the Contractor has the option to use a minimum of 575 lbs/cu yd (345 kg/cu m).

- d. Central-Mixed, Truck-Mixed or Shrink-Mixed. For Class PP-1 and RR concrete, the mixture shall contain a minimum of 650 lbs/cu yd (385 kg/cu m) of cement and finely divided minerals summed together. For Class PP-1 and RR concrete using Type III portland cement, the mixture shall contain a minimum of 620 lbs/cu yd (365 kg/cu m).

For Class PP-2 concrete, the mixture shall contain a minimum of 735 lbs/cu yd (435 kg/cu m) of cement and finely divided minerals summed together. For Class BS concrete, the mixture shall contain a minimum of 605 lbs/cu yd (360 kg/cu m). For Class DS concrete, the mixture shall contain a minimum of 665 lbs/cu yd (395 kg/cu m).

If a water-reducing or high range water-reducing admixture is used in Class PP-1 and RR concrete, the Contractor has the option to use a minimum of 620 lbs/cu yd (365 kg/cu m) of cement and finely divided minerals summed together. If a water-reducing or high-range water-reducing admixture is used with Type III portland cement in Class PP-1 and RR concrete, the Contractor has the option to use a minimum of 590 lbs/cu yd (350 kg/cu m).

- e. Central-Mixed or Truck-Mixed. For Class PC and PS concrete, the mixture shall contain a minimum of 565 lbs/cu yd (335 kg/cu m) of cement and finely divided minerals summed together.
 - f. The mixture shall contain a maximum of 705 lbs/cu yd (418 kg/cu m) of cement and finely divided mineral(s) summed together for Class PV, BS, PC, PS, DS, SC, and SI concrete. For Class PP-1 and RR concrete, the mixture shall contain a maximum of 750 lbs/cu yd (445 kg/cu m). For Class PP-1 and RR concrete using Type III portland cement, the mixture shall contain a maximum of 720 lbs/cu yd (425 kg/cu m). For Class PP-2 concrete, the mixture shall contain a maximum of 735 lbs/cu yd (435 kg/cu m).
 - g. For Class SC concrete and for any other class of concrete that is to be placed underwater, except Class DS concrete, the allowable cement and finely divided minerals summed together shall be increased by ten percent.
 - h. The combination of cement and finely divided minerals shall comply with Article 1020.05(d).
- (d) Alkali-Silica Reaction. For cast-in-place (includes cement aggregate mixture II), precast, and precast prestressed concrete, one of the mixture options provided in Article 1020.05(d)(2) shall be used to reduce the risk of a deleterious alkali-silica reaction in concrete exposed to humid or wet conditions. The mixture options are not intended or adequate for concrete exposed to potassium acetate, potassium formate, sodium acetate, or sodium formate. The mixture options will not be required for the dry environment (humidity less than 60 percent) found inside buildings for residential or commercial occupancy.

The mixture options shall not apply to concrete revetment mats, insertion lining of pipe culverts, portland cement mortar fairing course, controlled low-strength material, miscellaneous grouts that are not prepackaged, Class PP-3 concrete, Class PP-4 concrete, and Class PP-5 concrete.

- (1) Aggregate Groups. Each combination of aggregates used in a mixture will be assigned to an aggregate group. The point at which the coarse aggregate and fine aggregate expansion values intersect in the following table will determine the group.

Aggregate Groups			
Coarse Aggregate or Coarse Aggregate Blend	Fine Aggregate Or Fine Aggregate Blend		
	ASTM C 1260 Expansion		
ASTM C 1260 Expansion	≤0.16%	>0.16% - 0.27%	>0.27%
≤0.16%	Group I	Group II	Group III
>0.16% - 0.27%	Group II	Group II	Group III
>0.27%	Group III	Group III	Group IV

- (2) Mixture Options. Based upon the aggregate group, the following mixture options shall be used. However, the Department may prohibit a mixture option if field performance shows a deleterious alkali-silika reaction or Department testing indicates the mixture may experience a deleterious alkali-silica reaction.

Group I – Mixture options are not applicable. Use any cement or finely divided mineral.

Group II – Mixture options 1, 2, 3, 4, or 5 shall be used.

Group III – Mixture options 1, combine 2 with 3, 4 or 5 shall be used.

Group IV – Mixture options 1, combine 2 with 4, or 5 shall be used.

- a. Mixture Option 1. The coarse or fine aggregates shall be blended to place the material in a group that will allow the selected cement or finely divided mineral to be used. Coarse aggregate may only be blended with another coarse aggregate. Fine aggregate may only be blended with another fine aggregate. Blending of coarse with fine aggregate to place the material in another group will not be permitted.

When a coarse for fine aggregate is blended, the weighted expansion value shall be calculated separately for the coarse and fine aggregate as follows:

$$\text{Weighted Expansion Value} = (a/100 \times A) + (b/100 \times B) + (c/100 \times C) + \dots$$

Where: a, b, c... = percentage of aggregate in the blend;
A, B, C... = expansion value for that aggregate.

- b. Mixture Option 2. A finely divided mineral shall be used as described in 1), 2), 3), or 4) that follow.

1. Class F Fly Ash. For cement aggregate mixture II, Class PV, BS, PC, PS, MS, DS, SC and SI concrete, the Class F fly ash shall be a minimum 25.0 percent by weight (mass) of the cement and finely divided minerals summed together.

If the maximum total equivalent available alkali content ($\text{Na}_2\text{O} + 0.658\text{K}_2\text{O}$) exceeds 4.50 percent for the Class F fly ash, it may be used only if it complies with Mixture Option 5.

2. Class C Fly Ash. For cement aggregate mixture II, Class PV, PP-1, PP-2, RR, BS, PC, PS, DS, SC, and SI concrete, Class C fly ash shall be a minimum of 25.0 percent by weight (mass) of the cement and finely divided minerals summed together.

If the maximum total equivalent available alkali content ($\text{Na}_2\text{O} + 0.658\text{K}_2\text{O}$) exceeds 4.50 percent or the calcium oxide exceeds 26.50 percent for the Class C fly ash, it may be used only per Mixture Option 5.

3. Ground Granulated Blast-Furnace Slag. For Class PV, PP-1, PP-2, RR, BS, PC, PS, DS, SC, and SI concrete, ground granulated blast-furnace slag shall be a minimum of 25.0 percent by weight (mass) of the cement and finely divided minerals summed together.

If the maximum total equivalent available alkali content ($\text{Na}_2\text{O} + 0.658\text{K}_2\text{O}$) exceeds 1.00 percent for the ground granulated blast-furnace slag, it may be used only per Mixture Option 5.

4. Microsilica or High Reactivity Metakaolin, Microsilica solids or high reactivity metakaolin shall be a minimum 5.0 percent by weight (mass) of the cement and finely divided minerals summed together.

If the maximum total equivalent available alkali content ($\text{Na}_2\text{O} + 0.658\text{K}_2\text{O}$) exceeds 1.00 percent for the Microsilica or High Reactivity Metakaolin, it may be used only if it complies with Mixture Option 5.

- c. Mixture Option 3. The cement used shall have a maximum total equivalent alkali content ($\text{Na}_2\text{O} + 0.658\text{K}_2\text{O}$) of 0.60 percent. When aggregate in Group II is involved and the Contractor desires to use a finely divided mineral, any finely divided mineral may be used with the cement unless the maximum total equivalent available alkali content ($\text{Na}_2\text{O} + 0.658\text{K}_2\text{O}$) exceeds 4.50 percent for the fly ash; or 1.00 percent for the ground granulated blast-furnace slag, microsilica or high reactivity metakaolin. If the alkali content is exceeded, the finely divided mineral may be used only per Mixture Option 5.
- d. Mixture option 4. The cement used shall have a maximum total equivalent alkali content ($\text{Na}_2\text{O} + 0.658\text{K}_2\text{O}$) of 0.45 percent. When aggregate in Group II or III is involved and the Contractor desires to use a finely divided mineral, any finely divided mineral may be used with the cement unless the maximum total equivalent available alkali content ($\text{Na}_2\text{O} + 0.658\text{K}_2\text{O}$) exceeds 4.50 percent for the fly ash; or 1.00 percent for the ground granulated blast-furnace slag, microsilica, or high reactivity metakaolin. If the alkali content is exceeded, the finely divided mineral may be used only per Mixture Option 5.

- e. Mixture Option 5. The proposed cement or finely divided mineral may be used if the ASTM C 1567 expansion value is ≤ 0.16 percent when performed on the aggregate in the concrete mixture with the highest ASTM C 1260 test result. The laboratory performing the ASTM C 1567 test shall be approved by the Department according to the current Bureau of Materials and Physical Research Policy Memorandum "Minimum Laboratory Requirements for Alkali-Silica Reactivity (ASR) Testing". The ASTM C 1567 test will be valid for two years, unless the Engineer determines the materials have changed significantly. For latex concrete, the ASTM C 1567 test shall be performed without the latex. The 0.20 percent autoclave expansion limit in ASTM C 1567 shall not apply.

If during the two year time period the Contractor needs to replace the cement, and the replacement cement has an equal or lower total equivalent alkali content ($\text{Na}_2\text{O} + 0.658\text{K}_2\text{O}$), a new ASTM C 1567 test will not be required.

The Engineer reserved the right to verify a Contractor's ASTM C 1567 test result. When the Contractor performs the test, a split sample may be requested by the Engineer. The Engineer may also independently obtain a sample at any time. The proposed cement or finely divided mineral will not be allowed for use if the Contractor or Engineer obtains an expansion value greater than 0.16 percent.

1020.06 Water/Cement Ratio. The water/cement ratio shall be determined on a weight (mass) basis. When a maximum water/cement ratio is specified, the water shall include mixing water, water in admixtures, free moisture on the aggregates, and water added at the jobsite. The quantity of water may be adjusted within the limit specified to meet slump requirements.

When fly ash, ground granulated blast-furnace slag, high-reactivity metakaolin, or microsilica (silica fume) are used in a concrete mix, the water/cement ratio will be based on the total cement and finely divided minerals contained in the mixture.

1020.07 Slump. The slump shall be determined according to Illinois Modified AASHTO T 119.

If the measured slump falls outside the limits specified, a check test will be made. In the event of a second failure, the Engineer may refuse to permit the use of the batch of concrete represented.

If the Contractor is unable to add water to prepare concrete of the specified slump without exceeding the maximum design water/cement ratio, additional cement or water-reducing admixture shall be added.

1020.08 Air Content. The air content shall be determined according to Illinois Modified AASHTO T 152 or Illinois Modified AASHTO T 196. The air-entrainment shall be obtained by the use of cement with an approved air-entraining admixture added during the mixing of the concrete or the use of air-entraining cement.

If the air-entraining cement furnished is found to produce concrete having an air content outside the limits specified, its use shall be discontinued immediately and the Contractor shall provide other air-entraining cement which will produce air contents within the specified limits.

If the air content obtained is above the specified maximum limit at the jobsite, the Contractor, with the Engineer's approval, may add to the truck mixer non air-entraining cement in the proportion necessary to bring the air content within the specified limits, or the concrete may be further mixed, within the limits of time and revolutions specified, to reduce the air content. If the air content obtained is below the specified minimum limit, the Contractor may add to the concrete a sufficient quantity of an approved air-entraining admixture at the jobsite to bring the air content within the specified limits.

1020.09 Strength Tests. The specimens shall be molded and cured according to Illinois Modified AASHTO T 23. Specimens shall be field cured with the construction item as specified in Illinois Modified AASHTO T 23. The compressive strength shall be determined according to Illinois Modified AASHTO T 22. The flexural strength shall be determined according to Illinois Modified AASHTO T 177.

Except for Class PC and PS concrete, the Contractor shall transport the strength specimens from the site of the work to the field laboratory or other location as instructed by the Engineer. During transportation in a suitable light truck, the specimens shall be embedded in straw, burlap, or other acceptable material in a manner meeting with the approval of the Engineer to protect them from damage; care shall be taken to avoid impacts during hauling and handling. For strength specimens, the Contractor shall provide a water storage tank for curing.

1020.10 Handling, Measuring, and Batching Materials. Aggregates shall be handled in a manner to prevent mixing with soil and other foreign material.

Aggregates shall be handled in a manner which produces a uniform gradation, before placement in the plant bins. Aggregates delivered to the plant in a nonuniform gradation condition shall be stockpiled. The stockpiled aggregate shall be mixed uniformly before placement in the plant bins.

Aggregates shall have a uniform moisture content before placement in the plant bins. This may require aggregates to be stockpiled for 12 hours or more to allow drainage, or water added to the stockpile, or other methods approved by the Engineer. Moisture content requirements for crushed slag or lightweight aggregate shall be according to Article 1004.01(e).

Aggregates, cement, and finely divided minerals shall be measured by weight (mass). Water and admixtures shall be measured by volume or weight (mass).

The Engineer may permit aggregates, cement, and finely divided minerals to be measured by volume for small isolated structures and for miscellaneous items. Aggregates, cement, and finely divided minerals shall be measured individually. The volume shall be based upon dry, loose materials.

1020.11 Mixing Portland Cement Concrete. The mixing of concrete shall be according to the following.

(a) Ready-Mixed Concrete. Ready-mixed concrete is central-mixed, truck-mixed, or shrink-mixed concrete transported and delivered in a plastic state ready for placement in the work and shall be according to the following.

(1) Central-Mixed Concrete. Central-mixed concrete is concrete which has been completely mixed in a stationary mixer and delivered in a truck agitator, a truck mixer operating at agitating speed, or a nonagitator truck.

The stationary mixer shall operate at the drum speed for which it was designed. The batch shall be charged into the drum so that some of the water shall enter in advance of the cement, finely divided minerals, and aggregates. The flow of the water shall be uniform and all water shall be in the drum by the end of the first 15 seconds of the mixing period. Water shall begin to enter the drum from zero to two seconds in advance of solid material and shall stop flowing within two seconds of the beginning of mixing time.

Some coarse aggregate shall enter in advance of other solid materials. For the balance of the charging time for solid materials, the aggregates, finely divided minerals, and cement (to assure thorough blending) shall each flow at acceptably uniform rates, as determined by visual observation. Coarse aggregate shall enter two seconds in advance of other solid materials and a uniform rate of flow shall continue to within two seconds of the completion of charging time.

The entire contents of the drum, or of each single compartment of a multiple-drum mixer, shall be discharged before the succeeding batch is introduced.

The volume of concrete mixed per batch shall not exceed the mixer's rated capacity as shown on the standard rating plate on the mixer by more than ten percent.

The minimum mixing time shall be 75 seconds for a stationary mixer having a capacity greater than 2 cu yd (1.5 cu m). For a mixer with a capacity equal to or less than 2 cu yd (1.5 cu m) the mixing time shall be 60 seconds. Transfer time in multiple drum mixers is included in the mixing time. Mixing time shall begin when all materials are in the mixing compartment and shall end when the discharge of any part of the batch is started. The required mixing times will be established by the Engineer for all types of stationary mixers.

When central-mixed concrete is to be transported in a truck agitator or a truck mixer, the stationary-mixed batch shall be transferred to the agitating unit without delay and without loss of any portion of the batch. Agitating shall start immediately thereafter and shall continue without interruption until the batch is discharged from the agitator. The ingredients of the batch shall be completely discharged from the agitator before the succeeding batch is introduced. Drums and auxiliary parts of the equipment shall be kept free from accumulations of materials.

The vehicles used for transporting the mixed concrete shall be of such capacity, or the batches shall be so proportioned, that the entire contents of the mixer drum can be discharged into each vehicle load.

- (2) **Truck-Mixed Concrete.** Truck-mixed concrete is completely mixed and delivered in a truck mixer. When the mixer is charged with fine and coarse aggregates simultaneously, not less than 60 nor more than 100 revolutions of the drum or blades at mixing speed shall be required, after all of the ingredients including water are in the drum. When fine and coarse aggregates are charged separately, not less than 70 revolutions will be required. Additional mixing beyond 100 revolutions shall be at agitating speed unless additions of water, admixtures, cement, or other materials are made at the jobsite. The mixing operation shall begin immediately after the cement and water, or the cement and wet aggregates, come in contact. The ingredients of the batch shall be completely discharged from the drum before the succeeding batch is introduced. The drum and auxiliary parts of the equipment shall be kept free from accumulations of materials. If additional water or an admixture is added at the jobsite, the concrete batch shall be mixed a minimum of 40 additional revolutions after each addition.
- (3) **Shrink-Mixed Concrete.** Shrink-mixed concrete is mixed partially in a stationary mixer and completed in a truck mixer for delivery. The mixing time of the stationary mixer may be reduced to a minimum of 30 seconds to intermingle the ingredients, before transferring to the truck mixer. All ingredients for the batch shall be in the stationary mixer and partially mixed before any of the mixture is discharged into the truck mixer. The partially mixed batch shall be transferred to the truck mixer without delay and without loss of any portion of the batch, and mixing in the truck mixer shall start immediately. The mixing time in the truck mixer shall be not less than 50 nor more than 100 revolutions of the drum or blades at mixing speed. Additional mixing beyond 100 revolutions shall be at agitating speed, unless additions of water, admixtures, cement, or other materials are made at the jobsite. Units designed as agitators shall not be used for shrink mixing. The ingredients of the batch shall be completely discharged from the drum before the succeeding batch is introduced. The drum and auxiliary parts of the equipment shall be kept free from accumulations of materials. If additional water or an admixture is added at the jobsite, the concrete batch shall be mixed a minimum of 40 additional revolutions after each addition.
- (4) **Mixing Water.** Wash water shall be completely discharged from the drum or container before a batch is introduced. All mixing water shall be added at the plant and any adjustment of water at the jobsite by the Contractor shall not exceed the specified maximum water/cement ratio or slump. If strength specimens have been made for a batch of concrete, and subsequently during discharge there is more water added, additional strength specimens shall be made for the batch of concrete. No additional water may be added at the jobsite to central-mixed concrete if the mix design has less than 565 lbs/cu yd (335 kg/cu m) of cement and finely divided minerals summed together.
- (5) **Mixing and Agitating Speeds.** The mixing or agitating speeds used for truck mixers or truck agitators shall be per the manufacturer's rating plate.
- (6) **Capacities.** The volume of plastic concrete in a given batch will be determined according to AASHTO T 121, based on the total weight (mass) of the batch, determined either from the weight (masses) of all materials, including water, entering the batch or directly from the net weight (mass) of the concrete in the batch as delivered.

The volume of mixed concrete in truck mixers or truck agitators shall in no case be greater than the rated capacity determined according to the Truck Mixer, Agitator, and Front Discharge Concrete Carrier Standards of the Truck Mixer Manufacturer's Bureau, as shown by the rating plate attached to the truck. If the truck mixer does not have a rating plate, the volume of mixed concrete shall not exceed 63 percent of the gross volume of the drum or container, disregarding the blades. For truck agitators, the value is 80 percent.

- (7) Time of Haul. Haul time shall begin when the delivery ticket is stamped. The delivery ticket shall be stamped no later than five minutes after the addition of the mixing water to the cement, or after the addition of the cement to the aggregate when the combined aggregates contain free moisture in excess of two percent by weight (mass). If more than one batch is required for charging a truck using a stationary mixer, the time of haul shall start with mixing of the first batch. Haul time shall end when the truck is emptied for incorporation of the concrete into the work.

The time elapsing from when water is added to the mix until it is deposited in place at the site of the work shall not exceed 30 minutes when the concrete is transported in nonagitating trucks.

The maximum haul time for concrete transported in truck mixers or truck agitators shall be according to the following.

Concrete Temperature at Point of Discharge °F (°C)	Haul Time	
	Hours	Minutes
50-64 (10-17.5)	1	30
>64 (>17.5) - without retarder	1	0
>64 (>17.5) - with retarder	1	30

To encourage start-up testing for mix adjustments at the plant, the first two trucks will be allowed an additional 15 minutes haul time whenever such testing is performed.

For a mixture which is not mixed on the jobsite, a delivery ticket shall be required for each load. The following information shall be recorded on each delivery ticket: (1) ticket number; (2) name of producer and plant location; (3) contract number; (4) name of Contractor; (5) stamped date and time batched; (6) truck number; (7) quantity batched; (8) amount of admixture(s) in the batch; (9) amount of water in the batch; and (10) Department mix design number.

For concrete mixed in jobsite stationary mixers, the above delivery ticket may be waived, but a method of verifying the haul time shall be established to the satisfaction of the Engineer.

- (8) Production and Delivery. The production of ready-mixed concrete shall be such that the operations of placing and finishing will be continuous insofar as the job operations require. The Contractor shall be responsible for producing concrete that will have the required workability, consistency, and plasticity when delivered to the work. Concrete which is unsuitable for placement as delivered will be rejected. The Contractor shall minimize the need to adjust the mixture at the jobsite, such as adding water, admixtures, and cement prior to discharging.

- (9) Use of Multiple Plants in the Same Construction Item. The Contractor may simultaneously use central-mixed, truck-mixed, and shrink-mixed concrete from more than one plant, for the same construction item, on the same day, and in the same pour. However, the following criteria shall be met.
- a. Each plant shall use the same cement, finely divided minerals, aggregates, admixtures, and fibers.
 - b. Each plant shall use the same mix design. However, material proportions may be altered slightly in the field to meet slump and air content criteria. Field water adjustments shall not result in a difference that exceeds 0.02 between plants for water/cement ratio. The required cement factor for central-mixed concrete shall be increased to match truck-mixed or shrink-mixed concrete, if the latter two types of mixed concrete are used in the same pour.
 - c. The maximum slump difference between deliveries of concrete shall be 3/4 in. (19 mm) when tested at the jobsite. If the difference is exceeded, but test results are within specification limits, the concrete may be used. The Contractor shall take immediate corrective action and shall test subsequent deliveries of concrete until the slump difference is corrected. For each day, the first three truck loads of delivered concrete from each plant shall be tested for slump by the Contractor. Thereafter, when a specified test frequency for slump is to be performed, it shall be conducted for each plant at the same time.
 - d. The maximum air content difference between deliveries of concrete shall be 1.5 percent when tested at the jobsite. If the difference is exceeded, but test results are within specification limits, the concrete may be used. The Contractor shall take immediate corrective action and shall test subsequent deliveries of concrete until the air content difference is corrected. For each day, the first three truck loads of delivered concrete from each plant shall be tested for air content by the Contractor. Thereafter, when a specified test frequency for air content is to be performed, it shall be conducted for each plant at the same time.
 - e. Strength tests shall be performed and taken at the jobsite for each plant. When a specified strength test is to be performed, it shall be conducted for each plant at the same time. The difference between plants for strength shall not exceed 900 psi (6200 kPa) compressive and 90 psi (620 kPa) flexural. If the strength difference requirements are exceeded, the Contractor shall take corrective action.
 - f. The maximum haul time difference between deliveries of concrete shall be 15 minutes. If the difference is exceeded, but haul time is within specification limits, the concrete may be used. The Contractor shall take immediate corrective action and check subsequent deliveries of concrete.
- (b) Class PC Concrete. The concrete shall be central-mixed or truck-mixed. Variations in plastic concrete properties shall be minimized between batches.
- (c) Class PV Concrete. The concrete shall be central-mixed or truck-mixed.

The required mixing time for stationary mixers with a capacity greater than 2 cu yd (1.5 cu m) may be less than 75 seconds upon satisfactory completion of a mixer performance test. Mixer performance tests may be requested by the Contractor when the quantity of concrete to be placed exceeds 50,000 sq yd (42,000 sq m). The testing shall be conducted according to the current Bureau of Materials and Physical Research's Policy Memorandum, "Field Test Procedures for Mixer Performance and Concrete Uniformity Tests".

The Contractor will be allowed to test two mixing times within a range of 50 to 75 seconds. If satisfactory results are not obtained from the required tests, the mixing time shall continue to be 75 seconds for the remainder of the contract. If satisfactory results are obtained, the mixing time may be reduced. In no event will mixing time be less than 50 seconds.

The Contractor shall furnish the labor, equipment, and material required to perform the testing according to the current Bureau of Materials and Physical Research's Policy Memorandum, "Field Test Procedures for Mixer Performance and Concrete Uniformity Tests".

A contract which has 12 ft (3.6 m) wide pavement or base course, and a continuous length of 1/2 mile (0.8 km) or more, shall have the following additional requirements.

- (1) The plant and truck delivery operation shall be able to provide a minimum of 50 cu yd (38 cu m) of concrete per hour.
- (2) The plant shall have automatic or semi-automatic batching equipment.

(d) All Other Classes of Concrete. The concrete shall be central-mixed, truck-mixed, or shrink-mixed concrete.

1020.12 Mobile Portland Cement Concrete Plants. The use of a mobile portland cement concrete plant may be approved under the provisions of Article 1020.10 for volumetric proportioning in small isolated structures, thin overlays, and for miscellaneous and incidental concrete items.

The first 1 cu ft (0.03 cu m) of concrete produced may not contain sufficient mortar and shall not be incorporated in the work. The side plate on the cement feeder shall be removed periodically (normally the first time the mixer is used each day) to see if cement is building up on the feed drum.

Sufficient mixing capacity of mixers shall be provided to enable continuous placing and finishing insofar as the job operations and the specifications require.

Slump and air tests made immediately after discharge of the mix may be misleading, since the aggregates may absorb a significant amount of water for four or five minutes after mixing.

1020.13 Curing and Protection. The method of curing, curing period, and method of protection for each type of concrete construction is included in the following Index Table.

INDEX TABLE OF CURING AND PROTECTION OF CONCRETE CONSTRUCTION			
TYPE OF CONSTRUCTION	CURING METHODS	CURING PERIOD DAYS	LOW AIR TEMPERATURE PROTECTION METHODS
Cast-in-Place Concrete ^{11/}			
Pavement			
Shoulder	1020.13(a)(1)(2)(3)(4)(5) ^{3/ 5/}	3	1020.13(c)
Base Course			
Base Course Widening	1020.13(a)(1)(2)(3)(4)(5) ^{2/}	3	1020.13(c)
Driveway			
Median			
Barrier			
Curb			
Gutter	1020.13(a)(1)(2)(3)(4)(5) ^{4/ 5/}	3	1020.13(c) ^{16/}
Curb & Gutter			
Sidewalk			
Slope Wall			
Paved Ditch			
Catch Basin			
Manhole	1020.13(a)(1)(2)(3)(4)(5) ^{4/}	3	1020.13(c)
Inlet			
Valve Vault			
Pavement Patching	1020.13(a)(1)(2)(3)(4)(5) ^{2/}	3 ^{12/}	1020.13(c)
Bridge Deck Patching	1020.13(a)(3)(5)	3 or 7 ^{12/}	1020.13(c)
Railroad Crossing	1020.13(a)(3)(5)	1	1020.13(c)
Piles and Drilled Shafts	1020.13(a)(3)(5)	7	1020.13(d)(1)(2)(3)
Foundations & Footings			
Seal Coat	1020.13(a)(1)(2)(3)(4)(5) ^{4/ 6/}	7	1020.13(d)(1)(2)(3)
Substructure	1020.13(a)(1)(2)(3)(4)(5) ^{1/ 7/}	7	1020.13(d)(1)(2)(3)
Superstructure (except deck)	1020.13(a)(1)(2)(3)(5) ^{8/}	7	1020.13(d)(1)(2)
Deck			
Bridge Approach Slab	1020.13(a)(5)	7	1020.13(d)(1)(2) ^{17/}
Retaining Walls	1020.13(a)(1)(2)(3)(4)(5) ^{1/ 7/}	7	1020.13(d)(1)(2)
Pump Houses	1020.13(a)(1)(2)(3)(4)(5) ^{1/}	7	1020.13(d)(1)(2)
Culverts	1020.13(a)(1)(2)(3)(4)(5) ^{4/ 6/}	7	1020.13(d)(1)(2) ^{18/}
Other Incidental Concrete	1020.13(a)(1)(2)(3)(5)	3	1020.13(c)
Precast Concrete ^{11/}			
Bridge Slabs			
Piles and Pile Caps	1020.13(a)(3)(5) ^{9/ 10/}	As ^{13/}	9/
Other Structural Members		Required	
All Other Precast Items	1020.13(a)(3)(4)(5) ^{2/ 9/ 10/}	As ^{14/}	9/
		Required	
Precast, Prestressed Concrete ^{11/}			
All Items	1020(a)(3)(5) ^{9/ 10/}	Until Strand Tensioning is Released ^{15/}	9/

Notes-General:

- 1/ Type I, membrane curing only
- 2/ Type II, membrane curing only
- 3/ Type III, membrane curing only
- 4/ Type I, II and III membrane curing
- 5/ Membrane Curing will not be permitted between November 1 and April 15.

- 6/ The use of water to inundate foundations and footings, seal coats or the bottom slab of culverts is permissible when approved by the Engineer, provided the water temperature can be maintained at 45 °F (7 °C) or higher.
- 7/ Asphalt emulsion for waterproofing may be used in lieu of other curing methods when specified and permitted according to Article 503.18.
- 8/ On non-traffic surfaces which receive protective coat according to Article 503.19, a linseed oil emulsion curing compound may be used as a substitute for protective coat and other curing methods. The linseed oil emulsion curing compound will be permitted between April 16 and October 31 of the same year, provided it is applied with a mechanical sprayer according to Article 1101.09(b).
- 9/ Steam, supplemental heat, or insulated blankets (with or without steam/supplemental heat) are acceptable and shall be according to the Bureau of Materials and Physical Research's Policy Memorandum "Quality Control/Quality Assurance Program for Precast Concrete Products" and the "Manual for Fabrication of Precast, Prestressed Concrete Products".
- 10/ A moist room according to AASHTO M 201 is acceptable for curing.
- 11/ If curing is required and interrupted because of form removal for cast-in-place concrete items, precast concrete products, or precast prestressed concrete products, the curing shall be resumed within two hours from the start of the form removal.
- 12/ Curing maintained only until opening strength is attained for pavement patching, with a maximum curing period of three days. For bridge deck patching the curing period shall be three days if Class PP concrete is used and 7 days if Class BS concrete is used.
- 13/ The curing period shall end when the concrete has attained the mix design strength. The producer has the option to discontinue curing when the concrete has attained 80 percent of the mix design strength or after seven days. All strength test specimens shall remain with the units and shall be subjected to the same curing method and environmental condition as the units, until the time of testing.
- 14/ The producer shall determine the curing period or may elect to not cure the product. All strength test specimens shall remain with the units and shall be subjected to the same curing method and environmental condition as the units, until the time of testing.
- 15/ The producer has the option to continue curing after strand release.
- 16/ When structural steel or structural concrete is in place above slope wall, Article 1020.13(c) shall not apply. The protection method shall be according to Article 1020.13(d)(1).
- 17/ When Article 1020.13(d)(2) is used to protect the deck, the housing may enclose only the bottom and sides. The top surface shall be protected according to Article 1020.13(d)(1).

18/ For culverts having a waterway opening of 10 sq ft (1 sq m) or less, the culverts may be protected according to Article 1020.13(d)(3).

(a) Methods of Curing. Except as provided for in the Index Table of Curing and Protection of Concrete Construction, curing shall be accomplished by one of the following described methods. When water is required to wet the surface, it shall be applied as a fine spray so that it will not mar or pond on the surface. Except where otherwise specified, the curing period shall be at least 72 hours.

(1) Waterproof Paper Method. The surface of the concrete shall be covered with waterproof paper as soon as the concrete has hardened sufficiently to prevent marring the surface. The surface of the concrete shall be wetted immediately before the paper is placed. The blankets shall be lapped at least 12 in. (300 mm) end to end, and these laps shall be securely weighted with a windrow of earth, or other approved method, to form a closed joint. The same requirements shall apply to the longitudinal laps where separate strips are used for curing edges, except the lap shall be at least 9 in. (225 mm). The edges of the blanket shall be weighted securely with a continuous windrow of earth or any other means satisfactory to the Engineer to provide an air-tight cover. Any torn places or holes in the paper shall be repaired immediately by patches cemented over the openings, using a bituminous cement having a melting point of not less than 180 °F (82 °C). The blankets may be reused, provided they are air-tight and kept serviceable by proper repairs.

A longitudinal pleat shall be provided in the blanket to permit shrinkage where the width of the blanket is sufficient to cover the entire surface. The pleat will not be required where separate strips are used for the edges. Joints in the blanket shall be sewn or cemented together in such a manner that they will not separate during use.

(2) Polyethylene Sheeting Method. The surface of the concrete shall be covered with white polyethylene sheeting as soon as the concrete has hardened sufficiently to prevent marring the surface. The surface of the concrete shall be wetted immediately before the sheeting is placed. The edges of the sheeting shall be weighted securely with a continuous windrow of earth or any other means satisfactory to the Engineer to provide an air-tight cover. Adjoining sheets shall overlap not less than 12 in. (300 mm) and the laps shall be securely weighted with earth, or any other means satisfactory to the Engineer, to provide an air tight cover. For surface and base course concrete, the polyethylene sheets shall be not less than 100 ft (30 m) in length nor longer than can be conveniently handled, and shall be of such width that, when in place, they will cover the full width of the surface, including the edges, except that separate strips may be used to cover the edges. Any tears or holes in the sheeting shall be repaired. When sheets are no longer serviceable as a single unit, the Contractor may select from such sheets and reuse those which will serve for further applications, provided two sheets are used as a single unit; however, the double sheet units will be rejected when the Engineer deems that they no longer provide an air tight cover.

- (3) Wetted Burlap Method. The surface of the concrete shall be covered with wetted burlap blankets as soon as the concrete has hardened sufficiently to prevent marring the surface. The blankets shall overlap 6 in. (150 mm). At least two layers of wetted burlap shall be placed on the finished surface. The burlap shall be kept saturated by means of a mechanically operated sprinkling system. In place of the sprinkling system, at the Contractor's option, two layers of burlap covered with impermeable covering shall be used. The burlap shall be kept saturated with water. Plastic coated burlap may be substituted for one layer of burlap and impermeable covering.

The blankets shall be placed so that they are in contact with the edges of the concrete, and that portion of the material in contact with the edges shall be kept saturated with water.

- (4) Membrane Curing Method. Membrane curing will not be permitted where a protective coat, concrete sealer, or waterproofing is to be applied, or at areas where rubbing or a normal finish is required, or at construction joints other than those necessary in pavement or base course. Concrete at these locations shall be cured by another method specified in Article 1020.13(a).

After the concrete has been finished and the water sheen has disappeared from the surface, the concrete shall be immediately sealed with membrane curing compound of the type specified. The seal shall be maintained for the specified curing period. The edges of the concrete shall, likewise, be sealed immediately after the forms are removed. Two separate applications, applied at least one minute apart, each at the rate of not less than 1 gal/250 sq ft (0.16 L/sq m) will be required upon the surfaces and edges of the concrete. These applications shall be made with the mechanical equipment specified. Type III compound shall be agitated immediately before and during the application.

At locations where the coating is discontinuous or where pin holes show or where the coating is damaged due to any cause and on areas adjacent to sawed joints, immediately after sawing is completed, an additional coating of membrane curing compound shall be applied at the above specified rate. The equipment used may be of the same type as that used for coating variable widths of pavement. Before the additional coating is applied adjacent to sawed joints, the cut faces of the joint shall be protected by inserting a suitable flexible material in the joint, or placing an adhesive width of impermeable material over the joint, or by placing the permanent sealing compound in the joint. Material, other than the permanent sealing compound, used to protect cut faces of the joint, shall remain in place for the duration of the curing period. In lieu of applying the additional coating, the area of the sawed joint may be cured according to any other method permitted.

When rain occurs before an application of membrane curing compound has dried, and the coating is damaged, the Engineer may require another application be made in the same manner and at the same rate as the original coat. The Engineer may order curing by another method specified, if unsatisfactory results are obtained with membrane curing compound.

(5) **Wetted Cotton Mat Method.** After the surface of concrete has been textured or finished, it shall be covered immediately with dry or damp cotton mats. The cotton mats shall be placed in a manner which will not mar the concrete surface. A texture resulting from the cotton mat material is acceptable. The cotton mats shall then be wetted immediately and thoroughly soaked with a gentle spray of water. For bridge decks, a foot bridge shall be used to place and wet the cotton mats.

The cotton mats shall be maintained in a wetted condition until the concrete has hardened sufficiently to place soaker hoses without marring the concrete surface. The soaker hoses shall be placed on top of the cotton mats at a maximum 4 ft (1.2 m) spacing. The cotton mats shall be kept wet with a continuous supply of water for the remainder of the curing period. Other continuous wetting systems may be used if approved by the Engineer.

After placement of the soaker hoses, the cotton mats shall be covered with white polyethylene sheeting or burlap-polyethylene blankets.

For construction items other than bridge decks, soaker hoses or a continuous wetting system will not be required if the alternative method keeps the cotton mats wet. Periodic wetting of the cotton mats is acceptable.

For areas inaccessible to the cotton mats on bridge decks, curing shall be according to Article 1020.13(a)(3).

(b) **Removing and Replacing Curing Covering.** When curing methods specified above in Article 1020.13(a), (1), (2), or (3) are used for concrete pavement, the curing covering for each day's paving shall be removed to permit testing of the pavement surface with a profilograph or straightedge, as directed by the Engineer.

Immediately after testing, the surface of the pavement shall be wetted thoroughly and the curing coverings replaced. The top surface and the edges of the concrete shall not be left unprotected for a period of more than 1/2 hour.

(c) **Protection of Concrete, Other Than Structures, From Low Air Temperatures.** When the official National Weather Service forecast for the construction area predicts a low of 32 °F (0 °C), or lower, or if the actual temperature drops to 32 °F (0 °C), or lower, concrete less than 72 hours old shall be provided at least the following protection.

Minimum Temperature	Protection
25 – 32 °F (-4 – 0 °C)	Two layers of polyethylene sheeting, one layer of polyethylene and one layer of burlap, or two layers of waterproof paper.
Below 25 °F (-4 °C)	6 in. (150 mm) of straw covered with one layer of polyethylene sheeting or waterproof paper.

These protective covers shall remain in place until the concrete is at least 96 hours old. When straw is required on pavement cured with membrane curing compound, the compound shall be covered with a layer of burlap, polyethylene sheeting or waterproof paper before the straw is applied.

After September 15, there shall be available to the work within four hours, sufficient clean, dry straw to cover at least two days production. Additional straw shall be provided as needed to afford the protection required. Regardless of the precautions taken, the Contractor shall be responsible for protection of the concrete placed and any concrete damaged by cold temperatures shall be removed and replaced.

- (d) Protection of Concrete Structures From Low Air Temperatures. When the official National Weather Service forecast for the construction area predicts a low below 45 °F (7 °C), or if the actual temperature drops below 45 °F (7 °C), concrete less than 72 hours old shall be provided protection. Concrete shall also be provided protection when placed during the winter period of December 1 through March 15. Concrete shall not be placed until the materials, facilities, and equipment for protection are approved by the Engineer.

When directed by the Engineer, the Contractor may be required to place concrete during the winter period. When winter construction is specified, the Contractor shall proceed with the construction, including excavation, pile driving, concrete, steel erection, and all appurtenant work required for the complete construction of the item, except at times when weather conditions make such operations impracticable.

Regardless of the precautions taken, the Contractor shall be responsible for protection of the concrete placed and any concrete damaged by cold temperatures shall be removed and replaced.

- (1) Protection Method I. The concrete shall be completely covered with insulating material such as fiberglass, rock wool, or other approved commercial insulating material having the minimum thermal resistance R, as defined in ASTM C 168, for the corresponding minimum dimension of the concrete unit being protected as shown in the following table.

Minimum Pour Dimension		Thermal Resistance R
in.	(mm)	
6 or less	(150 or less)	R=16
> 6 to 12	(> 150 to 300)	R=10
> 12 to 18	(> 300 to 450)	R=6
> 18	(> 450)	R=4

The insulating material manufacturer shall clearly mark the insulating material with the thermal resistance R value.

The insulating material shall be completely enclosed on sides and edges with an approved waterproof liner and shall be maintained in a serviceable condition. Any tears in the liner shall be repaired in a manner approved by the Engineer. The Contractor shall provide means for checking the temperature of the surface of the concrete during the protection period.

On formed surfaces, the insulating material shall be attached to the outside of the forms with wood cleats or other suitable means to prevent any circulation of air under the insulation and shall be in place before the concrete is placed. The blanket insulation shall be applied tightly against the forms. The edges and ends shall be attached so as to exclude air and moisture. If the blankets are provided with nailing flanges, the flanges shall be attached to the studs with cleats. Where tie rods or reinforcement bars protrude, the areas adjacent to the rods or bars shall be adequately protected in a manner satisfactory to the Engineer. Where practicable, the insulation shall overlap any previously placed concrete by at least 1 ft (300 mm). Insulation on the underside of floors on steel members shall cover the top flanges of supporting members. On horizontal surfaces, the insulating material shall be placed as soon as the concrete has set, so that the surface will not be marred and shall be covered with canvas or other waterproof covering. The insulating material shall remain in place for a period of seven days after the concrete is placed.

The Contractor may remove the forms, providing the temperature is 35 °F (2 °C) and rising and the Contractor is able to wrap the particular section within two hours from the time of the start of the form removal. The insulation shall remain in place for the remainder of the seven days curing period.

- (2) Protection Method II. The concrete shall be enclosed in adequate housing and the air surrounding the concrete kept at a temperature of not less than 50 °F (10 °C) nor more than 80 °F (27 °C) for a period of seven days after the concrete is placed. The Contractor shall provide means for checking the temperature of the surface of the concrete or air temperature within the housing during the protection period. All exposed surfaces within the housing shall be cured according to the Index Table.

The Contractor shall provide adequate fire protection where heating is in progress and such protection shall be accessible at all times. The Contractor shall maintain labor to keep the heating equipment in continuous operation.

At the close of the heating period, the temperature shall be decreased to the approximate temperature of the outside air at a rate not to exceed 15 °F (8 °C) per 12 hour period, after which the housing maybe removed. The surface of the concrete shall be permitted to dry during the cooling period.

- (3) Protection Method III. As soon as the surface is sufficiently set to prevent marring, the concrete shall be covered with 12 in. (300 mm) of loose, dry straw followed by a layer of impermeable covering. The edges of the covering shall be sealed to prevent circulation of air and prevent the cover from flapping or blowing. The protection shall remain in place until the concrete is seven days old. If construction operations require removal, the protection removed shall be replaced immediately after completion or suspension of such operations.

1020.14 Temperature Control for Placement. Temperature control for concrete placement shall be according to the following.

- (a) Concrete other than Structures. Concrete may be placed when the air temperature is above 35 °F (2 °C) and rising, and concrete placement shall stop when the falling temperature reaches 40 °F (4 °C) or below, unless otherwise approved by the Engineer.

The temperature of concrete immediately before placement shall be a minimum of 50 °F (10 °C) and a maximum of 90 °F (32 °C). If concrete is pumped, the temperature of the concrete as placed in the forms shall be a minimum of 50 °F (10 °C) and a maximum of 90 °F (32 °C). A maximum concrete temperature shall not apply to Class PP concrete.

- (b) Concrete in Structures. Concrete may be placed when the air temperature is above 40 °F (4 °C) and rising, and concrete placement shall stop when the falling temperature reaches 45 °F (7 °C) or below, unless otherwise approved by the Engineer.

The temperature of the concrete immediately before placement shall be a minimum of 50 °F (10 °C) and a maximum of 90 °F (32 °C). If concrete is pumped, the temperature of the concrete as placed in the forms shall be a minimum of 50 °F (10 °C) and a maximum of 90 °F (32 °C).

When insulated forms are used, the maximum temperature of the concrete mixture immediately before placement shall be 80 °F (25 °C).

When concrete is placed in contact with previously placed concrete, the temperature of the mixed concrete may be increased to 80 °F (25 °C) by the Contractor to offset anticipated heat loss.

- (c) All Classes of Concrete. Aggregates and water shall be heated or cooled uniformly and as necessary to produce concrete within the specified temperature limits. No frozen aggregates shall be used in the concrete.
- (d) Temperature. The concrete temperature shall be determined according to Illinois Modified AASHTO T 309.

1020.15 Heat of Hydration Control for Concrete Structures. The Contractor shall control the heat of hydration for concrete structures when the least dimension for a drilled shaft, foundation, footing, substructure, or superstructure concrete pour exceeds 5.0 ft (1.5 m). The work shall be according to the following.

- (a) Temperature Restrictions. The maximum temperature of the concrete after placement shall not exceed 150 °F (66 °C). The maximum temperature differential between the internal concrete core and concrete 2 to 3 in. (50 to 75 mm) from the exposed surface shall not exceed 35 °F (19 °C). The Contractor shall perform temperature monitoring to ensure compliance with the temperature restrictions.
- (b) Thermal Control Plan. The Contractor shall provide a thermal control plan a minimum of 28 calendar days prior to concrete placement for review by the Engineer. Acceptance of the thermal control plan by the Engineer shall not preclude the Contractor from specification compliance, and from preventing cracks in the concrete. At a minimum, the thermal control plan shall provide detailed information on the following requested items and shall comply with the specific specifications indicated for each item.
- (1) Concrete mix design(s) to be used. Grout mix design if post-cooling with embedded pipe.

The mix design requirements in Articles 1020.04 and 1020.05 shall be revised to include the following additional requirements to control the heat of hydration.

- a. The concrete mixture shall be uniformly graded and preference for larger size aggregate shall be used in the mix design. Article 1004.02(d)(2) and information in the "Portland Cement Concrete Level III Technician Course – Manual of Instructions for Design of Concrete Mixtures" shall be used to develop the uniformly graded mixture.
- b. The following shall apply to all concrete except Class DS concrete or when self-consolidating concrete is desired. For central-mixed concrete, the Contractor shall have the option to develop a mixture with a minimum of 520 lbs/cu yd (309 kg/cu m) of cement and finely divided minerals summed together. For truck-mixed or shrink-mixed concrete, the Contractor shall have the option to develop a mixture with a minimum of 550 lbs/cu yd (326 kg/cu m) of cement and finely divided minerals summed together. A water-reducing or high range water-reducing admixture shall be used in the central mixed, truck-mixed or shrink-mixed concrete mixture. For any mixture to be placed underwater, the minimum cement and finely divided minerals shall be 550 lbs/cu yd (326 kg/cu m) for central-mixed concrete, and 580 lbs/cu yd (344 kg/cu m) for truck-mixed or shrink-mixed concrete.

For Class DS concrete, CA 11 may be used. If CA 11 is used, the Contractor shall have the option to develop a mixture with a minimum cement and finely divided minerals of 605 lbs/cu yd (360 kg/cu m) summed together. If CA 11 is used and either Class DS concrete is placed underwater or a self-consolidating concrete mixture is desired, the Contractor shall have the option to develop a mixture with a minimum cement and finely divided minerals of 635 lbs/cu yd (378 kg/cu m) summed together.

- c. The minimum portland cement content in the mixture shall be 375 lbs/cu yd (222 kg/cu m). When the total of organic processing additions, inorganic processing additions, and limestone addition exceed 5.0 percent in the cement, the minimum portland cement content in the mixture shall be 400 lbs/cu yd (237 kg/cu m). For a drilled shaft, foundation, footing, or substructure, the minimum portland cement may be reduced to as low as 330 lbs/cu yd (196 kg/cu m) if the concrete has adequate freeze/thaw durability. The Contractor shall provide freeze/thaw test results according to AASHTO T 161 Procedure A or B, and the relative dynamic modulus of elasticity of the mix design shall be a minimum of 80 percent. Freeze/thaw testing will not be required for concrete that will not be exposed to freezing and thawing conditions as determined by the Engineer.
- d. The maximum cement replacement with fly ash shall be 40.0 percent. The maximum cement replacement with ground granulated blast-furnace slag shall be 65.0 percent. When cement replacement with ground granulated blast-furnace slag exceeds 35.0 percent, only Grade 100 shall be used.

- e. The mixture may contain a maximum of two finely divided minerals. The finely divided mineral in portland-pozzolan cement or portland blast-furnace slag cement shall count toward the total number of finely divided minerals allowed. The finely divided minerals shall constitute a maximum of 65.0 percent of the total cement plus finely divided minerals. The fly ash portion shall not exceed 40.0 percent. The ground granulated blast-furnace slag portion shall not exceed 65.0 percent. The microsilica or high-reactivity metakaolin portion used together or separately shall not exceed 5.0 percent.
- f. The time to obtain the specified strength may be increased to a maximum 56 days, provided the curing period specified in Article 1020.13 is increased to a minimum of 14 days.

The minimum grout strength for filling embedded pipe shall be as specified for the concrete, and testing shall be according to AASHTO T 106.

- (2) The selected mathematical method for evaluating heat of hydration thermal effects, which shall include the calculated adiabatic temperature rise, calculated maximum concrete temperature, and calculated maximum temperature differential between the internal concrete core and concrete 2 to 3 in. (50 to 75 mm) from the exposed surface. The time when the maximum concrete temperature and maximum temperature differential will occur is required if the time frame will be more than seven days.

Acceptable mathematical methods include ACI 207.2R "Report on Thermal and Volume Change Effects on Cracking of Mass Concrete" as well as other proprietary methods. The Contractor shall perform heat of hydration testing on the cement and finely divided minerals to be used in the concrete mixture. The test shall be according to ASTM C 186 or other applicable test methods, and the result for heat shall be used in the equation to calculate adiabatic temperature rise.

The Contractor has the option to propose a higher maximum temperature differential between the internal concrete core and concrete 2 to 3 in. (50 to 75 mm) from the exposed surface, but the proposed value shall not exceed 50 °F (10 °C). In addition, based on strength gain of the concrete, multiple maximum temperature differentials at different times may be proposed. The proposed value shall be justified through a mathematical method.

- (3) Proposed maximum concrete temperature or temperature range prior to placement.

Article 1020.14 shall apply except a minimum 40 °F (10 °C) concrete temperature will be permitted.

- (4) Pre-cooling, post-cooling, and surface insulation methods that will be used to ensure the concrete will comply with the specified maximum temperature and specified or proposed temperature differential. For reinforcement that extends beyond the limits of the pour, the Contractor shall indicate if the reinforcement is required to be covered with insulation.

Refer to ACI 207.4R "Cooling and Insulating Systems for Mass Concrete" for acceptable methods that will be permitted. A copy of the ACI document shall be provided to the Engineer at the construction site. If embedded pipe is used for post-cooling, the material shall be polyvinyl chloride or polyethylene. The embedded pipe system shall be properly supported, and the Contractor shall subsequently inspect glued joints to ensure they are able to withstand free falling concrete. The embedded pipe system shall be leak tested after inspection of the glued joints, and prior to the concrete placement. The leak test shall be performed at maximum service pressure or higher for a minimum of 15 minutes. All leaks shall be repaired. The embedded pipe cooling water may be from natural sources such as streams and rivers, but shall be filtered to prevent system stoppages. When the embedded pipe is no longer needed, the surface connections to the pipe shall be removed to a depth of 4 in. (100 mm) below the surface of the concrete. The remaining pipe shall be completely filled with grout. The 4 in. (100 mm) deep concrete hole shall be filled with nonshrink grout. Form and insulation removal shall be done in a manner to prevent cracking and ensure the maximum temperature differential is maintained. Insulation shall be in good condition as determined by the Engineer and properly attached.

- (5) Dimensions of each concrete pour, location of construction joints, placement operations, pour pattern, lift heights, and time delays between lifts.

Refer to ACI 207.1R "Guide to Mass Concrete" for acceptable placement operations that will be permitted. A copy of the ACI document shall be provided to the Engineer at the construction site.

- (6) Type of temperature monitoring system, the number of temperature sensors, and location of sensors.

A minimum of two independent temperature monitoring systems and corresponding sensors shall be used.

The temperature monitoring system shall have a minimum temperature range of 32 °F (0 °C) to 212 °F (100 °C), an accuracy of ± 2 °F (± 1 °C), and be able to automatically record temperatures without external power. Temperature monitoring shall begin once the sensor is encased in concrete, and with a maximum interval of one hour. Temperature monitoring may be discontinued after the maximum concrete temperature has been reached, post-cooling is no longer required, and the maximum temperature differential between the internal concrete core and the ambient air temperature does not exceed 35 °F (19 °C). The Contractor has the option to select a higher maximum temperature differential, but the proposed value shall not exceed 50 °F (28 °C). The proposed value shall be justified through a mathematical method.

At a minimum, a temperature sensor shall be located at the theoretical hottest portion of the concrete, normally the geometric center, and at the exterior face that will provide the maximum temperature differential. At the exterior face, the sensor shall be located 2 to 3 in. (50 to 75 mm) from the surface of the concrete. Sensors shall also be located a minimum of 1 in. (25 mm) away from reinforcement, and equidistant between cooling pipes if either applies. A sensor will also be required to measure ambient air temperature. The entrant/exit cooling water temperature for embedded pipe shall also be monitored.

Temperature monitoring results shall be provided to the Engineer a minimum of once each day and whenever requested by the Engineer. The report may be electronic or hard copy. The report shall indicate the location of each sensor, the temperature recorded, and the time recorded. The report shall be for all sensors and shall include ambient air temperature and entrant/exit cooling water temperatures. The temperature data in the report may be provided in tabular or graphical format, and the report shall indicate any corrective actions during the monitoring period. At the completion of the monitoring period, the Contractor shall provide the Engineer a final report that includes all temperature data and corrective actions.

(7) Indicate contingency operations to be used if the maximum temperature or temperature differential of the concrete is reached after placement.

(c) Temperature Restriction Violations. If the maximum temperature of the concrete after placement exceeds 150 °F (66 °C), but is less than 158 °F (70 °C), the concrete will be accepted if no cracking or other unacceptable defects are identified. If cracking or unacceptable defects are identified, Article 105.03 shall apply. If the concrete temperature exceeds 158 °F (70 °C), Article 105.03 shall apply.

If a temperature differential between the internal concrete core and concrete 2 to 3 in. (50 to 75 mm) from the exposed surface exceeds the specified or proposed maximum value allowed, the concrete will be accepted if no cracking or other unacceptable defects are identified. If unacceptable defects are identified, Article 105.03 shall apply.

When the maximum 150 °F (66 °C) concrete temperature or the maximum allowed temperature differential is violated, the Contractor shall implement corrective action prior to the next pour. In addition, the Engineer reserves the right to request a new thermal control plan for acceptance before the Contractor is allowed to pour again.

(d) Inspection and Repair of Cracks. The Engineer will inspect the concrete for cracks after the temperature monitoring is discontinued, and the Contractor shall provide access for the Engineer to do the inspection. A crack may require repair by the Contractor as determined by the Engineer. The Contractor shall be responsible for the repair of all cracks. Protective coat or a concrete sealer shall be applied to a crack less than 0.007 in. (0.18 mm) in width. A crack that is 0.007 in. (0.18 mm) or greater shall be pressure injected with epoxy according to Section 590.

QUALITY CONTROL/QUALITY ASSURANCE OF CONCRETE MIXTURES (BDE)

Effective: January 1, 2012

Add the following to Section 1020 of the Standard Specifications:

“1020.16 Quality Control/Quality Assurance of Concrete Mixtures. This Article specifies the quality control responsibilities of the Contractor for concrete mixtures (except Class PC and PS concrete), cement aggregate mixture II, and controlled low-strength material incorporated in the project, and defines the quality assurance and acceptance responsibilities of the Engineer.

A list of quality control/quality assurance (QC/QA) documents is provided in Article 1020.16(g), Schedule D.

A Level I Portland Cement Concrete (PCC) Technician shall be defined as an individual who has successfully completed the Department's training for concrete testing.

A Level II Portland Cement Concrete (PCC) Technician shall be defined as an individual who has successfully completed the Department's training for concrete proportioning.

A Level III Portland Cement Concrete (PCC) Technician shall be defined as an individual who has successfully completed the Department's training for concrete mix design.

A Concrete Tester shall be defined as an individual who has successfully completed the Department's training to assist with concrete testing and is monitored on a daily basis.

Aggregate Technician shall be defined as an individual who has successfully completed the Department's training for gradation testing involving aggregate production and mixtures.

Mixture Aggregate Technician shall be defined as an individual who has successfully completed the Department's training for gradation testing involving mixtures.

Gradation Technician shall be defined as an individual who has successfully completed the Department's training to assist with gradation testing and is monitored on a daily basis.

- (a) Equipment/Laboratory. The Contractor shall provide a laboratory and test equipment to perform their quality control testing.

The laboratory shall be of sufficient size and be furnished with the necessary equipment, supplies, and current published test methods for adequately and safely performing all required tests. The laboratory will be approved by the Engineer according to the current Bureau of Materials and Physical Research Policy Memorandum "Minimum Private Laboratory Requirements for Construction Materials Testing or Mix Design". Production of a mixture shall not begin until the Engineer provides written approval of the laboratory. The Contractor shall refer to the Department's "Required Sampling and Testing Equipment for Concrete" for equipment requirements.

Test equipment shall be maintained and calibrated as required by the appropriate test method, and when required by the Engineer. This information shall be documented on the Department's "Calibration of Concrete Testing Equipment" form.

Test equipment used to determine compressive or flexural strength shall be calibrated each 12 month period by an independent agency, using calibration equipment traceable to the National Institute of Standards and Technology (NIST). The Contractor shall have the calibration documentation available at the test equipment location.

The Engineer will have unrestricted access to the plant and laboratory at any time to inspect measuring and testing equipment, and will notify the Contractor of any deficiencies. Defective equipment shall be immediately repaired or replaced by the Contractor.

- (b) Quality Control Plan. The Contractor shall submit, in writing, a proposed Quality Control (QC) Plan to the Engineer. The QC Plan shall be submitted a minimum of 45 calendar days prior to the production of a mixture. The QC Plan shall address the quality control of the concrete, cement aggregate mixture II, and controlled low-strength material incorporated in the project. The Contractor shall refer to the Department's "Model Quality Control Plan for Concrete Production" to prepare a QC Plan. The Engineer will respond in writing to the Contractor's proposed QC Plan within 15 calendar days of receipt.

Production of a mixture shall not begin until the Engineer provides written approval of the QC Plan. The approved QC Plan shall become a part of the contract between the Department and the Contractor, but shall not be construed as acceptance of any mixture produced.

The QC Plan may be amended during the progress of the work, by either party, subject to mutual agreement. The Engineer will respond in writing to a Contractor's proposed QC Plan amendment within 15 calendar days of receipt. The response will indicate the approval or denial of the Contractor's proposed QC Plan amendment.

- (c) Quality Control by Contractor. The Contractor shall perform quality control inspection, sampling, testing, and documentation to meet contract requirements. Quality control includes the recognition of obvious defects and their immediate correction. Quality control also includes appropriate action when passing test results are near specification limits, or to resolve test result differences with the Engineer. Quality control may require increased testing, communication of test results to the plant or the jobsite, modification of operations, suspension of mixture production, rejection of material, or other actions as appropriate. The Engineer shall be immediately notified of any failing tests and subsequent remedial action. Passing tests shall be reported no later than the start of the next work day.

When a mixture does not comply with specifications, the Contractor shall reject the material; unless the Engineer accepts the material for incorporation in the work, according to Article 105.03.

- (1) Personnel Requirements. The Contractor shall provide a Quality Control (QC) Manager who will have overall responsibility and authority for quality control. The jobsite and plant personnel shall be able to contact the QC Manager by cellular phone, two-way radio or other methods approved by the Engineer.

The QC Manager shall visit the jobsite a minimum of once a week. A visit shall be performed the day of a bridge deck pour, the day a non-routine mixture is placed as determined by the Engineer, or the day a plant is anticipated to produce more than 1000 cu yd (765 cu m). Any of the three required visits may be used to meet the once per week minimum requirement.

The Contractor shall provide personnel to perform the required inspections, sampling, testing and documentation in a timely manner. The Contractor shall refer to the Department's "Qualifications and Duties of Concrete Quality Control Personnel" document.

A Level I PCC Technician shall be provided at the jobsite during mixture production and placement, and may supervise concurrent pours on the project. For concurrent pours, a minimum of one Concrete Tester shall be required at each pour location. If the Level I PCC Technician is at one of the pour locations, a Concrete Tester is still required at the same location. Each Concrete Tester shall be able to contact the Level I PCC Technician by cellular phone, two-way radio or other methods approved by the Engineer. A single Level I PCC Technician shall not supervise concurrent pours for multiple contracts.

A Level II PCC Technician shall be provided at the plant, or shall be available, during mixture production and placement. A Level II PCC Technician may supervise a maximum of three plants. Whenever the Level II PCC Technician is not at the plant during mixture production and placement, a Concrete Tester or Level I PCC Technician shall be present at the plant to perform any necessary concrete tests. The Concrete Tester, Level I PCC Technician, or other individual shall also be trained to perform any necessary aggregate moisture tests, if the Level II PCC Technician is not at the plant during mixture production and placement. The Concrete Tester, Level I PCC Technician, plant personnel, and jobsite personnel shall have the ability to contact the Level II PCC Technician by cellular phone, two-way radio, or other methods approved by the Engineer.

For a mixture which is produced and placed with a mobile portland cement concrete plant as defined in Article 1103.04, a Level II PCC Technician shall be provided. The Level II PCC Technician shall be present at all times during mixture production and placement.

A Concrete Tester, Mixture Aggregate Technician, and Aggregate Technician may provide assistance with sampling and testing. A Gradation Technician may provide assistance with testing. A Concrete Tester shall be supervised by a Level I or Level II PCC Technician. A Gradation Technician shall be supervised by a Level II PCC Technician, Mixture Aggregate Technician, or Aggregate Technician.

- (2) Required Plant Tests. Sampling and testing shall be performed at the plant, or at a location approved by the Engineer, to control the production of a mixture. The required minimum Contractor plant sampling and testing is indicated in Article 1020.16(g) Schedule A.
- (3) Required Field Tests. Sampling and testing shall be performed at the jobsite to control the production of a mixture, and to comply with specifications for placement. For standard curing, after initial curing, and for strength testing; the location shall be approved by the Engineer. The required minimum Contractor jobsite sampling and testing is indicated in Article 1020.16(g), Schedule B.

(d) Quality Assurance by Engineer. The Engineer will perform quality assurance tests on independent samples and split samples. An independent sample is a field sample obtained and tested by only one party. A split sample is one of two equal portions of a field sample, where two parties each receive one portion for testing. The Engineer may request the Contractor to obtain a split sample. Aggregate split samples and any failing strength specimen shall be retained until permission is given by the Engineer for disposal. The results of all quality assurance tests by the Engineer will be made available to the Contractor. However, Contractor split sample test results shall be provided to the Engineer before Department test results are revealed. The Engineer's quality assurance independent sample and split sample testing is indicated in Article 1020.16(g), Schedule C.

(1) Strength Testing. For strength testing, Article 1020.09 shall apply, except the Contractor and Engineer beam strength specimens may be cured in the same tank.

(2) Comparing Test Results. Differences between the Engineer's and the Contractor's split sample test results will not be considered extreme if within the following limits:

Test Parameter	Acceptable Limits of Precision
Slump	0.75 in. (20 mm)
Air Content	0.9%
Compressive Strength	900 psi (6200 kPa)
Flexural Strength	90 psi (620 kPa)
Aggregate Gradation	See "Guideline for Sample Comparison" in Appendix "A" of the Manual of Test Procedures for Materials.

When acceptable limits of precision have been met, but only one party is within specification limits, the failing test shall be resolved before the material may be considered for acceptance.

(3) Test Results and Specification Limits.

a. Split Sample Testing. If either the Engineer's or the Contractor's split sample test result is not within specification limits, and the other party is within specification limits; immediate retests on a split sample shall be performed for slump, air content, or aggregate gradation. A passing retest result by each party will require no further action. If either the Engineer's or Contractor's slump, air content, or aggregate gradation split sample retest result is a failure; or if either the Engineer's or Contractor's strength test result is a failure, and the other party is within specification limits; the following actions shall be initiated to investigate the test failure:

1. The Engineer and the Contractor shall investigate the sampling method, test procedure, equipment condition, equipment calibration, and other factors.
2. The Engineer or the Contractor shall replace test equipment, as determined by the Engineer.
3. The Engineer and the Contractor shall perform additional testing on split samples, as determined by the Engineer.

For aggregate gradation, jobsite slump, and jobsite air content; if the failing split sample test result is not resolved according to 1., 2., or 3., and the mixture has not been placed, the Contractor shall reject the material; unless the Engineer accepts the material for incorporation in the work according to Article 105.03. If the mixture has already been placed, or if a failing strength test result is not resolved according to 1., 2., or 3., the material will be considered unacceptable.

If a continued trend of difference exists between the Engineer's and the Contractor's split sample test results, or if split sample test results exceed the acceptable limits of precision, the Engineer and the Contractor shall investigate according to items 1, 2, and 3.

- b. Independent Sample Testing. For aggregate gradation, jobsite slump, and jobsite air content; if the result of a quality assurance test on a sample independently obtained by the Engineer is not within specification limits, and the mixture has not been placed, the Contractor shall reject the material, unless the Engineer accepts the material for incorporation in the work according to Article 105.03. If the mixture has already been placed or the Engineer obtains a failing strength test result, the material will be considered unacceptable.
- (e) Acceptance by the Engineer. Final acceptance will be based on the Standard Specifications and the following:
- (1) The Contractor's compliance with all contract documents for quality control.
 - (2) Validation of Contractor quality control test results by comparison with the Engineer's quality assurance test results using split samples. Any quality control or quality assurance test determined to be flawed may be declared invalid only when reviewed and approved by the Engineer. The Engineer will declare a test result invalid only if it is proven that improper sampling or testing occurred. The test result is to be recorded and the reason for declaring the test invalid will be provided by the Engineer.
 - (3) Comparison of the Engineer's quality assurance test results with specification limits using samples independently obtained by the Engineer.

The Engineer may suspend mixture production, reject materials, or take other appropriate action if the Contractor does not control the quality of concrete, cement aggregate mixture II, or controlled low-strength material for acceptance. The decision will be determined according to (1), (2), or (3).

- (f) Documentation.

- (1) Records. The Contractor shall be responsible for documenting all observations, inspections, adjustments to the mix design, test results, retest results, and corrective actions in a bound hardback field book, bound hardback diary, or appropriate Department form, which shall become the property of the Department. The documentation shall include a method to compare the Engineer's test results with the Contractor's results. The Contractor shall be responsible for the maintenance of all permanent records whether obtained by the Contractor, the consultants, the subcontractors, or the producer of the mixture. The Contractor shall provide the Engineer full access to all documentation throughout the progress of the work.

The Department's form MI 504M, form BMPR MI654, and form BMPR MI655 shall be completed by the Contractor, and shall be submitted to the Engineer weekly or as required by the Engineer. A correctly completed form MI 504M, form BMPR MI654, and form BMPR MI655 are required to authorize payment by the Engineer, for applicable pay items.

- (2) Delivery Truck Ticket. The following information shall be recorded on each delivery ticket or in a bound hardback field book: initial/final revolution counter reading, at the jobsite, if the mixture is truck-mixed; time discharged at the jobsite; total amount of each admixture added at the jobsite; total amount of water added at the jobsite; and total amount of cement added at the jobsite if the air content needed adjustment.
- (g) Basis of Payment and Schedules. Quality Control/Quality Assurance of portland cement concrete mixtures will not be paid for separately, but shall be considered as included in the cost of the various concrete contract items.

SCHEDULE A

CONTRACTOR PLANT SAMPLING AND TESTING			
Item	Test	Frequency	IL Modified AASHTO or Department Test Method ^{1/}
Aggregates (Arriving at Plant)	Gradation ^{2/}	As needed to check source for each gradation number	T 2, T 11, T 27, and T 248
Aggregates (Stored at Plant in Stockpiles or Bins)	Gradation ^{2/}	2,500 cu yd (1,900 cu m) for each gradation number ^{3/}	T 2, T 11, T 27, and T 248
Aggregates (Stored at Plant in Stockpiles or Bins)	Moisture ^{4/} : Fine Aggregate	Once per week for moisture sensor, otherwise daily for each gradation number	Flask, Dunagan, Pycnometer Jar, or T 255
	Moisture ^{4/} : Coarse Aggregate	As needed to control production for each gradation number	Dunagan, Pycnometer Jar, or T 255
Mixture ^{5/}	Slump, Air Content, Unit Weight / Yield, and Temperature	As needed to control production	T 141 and T 119 T 141 and T 152 or T 196 T 141 and T 121 T 141 and T 309

- 1/ Refer to the Department's "Manual of Test Procedures for Materials".
- 2/ All gradation tests shall be washed. Testing shall be completed no later than 24 hours after the aggregate has been sampled.
- 3/ One per week (Sunday through Saturday) minimum unless the stockpile has not received additional aggregate material since the previous test.
One per day minimum for a bridge deck pour unless the stockpile has not received additional aggregate material since the previous test. The sample shall be taken and testing completed prior to the pour. The bridge deck aggregate sample may be taken the day before the pour or as approved by the Engineer.
- 4/ If the moisture test and moisture sensor disagree by more than 0.5 percent, retest. If the difference remains, adjust the moisture sensor to an average of two or more moisture tests, using the Dunagan or Illinois Modified AASHTO T 255 test method. The Department's "Water/Cement Ratio Worksheet" form shall be completed when applicable.
- 5/ The Contractor may also perform strength testing according to Illinois Modified AASHTO T 141, T 23, and T 22 or T 177; or water content testing according to Illinois Modified AASHTO T 318; or other tests at the plant to control mixture production.

SCHEDULE B

CONTRACTOR JOBSITE SAMPLING & TESTING ^{1/}			
Item	Measured Property	Random Sample Testing Frequency per Mix Design and per Plant ^{2/}	IL Modified AASHTO Test Method
Pavement, Shoulder, Base Course, Base Course Widening, Driveway Pavement, Railroad Crossing, Cement Aggregate Mixture II	Slump ^{3/ 4/}	1 per 500 cu yd (400 cu m) or minimum 1/day	T 141 and T 119
	Air Content ^{3/ 5/} _{6/}	1 per 100 cu yd (80 cu m) or minimum 1/day	T 141 And T 152 or T 196
	Compressive Strength ^{7/ 8/} or Flexural Strength ^{7/ 8/}	1 per 1250 cu yd (1000 cu m) or minimum 1/day	T 141, T 22 and T 23 Or T 141, T 177 and T 23
Bridge Approach Slab ^{9/} , Bridge Deck ^{9/} , Bridge Deck Overlay ^{9/} , Superstructure ^{9/} , Substructure, Culvert, Miscellaneous Drainage Structures, Retaining Wall, Building Wall, Drilled Shaft Pile & Encasement Footing, Foundation, Pavement Patching, Structural Repairs	Slump ^{3/ 4/}	1 per 50 cu yd (40 cu m) or minimum 1/day	T 141 and T 119
	Air Content ^{3/ 5/} _{6/}	1 per 50 cu yd (40 cu m) or minimum 1/day	T 141 And T 152 or T 196
	Compressive Strength ^{7/ 8/} or Flexural Strength ^{7/ 8/}	1 per 250 cu yd (200 cu m) or minimum 1/day	T 141, T 22 and T 23 Or T 141, T 177 and T 23
Seal Coat	Slump ^{3/}	1 per 250 cu yd (200 cu m) or minimum 1/day	T 141 and T 119
	Air Content ^{3/ 6/}	As needed to control production	T 141 And T 152 or T 196
	Compressive Strength ^{7/ 8/} or Flexural Strength ^{7/ 8/}	1 per 250 cu yd (200 cu m) or minimum 1/day	T 141, T 22 and T 23 Or T 141, T 177 and T 23

CONTRACTOR JOBSITE SAMPLING & TESTING ^{1/}			
Curb, Gutter, Median, Barrier, Sidewalk, Slope Wall, Paved Ditch, Fabric Formed Concrete Revetment Mat ^{10/} , Miscellaneous Items, Incidental Items	Slump ^{3/ 4/}	1 per 100 cu yd (80 cu m) or minimum 1/day	T 141 and T 119
	Air Content ^{3/ 5/ 6/}	1 per 50 cu yd (40 cu m) or minimum 1/day	T 141 And T 152 or T 196
	Compressive Strength ^{7/ 8/} or Flexural Strength ^{7/ 8/}	1 per 400 cu yd (300 cu m) or minimum 1/day	T 141, T 22 and T 23 Or T 141, T 177 and T 23
All	Temperature ^{3/}	As needed to control production	T 141 and T 309
Controlled Low-Strength Material (CLSM)	Flow, Air Content and Compressive Strength	As needed to control production	Illinois Test Procedure 307

- 1/ Sampling and testing of small quantities of curb, gutter, median, barrier, sidewalk, slope wall, paved ditch, miscellaneous items, and incidental items may be waived by the Engineer if requested by the Contractor. However, quality control personnel are still required according to Article 1020.16(c)(1) The Contractor shall also provide recent evidence that similar material has been found to be satisfactory under normal sampling and testing procedures. The total quantity that may be waived for testing shall not exceed 100 cu yd (76 cu m) per contract.

- 2/ If one mix design is being used for several construction items during a day's production, one testing frequency may be selected to include all items. The construction items shall have the same slump, air content, and water/cement ratio specifications. The frequency selected shall equal or exceed the testing required for the construction item.

One sufficiently sized sample shall be taken to perform the required test(s). Random numbers shall be determined according to the Department's "Method for Obtaining Random Samples for Concrete". The Engineer will provide random sample locations.

- 3/ The temperature, slump, and air content tests shall be performed on the first truck load delivered, for each pour. Unless a random sample is required for the first truck load, testing the first truck load does not satisfy random sampling requirements.

- 4/ The slump random sample testing frequency shall be a minimum 1/day for a construction item which is slipformed.

- 5/ If a pump or conveyor is used for placement, a correction factor shall be established to allow for a loss of air content during transport. The first three truck loads delivered shall be tested, before and after transport by the pump or conveyor, to establish the correction factor. Once the correction is determined, it shall be re-checked after an additional 50 cu yd (40 cu m) is pumped, or an additional 100 cu yd (80 cu m) is conveyed. This shall continue throughout the pour. If the re-check indicates the correction factor has changed, a minimum of two truckloads is required to re-establish the correction factor. The correction factor shall also be re-established when significant changes in temperature, distance, pump or conveyor arrangement, and other factors have occurred. If the correction factor is 3.0 percent or more, the Contractor shall take corrective action to reduce the loss of air content during transport by the pump or conveyor. The Contractor shall record all air content test results, correction factors and corrected air contents. The corrected air content shall be reported on form BMPR MI654.
- 6/ If the Contractor's or Engineer's air content test result is within the specification limits, and 0.2 percent or closer to either limit, the next truck load delivered shall be tested by the Contractor. For example, if the specified air content range is 5.0 to 8.0 percent and the test result is 5.0, 5.1, 5.2, 7.8, 7.9 or 8.0 percent, the next truck shall be tested by the Contractor.

If the Contractor's or Engineer's air content or slump test result is not within the specification limits, all subsequent truck loads delivered shall be tested by the Contractor until the problem is corrected.
- 7/ The test of record for strength shall be the day indicated in Article 1020.04. For cement aggregate mixture II, a strength requirement is not specified and testing is not required. Additional strength testing to determine early falsework and form removal, early pavement or bridge opening to traffic, or to monitor strengths is at the discretion of the Contractor. Strength shall be defined as the average of at least two cylinder or two beam breaks for field tests.
- 8/ In addition to the strength test, an air test, slump test, and temperature test shall be performed on the same sample. For mixtures pumped or conveyed, the Contractor shall sample according to Illinois Modified AASHTO T 141.
- 9/ The air content test will be required for each delivered truck load.
- 10/ For fabric formed concrete revetment mat, the slump test is not required and the flexural strength test is not applicable.

SCHEDULE C

ENGINEER QUALITY ASSURANCE INDEPENDENT SAMPLE TESTING		
Location	Measured Property	Testing Frequency ^{1/}
Plant	Gradation of aggregates stored in stockpiles or bins, Slump and Air Content	As determined by the Engineer.
Jobsite	Slump, Air Content and Strength	As determined by the Engineer.

ENGINEER QUALITY ASSURANCE SPLIT SAMPLE TESTING		
Location	Measured Property	Testing Frequency ^{1/}
Plant	Gradation of aggregates stored in stockpiles or bins ^{2/}	At the beginning of the project, the first test performed by the Contractor. Thereafter, a minimum of 10% of total tests required of the Contractor will be performed per aggregate gradation number and per plant.
	Slump and Air Content	As determined by the Engineer.
Jobsite	Slump ^{2/} and Air Content ^{2/3/}	At the beginning of the project, the first three tests performed by the Contractor. Thereafter, a minimum of 20% of total tests required of the Contractor will be performed per plant, which will include a minimum of one test per mix design.
	Strength ^{2/}	At the beginning of the project, the first test performed by the Contractor. Thereafter, a minimum of 20% of total tests required of the Contractor will be performed per plant, which will include a minimum of one test per mix design.

- 1/ The Engineer will perform the testing throughout the period of quality control testing by the Contractor.
- 2/ The Engineer will witness and take immediate possession of or otherwise secure the Department's split sample obtained by the Contractor.
- 3/ Before transport by pump or conveyor, a minimum of 20 percent of total tests required of the Contractor will be performed per mix design and per plant. After transport by pump or conveyor, a minimum of 20 percent of total tests required of the Contractor will be performed per mix design and per plant.

SCHEDULE D

CONCRETE QUALITY CONTROL AND QUALITY ASSURANCE DOCUMENTS

- (a) Model Quality Control Plan for Concrete Production (*)
- (b) Qualifications and Duties of Concrete Quality Control Personnel (*)
- (c) Development of Gradation Bands on Incoming Aggregate at Mix Plants (*)
- (d) Required Sampling and Testing Equipment for Concrete (*)
- (e) Method for Obtaining Random Samples for Concrete (*)
- (f) Calibration of Concrete Testing Equipment (BMPR PCCQ01 through BMPR PCCQ09) (*)
- (g) Water/Cement Ratio Worksheet (BMPR PCCW01) (*)
- (h) Field/Lab Gradations (MI 504M) (*)
- (i) Concrete Air, Slump and Quantity (BMPR MI654) (*)
- (j) P.C. Concrete Strengths (BMPR MI655) (*)
- (k) Aggregate Technician Course or Mixture Aggregate Technician Course (*)
- (l) Portland Cement Concrete Tester Course (*)
- (m) Portland Cement Concrete Level I Technician Course - Manual of Instructions for Concrete Testing (*)
- (n) Portland Cement Concrete Level II Technician Course - Manual of Instructions for Concrete Proportioning (*)
- (o) Portland Cement Concrete Level III Technician Course - Manual of Instructions for Design of Concrete Mixtures (*)
- (p) Manual of Test Procedures for Materials

* Refer to Appendix C of the Manual of Test Procedures for Materials for more information.”

RECLAIMED ASPHALT PAVEMENT AND RECLAIMED ASPHALT SHINGLES (BDE)

Effective: November 1, 2012

Revise Section 1031 of the Standard Specifications to read:

“SECTION 1031. RECLAIMED ASPHALT PAVEMENT AND RECLAIMED ASPHALT SHINGLES

1031.01 Description. Reclaimed asphalt pavement and reclaimed asphalt shingles shall be according to the following.

- (a) Reclaimed Asphalt Pavement (RAP). RAP is the material produced by cold milling or crushing an existing hot-mix asphalt (HMA) pavement. The Contractor shall supply written documentation that the RAP originated from routes or airfields under federal, state, or local agency jurisdiction.
- (b) Reclaimed Asphalt Shingles (RAS). Reclaimed asphalt shingles (RAS). RAS is from the processing and grinding of preconsumer or post-consumer shingles. RAS shall be a clean and uniform material with a maximum of 0.5 percent unacceptable material, as defined in Bureau of Materials and Physical Research Policy Memorandum "Reclaimed Asphalt Shingle (RAS) Sources", by weight of RAS. All RAS used shall come from a Bureau of Materials and Physical Research approved processing facility where it shall be ground and processed to 100 percent passing the 3/8 in. (9.5 mm) sieve and 93 percent passing the #4 (4.75 mm) sieve based on a dry shake gradation. RAS shall be uniform in gradation and asphalt binder content and shall meet the testing requirements specified herein. In addition, RAS shall meet the following Type 1 or Type 2 requirements.
 - (1) Type 1. Type 1 RAS shall be processed, preconsumer asphalt shingles salvaged from the manufacture of residential asphalt roofing shingles.
 - (2) Type 2. Type 2 RAS shall be processed post-consumer shingles only, salvaged from residential, or four unit or less dwellings not subject to the National Emission Standards for Hazardous Air Pollutants (NESHAP).

1031.02 Stockpiles. RAP and RAS stockpiles shall be according to the following.

- (a) RAP Stockpiles. The Contractor shall construct individual, sealed RAP stockpiles meeting one of the following definitions. No additional RAP shall be added to the pile after the pile has been sealed. Stockpiles shall be sufficiently separated to prevent intermingling at the base. Stockpiles shall be identified by signs indicating the type as listed below (i.e. "Homogeneous Surface").

Prior to milling, the Contractor shall request the District provide documentation on the quality of the RAP to clarify the appropriate stockpile.

- (1) Fractionated RAP (FRAP). FRAP shall consist of RAP from Class I, HMA (High and Low ESAL) mixtures. The coarse aggregate in FRAP shall be crushed aggregate and may represent more than one aggregate type and/or quality but shall be at least C quality. All FRAP shall be fractionated prior to testing by screening into a minimum of two size fractions with the separation occurring on or between the #4 (4.75 mm) and 1/2 in. (12.5 mm) sieves. Agglomerations shall be minimized such that 100 percent of the RAP shall pass the sieve size specified below for the mix the FRAP will be incorporated.

Mixture FRAP will be used in:	Sieve Size that 100% of FRAP Shall Pass
IL-25.0	2 in. (50 mm)
IL-19.0	1 1/2 in. (40 mm)
IL-12.5	1 in. (25 mm)
IL-9.5	3/4 in. (20 mm)
IL-4.75	1/2 in. (13 mm)

- (2) Homogeneous. Homogeneous RAP stockpiles shall consist of RAP from Class I, HMA (High and Low ESAL) mixtures and represent: 1) the same aggregate quality, but shall be at least C quality; 2) the same type of crushed aggregate (either crushed natural aggregate, ACBF slag, or steel slag); 3) similar gradation; and 4) similar asphalt binder content. If approved by the Engineer, combined single pass surface/binder millings may be considered "homogenous" with a quality rating dictated by the lowest coarse aggregate quality present in the mixture.
- (3) Conglomerate. Conglomerate RAP stockpiles shall consist of RAP from Class I, HMA (High and Low ESAL) mixtures. The coarse aggregate in this RAP shall be crushed aggregate and may represent more than one aggregate type and/or quality but shall be at least C quality. This RAP may have an inconsistent gradation and/or asphalt binder content prior to processing. All conglomerate RAP shall be processed prior to testing by crushing to where all RAP shall pass the 5/8 in. (16 mm) or smaller screen. Conglomerate RAP stockpiles shall not contain steel slag.
- (4) Conglomerate "D" Quality (DQ). Conglomerate DQ RAP stockpiles shall consist of RAP from Class I, HMA (High or Low ESAL), or "All Other" (as defined by Article 1030.04(a)(3)) mixtures. The coarse aggregate in this RAP may be crushed or round but shall be at least D quality. This RAP may have an inconsistent gradation and/or asphalt binder content. Conglomerate DQ RAP stockpiles shall not contain steel slag.
- (5) Non-Quality. RAP stockpiles that do not meet the requirements of the stockpile categories listed above shall be classified as "Non-Quality".

RAP/FRAP containing contaminants, such as earth, brick, sand, concrete, sheet asphalt, bituminous surface treatment (i.e. chip seal), pavement fabric, joint sealants, etc., will be unacceptable unless the contaminants are removed to the satisfaction of the Engineer. Sheet asphalt shall be stockpiled separately.

- (b) RAS Stockpiles. Type 1 and Type 2 RAS shall be stockpiled separately and shall not be intermingled. Each stockpile shall be signed indicating what type of RAS is present.

Unless otherwise approved by the Engineer, mechanically blending manufactured sand (FM 20 or FM 22) up to an equal weight of RAS with the processed RAS will be permitted to improve workability. The sand shall be "B Quality" or better from an approved Aggregate Gradation Control System source. The sand shall be accounted for in the mix design and during HMA production.

Records identifying the shingle processing facility supplying the RAS, RAS type and lot number shall be maintained by project contract number and kept for a minimum of three years.

1031.03 Testing. RAP/FRAP and RAS testing shall be according to the following.

- (a) RAP/FRAP Testing. When used in HMA, the RAP/FRAP shall be sampled and tested either during or after stockpiling.
 - (1) During Stockpiling. For testing during stockpiling, washed extraction samples shall be run at the minimum frequency of one sample per 500 tons (450 metric tons) for the first 2000 tons (1800 metric tons) and one sample per 2000 tons (1800 metric tons) thereafter. A minimum of five tests shall be required for stockpiles less than 4000 tons (3600 metric tons).

- (2) After Stockpiling. For testing after stockpiling, the Contractor shall submit a plan for approval to the District proposing a satisfactory method of sampling and testing the RAP/FRAP pile either in-situ or by restockpiling. The sampling plan shall meet the minimum frequency required above and detail the procedure used to obtain representative samples throughout the pile for testing.

Each sample shall be split to obtain two equal samples of test sample size. One of the two test samples from the final split shall be labeled and stored for Department use. The Contractor shall extract the other test sample according to Department procedure. The Engineer reserves the right to test any sample (split or Department-taken) to verify Contractor test results.

- (b) RAS Testing. RAS or RAS blended with manufactured sand shall be sampled and tested during stockpiling according to Illinois Department of Transportation Policy Memorandum, "Reclaimed Asphalt Shingle (RAS) Source".

Samples shall be collected during stockpiling at the minimum frequency of one sample per 200 tons (180 metric tons) for the first 1000 tons (900 metric tons) and one sample per 250 tons (225 metric tons) thereafter. A minimum of five samples are required for stockpiles less than 1000 tons (900 metric tons). Once a ≤ 1000 ton (900 metric ton), five-sample/test stockpile has been established it shall be sealed. Additional incoming RAS or RAS blended with manufactured sand shall be stockpiled in a separate working pile as designated in the Quality Control plan and only added to the sealed stockpile when the test results of the working pile are complete and are found to meet the tolerances specified herein for the original sealed RAS stockpile.

Before testing, each sample shall be split to obtain two test samples. One of the two test samples from the final split shall be labeled and stored for Department use. The Contractor shall perform a washed extraction and test for unacceptable materials on the other test sample according to Department procedures. The Engineer reserves the right to test any sample (split or Department-taken) to verify Contractor test results.

If the sampling and testing was performed at the shingle processing facility in accordance with the QC Plan, the Contractor shall obtain and make available all of the test results from start of the initial stockpile.

1031.04 Evaluation of Tests. Evaluation of tests results shall be according to the following.

- (a) Evaluation of RAP/FRAP Test Results. All of the extraction results shall be compiled and averaged for asphalt binder content and gradation and, when applicable G_{mm} . Individual extraction test results, when compared to the averages, will be accepted if within the tolerances listed below.

Parameter	FRAP/Homogeneous /Conglomerate	Conglomerate "D" Quality
1 in. (25 mm)		± 5 %
1/2 in. (12.5 mm)	± 8 %	± 15 %
No. 4 (4.75 mm)	± 6 %	± 13 %
No. 8 (2.36 mm)	± 5 %	
No. 16 (1.18 mm)		± 15 %
No. 30 (600 μm)	± 5 %	
No. 200 (75 μm)	± 2.0 %	± 4.0 %
Asphalt Binder	± 0.4 % ^{1/}	± 0.5 %
G _{mm}	± 0.03	

1/ The tolerance for FRAP shall be ± 0.3 %.

If more than 20 percent of the individual sieves and/or asphalt binder content tests are out of the above tolerances, the RAP/FRAP shall not be used in HMA unless the RAP/FRAP representing the failing tests is removed from the stockpile. All test data and acceptance ranges shall be sent to the District for evaluation.

With the approval of the Engineer, the ignition oven may be substituted for extractions according to the Illinois Test Procedure, "Calibration of the Ignition Oven for the Purpose of Characterizing Reclaimed Asphalt Pavement (RAP)".

- (b) Evaluation of RAS and RAS Blended with Manufactured Sand Test Results. All of the test results, with the exception of percent unacceptable materials, shall be compiled and averaged for asphalt binder content and gradation. Individual test results, when compared to the averages, will be accepted if within the tolerances listed below.

Parameter	RAS
No. 8 (2.36 mm)	± 5 %
No. 16 (1.18 mm)	± 5 %
No. 30 (600 μm)	± 4 %
No. 200 (75 μm)	± 2.0 %
Asphalt Binder Content	± 1.5 %

If more than 20 percent of the individual sieves and/or asphalt binder content tests are out of the above tolerances, or if the percent unacceptable material exceeds 0.5 percent by weight of material retained on the # 4 (4.75 mm) sieve, the RAS or RAS blend shall not be used in Department projects. All test data and acceptance ranges shall be sent to the District for evaluation.

1031.05 Quality Designation of Aggregate in RAP/FRAP.

- (a) RAP. The aggregate quality of the RAP for homogenous, conglomerate, and conglomerate "D" quality stockpiles shall be set by the lowest quality of coarse aggregate in the RAP stockpile and are designated as follows.

- (1) RAP from Class I, Superpave/HMA (High ESAL), or (Low ESAL) IL-9.5L surface mixtures are designated as containing Class B quality coarse aggregate.

- (2) RAP from Superpave/HMA (Low ESAL) IL-19.0L binder mixture is designated as Class D quality coarse aggregate.
 - (3) RAP from Class I, Superpave/HMA (High ESAL) binder mixtures, bituminous base course mixtures, and bituminous base course widening mixtures are designated as containing Class C quality coarse aggregate.
 - (4) RAP from bituminous stabilized subbase and BAM shoulders are designated as containing Class D quality coarse aggregate.
- (b) FRAP. If the Engineer has documentation of the quality of the FRAP aggregate, the Contractor shall use the assigned quality provided by the Engineer.

If the quality is not known, the quality shall be determined as follows. Coarse and fine FRAP stockpiles containing plus #4 (4.75 mm) sieve coarse aggregate shall have a maximum tonnage of 5,000 tons (4,500 metric tons). The Contractor shall obtain a representative sample witnessed by the Engineer. The sample shall be a minimum of 50 lb (25 kg). The sample shall be extracted according to Illinois Modified AASHTO T 164 by a consultant prequalified by the Department for the specified testing. The consultant shall submit the test results along with the recovered aggregate to the District Office. The cost for this testing shall be paid by the Contractor. The District will forward the sample to the BMPR Aggregate Lab for MicroDeval Testing, according to Illinois Modified AASHTO T 327. A maximum loss of 15.0 percent will be applied for all HMA applications.

1031.06 Use of RAP/FRAP and/or RAS in HMA. The use of RAP/FRAP and/or RAS shall be a Contractor's option when constructing HMA in all contracts.

- (a) RAP/FRAP. The use of RAP/FRAP in HMA shall be as follows.
- (1) Coarse Aggregate Size. The coarse aggregate in all RAP shall be equal to or less than the nominal maximum size requirement for the HMA mixture to be produced.
 - (2) Steel Slag Stockpiles. Homogeneous RAP stockpiles containing steel slag will be approved for use in all HMA (High ESAL and Low ESAL) Surface and Binder Mixture applications.
 - (3) Use in HMA Surface Mixtures (High and Low ESAL). RAP/FRAP stockpiles for use in HMA surface mixtures (High and Low ESAL) shall be FRAP or homogeneous in which the coarse aggregate is Class B quality or better. RAP/FRAP from Conglomerate stockpiles shall be considered equivalent to limestone for frictional considerations. Known frictional contributions from plus #4 (4.75 mm) homogeneous RAP and FRAP stockpiles will be accounted for in meeting frictional requirements in the specified mixture.
 - (4) Use in HMA Binder Mixtures (High and Low ESAL), HMA Base Course, and HMA Base Course Widening. RAP/FRAP stockpiles for use in HMA binder mixtures (High and Low ESAL), HMA base course, and HMA base course widening shall be FRAP, homogeneous, or conglomerate, in which the coarse aggregate is Class C quality or better.

- (5) Use in Shoulders and Subbase. RAP/FRAP stockpiles for use in HMA shoulders and stabilized subbase (HMA) shall be FRAP, homogeneous, conglomerate, or conglomerate DQ.
- (6) When the Contractor chooses the RAP option, the percentage of RAP shall not exceed the amounts indicated in Article 1031.06(c)(1) below for a given N Design.
- (b) RAS. RAS meeting Type 1 or Type 2 requirements will be permitted in all HMA applications as specified herein.
- (c) RAP/FRAP and/or RAS Usage Limits. Type 1 or Type 2 RAS may be used alone or in conjunction with RAP or FRAP in HMA mixtures up to a maximum of 5.0% by weight of the total mix.
- (1) RAP/RAS. When RAP is used alone or RAP is used in conjunction with RAS, the percentage of virgin asphalt binder replacement shall not exceed the amounts listed in the Max RAP/RAS ABR table listed below for the given Ndesign.

RAP/RAS Maximum Asphalt Binder Replacement (ABR) Percentage

HMA Mixtures ^{1/, 2/}	RAP/RAS Maximum ABR %		
Ndesign	Binder/Leveling Binder	Surface	Polymer Modified
30	30	30	10
50	25	15	10
70	15	10	10
90	10	10	10
105	10	10	10

- 1/ For HMA “All Other” (shoulder and stabilized subbase) N-30, the RAP/RAS ABR shall not exceed 50 percent of the mixture.
- 2/ When RAP/RAS ABR exceeds 20 percent, the high and low virgin asphalt binder grades shall each be reduced by one grade (i.e. 25 percent ABR would require a virgin asphalt binder grade of PG64-22 to be reduced to a PG58-28). If warm mix asphalt (WMA) technology is utilized, and production temperatures do not exceed 275 °F (135 °C) the high and low virgin asphalt binder grades shall each be reduced by one grade when RAP/RAS ABR exceeds 25 percent (i.e. 26 percent RAP/RAS ABR would require a virgin asphalt binder grade of PG64-22 to be reduced to a PG58-28).
- (2) FRAP/RAS. When FRAP is used alone or FRAP is used in conjunction with RAS, the percentage of virgin asphalt binder replacement shall not exceed the amounts listed in the FRAP/RAS tables listed below for the given N design.

Level 1 - FRAP/RAS Maximum Asphalt Binder Replacement (ABR) Percentage

HMA Mixtures <small>1/, 2/</small>	Level 1 - FRAP/RAS Maximum ABR %		
Ndesign	Binder/Leveling Binder	Surface	Polymer Modified <small>3/, 4/</small>
30	35	35	10
50	30	25	10
70	25	20	10
90	20	15	10
105	10	10	10

- 1/ For HMA “All Other” (shoulder and stabilized subbase) N30, the FRAP/RAS ABR shall not exceed 50 percent of the mixture.
- 2/ When FRAP/RAS ABR exceeds 20 percent for all mixes the high and low virgin asphalt binder grades shall each be reduced by one grade (i.e. 25 percent ABR would require a virgin asphalt binder grade of PG64-22 to be reduced to a PG58-28). If warm mix asphalt (WMA) technology is utilized, and production temperatures do not exceed 275 °F (135 °C) the high and low virgin asphalt binder grades shall each be reduced by one grade when FRAP/RAS ABR exceeds 25 percent (i.e. 26 percent ABR would require a virgin asphalt binder grade of PG64-22 to be reduced to a PG58-28).
- 3/ For SMA the FRAP/RAS ABR shall not exceed 20 percent.
- 4/ For IL-4.75 mix the FRAP/RAS ABR shall not exceed 20 percent.

Level 2 – FRAP/RAS Maximum Asphalt Binder Replacement (ABR) Percentage

HMA Mixtures <small>1/, 2/</small>	Level 2 – FRAP/RAS Maximum ABR %		
Ndesign	Binder/Leveling Binder	Surface	Polymer Modified ^{3/} , _{4/}
30	40	40	10
50	40	30	10
70	30	20	10
90	30	20	10
105	30	15	10

- 1/ For HMA “All Other” (shoulder and stabilized subbase) N30, the FRAP/RAS ABR shall not exceed 50 percent of the mixture.

- 2/ When FRAP/RAS ABR exceeds 20 percent for all mixes the high and low virgin asphalt binder grades shall each be reduced by one grade (i.e. 25 percent ABR would require a virgin asphalt binder grade of PG64-22 to be reduced to a PG58-28). If warm mix asphalt (WMA) technology is utilized, and production temperatures do not exceed 275 °F (135 °C) the high and low virgin asphalt binder grades shall each be reduced by one grade when FRAP/RAS ABR exceeds 25 percent (i.e. 26 percent ABR would require a virgin asphalt binder grade of PG64-22 to be reduced to a PG58-28).
- 3/ For SMA the FRAP/RAS ABR shall not exceed 20 percent.
- 4/ For IL-4.75 mix the FRAP/RAS ABR shall not exceed 30 percent.

1031.07 HMA Mix Designs. At the Contractor’s option, HMA mixtures may be constructed utilizing RAP/FRAP and/or RAS material meeting the above detailed requirements.

FRAP/RAS mix designs exceeding the Level 1 FRAP/RAS Maximum ABR percentages shall be tested prior to submittal for verification, according to Illinois Modified AASHTO T 324 (Hamburg Wheel) and shall meet the following requirements.

Asphalt Binder Grade	# Repetitions	Max. Rut Depth in. (mm)
PG76-XX	20,000	1/2 (12.5)
PG70-XX	15,000	1/2 (12.5)
PG64-XX	7,500	1/2 (12.5)
PG58-XX	5,000	1/2 (12.5)

- (a) RAP/FRAP and/or RAS. RAP/FRAP and/or RAS designs shall be submitted for volumetric verification. If additional RAP/FRAP stockpiles are tested and found that no more than 20 percent of the results, as defined under “Testing” herein, are outside of the control tolerances set for the original RAP/FRAP stockpile and HMA mix design, and meets all of the requirements herein, the additional RAP/FRAP stockpiles may be used in the original mix design at the percent previously verified.
- (b) RAS. Type 1 and Type 2 RAS are not interchangeable in a mix design. A RAS stone bulk specific gravity (Gsb) of 2.500 shall be used for mix design purposes.

1031.08 HMA Production. Mixture production where the FRAP/RAS ABR percentage exceeds the Level 1 limits, shall be sampled within the first 500 tons (450 metric tons) on the first day of production with a split reserved for the Department. The mix sample shall be tested according to the Illinois Modified AASHTO T 324 and shall meet the requirements specified herein. Mix production shall not exceed 1500 tons (1350 metric tons) or one day’s production, whichever comes first, until the testing is completed and the mixture is found to be in conformance. The requirement to cease mix production may be waived if the plant produced mixture conformance is demonstrated prior to start of mix production for a State contract.

- (a) RAP/FRAP. The coarse aggregate in all RAP/FRAP used shall be equal to or less than the nominal maximum size requirement for the HMA mixture being produced.

To remove or reduce agglomerated material, a scalping screen, gator, crushing unit, or comparable sizing device approved by the Engineer shall be used in the RAP feed system to remove or reduce oversized material. If material passing the sizing device adversely affects the mix production or quality of the mix, the sizing device shall be set at a size specified by the Engineer.

If the RAP/FRAP control tolerances or QC/QA test results require corrective action, the Contractor shall cease production of the mixture containing RAP/FRAP and either switch to the virgin aggregate design or submit a new RAP/FRAP design.

- (b) RAS. RAS shall be incorporated into the HMA mixture either by a separate weight depletion system or by using the RAP weigh belt. Either feed system shall be interlocked with the aggregate feed or weigh system to maintain correct proportions for all rates of production and batch sizes. The portion of RAS shall be controlled accurately to within ± 0.5 percent of the amount of RAS utilized. When using the weight depletion system, flow indicators or sensing devices shall be provided and interlocked with the plant controls such that the mixture production is halted when RAS flow is interrupted.

When producing HMA containing RAS, a positive dust control system shall be utilized.

- (c) RAP/FRAP and/or RAS. HMA plants utilizing RAP/FRAP and/or RAS shall be capable of automatically recording and printing the following information.

(1) Dryer Drum Plants.

- a. Date, month, year, and time to the nearest minute for each print.
- b. HMA mix number assigned by the Department.
- c. Accumulated weight of dry aggregate (combined or individual) in tons (metric tons) to the nearest 0.1 ton (0.1 metric ton).
- d. Accumulated dry weight of RAP/FRAP/RAS in tons (metric tons) to the nearest 0.1 ton (0.1 metric ton).
- e. Accumulated mineral filler in revolutions, tons (metric tons), etc. to the nearest 0.1 unit.
- f. Accumulated asphalt binder in gallons (liters), tons (metric tons), etc. to the nearest 0.1 unit.
- g. Residual asphalt binder in the RAP/FRAP material as a percent of the total mix to the nearest 0.1 percent.
- h. Aggregate and RAP/FRAP moisture compensators in percent as set on the control panel. (Required when accumulated or individual aggregate and RAP/FRAP are printed in wet condition.)

(2) Batch Plants.

- a. Date, month, year, and time to the nearest minute for each print.
- b. HMA mix number assigned by the Department.
- c. Individual virgin aggregate hot bin batch weights to the nearest pound (kilogram).
- d. Mineral filler weight to the nearest pound (kilogram).
- f. RAP/FRAP/RAS weight to the nearest pound (kilogram).

- g. Virgin asphalt binder weight to the nearest pound (kilogram).
- h. Residual asphalt binder in the RAP/FRAP/RAS material as a percent of the total mix to the nearest 0.1 percent.

The printouts shall be maintained in a file at the plant for a minimum of one year or as directed by the Engineer and shall be made available upon request. The printing system will be inspected by the Engineer prior to production and verified at the beginning of each construction season thereafter.

1031.09 RAP in Aggregate Surface Course and Aggregate Shoulders. The use of RAP in aggregate surface course and aggregate shoulders shall be as follows.

- (a) Stockpiles and Testing. RAP stockpiles may be any of those listed in Article 1031.02, except “Non-Quality” and “FRAP”. The testing requirements of Article 1031.03 shall not apply.
- (b) Gradation. One hundred percent of the RAP material shall pass the 1 1/2 in. (37.5 mm) sieve. The RAP material shall be reasonably well graded from coarse to fine. RAP material that is gap-graded or single sized will not be accepted.”

REMOVAL AND DISPOSAL OF REGULATED SUBSTANCES (BDE)

Effective: January 1, 2012

Revised: November 2, 2012

Revise Article 669.01 of the Standard Specifications to read:

“669.01 Description. This work shall consist of the transportation and proper disposal of contaminated soil and water. This work shall also consist of the removal, transportation, and proper disposal of underground storage tanks (UST), their content and associated underground piping to the point where the piping is above the ground, including determining the content types and estimated quantities.”

Revise Article 669.08 of the Standard Specifications to read:

“669.08 Contaminated Soil and/or Groundwater Monitoring. The Contractor shall hire a qualified environmental firm to monitor the area containing the regulated substances. The affected area shall be monitored with a photoionization detector (PID) utilizing a lamp of 10.6eV or greater or a flame ionization detector (FID). Any field screen reading on the PID or FID in excess of background levels indicates the potential presence of contaminated material requiring handling as a non-special waste, special waste, or hazardous waste. No excavated soils can be taken to a clean construction and demolition debris (CCDD) facility or an uncontaminated soil fill operation with detectable PID or FID meter readings. The PID or FID meter shall be calibrated on-site and background level readings taken and recorded daily. All testing shall be done by a qualified engineer/technician. Such testing and monitoring shall be included in the work. The Contractor shall identify the exact limits of removal of non-special waste, special waste, or hazardous waste. All limits shall be approved by the Engineer prior to excavation. The Contractor shall take all necessary precautions.

Based upon PID or FID readings indicating contamination, a soil or groundwater sample shall be taken from the same location and submitted to an approved laboratory. Soil or groundwater samples shall be analyzed for the contaminants of concern, including pH, based on the property's land use history or the parameters listed in the maximum allowable concentration (MAC) for chemical constituents in uncontaminated soil established pursuant to Subpart F of 35 Illinois Administrative Code 1100.605. The analytical results shall serve to document the level of soil contamination. Soil and groundwater samples may be required at the discretion of the Engineer to verify the level of soil and groundwater contamination.

Samples shall be grab samples (not combined with other locations). The samples shall be taken with disposable instruments. The samples shall be placed in sealed containers and transported in an insulated container to the laboratory. The container shall maintain a temperature of 39 °F (4 °C). All samples shall be clearly labeled. The labels shall indicate the sample number, date sampled, location and elevation, and any other observations.

The laboratory shall use a detectable concentration which is equal to the lowest appropriate practical quantitation limits (PQL) or estimated quantitation limit (EQL) specified in "Test Methods for Evaluating Solid Wastes, Physical/Chemical Methods", EPA Publication No. SW-846 and "Methods for the Determination of Organic Compounds in Drinking Water", EPA, EMSL, EPA-600/4-88/039. For parameters where the specified cleanup objective is below the acceptable detection limit (ADL), the ADL shall serve as the cleanup objective. For other parameters the ADL shall be equal to or below the specified cleanup objective."

Replace the first two paragraphs of Article 669.09 of the Standard Specifications with the following:

"669.09 Contaminated Soil and/or Groundwater Management and Disposal. The management and disposal of contaminated soil and/or groundwater shall be according to the following:

- (a) Soil Analytical Results Exceed Most Stringent MAC. When the soil analytical results indicate that detected levels exceed the most stringent maximum allowable concentration (MAC) for chemical constituents in uncontaminated soil established pursuant to Subpart F of 35 Illinois Administrative Code 1100.605, the soil shall be managed as follows:
 - (1) When analytical results indicate inorganic chemical constituents exceed the most stringent MAC but they are still considered within area background levels by the Engineer, the excavated soil can be utilized within the construction limits as fill, when suitable. Such soil excavated for storm sewers can be placed back into the excavated trench as backfill, when suitable, unless trench backfill is specified. If the soils cannot be utilized within the construction limits, they shall be managed and disposed of off-site as a non-special waste, special waste, or hazardous waste as applicable.
 - (2) When analytical results indicate chemical constituents exceed the most stringent MAC but do not exceed the MAC for a Metropolitan Statistical Area (MSA) County, the excavated soil can be utilized within the construction limits as fill, when suitable, or managed and disposed of off-site as "uncontaminated soil" at a CCDD facility or an uncontaminated soil fill operation within an MSA County provided the pH of the soil is within the range of 6.25 - 9.0, inclusive.

- (3) When analytical results indicate chemical constituents exceed the most stringent MAC but do not exceed the MAC for an MSA County excluding Chicago, or the MAC within the Chicago corporate limits, the excavated soil can be utilized within the construction limits as fill, when suitable, or managed and disposed of off-site as "uncontaminated soil" at a CCDD facility or an uncontaminated soil fill operation within an MSA County excluding Chicago or within the Chicago corporate limits provided the pH of the soil is within the range of 6.25 - 9.0, inclusive.
 - (4) When analytical results indicate chemical constituents exceed the most stringent MAC but do not exceed the MAC for an MSA County excluding Chicago, the excavated soil can be utilized within the construction limits as fill, when suitable, or managed and disposed of off-site as "uncontaminated soil" at a CCDD facility or an uncontaminated soil fill operation within an MSA County excluding Chicago provided the pH of the soil is within the range of 6.25 - 9.0, inclusive.
 - (5) When the Engineer determines soil cannot be managed according to Articles 669.09(a)(1) through (a)(4) above, the soil shall be managed and disposed of off-site as a non-special waste, special waste, or hazardous waste as applicable.
- (b) Soil Analytical Results Do Not Exceed Most Stringent MAC. When the soil analytical results indicate that detected levels do not exceed the most stringent MAC but the pH of the soil is less than 6.25 or greater than 9.0, the excavated soil can be utilized within the construction limits or managed and disposed of off-site as "uncontaminated soil" according to Article 202.03. However the excavated soil cannot be taken to a CCDD facility or an uncontaminated soil fill operation.
- (c) Groundwater. When groundwater analytical results indicate the detected levels are above Appendix B, Table E of 35 Illinois Administrative Code 742, the most stringent Tier 1 Groundwater Remediation Objectives for Groundwater Component of the Groundwater Ingestion Route for Class 1 groundwater, the groundwater shall be managed off-site as a special waste.

All groundwater encountered within lateral trenches may be managed within the trench and allowed to infiltrate back into the ground. If the groundwater cannot be managed within the trench it must be removed as a special or hazardous waste. The Contractor is prohibited from managing groundwater within the trench by discharging it through any existing or new storm sewer. The Contractor shall install backfill plugs within the area of groundwater contamination.

One backfill plug shall be placed down gradient to the area of groundwater contamination. Backfill plugs shall be installed at intervals not to exceed 50 ft (15 m). Backfill plugs are to be 4 ft (1.2 m) long, measured parallel to the trench, full trench width and depth. Backfill plugs shall not have any fine aggregate bedding or backfill, but shall be entirely cohesive soil or any class of concrete. The Contractor shall provide test data that the material has a permeability of less than 10^{-7} cm/sec according to ASTM D 5084, Method A or per another test method approved by the Engineer."

Revise Article 669.14 of the Standard Specifications to read:

“669.14 Final Environmental Construction Report. At the end of the project, the Contractor will prepare and submit three copies of the Environmental Construction Report on the activities conducted during the life of the project, one copy shall be submitted to the Resident Engineer, one copy shall be submitted to the District's Environmental Studies Unit, and one copy shall be submitted with an electronic copy in Adobe.pdf format to the Geologic and Waste Assessment Unit, Bureau of Design and Environment, IDOT, 2300 South Dirksen Parkway, Springfield, Illinois 62764. The technical report shall include all pertinent information regarding the project including, but not limited to:

- (a) Measures taken to identify, monitor, handle, and dispose of soil or groundwater containing regulated substances, to prevent further migration of regulated substances, and to protect workers,
- (b) Cost of identifying, monitoring, handling, and disposing of soil or groundwater containing regulated substances, the cost of preventing further migration of regulated substances, and the cost for worker protection from the regulated substances. All cost should be in the format of the contract pay items listed in the contract plans (identified by the preliminary environmental site investigation (PESA) site number),
- (c) Plan sheets showing the areas containing the regulated substances,
- (d) Field sampling and testing results used to identify the nature and extent of the regulated substances,
- (e) Waste manifests (identified by the preliminary environmental site investigation (PESA) site number) for special or hazardous waste disposal, and
- (f) Landfill tickets (identified by the preliminary environmental site investigation (PESA) site number) for non-special waste disposal.”

Revise the second paragraph of Article 669.16 of the Standard Specifications to read:

“The transportation and disposal of soil and other materials from an excavation determined to be contaminated will be paid for at the contract unit price per cubic yard (cubic meter) for NON-SPECIAL WASTE DISPOSAL, SPECIAL WASTE DISPOSAL, or HAZARDOUS WASTE DISPOSAL.”

REMOVAL AND DISPOSAL OF SURPLUS MATERIALS (BDE)

Effective: November 2, 2012

Revise the first four paragraphs of Article 202.03 of the Standard Specifications to read:

“202.03 Removal and Disposal of Surplus, Unstable, Unsuitable, and Organic Materials. Suitable excavated materials shall not be wasted without permission of the Engineer. The Contractor shall dispose of all surplus, unstable, unsuitable, and organic materials, in such a manner that public or private property will not be damaged or endangered.

Suitable earth, stones and boulders naturally occurring within the right-of-way may be placed in fills or embankments in lifts and compacted according to Section 205. Broken concrete without protruding metal bars, bricks, rock, stone, reclaimed asphalt pavement with no expansive aggregate, or uncontaminated dirt and sand generated from construction or demolition activities may be used in embankment or in fill. If used in fills or embankments, these materials shall be placed and compacted to the satisfaction of the Engineer; shall be buried under a minimum of 2 ft (600 mm) of earth cover (except when the materials include only uncontaminated dirt); and shall not create an unsightly appearance or detract from the natural topographic features of an area. Broken concrete without protruding metal bars, bricks, rock, or stone may be used as riprap as approved by the Engineer. If the materials are used for fill in locations within the right-of-way but outside project construction limits, the Contractor must specify to the Engineer, in writing, how the landscape restoration of the fill areas will be accomplished. Placement of fill in such areas shall not commence until the Contractor's landscape restoration plan is approved by the Engineer.

Aside from the materials listed above, all other construction and demolition debris or waste shall be disposed of in a licensed landfill, recycled, reused, or otherwise disposed of as allowed by State or Federal laws and regulations. When the Contractor chooses to dispose of uncontaminated soil at a clean construction and demolition debris (CCDD) facility or at an uncontaminated soil fill operation, it shall be the Contractor's responsibility to have the pH of the material tested to ensure the value is between 6.25 and 9.0, inclusive. A copy of the pH test results shall be provided to the Engineer.

A permit shall be obtained from IEPA and made available to the Engineer prior to open burning of organic materials (i.e., plant refuse resulting from pruning or removal of trees or shrubs) or other construction or demolition debris. Organic materials originating within the right-of-way limits may be chipped or shredded and placed as mulch around landscape plantings within the right-of-way when approved by the Engineer. Chipped or shredded material to be placed as mulch shall not exceed a depth of 6 in. (150 mm).”

SUBCONTRACTOR MOBILIZATION PAYMENTS (BDE)

Effective: April 2, 2005

Revised: April 1, 2011

To account for the preparatory work and operations necessary for the movement of subcontractor personnel, equipment, supplies, and incidentals to the project site and for all other work or operations that must be performed or costs incurred when beginning work approved for subcontracting according to Article 108.01 of the Standard Specifications, the Contractor shall make a mobilization payment to each subcontractor.

This mobilization payment shall be made at least 14 days prior to the subcontractor starting work. The amount paid shall be equal to 3 percent of the amount of the subcontract reported on form BC 260A submitted for the approval of the subcontractor's work.

The mobilization payment to the subcontractor is an advance payment of the reported amount of the subcontract and is not a payment in addition to the amount of the subcontract; therefore, the amount of the advance payment will be deducted from future progress payments.

This provision shall be incorporated directly or by reference into each subcontract approved by the Department.

TRACKING THE USE OF PESTICIDES (BDE)

Effective: August 1, 2012

Add the following paragraph after the first paragraph of Article 107.23 of the Standard Specifications:

“Within 48 hours of the application of pesticides, including but not limited to herbicides, insecticides, algaecides, and fungicides, the Contractor shall complete and return to the Engineer, Operations form “OPER 2720”.”

TRAFFIC CONTROL DEFICIENCY DEDUCTION (BDE)

Effective: August 1, 2011

Revise the third sentence of the third paragraph of Article 105.03(b) of the Standard Specifications to read:

“The daily monetary deduction will be \$2,500.”

UTILITY COORDINATION AND CONFLICTS (BDE)

Effective: April 1, 2011

Revised: January 1, 2012

Revise Article 105.07 of the Standard Specifications to read:

“105.07 Cooperation with Utilities. The Department reserves the right at any time to allow work by utilities on or near the work covered by the contract. The Contractor shall conduct his/her work so as not to interfere with or hinder the progress or completion of the work being performed by utilities. The Contractor shall also arrange the work and shall place and dispose of the materials being used so as not to interfere with the operations of utility work in the area.

The Contractor shall cooperate with the owners of utilities in their removal and rearrangement operations so work may progress in a reasonable manner, duplication or rearrangement of work may be reduced to a minimum, and services rendered by those parties will not be unnecessarily interrupted.

The Contractor shall coordinate with any planned utility adjustment or new installation and the Contractor shall take all precautions to prevent disturbance or damage to utility facilities. Any failure on the part of the utility owner, or their representative, to proceed with any planned utility adjustment or new installation shall be reported promptly by the Contractor to the Engineer.”

Revise the first sentence of the last paragraph of Article 107.19 of the Standard Specifications to read:

“When the Contractor encounters unexpected regulated substances due to the presence of utilities in unanticipated locations, the provisions of Article 107.40 shall apply; otherwise, if the Engineer does not direct a resumption of operations, the provisions of Article 108.07 shall apply.”

Revise Article 107.31 of the Standard Specification to read:

“107.31 Reserved.”

Add the following four Articles to Section 107 of the Standard Specifications:

“107.37 Locations of Utilities within the Project Limits. All known utilities existing within the limits of construction are either indicated on the plans or visible above ground. For the purpose of this Article, the limits of proposed construction are defined as follows:

(a) Limits of Proposed Construction for Utilities Paralleling the Roadway.

- (1) The horizontal limits shall be a vertical plane, outside of, parallel to, and 2 ft (600 mm) distant at right angles from the plan or revised slope limits.

In cases where the limits of excavation for structures are not shown on the plans, the horizontal limits shall be a vertical plane 4 ft (1.2 m) outside the edges of structure footings or the structure where no footings are required.

- (2) The upper vertical limits shall be the regulations governing the roadbed clearance for the specific utility involved.

- (3) The lower vertical limits shall be either the top of the utility at the depth below the proposed grade as prescribed by the governing agency or the limits of excavation, whichever is less.
- (b) Limits of Proposed Construction for Utilities Crossing the Roadway in a Generally Transverse Direction.
- (1) Utilities crossing excavations for structures that are normally made by trenching such as sewers, underdrains, etc. and all minor structures such as manholes, inlets, foundations for signs, foundations for traffic signals, etc., the limits shall be the space to be occupied by the proposed permanent construction, unless otherwise required by the regulations governing the specific utility involved.
 - (2) For utilities crossing the proposed site of major structures such as bridges, sign trusses, etc., the limits shall be as defined above for utilities extending in the same general direction as the roadway.

It is understood and agreed that the Contractor has considered in the bid all of the permanent and temporary utilities in their present and/or adjusted positions as indicated in the contract. It is further understood the actual location of the utilities may be located anywhere within the tolerances provided in 220 ILCS 50/2.8 or Administrative Code Title 92 Part 530.40(c), and the proximity of some utilities to construction may require extraordinary measures by the Contractor to protect those utilities.

No additional compensation will be allowed for any delays, inconveniences, or damages sustained by the Contractor due to the presence of or any claimed interference from known utility facilities or any adjustment of them, except as specifically provided in the contract.

107.38 Adjustments of Utilities within the Project Limits. The adjustment of utilities consists of the relocation, removal, replacement, rearrangements, reconstruction, improvement, disconnection, connection, shifting, new installation, or altering of an existing utility facility in any manner.

Utilities which are to be adjusted shall be adjusted by the utility owner or the owner's representative or by the Contractor as a contract item. Generally, arrangements for adjusting known utilities will be made by the Department prior to project construction; however, utilities will not necessarily be adjusted in advance of project construction and, in some cases, utilities will not be removed from the proposed construction limits as described in Article 107.37. When utility adjustments must be performed in conjunction with construction, the utility adjustment work will be indicated in the contract.

The Contractor may make arrangements for adjustment of utilities indicated in the contract, but not scheduled by the Department for adjustment, provided the Contractor furnishes the Department with a signed agreement with the utility owner covering the adjustments to be made. The cost of any such adjustments shall be the responsibility of the Contractor.

107.39 Contractor's Responsibility for Locating and Protecting Utility Property and Services. At points where the Contractor's operations are adjacent to properties or facilities of utility companies, or are adjacent to other property, damage to which might result in considerable expense, loss, or inconvenience, work shall not be commenced until all arrangements necessary for the protection thereof have been made.

Within the State of Illinois, a State-Wide One Call Notice System has been established for notifying utilities. Outside the city limits of the City of Chicago, the system is known as the Joint Utility Locating Information for Excavators (JULIE) System. Within the city limits of the City of Chicago the system is known as DIGGER. All utility companies and municipalities which have buried utility facilities in the State of Illinois are a part of this system.

The Contractor shall call JULIE (800-892-0123) or DIGGER (312-744-7000), a minimum of 48 hours in advance of work being done in the area, and they will notify all member utility companies involved their respective utility should be located.

For utilities which are not members of JULIE or DIGGER, the Contractor shall contact the owners directly. The plan general notes will indicate which utilities are not members of JULIE or DIGGER.

The following table indicates the color of markings required of the State-Wide One Call Notification System.

Utility Service	Color
Electric Power, Distribution and Transmission	Safety Red
Municipal Electric Systems	Safety Red
Gas Distribution and Transmission	High Visibility Safety Yellow
Oil Distribution and Transmission	High Visibility Safety Yellow
Telephone and Telegraph System	Safety Alert Orange
Community Antenna Television Systems	Safety Alert Orange
Water Systems	Safety Precaution Blue
Sewer Systems	Safety Green
Non-Potable Water and Slurry Lines	Safety Purple
Temporary Survey	Safety Pink
Proposed Excavation	Safety White (Black when snow is on the ground)

The State-Wide One Call Notification System will provide for horizontal locations of utilities. When it is determined that the vertical location of the utility is necessary to facilitate construction, the Engineer may make the request for location from the utility after receipt of notice from the Contractor. If the utility owner does not field locate their facilities to the satisfaction of the Engineer, the Engineer will authorize the Contractor in writing to proceed to locate the facilities in the most economical and reasonable manner, subject to the approval of the Engineer, and be paid according to Article 109.04.

The Contractor shall be responsible for maintaining the excavations or markers provided by the utility owners.

The Contractor shall take all necessary precautions for the protection of the utility facilities. The Contractor shall be responsible for any damage or destruction of utility facilities resulting from neglect, misconduct, or omission in the Contractor's manner or method of execution or non-execution of the work, or caused by defective work or the use of unsatisfactory materials. Whenever any damage or destruction of a utility facility occurs as a result of work performed by the Contractor, the utility company will be immediately notified. The utility company will make arrangements to restore such facility to a condition equal to that existing before any such damage or destruction was done.

In the event of interruption of utility services as a result of accidental breakage or as a result of being exposed or unsupported, the Contractor shall promptly notify the proper authority and shall cooperate with the said authority in the restoration of service. If water service is interrupted, repair work shall be continuous until the service is restored. No work shall be undertaken around fire hydrants until provisions for continued service have been approved by the local fire authority.

107.40 Conflicts with Utilities. Except as provided hereinafter, the discovery of a utility in an unanticipated location will be evaluated according to Article 104.03. It is understood and agreed that the Contractor has considered in the bid all facilities not meeting the definition of a utility in an unanticipated location and no additional compensation will be allowed for any delays, inconveniences, or damages sustained by the Contractor due to the presence of or any claimed interference from such facilities.

When the Contractor discovers a utility in an unanticipated location, the Contractor shall not interfere with said utility, shall take proper precautions to prevent damage or interruption of the utility, and shall promptly notify the Engineer of the nature and location of said utility.

- (a) Definition. A utility in an unanticipated location is defined as an active or inactive utility, which is either:
- (1) Located underground and (a) not shown in any way in any location on the contract documents; (b) not identified in writing by the Department to the Contractor prior to the letting; or (c) not located relative to the location shown in the contract within the tolerances provided in 220 ILCS 50/2.8 or Administrative Code Title 92 Part 530.40(c); or
 - (2) Located above ground or underground and not relocated as provided in the contract.

Service connections shall not be considered to be utilities in unanticipated locations.

- (b) Compensation. Compensation will not be allowed for delays, inconveniences, or damages sustained by the Contractor from conflicts with facilities not meeting the above definition; or if a conflict with a utility in an unanticipated location does not cause a shutdown of the work applicable to the utility or a documentable reduction in the rate of progress exceeding the limits set herein. The provisions of Article 104.03 notwithstanding, compensation for delays caused by a utility in an unanticipated location will be paid according to the provisions of this Article governing minor and major delays or reduced rate of production which are defined as follows:
- (1) Minor Delay. A minor delay occurs when the Contractor's operation is completely stopped by a utility in an unanticipated location for more than two hours, but not to exceed three weeks.
 - (2) Major Delay. A major delay occurs when the Contractor's operation is completely stopped by a utility in an unanticipated location for more than three weeks.
 - (3) Reduced Rate of Production Delay. A reduced rate of production delay occurs when the contractor's rate of production decreases by more than 25 percent and lasts longer than seven days.

(c) Payment. Payment for Minor, Major and Reduced Rate of Production Delays will be made as follows.

(1) Minor Delay. Labor idled which cannot be used on other work will be paid for according to Article 109.04(b)(1) and (2) for the time between start of the delay and the minimum remaining hours in the work shift required by the prevailing practice in the area.

Equipment idled which cannot be used on other work, and which is authorized to standby on the project site by the Engineer, will be paid for according to Article 109.04(b)(4).

(2) Major Delay. Labor will be the same as for a minor delay.

Equipment will be the same as for a minor delay, except Contractor-owned equipment will be limited to three weeks plus the cost of move-out to either the Contractor's yard or another job, whichever is less. Rental equipment may be paid for longer than three weeks provided the Contractor presents adequate support to the Department (including lease agreement) to show retaining equipment on the job is the most economical course to follow and in the public interest.

(3) Reduced Rate of Production Delay. The Contractor will be compensated for the reduced productivity for labor and equipment time in excess of the 25 percent threshold for that portion of the delay in excess of seven days. Determination of compensation will be in accordance with Article 104.02, except labor and material additives will not be permitted.

Whether covered by (1), (2) or (3) above, additional traffic control required as a result of the operation(s) delayed will be paid for according to Article 109.04 for the total length of the delay.

If the delay is clearly shown to have caused work, which would have otherwise been completed, to be done after material or labor costs have increased, such increases may be paid. Payment for materials will be limited to increased cost substantiated by documentation furnished by the Contractor. Payment for increased labor rates will include those items in Article 109.04(b)(1) and (2), except the 35 percent and ten percent additives will not be permitted. On a working day contract, a delay occurring between November 30 and May 1, when work has not started, will not be considered as eligible for payment of measured labor and material costs.

Project overhead (not including interest) will be allowed when all progress on the contract has been delayed, and will be calculated as 15 percent of the delay claim.

(d) Other Obligations of Contractor. Upon payment of a claim under this provision, the Contractor shall assign subrogation rights to the Department for the Department's efforts of recovery from any other party for monies paid by the Department as a result of any claim under this Provision. The Contractor shall fully cooperate with the Department in its efforts to recover from another party any money paid to the Contractor for delay damages under this Provision."

WARM MIX ASPHALT (BDE)

Effective: January 1, 2012

Revised: November 1, 2012

Description. This work shall consist of designing, producing and constructing Warm Mix Asphalt (WMA) in lieu of Hot Mix Asphalt (HMA) at the Contractor's option. Work shall be according to Sections 406, 407, 408, 1030, and 1102 of the Standard Specifications, except as modified herein. In addition, any references to HMA in the Standard Specifications, or the special provisions shall be construed to include WMA.

WMA is an asphalt mixture which can be produced at temperatures lower than allowed for HMA utilizing approved WMA technologies. WMA technologies are defined as the use of additives or processes which allow a reduction in the temperatures at which HMA mixes are produced and placed. WMA is produced by the use of additives, a water foaming process, or combination of both. Additives include minerals, chemicals or organics incorporated into the asphalt binder stream in a dedicated delivery system. The process of foaming injects water into the asphalt binder stream, just prior to incorporation of the asphalt binder with the aggregate.

Approved WMA technologies may also be used in HMA provided all the requirements specified herein, with the exception of temperature, are met. However, asphalt mixtures produced at temperatures in excess of 275 °F (135 °C) will not be considered WMA when determining the grade reduction of the virgin asphalt binder grade.

Materials.

Add the following to Article 1030.02 of the Standard Specifications.

“(h) Warm Mix Asphalt (WMA) Technologies (Note 3)”

Add the following note to Article 1030.02 of the Standard Specifications.

“Note 3. Warm mix additives or foaming processes shall be selected from the current Bureau of Materials and Physical Research Approved List, “Warm-Mix Asphalt Technologies.”

Equipment.

Revise the first paragraph of Article 1102.01 of the Standard Specifications to read:

“**1102.01 Hot-Mix Asphalt Plant.** The hot-mix asphalt (HMA) plant shall be the batch-type, continuous-type, or dryer drum plant. The plants shall be evaluated for prequalification rating and approval to produce HMA according to the current Bureau of Materials and Physical Research Policy Memorandum, “Approval of Hot-Mix Asphalt Plants and Equipment”. Once approved, the Contractor shall notify the Bureau of Materials and Physical Research to obtain approval of all plant modifications. The plants shall not be used to produce mixtures concurrently for more than one project or for private work unless permission is granted in writing by the Engineer. The plant units shall be so designed, coordinated and operated that they will function properly and produce HMA having uniform temperatures and compositions within the tolerances specified. The plant units shall meet the following requirements.”

Add the following to Article 1102.01(a) of the Standard Specifications.

“(13) Equipment for Warm Mix Technologies.

- a. Foaming. Metering equipment for foamed asphalt shall have an accuracy of ± 2 percent of the actual water metered. The foaming control system shall be electronically interfaced with the asphalt binder meter.
- b. Additives. Additives shall be introduced into the plant according to the supplier’s recommendations and shall be approved by the Engineer. The system for introducing the WMA additive shall be interlocked with the aggregate feed or weigh system to maintain correct proportions for all rates of production and batch sizes.”

Mix Design Verification.

Add the following to Article 1030.04 of the Standard Specifications.

“(d) Warm Mix Technologies.

- (1) Foaming. WMA mix design verification will not be required when foaming technology is used alone (without WMA additives). However, the foaming technology shall only be used on HMA designs previously approved by the Department.
- (2) Additives. WMA mix designs utilizing additives shall be submitted to the Engineer for mix design verification. Additional mixture verification requirements include Hamburg Wheel testing according to Illinois Modified AASHTO T324 and tensile strength testing according to Illinois Modified AASHTO T283 which shall meet the criteria in Tables 1 and 2 respectively herein. The Contractor shall provide the additional material as follows:
 - a. Four gyratory specimens to be prepared in the Contractor’s lab according to Illinois Modified AASHTO T324.
 - b. Sufficient mixture to conduct tensile strength testing according to Illinois Modified AASHTO T283.

Table 1. Illinois Modified AASHTO T324 Requirements ^{1/}

Asphalt Binder Grade	# Wheel Passes	Max Rut Depth in. (mm)
PG 76-XX	20,000	1/2 in. (12.5 mm)
PG 70-XX	15,000	1/2 in. (12.5 mm)
PG 64-XX	7,500	1/2 in. (12.5 mm)
PG 58-XX	5,000	1/2 in. (12.5 mm)

1/ Loose WMA shall be oven aged at 270 ± 5 °F (132 ± 3 °C) for two hours prior to gyratory compaction of Hamburg Wheel specimens.

Table 2. Tensile Strength Requirements

Asphalt Binder Grade	Tensile Strength psi (kPa)	
	Minimum	Maximum
PG 76-XX	80 (552)	200 (1379)
PG 70-XX		
PG 64-XX	60 (414)	200 (1379)"
PG 58-XX		

Production.

Revise the second paragraph of Article 1030.06(a) of the Standard Specifications to read:

“At the start of mix production for HMA, WMA, and HMA using WMA technologies, QC/QA mixture start-up will be required for the following situations; at the beginning of production of a new mix of a new mixture design, at the beginning of each production season, and at every plant utilized to produce mixtures, regardless of the mix.”

Insert the following after the sixth paragraph of Article 1030.06(a) of the Standard Specifications:

“Warm mix technologies shall be as follows.

- (1) Mixture sampled to represent the test strip shall include additional material sufficient for the Department to conduct Hamburg Wheel testing according to Illinois Modified AASHTO T324 and tensile strength testing according to Illinois Modified AASHTO T283 (approximately 110 lb (50 kg) total).
- (2) Upon completion of the start-up, WMA, or HMA using WMA technologies, production shall cease. The Contractor may revert to conventional HMA production provided a start-up has been previously completed for the current construction season for the mix design. WMA, or HMA using WMA technologies, may resume once all the test results, including Hamburg Wheel results are completed and found acceptable by the Engineer.”

Add the following after the first paragraph of Article 1030.05(d)(2)c. of the Standard Specifications:

“During production of each WMA mixture or HMA utilizing WMA technologies, the Engineer will request a minimum of one randomly located sample, identified by the Engineer, for Hamburg Wheel testing to determine compliance with the requirements specified in Table 1 herein.”

Quality Control/Quality Assurance Testing.

Revise the table in Article 1030.05(d)(2)a. of the Standard Specifications to read:

Parameter	Frequency of Tests		Test Method See Manual of Test Procedures for Materials
	High ESAL Mixture Low ESAL Mixture	All Other Mixtures	
Aggregate Gradation % passing sieves: 1/2 in. (12.5 mm), No. 4 (4.75 mm), No. 8 (2.36 mm), No. 30 (600 μm) No. 200 (75 μm) Note 1.	1 washed ignition oven test on the mix per half day of production Note 4.	1 washed ignition oven test on the mix per day of production Note 4.	Illinois Procedure
Asphalt Binder Content by Ignition Oven Note 2.	1 per half day of production	1 per day	Illinois-Modified AASHTO T 308
VMA Note 3.	Day's production ≥ 1200 tons: 1 per half day of production Day's production < 1200 tons: 1 per half day of production for first 2 days and 1 per day thereafter (first sample of the day)	N/A	Illinois-Modified AASHTO R 35
Air Voids Bulk Specific Gravity of Gyratory Sample Note 5.	Day's production ≥ 1200 tons: 1 per half day of production Day's production < 1200 tons: 1 per half day of production for first 2 days and 1 per day thereafter (first sample of the day)	1 per day	Illinois-Modified AASHTO T 312
Maximum Specific Gravity of Mixture	Day's production ≥ 1200 tons: 1 per half day of production Day's production < 1200 tons: 1 per half day of production for first 2 days and 1 per day thereafter (first sample of the day)	1 per day	Illinois-Modified AASHTO T 209

Note 1. The No. 8 (2.36 mm) and No. 30 (600 μ m) sieves are not required for All Other Mixtures.

Note 2. The Engineer may waive the ignition oven requirement for asphalt binder content if the aggregates to be used are known to have ignition asphalt binder content calibration factors which exceed 1.5 percent. If the ignition oven requirement is waived, other Department approved methods shall be used to determine the asphalt binder content.

Note 3. The G_{sb} used in the voids in the mineral aggregate (VMA) calculation shall be the same average G_{sb} value listed in the mix design.

Note 4. The Engineer reserves the right to require additional hot bin gradations for batch

Note 5. The WMA compaction temperature for mixture volumetric testing shall be 270 ± 5 °F (132 ± 3 °C) for quality control testing. The WMA compaction temperature for quality assurance testing will be 270 ± 5 °F (132 ± 3 °C) if the mixture is not allowed to cool to room temperature. If the mixture is allowed to cool to room temperature it shall be reheated to standard HMA compaction temperatures.”

Construction Requirements.

Revise the second paragraph of Article 406.06(b)(1) of the Standard Specifications to read:

“The HMA shall be delivered at a temperature of 250 to 350 °F (120 to 175 °C). WMA shall be delivered at a minimum temperature of 215 °F (102 °C).”

Basis of Payment.

This work will be paid at the contract unit price bid for the HMA pay items involved. Anti-strip will not be paid for separately, but shall be considered as included in the cost of the work.

WEEKLY DBE TRUCKING REPORTS (BDE)

Effective: June 2, 2012

The Contractor shall provide a weekly report of Disadvantaged Business Enterprise (DBE) trucks hired by the Contractor or subcontractors (i.e. not owned by the Contractor or subcontractors) that are used on the jobsite; or used for the delivery and/or removal of equipment/material to and from the jobsite. The jobsite shall also include offsite locations, such as plant sites or storage sites, when those locations are used solely for this contract.

The report shall be submitted on the form provided by the Department within ten business days following the reporting period. The reporting period shall be Monday through Sunday for each week reportable trucking activities occur. The report shall be submitted to the Engineer and a copy shall be provided to the district EEO Officer.

Any costs associated with providing weekly DBE trucking reports shall be considered as included in the contract unit prices bid for the various items of work involved and no additional compensation will be allowed.

WORKING DAYS (BDE)

Effective: January 1, 2002

The Contractor shall complete the work within 15 working days.

FOR INDEX OF SHEETS & STATE STANDARDS
SEE SHEET NO. 2

STATE OF ILLINOIS
DEPARTMENT OF TRANSPORTATION
DIVISION OF HIGHWAYS

PROPOSED HIGHWAY PLANS

F.A.I. ROUTE 39 (I-39)
SECTION D2 PATCHING 2013-1
PROJECT
WINNEBAGO COUNTY
C-92-161-12

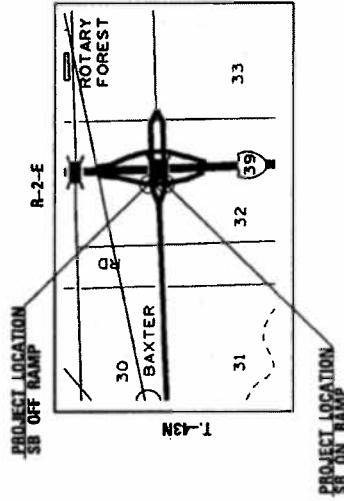

GROSS LENGTH OF PROJECT = NA = NA MILES
OMISSION LENGTH OF PROJECT = NA = NA MILES
NET LENGTH OF PROJECT = NA = NA MILES

TOWNSHIP (SECTION):
ROCKFORD (32)

J.B.I.L.L.E.
JOINT UTILITY LOCATION INFORMATION FOR EXCAVATION
1-800-922-0123

CONTRACT NO. 64J11

F.A.I. ROUTE 39 (I-39) SECTION D2 PATCHING 2013-1 WINNEBAGO COUNTY

SECTION
WINNEBAGO

CONTRACT NO. 64J11
D-92-097-12

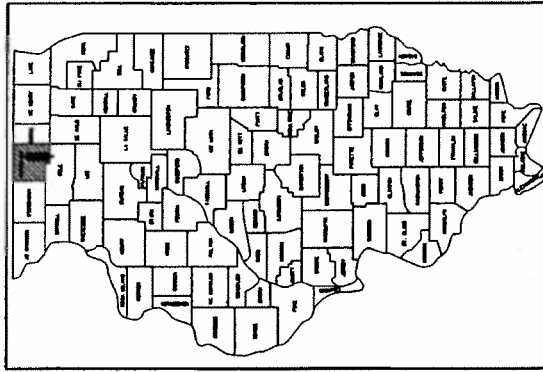

LOCATION OF SECTION INDICATED THERE

STATE OF ILLINOIS
DEPARTMENT OF TRANSPORTATION
DIVISION OF HIGHWAYS

SUBMITTED August 1 20 12

Eric S. Anker
DEPUTY DIRECTOR OF HIGHWAYS, REGION ENGINEER

20

ENGINEER OF DESIGN AND ENVIRONMENT

20

DIRECTOR OF HIGHWAYS, CHIEF ENGINEER

PRINTED BY THE AUTHORITY
OF THE STATE OF ILLINOIS

INDEX

FAI 39 (I-39)
SECTION D2 PATCHING 2013-1
WINNEBAGO COUNTY
CONTRACT NO. 64J11
Sheet 2 of 19

1	Cover Sheet
2	Index of Sheets / State Standards
3-4	Summary of Quantities
5-7	Schedule of Quantities
8-9	General Notes
10-11	Plan Sheets
12	Temporary Ramp, Special Detail
13-14	Typical Sections
15	Bituminous Schedule
16	Patching Schedule
17	Hot-Mix Asphalt Shoulder (D.S. 23.4a)
18	Sub-Grade Replacement (D.S. 97.4)
19	Painting Details (D.S. 44.1)

STATE STANDARDS

420001-07	PAVEMENT JOINTS
420701-02	PAVEMENT FABRIC
442101-07	CLASS B PATCHES
701006-03	OFF-ROAD OPERATIONS, 2L, 2W, 15'(4.5M) TO 24'(600MM) FROM PAVEMENT EDGE
701011-02	OFF-ROAD MOVING OPERATIONS, 2L, 2W, DAY ONLY
701201-04	LANE CLOSURE, 2L, 2W, DAY ONLY, FOR SPEED \geq 45 MPH
701311-03	LANE CLOSURE, 2L, 2W, MOVING OPERATIONS, DAY ONLY
701326-04	LANE CLOSURE, 2L, 2W, PAVEMENT WIDENING, FOR SPEEDS \geq 45 MPH
701456-02	PARTIAL EXIT RAMP CLOSURE FREEWAY/EXPRESSWAY
701901-02	TRAFFIC CONTROL DEVICES
720011-01	METAL POST FOR SIGNS, MARKERS AND DELINEATORS
728001-01	TELESCOPING STEEL SIGN SUPPORT
729001-01	APPLICATIONS OF TYPES A AND B METAL POST (FOR SIGNS & MARKERS)

SUMMARY OF QUANTITIES

FAL 99 (0-99)
SECTION 02 PATCHING 2013-1
WINNEBAGO COUNTY
CONTRACT # 84J11
SHEET 3 OF 18
100% Bids
0065

CODE NO.	ITEM	UNIT	TOTAL QUANTITY
20200600	EXCAVATING AND GRADING EXISTING SHOULDERS	UNIT	2
31100910	SUBBASE GRANULAR MATERIAL TYPE A, 12 INCH	SQ YD	115
40603310	HOT-MIX ASPHALT SURFACE COURSE, MIX "C" N50	TON	10
42001200	PAVEMENT FABRIC	SQ YD	313
44200976	CLASS B PATCHES TYPE IV, 10 INCH	SQ YD	313
44201299	DOWEL BARS 1 1/2"	EACH	190
44213200	SAW CUTS	FOOT	261
44213208	TIE BARS 1-1/4 INCH	EACH	103
48102100	AGGREGATE WEDGE SHOULDER, TYPE B	TON	61
48203023	HOT-MIX ASPHALT SHOULDERS, 6 1/2"	SQ YD	115
60107600	PIPE UNDERDRAINS 4"	FOOT	192
67100100	MOBILIZATION	L SUM	1
70100450	TRAFFIC CONTROL AND PROTECTION, STANDARD 701201	L SUM	1

SUMMARY OF QUANTITIES

FAJ 19 (1-30)
SECTION OF PATCHING 2013-1
WINNEBAGO COUNTY
CONTRACT # BA111
SHEET 4 OF 19

100% State
0005

CODE NO.	ITEM	UNIT	TOTAL QUANTITY
70100500	TRAFFIC CONTROL AND PROTECTION, STANDARD 701326	L SUM	1
70100825	TRAFFIC CONTROL AND PROTECTION, STANDARD 701456	L SUM	1
70103815	TRAFFIC CONTROL SURVEILLANCE	CAL DAY	6
78001110	PAINT PAVEMENT MARKING- LINE 4 INCH	FOOT	1082
78001140	PAINT PAVEMENT MARKING - LINE 8 INCH	FOOT	270
78001150	PAINT PAVEMENT MARKING - LINE 12 INCH	FOOT	66
78001180	PAINT PAVEMENT MARKING - LINE 24 INCH	FOOT	80
X4060995	TEMPORARY RAMP, SPECIAL	SQ YD	107
Z0028415	GEOTECHNICAL REINFORCEMENT	SQ YD	313
30300001	AGGREGATE SUBGRADE IMPROVEMENT	CU YD	52

* Specialty Items

SCHEDULE OF QUANTITIES

FAI 39 (I 39)
Section D2 PATCHING 2013-1
Winnebago County
Contract #64J11
Sheet 5 of 19

20200600 EXCAVATING AND GRADING EXISTING SHOULDERS

<u>LOCATION</u>	<u>UNIT</u>	<u>REMARKS</u>
SB "ON RAMP"	1.10	LT and RT Shoulders
SB "OFF RAMP"	<u>0.82</u>	RT Shoulder
TOTAL	1.92	

31100910 SUBBASE GRANULAR MATERIAL TYPE A, 12 INCH

<u>LOCATION</u>	<u>SQ YD</u>	<u>REMARKS</u>
SB "ON RAMP"	60	LT and RT Shoulders
SB "OFF RAMP"	<u>55</u>	RT Shoulder
TOTAL	115	

48102100 AGGREGATE WEDGE SHOULDER, TYPE B

<u>LOCATION</u>	<u>TON</u>	<u>REMARKS</u>
SB "ON RAMP"	31	LT and RT Shoulders
SB "OFF RAMP"	<u>30</u>	LT and RT Shoulders
TOTAL	61	

60107600 PIPE UNDERDRAINS 4"

<u>LOCATION</u>	<u>FOOT</u>	<u>REMARKS</u>
SB "ON RAMP"	110	This is a contingency item for LT and RT Shoulders
SB "OFF RAMP"	<u>82</u>	
TOTAL	192	

SCHEDULE OF QUANTITIES

FAI 39 (I 39)
Section D2 PATCHING 2013-1
Winnebago County
Contract #64J11
Sheet 6 of 19

78001110 PAINT PAVEMENT MARKING - LINE 4 INCH

<u>LOCATION</u>	<u>FOOT</u>	<u>REMARKS</u>
(WHITE) 2 Applications		
SB "ON RAMP"	300	EOP TO 150'
SB "OFF RAMP"	<u>280</u>	EOP TO 140'
TOTAL (WHITE)	580	
(YELLOW) 2 Applications		
SB "ON RAMP"	252	EOP TO 126'
SB "OFF RAMP"	<u>250</u>	EOP TO 125'
TOTAL (YELLOW)	502	
TOTAL (YELLOW AND WHITE)	1082	

78001140 PAINT PAVEMENT MARKING - LINE 8 INCH

<u>LOCATION</u>	<u>FOOT</u>	<u>REMARKS</u>
(2 Applications)		
SB "OFF RAMP"	<u>270</u>	AROUND ISLAND
TOTAL	270	

78001150 PAINT PAVEMENT MARKING - LINE 12 INCH

<u>LOCATION</u>	<u>FOOT</u>	<u>REMARKS</u>
(2 Applications)		
SB "OFF RAMP"	<u>66</u>	ISLAND DIAGONALS
TOTAL	66	

SCHEDULE OF QUANTITIES

FAI 39 (I 39)
Section D2 PATCHING 2013-1
Winnebago County
Contract #64J11
Sheet 7 of 19

78001180 PAINT PAVEMENT MARKING - LINE 24 INCH

<u>LOCATION</u>	<u>FOOT</u>	<u>REMARKS</u>
(2 Applications)		
SB "OFF RAMP"	40	LT TURN STOP BAR
SB "OFF RAMP"	40	RT TURN STOP BAR
TOTAL	80	

X4060995 TEMPORARY RAMP, SPECIAL

<u>LOCATION</u>	<u>SQ YD</u>	<u>REMARKS</u>
SB "OFF RAMP"	107	AT ISLAND
TOTAL	107	

GENERAL NOTES

All Borrow/Waste/Use sites must be approved by the Department prior to removing any material from the project or initiating any earthmoving activities, including temporary stockpiling outside the limits of construction.

Closed expansion joints on jointed pavements shall be re-established during the patching operations. Class B Patches - when the pavement requires patching at the location of the expansion joint, a new joint should be established using a dowelled expansion patch as shown on Highway Standard 442101. When the joint is closed, but does not require patching, an expansion joint may be formed by sawing the pavement and filling the saw cut with a preformed expansion joint filler meeting the requirements of Section 1051 of the Standard Specifications as shown on Standard 420001.

When laying out for patching, the minimum distance between new patches (saw cut to saw cut) shall be 15 feet. When patch spacing is less than 15 feet, the pavement between patches shall also be removed and replaced.

All mandatory joint sealing for Class A, Class B, and Class B (Hinge Jointed) patches as shown on the plans will not be measured for payment. Optional sawing of the joint for the sealant reservoir will not be measured for payment.

For all concrete patching that will not be resurfaced, the concrete shall be struck off flush with the existing pavement surface at each end of the patch.

The Engineer reserves the right to check all patches for smoothness by the use of a 10' rolling straight edge set to a 3/16" tolerance in the wheel paths. Any patch areas higher than 3/16" must be ground smooth with an approved grinding device consisting of multiple saws. The use of bushhammer or other impact devices will not be permitted. Any patch with depressions greater than 3/16" shall be repaired in a manner approved by the Engineer.

The mandatory saw cuts for pavement patching are:

Class A Patch: Cut two transverse saw cuts at each end of the patch; one full depth and one partial depth. The longitudinal edges of the patch shall be cut full depth. When the patch is adjacent to a pcc shoulder, two saw cuts along the shoulder will be required.

Class B Patch: Cut two transverse saw cuts outlining the patch and one transverse pressure relief saw cut. The longitudinal edges of the patch shall be cut full depth. When the patch is adjacent to a pcc shoulder, two saw cuts along the shoulder will be required.

The mandatory saw cuts will be paid for at the contract unit price per Foot for SAW CUTS.

The following Mixture Requirements are applicable for this project:

Mixture Uses(s):	Top Shoulder	Bottom Shoulder	
PG:	PG 58-22	PG 58-22	
Design Air Voids	3 @ N50	2 @ N50	
Mixture Composition (Gradation Mixture)	IL 9.5 or 12.5	BAM	
Friction Aggregate	C	N/A	
20 Year ESAL	N/A	N/A	

Bituminous and Aggregate prime coat shall be placed in accordance with Section 406 of the Standard Specifications. The cost of the prime coats shall be included in the contract unit price per Ton for HOT-MIX ASPHALT SURFACE COURSE of the type specified.

Pavement Marking shall be done according to Standard 780001, except as follows:

1. All words, such as ONLY, shall be 8 feet high.
2. All non-freeway arrows shall be the large size.
3. The distance between yellow no-passing lines shall be 8 inches, not 7 inches, as shown in the detail of Typical Lane and Edge Lines.
4. Centerline Skip Dash Pavement Marking on multi-lane divided, multi-lane undivided, and one-way roadway shall be according to District Standard 41.1.

The Contractor shall be responsible for protecting utility property during construction operations as outlined in Article 107.31 of the Standard Specifications. A minimum of 48 hours advance notice is required for non-emergency work. The JULIE number is 800-892-0123. The following listed utilities located within the project limits or immediately adjacent to the project construction limits are members of JULIE:

Commonwealth Edison Co. (815/490-2869)	Frontier (815/895-1515)
NICOR Gas Co. (630/983-8676)	Rock River Water Reclamation Dist. (815/387-7400)
Comcast Cable (815/395-8977)	

IDOT is not a member of JULIE. If you are near any overhead lighting, intersection lighting or traffic signals, contact the IDOT Traffic Office at 815/284-5469 at least 48 hours prior to work.

FAI 39(1-39)
SECTION D2 PATCHING 2013-1
WINNEBAGO COUNTY
CONTRACT 64J11
SHEET 10 OF 19

PLAN SHEET

I-39
ON RAMP PATCH DETAIL

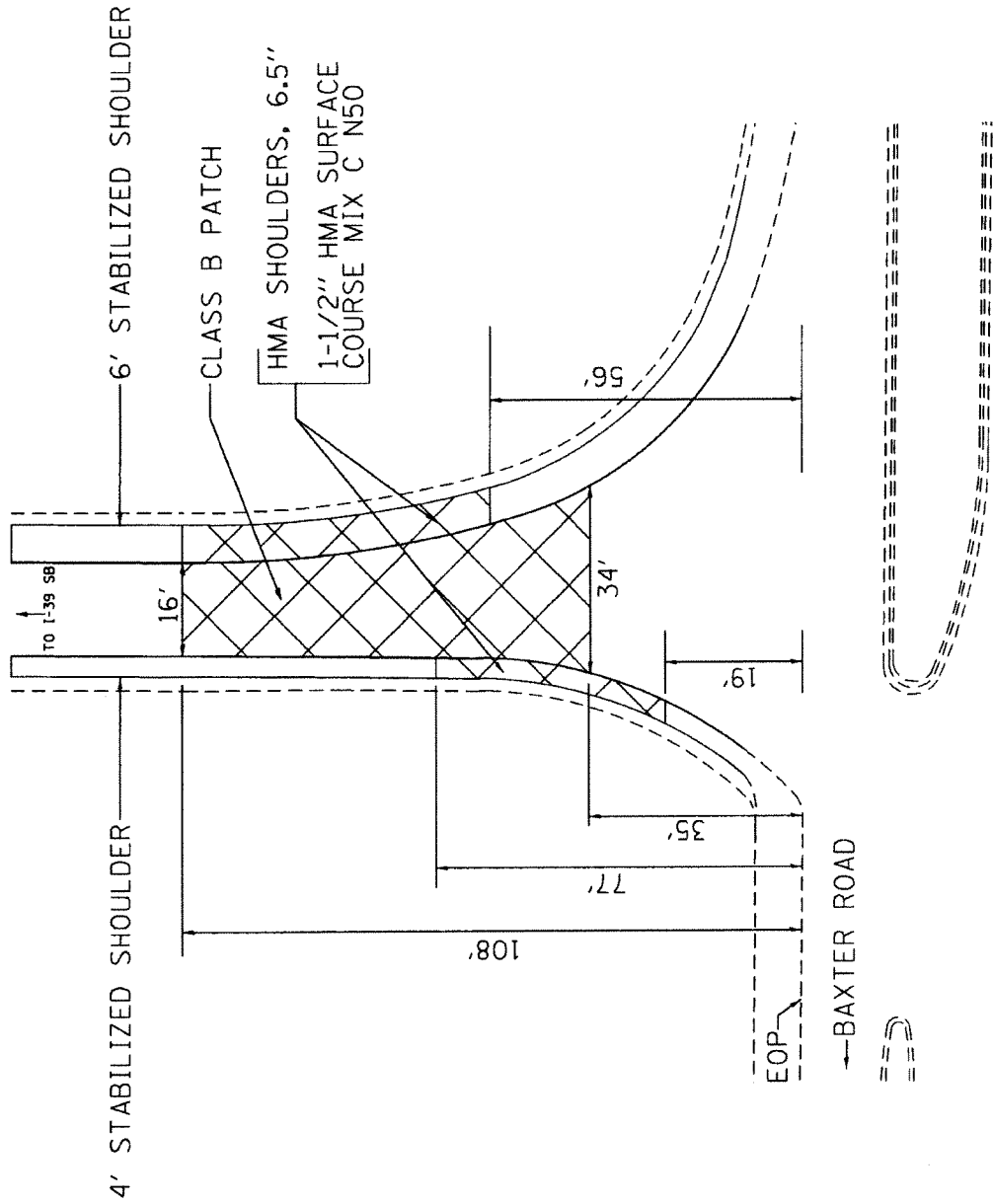

FAI 39(I-39)
SECTION 02 PATCHING 2013-1
WINNEBAGO COUNTY
CONTRACT 64J11
SHEET 11 OF 19

PLAN SHEET

I-39
OFF RAMP PATCH DETAIL

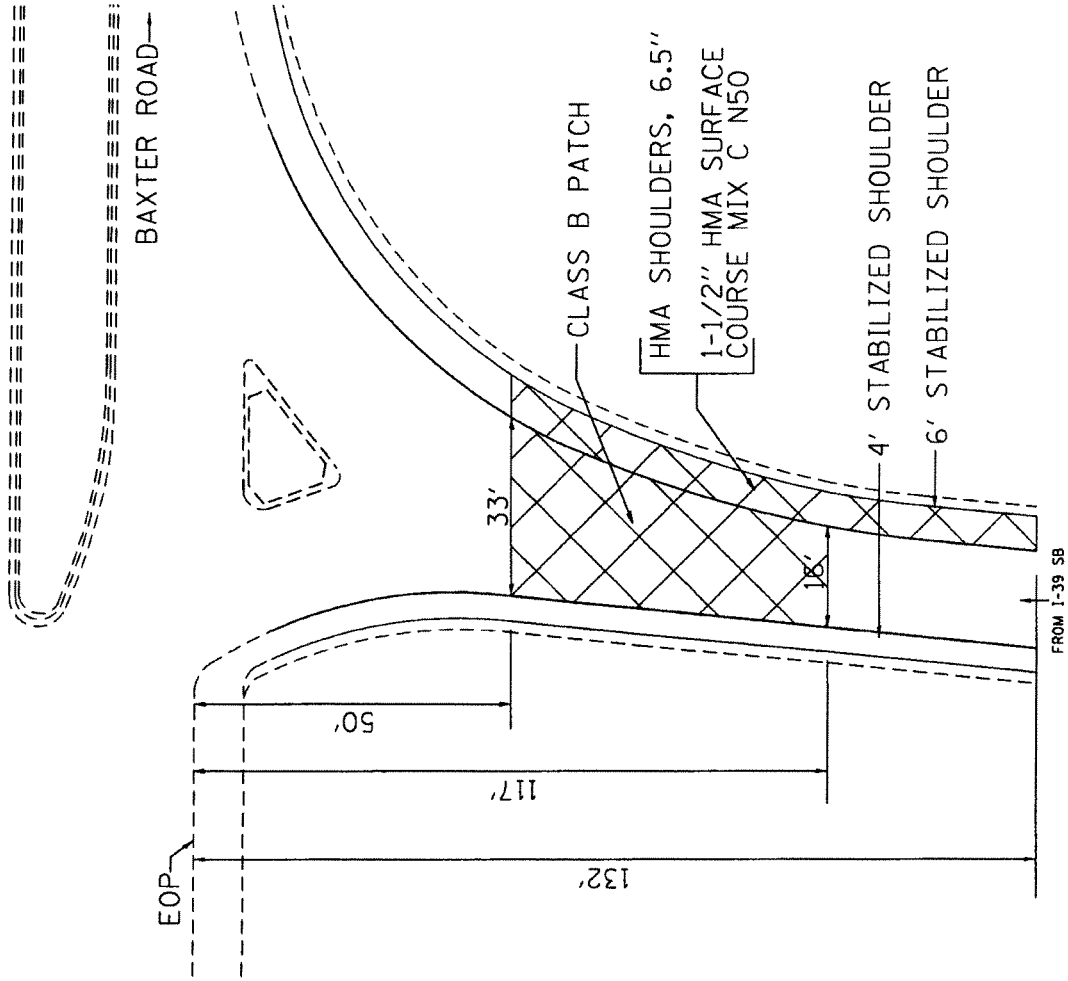

TEMPORARY RAMP, SPECIAL

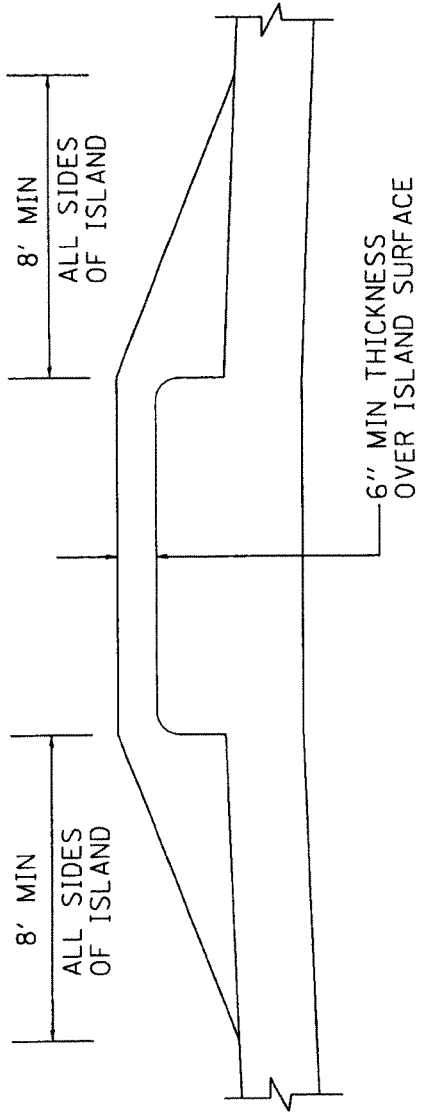

TEMPORARY RAMP, SPECIAL SHALL BE ACCORDING TO SECTION 406.

WHEN RAMP IS NO LONGER NEEDED IT SHALL BE COMPLETELY REMOVED FROM ISLAND SURFACE AND ON ALL SIDE OF THE ISLAND.

IF DAMAGE TO THE ISLAND OR SURROUNDING PAVEMENT OCCURS DUE TO PLACING OR REMOVAL OF THE TEMPORARY RAMP, SPECIAL, DAMAGES SHALL BE REPAIRED BY THE CONTRACTOR AT NO ADDITIONAL COST TO THE DEPARTMENT.

STOP SIGN REMOVAL AND REPLACEMENT SHALL BE INCLUDED IN THE COST OF TEMPORARY RAMP, SPECIAL.

THIS WORK SHALL BE PAID FOR PER SQ YD, FOR TEMPORARY RAMP, SPECIAL.

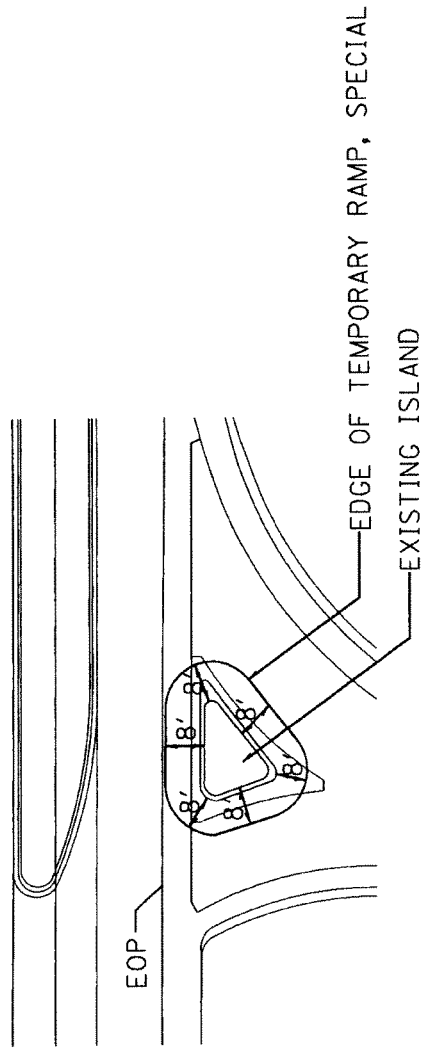

TYPICAL SECTIONS

I-39 OFF RAMP

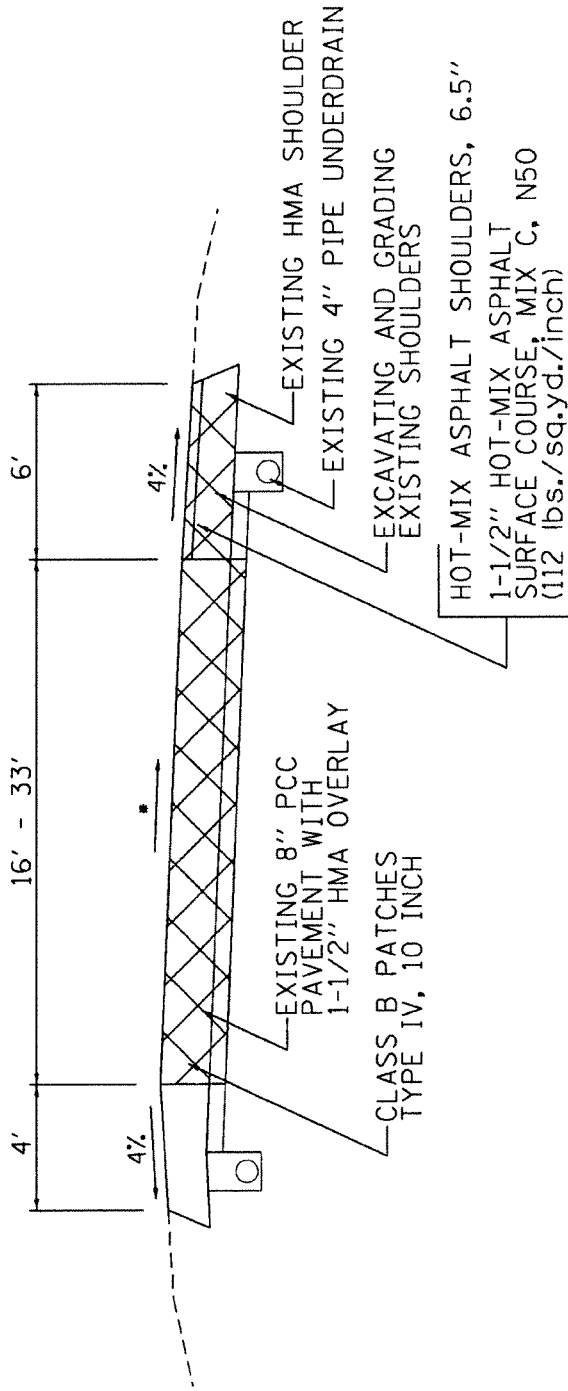

* MATCH EXISTING

TYPICAL SECTIONS

I-39
 ON RAMP

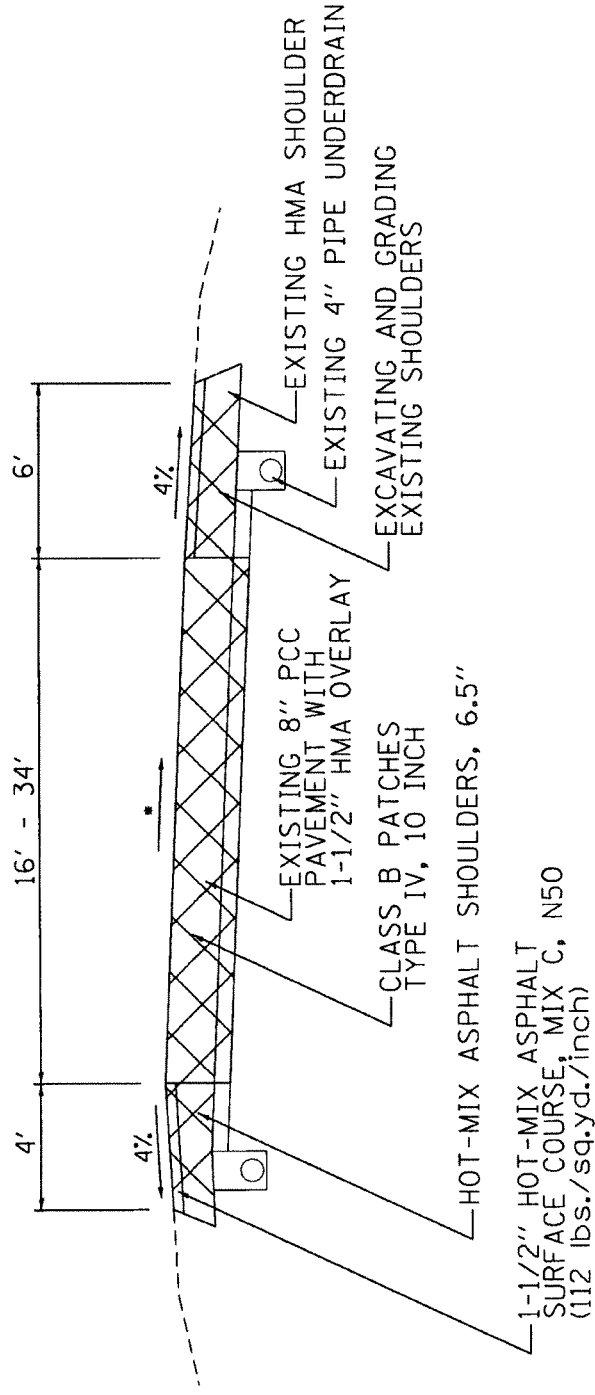

* MATCH EXISTING

FAI 39 (I-39)
 Section D2 PATCHING 2013-1
 Winnebago County
 Contract # 64J11
 Sheet 15 of 19

BITUMINOUS SCHEDULE

STATIONS	LENGTH FT	PROPOSED		40603310 HOT-MIX ASPHALT SURF CSE MIX C N 50 TON	48203023 HOT-MIX ASPHALT SHOULDERS 6.5 INCH SQ YD
		SURFACE	SHOULDER		
SB "ON RAMP"	58	4	25.8	2.2	25.8
	52	6	34.7	2.9	34.7
				5.1	60.4
SB "OFF RAMP"	0	4	0.0	0.0	0.0
	82	6	54.7	4.6	54.7
				4.6	54.7
TOTALS				9.7	115.1

CLASS B PATCHING SCHEDULE

FAI 39 (I-39)
 Section D2 PATCHING 2013-1
 Winnebago
 64J11
 Sheet 16 of 19

DIST. FROM BAXTER RD. EOP FOOT	LENGTH OF PAVT FOOT	AVG. WIDTH OF PATCH		CLASS B PATCHES TYPE 4, 10 INCH		SAW CUTS		DOWEL BARS 1.5 INCH		42001200 PAVEMENT FABRIC SQ. YD.	44213208 TIE BARS 1-1/4IN. EACH
		STAGE 1 FOOT	STAGE 2 FOOT	STAGE 1 SQ. YD.	STAGE 2 SQ. YD.	STAGE 1 FOOT	STAGE 2 FOOT	STAGE 1 EACH	STAGE 2 EACH		
SB ON RAMP											
34 to 108	74	10	10	82.2	82.2	104.0	30.0	45	45	164.4	51
SB OFF RAMP											
50 to 117	67	10	10	74.4	74.4	97.0	30.0	50	50	148.9	52
PAGE SUB-TOTAL				156.7	156.7	201.0	60.0	95.0	95.0	313.3	103.0
PAY ITEM TOTAL				313.3	313.3	251.0	251.0	190.0	190.0	313.3	103.0

Z0028415

GEOTECHNICAL REINFORCEMENT (SQ YL 313.3

Z0028700

GRANULAR SUBGRADE REPLACEMENT @ 6" (CU YL 52

HOT-MIX ASPHALT SHOULDER

GENERAL NOTES

THE HOT-MIX ASPHALT SHOULDER SHALL BE CONSTRUCTED IN ACCORDANCE WITH SECTION 482 EXCEPT THE TOP LIFT SHALL BE HOT-MIX ASPHALT SURFACE COURSE, MIX "C", N50 #40603310. THE WORK WILL BE PAID FOR AT THE CONTRACT UNIT PRICE PER TON FOR HOT-MIX ASPHALT SURFACE COURSE, MIX "C", N50 #40603310 AND SQUARE YARD FOR HOT-MIX ASPHALT SHOULDERS OF THE THICKNESS SPECIFIED.

USE HOT-MIX ASPHALT SURFACE COURSE, MIX "C", N50 #40603310. WHEN RESURFACING EXISTING HOT-MIX ASPHALT SHOULDERS, THE THICKNESS IS SHOWN ON THE TYPICAL SECTIONS. THIS WORK WILL BE PAID FOR AT THE CONTRACT UNIT PRICE PER TON FOR HOT-MIX ASPHALT SURFACE COURSE, MIX "C", N50 #40603310.

REMOVAL OF MATERIAL FOR PLACEMENT OF THE HOT-MIX ASPHALT SHOULDER TO BE PAID FOR IN UNITS FOR EXCAVATING AND GRADING EXISTING SHOULDERS OR IN CUBIC YARDS FOR EARTH EXCAVATION OR EARTH EXCAVATION WIDENING.

* 4% WHEN MAINLINE IS ON TANGENT. FOR CROSS SLOPE ON SUPERELEVATION SECTION, SEE HIGHWAY STANDARD 482001 OR 482006.

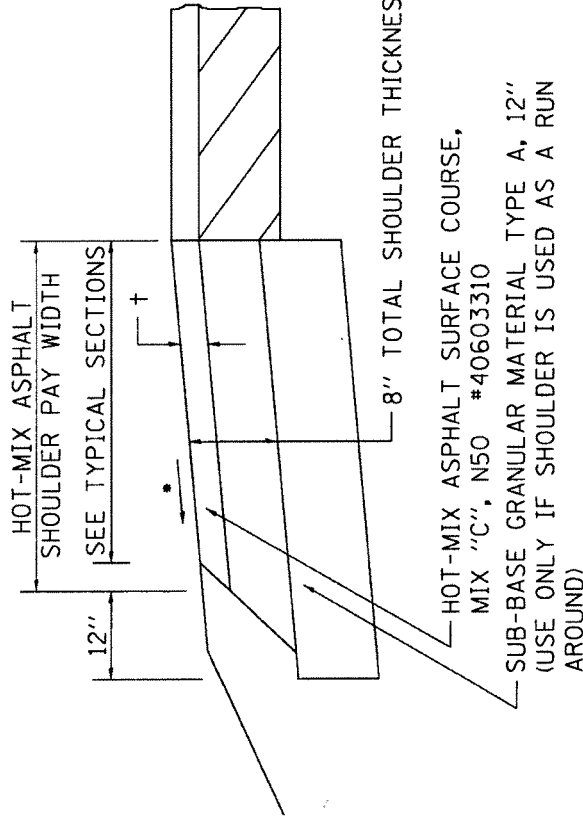

REVISED - 6-06-11	F.A.T. RTE.	SECTION	COUNTY	TOTAL SHEETS	SHEET NO.
REVISED -	39	D2 PATCHING 2013-1	WINNEBAGO	19	17
REVISED -	FED. ROAD DIST. NO. - ILLINOIS FED. AID PROJECT		CONTRACT NO. 64J11		
REVISED -	SCALE: 3/8" = 1' - 0"		SHEET NO. OF SHEETS		STA. TO STA.
REGION 2 / DISTRICT 2 STANDARD					

DATE = Wed Aug 01 07:58:18 2012

HOT-MIX ASPHALT SHOULDER 23.4a

SUBGRADE REPLACEMENT

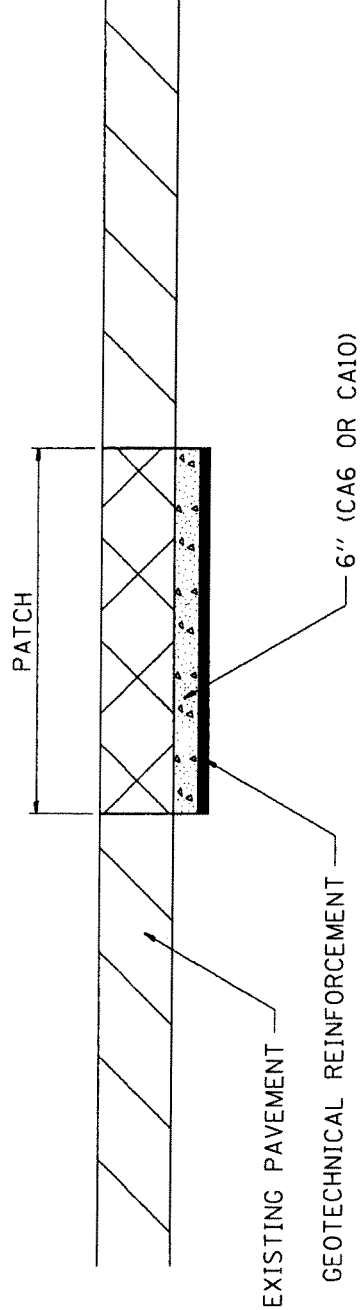

NOTES:
 THE CA 6 OR CA 10 SHALL BE COMPACTED IN A MANNER APPROVED BY THE ENGINEER. IF THE MOISTURE CONTENT OF THE MATERIAL IS SUCH THAT COMPACTION SATISFACTORY TO THE ENGINEER CANNOT BE OBTAINED, SUFFICIENT WATER SHALL BE ADDED SO THAT SATISFACTORY COMPACTION CAN BE OBTAINED.
 THE CA 6 OR CA 10 WILL BE PAID FOR AT THE CONTRACT UNIT PRICE PER CU YD FOR GRANULAR SUBGRADE REPLACEMENT
 THE GEOTECHNICAL REINFORCEMENT WILL BE PAID FOR AT THE CONTRACT UNIT PRICE PER SQ YD FOR GEOTECHNICAL REINFORCEMENT
 ALL DIMENSIONS ARE IN INCHES UNLESS OTHERWISE NOTED.

REVISED - 10-11-11	F.A.I. RTE.	SECTION	COUNTY	TOTAL SHEETS	SHEET NO.
REVISED -	39	D2 PATCHING 2013-1	WINNEBAGO	19	18
REVISED -	FED. ROAD DIST. NO. - ILLINOIS FED. AID PROJECT				
REVISED -	CONTRACT NO. 64J11				

REGION 2 / DISTRICT 2 STANDARD
 SCALE: 3/4" = 1'-0" SHEET NO. OF SHEETS STA. TO STA.
SUBGRADE REPLACEMENT 97.4

ILLINOIS DEPARTMENT OF LABOR

**PREVAILING WAGES FOR
K-BB965 ; C COUNTY
EFFECTIVE OCTOBER 2012**

The Prevailing rates of wages are included in the Contract proposals which are subject to Check Sheet #5 of the Supplemental Specifications and Recurring Special Provisions. The rates have been ascertained and certified by the Illinois Department of Labor for the locality in which the work is to be performed and for each craft or type of work or mechanic needed to execute the work of the Contract. As required by Prevailing Wage Act (820 ILCS 130/0.01, et seq.) and Check Sheet #5 of the Contract, not less than the rates of wages ascertained by the Illinois Department of Labor and as revised during the performance of a Contract shall be paid to all laborers, workers and mechanics performing work under the Contract. Post the scale of wages in a prominent and easily accessible place at the site of work.

If the Illinois Department of Labor revises the prevailing rates of wages to be paid as listed in the specification of rates, the contractor shall post the revised rates of wages and shall pay not less than the revised rates of wages. Current wage rate information shall be obtained by visiting the Illinois Department of Labor web site at <http://www.state.il.us/agency/idol/> or by calling 312-793-2814. It is the responsibility of the contractor to review the rates applicable to the work of the contract at regular intervals in order to insure the timely payment of current rates. Provision of this information to the contractor by means of the Illinois Department of Labor web site satisfies the notification of revisions by the Department to the contractor pursuant to the Act, and the contractor agrees that no additional notice is required. The contractor shall notify each of its subcontractors of the revised rates of wages.

Winnebago County Prevailing Wage for October 2012

(See explanation of column headings at bottom of wages)

Trade Name	RG	TYP	C	Base	FRMAN	*M-F>8	OSA	OSH	H/W	Pensn	Vac	Trng
=====	==	===	=	=====	=====	=====	===	===	=====	=====	=====	=====
ASBESTOS ABT-GEN		BLD		29.580	30.580	1.5	1.5	2.0	8.240	12.32	0.000	0.800
ASBESTOS ABT-MEC		BLD		18.950	0.000	1.5	1.5	2.0	2.700	3.350	0.000	0.000
BOILERMAKER		BLD		43.450	47.360	2.0	2.0	2.0	6.970	14.66	0.000	0.350
BRICK MASON		BLD		35.880	38.630	1.5	1.5	2.0	7.950	11.73	0.000	0.600
CARPENTER		BLD		36.320	40.320	1.5	1.5	2.0	7.700	11.25	0.000	0.600
CARPENTER		HWY		39.830	41.580	1.5	1.5	2.0	7.700	9.000	0.000	0.490
CEMENT MASON		ALL		34.820	37.570	1.5	1.5	2.0	8.150	11.45	0.000	0.500
CERAMIC TILE FNSHER		BLD		32.410	0.000	1.5	1.5	2.0	7.700	4.840	0.000	0.530
COMMUNICATION TECH		BLD		36.000	39.600	1.5	1.5	2.0	10.14	11.20	0.000	0.720
ELECTRIC PWR EQMT OP		ALL		35.400	48.110	1.5	1.5	2.0	5.000	10.97	0.000	0.270
ELECTRIC PWR GRNDMAN		ALL		27.380	48.110	1.5	1.5	2.0	5.000	8.490	0.000	0.210
ELECTRIC PWR LINEMAN		ALL		42.390	48.110	1.5	1.5	2.0	5.000	13.14	0.000	0.320
ELECTRIC PWR TRK DRV		ALL		28.350	48.110	1.5	1.5	2.0	5.000	8.790	0.000	0.220
ELECTRICIAN		BLD		40.000	44.000	1.5	1.5	2.0	10.14	16.93	0.000	0.800
ELEVATOR CONSTRUCTOR		BLD		44.940	50.560	2.0	2.0	2.0	11.03	11.96	2.760	0.000
GLAZIER		BLD		34.730	35.730	1.5	1.5	2.0	9.700	8.200	0.000	1.250
HT/FROST INSULATOR		BLD		33.930	36.470	1.5	1.5	2.0	7.450	14.77	0.000	0.000
IRON WORKER		ALL		35.090	36.840	2.0	2.0	2.0	8.250	20.59	0.000	0.700
LABORER		BLD		29.580	30.580	1.5	1.5	2.0	8.240	12.32	0.000	0.800
LABORER		HWY		31.950	32.700	1.5	1.5	2.0	8.240	12.50	0.000	0.800
LABORER, SKILLED		HWY		34.250	35.000	1.5	1.5	2.0	8.240	12.50	0.000	0.800
LATHER		BLD		36.320	40.320	1.5	1.5	2.0	7.700	11.25	0.000	0.600
MACHINIST		BLD		43.550	46.050	1.5	1.5	2.0	6.130	8.950	1.850	0.000
MARBLE FINISHERS		BLD		32.410	0.000	1.5	1.5	2.0	7.700	4.840	0.000	0.530
MARBLE MASON		BLD		35.090	35.340	1.5	1.5	2.0	7.700	7.150	0.000	0.560
MATERIAL TESTER I		ALL		21.550	0.000	1.5	1.5	2.0	7.460	4.840	0.000	0.170
MATERIALS TESTER II		ALL		26.550	0.000	1.5	1.5	2.0	7.460	4.840	0.000	0.170
MILLWRIGHT		BLD		35.000	38.500	1.5	1.5	2.0	7.700	13.87	0.000	0.500
OPERATING ENGINEER		BLD	1	40.800	44.850	2.0	2.0	2.0	15.85	9.800	2.350	1.300
OPERATING ENGINEER		BLD	2	40.100	44.850	2.0	2.0	2.0	15.85	9.800	2.350	1.300
OPERATING ENGINEER		BLD	3	37.650	44.850	2.0	2.0	2.0	15.85	9.800	2.350	1.300
OPERATING ENGINEER		BLD	4	35.650	44.850	2.0	2.0	2.0	15.85	9.800	2.350	1.300
OPERATING ENGINEER		BLD	5	44.600	44.850	2.0	2.0	2.0	15.85	9.800	2.350	1.300
OPERATING ENGINEER		BLD	6	43.350	44.850	2.0	2.0	2.0	15.85	9.800	2.350	1.300
OPERATING ENGINEER		BLD	7	40.350	44.850	2.0	2.0	2.0	15.85	9.800	2.350	1.300
OPERATING ENGINEER		HWY	1	40.650	44.700	1.5	1.5	2.0	15.85	9.800	2.350	1.300
OPERATING ENGINEER		HWY	2	40.100	44.700	1.5	1.5	2.0	15.85	9.800	2.350	1.300
OPERATING ENGINEER		HWY	3	38.800	44.700	1.5	1.5	2.0	15.85	9.800	2.350	1.300
OPERATING ENGINEER		HWY	4	37.350	44.700	1.5	1.5	2.0	15.85	9.800	2.350	1.300
OPERATING ENGINEER		HWY	5	35.900	44.700	1.5	1.5	2.0	15.85	9.800	2.350	1.300
OPERATING ENGINEER		HWY	6	43.700	44.700	1.5	1.5	2.0	15.85	9.800	2.350	1.300
OPERATING ENGINEER		HWY	7	41.700	44.700	1.5	1.5	2.0	15.85	9.800	2.350	1.300
PAINTER		ALL		35.700	37.700	1.5	1.5	1.5	9.650	8.460	0.000	1.250
PILEDRIVER		BLD		37.320	41.430	1.5	1.5	2.0	7.700	11.25	0.000	0.600
PILEDRIVER		HWY		39.830	41.580	1.5	1.5	2.0	7.700	9.000	0.000	0.490
PIPEFITTER		BLD		39.900	42.690	1.5	1.5	2.0	7.980	10.69	0.000	1.000
PLASTERER		BLD		33.360	36.700	1.5	1.5	2.0	8.150	11.05	0.000	0.500
PLUMBER		BLD		39.900	42.690	1.5	1.5	2.0	7.980	10.69	0.000	1.000
ROOFER		BLD		38.350	41.350	1.5	1.5	2.0	8.080	8.220	0.000	0.430
SHEETMETAL WORKER		BLD		35.780	37.710	1.5	1.5	2.0	5.450	15.44	0.520	0.290
SPRINKLER FITTER		BLD		36.390	39.140	1.5	1.5	2.0	8.420	8.350	0.000	0.350
STONE MASON		BLD		35.880	38.630	1.5	1.5	2.0	7.950	11.73	0.000	0.600
TERRAZZO FINISHER		BLD		32.410	0.000	1.5	1.5	2.0	7.700	4.840	0.000	0.530
TERRAZZO MASON		BLD		35.090	35.340	1.5	1.5	2.0	7.700	7.150	0.000	0.560
TILE LAYER		BLD		36.320	40.320	1.5	1.5	2.0	7.700	11.25	0.000	0.600
TILE MASON		BLD		35.090	35.340	1.5	1.5	2.0	7.700	7.150	0.000	0.560
TRUCK DRIVER		ALL	1	32.960	33.420	1.5	1.5	2.0	6.900	8.220	0.000	0.000

TRUCK DRIVER	ALL	2	33.110	33.420	1.5	1.5	2.0	6.900	8.220	0.000	0.000
TRUCK DRIVER	ALL	3	33.310	33.420	1.5	1.5	2.0	6.900	8.220	0.000	0.000
TRUCK DRIVER	ALL	4	33.420	33.420	1.5	1.5	2.0	6.900	8.220	0.000	0.000
TUCKPINTER	BLD		35.880	38.630	1.5	1.5	2.0	7.950	11.73	0.000	0.600

Legend :

RG (Region)

TYP (Trade Type - All,Highway,Building,Floating,Oil & Chip,Rivers)

C (Class)

Base (Base Wage Rate)

FRMAN (Foreman Rate)

M-F>8 (OT required for any hour greater than 8 worked each day, Mon through Fri.

OSA (Overtime (OT) is required for every hour worked on Saturday)

OSH (Overtime is required for every hour worked on Sunday and Holidays)

H/W (Health & Welfare Insurance)

Pensn (Pension)

Vac (Vacation)

Trng (Training)

Explanations

WINNEBAGO COUNTY

The following list is considered as those days for which holiday rates of wages for work performed apply: New Years Day, Memorial Day, Fourth of July, Labor Day, Thanksgiving Day, Christmas Day and Veterans Day in some classifications/counties. Generally, any of these holidays which fall on a Sunday is celebrated on the following Monday. This then makes work performed on that Monday payable at the appropriate overtime rate for holiday pay. Common practice in a given local may alter certain days of celebration. If in doubt, please check with IDOL.

EXPLANATION OF CLASSES

ASBESTOS - GENERAL - removal of asbestos material/mold and hazardous materials from any place in a building, including mechanical systems where those mechanical systems are to be removed. This includes the removal of asbestos materials/mold and hazardous materials from ductwork or pipes in a building when the building is to be demolished at the time or at some close future date.

ASBESTOS - MECHANICAL - removal of asbestos material from mechanical systems, such as pipes, ducts, and boilers, where the mechanical systems are to remain.

CERAMIC TILE FINISHER, MARBLE FINISHER, TERRAZZO FINISHER

Assisting, helping or supporting the tile, marble and terrazzo mechanic by performing their historic and traditional work assignments required to complete the proper installation of the work covered by said crafts. The term "Ceramic" is used for naming the classification only and is in no way a limitation of the product handled. Ceramic takes into consideration most hard tiles.

COMMUNICATIONS TECHNICIAN

Installing, manufacturing, assembling and maintaining sound and intercom, protection alarm (security), fire alarm, master antenna television, closed circuit television, low voltage control for computers and/or door monitoring, school communications systems, telephones and servicing of nurse and emergency calls, and the installation and maintenance of transmit and receive antennas, transmitters, receivers, and associated apparatus which operates in conjunction with above systems. All work associated with these system installations will be included EXCEPT the installation of protective metallic conduit in new construction projects (excluding less than ten-foot, runs strictly for protection of cable) and 120 volt AC (or higher) power wiring and associated hardware.

LABORER, SKILLED - HIGHWAY

Individuals engaged in the following types of work, irrespective of the site of the work: asbestos abatement worker, handling of any materials with any foreign matter harmful to skin or clothing, track laborer, cement handlers, chloride handlers, the unloading and loading with steel workers and re-bars, concrete workers wet, tunnel helpers in free air, batch dumpers, mason tenders, kettle and tar men, tank cleaners, plastic installers, scaffold workers, motorized buggies or motorized unit used for wet concrete or handling of building materials, laborers with de-watering systems, sewer workers plus depth, rod and chainmen with technical engineers, rod and chainmen with land surveyors, rod and chainmen with surveyors, vibrator operators, cement silica, clay, fly ash, lime and plasters, handlers (bulk or bag), cofferdam workers plus depth, on concrete paving, placing, cutting and tying of reinforcing, deck hand, dredge hand, and shore laborers, bankmen on floating plant, grade checker, power tools, front end man on chip spreaders, cession workers plus depth, gunnite nozzle men, lead man on sewer work, welders, cutters, burners and torchmen, chainsaw operators, jackhammer and drill operators, layout man and/or drainage tile layer, steel form setter - street and highway, air tamping hammermen, signal man on crane, concrete saw operator, screedman on asphalt pavers, laborers tending masons with hot material or where foreign materials are used, mortar mixer operators, multiple concrete duct - leadsman, lumen, asphalt raker, curb asphalt machine operator, ready mix scalemen (permanent, portable or temporary plant), laborers handling masterplate or similar materials, laser beam operator, con-crete burning machine operator, coring machine operator, plaster ten-der, underpinning and shoring of buildings, pump men, manhole and catch basin, dirt and stone tamper, hose men on concrete pumps, haz-ardous waste worker, lead base paint abatement worker, lining of pipe, refusing machine, assisting on direct boring machine, the work of lay-ing watermain, fire hydrants, all mechanical joints to watermain work, sewer worker, and tapping water service and forced lift station mechanical worker.

MATERIAL TESTER I: Hand coring and drilling for testing of materials; field inspection of uncured concrete and asphalt.

MATERIAL TESTER II: Field inspection of welds, structural steel, fireproofing, masonry, soil, facade, reinforcing steel, formwork, cured concrete, and concrete and asphalt batch plants; adjusting proportions of bituminous mixtures.

OPERATING ENGINEERS - BUILDING

Class 1. Asphalt Plant; Asphalt Spreader; Autograde; Backhoes with Caisson Attachment; Batch Plant; Benoto (requires Two Engineers); Boiler and Throttle Valve; Caisson Rigs; Central Redi-Mix Plant; Combination Back Hoe Front End-loader Machine; Compressor and Throttle Valve; Concrete Breaker (Truck Mounted); Concrete Conveyor; Concrete Paver (over 27E cu. ft.): Concrete Paver (27 cu. ft. and under); Concrete Placer; Concrete Pump (Truck Mounted); Concrete Conveyor (Truck Mounted); Concrete Tower; Cranes, All; GCI and similar types (required two operators only); Cranes, Hammerhead; Creter Crane; Crusher, Stone, etc.; Derricks, All; Derricks, Traveling; Formless Curb and Gutter Machine; Grader, Elevating; Grouting Machines; Highlift Shovels or Front Endloader 2-1/4 yd. and over; Hoists, Elevators, outside type rack and pinion and similar machines; Hoists, one, two and three Drum; Hoists, Two Tugger One Floor; Hydraulic Backhoes; Hydraulic Boom Trucks; Locomotives, All; Lubrication Technician; Manipulators; Motor Patrol; Pile Drivers and Skid Rig; Post Hole Digger; Pre-Stress Machine; Pump Cretes Dual Ram; Pump Cretes: Squeeze Cretes - Screw Type Pumps, Gypsum Bulker and Pump; Raised and Blind Hole Drill; Rock Drill (self-propelled); Rock Drill - Truck Mounted; Roto Mill Grinder; Scoops - Tractor Drawn; Slipform Paver; Scrapers Prime Movers; Straddle Buggies; Tie Back Machine; Tractor with Boom and Side Boom; Trenching Machines.

Class 2. Bobcat (over 3/4 cu. yd.); Boilers; Brick Forklift; Broom, All Power Propelled; Bulldozers; Concrete Mixer (Two Bag and Over); Conveyor, Portable; Forklift Trucks; Highlift Shovels or Front Endloaders under 2-1/4 yd.; Hoists, Automatic; Hoists, Sewer Dragging Machine; Hoists, Tugger Single Drum; Rollers, All; Steam Generators; Tractors, All; Tractor Drawn Vibratory Roller; Winch Trucks with "A" Frame.

Class 3. Air Compressor; Asphalt Spreader; Combination - Small Equipment Operator; Generators; Heaters, Mechanical; Hoists, Inside Elevators - (Rheostat Manual Controlled); Hydraulic Power Units (Pile Driving and Extracting); Pumps, Over 3" (1 to 3 not to exceed total of 300 ft.); Pumps, Well Points; Welding Machines (2 through 5); Winches, 4 Small Electric Drill Winches; Bobcat (up to and including 3/4 cu. yd.).

Class 4. Elevator push button with automatic doors; Hoists, Inside; Oilers; Brick Forklift.

Class 5. Assistant Craft Foreman

Class 6. Mechanics

Class 7. Gradall.

OPERATING ENGINEERS - HIGHWAY CONSTRUCTION

Class 1. Asphalt Plant; Asphalt Heater and Planer Combination; Asphalt Heater Scarfire; Asphalt Silo Tender; Asphalt Spreader; Autograder; ABG Paver; Backhoes with Caisson Attachment; Ballast Regulator; Belt

Loader; Caisson Rigs; Car Dumper; Central Redi-Mix Plant; Backhoe w/shear attachments; Combination Backhoe Front Endloader Machine, (1 cu. yd. Backhoe Bucket or over or with attachments); Concrete Breaker (Truck Mounted); Concrete Conveyor; Concrete Paver over 27E cu. ft.; Concrete Placer; Concrete Tube Float; Cranes, all attachments; Cranes, Tower of all types; Creter Crane; Crusher, Stone, etc.; Derricks, All; Derrick Boats; Derricks, Traveling; Directional Boring Machine over 12"; Dredges; Formless Curb and Gutter Machine; Grader, Elevating; Grader, Motor Grader, Motor Patrol, Auto Patrol, Form Grader, Pull Grader, Subgrader; Guard Rail Post Driver Mounted; Hoists, One, Two and Three Drum; Hydraulic Backhoes; Lubrication Technician; Manipulators; Pile Drivers and Skid Rig; Pre-Stress Machine; Pump Cretes Dual Ram; Rock Drill - Crawler or Skid Rig; Rock Drill - Truck Mounted; Rock/Track Tamper; Roto Mill Grinder; Slip-Form Paver; Soil Test Drill Rig (Truck Mounted); Straddle Buggies; GCI Crane; Hydraulic Telescoping Form (Tunnel); Tie Back Machine; Tractor Drawn Belt Loader; Tractor Drawn Belt Loader with attached pusher; Tractor with Boom; Tractaire with Attachments; Traffic Barrier Conveyor Machine; Raised or Blind Hole Drills; Trenching Machine (over 12"); Truck Mounted Concrete Pump with Boom; Truck Mounted Concrete Conveyor; Underground Boring and/or Mining Machines; Wheel Excavator; Widener (APSCO).

Class 2. Batch Plant; Bituminous Mixer; Boiler and Throttle Valve; Bulldozers; Car Loader Trailing Conveyors; Combination Backhoe Front Endloader Machine (less than 1 cu. yd. Backhoe Bucket or over or with attachments); Compressor and Throttle Valve; Compressor, Common Receiver (3); Concrete Breaker or Hydro Hammer; Concrete Grinding Machine; Concrete Mixer or Paver 7S Series to and including 27 cu. ft.; Concrete Spreader; Concrete Curing Machine, Burlap Machine, Belting Machine and Sealing Machine; Conveyor Muck Cars (Haglund or Similar Type); Drills, all; Finishing Machine - Concrete; Highlift Shovels or Front Endloader; Hoist - Sewer Dragging Machine; Hydraulic Boom Trucks (All Attachments); Hydro Blaster; All Locomotives, Dinky; Off-Road Hauling Units (including articulating) / 2 ton capacity or more; Non-Self Loading Ejection Dump; Pump Cretes: Squeeze Cretes - Screw Type Pumps, Gypsum Bulker and Pump; Roller, Asphalt; Rotary Snow Plows; Rototiller, Seaman, etc., self-propelled; Scoops - Tractor Drawn; Self-Propelled Compactor; Spreader - Chip - Stone, etc.; Scraper; Scraper - Prime Mover in Tandem (Regardless of Size); Tank Car Heater; Tractors, Push, Pulling Sheeps Foot, Disc, Compactor, etc.; Tug Boats.

Class 3. Boilers; Brooms, All Power Propelled; Cement Supply Tender; Compressor, Common Receiver (2); Concrete Mixer (Two Bag and Over); Conveyor, Portable; Farm-Type Tractors Used for Mowing, Seeding, etc.; Fireman on Boilers; Forklift Trucks; Grouting Machine; Hoists, Automatic; Hoists, All Elevators; Hoists, Tugger Single Drum; Jeep Diggers; Low Boys; Pipe Jacking Machines; Post-Hole Digger; Power Saw, Concrete Power Driven; Pug Mills; Rollers, other than asphalt; Seed and Straw Blower; Steam Generators; Stump Machine; Winch Trucks with "A" Frame; Work Boats; Tamper - Form - Motor Driven.

Class 4. Air Compressor - Small and Large; Asphalt Spreader, Backend Man; Bobcat (Skid Steer) all; Brick Forklift; Combination - Small Equipment Operator; Directional Boring Machine up to 12"; Generators; Heaters, Mechanical; Hydraulic Power Unit (Pile Driving, Extracting, or Drilling); Hydro-Blaster; Light Plants, All (1 through 5); Pumps, over 3" (1 to 3 not to exceed a total of 300 ft.); Pumps, Well Points; Tractaire; Trencher 12" and under; Welding Machines (2 through 5); Winches, 4 Small Electric Drill Winches.

Class 5. Oilers and Directional Boring Machine Locator.

Class 6. Field Mechanics and Field Welders

Class 7. Gradall and machines of like nature.

TRUCK DRIVER - BUILDING, HEAVY AND HIGHWAY CONSTRUCTION

Class 1. Two or three Axle Trucks. A-frame Truck when used for transportation purposes; Air Compressors and Welding Machines, including those pulled by cars, pick-up trucks and tractors; Ambulances; Batch Gate Lockers; Batch Hopperman; Car and Truck Washers; Carry-alls; Fork Lifts and Hoisters; Helpers; Mechanics Helpers and Greasers; Oil Distributors 2-man operation; Pavement Breakers; Pole Trailer, up to 40 feet; Power Mower Tractors; Self-propelled Chip Spreader; Skipman; Slurry Trucks, 2-man operation; Slurry Truck Conveyor Operation, 2 or 3 man; TTeamsters Unskilled dumpman; and Truck Drivers hauling warning lights, barricades, and portable toilets on the job site.

Class 2. Four axle trucks; Dump Crets and Adgetors under 7 yards; Dumpsters, Track Trucks, Euclids, Hug Bottom Dump Turnapulls or Turnatrailers when pulling other than self-loading equipment or similar equipment under 16 cubic yards; Mixer Trucks under 7 yards; Ready-mix Plant Hopper Operator, and Winch Trucks, 2 Axles.

Class 3. Five axle trucks; Dump Crets and Adgetors 7 yards and over; Dumpsters, Track Trucks, Euclids, Hug Bottom Dump Turnatrailers or turnapulls when pulling other than self-loading equipment or similar equipment over 16 cubic yards; Explosives and/or Fission Material Trucks; Mixer Trucks 7 yards or over; Mobile Cranes while in transit; Oil Distributors, 1-man operation; Pole Trailer, over 40 feet; Pole and Expandable Trailers hauling material over 50 feet long; Slurry trucks, 1-man operation; Winch trucks, 3 axles or more; Mechanic--Truck Welder and Truck Painter.

Class 4. Six axle trucks; Dual-purpose vehicles, such as mounted crane trucks with hoist and accessories; Foreman; Master Mechanic; Self-loading equipment like P.B. and trucks with scoops on the front.

Other Classifications of Work:

For definitions of classifications not otherwise set out, the Department generally has on file such definitions which are available. If a task to be performed is not subject to one of the classifications of pay set out, the Department will upon being contacted state which neighboring county has such a classification and provide such rate, such rate being deemed to exist by reference in this document. If no neighboring county rate applies to the task, the Department shall undertake a special determination, such special determination being then deemed to have existed under this determination. If a project requires these, or any classification not listed, please contact IDOL at 217-782-1710 for wage rates or clarifications.

LANDSCAPING

Landscaping work falls under the existing classifications for laborer, operating engineer and truck driver. The work performed by landscape plantsman and landscape laborer is covered by the existing classification of laborer. The work performed by landscape operators (regardless of equipment used or its size) is covered by the classifications of operating engineer. The work performed by

landscape truck drivers (regardless of size of truck driven) is covered by the classifications of truck driver.